



**10th Annual Conference of the  
EuroMed Academy of Business**

**Global and national business theories and practice:  
bridging the past with the future**

**Edited by:** Demetris Vrontis,  
Yaakov Weber,  
Evangelos Tsoukatos

**Published by:** EuroMed Press



# **10th Annual Conference of the EuroMed Academy of Business**

CONFERENCE READINGS

BOOK PROCEEDINGS

September 13-15 2017

Rome, Italy

## **Global and national business theories and practice: bridging the past with the future**

Copyright ©

The materials published in this Readings Book may be reproduced for instructional and non-commercial use. Any use for commercial purposes must have the prior approval of the Executive Board of the EuroMed Research Business Institute (EMRBI).

All full papers and abstracts submitted to the EMRBI Conference are subject to a peer reviewing process, using subject specialists selected because of their expert knowledge in the specific areas.

ISBN: 978-9963-711-56-7

Published by: EuroMed Press



## FOREWORD

The Annual Conference of the EuroMed Academy of Business aims to provide a unique international forum to facilitate the exchange of cutting-edge information through multidisciplinary presentations on examining and building new theory and business models for success through management innovation.

It is acknowledged that the conference has established itself as one of the major conferences of its kind in the EuroMed region, in terms of size, quality of content, and standing of attendees. Many of the papers presented contribute significantly to the business knowledge base.

The conference attracts hundreds of leading scholars from leading universities and principal executives and politicians from all over the world with the participation or intervention of Presidents, Prime Ministers, Ministers, Company CEOs, Presidents of Chambers, and other leading figures.

This year the conference attracted over 270 people from over 50 different countries. Academics, practitioners, researchers and Doctoral students throughout the world submitted original papers for conference presentation and for publication in this Book. All papers and abstracts were double blind reviewed. The result of these efforts produced empirical, conceptual and methodological papers and abstracts involving all functional areas of business.

## **ACKNOWLEDGEMENT**

Many people and organizations are responsible for the successful outcome of the 10th Annual Conference of the EuroMed Academy of Business. Special thanks go to the Conference Co-Chairs Dr. Stefano Fontana, Dr. Silvia Solimene and Dr Daniela Couccia and the Sapienza University of Rome, in Rome, for accomplishing an excellent job.

It is acknowledged that a successful conference could not be possible without the special co-operation and care of the Track Chairs and Reviewers for reviewing the many papers that were submitted to this conference. Special thanks to the Session Chairs and Paper Discussants for taking the extra time to make this conference a real success.

The last but not the least important acknowledgment goes to all those who submitted and presented their work at the conference. Their valuable research has highly contributed to the continuous success of the conference.

## TABLE OF PAPERS

A SUGGESTED NEW METHOD OF INNOVATION: INTRODUCING THE INTEGRATED QUALITY FUNCTION DEPLOYMENT FOR PRODUCTS & SERVICES .....	36
<i>Abu-Assab, Samah</i> .....	36
PERCEIVED VALUE OF BRANDS: THE EFFECTS OF BRAND ATTRACTIVENESS AND BRAND TRUSTWORTHINESS .....	47
<i>Akturan, Ulun</i> .....	47
ADVANCING THE PRIVATE HEALTHCARE MANAGEMENT SYSTEM IN LEBANON AND THE MIDDLE EAST - INTRODUCING NEW MEDICAL BENEFITS BY THIRD PARTY ADMINISTRATORS .....	56
<i>Al Khoury, Wissam<sup>1</sup>; Bekhazi, Helene<sup>1</sup>; Al Khoury, Grace<sup>2</sup></i> .....	56
INTERLINKING EMOTIONAL INTELLIGENCE AND CUSTOMER RELATIONSHIP MARKETING IN THE LEBANESE RETAIL BANKING SECTOR.....	75
<i>Al Khoury, Grace; Thrassou, Alkis; Kaufmann, Hans Ruediger</i> .....	75
SOCIAL ENTERPRISES AS DRIVERS OF LOCAL DEVELOPMENT: A FRAMEWORK .....	90
<i>Andreottola, Francesco<sup>1</sup>; Massaro, Maria Rita<sup>2</sup></i> .....	90
THE IMPACT OF PUBLIC RESEARCH ON INDUSTRY INNOVATION: A TECHNOLOGY-LEVEL PERSPECTIVE IN THE GREEN ENERGY FIELD.....	96
<i>Ardito, Lorenzo; Petruzzelli, Antonio Messeni; Albino, Vito</i> .....	96
THE EFFECTS OF PAY DISPERSION BETWEEN EXECUTIVES AND EMPLOYEES OF AN ORGANIZATION ON FIRM PERFORMANCE: EVIDENCE FROM TURKEY .....	117
<i>Ataay, Aylin</i> .....	117
THE EFFECTS OF PAY DISPERSION BETWEEN EXECUTIVES AND EMPLOYEES OF AN ORGANIZATION ON FIRM PERFORMANCE: EVIDENCE FROM TURKEY .....	129
<i>Aylin Ataay</i> .....	129
INVOLVING CUSTOMERS IN NEW SERVICE DEVELOPMENT: PAST, PRESENT AND FUTURE	141
<i>Athanasopoulou, P.<sup>1</sup>; Giovanis, A.N.<sup>2</sup>; Karounis, V.<sup>1</sup>; Tsoukatos, E.<sup>3</sup></i> .....	141
SOCIAL MEDIA IMPACT ON NPO BRAND EQUITY: CONCEPTUALIZING THE TRENDS AND PROSPECTS .....	150
<i>Belenioti, Zoe- Charis<sup>1</sup>; Vassiliadis, Chris A.<sup>2</sup></i> .....	150

SOCIAL RESPONSIBILITY IN BANKING: A BIBLIOGRAPHIC REVIEW .....	161
<i>Bellomo, Mario; La Rosa, Fabio</i> .....	161
FOR LOVE AND MONEY! EMPLOYEES, VOLUNTEERS AND ECONOMIC PERFORMANCES IN USA NONPROFIT ART ORGANIZATIONS.....	175
<i>Besana, Angela; Esposito, Annamaria</i> .....	175
CAN A HIGH WOMEN QUOTA IN SUPERVISORY BOARDS INFLUENCE ENTERPRISE SUCCESS? .....	188
<i>Binder, B.C.K.</i> .....	188
THE POWER OF NARRATION (STORY) FOR LEARNING AND FOR LIFE: BRIDGING PAST AND FUTURE.....	202
<i>Bombelli, M. Cristina<sup>1</sup>; Jirkovska, Blanka<sup>2</sup>; Sawyer, Carol H.<sup>3</sup>; Wallace, Annika E.<sup>4</sup>; Walling, Barbara<sup>5</sup></i> .....	202
REDUCING COSTS OR INCREASING MARKETING: STRATEGIC SUGGESTIONS FOR TOURISM FIRMS IN CRISIS SITUATIONS .....	207
<i>Bremser, Kerstin<sup>1</sup>; Alonso-Almeida, María del Mar<sup>2</sup>; Llach, Josep<sup>3</sup></i> .....	207
FEATURES AND BUSINESS OPPORTUNITIES OF PIEDMONT AGRITOURISMS .....	219
<i>Broccardo, Laura; Culasso, Francesca; Giacosa, Elisa; Truant, Elisa</i> .....	219
FRAMING THE TEMPORAL DIMENSIONS OF A BRAND .....	229
<i>Brunetti, Federico<sup>1</sup>; Confente, Ilenia<sup>1</sup>; Kucharska, Wioleta<sup>2</sup>; Kaufmann, Hans Ruediger<sup>3</sup></i> .....	229
HOW FOUNDERS VIEW THE DEVELOPMENT OF CUSTOMER- AND BRAND-ORIENTED CAPABILITIES OF THEIR YOUNG FIRM.....	239
<i>Buttenberg, Katharina</i> .....	239
TOWARDS A LIFE-CYCLE MODEL OF INTER-FIRM NETWORKS: PHYSIOLOGICAL AND PATHOLOGICAL PATH OF EVOLUTION .....	256
<i>Cantele, Silvia; Vernizzi, Silvia</i> .....	256
THE ROLE OF BIG DATA IN VALUE CO-CREATION FOR THE KNOWLEDGE ECONOMY .....	269
<i>Caputo, Francesco<sup>1</sup>; Evangelista, Federica<sup>2</sup>; Perko, Igor<sup>3</sup>; Russo, Giuseppe<sup>2</sup></i> .....	269
CAN BRAND ENTERTAINMENT STRENGTHEN A BRAND?.....	280
<i>Caratù, Myriam; Sfodera, Fabiola</i> .....	280
TECHNOLOGY TRANSFER AS DRIVER OF SMART GROWTH: A QUADRUPLE / QUINTUPLE INNOVATION FRAMEWORK APPROACH.....	295



<i>Carayannis, Elias<sup>1</sup>; Caputo, Francesco<sup>2</sup>; Del Giudice, Manlio<sup>3</sup></i> .....	295
RECENT ISSUES ON CORPORATE GOVERNANCE: THE EFFECTS OF THE “PRECAUTIONARY RECAPITALISATION” .....	316
<i>Cardi, Mavie</i> .....	316
ENHANCING TOURISM DURING 2007-2013 PROGRAMMING PERIOD IN ROMANIA: THE CASE OF BRASOV GROWTH POLE .....	327
<i>Catana, Aida; Manea, Daniela; Titan, Emilia</i> .....	327
POLITICAL CORPORATE SOCIAL RESPONSIBILITY IN THE TURKISH BUSINESS CONTEXT ...	334
<i>Cemek, Elif</i> .....	334
THE RELATIONSHIP BETWEEN LEADERSHIP COMPETENCIES AND SUCCESSFUL ORGANISATIONAL CHANGE .....	347
<i>Chatzoglou, Prodromos<sup>1</sup>; Dimitrellos, Georgios<sup>2</sup>; Chatzoudes, Dimitrios<sup>1</sup>; Aggelidis, Vasileios<sup>1</sup></i> .....	347
MARKETING AND PR ACTIVITIES OF THE LEADING WORLD UNIVERSITIES: MODERN TOOLS AND DEVELOPMENT TRENDS .....	362
<i>Chernysheva, Anna; Kalygina, Valentina; Zobov, Alexander</i> .....	362
THE LONG-TERM EFFECTS OF CVDS ON ECONOMIC DEVELOPMENT: THE CASE OF BANGALORE .....	373
<i>Chinnaswamy, Anitha K.<sup>1</sup>; Garcia-Perez, Alexeis<sup>1</sup>; Marshall, Ian M.<sup>1</sup>; Naguib, Raouf<sup>2</sup></i> .....	373
CROWD-FOODING. THE ROLE OF CROWDFUNDING PLATFORMS IN THE FOOD INDUSTRIES OPEN INNOVATION .....	387
<i>Cillo, Valentina<sup>1</sup>; Cardinali, Silvio<sup>2</sup>; Dell’Anno, Davide<sup>3</sup>; Bertoldi, Bernardo<sup>4</sup></i> .....	387
GOVERNANCE OF NON-PROFIT INSTITUTIONS: A MANAGERIAL ISSUE?.....	405
<i>Civitillo, Renato</i> .....	405
A WEB OF EMOTIONS –THE EFFECT OF ONLINE BRAND EXPERIENCE ON BRAND LOYALTY .....	424
<i>Cleff, Thomas; Walter, Nadine</i> .....	424
HOW LEAN GLOBAL START-UPS SELECT THEIR PRICING STRATEGIES, PRACTICES AND MODELS.....	441
<i>Cohen, Benjamin; Neubert, Michael</i> .....	441
PRICE-SETTING STRATEGIES FOR PRODUCT INNOVATIONS IN THE MEDTECH INDUSTRY	456

<i>Cohen, Benjamin; Neubert, Michael</i> .....	456
SOCIAL MEDIA TECHNOLOGY USE AND MANAGERS PERCEPTION. A PRELIMINARY STUDY IN THE ITALIAN WINE INDUSTRY .....	471
<i>Crescimanno, Maria; Galati, Antonino; Tulone, Antonio; Tinervia, Salvatore</i> .....	471
SUCCESSFUL ORGANISATIONAL MODELS IN THE GREEK WINE INDUSTRY .....	483
<i>Crescimanno, Maria<sup>1</sup>; Galati, Antonino<sup>1</sup>; Tinervia, Salvatore<sup>1</sup>; Iliopoulos, Constantine<sup>2</sup>; Theodorakopoulou, Irini<sup>2</sup>; Tulone, Antonio<sup>1</sup></i> .....	483
NEW PERSPECTIVES IN MANAGING RISKS IN SMES .....	496
<i>Crovini, Chiara</i> .....	496
UNDERSTANDING “CREATING SHARED VALUE” .....	510
<i>Daood, Antonio; Menghwar, Prem Sagar</i> .....	510
ANALYSING THE TRUMP AND BREXIT VOTERS .....	523
<i>Dos-Santos, Maria José Palma Lampreia dos Santos<sup>1</sup>; Candeias, Teresa<sup>2</sup>; Diz, Henrique<sup>3</sup></i> .....	523
PRICING STRATEGIES IN THE LEBANESE PHARMACEUTICAL INDUSTRY .....	537
<i>El Nemar, Sam; Mallat, Amani</i> .....	537
CORPORATE SOCIAL RESPONSIBILITY AND CORPORATE GOVERNANCE FOR NON-PROFIT ORGANIZATIONS AN EITHER / OR CHOICE? .....	552
<i>Eller, Helene</i> .....	552
THE URBAN FREE ZONES (ZFU). BETWEEN DISAPPROVAL, MISUNDERSTANDING AND RECOGNITION. AS A SPECIAL DEVELOPMENT TOOL FOR LOCAL FINANCE.....	565
<i>Esposito, Paolo; Ricci, Paolo; Iovino, Felicetta</i> .....	565
SWOT ANALYS: FROM BUSINESS ANALYSIS TO SOCIAL DIAGNOSIS .....	579
<i>Ferreira, Maria Emilia<sup>1</sup>; Candeias, Teresa<sup>2</sup></i> .....	579
RESTORING LEGITIMACY IN THE AFTERMATH OF CORPORATE SCANDALS: A MULTIPLE CASE-STUDY ANALYSIS ON CSR INITIATIVES .....	590
<i>Florio, Cristina; Sproviero, Alice F.</i> .....	590
SUSTAINABLE BUSINESS MODEL INNOVATION: AN OPPORTUNITY FOR THE FOOD INDUSTRY .....	604
<i>Franceschelli, Maria Vittoria<sup>1</sup>; Santoro, Gabriele<sup>2</sup></i> .....	604

ASSESSMENT OF THE INTERNATIONAL DEVELOPMENT LEVEL OF KAZAKHSTAN NATIONAL PHARMACEUTICAL COMPLEX .....	614
<i>Frolova, Elena<sup>1</sup>; Andreeva, Elena<sup>2</sup>; Abdurahmanova, Zulparuza<sup>3</sup></i> .....	614
BRAND HATE: A QUALITATIVE STUDY ON THE EXTREME NEGATIVE EMOTION TOWARD THE BRAND .....	628
<i>Gharbi, Dorra ; Smaoui, Fatma</i> .....	628
COST DEPLOYMENT IMPLEMENTATION: A CASE STUDY .....	642
<i>Giovando, Guido; Crovini, Chiara; Venturini, Stefano</i> .....	642
SUPPLY CHAIN CONNECTIONS AND THE TRIPLE BOTTOM LINE IN THE GLOBAL WINE INDUSTRY .....	655
<i>Golicic, Susan L.<sup>1</sup>; Signori, Paola<sup>2</sup>; Flint, Daniel J.<sup>3</sup></i> .....	655
DATA DRIVEN MARKETING FOR GROWTH AND PROFITABILITY .....	665
<i>Grandhi, Balakrishna; Patwa, Nitin; Saleem, Kashaf</i> .....	665
BUILDING BRAND LOYALTY THROUGH SOCIAL MEDIA IN TIMES OF ECONOMIC CRISIS: A GENDER AND GEN Y PERSPECTIVE OF LUXURY FASHION CONSUMERS IN SOUTH EAST EUROPE .....	685
<i>Gubatova, Zlatina<sup>1</sup>; Kapoulas, Alexandros<sup>2</sup>; Cheng, Ranis<sup>3</sup></i> .....	685
EVOLUTION OF FUNDING AND FINANCING IN PUBLIC HIGHER EDUCATION: CHALLENGES FOR PORTUGAL AND OTHER EUROPEAN COUNTRIES .....	696
<i>Guedes, Rui<sup>1</sup>; Marta-Costa, Ana<sup>2</sup>; Ribeiro, Humberto<sup>3</sup>; Alves, Sandra<sup>4</sup>; Veloso, Cláudia<sup>5</sup></i> .....	696
VALUATING RENEWABLE ENERGY INVESTMENTS WITHIN TRANSACTIONS: A COMPARATIVE REVIEW AMONG PRACTITIONERS .....	710
<i>Hürlimann, Christian<sup>1</sup>; Bengoa, Dolores S.<sup>2</sup></i> .....	710
DOES EMPLOYEE ENGAGEMENT AFFECT CLIENT LOYALTY IN B2B SERVICES?: A QUALITATIVE STUDY IN THE ADVERTISING INDUSTRY IN SERBIA .....	727
<i>Josic, Sinisa<sup>1</sup>, Petrosyan, Armine<sup>2</sup>; Dimitriadis, Nikolaos<sup>3</sup></i> .....	727
ON THE ROAD TO MEANING: A THINKING JOURNEY TO SPIRITUALITY IN PROFESSIONAL LIFE .....	739
<i>Kay, Avi</i> .....	739

POSITIVE AND NEGATIVE ASPECTS OF MANAGER POLITICAL BEHAVIOUR IN THE PUBLIC SECTOR ORGANIZATIONS .....	747
<i>Kidron, Aviv<sup>1</sup>; Vinarski –Peretz, Hedva<sup>2</sup></i> .....	747
DETERMINANTS OF SPORT COMMITMENT AND PURCHASE INTENTION OF RUNNERS: AN EMPIRICAL EXAMINATION .....	760
<i>Koronios, Konstantinos; Kriemadis, Athanasios; Gkatsis, Georgia; Manousaridou, Genovefa</i> .....	760
THE TRADE EFFECTS OF ECONOMIC INTEGRATION IN EMERGING MARKET OF THE EURASIAN ECONOMIC UNION.....	769
<i>Kovalev, Victor; Falchenko, Oksana; Vyazovskaya, Veronika; Maydanik, Vera</i> .....	769
EFFECTIVENESS OF GOVERNMENTAL SUPPORT PROVIDED TO MONOTOWNS IN CIS COUNTRIES .....	782
<i>Kreidenko, Tatyana<sup>1</sup>; Sorokina, Svetlana<sup>2</sup>; Adashova, Tatyana<sup>1</sup></i> .....	782
INTEGRATED REPORTING AND PREPARERS' ACCOUNTABILITY: A MATTER OF CONTEXT	792
<i>Lai, Alessandro<sup>1</sup>; Melloni, Gaia<sup>2</sup>; Stacchezzini, Riccardo<sup>1</sup></i> .....	792
HOW INTEGRATED REPORTING MEETS THE INVESTORS AND OTHER STAKEHOLDERS' INFORMATION NEEDS .....	798
<i>Lai, Alessandro; Rossignoli, Francesca; Stacchezzini, Riccardo</i> .....	798
PRICE AVAILABILITY OF CAR RENTAL AS AN ALTERNATIVE OF CAR OWNERSHIP.....	805
<i>Leontyeva, Yulia; Mayburov, Igor</i> .....	805
HOW CUSTOMER EXPERIENCE ATTRIBUTES INFLUENCE CUSTOMER SATISFACTION AND ONLINE BANK CREDIBILITY .....	813
<i>Loureiro, Sandra Maria Correia<sup>1</sup>; Sarmiento, Eduardo Moraes<sup>2</sup></i> .....	813
THE OLIVE OIL PRICES DETERMINANTS FROM PRODUCTION TO RETAIL: A STUDY OF THE OLIVE OIL SECTOR IN PORTUGAL AND SPAIN .....	832
<i>Lousas, Carla<sup>1</sup>; Ribeiro, Humberto<sup>2</sup>; Alves, Sandra<sup>1</sup>; Veloso, Cláudia<sup>3</sup></i> .....	832
EFFECT OF EMPLOYEE THRIVING ON INNOVATIVE WORK BEHAVIOUR .....	849
<i>Lyndon, Shiji<sup>1</sup>; Rawat, Preeti<sup>1</sup>; Varghese, Billy Sam<sup>2</sup></i> .....	849
TOWARDS THE ADOPTION OF PATIENT GENERATED HEALTH DATA: A TECHNOLOGY READINESS INVESTIGATION OF LAGOS STATE NIGERIA .....	858

<i>Maduka, Ikechukwu C.<sup>1</sup>; Odetayo, Michael<sup>1</sup>; Nkantah, Dianabasi<sup>1</sup>; Garcia-Perez, Alexeis<sup>2</sup>; Cegarra-Navarro, Juan Gabriel<sup>3</sup>; Olayanju, Lateef O.<sup>4</sup></i> .....	858
CASE STUDIES AND MANAGEMENT ACCOUNTING RESEARCH: EPISTEMOLOGICAL CONSIDERATIONS .....	874
<i>Makrygiannakis, Georgios</i> .....	874
AN INTRODUCTION TO BIOETHICAL RIGHTS .....	885
<i>Maniatis, Antonios</i> .....	885
THE RIGHT TO RECREATION ( / $\Psi$ , X ) WITH EMPHASIS ON TOURISM .....	899
<i>Maniatis, Antonios</i> .....	899
OPTIONS FOR DIAGNOSTICS OF ECONOMIC EVOLUTION TURNING POINTS .....	913
<i>Marek, Luboš<sup>1</sup>; Hindls, Richard<sup>1</sup>; Hronová, Stanislava<sup>2</sup></i> .....	913
THE INFLUENCE OF PERSONAL AND ORGANIZATIONAL FACTORS ON ENTREPRENEURSHIP INTENTION: AN APPLICATION IN THE HEALTHCARE SECTOR.....	927
<i>Marques, Carla Susana<sup>1</sup>; Valente, Sandra<sup>2</sup>; Lages, Marisa<sup>1</sup></i> .....	927
PROFILE OF WOMEN ENTREPRENEURS IN HEALTHCARE SETOR: AN EXPLORATORY STUDY .....	941
<i>Marques, Carla Susana<sup>1</sup>; Mestre, Marta<sup>2</sup>; Nascimento, Maria M.<sup>3</sup></i> .....	941
INFLUENCE OF UPDATING ENVIRONMENTAL KNOWLEDGE THROUGH LEARNING PROCESSES TO IMPROVE PERFORMANCE IN A TOURIST MARKET .....	954
<i>Martínez-Martínez, Aurora<sup>1</sup>; Cegarra-Navarro, Juan Gabriel<sup>2</sup>; García-Pérez, Alexeis<sup>3</sup></i> .....	954
THE SUCCESS OF CROSS BORDER ACQUISITIONS: DOES CULTURAL DISTANCE MATTER FOR CONSUMERS? .....	969
<i>Matarazzo, Michela<sup>1</sup>; Lanzilli, Giulia<sup>2</sup>; Resciniti, Riccardo<sup>2</sup></i> .....	969
THE COST OF CAPITAL IN THE BOND MARKET. WHEN THE FIRMS ALLEGEDLY RESTATED EARNINGS .....	977
<i>Felice Matozza<sup>1</sup>; Elisabetta Mafrolla<sup>2</sup>; Anna Maria Biscotti<sup>2</sup></i> .....	977
APPLYING SECI MODEL TO TRANSFER ORGANIZATIONAL MEMORY THROUGH CORPORATE MUSEUMS .....	998
<i>Matricano, Diego</i> .....	998
GENDER ASYMMETRY IN BEHAVIORAL RESPONSES OF TRANSPORT FEE PAYERS .....	1006

<i>Mayburov, Igor<sup>1,2</sup>; Leontyeva, Yulia<sup>1</sup></i> .....	1006
IDENTIFICATION OF LEADERSHIP COMPETENCIES IN THE INTERNATIONAL ENVIRONMENT.....	1018
<i>Mazánek, Lukáš; Pekárek, Jan; Vraniak, Lukáš; Konečná, Zdenka</i> .....	1018
MANDATORY ENTREPRENEURS' CHARACTERISTICS TO NEW VENTURES' INTERNATIONALIZATION .....	1029
<i>Meneses, Raquel<sup>1</sup>; Moutinho, Nuno<sup>1</sup>; Azevedo, José<sup>2</sup></i> .....	1029
CONSUMER FAD DYNAMIC. THE GIN CASE.....	1042
<i>Meneses, Raquel; Almeida, Rui</i> .....	1042
ECONOMIC AND FINANCIAL BALANCE OF ITALIAN PLASTIC MANUFACTURERS DURING THE CRISIS (2008-2015).....	1056
<i>Migliaccio, Guido; De Blasio, Veronica</i> .....	1056
CITIZEN SATISFACTION IN ITALY: RESULTS FROM AN EMPIRICAL RESEARCH .....	1071
<i>Migliaccio, Guido<sup>1</sup>; Russo, Agostino<sup>2</sup></i> .....	1071
CAPITAL STRUCTURE AND PERFORMANCE: EVIDENCE FROM INDONESIA STOCK EXCHANGE .....	1085
<i>Miglietta, Nicola<sup>1</sup>; Battisti, Enrico<sup>1</sup>; Monge, Filippo<sup>2</sup></i> .....	1085
ENTREPRENEURSHIP UNTAPPED: TESTING TRAINING FOR START-UPS BY PHD STEM GRADUATES .....	1094
<i>Mihai-Yiannaki, Simona<sup>1</sup>; Varnava-Marouchou, Despina<sup>2</sup>; Konis, Elmos<sup>2</sup>; Hadjichristodoulou, Vassilia<sup>3</sup></i> .....	1094
LOCAL LIABILITIES AND INTERACTION BETWEEN NATIVE AND IMMIGRANT FIRMS .....	1106
<i>Milanesi, Matilde; Guercini, Simone</i> .....	1106
SERVICE QUALITY, CUSTOMER SATISFACTION AND CORPORATE IMAGE AS A KEY DRIVER OF CUSTOMER LOYALTY IN TRADITIONAL RETAIL.....	1120
<i>Miranda Veloso, Cláudia<sup>1</sup>; Magueta, Daniel Margaça<sup>2</sup>; Fernandes, Paula Odete<sup>3</sup>; Rito-Ribeiro, Humberto Nuno<sup>4</sup></i> .....	1120
IMPORTANCE OF CULTURAL INTELLIGENCE IN INDIAN MANAGEMENT EDUCATION ....	1135
<i>Naik, Kasturi<sup>1</sup>; Bobade, Anita<sup>2</sup></i> .....	1135
RELATIONSHIP BETWEEN WORKFORCE DIVERSITY AND EFFECTIVENESS OF INDIAN BPO ORGANIZATION .....	1152
<i>Naik, Kasturi<sup>1</sup>; Bobade, Anita<sup>2</sup></i> .....	1152

LEAN INTERNATIONALIZATION OF BORN GLOBAL FIRMS .....	1166
<i>Neubert, Michael<sup>1</sup>; Van Der Krogt, Stijn<sup>2</sup></i> .....	1166
THE ROLE OF BUSINESS MODELS IN THE INTERNATIONAL GROWTH PATH OF STARTUPS .....	1177
<i>Onetti, Alberto <sup>1</sup>; Pisoni, Alessia <sup>1</sup>; Riva, Giada<sup>2</sup></i> .....	1177
NETWORK PERSPECTIVE ON ESTABLISHMENT PROCESS IN TRANSITION ECONOMIES ....	1192
<i>Osarenkhoe, Aihie<sup>1</sup>; Fjellström, Daniella<sup>1</sup>; Abraha, Desalegn<sup>2</sup>; Awuah, Gabriel Baffour<sup>3</sup></i> .....	1192
CLUSTERING AND NETWORKING AS A SINE QUA NON FOR SMES AND REGIONAL INTERNATIONAL COMPETITIVE ADVANTAGE.....	1215
<i>Osarenkhoe, Aihie; Fjellström, Daniella</i> .....	1215
CYBER RISK MANAGEMENT IN CREDIT COOPERATIVE BANKS: A CASE STUDY .....	1239
<i>Ossola, Giovanni; Giovando, Guido; Crovini, Chiara</i> .....	1239
AN EXPLORATORY STUDY ON CONSUMERS ATTITUDES TOWARDS ETHICAL FASHION CONSUMPTION: MOTIVATORS AND BARRIERS .....	1251
<i>Öztürk, Selen; Engizek, Nil</i> .....	1251
CORPORATE CRISIS IN ITALY: YOMO SPA.....	1266
<i>Pavone, Pietro<sup>1</sup>; Migliaccio, Guido<sup>2</sup></i> .....	1266
THE QUALITY OF MISSION STATEMENTS IN THE TOURISM INDUSTRY: AN EMPIRICAL ASSESSMENT.....	1282
<i>Penco, Lara; Profumo, Giorgia; Scarsi, Roberta</i> .....	1282
GREEN MARKETING AND ITS PERCEPTION BY YOUNG CONSUMERS OF THE “GENERATION Y” .....	1298
<i>Průša, Přemysl; Sadílek, Tomáš</i> .....	1298
DETERMINANTS OF CREDIT TO SMES - EMPIRICAL EVIDENCE FROM SUPPLY SIDE PERSPECTIVE IN MUMBAI REGION .....	1308
<i>Raghu, Kumari P.S; Pankaj, Trivedi</i> .....	1308
TEAM PSYCHOLOGICAL SAFETY PREDICTING TEAM CREATIVITY: A CONDITIONAL INDIRECT EFFECT MODEL.....	1321
<i>Rego, Arménio<sup>1</sup>; Melo, Ana Isabel<sup>2</sup>; Bluhm, Dustin J.<sup>3</sup>; Pina e Cunha, Miguel<sup>3</sup>; Valverde, Camilo<sup>5</sup></i> .....	1321

E-COMMERCE STUDIES REVIEW: IMPLICATIONS AND FUTURE AGENDA FOR FIRMS AND CONSUMERS .....	1333
<i>Resciniti, Riccardo<sup>1</sup>; Matarazzo, Michela<sup>2</sup>; De Vanna, Federica<sup>1</sup> .....</i>	<i>1333</i>
VENTURE CAPITALIST'S INTERVENTION AND THE INTERNATIONALIZATION OF INTERNATIONAL NEW VENTURES (INVS) – PORTUGUESE CASE STUDY.....	1342
<i>Ribeiro, Paulo; Meneses, Raquel .....</i>	<i>1342</i>
CONCEPTUALIZING PUBLIC VALUE DESTRUCTION.....	1356
<i>Ricci, Paolo; Esposito, Paolo.....</i>	<i>1356</i>
IS THERE A MEDITERRANEAN CORPORATE GOVERNANCE SYSTEM? EVIDENCE FROM LITERATURE .....	1392
<i>Ricci, Paolo; Esposito, Paolo; Fusco, Floriana .....</i>	<i>1392</i>
ENERGY MANAGEMENT IN ITALIAN MUNICIPAL PUBLIC ADMINISTRATIONS: AN ORGANIZATIONAL CULTURAL PERSPECTIVE .....	1404
<i>Rizzi, Francesco<sup>1</sup>; Annunziata, Eleonora<sup>2</sup>.....</i>	<i>1404</i>
HORIZONTAL ORGANIZATION AND LEADERSHIP: A GENERATIVE APPROACH FOR AN ETHIC DEVELOPMENT IN COMPLEX SYSTEMS.....	1427
<i>Rizziato, Erica.....</i>	<i>1427</i>
THE BALANCE OF POWER IN THE WORLD MANUFACTURING INDUSTRY.....	1442
<i>Rodionova, Irina<sup>1</sup>; Shuvalova, Olga<sup>1</sup>; Kokuytseva, Tatiana<sup>2</sup>.....</i>	<i>1442</i>
ANTECEDENTS TO BRAND HATE AMONG GENERATION Y: A CONSUMER CROSS-CULTURAL STUDY .....	1456
<i>Rodrigues, Clarinda<sup>1</sup>; Rodrigues, Paula<sup>2</sup>.....</i>	<i>1456</i>
THE MULTISENSORY EXPERIENCE OF TASTE. THE EFFECTS OF SENSES AND BRAND IN WINE CONSUMPTION.....	1465
<i>Romanazzi, Salvatore; Petruzzellis, Luca .....</i>	<i>1465</i>
A SOUTH AFRICAN INDUSTRY PERCEPTIVE ON MODERN TRANSIT ADVERTISING MEDIA OPPORTUNITIES .....	1485
<i>Roux, Thérèse.....</i>	<i>1485</i>
UNDERVALUED AND DISORGANIZED? CLASSIFICATION AND APPRAISAL OF CONTEMPORARY OUT-OF-HOME ADVERTISING IN SOUTH AFRICA .....	1498



<i>Roux, Thérèse; Babst, Melanie; de Jager, Johan</i> .....	1498
EMPLOYEE LEARNING IN INTERCULTURAL INTERACTIONS - GROUNDED THEORY.....	1511
<i>Rozkwitalska, Malgorzata</i> .....	1511
THE MEDIATING EFFECT OF INNOVATION ON THE RELATIONSHIP BETWEEN INTANGIBLE RESOURCES AND EXPORT PERFORMANCE .....	1523
<i>Rua, Orlando Lima<sup>1</sup>; França, Alexandra<sup>2</sup></i> .....	1523
THE ROLE OF HUMAN RESOURCES FOR INBOUND OPEN INNOVATION: IMPLICATIONS FOR HIGH-TECH FIRMS. ....	1538
<i>Santoro, Gabriele</i> .....	1538
RE-AFFIRMING THE NEED FOR SYSTEMS THINKING IN SOCIAL SCIENCES: A VIABLE SYSTEMS VIEW OF SMART CITY.....	1552
<i>Saviano, Marialuisa; Caputo, Francesco</i> .....	1552
TAYLORISM AND AMAZON: SCIENTIFIC MANAGEMENT AT THE WORLD'S MOST SUCCESSFUL RETAIL COMPANY .....	1568
<i>Schein, Andrew</i> .....	1568
WHAT IS SMART LEADERSHIP IN LUXEMBOURG? .....	1579
<i>Schinzel, Ursula</i> .....	1579
WHAT IS SUCCESS OR FAILURE IN M&AS? A STAKEHOLDER PERSPECTIVES .....	1612
<i>Schriber, Svante<sup>1</sup>; Meglio, Olimpia<sup>2</sup></i> .....	1612
OVERCOMING “IMPERFECTIONS” OF TECHNOLOGICAL CHANGE: THE BORDERLESS NATURE OF ENTREPRENEURSHIP IN OPEN INNOVATION MODEL .....	1624
<i>Scuotto, Veronica<sup>1</sup>; Usai, Antonio<sup>2</sup>; Murray, Alan<sup>3</sup>; Fiano, Fabio<sup>4</sup></i> .....	1624
CONSUMER PERCEPTIONS AND USES OF SOCIAL MEDIA AROUND VARSITY CUP RUGBY: A TRADITIONAL SOUTH AFRICAN UNIVERSITY .....	1633
<i>Serra, Pamela</i> .....	1633
OWNERSHIP STRUCTURE AND FINANCIAL PERFORMANCE OF COMPANIES IN THE FRENCH STOCK MARKET INDEX CAC 40: IS THE FRENCH GOVERNMENT A PERFORMING SHAREHOLDER? .....	1644
<i>Spurr, Michael<sup>1</sup>; Goehlich, Veronique<sup>1</sup>; Fournier, Guy<sup>2</sup></i> .....	1644
BIG DATA IN SME - FINDINGS OF AN EMPIRICAL STUDY.....	1659

<i>Sterk, Matthias; Graue, Carolin; Britzelmaier, Bernd</i> .....	1659
PROMOTING INTERNET USAGE: AN ANALYSIS OF NONUSERS.....	1678
<i>Teerakapibal, Surat</i> .....	1678
MANDATORY DISCLOSURE OF NON-FINANCIAL INFORMATION: A STRUCTURED LITERATURE REVIEW .....	1684
<i>Testarmata, Silvia; Sergiacomi, Silvia; Fortuna, Fabio</i> .....	1684
LINKING MOTIVATION WITH CREATIVITY IN GREECE.....	1704
<i>Thrassou, Alkis<sup>1</sup>; Orfanos, Dimosthenis<sup>2</sup>; Tsoukatos, Evangelos<sup>3</sup></i> .....	1704
EXAMINING THE ECONOMIC FACTORS THAT INFLUENCE THE TECHNICAL EFFICIENCY IN GOAT FARMS IN GREECE.....	1718
<i>Tsiouni, Maria<sup>1</sup>; Aggelopoulos, Stamatis<sup>2</sup>; Papanagiotou, Evangelos<sup>1</sup>; Chioteris, Cpyridon<sup>2</sup></i> .....	1718
EXPLORING ALTERNATIVE VIEWS ON CLUTCHES OF UKUTHWALA IN THE PATRIARCHAL CULTURE OF SOUTH AFRICA: BALANCING OF HUMAN RIGHTS.....	1728
<i>Van der, Bank; Christienna, Maria</i> .....	1728
SHAREHOLDER DILEMMA: WHAT STAKE TO OFFER TO FINANCIAL INVESTORS? PROPOSALS BASED ON FINANCIAL PRINCIPLES.....	1741
<i>Vashakmadze, T.; Martirosyan, E.; Sergeeva, A.</i> .....	1741
SCREENING AND SCORING PROCESS IN M&A DEALS OF SERIAL ACQUIRERS. EVIDENCE FROM THE RUSSIAN AND INTERNATIONAL MARKETS.....	1750
<i>Vashakmadze, Teimuraz; Martirosyan, Emil; Sergeeva, Anastasia; Krechun Margarita</i> .....	1750
WHEN THINGS GO WRONG: UNTANGLING THE ORIGINS OF INTER-FIRM NETWORK TERMINATION .....	1770
<i>Vernizzi, Silvia;Cantele, Silvia</i> .....	1770
DIGITISATION AND BRANDING EVOLUTION: AN INTEGRATIVE CONCEPTUAL FRAMEWORK .....	1782
<i>Vernuccio, Maria</i> .....	1782
EFFSAMWMIX : AN EFFICIENT STOCHASTIC MULTI-ARMED BANDIT ALGORITHM BASED ON A SIMULATED ANNEALING WITH MULTIPLICATIVE WEIGHTS .....	1793
<i>Villari, Bobby Chaitanya; Abdulla, Mohammed Shahid</i> .....	1793

PORTFOLIO CHOICE DECISION MAKING WITH <i>NBP-EFFSAMWMIX</i> : A STOCHASTIC MULTI-ARMED BANDIT ALGORITHM USING NAÏVE BANDIT PORTFOLIO APPROACH.....	1808
<i>Villari, Bobby Chaitanya; Abdulla, Mohammed Shahid FPM Student, IT &amp; Systems Area.....</i>	<i>1808</i>
WHAT COMES FIRST, THE CHICKEN OR THE EGG: THE UNDERPINNING TECHNOLOGY OR BUSINESS MODEL? .....	1823
<i>Vinaik, Rubal; Zubac, Angelina.....</i>	<i>1823</i>
LEGITIMACY THEORY AND SUSTAINABILITY REPORTING. EVIDENCE FROM ITALY. ....	1835
<i>Vitolla, Filippo; Rubino, Michele.....</i>	<i>1835</i>
THE SOLAR PV SECTOR. EVOLUTION AND GROWTH OF INNOVATION IN THE SECTORAL SYSTEM.....	1849
<i>Xue, Han<sup>1</sup>; Jorge, Niosi<sup>2</sup>.....</i>	<i>1849</i>

## TABLE OF ABSTRACTS

IC AND ENABLING FACTORS FOR STARTUPS IN A BUSINESS ECOSYSTEM PERSPECTIVE ..	1865
<i>Abbate, Tindara<sup>1</sup>; Accordino, Patrizia<sup>2</sup>; La Rocca, Elvira Tiziana<sup>1</sup>; Rupo, Daniela<sup>1</sup>.....</i>	<i>1865</i>
MARKET DOCTRINE (MD), CREATIVITY, AND NEW PRODUCT PERFORMANCE IN INTERNATIONAL MARKETS.....	1868
<i>Abboud, Amer; Shoham, Aviv.....</i>	<i>1868</i>
DEROGATION EFFECT OF USING SUCCESSFUL VERSUS ATTRACTIVE SPOKESPERSON IN ADVERTISING: A COMPARATIVE STUDY BETWEEN THE NETHERLANDS AND BRAZIL .....	1871
<i>Adigüzel, Feray<sup>1</sup>; Buranello, Renata<sup>2</sup> .....</i>	<i>1871</i>
INTERNATIONAL DIFFERENCES IN SPORT EVENT SPONSORSHIP EFFECTIVENESS.....	1874
<i>Adigüzel, Feray<sup>1</sup>; Kennett, Christopher<sup>2</sup> .....</i>	<i>1874</i>
IMPULSIVE BUYING AND SHOPPING MOTIVATIONS IN EMERGENT AND MATURE MARKETS .....	1877
<i>Adigüzel, Feray .....</i>	<i>1877</i>
THE IMPACT OF EXISTENTIAL GUILT APPEAL ON CONSUMER INTENTION TO PURCHASE CAUSE-RELATED PRODUCT OR TO DONATE TO CHARITY .....	1880
<i>Adomaviciute, Karina; Urbonavicius, Sigitas; Urbutyte, Ieva.....</i>	<i>1880</i>
IMPACT OF STRESS AND JOB SATISFACTION ON MENTAL WELL BEING OF HEALTHCARE PROFESSIONALS .....	1882
<i>Aggarwal - Gupta, Meenakshi<sup>1</sup>; Vatharkar, Poonam<sup>2</sup> .....</i>	<i>1882</i>
FAMILY BUSINESS EFFICACY AND PERFORMANCE .....	1887
<i>Al Kayid, Wejdan Saeed; Zhongqi, Jin; Ramakrishnan, Sumeetra; Priporas, Costas.....</i>	<i>1887</i>
ESTIMATION OF MANAGERIAL DISCRETION IN ACCRUALS USING FIRM LIFE CYCLE .....	1889
<i>Almand, Andrew<sup>1</sup>; Cantrell, Brett<sup>2</sup>; Dickinson, Victoria<sup>2</sup> .....</i>	<i>1889</i>
EXPLORING THE EFFECTS OF BRAND COMMUNITY CENTRIC MODEL ON FANDOM AND BRANDOM OF FOOTBALL FANS.....	1892
<i>Alon, Anat Toder; Shuv-Ami, Avichai .....</i>	<i>1892</i>
AN ASSESSMENT OF CUSTOMER RETENTION WITH SELF-SERVICE TECHNOLOGY: A COMPARATIVE STUDY BETWEEN INTERNET BANKING AND MOBILE BANKING IN SAUDI ARABIA.....	1895

<i>Alsiehemy, Ali; Battor, Moustafa; Pantano, Eleonora; Dennis, Charles</i> .....	1895
INTENSIFYING THE POWER OF THE PORTUGUESE LANGUAGE: COMMUNICATING ON SCIENCE .....	1898
<i>Alves, Gisela; Martins, Moisés de Lemos</i> .....	1898
HOW TRUST AND COOPERATION HAVE AN IMPACT ON INTERNATIONAL BUSINESS: A CASE STUDY .....	1900
<i>Alves, Gisela</i> .....	1900
MULTI-CHANNEL AND OMNICHANNEL MARKETING: THE NEW TRENDS IN DIGITAL MARKETING COMMUNICATIONS .....	1902
<i>Amirkhanpour, Monaliz<sup>1</sup>; Vrontis, Demetris<sup>2</sup></i> .....	1902
MEASURING THE ECONOMIC EFFECTS OF TOURISM: THE CASE STUDY OF ITALY .....	1905
<i>Andreottola, Francesco; Massaro, Maria Rita</i> .....	1905
THE STATE OF UNIVERSITY – BUSINESS COOPERATION IN GREECE .....	1908
<i>Angelopoulou, Konstantina<sup>1</sup>, Tsoukatos, Evangelos<sup>2</sup></i> .....	1908
AUTONOMY, INNOVATION MATURITY AND INTRAPRENEURSHIP AS DRIVERS OF INNOVATION MANAGEMENT PROCESSES: EVIDENCE FROM THE WATER SECTOR .....	1912
<i>Annunziata, Eleonora<sup>1</sup>; Pellegrini, Chiara<sup>1</sup>; Rizzi, Francesco<sup>2</sup>; Frey, Marco<sup>1</sup></i> .....	1912
MANAGEMENT OBJECTIVES IN M&A DECISIONS: A DEPARTURE FROM RATIONALITY?... 1914	
<i>Arnold, Nicole<sup>1</sup>, Bengoa, S. D.<sup>2</sup></i> .....	1914
COMMUNICATION SKILLS OF ENTRY-LEVEL ACCOUNTANTS IN GREECE .....	1919
<i>Asonitou, Sofia<sup>1</sup>; Tourna, Eleni<sup>1</sup>; Koukouletsos, Kostas<sup>2</sup>, Touloumis, Konstantinos<sup>1</sup></i> .....	1919
IMPACT OF CORPORATE GOVERNANCE MECHANISM ON FIRM PERFORMANCE: EVIDENCE FROM AN EMERGING MARKET .....	1921
<i>Ataay, Aylin</i> .....	1921
WOMENOMICS: IS THE WORKFORCE READY?.....	1924
<i>Averianova, Irina<sup>1</sup>; Nae, Niculina<sup>2</sup></i> .....	1924
LINKING CONSUMER BEHAVIOR, VIRAL MARKETING AND CINEMATOGRAPHY: A PRACTICAL APPLICATION FOR NGOS .....	1925
<i>Avgeropoulou, Katerina; Melanthiou, Yioula; Papasolomou, Ioanna</i> .....	1925
ESCAPE EXPERIENCES IN LIGHTHOUSE TOURISM: A PHOTO ELICITATION PERSPECTIVE	1927

<i>Azevedo, António J. A.</i> .....	1927
DO COUNTRY-SPECIFIC FACTORS AFFECT THE VALUE RELEVANCE OF BRAND VALUE? AN EMPIRICAL ANALYSIS .....	1930
<i>Bagna, Emanuel<sup>1</sup>; Dicuonzo, Grazia<sup>2</sup>; Perrone, Andrea<sup>2</sup>; Dell'Atti, Vittorio<sup>2</sup></i> .....	1930
A COMPARATIVE CROSS COUNTRY ANALYSIS OF BANK MARKETING STRATEGIES DURING THE CURRENT GLOBAL FINANCIAL CRISIS .....	1932
<i>Balomenou, Chrysanthi; Akriviadi, Amalia</i> .....	1932
THE CRUCIAL ROLE OF LENDER OF LAST RESORT AS ONE OF THE MAJOR MEANS OF THE BANKING SAFETY NET, ESPECIALLY IN CRISIS AND RECESSION PERIODS .....	1938
<i>Balomenou, Chrysanthi</i> .....	1938
SMES, SOCIAL MEDIA AND INTERNATIONALIZATION: AN EXPLORATIVE RESEARCH .....	1943
<i>Bartoloni, Sara; Pascucci, Federica</i> .....	1943
THE SOCIAL RESPONSIBILITY IN BANKING: REVIEW AND RESEARCH PERSPECTIVES.....	1946
<i>Bellomo, Mario Filippo Paolo; La Rosa, Fabio</i> .....	1946
A CHOICE OF SOCIALLY RESPONSIBLE INSTRUMENTS: SME STUDY IN 6 COUNTRIES .....	1948
<i>Belyaeva, Zhanna<sup>1</sup>; Lopatkova, Yana<sup>1</sup>; Kislyak, Nadezhda<sup>1</sup>; Rudawska, Edyta<sup>2</sup></i> .....	1948
CONSUMER-BRAND ENGAGEMENT THROUGH WEBSITE STIMULI.....	1951
<i>Bilro, Ricardo; Loureiro, Sandra Maria Correia</i> .....	1951
DOES THE PRESENCE OF WOMEN IN SUPERVISORY BOARDS INFLUENCE FIRM PERFORMANCE? .....	1955
<i>Binder, B.C.K.</i> .....	1955
MARKETING DOCTRINE AS A PRECURSOR TO NEW PRODUCT DEVELOPMENT AND INTERNATIONAL PERFORMANCE: TOWARDS A TESTABLE THEORETICAL MODEL .....	1958
<i>Boulos, Jumana Shukri; Shoham, Aviv</i> .....	1958
DOES MONEY BUY YOU HAPPINESS? .....	1961
<i>Bozcuk, Aslihan</i> .....	1961
HRM-PATIENT ORIENTATION AND TEAMWORK CLIMATE LINKAGE IN HEALTH CARE INSTITUTIONS: THE ROLE OF CALLING AND PROSOCIAL MOTIVATION .....	1964
<i>Bučičūnienė, Ilona<sup>1</sup>; Goštautaitė, Bernadeta<sup>1</sup>; Žemyna Milašauskienė<sup>2</sup></i> .....	1964
INNOVATION NETWORK DYNAMICS IN THE AEROSPACE CLUSTER IN TUSCANY.....	1968

<i>Capone, Francesco; Zampi Vincenzo</i> .....	1968
MANAGING ORGANIZATIONAL AND BRAND IDENTITY IN FAMILY FIRM: PRELIMINARY EVIDENCES FROM AN ITALIAN CASE .....	1971
<i>Casprini, Elena<sup>1</sup>; Ticci, Camilla<sup>2</sup>; Zanni, Lorenzo<sup>2</sup></i> .....	1971
CRITICAL SUCCESS FACTORS OF THE MERGERS AND ACQUISITIONS PERFORMANCE: INTERRELATIONSHIP OF PLANNING STAGE (PRE-MERGER) AND INTEGRATION PROCESS (POST-MERGER) .....	1974
<i>Chew, Grace</i> .....	1974
FOOD WASTE REDUCTION AND SHELF LIFE EXTENSION: THE CASE STUDY OF OLIVE PATE .....	1977
<i>Chiara, Filomena<sup>1</sup>; Pellegrini, Giustina<sup>1*</sup>; Contò, Francesco<sup>1</sup></i> .....	1977
A MODEL ON ANTECEDENTS OF DIGITAL PIRACY BEHAVIOUR .....	1980
<i>Christofi, Anna-Maria<sup>1</sup>; Coudounaris, Dafnis N.<sup>2</sup></i> .....	1980
DEVELOPMENT OF SOCIAL ENTERPRISE: DISTRIBUTION OF PROFIT OR NON-DISTRIBUTION CONSTRAINT? .....	1981
<i>Cosentino, Antonietta<sup>1</sup>; Di Stefano, Cristina<sup>2</sup>; Magistro, Angela<sup>1</sup></i> .....	1981
A NEW PERSPECTIVE IN BUSINESS EVALUATION: MEASURING SOCIAL IMPACT VALUE. A CASE STUDY ON ITALIAN WORK INTEGRATION COOPERATIVES.....	1987
<i>Cosentino, Antonietta<sup>1</sup>; Bongiovanni, Laura<sup>2</sup>; Cesari, Alberto<sup>2</sup>; Di Stefano, Cristina<sup>3</sup></i> .....	1987
ANTECEDENTS OF BRAND EQUITY OF NORDIC UNIVERSITIES AND MODERATING EFFECTS .....	1990
<i>Coudounaris, Dafnis N.<sup>1</sup>; Koasova, Olga<sup>2</sup></i> .....	1990
IS PUBLIC SUPPORT A BAD FOR THE DISSEMINATION OF CROWDFUNDING AMONG INNOVATIVE START UP FIRMS? .....	1991
<i>Cucari, Nicola; Ghi, Alessandra; Orlando, Beatrice; Renzi, Antonio</i> .....	1991
SHARING KNOWLEDGE TO INCREASE FOOD VALUE CHAIN: THE INTRODUCTION OF DSS BY SUPPLY CHAIN LEADER DRIVING FARMER'S MANAGERIAL CULTURAL CHANGE.....	1995
<i>Cupertino, Sebastiano; Vitale, Gianluca; Riccaboni Angelo</i> .....	1995
ENTREPRENEURSHIP AS A CONTEXTUAL PHENOMENA .....	1998
<i>Czarczynska, Anna<sup>1</sup>; Mosquera, José Luis Naya<sup>2</sup></i> .....	1998

THE PIVOTAL ROLE OF ORGANIZATIONAL LEARNING AS A LINK BETWEEN EXPORTER'S ORIENTATIONS AND CAPABILITIES AND BETWEEN INTERNATIONAL PERFORMANCES . 2002	
<i>Dahan, Gavriel<sup>1</sup>; Shoham, Aviv<sup>2</sup></i> .....	2002
THE IMPACT OF INTERNAL AND EXTERNAL ORGANIZATIONAL ORIENTATIONS ON FIRM PERFORMANCE.....	2005
<i>Dahan, Gavriel<sup>1</sup>; Shoham, Aviv<sup>2</sup>; Asseraf, Yoel<sup>3</sup></i> .....	2005
ECONOMIC ANIMOSITY, NATIONALISM, AND COUNTRY IMAGE: "US VS. OTHERS" IN TIMES OF CRISIS.....	2008
<i>De Nisco, Alessandro<sup>1</sup>; Papadopoulos, Nicolas<sup>2</sup>; Napolitano, Maria Rosaria<sup>3</sup>; Mainolfi, Giada<sup>1</sup></i> .....	2008
THE VALUE RELEVANCE OF CORPORATE SOCIAL RESPONSIBILITY IN THE EUROPEAN STOCK MARKETS: THE INFLUENCE OF STANDARD ETHICS RATING .....	2011
<i>Dicuonzo, Grazia; Ricciardi, Francesca; Dell'Atti, Vittorio</i> .....	2011
PREDICTING THE PRESENT AND FUTURE OF AQUAPONICS WITH GOOGLE TRENDS.....	2013
<i>Dos Santos, Maria José Palma Lampreia</i> .....	2013
COMMUNITY BASED BUSINESS MODEL PROPOSITION .....	2018
<i>Drummond, Damon</i> .....	2018
EFFECT OF CULTURAL INTELLIGENCE AND PROFESSIONAL COMMITMENT ON WELL-BEING OF EXPATRIATES AND HOST COUNTRY NATIONALS.....	2019
<i>Duyar, Veli Deniz; Erkuş, Ahmet</i> .....	2019
"DELIBERATED INTUITION" IN STOCK PRICE FORECASTING .....	2020
<i>Endress, Tobias; Gear, Tony</i> .....	2020
THE IMPACT OF STUDYING IN A SOCIOECONOMICALLY DIFFERENT SOCIETY COMPARED TO THE HOME COUNTRY ON WORK RELATED VALUES: EVIDENCE FROM CYPRIOT WORKERS WHO WERE EDUCATED IN THE UK.....	2022
<i>Epaminonda, Epaminondas</i> .....	2022
INTERRELATIONS BETWEEN PERCEIVED ATTRIBUTES AND THEIR INFLUENCE ON PREFERENCE OF USER INTERFACES .....	2024
<i>Eytam, Eleanor</i> .....	2024
STUDENTS' PERCEPTIONS ON SMART CITY INITIATIVES: EVIDENCES FROM ITALY AND RUSSIA .....	2026



<i>Ferraris, Alberto<sup>1</sup>; Belyaeva, Zhanna<sup>2</sup></i> .....	2026
ADOPTION OF RISK MANAGEMENT IN SMES: A SYSTEMATIC LITERATURE REVIEW .....	2029
<i>Ferreira de Araújo Lima, Priscila; Verbano, Chiara; Crema, Maria</i> .....	2029
TOWARD DEVELOPING A PRACTICAL MODEL FOR SUCCESSFUL GENERATIONAL TRANSITION IN THE FAMILY BUSINESS .....	2033
<i>Flynn, JoAnn; Duesing, Robert J.</i> .....	2033
THE COST OF EQUITY OF <i>TOO BIG TO FAIL</i> BANKS (TBTF). A COMPARATIVE STUDY BETWEEN CAPM, THE METHOD BASED ON THE RECIPROCAL OF P/E MULTIPLE AND ACTUARIAL METHOD .....	2036
<i>Fontana, Stefano; Coluccia, Daniela; Solimene, Silvia; Rosati, Serena</i> .....	2036
RETAILERS' INVENTORY STRATEGY ON PURCHASING-CONSUMPTION CYCLE MODEL OF CONSUMERS .....	2039
<i>Fujimoto, Hisao</i> .....	2039
THE CHOICE OF CREATIVE COMMONS LICENSE .....	2042
<i>Gambardella, Massimiliano</i> .....	2042
THE ROLE OF CENTRAL BANKS IN THE RECENT FINANCIAL CRISIS. CAUSES AND CONSEQUENCES OF THE CRISIS AND COUNTERMEASURES TAKEN .....	2044
<i>Georgakoulis, Athanasios; Koulakiotis, Athanasios</i> .....	2044
BANK COMPANY RELATIONSHIPS FOR STRENGTHENING AN INTERNATIONAL COMPETITION. ANALYSIS OF ITALIAN CONTEXT .....	2047
<i>Giacosa, Elisa<sup>1</sup>; Mazzoleni, Alberto<sup>2</sup></i> .....	2047
GLOBAL BANNING OF A DIFFUSED CONTROVERSIAL PRACTICE: DEINSTITUTIONALIZATION IN THE SOCCER INDUSTRY .....	2048
<i>Gurses, Kerem<sup>1</sup>; Giones, Ferran<sup>2</sup>; Mehtakumar, Kandarp<sup>3</sup></i> .....	2048
EMERGING-MARKET FIRMS' CROSS-BORDER ACQUISITION COMPLETION: INSTITUTIONAL IMAGE AND STRATEGIES .....	2051
<i>He, Xinming<sup>1</sup>; Zhang, Jianhong<sup>2</sup></i> .....	2051
CROSS-BORDER MERGER AMONG NORDIC BANKS – A LONGITUDINAL STUDY .....	2052
<i>Hyder, S. Akmal; Osarenkhoe, Aihie</i> .....	2052
CUSTOMER RELATIONSHIP MANAGEMENT TECHNOLOGY USE OF SALESPEOPLE .....	2055

<i>Itani, Omar S.</i> .....	2055
TOURIST EXPERIENCE AND VIRTUAL REALITY: THE CASE OF NURAGICA PROJECT .....	2056
<i>Izzo, Filomena<sup>1</sup>; Solinas, Maria Carmela<sup>2</sup>; Pinna, Paolo Alberto<sup>2</sup></i> .....	2056
PROJECTIFICATION OF THE NON-GOVERNMENTAL SECTOR IN POLAND .....	2058
<i>Jalocha, Beata; Bogacz-Wojtanowska, Ewa</i> .....	2058
EMERGING MARKET MULTINATIONALS FROM LATIN AMERICA: ANALYZING THE INTERNATIONALIZATION PATTERNS AND M&AS CORPORATE STRATEGIES OF MEXICO'S LARGEST COMPANIES. ....	2061
<i>Jarque, Eduardo</i> .....	2061
AN INVESTIGATION OF WAITERS' OCCUPATIONAL IDENTITY (WOI): A LITERATURE REVIEW AND CONCEPTUAL FRAMEWORK .....	2065
<i>Jerez, M.J. ; Melewar, TC; Foroudi, P.; Stylidis, D.</i> .....	2065
CYPRUS AND THE U.K.: DELIVERING NUTRITIONAL ADVICE SERVICES THROUGH DIGITAL TECHNOLOGY .....	2069
<i>Kakouri, Stella K.<sup>1</sup>, Scott, Peter<sup>2</sup> and Scott, Tamsin<sup>3</sup></i> .....	2069
THE IMPACT OF SOCIAL MEDIA BRAND COMMUNICATION ON BRAND EQUITY FOR YOUNG CONSUMERS: INTERNATIONAL HIGH STREET FASHION BRANDING IN CHINA .....	2074
<i>Kan, Yuna; Dennis, Charles; Melewar, TC; Foroudi, Pantea</i> .....	2074
NATIONAL INNOVATION SYSTEM IN SMALLER NATIONS; THE CASE OF MONTENEGRO .....	2076
<i>Karadzic, Vesna<sup>1</sup>; Manijeh, Reyhani<sup>2</sup></i> .....	2076
IDENTIFYING SUCCESS FACTORS IN FOOD EXPORTS: AN APPLICATION OF THE BEST-WORST SCALING METHOD .....	2079
<i>Karipidis, Philippos<sup>1</sup>; Chrysochou, Polymeros<sup>2</sup>; Karypidou, Ioanna<sup>3</sup></i> .....	2079
TITLE- DEVELOPMENT AND VALIDATION OF A SCALE FOR TEAM TASK ROLES, TEAM TASK TYPES AND TASK INTERDEPENDENCIES .....	2081
<i>Karve, Shailaja<sup>1</sup>; Pandey, Aparna<sup>2</sup>; Malankar, Shweta<sup>3</sup></i> .....	2081
SPONTANEOUS VS. INDUCED CLUSTERS: NETWORKS AND COMPETITIVE ADVANTAGE .....	2084
<i>Kavadarlı, Altın; Öz, Özlem<sup>2</sup></i> .....	2084
THE IMPACT OF DIGITAL NETWORKS ON MANAGERIAL DECISION MAKING: PRACTICALITIES AND PARADOXES.....	2086

<i>Kay, Avi</i> .....	2086
EMERGENCE OF COMPLEX NEW ARRANGEMENTS: THE STATE RESPONSES TO GLOBAL BUSINESS DIVERSITY .....	2089
<i>Kayasan, Oskar; Saghir, Nadine</i> .....	2089
MARGINAL REVOLUTION: ROLE OF INTERMEDIARY IN INTEGRATION OF STREET VENDORS IN FORMAL ECONOMY .....	2090
<i>Kella, Chintan; Rimac, Tomislav; Gurses, Kerem; Turner, Karynne</i> .....	2090
SUPERVISOR COMMITMENT VERSUS ORGANIZATIONAL COMMITMENT .....	2093
<i>Kidron, Aviv</i> .....	2093
THE BUSINESS MODEL CANVAS AS THE KEY TO A COMPANY'S SUCCESS .....	2094
<i>Klimova, Olena</i> .....	2094
ROLE OF DIGITAL COMMUNICATIONS IN SOCIAL SUPERMARKETS IN CROATIA .....	2096
<i>Knezevic, Blazenka; Skrobot, Petra; Delic, Mia</i> .....	2096
CUSTOMER ORIENTED STRATEGY AND BUSINESS PERFORMANCE: EVIDENCE FROM THE TOURISM AND HOSPITALITY INDUSTRY .....	2098
<i>Kriemadis, Thanos; Papaioannou, Alkistis; Rizos John; Koronios, Konstantinos</i> .....	2098
REMITTANCE BEHAVIOR OF PERMANENT MIGRANTS .....	2101
<i>Kushmirovich Nonna</i> .....	2101
INNOVATIVE SKILLS MANAGEMENT FOR THE AGRICULTURAL ENTREPRENEUR .....	2105
<i>Lachapelle, Nathalie</i> .....	2105
FOR THE STUDY OF DEVELOPMENT GOVERNMENTAL STRATEGY TO SUPPORT THE ENTREPRENEURIAL EDUCATION IN GEORGIA .....	2107
<i>Lekashvili, Eka</i> .....	2107
AVAILABILITY OF CAR RENTAL AS AN ALTERNATIVE OF CAR OWNERSHIP .....	2110
<i>Leontyeva, Yulia<sup>1</sup>; Mayburov, Igor<sup>2</sup></i> .....	2110
THE EFFECT OF DIGITAL VARIABLES ON PERCEIVED EMPLOYABILITY IN AN ETHNIC MINORITY AND HEGEMONIC GROUP .....	2111
<i>Lissitsa, Sabina<sup>1</sup>; Chachashvili-Bolotin, Svetlana<sup>2</sup></i> .....	2111
EXPOSURE TO BULLYING AND JOB BURNOUT: THE PROTECTIVE ROLE OF JOB RESOURCES .....	2114

<i>Livne, Yael; Goussinsky, Ruhama</i> .....	2114
LOVE AND RESPECT IN THE SOCCER INDUSTRY .....	2117
<i>Loureiro, Sandra Maria Correia<sup>1</sup>; Kaufmann, Hans Ruediger<sup>2</sup></i> .....	2117
LOCAL COMMUNITY AND TOURISTS - PERCEPTIONS ABOUT THE IMPACTS OF TOURISM IN THE HISTORIC ZONE OF PORTO .....	2123
<i>Magalhães, Carla; Marques, Isabel; Candeias, Maria Teresa</i> .....	2123
STAKEHOLDER'S PERCEIVED REPUTATION OF LOCAL GOVERNMENT OF SOUTH AFRICA .....	2125
<i>Maleho, Lazarus Mohapi</i> .....	2125
SMES FARMING SUSTAINABILITY: THE ROLE OF AGRIFOOD HUBS .....	2126
<i>Malindretos, George <sup>1</sup>; Moschouris Socratis<sup>2</sup>, Kinanlis Panagiotis<sup>1</sup></i> .....	2126
THE RIGHT TO CONTAINING CLIMATE CHANGE (CCC).....	2129
<i>Maniatis, Antonios</i> .....	2129
ENTREPRENEURIAL THINKING AND ACTING IN GERMAN HOTELS – AN ANALYSIS FROM AN INDIVIDUAL AND ORGANIZATIONAL POINT OF VIEW .....	2132
<i>Männicke, Jörg<sup>1</sup>; Baierl, Ronny<sup>2</sup>; Freyer, Walter<sup>3</sup></i> ; .....	2132
FREEDOM AND PROSPERITY: COMPARATIVE ANALYSIS OF POST-COMMUNIST NATIONS .....	2139
<i>Mardanov, Ismatilla</i> .....	2139
BRAND EQUITY: A PROBABILISTIC APPROACH ON BRAND PREFERENCE .....	2142
<i>Martins, Marta; Brandão, Amélia; Santos, Luís Delfim</i> .....	2142
INSTITUTIONAL PILLARS IN CSR IN THE RUSSIAN OIL INDUSTRY .....	2145
<i>Mathews, Martin; Benyaminova, Alina</i> .....	2145
VERNACCIA DI SAN GIMIGNANO: A BUSINESS-CASE ANALYSIS TO RE-POSITION AN ITALIAN ORIGIN LABELLED WHITE WINE.....	2150
<i>Mattiacci, Alberto<sup>1</sup>; Caratù, Myriam<sup>1</sup>; Fisichella, Chiara<sup>2</sup></i> .....	2150
TOWARDS A ROUTE TO MARKET FRAMEWORK FOR EUROPE WIDE AMBIENT ASSISTED LIVING TECHNOLOGY SOLUTIONS.....	2153
<i>McConalogue, Eoghan; Davis, Paul</i> .....	2153
HEDGE FUNDS PERFORMANCE TRACKING FOR CYPRUS, U.K. AND IRELAND.....	2155

<i>Mihai Yiannaki, Simona</i> .....	2155
BORN GLOBAL FAMILY FIRMS .....	2157
<i>Musso, Fabio; Francioni, Barbara; Masili, Giorgia</i> .....	2157
THE EFFECT OF NEPOTISM / WASTA ON HR PRACTICES IN LEBANESE AND TUNISIAN COMPANIES .....	2159
<i>Nakhle, Samer F.<sup>1</sup>; Yahiaoui, Dorra<sup>2</sup>; Vrontis, Demetris<sup>3</sup>; Naddour, Fadi<sup>4</sup></i> .....	2159
DOES FUND RAISING TRIGGER THE INTERNATIONALIZATION OF STARTUPS?.....	2164
<i>Onetti, Alberto; Pisoni, Alessia</i> .....	2164
THE VISITOR EMOTIONAL EXPERIENCE AT A HERITAGE SITE: A CASE STUDY – THE AUSCHWITZ-BIRKENAU DEATH CAMP .....	2167
<i>Oren Gila<sup>1</sup>; Poria Yaniv<sup>2</sup>; Reichel Arie<sup>2</sup></i> .....	2167
THE ROLE OF SELF AWARENESS AND SELF EFFICACY ON CAREER DECISION MAKING OF THE STUDENTS .....	2170
<i>Özek, Hande<sup>1</sup>; Ferraris, Alberto<sup>2</sup></i> .....	2170
ORGANIZATION STUDIES MEET FILM STUDIES: THE CASE OF ISTANBUL’S FILM CLUSTERS .....	2173
<i>Özlem, Öz<sup>1</sup>; Kaya, Özkaracalar<sup>2</sup></i> .....	2173
EXPLORING ATTITUDES AND RESPONSIBLE BEHAVIOR TOWARDS THE PHYSICAL ENVIRONMENT AMONG ELEMENTARY SCHOOL STUDENTS IN GREECE.....	2175
<i>Melanthiou, Yioula<sup>1</sup>; Papasolomou, Ioanna<sup>1</sup>; Kountouros, Haris<sup>2</sup></i> .....	2175
THE EFFECTS OF DOWNWARD LINE EXTENSIONS ON CONSUMER BRAND ATTITUDE: THE CASE OF THE EUROPEAN PREMIUM AUTOMOTIVE MARKET .....	2179
<i>Pedrosa, Gabriel; Nobre, Helena</i> .....	2179
VALUE OF LISTED COMPANIES; ABNORMAL EARNINGS AND INNOVATIVENESS.....	2182
<i>Philipson, Sarah</i> .....	2182
THE DETECTION OF FALSE FINANCIAL STATEMENTS USING ACCOUNTING RATIOS: AN EMPIRICAL INVESTIGATION .....	2190
<i>Pisciotta, Raffaella; Dicuonzo, Grazia</i> .....	2190
THE TREND OF HEALTH CARE TOURISM: LITERATURE REVIEW .....	2192
<i>Pjero (Beqiraj), Elenica<sup>1</sup>; Kamberi, Fatjona<sup>2</sup>; Mechili, Enkeleint Aggelos<sup>3</sup></i> .....	2192

ONLINE BUYING INTENTIONS OF WINE CONSUMERS: THE ROLE OF KNOWLEDGE AND SOCIAL MEDIA .....	2197
<i>Pucci, Tommaso<sup>1</sup>; Casprini, Elena<sup>2</sup>; Nosi, Costanza<sup>3</sup>; Zanni, Lorenzo<sup>1</sup></i> .....	2197
RELIGIOSITY AND ORGANIC FOOD CONSUMPTION. TOWARDS A DEEPER UNDERSTANDING .....	2201
<i>Raggiotto, Francesco<sup>1</sup>; Mason, Michela Cesarina<sup>1</sup>; Moretti, Andrea<sup>1</sup>; Cardinali, Silvio<sup>2</sup></i> .....	2201
REDEPLOYMENT OF BRAND ASSETS FOLLOWING M&A BY EMERGING MARKET FIRMS ...	2204
<i>Rahman, Mahabubur</i> .....	2204
WHY WE CONSUME FINANCIAL SELF-HELP? A THICK EXPLANATION USING CONSUMER TALES .....	2206
<i>Rahman, Kaleel</i> .....	2206
A MODERATED MEDIATION MODEL FOR THE ROLES OF TEAM LEARNING IN PROMOTING TEAM INNOVATION IMPLEMENTATION AND PREFORMANCE .....	2208
<i>Rashkovits, Sarit<sup>1</sup>; Livne, Yael<sup>2</sup></i> .....	2208
WHO BENEFITS MORE FROM TRANSFORMATIONAL LEADERSHIP? THE CASE OF TEACHERS' BURNOUT UNDER NORMAL VERSUS EXTREME WORK DEMANDS .....	2211
<i>Rashkovits, Sarit<sup>1</sup>; Livne, Yael<sup>2</sup></i> .....	2211
ANTECEDENTS OF ORGANIZATIONAL FIELD REGULATORY CHANGE: LINKING INDIVIDUAL PROFILES OF SOCIAL ENTREPRENEURS WITH THEIR REGULATORY NEEDS AND PRIORITIES? .....	2214
<i>Rimac, Tomislav; Gurses, Kerem</i> .....	2214
LUXURY CONSUMER-BRAND RELATIONSHIPS – THE IMPORTANCE OF SELF IN BRAND LOVE .....	2217
<i>Rodrigues, Paula<sup>1</sup>; Rodrigues, Clarinda<sup>2</sup>; Brandão, Amélia<sup>3</sup>; Costa, Paula<sup>1</sup></i> .....	2217
CORPORATE GOVERNANCE INDEXES: A PRACTICAL APPLICATION ON ITALIAN SME'S..	2222
<i>Roffia, Paolo</i> .....	2222
FROM EMPLOYEE SATISFACTION TO CUSTOMER TRUST: A MODERATED MEDIATION MODEL IN THE ITALIAN CHAMBERS OF COMMERCE .....	2224
<i>Romanazzi, Salvatore<sup>1</sup>; Ambrosino, Gabriella<sup>2</sup></i> .....	2224

AN EXAMINATION OF RESIDENTS' SUPPORT FOR TOURISM DEVELOPMENT: A CASE STUDY IN THE CITY OF YOGYAKARTA .....	2229
<i>Roostika, Ratna</i> .....	2229
NETWORKING SMES FOR KNOWLEDGE SHARING: PRELIMINARY EVIDENCES FROM A SURVEY.....	2232
<i>Rossignoli, Francesca</i> .....	2232
KINDNESS, FRED VERSUS NIC: MACHIAVELLIAN LEADERSHIP IN THE 21 <sup>ST</sup> CENTURY.....	2236
<i>Rowland, Caroline<sup>1</sup>; Thomas, Mike<sup>2</sup></i> .....	2236
THE ADOPTION OF ACCRUAL ACCOUNTING IN THE PUBLIC SECTOR: A CASE WITHIN ITALIAN UNIVERSITIES .....	2239
<i>Rupo, Daniela<sup>1</sup>; Loprevite, Salvatore<sup>2</sup>; Sidoti, Salvatore<sup>1</sup></i> .....	2239
PERCEIVING DESTINATION QUALITY ON THE LEVEL OF THE ORGANIZATION/TOURISM SERVICE PROVIDER .....	2241
<i>Ryglova, Katerina<sup>1</sup>; Rasovska, Ida<sup>2</sup> Králíková, Andrea<sup>1</sup>, Stojarova, Sarka<sup>1</sup>; Sacha, Jakub<sup>3</sup></i> ; .....	2241
EXAMINING THE IMPACT OF EMPLOYEE SOCIAL MEDIA USAGE ON EMPLOYEE WORD OF MOUTH: THE ROLE OF BONDING SOCIAL TIES .....	2246
<i>Sakka, Georgia</i> .....	2246
HOW QUALITY OF LIFE INDICATORS CAN DEFINE CARE PROCESSES PERFORMANCE? ....	2249
<i>Salvatore, Fiorella Pia<sup>1</sup>; Crema, Maria<sup>2</sup>; Contò, Francesco<sup>1</sup>; Fiore, Mariantonietta<sup>1</sup></i> .....	2249
MORAL REASONING AND CORPORATE PLANNING.....	2253
<i>Santosuosso, Pierluigi</i> .....	2253
INTERNATIONALIZATION PROCESS OF FAMILY SMES: EVIDENCE FROM ITALY .....	2256
<i>Schiesari, Roberto; Bollani, Luigi; Battisti, Enrico</i> .....	2256
THE MORE THINGS CHANGE, THE MORE THEY STAY THE SAME .....	2258
<i>Schipani, Cindy<sup>1</sup>; Dworkin, Terry<sup>2</sup></i> .....	2258
WORKING IN VIRTUAL TEAMS: THE ROLE OF TEAM CONNECTEDNESS, KNOWLEDGE SHARING AND TEAM DIVERSITY.....	2261
<i>Schreiber, Ezolda; Van Dijk, Dina; Drory, Amos</i> .....	2261
DESTINATION MARKETING IN THE UNITED KINGDOM AND ORGANIZATIONAL AMBIDEXTERITY: EXPLOITATIVE DILEMMAS AND EXPLORATIVE PROSPECTS? .....	2267

<i>Scott, Peter<sup>1</sup>; Stokes, Peter<sup>2</sup>; Rowland, Caroline<sup>3</sup>; Gordon, David<sup>2</sup></i> .....	2267
EXPLORATORY TEST OF A NEW FOOTBALL CLUB AGGRESSION SCALE .....	2270
<i>Shuv-Ami, Avichai; Alon, Anat Toder</i> .....	2270
EXPLORATORY TEST OF A NEW SCALE FOR SPORT FANS SOCIAL AND PERSONAL IDENTITIES .....	2274
<i>Shuv-Ami, Avichai; Alon, Anat Toder</i> .....	2274
DISCLOSURE VIA SOCIAL MEDIA AND MARKET REACTION WITHIN THE STAKEHOLDER THEORY .....	2279
<i>Solimene, Silvia; Coluccia, Daniela; Fontana, Stefano</i> .....	2279
A GENERALISED PROPENSITY SCORE ANALYSIS TO INVESTIGATE INFLUENCE OF AGRICULTURAL RESEARCH SYSTEMS ON GHGS EMISSIONS .....	2287
<i>Spada, Alessia; Fiore, Mariantonietta; Contò, Francesco</i> .....	2287
SUBSIDIARY'S DUAL RELATIONAL EMBEDDEDNESS FOR THE MANAGEMENT OF KNOWLEDGE NETWORKS IN EUROPEAN MULTINATIONAL FIRMS .....	2290
<i>Tardivo, Giuseppe<sup>1</sup>; Ferraris, Alberto<sup>2</sup>; Bresciani, Stefano<sup>1</sup></i> .....	2290
THE CUSTOMER EXPERIENCE WITH SELF-SERVICE TECHNOLOGIES IN SERVICE ENCOUNTERS .....	2294
<i>Teixeira, Antonio Samuel<sup>1</sup>; Nobre, Helena<sup>2</sup>; Simões, Cláudia<sup>3</sup></i> .....	2294
EXPLORING INTERVAL-VALUED SCALES: A COMPARISON OF SCALE ATTRIBUTES BETWEEN INTERVAL VALUED AND SEMANTIC DIFFERENTIAL SCALES .....	2297
<i>Themistocleous, Christos<sup>1</sup>; Pagiaslis, Anastasios<sup>1</sup>; Smith, Andrew<sup>1</sup>; Cristian Wagner<sup>2</sup></i> .....	2297
MONTREAL'S MULTIMEDIA AND VIDEOGAME INDUSTRY: THE SOURCES OF ITS COMPETITIVENESS AND INNOVATION CAPACITY .....	2300
<i>Tremblay, Diane-Gabrielle</i> .....	2300
FARM BUSINESS RESOURCES, GOALS AND STRATEGIES: IMPLICATIONS FOR ACCELERATING THE CERTIFICATION .....	2303
<i>Tselempis, Dimitrios; Karipidis, Philippos; Pavlouidi Alexandra</i> .....	2303
THE EFFECTS OF CEO NARCISSISM AND CORPORATE BRAND REPUTATION ON FIRM PERFORMANCE .....	2305
<i>Turner, Karynne</i> .....	2305



CONSUMER MOTIVES IN TIMES OF ECONOMIC RECESSION: ADOPTION OF THE MEANS END THEORY.....	2308
<i>Tzimas Dionysios<sup>1</sup>, Karipidis Philippos<sup>2</sup>, Kontogeorgos Achilleas<sup>3</sup>.....</i>	<i>2308</i>
RECENT DEVELOPMENTS IN THE HYDROCARBON ENERGY MARKETS IN THE EASTERN MEDITERRANEAN .....	2310
<i>Vasilopoulou, Panagiota.....</i>	<i>2310</i>
JOB SATISFACTION IN THE HOSPITALITY INDUSTRY. A CASE STUDY FROM GREECE .....	2313
<i>Vasilopoulou, Panagiota.....</i>	<i>2313</i>
FEAR OF TERRORISM AND THE COSMOPOLITAN VALUE SYSTEM REFLECTED IN THE TOURISTS' PERCEPTION OF COUNTRY IMAGE AND TRAVEL DECISION .....	2316
<i>Vereb, Vanda<sup>1</sup>; Nobre, Helena<sup>2</sup>; Farhangmehr, Minoo<sup>1</sup>.....</i>	<i>2316</i>
CORPORATE GOVERNANCE, CORPORATE SOCIAL RESPONSIBILITY AND CORPORATE SOCIAL PERFORMANCE.....	2319
<i>Vinarski -Peretz Hedva .....</i>	<i>2319</i>
DETERMINANTS OF YOUTH'S TRUST IN THE RETAIL BANKING SECTOR IN TURBULENT TIMES .....	2322
<i>Viterbo, Marilia Ribeiro; Azevedo, António J. A. ....</i>	<i>2322</i>
THE IMPORTANCE OF SOUND IN THE GAMING AREA OF A CASINO .....	2325
<i>Wannenburg, Elizma; Drotsky, Tonie; De Jager, Johan.....</i>	<i>2325</i>
THE IMPACT OF THE SUBSIDIARY'S INTRAPRENEURIAL CAPACITY ON THE EVOLUTION OF MNC'S STRATEGIC ORIENTATION IN THE EURO-MEDITERRANEAN REGION .....	2328
<i>Yahiaoui, Dorra<sup>1</sup>; Chebbi, Hela<sup>2</sup>.....</i>	<i>2328</i>
AN EXAMINATION OF THE INFLUENCE OF ISLAMIC BRAND LOVE ON BRAND LOYALTY, WORD OF MOUTH AND PURCHASE INTENTION: AN EMPIRICAL STUDY IN SAUDI ARABIA .....	2334
<i>Yousef, Waleed; Melewar, T.C.;Dennis, Charles; Foroudi, Pantea .....</i>	<i>2334</i>
STYLES OF GOVERNANCE AND COMPANY PERFORMANCE. NEW INTERDISCIPLINARY MODEL APPLIED TO BEST PERFORMING AUTOMOTIVE INDUSTRY GIANTS .....	2336
<i>Zanda, Stefania .....</i>	<i>2336</i>
ECONOMIC AND SOCIAL COMMUNICATION NETWORKS: STRUCTURAL COMPARISON ..	2337

*Zvereva, Olga M.; Kondratyev, Andrey; Zverev, Fedor* ..... 2337

# **BOOK OF CONFERENCE PROCEEDINGS**

# A SUGGESTED NEW METHOD OF INNOVATION: INTRODUCING THE INTEGRATED QUALITY FUNCTION DEPLOYMENT FOR PRODUCTS & SERVICES

**Abu-Assab, Samah**

Dept. of Business Administration and Marketing, Birzeit University, BZU, Ramallah, Palestine

## **ABSTRACT**

The main purpose of the paper is to present a new method of innovation to help organizations to become more competitive in their markets by better capturing the voice of customers and better implementing it to create new products or improve existing ones. The new method is called integrated QFD which is an integration between the quality function deployment method and the compositional preference measurement method of conjuncture compensated self-explicated method. The paper explains each method and the way they are combined and used.

The method is first introduced in Abu-Assab (2012) under the category of research methods for the particular group of elderly people, and here it is extended to be used as a tool for innovation and to suit consumers in general. The method is a modification of previous methods from Pullman et al. (2002) and from Baier (1998).

*Keywords: Quality function deployment, innovation, Self-explicated method, House of quality, Integrated QFD, Conjuncture-compensatory self-explicated method, competitiveness, preference measurement, voice of customers.*

## **INTRODUCTION**

The economy of the 21st century is based mainly on information, knowledge and innovation. Lots of competitors and similar products which makes no choice for the companies but to invest in their employees and always seek to be innovative and differentiable.

For example, it is emphasized that in order for organizations to have competitive advantage, they have to effective management for today and simultaneously working on future innovation.

So to innovate, organizations need tools and methods to implement to stay ahead in their domain. In this article, the author suggested a method of innovation for organizations to help them create new products or/and improve on the existing products they have.

The suggested method “Integrated QFD” is based on the integration of the conjuncture-compensatory self-explicated CC-SE method into the quality function deployment (QFD) (see Abu-Assab, 2012). In the coming sections, the two methods are explained and then the suggested method is presented.

## **QUALITY FUNCTION DEPLOYMENT (QFD)**

For the suggested new innovation method, the quality function deployment is the main method used, therefore, the method will be described in this section to help readers in understanding it. The method was first suggested by the author for complex products to help organizations capture the needs of the elderly people in particular, and thus enhance the organizations in producing more adequate products that fits to the real demand of elderly people. The method was first introduced in 2012 as a market research method for organizations and in order to improve their ability to capture the voice of their elderly customers. In this research, the author introduce the method as an innovation method to help companies become more competitive and customer oriented, in general.

### *Introduction and Definition*

QFD focuses on the voice of the customer (VOC) and translates it into engineering quality or engineering characteristics. QFD is shaped from the combination, integration, and development of many concepts, starting with the quality assurance items (Oshiumi, 1966), the quality deployment (Akao 1972) and continuing with the quality chart (Takayanagi, 1972), value engineering which defines a function of a product, to the narrowly defined QFD, and to the quality charts (Akao and Mazur, 2003).

Quality function Deployment is the translation of the Japanese words “hinshitsu kino tenkai”. In its literal sense, it means deploying the attributes/features of a product/service accepted by customers throughout the relevant department of a company (Akao and Mazur, 2003)

One of the key definitions of QFD by Akao (1990) “A method for developing a design quality aimed at satisfying the consumer and then translating the consumer’s demand into design targets and major quality assurance points to be used throughout the production phase.”(also refer to Abu-Assab, 2012; see also Abu-Assab, 2011; Abu-Assab et al., 2010).

QFD enables the companies to focus on the customer and brings better communication between different departments in the company to achieve the optimum customer satisfaction. Additionally, it enables the companies to make the necessary trade-offs between the customer requirements and their abilities and capacities to produce the optimum product (Bouchereau and Rowlands, 2000). As a result, the organization can increase its competitiveness abilities.

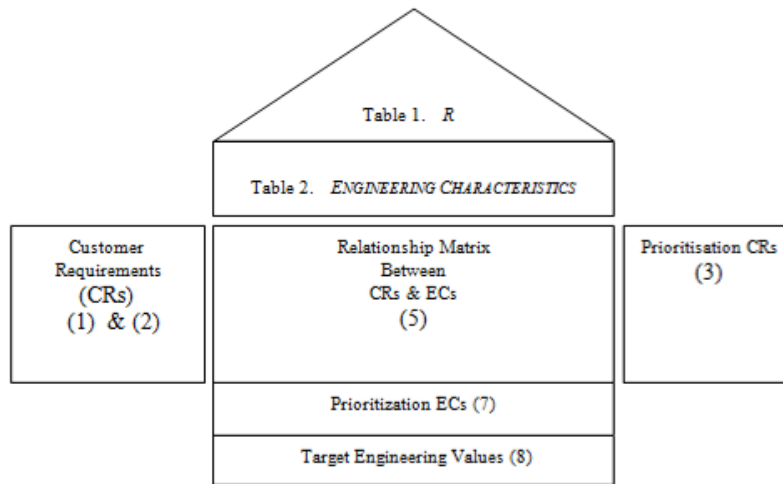

Figure 1: HoQ (Source Abu-Assab, 2012; see also Abu-Assab and Baier, 2010)

### *The House of Quality*

According to Akao (1997), the House of Quality (HoQ) was given this name because of its “triangular top shape” which looks like a roof (Akao and Mazur, 2003). The main purpose of the HoQ is to transform the “Customer Requirements” (CRs) into “Engineering Characteristics” (ECs) and assign target values for the product (van de Poel, 2007). Clausing (1994) described the HoQ as a matrix that provides a conceptual map for the product design process. In this sense, it is a construct for gathering and understanding the CRs as well as finding and prioritizing the

ECs. The cooperation among the marketing, the engineering, and the manufacturing departments of a company is necessary for building the HoQ. This cooperation leads to a greater new or improved product success and more profits for the company (Griffin and Hauser, 1993).

The main steps of the house of quality are according to Griffin and Hauser (1993), (1) Collecting the CRs, (2) rating the importances of the CRs, (3) the customer rating of competitive products, (4) determining the ECs, (5) rating of the relationship matrix, (6) rating of the correlation matrix, (7) calculating the importances/priorities of the ECs, and (8) determining the target engineering as seen in Figure 1.

### *Values for ECs.*

Step 1 in the HoQ begins with the collection of the CRs. CRs are listed in the left side of the matrix (see Figure 1). Those CRs are the description of customers’ needs, wishes, and expectations in their own words (refer to Terninko 1997). Typically, the customer needs are also called “customer attributes” and “customer requirements” and they are usually structured in a hierarchy of primary, secondary, and tertiary demands. CRs are usually gathered in focus groups, face-to-face interviews, customer surveys and trials (Saatweber 2007), analyzing competitors, and listening to customers. However, a major

problem related to the CR issue is the correct translation of the words and inferences of customers by the cross-functional expert team (Hauser and Clausing 1988)

In step 2, rating the importance of the CRs, the expert team members rate the CRs based on their direct experience or, e.g., through questionnaires. This step is very critical in the HoQ, because of the various interpretation or calculations of the importance of the CRs which can lead to different results. Many methods are used in the literature to rate the CRs: some researchers use statistical techniques while others use revealed preference techniques. In the former technique, the customers state their preferences for existing and hypothetical products whereas for the latter, customers are judged by both their actions and their words (Cohen, 1995).

Further in step 3, competitive products are rated by customers. In order for companies to match or exceed their competitors, they have to know where they stand in relation to them first (Hauser and Clausing, 1988). The part dealing with benchmarking is located on the right side of the CRs which gathered the customers' evaluations and assessments of the "company's product" and the "competitors' products". This step helps the company identify areas of strengths and weaknesses. It should be seen as an essential step for the company to improve itself against its competitors.

In step 4, determining the engineering characteristics, an interdisciplinary expert team from various departments of the company is formed, usually from the marketing, sales, R&D, engineering, and production departments, to translate the VOC into ECs. It should be noted that any EC may affect more than one CR. Another important issue is that it is expected that the ECs describe the CRs in measurable terms and thus affect the customer perceptions (refer to Hauser and Clausing, 1988; Abu-Assab, 2012).

Afterwards, in step 5, rating the relationship matrix, the interactions or dependences between CRs and ECs are estimated by the cross-functional expert team. According to Franceschini and Rossetto (1995) a consensus is required here. Symbols or measuring systems are often used to rate the strength of the relationship between the CRs and ECs. The two most known measuring systems used in this step are the 1-3-9 and the 1-3-5 ordinal scales (for a description of scales refer to Franceschini and Rossetto, 1995).

Subsequently, in step 6, rating the correlation matrix (roof of the house), the dependency within the ECs is assessed. The expert team assesses the effect of each EC on the other ECs (refer to Saatweber, 2007). Sometimes, the expert team has to take the right decisions between possible conflicts within ECs. This happens when the increase of an EC affects at least one other EC negatively. This results in a conflict concerning the product's design. Objective measures and comparisons (e.g. with the competitors) as well as cost-benefit comparisons help engineers, marketers, and managers of the expert team to decide about the correlations of the ECs process.

In step 7, the importance of the ECs and relative importance of ECs are calculated according to the equations shown in Table 1.

Absolute importance of EC	Relative importance of EC
$AI_j = \sum_{i=1}^m w_i * f_{ij}$	$RI_j = AI_j / \sum_{k=1}^n AI_k$
$AI_j$ Absolute importance of $EC_j$ ( $j=1, \dots, n$ )	$RI_j$ Relative importance of $EC_j$
$w_i$ Relative importance of $CR_i$ ( $i=1, \dots, m$ )	$AI_j$ Absolute importance of $EC_j$
$f_{ij}$ Relationship coefficient between $EC_j$ and $CR_i$	

Table 1: The absolute and relative importance of ECs in the HoQ (adapted from Kim et al. 2003; see also Abu-Assab, 2012).

Mathematically expressed, in the relationship matrix (Table 1) a cell (i, j), where the i<sup>th</sup> defines the row and the j<sup>th</sup> defines a column is, given a value according to the scale used corresponding to the strength of the relationship between the  $CR_i$  and  $EC_j$  which is called the relationship coefficient and designates a weak, medium, or strong relationship  $f_{ij}$ .

In the last step, step 8, to determine the target values for the ECs, it is essential for the multi-disciplinary team to consider the customer satisfaction values and to be careful not to emphasize tolerances (Hauser and Clausing, 1988). The setting of target EC levels is accomplished in a subjective, ad hoc manner, e.g., by expert team consensus (Kim et al., 2003).

The house is as a common place for the various functional teams of a company, which enables them to communicate together and understand the priorities and goals of one another (Hauser and Clausing, 1988). In short, The house of quality aggregates a lot of information in one table.

In the next section, the second used method in the new suggested method is introduced namely the self-explicated method.

## METHOD OF PREFERENCE MEASUREMENT: THE SELF-EXPLICATED METHOD

In this section, the self-explicated method is introduced. The self-explicated method is a known method of preference measurement together with the conjoint analysis method.

### *Definition of The Self-Explicated Method*

The compositional *self-explicated* (SE) method is one of the three main approaches used in marketing to measure the preference structures of respondents (Green and Srinivasan, 1990). Its main underlying



idea is to ask respondents directly about their preferences of a product and is based on an additive model (Hensel-Börner, 2000).

#### *Two-Stage Self-Explicated Method*

*The two-stage SE method consists of a conjunctive and a compensatory stage (Srinivasan 1988; Green et al. 1988). The SE method is differently implemented by various researchers (Green and Srinivasan, 1990). In this section, the conjunctive-compensatory SE approach suggested by Srinivasan (1988) is described and adapted in this research.*

Srinivasan (1988) suggested an SE approach called “Conjunctive-Compensatory SE” (CC-SE) that incorporates conjunctive and compensatory stages. The idea in the conjunctive stage is to ask respondents to identify one or two (if any) “totally unacceptable levels” of each attribute. And idea in the compensatory stage is to rate the attributes and levels on a 0-100 or 0-10 scale with the least preferred yet acceptable level assigned 0 and the most preferred level assigned 100 or 10, respectively (Bucklin and Srinivasan, 1991). In doing so, the respondents are explicitly asked to rate the attributes and their levels to elicit the part-worths of the levels and subsequently to obtain the overall utility for the choice alternatives based on the multi-attribute preference model, in which a product is considered as a bundle of attributes (Wilkie and Pessemier, 1973). The model is shown in Table 1 (see Baier and Brusch, 2009a):

$$y_j = \mu + \sum_{k=1}^K \sum_{l=1}^{L_j} \beta_{kl} \cdot x_{jkl}$$

Such that:

$y_j$  = overall utility of alternative j

$\mu$  = average preference value of all alternative

$\beta_{kl}$  = utility of level l of attribute k

$x_{jkl}$  = 1 When the level l of attribute k in the choice alternative  
=0 otherwise

*Table 2: Model of (adapted from Kim et al. 2003; see also Abu-Assab, 2012).*

This formula represents an additive utility model originating from the compositional model identified by Wilkie and Pessemier (1973) based on the main assumption that the total utility value of an attribute is the sum of the utility value of each of its levels (Hensel-Börner, 2000). Figure 2 presents the main steps of the procedure of the CC-SE method (Srinivasan, 1988).

Two concepts should be explained to understand the steps of the SE method. In step 1, the respondents should understand that when a product has a “totally unacceptable” level that means that this product

will be rejected regardless of the other levels. Moreover, in step 3, a critical attribute is the most valuable attribute to the respondent, which is used as an anchor to estimate the importance ratings of the other attributes (see discussion in Srinivasan, 1988).

The main step of the SE methods are:

1. Inform respondents about all attributes and their levels and identify “*totally unacceptable*” levels
2. Determine the “most preferred” and the “least preferred” level for each attribute, excluding the “*totally unacceptable*” levels
3. Identify the “*critical attribute*” and set its importance to 100 and elicit the importance ratings (0-100) for other attributes using the critical attribute as an anchor
4. Rate the *desirability ratings* of the different acceptable levels within the attribute and for each attribute on the scale with the least preferred (but acceptable level) = 0 and most preferred level = 100
5. Calculate the part-worths for acceptable attribute levels
6. Set the part-worths to fall in the range from 0-100 (To make the part-worths more comparable and readable)

Additionally, in step 5, the part-worths of the levels are calculated as follows (Dorsch and Teas,1992):

$$PW_{kl} = \frac{\alpha_{kl}x_{kl}}{100}$$

Such that:

$PW_{kl}$  Part-worth of level l of attribute k

$\alpha_{kl}$  = Self-explicated desirability rating of level l of attribute k

$x_{kl}$  = Self-explicated importance rating of attribute k

The new suggested method is introduced in the coming section.

#### *A New suggested Method of Innovation: Integrated QFD*

In this section, the new suggested method of innovation “Integrated QFD” is introduced and explained. This new method was already suggested by the researcher in her work (Abu-Assab, 2012). However, the method was suggested as a new research method for complex products and particularly for elderly people. In this work, the researcher reintroduce the method as a method of innovation and for customers of all ages. The method serves like any other innovation method in enhancing the ability of the organizations to create and produce new products that particularly comply with the customers’ needs and demands from the very first stage of idea creation.

The new method is a modification of the Pullman's et al. (2002) method and Baier's conjointQFD method (Baier, 1998). The two methods are described in details in the previous work of Abu-Assab (2012).

The new method is a combination of the two previously introduced methods in this paper: The two-stages conjuncture-compensatory self-explicated (CC-SE) method proposed by Srinivasan (1988) is suggested to be used to the QFD house of Quality mainly to make the method easier and lower the cognitive burden on respondents in comparison to the other combined methods.

The use of CC-SE method conforms to the consumer behaviour research that empirically recognises the heterogeneity in the choice process across individuals (see Srinivasan, 1988). The approach models the customer choices in two stages: conjunctive and compensatory. Individuals can purely choose in a conjunctive way in which they eliminate all the levels that are totally unacceptable, thus excluding them from further processing or they choose to different degrees in a compensatory way in which they trades off the remaining levels and attributes; Against this background, the author assumes that the CC-SE method would be more suitable to elicit the preferences of the customers of all ages as well as elderly especially for products with many attributes.

The major three phases conducted in the integrated QFD innovative method are:

#### *Selection and Evaluation of CRs*

The respondents (customers) and the expert team is built from experts including a number of customers who are considered expert in the selected product of study. In this phase, first the CRs are identified by conducting face-to-face interviews with customers (e.g. 17-20 face-to-face interviews can be a sufficient number to collect the CRs according to Griffin and Hauser 1993). The identification process of the CRs is conducted in the same way as described by Pullman's conjointQFD. That is to say, three members of the expert team separately identify primary and secondary CRs and then conclude their work with a final list of primary and secondary CRs (see Pullman et al., 2002). Then a number of respondents are asked to evaluate the primary and secondary CRs by a one-phase SE method in which the respondents are directly asked to rate their preferences of the CRs on a 1-10 Likert scale. The CRs are then rescaled so that the sum of secondary needs is equal to their corresponding primary CR in the same manner as done in Pullman et al.'s (2002). Additionally, a check is done to make sure that the importance or preferences of CRs ranking correspond to the evaluation given by respondents, otherwise they are then corrected according to their evaluation. Afterwards, respondents are asked to evaluate a number of competitive products of the selected product on a 1-10 Likert scale for the benchmarking part in the HoQ.

#### *Selection and Assessment of ECs*

In this phase, the expert team determine for each CR one or more ECs. Then for each ECs, two or three levels are assigned “convenient option”, “inconvenient option”, and “between option”. Additionally, the influences of ECs on each CR are determined as in the traditional HoQ. Afterwards, the relationship matrix is evaluated using the CC-SE method. For each CR, which is assigned more than one EC, a CC-SE questionnaire is made. The questionnaire is done by elderly respondents. By using the CC-SE method the relationship matrix is quantitatively assessed thus overcoming this problematic issue of the HoQ.

#### *Estimation of the Importance of the ECs*

From the CC-SE method, three HoQ can be constructed, namely a HoQ for (1) the conjuncture stage on the aggregated level, (2) the compensatory stage on the aggregated level, (3) the compensatory stage on the individual level

For the aggregated level, the importance of the ECs are calculated in the conventional way, each EC importance is calculated by summing its influences over the CRs multiplied by the weight of each corresponding CR. On the individual level, the importance of the ECs are calculated for each respondent in the conventional way and then the average of the importance of ECs are presented in the HoQ for of all respondents is presented in the HoQ on the individual level.

An additional CC-SE interview is conducted to test the validity in which all the ECs are included in the interview to investigate the respondents’ preferences for the ECs. The “within approach” convergent validity is calculated on each of the three results.

The new method was implemented on the product of smart homes for the target group elderly people and was proven valid (refer to Abu-Assab, 2012; see also Abu-Assab and Szuppa, 2005).

In this paper, the concept is introduced of the new innovation method. Further, the author will be using this method on different industries and different target groups of customers.

## **CONCLUSION**

In this conceptual paper, a new innovation method was suggested for new and improved product development for different types of customers which is based on the new research method that was suggested in Abu-Assab (2012). The method was implemented on the smart home product and proved to give good results. Here, the author extends the use of method on products and different categories of customers.

The method should positively contribute to the field of new product development and/or improved products which in return should promote the competitiveness of the organizations and its capabilities to innovate successful products wanted and needed by buyers.

In further research, the author will be implementing the method on different products from different industries and for various targeted groups to test the method.

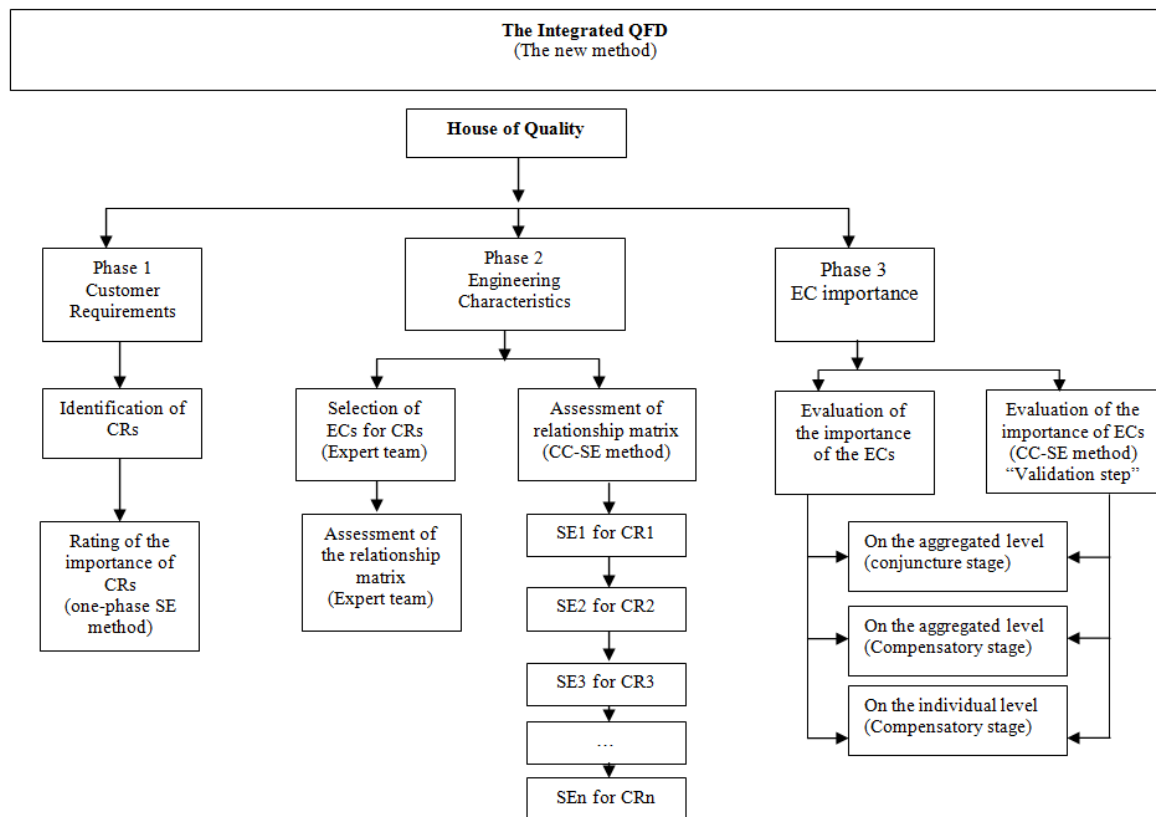

## REFERENCES

- Abu-Assab, S. (2012), Integration of Preference Analysis Methods into QFD for Elderly People, in Gabler-Springer, 2012.
- Abu-Assab, S. (2011), The Future Market: Needs and Perception of Elderly People in a Technological Market, in: Baier, D.; Gaul, W.; Rese, A., et al. (Eds.): The Entrepreneurship - Innovation - Marketing - Interface, Proceedings of the 3rd Symposium in Cottbus, Swiridoff, Künzelsau, 267-280.
- Abu-Assab, S.; Baier, D. (2010), Designing Products Using Quality Function Deployment and Conjoint Analysis: A Comparison in a Market for Elderly People, in: Studies in Classification, Data Analysis, and Knowledge Organization, 38, 515-526.
- Abu-Assab, S.; Baier, D.; Kühne, M. (2010), Preference Analysis and Product Design in Markets for Elderly People: A Comparison of Methods and Approaches, in: Studies in Classification, Data Analysis, and Knowledge Organization, 40, 709-718.
- Abu-Assab, S.; Szuppa, S. (2005), Marktforschung für das "Intelligente Haus". Eine Online-Befragung der Bussysteme-Leser, in: Bussysteme, 12(103), 151-156.
- Akao, Y. (1972), New Product Development and Quality Assurance – Quality Deployment System, in: Standardization and Quality Control, 25(4), 7-14. (In Japanese)
- Akao, Y. (1990): History of Quality Function Deployment in Japan, in: International Academy for Quality (Eds.): The Best on Quality, IAQ Book Series, 3, 183-196.
- Akao, Y.; Mazur, G. H. (2003), The Leading Edge in QFD: Past, Present and Future, in: International Journal of Quality & Reliability Management, 20(1), 20-35.
- Baier, D. (1998), Conjointanalytische Lösungsansätze zur Parametrisierung des House of Quality, in: QFD: Produkte und Dienstleistungen marktgerecht gestalten, VDI-Berichte, 1413, VDI-Verlag, Düsseldorf, 73-88.
- Baier, D.; Bruschi, M. (2009), Erfassung von Kundenpräferenzen für Produkte und Dienstleistungen, in: Baier, D.; Bruschi, M. (Eds.): Conjointanalyse: Methoden, Anwendungen, Praxisbeispiele, Springer, Heidelberg, 3-18.

- Bouchereau, V.; Rowlands, H. (2000), Methods and Techniques to Help Quality Function Deployment (QFD), in: *Benchmarking: An International Journal*, 7(1), 8-20.
- Bucklin, R. E.; Srinivasan, V. (1991), Determining Inter brand Substitutability Through Survey Measurement of Consumer Preference Structures, in: *Journal of Marketing Research*, 28(1), 58-71.
- Clausing, D. (1994), *Total Quality Development: A Step-by-Step Guide to World Class Concurrent Engineering*, ASME Press, New York.
- Cohen, L. (1995), *Quality Function Deployment: How to Make QFD Work for You*, Addison Wesley, Reading, Massachusetts.
- Dorsch, M. J.; Teas, R. K. (1992), A Test of the Convergent Validity of Self-Explicated and Decompositional Conjoint Measurement, in: *Journal of the Academy of Marketing Science*, 20(1), 37-48.
- Franceschini, F.; Rossetto, S. (1995), QFD: The Problem of Comparing Technical / Engineering Design Requirements, in: *Research in Engineering Design*, 7(4), 270-278.
- Green, P. E.; Srinivasan, V. (1990), Conjoint Analysis in Marketing: New Developments with Implications for Research and Practice, in: *The Journal of Marketing*, 54(4), 3-19.
- Griffin, A.; Hauser, J. R. (1993), The Voice of Customer, in: *Marketing Science*, 12(1), 1-27.
- Hauser, J. R.; Clausing, D. (1988), The House of Quality, in: *Harvard Business Review*, 3(May/June), 63-73.
- Hensel-Börner, S. (2000), Validität computergestützter hybrider Conjoint-Analysen, Gabler, Wiesbaden.
- Kim, K. J.; Cho, H.-W.; Jeong, I.; Lim, I. G. (2003), A Synopsis of Recent Methodological Enhancements on Quality Function Deployment, in: *International Journal of Industrial Engineering*, 10(4), 462-466.
- Oshiumi, K. (1966), Perfecting Quality Assurance System in Plants, in: *Quality Control*, 17(May), 62-67 (supp.). (In Japanese)
- Pullman, M. E.; Moore, W. L.; Wardell, D. G. (2002), A Comparison of Quality Function Deployment and Conjoint Analysis in New Product Design, in: *Journal of Product Innovation Management*, 19(5), 354-364.
- Saatweber, J. (2007), Kundenorientierung durch Quality Funktion Deployment: Systematisches Entwickeln von Produkten und Dienstleistungen, Symposium, Düsseldorf.
- Srinivasan, V. (1988), A Conjunctive-Compensatory Approach to Self-Explication of Multiattributed Preferences, in: *Decision Sciences*, 19(2), 295-305.
- Takayanagi, A. (1972), Quality Control in Production-to-Order at our Company (1): Quality Control Activities for Made-to-Order Products – Re: Concept of a Quality Chart, in: *Quality Control*, 23(Special Issue), 63-67. (In Japanese)
- Terninko, J. (1997): *Step-by-Step QFD: Customer-Driven Product Design*, 2nd Ed., St. Lucie Press, Boca Raton, Florida.
- van de Poel, I. (2007), Methodological Problems in QFD and Directions for Future Development, in: *Research in Engineering Design*, 18(1), 21-36.
- Wilkie, W. L.; Pessemier, E. A. (1973), Issues in Marketing's Use of Multi-Attribute Attitude Models, in: *Journal of Marketing Research*, 10(4), 428-441.

## PERCEIVED VALUE OF BRANDS: THE EFFECTS OF BRAND ATTRACTIVENESS AND BRAND TRUSTWORTHINESS

Akturan, Ulun

Department of Business Administration, Galatasaray University, Istanbul, Turkey

### ABSTRACT

The aim of this study is to explore the relationship among brand attractiveness, brand trustworthiness, and perceived value. Data were collected from 458 respondents via face-to-face interview. And the hypothesis tested via Structural Equation Modeling (SEM). As a result, it was found that brand attractiveness affects all four of the perceived value dimensions, and trustworthiness affects only three of them-functional, emotional and monetary value- but it has no influence on the social value.

*Keywords: Brand attractiveness, brand trustworthiness, perceived value, SEM*

### INTRODUCTION

Business is about creating value. In today's business environment, companies are focusing on creating and delivering superior value to customers in order to drive their satisfaction, loyalty, and profitability (Kumar and Reinartz, 2016). The value perception of consumers is a key element in marketing (Morar, 2013), and the marketing literature extensively investigates the perceived value (Sánchez-Fernández and Iniesta-Bonillo, 2007).

Previous research conceptualized value as a trade-off between "get" and "give" elements (Kumar and Reinartz, 2016; Zeithaml, 1988). In other words, consumers' value assessment is based on perceived attributes and costs. Perceived attributes are benefits that the consumers can get by having those brands, and costs may be monetary- such as price-, or nonmonetary- such as time, effort, and perceived risks. The extant literature defines "*perceived quality*" as the main benefit, and "*price*" as the main cost, on that ground, perceived value is interpreted as "value-for-money" (Sweeney and Soutar, 2001). However, defining value as *value-for-money* is a uni-dimensional approach and there were attempts to redefine value as a multi-dimensional concept (Sheth et al. 1991; Sweeney and Soutar, 2001).

But, what affects the value perception of consumers? One of the main indicators is perceived quality- since it is a base for "get" elements- it affects value positively (Sweeney, 1997). In addition to quality perceived risk also has an impact on consumers evaluations, because it represents a cost as a sacrifice

(Sweeney et al. 1999). Price also found as influencing the perception of value inversely (Doods and Monroe, 1985). Moreover, several extrinsic cues (i.e., price, brand name, and store name, country-of-origin) also stated as affecting value perception (Teas and Agarwal, 2000). This relationship between extrinsic cues and perceived value is mediated by perceived quality and sacrifice.

Other than that, while extant literature enhances the understanding of the components of perceived value, there is no research, to the best of the knowledge of the author, which investigates the effects of brand attractiveness and brand trustworthiness on perceived value as a ground for cognitive-affective approach. Therefore, taking into consideration the lack of research on that issue, this study aims to analyze the relationship among brand attractiveness, brand trustworthiness and perceived value in an emerging country settlement.

#### *Perceived value*

Creating and delivering value is a crucial factor for companies to succeed. It is also main activity of marketing, since the marketing is defined as “the activity, set of institutions, and processes for creating, communicating, delivering, and exchanging offerings that have value for customers, clients, partners, and society at large” (AMA, 2013).

There are mainly two approaches to conceptualize perceived value, *uni-dimensional approach* and *multi-dimensional approach* (Sánchez-Fernández and Iniesta-Bonillo, 2007). From a uni-dimensional point of view, perceived value is conceptualized as a single overall concept that can be measured on the basis of quality-price relationship. One of the earliest attempts to conceptualize perceived value defines it as a function of acquisition utility and transaction utility (Thaler, 1985). Acquisition utility “is based primarily on non-monetary costs involved in a purchase and encompasses the subjective benefits derived from a purchase” (Jayanti and Ghosh, 1996, p. 8). However, transaction utility depends on the “perceived merits of the deal” (Thaler, 1985, p. 205). In this model, Thaler (1985) replaced the utility function in economics with the value function in prospect theory (Monroe and Chapman, 1987). However, it is not that simple to measure value perception (Zeithaml, 1988). First, value perception is subjective and has different meanings for consumers. Second, consumers do not carefully calculate the give and get components as opposed to the assumptions of utility models. On that ground perceived value is “the consumer’s overall assessment of the utility of a product based on perceptions of what is received and what is given” (Zeithaml, 1988 p. 14). Monroe and Chapman (1987) conceptualized perceived value as a function of perceived quality constituting the numerator while the price as a sacrifice constituting the denominator ( $PV = PQ/P$ ).

From a multi-dimensional point of view, perceived value has an affective dimension as well as a functional dimension (Morar, 2013). Holbrook (1994) developed a complementary view on value and postulated that consumption experiences most likely involve more than one type of value



simultaneously. Because people do not desire products but they want to satisfy experiences, then customer value simply is an “interactive relativistic preference experience” Holbrook (1994 p.27). In other words, customer value involves an interaction between an object (e.g., a product) and a subject (e.g., a consumer). “This object–subject interaction is relativistic in at least three senses (comparative, personal, situational) –“first, involving a comparison among objects; second, varying from one person to another; and, third, depending on the situation in which the evaluation occurs” (Holbrook, 2006 p.715).

Sheth et al (1991) define multiple value dimensions for different choice and decision levels such as buy level, product level, and brand level. They suggested five value dimensions (social, emotional, functional, epistemic, and conditional) in relation to the perceived utility of those levels. Sweeney and Soutar (2001) developed a four-dimensional perceived value model (price/value for money, performance/utility, functional and emotional value).

(1) *Functional value (price/value for money)* is the utility derived from a product due to the reduction of its perceived short-term and longer-term costs (in this study, this dimension is called monetary value).

(2) *Functional value (performance/quality)* is the utility derived from the perceived quality and expected performance of a product.

(3) *Emotional value* is the utility derived from the feelings or effective states that a product generates.

(4) *Social value* is the utility derived from a product’s ability to enhance social self-concept.

In this research perceived value is defined as a multi-dimensional construct formed by functional value, monetary value, social value and emotional value.

#### *Brand Attractiveness*

Brand attractiveness is the “ extent to which a brand is attractive, favorable, and distinctive” (Sophonsiri and Polyorat, 2009 p.54). It is the sum of the positive evaluations of the brand’s associations and attributions (Elbedweihy et al. 2016). Brand attractiveness is important for brand success (Kim et al., 2001) since it affects market share positively (Gonzalez-Benito et al., 2008). Also, perceived brand attractiveness influence the relationship between consumers and brands. The quality of the relationship between consumers and brands appears to be dependent on the brand's perceived attractiveness (Hayes et al., 2006). On that ground, it has a direct, positive influence on consumer-company identification (Curra’s-Pe’ rez et al. 2009).

Consumers evaluate a product category on the basis of the factors that go beyond the brand level. Boyd and Mason (1999) name those factors as “*extrabrand attributes*” (EBAs), such as the number of

competing firms, firm reputation, the existence of uniform standards of technology, the availability of local product support and repair services, and the actual users. Those EBAs constitute the assessment of brand attractiveness, which turns into the focal point whether to adopt or not. Therefore, attractiveness has an important influence on consumer attitudes and intentions (Boyd and Mason 1999). Brand attractiveness is not merely a function of attributes, but when the brand associations match the consumer's sense of self, a brand is perceived as attractive (Bhattacharya and Sen, 2003). Moreover, value congruence is positively related to brand attractiveness (Elbedweihy et al. 2016). For example, a consumer who cares about animal rights will be drawn more to a brand that have respect for animal rights in their manufacturing and operation process (Bhattacharya and Sen, 2003). In addition, customer-to-customer similarity is positively related to brand attractiveness (Elbedweihy et al. 2016). In that sense, a brand is attractive when customers perceived other users to be similar to themselves.

Brand attractiveness is important in evaluating the attributes of a brand. It, even, uniforms an association related to the brand or the product category, and perceived value is the assessment of brand related attributes and costs, hereby it is hypothesized that:

H1: Brand attractiveness positively affects (a) functional value, (b) emotional value, (c) monetary value, and (d) social value.

#### *Brand Trustworthiness*

Brand trust is an important antecedent of brand loyalty (Chaudhuri and Holbrook, 2001; Delgado-Ballester and Munuera-Alema'n, 1999), and a leading indicator of brand equity (Ambler, 1997). The long-term relationship between consumers and brands is based on trust (Morgan and Hunt, 1994). The relationship between trust and volume sales is not a linear, symmetric relationship. Trust builds slowly with sales when consumers are fully satisfied, since it is an affective form of memory (Ambler, 1997).

Trust is possible only after a satisfactory degree of trustworthiness is achieved (Lee and Turban, 2001; McKnight et al., 2002b). Trustworthiness can be defined as beliefs of ability, integrity, and benevolence (Gefen 2002). In order trust to be developed, consumers determine if a business is trustworthy (McKnight et al., 2002). Trustworthiness and trust are not the same concept, but they are related as trustworthiness precedes trust (Serva et al., 1990). In other words, "trust is an act of a trustor, whereas trustworthiness is a characteristic of someone or something that is the object of trust" (Corritore et al. 2003 p. 741). Since trustworthiness leads to overall trust, which is assessed as a determinant of brand equity and perceived quality, it is hypothesized that;

H1: Brand trustworthiness positively affects (a) functional value, (b) emotional value, (c) monetary value, and (d) social value.

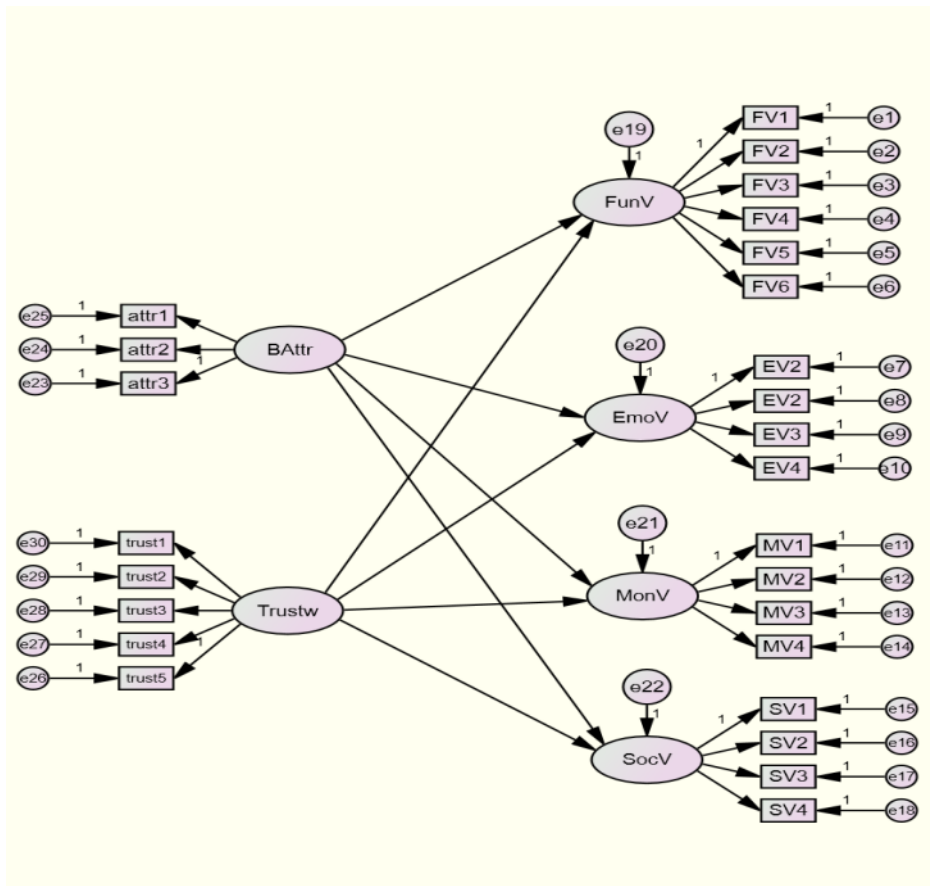

Figure- 1: Model of Hypothesized Relationships

## RESEARCH METHODOLOGY

### Measurement and Sampling

Data were collected via survey method from the university students. And the product category was chosen as sneakers, which is suitable with the sample. A total of 458 valid and complete responses were included in the final analysis. The socio-demographics of the sample is as follows: Gender (53.3 % female, 46.7 % male), Age group 21-23 (64,4 %), Income level: 1500 Euro (34.9 %). Because it is a student sample, sneakers were chosen as a subject to study.

In order to measure the variables, established scales were used. Perceived value was adopted from Sweeney and Soutar (2001), brand attractiveness was adopted from Wang and Yang (2010), and trustworthiness was adopted from Erdem and Swait (2004). Scales were translated and back-translated to ensure the consistency.

## RESEARCH FINDINGS

### *The Reliability Analysis*

Prior to test the hypothesis, the reliability of the scales was evaluated via Cronbach's Alpha coefficient and the exploratory factor analysis was run to check the validity. Table 1 summarizes the Cronbach's Alpha values and the explained variance of the constructs.

**Table 1: The Results of Validity and Reliability Analyses**

Constructs	# of items	Cronbach's Alpha	Variance Explained (%)
Brand attractiveness	3	.829	59,567
Brand Trustworthiness	5	.790	70,552
Functional value	6	.754	66,704
Emotional value	4	.893	75,727
Monetary value	4	.863	71,122
Social value	4	.883	74,137
Overall value	18		66,900

As given in Table 1, all the constructs are reliable, and explain at least 59.5 % of variance. Then, the research hypothesis tested via SEM.

### *Structural Model Testing*

The overall fit measures of the structural model indicate an adequate fit of the model to the data (Chi-square/df=3,382; CFI=.891; TLI=.877; IFI=.892; GFI=.861; RMSEA=.072). The results provide strong support for the conceptual model displayed in Figure 1, and Table 2 presents a summary of the hypotheses tests. As a result, all the hypotheses were supported except H2d, which is testing the relationship between trustworthiness and social value.

**Table 2: Regression Weights**

			Estimate	S.E.	C.R.	Sign.	Reg. Weights	Std.
Func.V.	<---	Br.Attr.	,341	,042	8,057	***	,467	H1a supported
Emo.V.	<---	Br.Attr.	,670	,064	10,465	***	,668	H1b supported
Mon.V.	<---	Br.Attr.	,338	,051	6,581	***	,375	H1c supported
Soc. V.	<---	Br.Attr.	,449	,061	7,321	***	,438	H1d supported
Func.V.	<---	trustw	,616	,060	10,238	***	,631	H2a supported
Emo.V.	<---	trustw	,532	,065	8,208	***	,397	H2b supported
Mon.V.	<---	trustw	,484	,066	7,300	***	,402	H2c supported
Soc. V.	<---	trustw	,093	,069	1,342	,180	,068	H2d not supported

**Functional value  $R^2 = .616$ , Emotional value  $R^2 = .603$ , Monetary value  $R^2 = .302$ , Social value  $R^2 = .196$**

$R^2$  values represent the explanatory power of the dependent variables and the overall adequacy of the model. It displays the explained percentage of endogenous latent construct by exogenous latent

variables (Sirohi *et al.*, 1998). For functional value  $R^2$  value is .616, for emotional value it is .603, for monetary value it is .302 and, for social value it is .196. Brand attractiveness and trustworthiness explains nearly 60% variance of functional and emotional value. However, their exploratory power is low for monetary value, and social value.

## CONCLUSION AND DISCUSSION

Extant marketing literature has investigated the concept of creating and delivering value to the customers. In order to drive satisfaction, loyalty and profitability, companies should focus on value creation (Kumar and Reinartz, 2016). This study seeks to find answers the affects of brand attractiveness and trustworthiness on perceived value.

Perceived value is the trade-off between the benefits that consumers expect or experience, and the undesired consequences (Gutman, 1982). The central aspect is that, consumers choose actions that, *ceteris paribus*, maximize the desired consequences and minimize concurrent undesired consequences (Kumar and Reinartz, 2016). Benefits are derived from the attributes of the offerings, while undesired consequences are the sacrifices or costs- either monetary or nonmonetary, such as price, time, effort and risk. Consumers are not able to perceive the entire objective attributes clearly (Kumar and Reinartz, 2016), but form a composite perception. Brand attractiveness and brand trustworthiness can also be assessed as brand attributes. Therefore, it was hypothesized that brand attractiveness and trustworthiness positively affects perceived value.

As a result, it was found that brand attractiveness affects all of the perceived value dimensions- functional, emotional, monetary and social value. And when the standardized regression coefficients checked, it is seen that brand attractiveness dominantly affects emotional value (.668). In addition to brand attractiveness, trustworthiness also affects three of the perceived value dimensions- functional value, emotional value, and monetary value, but it has no influence on social value. And trustworthiness has a major impact on functional value (.631).

The study contributes to the literature by defining the brand attractiveness and trustworthiness as determinants of perceived value. When consumers perceive the brand is elegant, beautiful and attractive, they perceive it is well made, has a consistent quality, offers value for money, give them pleasure, make them feel good, and help them to feel acceptable. Moreover, when they think that the brand delivers what it promises and has believable claims, they perceive the brand generates functional, emotional and monetary value.

As is the case with any research, the study has several limitations that may generate further research avenues. The findings may be limited to the sample and the brand investigated in this research. Because a student sample was used, the findings should be verified for other samples. Besides, one

product category and one brand were investigated in the study. Therefore, other product categories should be tested for generalizability.

## ACKNOWLEDGMENTS

The author thanks to Galatasaray University Scientific Research Projects Commission for the support provided (Research Project No. 17.102.001).

## REFERENCES

- Ambler, T. (1997), "How much of brand equity is explained by trust?", *Management Decision*, Vol.35, No.4, pp. 283-292.
- Bhattacharya, C. B., and Sen, S. (2003), "Consumer-company identification: A framework for understanding consumers' relationships with companies", *Journal of Marketing*, Vol.67, No.2, pp. 76-88.
- Boyd, T. C., and Mason, C. H. (1999), "The link between attractiveness of "extrabrand" attributes and the adoption of innovations", *Journal of the Academy of Marketing Science*, Vol.27, No.3, pp.306-319.
- Chaudhuri, A. and Holbrook, M.B. (2001), "The chain of effects from brand trust and brand affect to brand performance: the role of brand loyalty", *Journal of Marketing*, Vol. 65, April, pp. 81-93.
- Corritore, C. L., Kracher, B., & Wiedenbeck, S. (2003) "On-line trust: concepts, evolving themes, a model", *International Journal of Human-Computer Studies*, Vol.58, No.6, pp. 737-758.
- Currás-Pérez, R., Bigné-Alcañiz, E., and Alvarado-Herrera, A. (2009), "The role of self-definitional principles in consumer identification with a socially responsible company", *Journal of Business Ethics*, Vol. 89, No.4, pp. 547.
- Delgado-Ballester, E. and Munuera-Alema'n, J.L. (1999), "Brand trust in the context of consumer loyalty", *European Journal of Marketing*, Vol. 35 No. 11/12, pp. 1238-58
- Dodds, W. B., and Monroe, K. B. (1985), "The effect of brand and price information on subjective product evaluations", *NA-Advances in Consumer Research*, Vol.12, pp.85-90.
- Elbedweihy, A. M., Jayawardhena, C., Elsharnouby, M. H., and Elsharnouby, T. H. (2016), "Customer relationship building: The role of brand attractiveness and consumer-brand identification", *Journal of Business Research*, Vol.69, No.8, pp. 2901-2910.
- Erdem, T., and Swait, J. (2004), "Brand credibility, brand consideration, and choice", *Journal of Consumer Research*, Vol.21, No.1, pp. 191-198.
- Gefen, D. (2002), "Reflections on the dimensions of trust and trustworthiness among online consumers", *ACM Sigmis Database*, Vol.33, No.3, pp. 38-53.
- Gonzalez-Benito, O., Pilar Martínez-Ruiz, M., and Mollá-Descals, A. (2008), "Latent segmentation using store-level scanner data", *Journal of Product and Brand Management*, Vol.17, No.1, pp. 37-47.
- Gutman, J. (1982), "A means-end chain model based on consumer categorization processes", *The Journal of Marketing*, Vol.46, No.2, pp.60-72.
- Hayes, B. J., Alford, B. L., Silver, L., and York, R. P. (2006), "Looks matter in developing consumer-brand relationships", *Journal of Product and Brand Management*, Vol.15, No.5, pp. 306-315.
- Holbrook, M. B. (1994), "The nature of customer value: an axiology of services in the consumption experience," *Service quality: New directions in theory and practice*, Vol.21, No.1, pp. 21-71.
- Holbrook, M. B. (2006), "Consumption experience, customer value, and subjective personal introspection: An illustrative photographic essay", *Journal of Business Research*, Vol.59, No.6, pp. 714-725.
- Jayanti, R. K., and Ghosh, A. K. (1996), "Service value determination: An integrative perspective", *Journal of Hospitality & Leisure Marketing*, Vol.3, No.4, pp. 5-25.
- Kumar, V., and Reinartz, W. (2016), "Creating enduring customer value", *Journal of Marketing*, Vol.80, No.6, pp.36-68.
- Lee, M. K., & Turban, E. (2001), "A trust model for consumer internet shopping", *International Journal of Electronic Commerce*, Vol.6, No.1, pp. 75-91.
- McKnight, D. H., Choudhury, V., and Kacmar, C. (2002), "The impact of initial consumer trust on intentions to transact with a web site: A trust building model", *Journal of Strategic Information Systems*, Vol.11, No.3/4, pp. 297-323.

- Monroe, K. B., and Chapman, J. D. (1987), "Framing effects on buyers' subjective product evaluations", *NA-Advances in Consumer Research*, Vol.14, No.1, pp.193-197.
- Morar, D. D. (2013), "An overview of the consumer value literature—perceived value, desired value", *Marketing From Information to Decision*, Vol.6, No.1, pp. 169-186.
- Morgan, R. M., and Hunt, S. D. (1994), "The commitment-trust theory of relationship marketing", *The Journal of Marketing*, Vol.58, No.3, pp.20-38.
- Sánchez-Fernández, R., and Iniesta-Bonillo, M. Á. (2007), "The concept of perceived value: a systematic review of the research", *Marketing Theory*, Vol.7, No.4, pp. 427-451.
- Serva, M. A., Benamati, J., and Fuller, M.A. (2005), "Trustworthiness in B2C e-commerce: An examination of Alternative models", *Database for Advances in Information Systems*, Vol.36, No.3, pp. 89-108.
- Sheth, J. N., Newman, B. I., and Gross, B. L. (1991), "Why we buy what we buy: A theory of consumption values", *Journal of Business Research*, Vol.22, No.2, pp. 159-170.
- Sophonsiri, S., and Polyorat, K. (2009), "The impact of brand personality dimensions on brand association and brand attractiveness: the case study of KFC in Thailand", *Journal of Global Business and Technology*, Vol.5, No.2, pp. 51-62.
- Sweeney, J. C., Soutar, G. N., and Johnson, L. W. (1997), "Retail service quality and perceived value: A comparison of two models", *Journal of Retailing and Consumer Services*, Vol.4, No.1, pp. 39-48.
- Sweeney, J. C., Soutar, G. N., and Johnson, L. W. (1999), "The role of perceived risk in the quality-value relationship: a study in a retail environment", *Journal of Retailing*, Vol.75, No.1, pp. 77-105.
- Sweeney, J. C., and Soutar, G. N. (2001), "Consumer perceived value: The development of a multiple item scale", *Journal of Retailing*, Vol.77, No.2, pp. 203-220.
- Teas, R. K., and Agarwal, S. (2000), "The effects of extrinsic product cues on consumers' perceptions of quality, sacrifice, and value", *Journal of the Academy of Marketing Science*, Vol.28, No.2, pp. 278-290.
- Thaler, R. (1985), "Mental accounting and consumer choice", *Marketing Science*, Vol.4, No.3, pp. 199-214.
- Wang, X., and Yang, Z. (2010), "The effect of brand credibility on consumers' brand purchase intention in emerging economies: The moderating role of brand awareness and brand image", *Journal of Global Marketing*, Vol.23, No.3, pp. 177-188.
- Zeithaml, V. A. (1988), "Consumer perceptions of price, quality, and value: a means-end model and synthesis of evidence", *The Journal of Marketing*, Vol.52, No.3, pp. 2-22.

# ADVANCING THE PRIVATE HEALTHCARE MANAGEMENT SYSTEM IN LEBANON AND THE MIDDLE EAST - INTRODUCING NEW MEDICAL BENEFITS BY THIRD PARTY ADMINISTRATORS

Al Khoury, Wissam<sup>1</sup>; Bekhazi, Helene<sup>1</sup>; Al Khoury, Grace<sup>2</sup>

<sup>1</sup>GlobeMed Lebanon, MD, MBA, Beirut, Lebanon

<sup>2</sup>University of Nicosia, Nicosia, Cyprus

## ABSTRACT

The definition of healthcare in the Middle East has recently been changing in accordance with the international healthcare advancements by incorporating new medical benefits and assessing the cost-benefit of these added services. Most of those added services were used to be viewed as being too expensive to be covered, irrelevant to core medical practices or simply secondary medical services that can be ignored. Changes in approaches to health issues such as mental disorders and sexually transmitted diseases and in particular the decrease in the taboo surrounding HIV infection, infertility and obesity has allowed the Ministry of Public Health (MOPH) with the support of Third Party Administrators (TPA) to tackle those issues in the Middle East. TPAs have played a crucial role in this aspect by highlighting the fact that those mentioned medical conditions do not have a high financial burden and covering them would in fact greatly help patients in need. In order to elaborate this point, this paper will look at certain healthcare trends and medical benefits newly added by TPAs in the region.

*Keywords: Healthcare Management, Health Benefits, Middle East, Lebanon, Ministry of Public Health (MOPH), GlobeMed, Insurance Policies, National Social Security Fund (NSSF), Insurance Regulatory and Development Authority (IRDA)*

## INTRODUCTION

Large increases in health-care costs can make it difficult to balance a budget, but at the same time, health-care benefits are pivotal in maintaining an up-to-date healthcare level. Governments in the Middle East with the help of Third Party Administrators (TPAs) need to closely monitor health-care costs and choose approaches that make use of the jurisdictions, purchasing power, shared costs, and ultimately health promotion.

This paper will be based on analyzing the added benefits newly covered by a major Third Party Administrator in Lebanon and the Middle East - GlobeMed Lebanon (formerly known as MedNet Liban till September 2012).



Policies determine what is covered, what is excluded and what is subject to financial limitations.

Over the years, the policies have been revised several times in order to add new benefits as the healthcare needs arise. Major updates have been implemented in several medical fields ranging from congenital disorders, to infertility and organ transplantation. In fact, while all the healthcare industry is covering “sickness treatment”, some Third Party Administrators are shifting their interest to “sickness prevention”, promoting prevention and wellness-education and even extending the scope of coverage to encapsulate palliative care.

In this paper, we visit the newly added benefits and assess the impact they had on the beneficiaries especially since they were previously exclusions that were recently transferred to covered conditions or procedures.

As previously stated, the policy is constantly changing to accommodate emerging needs; many benefits were added to various programs, but we will limit our review to subjects that we consider resulted in major changes and healthcare impact.

The benefits that will be visited are listed below; these were added gradually as of year 2012.

1. Transplantation, added in May 2012
2. Psychiatric and mental disorders, added in May 2012
3. Infertility, added in May 2012
4. Pet scan and VCT 64, added in May 2012
5. Morbid Obesity Surgery, added in October 2014
6. HIV and other Sexually Transmitted Diseases, added in May 2015

Other added benefits of importance also include video capsule endoscopy, OCT (Optical coherence tomography), non-post-traumatic prosthesis, and many others.

The general aim of this paper is to augment the Lebanese Healthcare Management Association’s goals that revolve around assessing and advancing healthcare solutions through the widening of the scope of healthcare services that need to be covered by Third Party Administrators. These services would be proven in this paper to have bearable financial costs while at the same time immensely advancing the healthcare level in Lebanon and the Middle East.

The objectives of this paper would therefore be:

1. To shed light on several healthcare services that have been newly introduced into the general healthcare practices in the Middle East but which needed the support of private Third Party Administrators in order to include them in the applied policies.
2. To highlight the impact of covering HIV and other sexually transmitted diseases that were once thought to be completely out of the scope of health coverage schemes. The same applies to organ transplantation, psychiatric disorders, infertility, Pet-Scans and bariatric surgeries.

3. To delve into each of the six most significant healthcare services and elucidate the cost-benefit and advantages of including those services into the common mainstream healthcare system.
4. To present an example which can serve future healthcare assessment projects in being able to persuade healthcare Third Party Administrators to adopt and cover potential healthcare services.

## LITERATURE REVIEW

When trying to understand the different types of healthcare coverage programs and policies, it is important to know the definition of policy exclusions and restrictions which were the subject of criticism in several papers. By this token, healthcare plans should be assessed from different perspectives. Even though we are tackling the newly covered benefits in this paper, it is important to note that policy exclusions and restrictions are important as well. Exclusions arise when one is not covered at all for certain services. Restrictions however arise when one agrees to receive only limited benefits for certain services. This might have the benefit of paying a lower premium in return. In her paper, 'What Does That Mean? Understanding Health Insurance Coverage', Mila Araujo has defined what a lifetime maximum, out-of-pocket expenses and limitations on pre-existing conditions are. "A pre-existing condition is a medical condition that the insured had before the insurance policy began. Some plans will cover pre-existing conditions while others may completely exclude them. Pre-existing conditions may sometimes be subject to a waiting period before they are covered, other times they are excluded completely" (Araujo, 2016). This would constitute a win-win situation in certain instances when certain pre-existing conditions might not pose a health threat for the policy holders and excluding them might save those holders money by paying lower premiums and removing or lowering the financial limitation on other diseases that might otherwise pose a higher threat. Moreover, experimental and investigational therapies are still not covered by most coverage schemes in the Middle East because of the mere fact that they are still unproven therapies that might be detrimental to one's health. However, in several instances, rising premiums have been paired with increasing exclusions. This is the case with some healthcare coverage programs in Australia. "With insurance premiums rising faster than inflation ... policies are being stripped of cover deemed unnecessary, or laden with fees and charges that members pay only when treated. Former health official Shaun Gath is warning that this trend will force insurers to increase the price of entry-level products, potentially deterring customers. The Australian Competition and Consumer Commission (ACCC) has also raised concerns over the increasing number of policies, changes to benefits and the rise of exclusions, restrictions, excess and co-payments. 'This complexity makes it harder for consumers to understand and respond effectively when insurers change their benefits, and makes

consideration of reforms to improve benefit change notifications in this industry even more important,' the ACCC states in its latest report to the Senate" (Parnell, 2017).

When the civil war ended in 1992, the health sector in Lebanon faced several problems: the weakened Ministry of Public Health (MOPH), rapid cost escalation in health expenditure, particularly MOPH expenditures, unrestricted growth of the private sector and a weakened primary health care system. In response to these problems, the government adopted a health sector strategy in 1993. Important elements of this strategy included strengthening the role of the MOPH and containing the rapid growth in health expenditure. While the long-term objective of the health sector strategy is to improve the allocation and use of resources in the public and private sectors, the short-to-medium term objectives have focused on improving the managerial and administrative functions of the MOPH, including a comprehensive package of curative and preventive services at all primary health care facilities, strengthening of hospital management and implementing service delivery capability and alternative health financing options (Kronfol, 2006). Moreover, a recent endeavor in 2016 was the collaboration between the MOPH and three TPAs in Lebanon whereby those TPAs would be helping the MOPH in both managing and auditing health claims.

With the growth of private voluntary insurance in the unregulated healthcare market, costs of healthcare are likely to go up. Managed care organizations in many developed countries play important role in containing costs. The Insurance Regulatory and Development Authority (IRDA) has paved the way for insurance intermediaries such as third party administrators (TPAs) which are going to play a pivotal role in setting up managed care systems. TPAs have been set-up with the objective of ensuring better services to policyholders and mitigating some of the negative consequences of private health insurance. However, given the demand and supply side complexities of private health insurance and health care markets, insurance intermediaries face challenging tasks to achieve these objectives. Right in the early stages of its development, the IRDA has defined the role of TPAs to manage claims and reimbursements. Their role in controlling costs of health care and ensuring appropriate quality of care remains less defined. In order to mitigate the risks of working capital, insurance companies may be required to keep cash balances with TPAs to meet the reimbursement pressure (Bhat, 2004).

## **GAP(S)**

Mustafa Younis who is a member of the Executive Committee of the International Society for Research of Healthcare Financial Management states that an emergent issue in the Middle East is the long-term

policy to deal with access to healthcare and health for the growing aging population. In his speech to Laura Dormer, the commissioning editor of Future Medicine, he states that the government and other healthcare organizations are increasing their focus on preventive healthcare as a means of cost containment and outcomes improvement. They have used the media and other educational outreach to promote immunizations and other forms of prevention. However, they continue to face the major obstacles of low literacy rates and political instability in the region, which can limit the success of these efforts (Younis, 2013).

The Middle East is further challenged by high health care costs on a per capita basis, significant variation in the quality of care provided across sectors, and large gaps in services. Boston Consultancy Group was asked to assess and benchmark performance, develop recommendations, and create a roadmap for change and their recommendations included increasing preventive care and integrating the public and private healthcare sector. "Creating value for patients is both the ultimate goal and an increasingly critical competitive advantage for health care payers and providers worldwide. Payer organizations are being challenged to manage funding gaps and improve the care of members within a changing regulatory environment. Health care providers must transform their business models to deliver cost-competitive services that improve patient outcomes and deliver sustainable growth for the organization" (Farber, 2017).

In the United States, the new healthcare reform law (the Patient Protection and Affordable Care Act or "PPACA") required healthcare payers and insurance companies to cover additional preventive care services and eliminate member cost-sharing (copayments, deductibles, or coinsurance) for certain in-network preventive care services (Laxmaiah). The question that arises here is why the Middle East is still lagging behind on this front? It is clear that healthcare reform needs to kick in. This reform can only be done through collaborations between Third Party Administrators and the Ministry of Health and by extending the horizons of the existing healthcare benefits. Although many benefits have been introduced, still much reform is needed to be done.

## **METHODOLOGY**

This paper is based on the statistics, real-life medical examples and assessments – hence, it is a quantitative research using a deductive approach - conducted on data from a leading private healthcare Third Party Administrator in the Middle East, GlobeMed Lebanon. The ontology is that of a positivist and the epistemology is positivism; this leads to a positivist paradigm. In essence, we will focus on the Lebanese market and numbers pertaining to the Lebanese adherents – which is the sample of study. As for the methods to be used, this research will utilize the IBM Cognos Analytics software which is a business intelligence and performance management tool in order to personally

extract and analyze all the needed data. Besides Cognos Analytics, we will take advantage of a healthcare platform, 'i-care 2', which is utilized by GlobeMed Lebanon and which has access to all the medical records including adherents' profiles, electronic medical records and healthcare provider data. In this manner, all the needed quantitative data relevant to our study are extracted and linked to other financial and medical data in order to draw conclusions.

## **HYPOTHESES TESTED**

*H1:* The addition and implementation of new healthcare benefits by TPAs is cost-efficient.

*H2:* The addition and implementation of new healthcare benefits by TPAs would lead to a win-win scenario between the guarantors and adherents.

## **DATA GATHERING AND ANALYSIS**

### *1. Transplantation:*

While transplantation is described for kidney, liver, heart, pancreas, lung, cornea, skin, and bone marrow, our review will be limited to bone-marrow and kidney transplants because of the scarcity of cases.

In the following section, we will study 8 bone marrow and 7 kidney transplantations.

#### *1.1 Bone-Marrow Transplantation (BMT):*

Bone marrow transplantation, or stem cell transplantation, is the process of taking healthy stem cells from the blood or bone marrow and transferring them later on into a malfunctioning bone-marrow.

In the experience of GlobeMed Lebanon, since it started covering bone-marrow transplantation in May 2012 for its Perpetual and Mutually Upgraded Plus programs, only 8 patients needed this newly introduced benefit out of the 30 identified patients in the whole population including the groups that have policies that are the same as NSSF benefits.

The only two providers where bone-marrow transplantation (BMT) was done for GlobeMed Lebanon patients' were the American University of Beirut Medical Center and the Makassed General Hospital.

The outcome is not as impressive as in the kidney transplantation (presented later), but the number of cases reviewed is minimal and does not permit to make conclusions.

Only one woman who was 65 years old died during the same hospitalization of the bone-marrow transplantation. She had T-cell lymphoma diagnosed in February 2014, underwent the autologous bone-marrow transplantation in May 2016, and died of sepsis around one month later while still in hospital.

Another woman who was 65 years old, first diagnosed with Multiple Myeloma in September 2015, had 24 sessions of chemotherapy, followed by successful autologous bone-marrow transplantation. However, she died one year later of aspergillosis pneumonia.

The six remaining patients are still alive but with variable outcomes: stroke, relapse and chemotherapy four years later but with no direct complications. By reviewing the expenses related to this new benefit, the average cost of the procedure was 35,000 USD. The total cost incurred for the 8 patients related to their diseases was 809,640 USD; but it is important to note that regular chemotherapy cycles before the BMT are not included in the financial limitation.

It is worth noting that in the Lebanese market, transplantation is not yet included in most of the policies. But since its introduction under GlobeMed Lebanon's policies in 2012, the experience is considered encouraging, and out of the 94 cases with diagnosis listed in the indications of BMT, eight could benefit from it under their insurance coverage in Lebanon.

Although the network covered under GlobeMed Lebanon includes the MENA region and France, there are no reimbursement claims from abroad and all the cases were done in Lebanon.

### 1.2 Kidney Transplantation:

It is well known that end-stage renal disease may lead to death; only dialysis and kidney transplantation are available to treat this condition.

In Lebanon, there are 2 major payers: the public sector and the private sector.

Regarding the public sector, the NSSF and MOPH are paying directly the fees of the surgery to the hospital. They do cover also the cost of immunosuppressive drugs needed to maintain the life of the transplanted kidney.

In the private sector, most of the policies are still excluding kidney transplantation. GlobeMed Lebanon added the transplantation to its covered benefits in May 2012, subject to a life-time financial limitation.

Between 2012 and June 2015, GlobeMed Lebanon covered 7 cases of kidney transplantations. While the total financial limitation for the 7 cases was 780,000 USD, the cost of the procedures was only 180,260 USD, and the real spent amount was 107,586 USD since some patients had co-insurance.

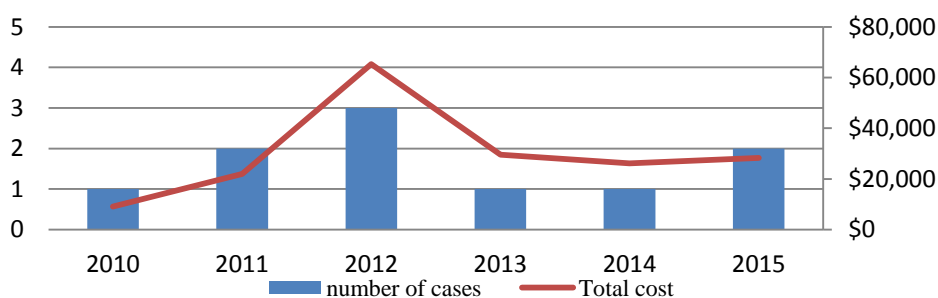

Figure 1: Kidney Transplantation

While the number of cases is not the most significant factor under study here, it should be noted that the average cost over the years strongly depends on the admission class of the patients. The good news is that 100% of the kidney transplantations procedures covered by GML were successful.

## 2. Psychiatric and Mental Disorders

While reviewing the number of patients who benefited from this newly added benefit, we found 21 patients from 2012 through 2015, 17 of them being female and 4 being male.

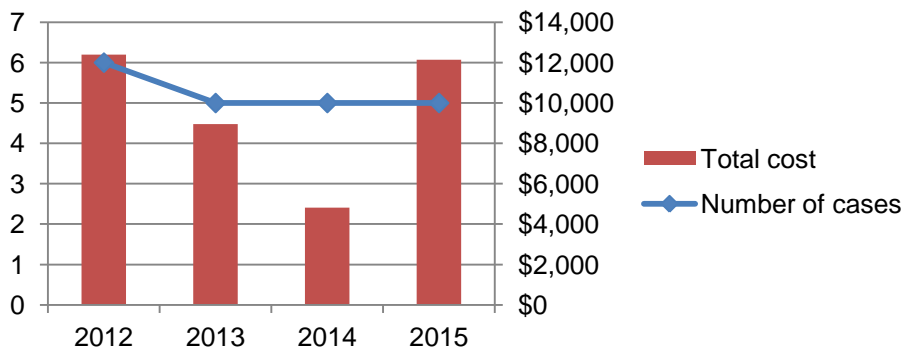

Figure 2: Psychiatric cases covered as of 2012

As can be seen in the figure above, the total cost incurred is not major and the maximum length of stay was 11 days for a case of major depressive disorder. The ages of hospitalized patient ranged between 21 and 88 years.

## 3. Infertility

GlobeMed Lebanon has extended its coverage of infertility in 2012 for the following coverage plans: Mutual Upgraded Plus, Perpetual Program, Perpetual SP Limited Network. This coverage for infertility covers laparoscopy and hysteroscopy procedures for females whereas for males it covers varicocele repair procedures. However, the newly added infertility benefit does not cover in-vitro fertilization or intra-uterine insemination procedures.

### 3.1 Males: Varicolectomy

Varicoceles are enlarged varicose veins that occur in the scrotum. Between 2012 and end 2015, GlobeMed Lebanon covered 337 varicocele surgeries, out of which 57 fall under the newly added benefits. The age of the beneficiaries ranged between 12 and 51 years. Most of them had one surgical intervention with no further complications. All the hospitals can provide this type of surgery, so claims occurred in 67 hospitals within the GML Network.

Going back to 2010 and 2011, we noted that GML was rejecting around 80 requests of varicocele repairs per year. GlobeMed Lebanon's male population counts for around 105,000 adherents, around 60,000 of them being between 12 and 51 years of age. Since coverage of infertility is not yet comprehensive, no one can estimate, from the number of varicocele cases covered, the rate of infertility in the subject male population.

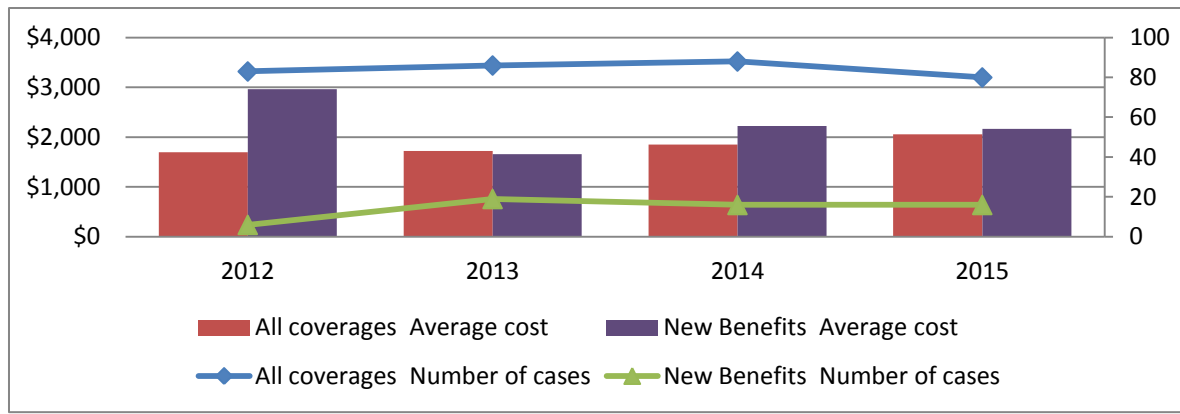

Figure 3: Varicocele in GML population

3.2 Females: Laparoscopy and Hysteroscopy

The most common procedures associated with infertility in women are laparoscopy and hysteroscopy. Both procedures can be performed for several medical conditions other than infertility and are inherently covered, such as pelvic pain, hemorrhage, etc...

If we limit our review to the cases with a final diagnosis of infertility, we have 10 cases between 2012 and the end of 2015, with a mean age of 36 years and an average cost of 1,401 USD.

Most of the laparoscopies done for infertility of tubal origin have an average cost of 2,522 USD while most of the hysteroscopies are done for endometrial hyperplasia with an average cost of 603 USD.

If we take into consideration all cases of hysteroscopies and laparoscopies in those years, for all ages including post-menopausal women, the below table will describe the situation. As can be seen, the numbers are quiet more than if infertility is taken alone which means that such procedures done for infertility alone are cheaper possibly due to lower expenses in accompanying costs.

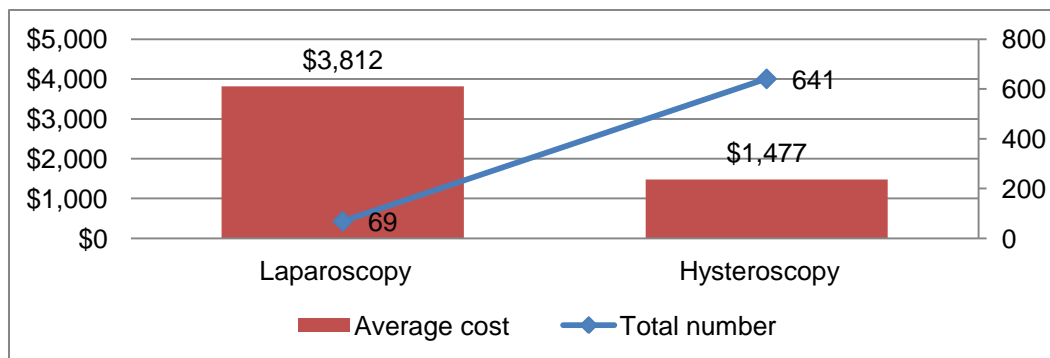

Figure 4: Laparoscopy and Hysteroscopy, all causes (not only infertility)

Our data shows that the number of claims for such procedures is gradually increasing over the years. Moreover, the age range of women undergoing the aforementioned procedures is mostly between ages 32 – 44 years and the total cost of those procedures over the years (2012 – 2015) for the newly covered plans sum up to nearly \$298,180 in those 4 years. However, the average cost per claim is relatively stable and the increase in total cost is mainly related to the increase of accepted claims over the years.



Year	Number of Accepted Claims	Total Cost (USD)	Average Cost/Claim(USD)
2012	85	\$51,734.73	\$608.64
2013	110	\$63,830.13	\$580.27
2014	130	\$79,106.94	\$608.51
2015	168	\$103,508.30	\$616.12
Total	493	\$298,180.10	Average \$603.4

Table 1: Average cost per claim

Now, let's look at the rejected cases of infertility before the year 2012 (before implementing the novel coverage) as compared to that rejection as of year 2012 onwards:

Our data shows that there were 36 rejected cases of infertility during the years 2012 till 2015, 15 of which were in 2010 and 16 being in 2011. So, 15.5 claims per year were rejected in those two years and this average rate of rejection decreased to 9 claims per year as of year 2012 onwards. Based on the fact that the average cost per claim was around 603 USD, then around 5,500 USD per year were related to rejected claims of infertility as of year 2012 onwards and around \$9,400 per year is related to rejected claims before that. Therefore, the rate of approval of infertility cases increased by more than 72%.

4. PET-Scan and VCT-64

4.1 PET-Scan:

A minimally invasive diagnostic imaging procedure, PET uses a radioactive tracer to evaluate glucose metabolism in tumors and in normal tissue. TPAs in Lebanon have started covering PET-Scans for oncology cases only. Studying the covered PET-Scans up until 2015, GlobeMed Lebanon covered them on out-patient basis, and the average cost of the test varied between 1,000 USD and 1,088 USD.

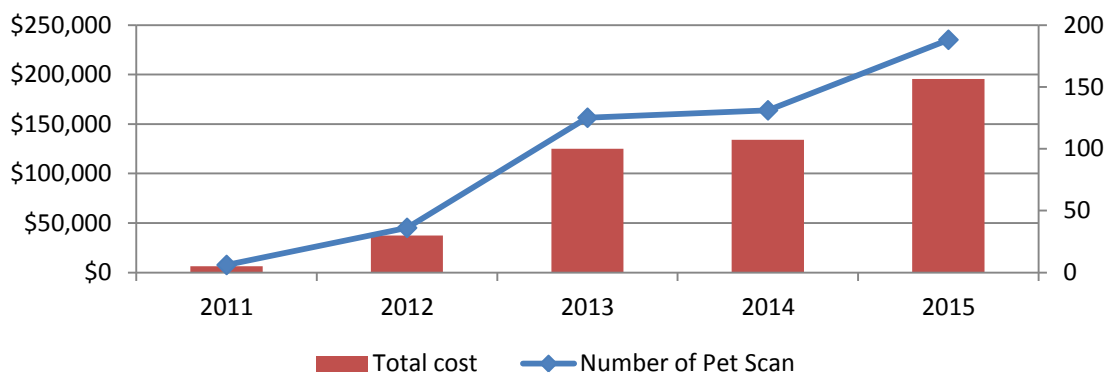

Figure 5: Number and Total cost of Pet Scan from 2011 to 2015

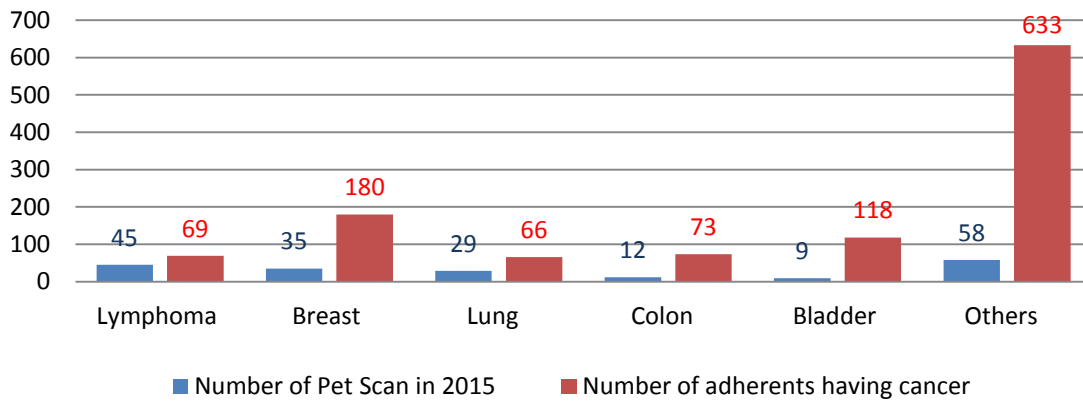

Figure 6: Number of Pet-Scans vs. number of cancer patients in 2015

GlobeMed Lebanon had 1,139 adherents in 2015 diagnosed with cancer and covered 189 PET-Scans, sometimes twice and more for the same patient during the same year. Although GML is sure the PET-Scanning is providing better cancer staging and follow-up, it does not have enough data to evaluate the impact of introducing PET-Scan to its policies.

4.2 VCT-64 (Coro-Scan):

The heart is known to be a “noble organ”. Preserving it is a major concern to any human being. GlobeMed Lebanon decided to cover this test even though it is not yet recognized by the NSSF.

As can be seen in the table below, the average and total cost of VCT-64 has been increasing over the years and this is related to the increasing number of patients undergoing this imaging technique. This is based on 2 factors: the increase of awareness to the benefits of this imaging technique and an increase in the awareness in recognizing the availability of it.

	2012	2013	2014	2015	2016
Sum Cost	\$1,458.61	\$14,564.74	\$29,686.02	\$49,792.56	
Average Cost	\$540.65	\$502.23	\$645.35	\$655.17	\$688.53
Count	4	29	46	76	

Table 2: Average and total cost of VCT-64

However, it should be noted that the coroscan did not replace the traditional cardiac catheterization which is done on an in-hospital basis.

5. Morbid Obesity Surgery (Bariatric Surgery)

Obesity is a world-wide epidemic and is associated with multiple serious co-morbidities, both physical and psychological.

Body Mass Index (BMI) is a simple index of weight for height that is commonly used to classify overweight and obesity in adults. It is defined as a person’s weight in kilograms divided by the square of his height in meter.

For adults, WHO defines overweight and obesity as follows:

- Overweight is BMI greater than or equal to 25.
- Obesity is a BMI greater than or equal to 30.

Since starting covering bariatric surgeries for morbidly obese adherents in October 2014, GML has approved and covered nearly 220 cases of such surgeries.

Furthermore, the increase in medical expenses and hospitalization fees has rendered those surgeries more expensive. This can be clearly noted in the graph below which shows the increasing trend in the average cost of the procedure in Lebanon.

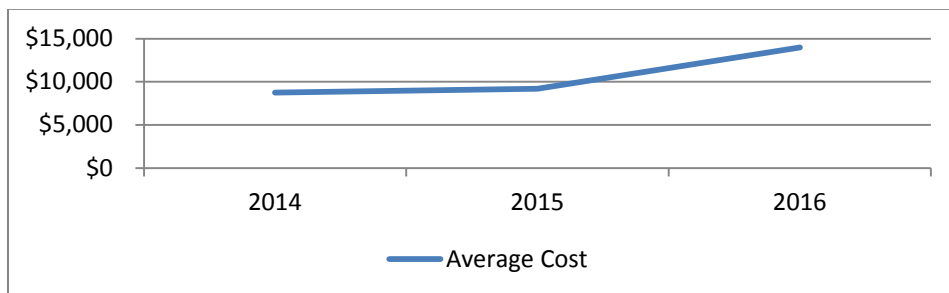

Figure 7: Average cost of morbid obesity surgery over the years in GML population

#### 6. HIV Tests:

The number of patients undergoing HIV tests is not huge but nonetheless significant. Knowing that HIV screening and testing helps in early detection, treatment and consequently a decrease in the number of patients reaching the AIDS stage, covering this test can have a great positive impact on our patients' health status and on decreasing the outbreak of this global disease.

We have not detected a significant difference in ordering this test between males and females (394 for females versus 362 for males). Moreover, the total cost of doing this test over the past 6 years for our population of adherents amounts to 16,686 USD knowing that a single admission for any of our patients can cost approximately this much if he/she presents with serious infections and immune-compromise.

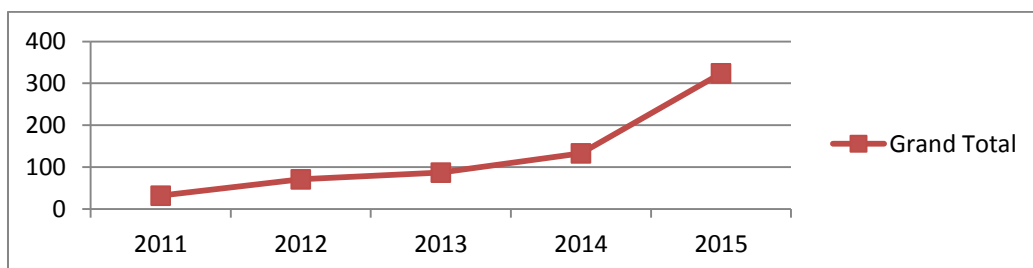

Figure 8: Trend of Total Number of Claims for HIV Tests over the years

As can be seen above the total number of claims dramatically increased in 2015 since GML started covering HIV testing in its policies as contrasted to the years before whereby coverage was just based on NSSF approval.

Because of the fact that antiretroviral treatment is given for free to infected patients and the fact that we are pushing forwards for early detection, the number of HIV infected patients who have an undetectable viral load is nearly 80% and the goal is to reach 90% according to Dr. Jaques Mokhbat, a prominent leading infectious disease physician who is striving for HIV advancement in Lebanon.

GML data shows that nearly 60% of the tests done for STD's other than HIV are mainly for anogenital (venereal) warts caused by human papillomavirus (HPV). However, the number of tests ordered is not very significant as it is small and not statistically important.

## DISCUSSION

In USA, Medicare started covering kidney transplantation in 1972, with deductible and co pay, based on a study proving cost saving compared to maintaining patient on hemodialysis (Levinsky). In Lebanon, the rising coverage of organ transplantation has helped in improving the health status of some patients especially those with end-stage-renal disease. However, the figures are still shy due to the various financial, technological and medical hurdles that still need to be solved. This does not mean that there is no future for such surgeries/ on the contrary, the future is bright in Lebanon and the Middle East for such surgeries especially kidney and bone-marrow transplantations.

As most people know, mental health care services are not covered by health insurance packages and health plans to the same degree as are physical healthcare services. Not only such medical services are excluded, but even when covered they are often subject to higher co-pays and are capped at a maximum number of covered treatments in a lifetime. Less well known is the fact that those with severe mental illness (SMI) are less likely to have health insurance coverage of any kind (McLaughlin, 2004).

What emerges is a complex circle of correlation that suggests various paths of causation. Lower levels of employment, educational attainment, and income are positively correlated with both mental illness and the lack of health insurance coverage; lower levels of insurance coverage are negatively correlated with utilization of primary care; late detection and treatment of mental illness is positively correlated with psychiatric and physical co-morbidities; and so on (Levy and Meltzer 2004). The findings of the research done by Wang point out a serious problem in the health care system and underscore the belief of many that mental illness may be one of the more important areas in which the lack of insurance coverage leads to serious deleterious health consequences which impact both the individual and society (Wang et al. 2004). In Lebanon, NGOs like IDRAAC (Institute for Development, Research, Advocacy and Applied Care) is striving to spread more awareness about such psychiatric illnesses and the fact that TPAs have started covering them rendered the patients less afraid to disclose about

such an illness and feel motivated about the mere fact that insurance companies are standing by their side.

Infertility is considered one of the main public health issues, as it affects about 15% of the couples of reproductive age (World Health Organization). The male factor is involved in 40% - 50% of infertility cases (Speroff L). The most common type of male infertility is idiopathic infertility, which is characterized by the presence of one or more abnormal semen parameters with no identifiable cause (Baker HW). Another common cause of male infertility is varicocele, which in a European study was found to affect 16.6% of men referred for infertility (Nieschlag E). The Lebanese public as well as third party administrators have seen no reason not to cover surgical and medical treatments for infertility. The previous idea was that health insurance companies should only cover medical case that cause debilitation or deteriorating health. However, as these companies have shifted their visions to encapsulate a more comprehensive medical approach that takes care of healthcare itself, the definition of what to cover has in turn changed. Managing infertility is started to be seen not as a 'luxury' treatment but a medical necessity.

Regarding infertility in females, studies have shown that surgical treatment of severe endometriosis does improve the chances for pregnancy as compared to no treatment (Richard Sherbahn). TPAs in Lebanon have started to cover cases of moderate and severe endometriosis which can help women in overcoming their infertility problem. The only way to be sure whether a woman has endometriosis is to perform a surgical procedure called laparoscopy that allows the physician to look inside the abdominal cavity with a narrow scope.

Endometrial polyps are localized hyperplastic overgrowths of endometrium that contain both endometrial glands and stroma. Up to 25% of women with unexplained infertility have endometrial polyps on hysteroscopy (Rackow). Since those polyps can bleed and in turn have serious complications, visualizing them via hysteroscopy and treating them either by excision or laparoscopy have saved us from many other attributable hospital admissions for anemia, unexplained abdominal pain, adhesions and possible malignancies. The approach therefore is not only to cover the disease that is directly related to the symptoms but also to prevent the possibility of having future preventable diseases and unnecessary hospital admissions.

Regarding breast cancer, PET-Scanning has efficacy superior to that of conventional imaging for the detection of locoregional and metastatic spread in the appropriate patient population, and has better diagnostic performance for detection of skeletal metastasis compared to routine bone scanning (Osborne JR, Miyake KK, Jin S). Pet-Scan allows more accurate staging of the tumor in patients and consequently has resulted in a change of treatment in 10%–15% of them (Gallamini A). Clinicians can detect much earlier the effectiveness of a given antineoplastic treatment, as compared to the

traditional radiological detection of tumor shrinkage, which usually takes time and occurs much later and by this Pet-Scan has increased the general survival rates in cancer patients by 25% (Pellegrini C). This is a main reason for the increasing utility of Pet-Scans in breast cancers. Therefore we should expect an increase in the demand on PET-Scan in breast cancer patients. The numbers in Lebanon have indeed shown that such exams are on the rise and therefore the need to cover them has become a necessity. Also under the umbrella of radiologic exams, we have seen that the use of 64-slice MDCT (multidetector computed tomography) results in excellent diagnostic accuracy and in an increased negative predictive value for detecting significant coronary stenoses in per-segment analysis. Patients with a high probability of coronary artery disease do not benefit from this type of non-invasive approach (Sirol). However, other patients with mild to moderate risk for cardiovascular diseases would surely benefit. In a study done by the Institute for Diagnostic and Interventional Radiology in Frankfurt, 218 patients with Coronary Artery Disease were studied (n = 218) and atherosclerotic plaques were found at transverse scanning with a sensitivity of 65.6% (143 of 218 plaques) (Vogl). This sensitivity increased in patients with an intermediate to moderate risk since this techniques works best for those patients and not for the ones who are known to have atherosclerotic heart disease or who are high-risk cardiac patients. By this token, third party administrators have realized that utilizing this exam to screen low to moderate-risk patients would in fact help those patients avoid that complications of the more invasive cardiac catheterization and would motivate more patients to perform this exam given the fact that it is patient-friendly, fast and safe.

On another front, covering bariatric (weight-decreasing) surgeries is on the rise in Lebanon and the Arab world. As per the American Society for Metabolic and Bariatric Surgery, based on data analyzed from 235 hospitals between 2005 and 2007, related to 66,339 bariatric surgeries performed, 83% of patients were female with mean age 43 years. In GlobeMed Lebanon 57% of the patents were female, with an average age of 37 years.

Out of the 220 claims of bariatric surgery, we had a total of 19 complications (8.5%) that followed the surgery and occurred during the same hospital stay. The complication rate in Lebanon is lower than the international rate (13% for Sleeve and Banding and 21% for Bypass as shown by the various different research conducted by Blachar A, Carucci LR, Chang SH, Heneghan HM, Himpens J, Livingston EH, Masoomi H, Suter M, Topart P, Triantafyllidis G). These complications include post-operative haemorrhage and hematoma (5 cases), prolonged ileus (2 cases), hypotension and tachycardia (2 cases), ulcer and necrosis (1 case), vomiting and intestinal obstruction (4 cases), accidental puncture and laceration during procedure (1 case), fever (1 case), dysphagia (1 case), respiratory distress (2 cases), respiratory distress (2 cases).

Of the three most popular bariatric surgeries (Lap Band, sleeve gastrectomy, gastric bypass), gastric bypass is the most expensive. Duodenal switch surgery and some revision procedures are usually the most expensive of **all** bariatric procedures. The gastric banding used to be the most popular; however, currently, sleeve gastrectomy is the most common followed by gastric bypass. Due, to the prominence and popularity of those latter two procedures, the average cost of the bariatric surgery has increased over the years. Furthermore, the increase in medical expenses and hospitalization fees has rendered those surgeries more expensive.

Finally, over the past decade, antiretroviral therapy has become more potent, better tolerated, and less complex. According to an article published in Oxford Journal, today, most human immunodeficiency virus (HIV)-infected individuals receiving combination antiretroviral therapy achieve an undetectable plasma HIV-RNA level. Nevertheless, deficits in the spectrum of engagement in HIV care including late HIV diagnosis, suboptimal linkage to and retention in HIV care, insufficient use of antiretroviral therapy, and suboptimal adherence to therapy, pose significant barriers to achieving optimal treatment outcomes (Gardner EM, 2011). In Lebanon, the Ministry of Public Health is dispensing free medical treatment (antiretroviral medications) for hall HIV-positive patients. Several efforts are also being made in order to decrease the social stigma and stereotypes that surround those patients. Many social enterprises are also starting to devise new and innovative plans in the Middle East to help the communities get more aware of the dangers of HIV, prevention techniques as well as facilitating the delivery of medical management to all infected patients irrespective of sexual preferences or race. Therefore, third party administrators have found themselves in a critical position to cover those patients especially since helping them at an early stage would result in a win-win situation on the long-run, both for insurance companies and patients.

#### **Financial Evaluation:**

	Total Amount of Approved Costs for Year 2015
IN Claims	\$174,075,214
OUT Claims	\$36,420,203

Table 3: Financial Evaluation for year 2015

	Total Cost in Year 2015 (\$)	Relative Percentage (%)
Bone Marrow Transplant	175,000	0.040
Kidney Transplant	30,000	0.017
Psychiatry	12,000	0.007
Varicocele (Infertility)	160,000	0.092
Laparoscopy (Infertility)	59,000	0.034
Hysterectomy (infertility)	257,504	0.148
Pet-Scan	240,000	0.660

Coroscan (VCT-64)	50,000	0.140
Bariatric Surgeries	1,500,000	0.900
HIV	12,800	0.035

Table 4: Total cost in year 2015

(Note: relative percentages were calculated based whether each service is considered an in-patient or an out-patient claim).

The opportunity cost of not covering those services:

	Opportunity Cost Description (in case of not covering)
Bone Marrow Transplant	Aplastic anemia, Leukemia, Lymphoma, Multiple Myeloma, Thalassemia... can all be cured by this procedure and therefore the cost saving would be significant.
Kidney Transplant	Chronic Dialysis and most of the complications related to Chronic Renal Failure can be avoided.
Psychiatry	decrease the stigma related to this medical condition, mitigate discrimination, boost patient's credibility in the healthcare sector and avoid claims related to idiopathic claims that do not disclose psychiatric reasons as the underlying disease.
Varicocele (Infertility)	An untreated varicocele or uterine polyps/adhesions are not life-threatening,
Laparoscopy (Infertility)	however, they can lead to damage or complete atrophy of the testicles, ovaries
Hysterectomy (infertility)	and/or irreversible damage to the uterus and ultimately complete infertility. Covering such claims would render the healthcare services more immersive and comprehensive, decrease the stigma related to being infertile, boost the adherents trust in Third Party Administrators and help in avoiding unnecessary systematic complications.
Pet-Scan	There are tremendous benefits of having a combined PET/CT scan including earlier diagnosis, accurate staging and localization and precise treatment and monitoring. The cost-saving therefore is significant.
Coroscan (VCT-64)	Early detection of coronary artery diseases and avoiding strokes.
Bariatric Surgeries	Provide patients with long term weight-loss and help increase the quality of health. Help improve or resolve many obesity-related conditions, such as type 2 diabetes, high blood pressure, heart disease, and more.
HIV	Help patients in containing their infection and not reach the AIDS stage

Table 5: Opportunity Cost Description

The hypotheses tested that the addition and implementation of new healthcare benefits by TPAs is cost-efficient and would lead to a win-win scenario between the guarantors and adherents is therefore valid.

## CONCLUSION



There has always been a question of whether extending a TPA's coverage would be increasing the burdens on its shoulders. It turns out that on the contrary, the adherents (patients) get to feel protected and taken care of by nondiscriminatory and well-thought-of actions which would enhance clients' loyalty while at the same time being viable for those Third Party Administrators. Many efforts are done to shift the TPA role into "sickness prevention", promoting prevention and wellness education and even extending the scope of coverage to palliative care. This is done by extrapolating the basic function of merely acting as an intermediary between the insurer and the insured by taking a further step to assess the feasibility and benefit of extending the coverage in a win-win situation whereby the adherents have better access and coverage to broader healthcare services which are deemed financially feasible.

## REFERENCES

- Araujo, M. (2016), "What Does That Mean? Understanding Health Insurance Coverage How Co-Payments, Deductibles and Other Health Insurance Policy Basics Work", The Balance, Updated October 12, 2016.
- Baker, H.W. (1994), "Male infertility", *Endocrinol Metab Clin North Am*, Vol. 23, pp. 783–793.
- Bhat, R. and Sumesh, B. (2004), "Health insurance and third party administrators: Issues and Challenges", *Economic and political weekly*, Vol. 39 No. 28, pp: 3149-3155.
- Blachar A. and Federle M.P. (2002), "Gastrointestinal complications of laparoscopic Rouxen-Y gastric bypass surgery in patients who are morbidly obese: findings on radiography and CT", *AJR Am J Roentgenol*, Vol. 179 No. 6, pp. 1437–1442.
- Carucci L.R. and Turner M.A. (2009), "Imaging after bariatric surgery for morbid obesity: Roux-en-Y gastric bypass and laparoscopic adjustable gastric banding", *Semin Roentgenol*, Vol. 44 No. 4, pp. 283–296.
- Centers for Disease Control and Prevention (2014), "The Affordable Care Act helps people living with HIV/AIDS", available at: <http://www.cdc.gov/hiv/policies/aca.html> (accessed 2 September 2016)
- Chang, S.H., Stoll, C.R., Song, J., Varela, J.E., Eagon, C.J. and Colditz, G.A. (2014), "The effectiveness and risks of bariatric surgery: an updated systematic review and meta-analysis, 2003-2012", *JAMA Surg*, Vol. 149 No. 3, pp. 275–287.
- Farber, A. (2017), *Health Care Payers & Providers - Increased Value for Patients, Sustainable Growth for Organizations*, Boston Consultancy Group.
- Gallamini, A., Zwarthoed, C. and Borra A. (2014), "Positron Emission Tomography (PET) in Oncology", *Cancers*, Vol. 6 No. 4, pp. 1821-1889.
- Gardner, E.M., McLees, M.P., Steiner, J.F., Del Rio, C. and Burman, W.J. (2011), "The spectrum of engagement in HIV care and its relevance to test-and-treat strategies for prevention of HIV infection", *Clin Infect Dis*, Vol. 52 No. 6, pp.793–800.
- Heneghan, H.M., Meron-Eldar, S., Yenumula, P., Rogula, T., Brethauer, S.A. and Schauer, P.R. (2012), "Incidence and management of bleeding complications after gastric bypass surgery in the morbidly obese", *Surg Obes Relat Dis*, Vol. 8 No. 6, pp. 729–735.
- Himpen, J., Dobbeleir, J. and Peeters, G. (2010), "Long-term results of laparoscopic sleeve gastrectomy for obesity", *Ann Surg*, Vol. 252 No. 2, pp. 319–324.
- Jin, S., Kim, S.B., Ahn, J.H. et al. (2013), "18 F-fluorodeoxyglucose uptake predicts pathological complete response after neoadjuvant chemotherapy for breast cancer: a retrospective cohort study", *J Surg Oncol*, Vol. 107 No. 2, pp. 180-187.
- Kronfol, N.M. (2006), "Rebuilding of the Lebanese health care system: health sector reforms", *Eastern Mediterranean Health Journal*, Vol. 12, No. 3-4, pp. 459-473.
- Levinsky, N., Rettig, R. (1991), "The Medicare End-Stage Renal Disease Program — A Report from the Institute of Medicine", *The New England Journal of Medicine*, Vol. 324, pp. 1143-1148

- Levy, H. and Meltzer, D. (2004), "What Do We Really Know about Whether Health Insurance Affects Health?", in McLaughlin, C.G. (Ed.), *In Health Policy and the Uninsured*, Washington DC: Urban Press.
- Livingston, E.H. (2010), "The incidence of bariatric surgery has plateaued in the U.S.", *Am J Surg*, Vol. 200 No. 3, pp. 378–385.
- Manchikanti, L., Caraway, D., Parr, A.T., Fellows, B., and Hirsch, J.A. (2011), "Patient Protection and Affordable Care Act of 2010: Reforming the Health Care Reform for the New Decade", *Pain Physician*, Vol. 14 No. 1, pp. 35-67.
- Masoomi, H., Kim, H., Reavis, K.M., Mills, S., Stamos, M.J. and Nguyen, N.T. (2011), "Analysis of factors predictive of gastrointestinal tract leak in laparoscopic and open gastric bypass", *Arch Surg*, Vol. 146 No. 9, pp. 1048–1051.
- McLaughlin, C.G. (2004), "Delays in Treatment for Mental Disorders and Health Insurance Coverage", *Health Services Research*, Vol. 39 No. 2, pp. 221-224.
- Miyake, K.K., Nakamoto, Y., Kanao, S. et al. (2014), "Journal Club: diagnostic value of (18)F-FDG PET/CT and MRI in predicting the clinicopathologic subtypes of invasive breast cancer", *Am J Roent-genol*, Vol. 203 No. 2, pp. 272-279.
- Nieschlag, E. (1997), "Classification of andrological disorders", in Nieschlag, E. and Behre, H.M. (Ed.), *Andrology*, Berlin, Heidelberg, New York: Springer-Verlag' pp. 79–83.
- Osborne, J.R., Port, E., Gonen, M. et al. (2010), "18F-FDG PET of locally invasive breast cancer and association of estrogen receptor status with standardized uptake value: microarray and immunohisto-chemical analysis", *J Nucl Med*, Vol. 51 No. 4, pp. 543-550.
- Otero, H.J., Steigner, M.L., Rybicki, F.J. (2009), "The "Post- 64" Era of Coronary CT Angiography: Understanding New Technology from Physical Principles", *Radiologic clinics of North America*, Vol. 47 No. 1, pp. 79-90.
- Parnell, S. (2017), "More health insurance policies have exclusions as premiums rise", *The Weekend Australian*, January 4, 2017.
- Pellegrini, C., Casadei, B., Derenzini, E., Stefoni, V., Derenzini, E., Gandolfi, L., Casadei, B., Maglie, R., Pileri, S. and Zinzani, P.L. (2014), "Prognostic Value of Interim Positron Emission Tomography in Patients with Peripheral T-Cell Lymphoma", *Oncologist*, Vol. 19, pp. 746–750.
- Rackow, B.W., Jorgensen, E. and Taylor, H.S. (2011), "ENDOMETRIAL POLYPS AFFECT UTERINE RECEPTIVITY", *Fertility and sterility*, Vol. 95 No. 8, pp. 2690–2692. PMC. Web. 29 Oct. 2016.
- Schrevens, L., Lorent, N., Dooms, C. and Vansteenkiste J. (2004), "The role of PET scan in diagnosis, staging, and management of non-small cell lung cancer", *Oncologist*, Vol. 9, pp. 633–643.
- Sherbahn, R., "The Effect of Endometriosis on Fertility and Infertility", *Advanced Fertility Center of Chicago*, available at: <http://www.advancedfertility.com/endometriosis.htm>
- Sirol, M., Sanz, J., Henry, P., Rymer, R. and Leber A. (2009), "Evaluation of 64-slice MDCT in the real world of cardiology: A comparison with conventional coronary angiography", *Archives of Cardiovascular Diseases*, Volume 102 No. 5, Pages 433-439, Copyright © 2009 Elsevier Masson SAS
- Speroff, L., Glass, R.H. and Kase, N.G. (1999), "Clinical Gynecologic Endocrinology and Infertility", 6th Ed. Baltimore USA: Lippincott Williams & Wilkins. Infertility, pp. 201–246.
- Suter, M., Giusti, V., Worreth, M., Héraief, E. and Calmes, J.M. (2005), "Laparoscopic gastric banding: a prospective, randomized study comparing the Lapband and the SAGB: early results", *Ann Surg*, Vol. 241 No. 1, pp. 55–62.
- Topart, P., Becouarn, G. and Ritz, P. (2012), "Comparative early outcomes of three laparoscopic bariatric procedures: sleeve gastrectomy, Roux-en-Y gastric bypass, and biliopancreatic diversion with duodenal switch", *Surg Obes Relat Dis*, Vol. 8 No. 3, pp. 250–254.
- Triantafyllidis, G., Lazoura, O., Sioka, E. et al. (2011), "Anatomy and complications following laparoscopic sleeve gastrectomy: radiological evaluation and imaging pitfalls", *Obes Surg*, Vol. 21 No. 4, pp. 473–478.
- Vogl, T.J., Abolmaali, N.D., Diebold, T., Engelmann, K., Ay, M., Dogan, S., Wimmer-Greinecker, G., Moritz, A. and Herzog, C. (2002), "Techniques for the detection of coronary atherosclerosis: multi-detector row CT coronary angiography", *Radiology*, Vol. 223, No. 1, pp. 212-220
- Wang, P.S., Berglund, P.A., Olfson, M. and Kessler, R.C. (2004), "Delays in Initial Treatment Contant after First Onset of a Mental Disorder", *Health Services Research*, Vol. 39 No. 2, pp. 393–415.
- World Health Organization. *Laboratory manual for the examination of human semen and sperm-cervical mucus interaction* (1999). 4th Ed. New York USA: Cambridge University Press.
- Younis, M.Z. (2013), "Interview: comparative effectiveness research and challenges to healthcare reform in the Middle East and USA" *J. Comp. Eff. Res*, Vol. 2 No. 3, pp. 223–225.

# INTERLINKING EMOTIONAL INTELLIGENCE AND CUSTOMER RELATIONSHIP MARKETING IN THE LEBANESE RETAIL BANKING SECTOR

Al Khoury, Grace; Thrassou, Alkis; Kaufmann, Hans Ruediger

School of Business, University of Nicosia, Nicosia, Cyprus

## ABSTRACT

Emotional intelligence has been a topic of controversy over the years pertaining to its level of significance in the business world as well as how it can be defined and understood as a concept. Through a number of researches done by pioneers in the field of emotional intelligence, it is shown that EI have shown a significant effect on the retail banking sector; hence, the aim of this research is to link emotional intelligence theory with frontline employee behavior in the context of customer relationship marketing; and to empirically test these on the Lebanese retail banking sector, drawing also practicable managerial implications through a combination of existing models, theoretical research and secondary data. A conceptual framework of emotional intelligence was developed. The value of this research stems from its contribution regarding shedding the light on the importance of EI, the interlinkage between EI and CRM and the creation of a customized conceptual framework that fit the LRBS; as well as setting of the foundation for future research that will refine, test and finalise this conceptual framework.

*Keywords:* Emotional intelligence (EI), Customer Relationship Marketing (CRM), Service Encounter, Lebanese Retail Banking Sector (LRBS), Lebanon.

## 1. INTRODUCTION

Studying the concept of emotional intelligence in the Lebanese culture is of great interest since emotional intelligence helps in enhancing customer relationship marketing of organizations that are in the service field such as banks (the industry, focus of this research). It is thus crucial for banks to understand their customers' communication needs and perceptions, and to utilise this knowledge in the emotional intelligence context towards more effective customer relationship marketing techniques.

This research is a continuation on the work of Al Khoury et al., 2016 and Al Khoury et al., 2017, to refine the past papers' model, to expand on it, to shape gaps and concepts better as well as to specify methodology better. A greater literature review is constructed through adding new concepts, such as:

CRM, Exhibited Behavioural Attributes of EI, Customer Evaluation and Service Recovery, to serve the creation of the new conceptual framework.

In the context above, the aim of the research is to link emotional intelligence theory with frontline employee behavior in the context of customer relationship marketing; and to empirically test these on the Lebanese retail banking sector, drawing also practicable managerial implications.

Towards this aim, seven objectives have been set:

1. To construct the theoretical foundation of the research and particularly in relationship to emotional intelligence, customer relationship marketing and service encounters.
2. To identify and evaluate emotional intelligence related employee behavioural attributes in the customer relationship marketing context, from the customer perspective.
3. To describe customer evaluation of exhibited emotional intelligence behavioural attributes.
4. To identify customer positive and negative actions in response to exhibited emotional intelligence behavioural attributes.
5. To prescribe how emotional intelligence can improve the service experience.
6. To interrelate bank employees' responses with exhibited emotional intelligence behavioural attributes.
7. To develop a framework that will practicably link emotional intelligence theory with frontline employee behavior in the context of Lebanese banking customer relationship marketing.

## **2. THEORETICAL FOUNDATION**

### *2.1 Emotional Intelligence*

Over the years, the concept and definition of emotional intelligence has evolved since the 19<sup>th</sup> century. Gabriel (2000) stated that in 1990, Peter Salovey and John Mayer discovered a universal pattern to study emotions. Their research findings showed that individuals are able to identify and recognize emotions through faces, certain designs and colours. The term "Emotional Intelligence" became more solid and structured in 1995 and 1998, where people became aware of this terminology when Daniel Goleman wrote in "Emotional Intelligence: why it can matter more than IQ". Theorists such as Thorndike, Wechsler and Gardner were the first to generate awareness of the concept of EI and facilitated the emergence of the current well known pioneers in the field of EI such as Peter Salovey and John Mayer, Daniel Goleman and Reuven Bar-On.

Emotional intelligence, simply, is the individual's ability to monitor, recognize and understand his/her own emotions and feelings as well as others and the skill to use this ability in managing one's behavior and relationships.

According to Mayer and Salovey (1997), the major areas of skills are: perception and expression of emotion, assimilating emotion in thought, understanding and analyzing emotion, and reflective regulation of emotion. Bar-On (1997) stated the following major of skills: intrapersonal skills, interpersonal skills, adaptability scales, stress-management scales, and general mood. The third most known and commonly used EI model is that of Goleman (1995a) where he listed the following skills: knowing one's emotions, management emotions, motivating oneself, recognizing emotions in others, and handling relationships.

Intelligence quotient (IQ) and emotional intelligence (EI) are two completely different concepts and are independent of each other. It is possible for an individual of high level of IQ to have a low level of EI or vice versa. People assume that IQ is highly correlated with the achievements; to our surprise, it is not. Whereas EI is considered to be of high importance and highly correlated with success, experts stress that IQ contributes only about 20% of one's success and achievements. A study examining Harvard graduates showed that the entrance exam grade, which is highly linked to IQ, had a poor and even a negative correlation with one's success in his/her career life. It is well known that in order to run successful businesses it is not enough to use just the smarts. It is crucial to have a personal and a long-term relationship based on trust and technical know-how with the clients/customers especially in the services sector which includes banking. In business it is crucial to have self-awareness and self-confidence, and emotional intelligence is the key building block of these two components. Emotional intelligence is made up of five competencies as Goleman states: 1. Self-awareness: knowing one's feelings, 2. Self-regulation: managing those feelings and emotions, 3. Motivation: stimulating oneself, 4. Empathy: identifying and knowing others', 5. Social skills: managing relationships.

The following skills cannot be studied, measured and analyzed from a customer's perspective rather than from the employees' perspective. As a result, there is a need to translate these skills into exhibited behavioural attributes. A further research was made to construct a transitional phase in the model, which is the exhibited behavioural attributes, that enables the future implementation of the model. The key of the transition of emotions into behavior is attitude. (McShane and Von Glinow, 2009, p.100)

## *2.2 Exhibited Behavioural Attributes of Emotional Intelligence*

McShane and Von Glinow (2009) discussed the effect of emotions on the workplace and how emotions can be translated into attitude and then behavior. Since emotional intelligence is the study of emotions, generally speaking, there is need for the knowledge on the different types of emotion based on the levels of activation and evaluation.

The “Circumplex Model of Emotions” is the building block for understanding emotions which will be translated into behavioural attributes as a result of more detailed and interrelated models.

Emotional intelligence, generally speaking, is a psychological intelligence that deals with ones’ emotions and feelings; hence, how is it possible to control, motivate, and express these emotions if the individual is not aware of the emotions and the outcomes, consequently. The model shows two extreme emotions: positive and negative; however, the level of activation is the variable that results in different outcomes. Showing negative emotions at the workplace will result in poor performance; as a result, managers try to ensure that their employees come with positive vibes to work to increase the profitability of the organization.

Having the knowledge at this level of the different emotions, level of activation and the outcomes, a new “Model of Emotions, Attitudes, and Behavior” is introduced to summarize the role of emotions, attitudes and behavior, through both cognitive and emotional processes. The stimulus-response (S-R) model represents the difference between attitudes and emotions; attitude is a set of judgments that includes logical reasoning, whereas emotions are experiences that operate without one’s awareness. This dual cognitive-emotional attitude model is made up of cognitive, logical reasoning part, which creates the attitude, which is made up of three interrelated factors: 1. Beliefs, 2. Feelings and 3. Behavioural intentions. The model also consists of an emotional process where we have emotional episodes. These episodes affect one’s feelings which will have an influence on the end result, the behavior. Some episodes will lead to different emotions, but even low-intensity emotions will result in some automatic facial expressions that will be noticed by the customers. Hence, organizations tend to expose their employees to emotional episodes leading to positive feelings in order to shape employees’ attitude and behavior. The MARS model is an elaborated and advanced continuation of the S-R model and is made up of four factors: motivation, ability, role perceptions, and situational factors. This model shows a noticeable link between emotional intelligence skills and the factors that affect one’s behavior.

The “MARS – Model of Individual Behavior and Results” model consists of four elements which are influenced by individual characteristics. 1. Motivation: affects *direction* (which path to choose), *intensity* (how much effort is the individual going to dedicate for each target) and *persistence* (how much time will the individual continue to put effort to reach that goal). 2. Ability: is made up of

*aptitudes* (are the natural talents/skills which help employees to attain the needed tasks at work and hence perform better), and *learned capabilities* (are the physical and mental capabilities that individuals currently have and might fade with time if not practiced). The mix of these two concepts is usually used in the business world under the umbrella of *competencies*. Competencies are commonly described as personal traits such as: “knowledge, skills, aptitudes, personality, self-concept, values” (McShane, Von Glinow, p.36). Having these competencies will result in a better performance. 3. Role perceptions: are crucial for employees to know clearly their job description. Knowing what is needed and expected from them will set the direction and coordination with other employees/suppliers/stakeholders to reach their goal. There is a need for knowledge regarding the specific tasks, prioritizing their tasks and perform as expected, and finally understand which is the most preferable procedure/behavior by the organization to choose to complete the tasks assigned. 4. Situational factors: are external, non-controllable factors that affect employee’s behavior and performance. However, some situational factors such as: “time, people, budget, and physical work facilities” (McShane, Von Glinow, p.37) can be controlled and leaders make sure to plan for such factors so that their employees are able to perform at their best.

By mixing emotional intelligence skills and both S-R and MARS models of behavior, the following exhibited behavioural attributes of emotional intelligence are suggested:

- Expression of Emotions: Translation of anger, frustration, stress, work-overload ect. by employees in their interaction.
- Managing Emotions: Control, regulation, or otherwise channelling negative emotions into positive outcome.
- Constructive Communication: Communicating, connecting, providing needed/relevant information (technical know-how), tackle problems, reach solutions, persuade and motivate customers to invest/take risks.
- Adaptation: Adapting to changing environments, sudden obstacles/errors, anger bursts and unusual needs/requests.

Retail bank employees who have the above suggested exhibited behavioural attributes of emotional intelligence will result in a positive outcome and hence will be able to implement the customer relationship marketing skills to succeed at the workplace.

### *2.3 Customer Relationship Marketing*

Marketers in the new millennium are of two groups, those who practice customer relationship marketing (CRM) and those who do not, yet. However, those who do not practice CRM will not survive the new millennium and will not have enough profit to survive in the market. Generally speaking, marketing had gone through three waves, since world war two, before reaching CRM: 1. Mass marketing, 2. Targeted marketing, and 3. Global marketing. All three waves share a core concept, which is the main focus/goal on maximizing sales. Since it is possible for sales to increase without increasing profits, marketers shifted their attention to the quality of share so that they ensure profitable growth. Marketers aim to increase both sales and profits, simultaneously, through creating and reinforcing the bonding with the customers and hence build customer relationships. CRM is the fourth significant post-war wave that came after global marketing (which is still used to date).

The four pillars of CRM, in short, are the ability to: 1. Identify, 2. Attract, 3. Defend and 4. Strengthen 'brand loyalty'; and if the heart of CRM is brand loyalty, then 'Value of a Customer' (VOAC) is its brain. CRM is all about creating relationships with customers, retaining them, and trying to move them up the loyalty ladder. CRM is not about the sales, rather than enduring profitable growth through focusing on the customers and creating a loyalty bond between the organization and its clients/customers. Selling, which was the end goal of traditional marketing, is the first stage of CRM to turn customers into loyalists. Only customer-relationship marketing can endure profitable growth.

### *2.4 Service Encounters*

On the other hand, employees might face failure in performing/implementing the suggested behavioural attributes of emotional intelligence. The failure in service performance means that the customer's expectations were not met therefore customers will be dissatisfied leading to a negative outcome by having negative customer reactions/feedbacks. Data from TRAP Worldwide Inc. (2007) shows that: 1% to 5% complains to management or company headquarters, 45% complain to a frontline employee and 50% encounter a problem but do not complain. Zeithaml, Bitner and Gremler (2013) presented the "Customer Complaint Actions Following Service Failure" model in their book.

When failing to satisfy customer needs, negative emotions will emerge which will lead to either not complaining and choosing to either exit/switch or stay; or to act upon these negative emotions and file a complain to the provider, spread negative word-of-mouth using social media or other tools, which is extremely harmful for the organization due to the ease of access to social media without putting any financial effort and the time factor, where the complaint can be spread to the community in a matter of seconds. The customer might also consider a third-party action that would take action on his/her behalf which also harms the organization and cause propaganda. The end result



will be either exiting or switch the organization or to stay, based on how the dissatisfaction was handled by the organization/employees. In order to minimize the loss of customers as a result of service failure, customers expect the organization to not only response, but also to show remorse for the inconvenience and disappointment of the service. The organization is expected to show that they hold the responsibility and offer help as soon as failure occurs. The "Service Recovery Strategies" model presents the strategies that should be implemented once the organization faces a service failure.

Following the model of service failure which was discussed above, the model is adopted to 'fix' the dissatisfaction from the customer perspective as well as fixing the problem itself to ensure that it would happen again. Organizations and employees seek continuous improvement through learning from previous mistakes and planning for the future through trainings and gaining experience through time. The implementation of these service recovery strategies/techniques will result in the shift of the negative outcomes which lead to negative customer feedback/reaction into a positive outcome. As a result, the failure will be recovered and employees will be able to implement the relationship marketing skills to ensure and boost their success. The concept of consumer behavior is embedded in the process of having a positive and negative outcome as well as in the corrective actions using service marketing techniques since without having the knowledge of customers behavior, it will be impossible for employees to uncover the needs and wants of their customers to satisfy and fulfil their expectations.

### *2.5 Focusing on the Lebanese market*

Jamali, Sidani and Abu-Zaki (2008) stated the following results after conducting their research using the Emotional Quotient Inventory (EQ-I) technique to measure emotional intelligence and a final sample of 225 individuals working in different sectors such as banks, publishing organizations, internet companies, auditing firms, universities, government organizations, and other sectors from Beirut, Lebanon. Results showed that the entire sample scored moderate levels of emotional intelligence and that males scored higher on self-regulation and self-motivation whereas females scored higher on self-awareness, empathy and social skills. There was no significant change in EI scores between genders except for self-regulation where males scored higher. Senior managers scored higher than staff or lower-level employees on self-awareness, self-regulation and self-motivation whereas middle managers scored lower than senior managers and staff on empathy. Differences in educational background, as there are three categories: high school, college and graduate degree, had no significance in emotional intelligence scores when testing for self-awareness, self-regulation, self-motivation, empathy and social skills. Moreover, difference in age had no significance in emotional intelligence score, except for self-motivation where the group ranging from 35 to 44 scored the highest and the group aging under 25 scored the lowest. Carrying emotional intelligence assessments at work

can assist employees to detect their strengths and areas of development, and by implementing this technique in a safe and supportive environment, it can trigger and improve self-motivation.

Moreover, a research was conducted by Hejase, Al-Sayed, Haddad and Hamdar in 2012 to explore how emotional intelligence is applied in Lebanon. In the first part of their study, researchers highlighted the importance of emotional intelligence in business through existing frameworks. In order to explore emotional intelligence applications in Lebanon, both industry and service sectors were targeted. The sample included employees and managers of different backgrounds and gender. The final sample size was 110 individuals, and ten managers divided evenly between the service and industry sector. Results showed no significant distribution difference between genders in both sectors. To summarize the awareness of emotional intelligence: 2/3 of the respondents in both sector are not fully aware of the concept of emotional intelligence and have no deep knowledge on this concept. When identifying the sources that exposed emotional intelligence to the respondents in both sectors, none stated that they learned about it from their work setting. The sources were either from their education, media, or other mixed sources. The majority in both sectors agreed that EI has positive effects on an organization's profit and disagreed with the statement that adopting EI principles incurs a lot of costs in such a way that there is no point in investing in it. They also agreed that EI programs result in favourable results in employees' retention and disagreed that employees are required to work individually and not in teams when practicing EI principles.

### *1.7 Research Gap*

The link between the concept of emotional intelligence and other domains such as healthcare, banking and education has taken interest over the years. A research paper written by Tudor (2015) has studied the link between EI and these different domains. The researcher stated that banks can utilize the concept of emotional intelligence when it comes to customer-banker relationship and in the day-to-day interactions. Other recent research papers conducted by Danquah (2014) and Kappagoda (2013) have showed the importance of EI in the banking sector. Tudor (2015) has suggested to further research the link between EI and one of the domains that she has researched; one of these domains is the banking sector. Hence, it is stated that the link between emotional intelligence and customer-banker relationship should be researched and studied thoroughly.

Kearney et al. (2017) studied emotional intelligence in front-line/back-office employee relationships and stated: "The present study is premised on the assumption that employee emotional intelligence (at the front line and in the back office) positively affects customer attitudes and drives customer-related organisational outcomes. We did not demonstrate this link empirically though. Further studies might use dyadic data and thereby link emotional intelligence at the individual employee level to the customer level" (p. 193).

Researchers have already suggested a research gap in the term of lack of empirical research linking emotional intelligence, its exhibited behavioural attributes of employees and customer relationship marketing from the customer perspective; and some researchers, in fact, have explicitly or implicitly called for such work to be done (Tudor 2015; Danquah, 2014; Kappagoda (2013); Kearney et al., 2017; Wisker and Poulis, 2015; Hejase et al., 2012; Jamali, Sidani and Abu-Zaki, 2008; Suliman and Al-Shaikh, 2007; El-Chaarani, 2013; Geha, 2015). Wisker and Poulis (2015) suggested having a further research to study the effect of EI on marketing/sales performance, and identifying which of EI constructs affect the workplace performance. They have also suggested including variables such as personal characteristics, firm structure and industry characteristics when linking emotional intelligence to marketing/sales performance. This paper has included the exhibited behavioral attributes which relies on personal characteristics.

From a specifically Lebanese perspective, Hejase et al. (2012) added that although EI is perceived to be effective in organizations and will help in creating better outcomes, the majority of people are not willing to engage emotions and emotional intelligence in the workplace since they believe that emotions in business will lead to irrationality and unexplained behaviours and decisions. In the same vein, studies conducted by Jamali, Sidani and Abu-Zaki (2008) and Suliman and Al-Shaikh (2007) within Middle Eastern countries, including Lebanon, suggest that even though emotions cannot be separated from a person when conducting business and is part of the individuals' personality whether the organization accepts that or not, many are still caught with the traditional saying of "leaving emotions at home before coming to the job".

El-Chaarani (2013) has also studied the concept of emotional intelligence in Lebanese family firms. Although the concept of EI was explored in a completely different field than the one researched in this paper, El-Chaarani suggested to consider exploring this topic qualitatively and from a different angle from that of the research (family firms) since it will positively contribute to the field of EI. El-Chaarani added that other elements/variables should be taken into consideration, such as demographic characteristics and analyze how culture and education (through EI) can influence the job performance. Hence, El-Chaarani highlights the link between culture, emotional intelligence and job performance, which is affected by the customer relationship marketing.

Hejase et al. (2012) suggested to study cross-multiple relationships between different concepts such as EI and other concepts – to marketing, such as customer relationship marketing – and/or to management for example to discover a possible theoretical link that businesses can benefit from as they implement EI in their organizations.

Geha (2015) has stated: "Emotional intelligence training may be one way to bring opposing elements together. This is especially important to the Lebanese community with its diverse

backgrounds, religions, political groups and people. It is my opinion that emotional intelligence skills should be introduced at all levels and to all people within Lebanon." (p. 23)

### Conceptual Framework of Emotional Intelligence

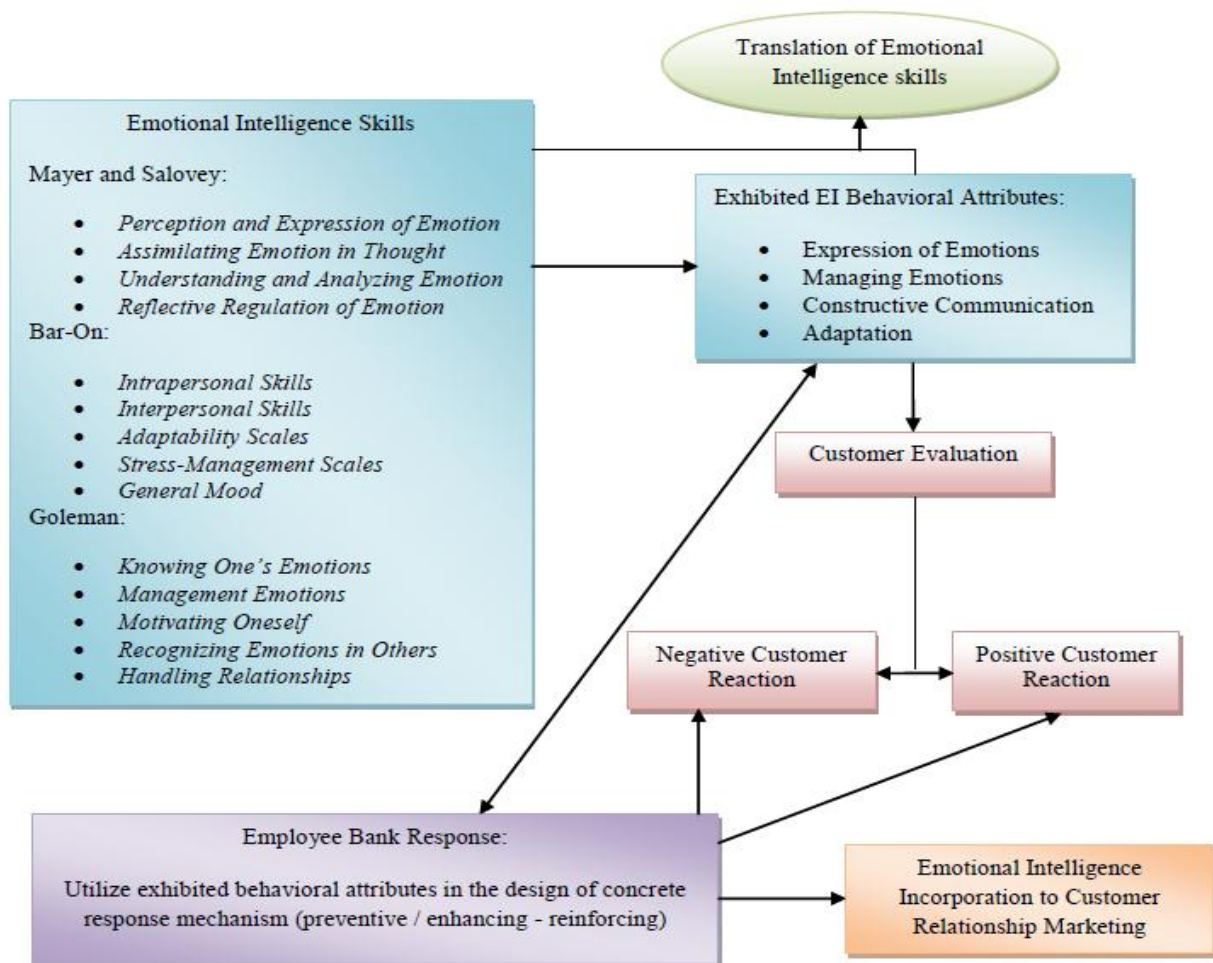

Figure 1: Framework of emotional intelligence for the Lebanese retail banking sector

#### Discussion of the Conceptual Framework

This framework links customer relationship marketing and emotional intelligence skills by adding a twist by translating emotional intelligence skills into exhibited behavioural attributes based on the stimulus-response and MARS model of individual behavior so that it is possible for the Lebanese retail bank customers to evaluate whether these skills are being implemented properly. Customers' evaluation of bank employees' exhibited emotional intelligence behavioural attributes will result in either a negative or positive customer reaction. Here comes the role of employee bank response, which consists of the design of concrete response mechanism which are: responding quickly, providing appropriate communication, treating customers fairly, cultivating relationships with customers, guarantying the service offering, encouraging and tracking complaints, learning from recovery experiences, learning from lost customers, and making the service fail-safe, and linking them

with the exhibited emotional intelligence behavioural attributes. The following step will result in preventing negative customers' reaction and enhance / reinforce positive customers' reaction. As a result, this process shows how emotional intelligence is incorporated in a successful customer relationship marketing in retail banks (which is the aim of this research paper). Being able to control and manage one's emotions and others will help in creating relationships with customers, which is the main goal of customer relationship marketing. In order to translate emotional intelligence skills into exhibited behavioural attributes, and in order to study customers' negative and positive feedbacks, the concept of organizational behavioural is indirectly used since employees and bank managers need to study, understand and analyze their customers so that they can act and react. Having no knowledge of their customers, will hinder their success by not knowing which strategy to implement and this case is crucial when facing negative outcomes.

This framework of emotional intelligence summarizes the link between emotional intelligence and customer relationship marketing which will serve as a base line model for the empirical work that will follow the proposed framework. This section answers and summarizes research questions one till eight.

### 3. RESEARCH PHILOSOPHY

The 'ontology' and 'epistemology' of the research will adapt the classical interpretive/constructivist ontology and the interpretivism/constructivism epistemology; since they are interrelated. The reason behind choosing the following ontology and epistemology is the nature of the subject researched. Since one of the major concepts discussed is 'emotional intelligence', which is a psychological subject, a researcher needs to implement techniques that will reveal deep and valuable data, usually through interviews, observations, focus groups ect. The researcher, in this case, will take part in the interviews and hence it will mark as a subjective research.

As for the paradigm, it is expected, based on the ontology and epistemology chosen, that the research will implement the 'interpretivist paradigm' as well as the 'constructivist paradigm'; the research paradigm, which is interpretivist/constructivist, is also labelled 'anti-positivist' (Hatch and Cunliffe, 2006) and 'post-positivist' (Blaikie, 1993). Another terminology used for an interpretivist phenomenology is Heideggers' 'hermeneutic (interpretivist) phenomenology'; which is originated from Husserls' 'descriptive phenomenology'. Saunders, Lewis and Thronhill (2007) stated that such a paradigm focuses on studying and analyzing 'social actors' and understand how they perceive the world. Hence, an interpretivist/constructivist paradigm is highly contextual and results cannot be generalized.

*Research Methodology and Methods*

Given that the phenomenological paradigm adapted is subjective in nature, it is best to use the qualitative approach to gather data. An exploratory case study is chosen to uncover significant variables and analyze the topic of study in the Lebanese context.

The researcher will implement two approaches, 1. Deductive – in order to extract the major emotional intelligence skills and exhibited behavioural attributes based on the literature review (secondary data); and 2. Inductive – to uncover the results of having positive and negative outcomes of implementing the suggested exhibited behavioural attributes from the consumer's perspective (primary data).

The concepts of 'reliability' and 'validity' are interrelated since validity relies on reliability. These concepts differ from a qualitative to a quantitative research. In a qualitative research reliability is measured by 'quality' of the study although the concept of reliability is commonly used in quantitative research. These concepts aim at differentiating a 'good' from a 'bad' research and should be judged based on the research paradigm adapted. Data gathered from Lebanese retail bank customers requires validity and reliability; which made it the main reason to conduct this study from the customers' perspective rather than the bank employees'.

Having in-depth, open-ended, semi-structural interviews helps in collecting more valuable data, understanding the situation realistically and maybe uncovering some hidden gaps that are not stated in existing research papers. This technique gives the interviewer the advantage of being able to remodel and restructure the questions when needed and also gives the interviewee the ability to better understand the aim of the study by familiarizing the latter with the concept of emotional intelligence.

However, before conducting interviews with Lebanese retail bank customers, a pilot test consisting of two to three questions will be implemented to make sure that the research is on the right path and hence the interviews will lead to valid and reliable results. Conducting a 'pilot study' before the main interviews is crucial to guarantee the success of the data gathering process. This study is considered a trial in preparation for the major study. A pilot study does not ensure the success of the research; however, it does increase the likelihood.

Interviews will be audio-recorded, transcribed and reviewed. At the end of each interview, critical incidents studies method will be implemented to uncover stories holding relatable variables that were not taken into consideration when studying the relationship between the customer and bank employees from the customer relations marketing perspective.

There will be, in total, 30 interviews. However, in case the research did not reach maturity after carrying out 30 interviews, additional interviews are a must till reaching maturity. The distribution of interviews process is based on the percentages of distributions of Lebanese retail banks, geographically.

A purposeful sampling will be used in order to gather reliable data for this research; hence, the *purposeful sample* in this research is the Lebanese retail banking customers who are in direct contact with customer service bank employees. Being into a service domain such as banking means relying heavily on personal interaction between bank employees and their clients which makes it easier for bank customers to evaluate the suggested behavioural attributes of emotional intelligence; hence, results gathered from interviews and critical incident studies are expected to be reliable.

Data gathered from interviews will be analyzed using the 'qualitative content analysis' which shares some steps with the traditional 'quantitative content analysis' procedure, in addition to the NVivo software - which is specialized in analyzing in-depth interviews through highlighting the most important messages/factors/findings after linking and relating/combining the gathered information and consequently the final framework will be constructed. As data is gathered and analyzed, it will uncover any possible effect of the Lebanese culture on emotional intelligence.

Throughout the research, the researcher might suggest that there is a need for additional implementation of qualitative research techniques such as focus groups. The following suggestion depends on the reliability, quality and completeness of the data gathered through the interviews.

#### 4. CONCLUSIONS AND IMPLICATIONS

The importance of emotional intelligence in organizations lays in its significant overall performance improvement through generating more sales and profits as well as satisfying clients and customers. Existing EI models created by Goleman, Bar-On and Mayer & Salovey, were adapted to set the overall EI skills which were translated into exhibited behavioural attributes using a number of models. These behavioural attributes are to be tested and evaluated by Lebanese retail bank customers. Both negative and positive customer outcomes are treated using service encounter models: Customer Complaint Actions Following Service Failure and Service Recovery Strategies. The conceptual framework created aims incorporate EI skills with effective implementation of CRM skills; laying the groundwork for further refinement, testing and elaboration through research and analyses.

##### *Theoretical Implications*

Creating a framework that studies emotional intelligence from the customer's perspective through the utilisation of suggested exhibited behavioural attributes and linking it to relationship marketing skills and service marketing in the Lebanese context was never done before. This research seeks to satisfy the aims and objectives that are set, and to study empirically the Lebanese market to create a preliminary framework of emotional intelligence that is customized for the Lebanese retail banks.

##### *Managerial Implications*

The theoretical understanding of the role of emotional intelligence in the sector has significant practical implications as well. The research, in fact, through its framework, shall prescribe actions at all organisational levels towards the utilisation of the knowledge gained for managerial implementation in the contexts of human resource management, customer relationship marketing and service design. Ultimately, the findings of the research shall contribute to the banks' improvement in the aforementioned contexts with direct and explicit benefits in terms of profitability and growth.

## REFERENCES

- Al Khoury, G., Thrassou, A., Kaufmann, H.R. (2016), "Emotional Intelligence in the Banking Sector – the Case of Lebanon", Proceedings of the 9th Annual Conference of the EuroMed Academy of Business entitled Innovation, Entrepreneurship and Digital Ecosystems, Cyprus: EuroMed Press (ISBN: 978-9963-711-43-7).
- Al Khoury, G., Thrassou, A., Kaufmann, H.R. (2017), "Utilisation of Emotional Intelligence in the Retail Banking Sector – A Preliminary Model for Lebanon" – preliminary acceptance by the special edition GBER Journal entitled: "Innovation and Entrepreneurship: Theoretical and Practical Perspectives in Small and Medium Enterprises" – paper under review.
- Blaikie, N. (1993), *Approaches to Social Enquiry*, 1st edition, Polity Press, Cambridge.
- Danquah, E. (2014), "Analysis of the impact of emotional intelligence on organizational performance: A banking perspective", *British Journal of Marketing Studies*, Vol.2 No.3, pp. 34-50.
- El-Chaarani, H. (2013), "Exploring the dimensions of emotional intelligence in the Lebanese family firms", *International Journal of Business and Economic Development*, Vol. 1 No. 2, pp. 101-111.
- Geha, M. (2015), "Emotional Intelligence in Leadership and Management", *Lebanese National Defense*, No. 91, pp. 5-27.
- Hatch, M. J. and Cunliffe, A. L. (2006), *Organization Theory*, 2nd edition, Oxford University Press, Oxford.
- Hejase, H.J., Al-Sayed, S., Haddad, Z. and Hamdar, B. (2012), "Applying Emotional Intelligence in Lebanon: An Exploratory Study", *Universal Journal of Management and Social Sciences*, Vol. 2 No. 6, pp. 13-35.
- Jamali, D., Sidani, Y. and Abu-Zaki, D. (2008), "Emotional intelligence and management development implications: Insights from the Lebanese context", *Journal of Management Development*, Vol. 27 No. 3, pp. 348-360.
- Jesri, P., Ahmadi, F. and Fatehipoor, M. (2013), Effects of Relationship Marketing (RM) on Customer Loyalty (Case Study: Mehr Bank, Kermanshah Province, Iran), *interdisciplinary journal of contemporary research in business*, Vol. 4 No. 11, pp. 304-312.
- Kearney, T., Walsh, G., Barnett, W., Gong, T., Schawbe, M. and Ifie, K. (2017), "Emotional intelligence in front-line/back-office employee relationships", *Journal of Services Marketing*, Vol. 31, No. 2, pp. 185-199.
- Kotler, P. and Kotler, N. (1999). Political marketing: generating effective candidates, campaigns, and causes. In Bruce I. Newman (ed.) *Handbook of political marketing*. Thousand Oaks, CA: Sage Publications, pp: 3-18.
- Larsen, R.J., Diener, E. and Lucas, R.E. (2003), "Emotion: Models, Measures, and Individual Differences", in *Emotions in the Workplace*, ed. Lord, R.G., Klimoski, R.J. and Kanfer, R. (San Francisco: Jossey-Bass, 2002), pp. 64-113; Russell, J.A. "Core Affect and the Psychological Construction of Emotion," *Psychological Review*, Vol. 110 No. 1, pp. 145-172.
- McShane, S. and Von Glinow, M.A. (2009), *Organizational Behavior: emerging knowledge and practice for the real world*, 5th edition, McGraw-Hill/Irwin, New York, NY.
- Saunders, M., Lewis, P. and Thornhill, A. (2007), *Research Methods for Business Students*, 4th edition, Prentice Hall Financial Times, Harlow.
- Sternberg, R.J. ed., (2000), *Handbook of intelligence*, Cambridge University Press, Cambridge, UK.
- Suliman, A.M. and Al-Shaikh, F.N. (2007), "Emotional intelligence at work: Links to conflict and innovation", *Employee Relations*, Vol. 29 No. 2, pp. 208-220.
- Tudor, M. (2015), "Particularities of Emotional Intelligence in Healthcare, Banking and Education", Proceedings of the 9th International Management Conference "Management and Innovation for Competitive Advantage", November 5th- 6th, Bucharest, Romania, pp. 555-562.
- Wisker, Z.L., Poulis, A. (2015), "Emotional Intelligence and Sales Performance. A Myth or Reality?", *International Journal of Business and Society*, Vol. 16 No. 2, pp.185 – 200.



- Yaghoubi, N.M., Doaee, H. and Ardalan, A. (2011), "The Effect of Emotional Intelligence on Relationship Marketing", *Interdisciplinary Journal of Contemporary Research in Business*, Vol. 3, No. 5, pp. 901-905.
- Zeithaml, V., Bitner, M. and Gremler, D. (2013), *Services Marketing—Integrating Customer Focus across the Firm*, 6th edition, McGraw-Hill, New York, NY.
- Zhang, Y. and Wildemuth, B. M. (2009), "Qualitative analysis of content", In B. Wildemuth (Ed.), *Applications of Social Research Methods to Questions in Information and Library Science* (pp. 308-319). Westport, CT: Libraries Unlimited.

## SOCIAL ENTERPRISES AS DRIVERS OF LOCAL DEVELOPMENT: A FRAMEWORK

Andreottola, Francesco<sup>1</sup>; Massaro, Maria Rita<sup>2</sup>

<sup>1</sup>National Research Council of Italy, Institute for Research on Innovation and Services for Development (IRISS-NCR), Naples, Italy

<sup>2</sup>Dept. of Business Systems and Operations, University of Bedfordshire Business School, Luton, UK

### ABSTRACT

The social enterprises (SE) are taking hold as key players in the processes of local development producing social, economic and environmental effects (Borzaga, Tortia, 2009; Borzaga, Galera, 2014; Eversole, 2013). Since SEs may assume a range of different organisational forms and despite the fact they are commonly spread across many countries, there is not any agreement on a unique and common definition yet (Doherty et al., 2014; Phillips et al., 2015; Picciotti, 2013). Certainly, SE's objective is to pursue a social goal, but they can also act as drivers of local development, supporting the local community growth and its economic development.

Empirical research shows that across Europe SEs not only increase the community wellbeing, providing product and services, fostering cohesion and collaboration among community members and institutions, but they also act as drivers of local and regional economic development (Birkhölzer; 2009; Eversole, 2013).

This paper aim is to provide an ideal-type model of SE which can help in drawing its boundaries; secondly, a new framework on how SEs produce local development through social, economic and environmental outputs is proposed.

*Keywords: social enterprise, local development, social development, economic development, environmental development*

### INTRODUCTION

The expression 'social enterprise' (SE) was introduced in Italy during the late '80s to mean a new form of company run by volunteers; differently from the non-profit organization focused on the promotion of human rights, the aim of a SE was to provide social services to the local communities or promoting equality and opportunities. Subsequently, the concept of SE was developed during the '90s and spread across Europe and United States and, more recently, even across Asia and Latin America while gaining relevance among academics and practitioners. The growing interest in SEs depends on many factors; firstly, SEs operates not for profit, but for promoting social change and growth and posing new

priorities within the debate on the social and economic development; secondly, with government and local public institutions experiencing the decrease of financial resources to be dedicated to social services, the SEs address the people's needs, reorganising proactively the existing welfare systems. Thirdly, the SEs are a trigger to re-think the efficiency and efficacy of public sector and to urge companies to consider the social responsibility. Against the scientific growing interest (Doherty, Haugh, Lyon, 2014; Phillips, Lee, Ghobadian, O'Regan, James, 2015) there is still a lack of a unique and common definition of what the SE is; a variety organisations, institutions and firms with different legal and organisational forms seem to be included in the definition of SE; as such there is a compelling need to seek a consistent and shared definition which could encompass all the varieties of existing SEs. The following section 2 attempts to isolate the SEs' main features drawing an SE ideal-type; in section 3 a new framework on the relation among SE and local development is proposed.

## **SES: DEFINITION AND FEATURES**

The SE has a hybrid structure as it combines a variety of elements featuring different types of companies; however, SE construct does not fit in any of the traditional existing corporate forms. At the heart of SE construct there is its 'social mission'. In the literature on social entrepreneurship two main approaches can be distinguished: the first emerged from the American studies and the second from the European researchers (Perrini, 2007; Defourny, Nyssens, 2010). The American works, which have been emphasizing the role of the social entrepreneurship since the middle of the 90s (Borzaga, Tortia, 2009), focus more on the nature and the characteristics of the 'social entrepreneur' than showing interest in deepening the understanding of the SE nature. In fact, within this stream, some works look into the capacity of the non-profit organisations (NPO) to acquire financial resources while other studies investigate the role of the social entrepreneur as a 'social innovator' and promoter of the social change. Hence, any organisation led by a social innovator and creating social value is a social enterprise (Picciotti, 2013). In this context, the SE can assume any organizational form among profit, not-for-profit or hybrid, the choice depends on the business model and the social aim to reach: the entrepreneur's ability to create the best hybrid structure boosts the organizational efficacy and efficiency. As a consequence, the SE become an innovation lab where new organizational behaviours, new cognitive and managerial models take place and guide the identification and satisfaction of the community's needs using a mix of public and private local financial resources (Bulsei, 2015).

On the other hand, due to the different cultural context and to the different economic situation in which the 'social cooperative' were born and largely developed, the European literature focused prevalently on the nature of SE.

The European approach is summarized by the Research Network “Emergence of Social Entrepreneurship in Europe (EMES)” (Borzaga and Defourny, 2008) while the GES model proposed here (Table 1) is derived from existing research (Galera and Borzaga, 2009; Galera and Borzaga 2012) on the SE and takes also in consideration the OCSE and EU’s definitions of SE. This model plots out the SE main features and helps in drawing its boundaries. The SE can be observed and evaluated through its governance, entrepreneurial and social dimensions (GES). The GES model depicts an ideal type, as such it does not represent an existing SE but stresses all the features common to the most. Each SE dimension can be evaluated not only by the presence or absence of the following characteristics, but even on their intensity.

Table 1 | *GES framework: defining the nature of SE*

Dimensions	Characteristics
Governance	Self-governance or high-autonomy Multi stakeholder Democracy Limitation to the distribution of profits
Entrepreneurial	Regular production and delivery of services and goods Totally or partially paid workforce Presence of economic risk Propensity to innovate
Social	Social aim Volunteers

## THE SES AND LOCAL DEVELOPMENT

After the 2007 economic turmoil, the demand for social goods and services has grown while the offering from public institutions has decreased, due to the lack of financial resources; in this gap, there are unexploited opportunities for private investments. Several empirical studies suggest that SE can play a key role to cope with the challenges of the local development: they have been successful especially in those sectors in which were missing the support of public institutions. Actually the social entrepreneurship has been able to develop unconventional strategies to address the needs of underdeveloped areas; for example, Borzaga and Galera (2014) describe the significant role SEs had in Africa providing new micro-credit services, contributing to the construction of infrastructures through the deployment of local resources; even in Europe SE are an important engine for the economic development of local communities: the UE Third System and Employment reports there are 8.88 millions of employees in this sector, confirming that SEs are not a marginal phenomenon, but on the

contrary, is a well-established reality. According to Eversole (2013), the SE has an intrinsic natural tendency for the local development as these institutions naturally foster the community development.

«The observation that social enterprises are hybrid organisations that blur sectoral boundaries is established in the literature. What is new is the observation that social enterprises are working in this way as an intentional strategy for achieving local development outcomes» (Eversole, 2013: 576).

According to the theory of the endogenous economic growth (Aghion and Howitt, 1998), the driving forces of the local development lie in internal local resources as human capital, culture and traditions, artisanal artefacts or networking capabilities of local institutions; hence, the SE represents a well-fitted gear of the system as its primary aim is not the exclusive production of goods or return on investments, but the development of social capital, human relationships, network and overall the community wellbeing; furthermore the set of resources used by SEs are prevalently those found in the local context; “In this sense, social enterprises can represent an important instrument for an endogenously driven process of development» (Borzaga and Tortia, 2009: 209).

Obviously, SEs cannot entirely drive by themselves the community full development; although, compared with the profit-oriented companies, the SE benefits from the community higher trust and support; its potential can be expressed only if reinforced by adequate policies such as dedicated financial funds, training programme for social entrepreneurs and managers, research on innovative governance and new business models.

Adopting the endogenous growth theory perspective, the links between SE and the local development can be represents as shown in Figure 1.

Figure 1. *SE and local growth*

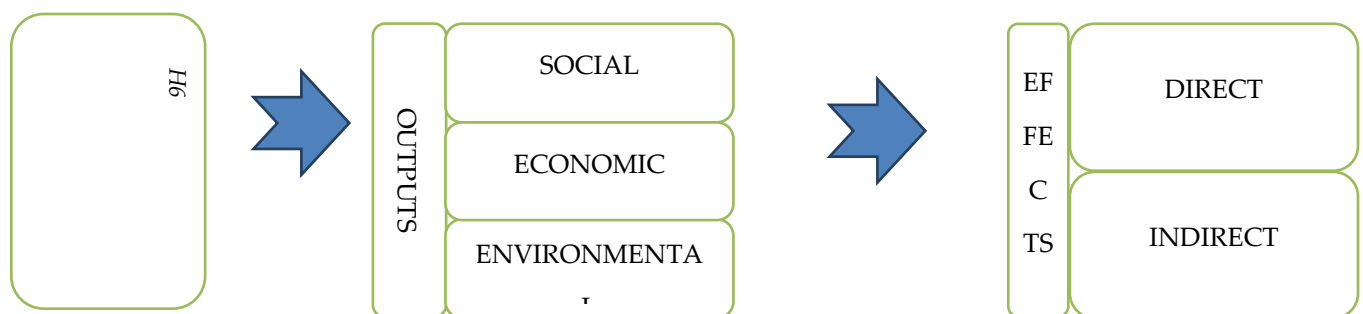

The SE produces social, economic and environmental outputs; in turn, these outputs creates direct and indirect effects on the local development.

The directs and indirect benefits are:

- *job creation*: SEs do not replace existing job positions with new roles, but address unmet social needs creating additional jobs especially for those who normally are denied access to work;

- *poverty reduction*: SEs often offer jobs to the low-income population and deliver goods and services at more affordable prices, or for free;
- *community wellbeing*: SEs contribute to uplift the local population standard of living and, despite employees perceive lower salaries, this is compensated by higher personal satisfaction and wellbeing in the working environment;
- *social capital*: social entrepreneurial activities create social value and social capital building relationship based on trust among individuals and organisations, promoting a cooperation culture among institutions; these links facilitate the exchange of tacit knowledge and reducing the asymmetric information problems.
- *social cohesion*: through the social capital, the terms for individuals and groups to take part in society are improved, hence stronger ties, sense of belonging and inclusion of poor and marginalized people helps people in cooperating to set and achieve community goals.

## LIMITATIONS AND FURTHER RESEARCH

SEs are a potential engine of the local development; they can play a key role in the most marginalized and poorest regions which are perceived as unprofitable markets by profit-oriented enterprises and cannot be supported by the governments and local authorities due to their lack of resources.

Basing on the previous literature, this work pinpointed the SE's main features depicting its ideal-type through the GES model. Subsequently, a new framework which points out the effects that SE has on local development was presented (section 3). The main limitations of the framework is in the fact that was drawn upon the existing qualitative research mainly consisting of case studies, while quantitative research on the topic is still scant. Hence the need for deepening the understanding of this phenomenon and the call for more quantitative research in the field of SE. In details, further evidence is needed on the followings:

- Are the SEs able to be financially self-sufficient on the long term, without dropping their social aim?
- Are SEs efficient and efficacious in the use of public financial and local resources?
- What are the contextual factors which foster the social entrepreneurship?
- What can be valid and reliable measurement of their social and environmental impact?
- Is the economic crisis or a profounder shift in the economy in determining the flourishing of SEs?

## REFERENCES

Aghion, P., Howitt, P., Brant-Collett, M., & García-Peñalosa, C. (1998), *Endogenous growth theory*, MIT Press, Cambridge, MA.

- Birkhölzer K. (2009), *The Role of Social Enterprise in Local Economic Development*, paper presentato alla EMES International Conference on Social Enterprise, 1-4 luglio, Trento, pp. 1-25.
- Borzaga, C., Defourmy, J. (2001), *The Emergence of Social Enterprises*, Routledge, London.
- Borzaga, C., Galera, G., (2014), *The Potential of the Social Economy for Local Development in Africa: An Exploratory Report*, European Union.
- Borzaga, C., Galera G., (2012), "The concept and practice of social enterprise. Lessons from the Italian Experience." *International Review of Social Research*, Vol. 2, No 2, pp. 85-102.
- Borzaga C., Tortia E. (2009), "Social Enterprises and Local Economic Development", in Noya A. (a cura di) *The Changing Boundaries of Social Enterprise, Local Economic and Employment Development (LEED)*, OECD Publishing, Paris, pp. 195-228.
- Bulsei G. (2015), *Un'altra economia è possibile? L'impresa sociale tra scenari globali e reti locali*, paper presentato al Colloquio scientifico sull'impresa sociale, 22-23 maggio, Reggio Calabria, pp. 1-16.
- Defourmy J., Nyssens M. (2010), "Social enterprise in Europe: At the crossroads of market, public policies and therid sector", in *Policy and Society*, n. 29, pp. 231-242.
- Doherty, B., Haugh, H., Lyon, F. (2014), "Social Enterprises as Hybrid Organizations: A Review and Research Agenda", in *International Journal of Management Reviews*, vol. 16, pp. 417-436.
- Eversole R. (2013) *Social enterprises as local development actors: Insights from Tasmania*, in *Local Economy*, vol. 28(6), pp. 567-579.
- Galera, G., Borzaga, C. (2009), "Social enterprise: An international overview of its conceptual evolution and legal implementation." *Social Enterprise Journal* 5.3 (2009): 210-228.
- Perrini F. (a cura di, 2007), *Social entrepreneurship. Imprese innovative per il cambiamento sociale*, EGEA, Milano.
- Phillips, W., Lee, H., Ghobadian, A., O'Regan, N., James, P. (2015), "Social Innovation and Social Entrepreneurship: A Systematic Review", in *Group & Organization Management*, vol. 40(3), pp. 428-461.
- Picciotti A. (2013), *L'impresa sociale per l'innovazione sociale. Un approccio di management*, Franco Angeli, Milano.

## THE IMPACT OF PUBLIC RESEARCH ON INDUSTRY INNOVATION: A TECHNOLOGY-LEVEL PERSPECTIVE IN THE GREEN ENERGY FIELD

Ardito, Lorenzo; Petruzzelli, Antonio Messeni; Albino, Vito

Politecnico di Bari, Bari, Italy

### ABSTRACT

This paper examines the degree to which companies successfully build on technologies developed by public research organizations (PROs) by analysing the influence of their technology attributes. Specifically, four technology attributes have been considered as (i) the level of establishment, (ii) the scope of application, (iii) the scientific nature, and (iv) the technological breadth. We develop hypotheses, and the green energy field is in the focus of this study this phenomenon. Accordingly, 4,363 patents registered by PROs in the period 1976-2011 and classified into the technology fields “Alternative energy production” and “Energy conservation” were collected. Results of the Tobit regression reveal that the level of establishment has a positive influence on subsequent industry innovation efforts; only when the level of establishment becomes excessively high this effect turns negative. Furthermore, the scope of application and the technological breadth positively impact the spread of public environmental technologies among companies, whereas the scientific nature has a negative effect.

### Highlights:

- The role of public research as a mean to boost industry innovation efforts is analysed
- Attributes of technologies developed by public research organizations are considered
- The attributes of public technologies impact subsequent industry innovation efforts

*Keywords: Green energy technologies, Industry innovation, Public research, Technology attributes, R&D policy.*

## 1. INTRODUCTION

Studies rooted in the neoclassical economic theory highlighted that private R&D efforts are subject to market failures, which are reflected in three main issues: increasing returns, knowledge leakage, and uncertainty of results (e.g., Arrow, 1962; Czarnitzki and Lopes-Bento, 2013). These issues make the private value of R&D lower than the social one. Thus, less incentive exist for firms to invest



in technology development, hence leading to a suboptimal level of industry innovation efforts (Arrow, 1962; Czarnitzki and Lopes-Bento, 2013).

Governments have attempted to correct for market failures by funding public research organizations (PROs) (e.g., universities, public research centres, governmental organizations) aimed at conducting the initial R&D efforts that may expand the pool of technological knowledge available to firms who can draw on this for subsequent innovation activities (Cohen et al., 2002; Martin and Tang, 2007). However, according to the evolutionary approach to the economics of publicly funded research, making available new technologies does not imply that outcomes of public research will boost further innovation efforts by the industry. Notably, firms are not always willing and/or able to build on public research because of its weaker connection to market needs or the lack of firms' absorptive capacity (Cohen and Levinthal, 1990; Salter and Martin, 2001). In fact, it has been argued that research outcomes of PROs fall short of the full impact they could have, so governments still seek to improve the effectiveness with which they invest public money to produce research externalities towards the industry sector (Beise and Stahl, 1999; Bornmann and Marx, 2014). This means that the question of when R&D efforts of PROs impact industry innovation activities by rendering outcomes as the basis for the innovation activities of many companies has not completely been answered (Alkemade et al., 2011; Coccia and Rolfo, 2008; Cohen et al., 2002). The present paper addresses this topic. Thus, differently from most of the prior research, we do not focus on the public incentives that may stimulate private R&D (R&D tax credits, R&D subsidies, etc.) (e.g., Czarnitzki and Lopes-Bento, 2013). Rather, we aim to assess when multiple companies build upon the technological knowledge underlying technologies created by PROs, hence stimulating industry innovation. Accordingly, to the best of our knowledge, this has remained an underdeveloped area of research.

In detail, since the evolutionary economic theory recognized that not all the technical solutions developed by the public sector automatically affect the industry sector, we attempt to understand which types of technology more likely set the basis for firms' innovation activities. Notably, technologies are not all equal, and, depending on their attributes, they may be more (or less) attractive to firms (Chen et al., 2011; Shane, 2001). According to the forgoing discussion, the main research question of this study is: do technology attributes explain the degree to which public research has an impact on industry innovation? We investigate this issue into the green energy field since it has been found that government technologies in this domain does not always have a stronger impact than non-government ones (Popp, 2006). Moreover, it is one of the most pollutant sectors, but with the highest chances of improvement (Hoppmann et al., 2013). As a consequence, the current political debate strongly relates to how public environmental research may further sustain the development and

implementation of green technologies by the industry, particularly referring to the energy sector (e.g., Hoppmann et al., 2013; OECD, 2012).

We develop hypotheses and, to test them, we relied on 4,363 patents registered by PROs during the period 1976-2011 and classified into the “Alternative energy production” and “Energy conservation” technology fields, according to the International Patent Classification (IPC) Green Inventory (Albino et al., 2014). After reviewing existing literature on technology attributes (e.g., Chen et al., 2011; Messeni Petruzzelli, Natalicchio, et al., 2015; Messeni Petruzzelli, Rotolo, et al., 2015; Nerkar and Shane, 2007; Shane, 2001; Sohn et al., 2013), four characteristics have been considered in this study, namely (i) the level of establishment (Ardito, Messeni Petruzzelli and Panniello, 2016), (ii) the scope of application (Novelli, 2015), (iii) the scientific nature (Narin et al., 1997), and (iv) the technological breadth (Messeni Petruzzelli, Rotolo, et al., 2015). Results of the Tobit regression reveal that the level of establishment of public environmental technologies has an inverted U-shaped effect of on the degree to which the industry sector builds on those solutions. Instead, the scope of application and technological breadth positively impact the spread of public environmental technologies among companies, whereas the scientific nature has a negative effect.

These results allow us to contribute to current debate on when publicly funded research can stimulate additional R&D efforts by industry (Coccia and Rolfo, 2008; OECD, 2006), with a specific focus on the outcomes of public environmental research, which is more and more important to promote economic growth and address environmental issues at the same time (Alkemade et al., 2011). Furthermore, we also provide an alternative perspective to evaluate the impact of public research to society, which is a difficult undertaking for governments, but it is needed to better design funding policies (Bornmann and Marx, 2014).

The reminder of the paper is structured as follows. Section 2 presents the theory and hypotheses. Section 3 explains the methodological approach. Section 4 shows the results. Finally, Section 5 provides discussion, implications, limitations, and future research directions.

## **2. THEORY AND HYPOTHESES**

### *2.1. Public research in the green energy field*

Nowadays, one of the most relevant objectives for many governments (e.g., European Union and the U.S.) is reducing human-induced climate change, while avoiding to shrink economic growth (EC/EACI, 2011; OECD, 2012). To achieve this win-win effect, the development of technical solutions that favour wealth creation and concurrently address environmental issues has become of foremost importance (Alkemade et al., 2011; Mowery et al., 2010; Rogge and Reichardt, 2016). Green energy technologies (i.e., alternative energy production and energy conservation solutions) are at the core of

this debate. Indeed, the energy sector contributes to the economic development, and it may provide extremely positive environmental benefits if innovative low-carbon energy technologies are created and diffused (Albino et al., 2014). However, as in the case of innovation in general, market failures often limit companies in the green energy sector to capture the full value of their environmental innovation activities (Mowery et al., 2010). Specifically, these are subject to the so-named double externality problem (Hoppmann et al., 2013). That is, those innovation efforts lead to two types of positive externalities as knowledge creation and environmental benefits; nonetheless, neither the former nor the latter is well captured by market prices (Rennings, 2000). As a result, private R&D efforts for developing green energy solutions are at a suboptimal level, and governments have to compensate for this misalignment (Foray et al., 2012). Accordingly, PROs spending on more eco-friendly energy technologies has drastically risen in the last years to correct for such problem (Albino et al., 2014; Hargadon, 2010). Yet, relevant improvements in the energy system have not been displayed since bringing green energy technologies to mainstream markets, hence realizing substantial changes in the energy system, requires additional innovation efforts by industry (Balachandra et al., 2010; Sagar and van der Zwaan, 2006). According to the foregoing discussion, we address our research question with a focus on the green energy field.

## 2.2. *Technology attributes*

Herein we argue that the attributes of the technologies created by PROs can predict when public research will set the basis for firms' innovation efforts, especially when they operate in technology-intensive industries such as the energy sector. Indeed, technology attributes reflect the opportunities and underlying knowledge base characterizing technical solutions (Shane, 2001). Hence, technology attributes may explain whether and to what extent firms are able and/or willing to rely upon certain types of technology since they come with some expectations for companies regarding the possibility to build on them to drive future innovation activities (Ardito et al., 2015; Nerkar and Shane, 2007; Shane, 2001). Relatedly, it has been proved that technology characteristics are relevant to explain the likelihood of firm formation (Shane, 2001), technology acquisition (Messeni Petruzzelli, Natalicchio, et al., 2015; Sohn et al., 2013), and the commercialization of university (Nerkar and Shane, 2007) and environmental technologies (Chen et al., 2011). Furthermore, some studies revealed that technology attributes affect the technological impact of patents (e.g., Fischer and Leidinger, 2014; Messeni Petruzzelli, Rotolo, et al., 2015; Nemet and Johnson, 2012; Sterzi, 2013) - i.e., the impact of a patent for developing novel patents (e.g., Ahuja and Lampert, 2001) - also in the case of green technologies (Nemet, 2012). In line with this reasoning, we analyse the role of technology attributes in elucidating the impact of public environmental research on industry innovation.

After reviewing extant literature, we identified four attributes that have been more extensively studied to examine innovation phenomena, namely (i) the level of establishment (Ardito, Messeni Petruzzelli and Panniello, 2016), (ii) the scope of application (Novelli, 2015), (iii) the scientific nature (Narin et al., 1997; Novelli, 2015), and (iv) the technological breadth (Messeni Petruzzelli, Rotolo, et al., 2015).

### 2.2.1. *The level of establishment*

Technologies are different with regard to the level of common understanding in the economy (i.e., the level of establishment). That is, certain technologies are more known and their underlying knowledge has been more exploited, which means that they can be considered more established as opposed to nascent (Ahuja and Lampert, 2001; Alnuaimi and George, 2016).

Prior research suggests that established technologies may positively impact subsequent innovation efforts since they provide advantages in terms of organizational learning, recombination opportunities, and market acceptance (Ardito, Messeni Petruzzelli and Panniello, 2016). Indeed, first, established technologies are more codified than novel ones, hence requiring an inferior level of absorptive capacity (Dosi and Nelson, 2010; Heeley and Jacobson, 2008). Thus, it is easier and more cost effective for firms that have not developed the inventions to build on them with fewer risks. Second, a better understanding of a given technology provides firms with more chances to come up with useful recombination opportunities, which then may act as a catalyst for future technological developments (Fleming, 2001; Savino et al., 2015). Third, customers are usually less reluctant towards a technology that they feel to be more familiar (Story et al., 2014). Thereby, the exploitation of established technologies is more legitimated by the operating market.

However, after a certain level of establishment (i.e. when technologies are widely known and adopted), established technologies become commodities and do not represent a valuable resource upon which companies may drive future innovative trajectories (James et al., 2013). Furthermore, a very-well established solution has probably been recombined many times, and the most profitable combinations have been exploited already, so that the costs of searching for new recombination opportunities surpass the benefits of finding additional valuable combinations (Ardito, Messeni Petruzzelli and Panniello, 2016). Finally, when the level of establishment starts to become too high the benefits deriving from market legitimization are outweighed by the impossibility to meet changing customers' demands and stimulate entrepreneurial possibilities (Alnuaimi and George, 2016).

The above arguments suggest that firms might be interested in established technologies, but only up to a certain level of establishment. Thereby, PROs that aim to provide research externalities toward the industry may have greater chances to attract many companies if they continue with the

initial improvement of a certain technology, hence making it more readily available, instead of only providing complete new solutions. This may be particularly relevant in the green energy sector since companies search for a compromise between avoiding radically new innovative activities, due to the double externality problem, and relying on solutions that cannot represent a source of competitive advantage (Hoppmann et al., 2013). Therefore, we expect that:

**H1.** The level of establishment of public technologies has a curvilinear (inverted U) effect on industry innovation.

### 2.2.2. *The scope of application*

The scope of application refers to the extent of different domains a technology relates to, which means that a higher scope reflects a broader set of potential applications (Gambardella et al., 2007; Lerner, 1994). Recent research revealed that non-innovating companies more likely build on technologies with a broad scope compared to innovating ones (Novelli, 2015). Indeed, innovating firms usually fail to protect and exploit broad inventions because they do not have the complementary assets and internal capabilities required to pursue developments across all potential domains in a timely manner (Gambardella and Giarratana, 2013; Rosenberg and Trajtenberg, 2004). Conversely, given the high visibility of broad technologies, many non-innovating companies may come across them during search processes and focus on the domain to which they are more expert or need a specific contribution to solve an ongoing issue (Lee and Lee, 2010; Messeni Petruzzelli, Natalicchio, et al., 2015), hence developing follow-up inventions that substitute the original ones. This implies that if PROs are able to develop technical solutions with a high scope of application, the likelihood that more companies will build on them grow because those solutions cross the search processes of many firms (Novelli, 2015). Moreover, to build on broad solutions, non-innovating firms usually do not have to compete with the innovating organization if it is a PRO and, since they will likely belong to diverse domains, they do not necessarily compete against each other as well, thus increasing the attractiveness of broad solutions. This phenomenon may be accentuated in the (green) energy sector because it relates to multiple domains (e.g., building, transportation, and energy production) (OECD, 2012). Thereby, a number of different companies exist that can come across a green energy solution with a broad scope of application. Thus:

**H2.** The scope of application of public technologies has positive effect on industry innovation.

### 2.2.3. *The scientific nature*

Technologies may differ with regard to the scientific knowledge that has been used for their development; the more the scientific knowledge used the stronger the scientific nature of the technologies (Fischer and Leidinger, 2014). Although the conventional wisdom states that PROs mainly develop more basic and science-based solutions, the changing orientation of PROs towards more applied research has made them not only reliant on basic science (Burhan et al.; Geuna and Rossi, 2011), so the level of scientific knowledge underlying their technologies may vary.

It has been argued that science is an enabler of innovation, in that it opens up novel and useful recombination opportunities that may lead to valuable technological discoveries (Fleming and Sorenson, 2004). This was a major justification for the need of public research (Mansfield, 1991). However, when the goal is to provide research externalities to the industry sector it should be mentioned that firms consider science-based technologies as extremely uncertain (Murray and Stern, 2007). Furthermore, solutions forged in basic science are not ready-made inputs for companies. Indeed, the comprehension of their underlying rationale is more complex than the understanding of solutions not grounded in a scientific knowledge base (Messeni Petruzzelli, Natalicchio, et al., 2015). This issue is further exacerbated by the fact that to understand the scientific logic used in technology development it is necessary to have a link with the scientific communities where more basic solutions are developed, but this link is often difficult to build between PROs and companies given their distance in terms of cognitive capabilities, research objectives, and modus operandi (Brooks, 1994; Bruneel et al., 2010; Gittelman, 2006). Building on these arguments, Gittelman (2016:1584) highlighted that the rise of basic science in medical research was a setback for drug discovery, hence revealing that “a moving frontier in scientific knowledge does not translate to a corresponding advance in technological innovation”. These arguments may also pertain to the green energy field. For instance, in the wind power domain, prior research revealed the failure of the “Big Science” approach over a less science based approach in both the U.S. and Europe (Hendry and Harborne, 2011). Therefore, we contend that:

**H3.** The scientific nature of public technologies has a negative effect on industry innovation.

#### 2.2.4. *The technological breadth*

The technological breadth represents the degree to which the knowledge base of a technology is diversified, thus reflecting a wider search process during its development (Messeni Petruzzelli, Rotolo, et al., 2015). Inventions resulting from broad searches are more likely understood by companies operating in different industries (Banerjee and Cole, 2010). This implies that more companies may build on those solutions. Moreover, the diverse companies that attempt to build on

technologies with a high technological breadth may benefit from a large pool of potential links and associations between various knowledge domains, which leads to more opportunities for knowledge recombination (Maggitti et al., 2013) and, hence, more chances to contribute to technological progress (Fleming, 2001; Messeni Petruzzelli, Rotolo, et al., 2015). These recombination opportunities are particularly relevant to let firms build on green energy technologies. Indeed, Nemet (2012) and Benson and Magee (2014) found that green energy technologies based on multiple knowledge domains more likely set the basis for future technological developments; additionally, Ardito, Messeni Petruzzelli and Albino (2016) showed that those technologies also have a higher breadth of impact. Eventually, we may expect that PROs combining more knowledge domains during their R&D (environmental) processes will come up with inventions of a higher impact on industry innovation. Stated more formally:

**H4.** The technological breadth of public technologies has a positive effect on industry innovation.

### 3. DATA AND METHODOLOGY

#### 3.1. *Industry setting*

As discussed in Section 2, the green energy field is in the focus of our study. Besides the fact that both public and private involvement is relevant (Alkemade et al., 2011; OECD, 2012), additional reasons make this setting as suitable to test the proposed hypotheses. First, despite PROs are usually set to provide scientific knowledge, in this context, their role as technology provider has gained increased importance (Albino et al., 2014; Oltra et al., 2012). Thereby, it is reasonable to adopt a technology perspective in this research. Second, the development of (green) energy technologies involves technological knowledge that spans a long time period and multiple technological areas; furthermore it may origin from both basic and applied research (Benson and Magee, 2014; Guan and Yan, 2016; Nemet, 2012). This provides us with further confidence about the relevance of the analysed technology attributes. Third, patents are widely used to identify and examine green energy technologies (Guan and Yan, 2016; Nemet, 2012; Veugelers, 2012). Moreover, with patent data, it is possible to identify several attributes of patented inventions and the degree to which they have had an impact on subsequent technological developments by means of citations (Kaplan and Vakili, 2015; Messeni Petruzzelli, Rotolo, et al., 2015; Nerkar and Shane, 2007). Finally, many governments have changed the intellectual property policy to increase incentives to patent public research (e.g., the Bayh-Dole Act). Consequently, the rate of PROs patenting has increased (Sterzi, 2013), especially in the

green energy field (Albino et al., 2014; Hargadon, 2010). Thereby, patents can be considered as a reliable information source to conduct our research.

### 3.2. *Data collection*

The first objective of the data collection process was to detect technologies developed by PROs in the green energy field. To this aim, patents registered at the USPTO were employed. Specifically, first, the IPC codes pertaining to the “Alternative energy production” and “Energy conservation” technology fields, as defined by the IPC Green Inventory<sup>1</sup>, were identified (e.g., Albino et al., 2014; Ardito, Messeni Petruzzelli and Albino, 2016). Second, we queried the USPTO database in order to collect all the patents (and related bibliographic information) associated with the identified IPC codes. Third, we excluded all the patents that matched our search criteria but were not registered by a research organization or were applied for after 2011. This second choice was made since our dependent variable is based on a patent’s forward citations (see Section 3.3.1), so more recent patents may not have had enough time to be cited (e.g., Katila, 2002), thus leading to a biased measure. Finally, we investigated websites, reports, and other additional sources that may let us distinguish between patents registered by private and public research organizations. As a result, this procedure yielded a final sample of 4,363 patents developed only by PROs during the period 1976-2011. Our sample includes patents of PROs established in diverse countries such as the U.S. department of Energy, the French Commissariat à l’énergie atomique et aux énergies, the National Research Council of Canada, the Indian Council of Scientific and Industrial Research, and the Taiwanese National Tsing Hua University, which are also among the most patent intensive public organizations.

### 3.3. *Variables*

#### 3.3.1. *Dependent variable*

Cited patents can be considered as the basis of subsequent innovation efforts. Indeed, these are inventions whose technological relevance has been recognized by innovating organizations, which then based part of their innovation activities on those solutions (Kaplan and Vakili, 2015; Messeni Petruzzelli, Rotolo, et al., 2015). Thus, forward citations have been widely considered as a proxy for the impact of patents on subsequent technological developments. In other words, “external citations indicate that other players have internalized part of the knowledge underlying the original invention and succeeded in building on it” (Novelli, 2015:494). In line with this reasoning, we analysed the citations received by the patents in our sample, specifically assessing whether they have been

---

<sup>1</sup> See <http://www.wipo.int/classifications/ipc/en/est/>.



referenced by patents developed by companies. With this procedure, we can analyse if PROs patents have had an impact on industry innovation efforts. More in detail, for each patent in our sample, we identified the citing patents and to whom they belong. Once identified the owners of the citing patents, we distinguished between those registered by companies and those registered by other types of assignee. Finally, after checking for company names, we measured our dependent variable (*IndustryImpact*) as follow:

$$IndustryImpact = 1 - \sum_F \left( \frac{C_{FP}}{C_P} \right)^2,$$

where  $C_{FP}$  indicates the number of times the firm  $F$  has cited the focal patent  $P$ , while  $C_P$  is the total number of citations to patent  $P$  coming from patents owned by firms. This is a Herfindahl-type index based on the generality index proposed by Trajtenberg et al. (1997). Differently, from the generality index, this measure does not account for the diverse technological classes of the citing patents; rather, it considers the diverse firms owing the citing patents. In other words, this index measures the degree of different firms possessing patents that cite a PRO patent. The rationale behind this index is that the greater the variety of firms owing citing patents, the higher the impact of the PRO patent on industry innovation efforts.

Of course, we may have computed this variable as the simple count of diverse firms that own, at least, one patent citing a PRO one. However, in this way, the actual degree to which the PRO patent affects the industry sector would be missed. For instance, suppose that an invention received 15 citations equally distributed among patents owned by companies A, B, and C, respectively. Moreover, suppose that a second invention still received 15 citations, but 13 of them are from patents owned by company A, one citation is from company B, and one citation is from company C. In this case, the first invention actually had a wider impact on the industry as opposed to the second one, which had an impact mainly on company A. However, if we adopted a count measure for *IndustryImpact*, its value would be the same for the two inventions (three). Differently, using the Herfindahl index, *IndustryImpact* would be 0.88 for the first invention and 0.24 for the second invention. This better reflects that the two inventions have impacted industry innovation efforts in a different way, with the first invention reflecting a wider impact.

Furthermore, since this study covers a long time period and there may be a bias towards older patents in terms of forward citations, we are confident that our measure is still reliable for the following reasons. First, the most recent patents in our sample were filed for in 2011, with forward citations collected through the end of 2016. Hence we captured all the citations received, at least, five years after patent application, which is considered the time span when patents gets most of their citations (e.g., Ardito, Messeni Petruzzelli and Albino, 2016; Griliches, 1987; Katila, 2002; Nooteboom

et al., 2007). Second, we included time period effects in our models to account for systematic intertemporal differences (Capaldo et al., 2017) (see Section 3.3.3).

### 3.3.2. Independent variables

The first independent variable measures the extent to which a technology is established (*Established*). It is computed as the natural logarithm of the number of a patent's backward citations. The logarithmic transformation was adopted to correct for skewness and kurtosis. The rationale behind this measure recalls previous studies arguing that the higher the citations made by a focal patent the higher the level of establishment (e.g. (Ahuja and Lampert, 2001; Ardito, Messeni Petruzzelli and Panniello, 2016; Nerkar and Shane, 2007; Ziedonis, 2007). Indeed, based on the fact that a technology is often the result of a cumulative process over a technological trajectory (Dosi, 1982; Dosi and Nelson, 2010), it can be assumed that patents referring to a high number of previous patents reflect inventions with a stronger link to a well-established technological paradigm (Dornbusch and Neuhäusler, 2015; Martinelli, 2012). Conversely, a small number of backward citations signal that the patent is disconnected from previous technical solutions, thus highlighting its novel nature (Ahuja and Lampert, 2001; Ziedonis, 2007). Second, following well-known research, we operationalized the scope of application (*Scope*) as the number of different three-digit U.S. classes assigned to each patent by the USPTO (Lerner, 1994; Novelli, 2015). Third, to account for the scientific nature of the knowledge underlying a patented invention (*Scientific*), as made by previous studies, we counted the number of patent references made to non-patent documents (Callaert et al., 2006; Narin et al., 1997). Since also this variable was skewed and kurtotic, logarithmic transformation was also used in this case. Finally, to assess the breath of the technological base upon which a patent is built (*TechBreadth*), we adopted the Trajtenberg et al. (1997)'s originality index. It is computed through a Herfindahl index measuring the diversity of technological classes assigned to the patents cited by a focal patent. Specifically,

$$Technological\ breadth = 1 - \sum S_{ij}^2,$$

where  $S_{ij}$  refers to the fraction of patents cited by patent  $i$  that belong to the three digit U.S. class  $j$  out of  $n$  technological categories assigned to the patents by the USPTO.

### 3.3.3. Control variables

Several control variables were considered to improve the reliability of our analyses. First, we controlled for the duration of the patent examination process (*Duration*), measured as the difference, in years, between the filing and issue date (Nemet, 2012). Second, a dummy variable assessing whether a patent has been jointly developed by more organizations was included (value one) (*Joint*) (Messeni

Petruzzelli, Rotolo, et al., 2015). Third, we controlled for the number of patent claims (*Claims*) (Novelli, 2015). Fourth, we accounted for the number of inventors that have been involved in the invention process (*TeamSize*) (Messeni Petruzzelli, Rotolo, et al., 2015). Fifth, a patent may attract companies' attention whether it has also been published in other patent offices and whether the innovating organization has been willing to pay renewal fees. Therefore, we took into account the number of patent offices (besides the USPTO) where the patent has been registered (*PatFamily*) and if the renewal fees of the patent have been paid at least once (*Renewal*) (Fischer and Leidinger, 2014). Sixth, we distinguished PROs between universities, governmental organizations (e.g., the U.S. Department of Energy), and other public research centres (e.g., national research councils), each of which resulted in a dummy variable. Thus, we included two dummies (*dummy PRO*) to control for the different types of PRO. Seventh, we also included dummy variables to control relevant time period effects (*dummy period*). Following Ardito, Messeni Petruzzelli and Albino (2016), four time periods related to the energy sector were considered: 1976-1987, 1988-1997, 1998-2002, 2003-2011. We omitted the dummy PRO "university" and the dummy period "2003-2011". Finally, we added a dummy variable assessing if the PRO owing a patent is U.S. based (value one) in order to control for a potential country bias (*dummy U.S.*).

### 3.4. Model specification

Since our focus is on the technology attributes of an invention, the unit of analysis of this study is the single patent. Regarding the econometric approach, we employ a Tobit regression. This type of regression is suitable when the dependent variable (DV) is limited between a range of values and is not normally distributed (Long, 1997). Indeed, other types of regression (e.g., OLS) cannot account for the nature of this type of DVs and will probably estimate incorrect parameters (Long, 1997; Wiersema and Bowen, 2009; Wooldridge, 2012). *IndustryBreadth* is operationalized through a Herfindahl index, which, by construction, is continuous but limited between zero and one. Thus, our dependent variable falls into the category of limited DVs and, according to previous studies (Ardito, Messeni Petruzzelli and Albino, 2016; Banerjee and Cole, 2010; Köhler et al., 2012), given the double bounded nature of this variable and its non-normal distribution, a Tobit regression is employed.

## 4. RESULTS

Table 1 and Table 2 show descriptive statistics and pairwise correlations, respectively. According to Table 2, correlations are well below the value of 0.70, hence limiting multicollinearity issues (Cohen et al., 2013).

**Table 1.** Descriptive statistics

	Min.	Max.	Mean	S.D.
IndustryImpact	0	0.97	0.29	0.35
Established	0	5.51	1.76	0.97
Scope	1	10	2.04	1.10
Scientific	0	6.98	1.43	1.38
TechBreadth	0	0.92	0.39	0.30
Duration	0	15	3.03	1.71
Joint	0	1	0.12	0.33
Claims	1	99	14.79	11.34
TeamSize	1	24	2.97	1.94
PatFamily	0	5	1.39	1.33
Renewal	0	1	0.68	0.47

n=4,363

**Table 2.** Pairwise correlations

	1	2	3	4	5	6	7	8	9	10	11
1-IndustryImpact	1										
2-Established	0.12*	1									
3-Scope	0.07*	-0.01	1								
4-Scientific	-0.24*	0.047*	0.15*	1							
5-TechBreadth	0.11*	0.67*	0.15*	-0.01	1						
6-Duration	-0.37*	0.01	0.03*	0.37*	-0.02	1					
7-Joint	-0.08*	-0.00	0.08*	0.21*	-0.02	0.16*	1				
8-Claims	0.07*	0.17*	0.13*	0.22*	0.14*	0.10*	0.02	1			
9-TeamSize	-0.16*	-0.02	-0.01	0.12*	-0.02	0.15*	0.21*	0.00	1		
10-PatFamily	-0.14*	-0.03*	0.13*	0.31*	-0.03*	0.30*	0.17*	0.16*	0.12*	1	
11-Renewal	0.13*	0.03	0.03	0.06*	0.01	-0.11*	0.01	0.12*	0.02	-0.01	1

n=4,363

\*p&lt;.05

Table 3 presents the results of the Tobit regression. Model 1 is the baseline model, hence including control variables only. Models 2-5 are the partial models, each of which includes one the four independent variables. Model 6 is the full model, where all the variables are present. Since the variance inflation factor (VIF) for this last model is above the limit of 10 (Kennedy, 2003), we discuss results using partial models (Capaldo et al., 2017). Model 1 reveals that PROs patents have a wider impact on the industry sector if the number of claims is high ( $\beta=0.008$ ,  $p<0.01$ ), and if they have been renewed at least once ( $\beta=0.226$ ,  $p<0.01$ ); the opposite effect can be ascribed to the duration of the examination process ( $\beta=-.084$ ,  $p<0.01$ ) and the team size ( $\beta=-0.011$ ,  $p<0.05$ ). Model 2 tests H1 and suggests that the level of establishment is curvilinearly (inverted U) related to *IndustryImpact*, as its linear term is positive and significant ( $\beta=0.206$ ,  $p<0.01$ ), while its squared term is negative and significant ( $\beta=-0.026$ ,  $p<0.01$ ). To corroborate this finding, using the coefficient estimates from Model 2, we depicted *Established* against the predicted level of *IndustryImpact* (Figure 1). According to Figure 1, the slope at the right side of the curve is not comparably steep to the slope at the left side. This may hint that despite negative effects of very-well established solutions exist, these are slightly relevant as

opposed to the positive ones (see Haans et al., 2016). In line with H2, Model 3 reveals that the scope of application has a positive impact on industry innovation efforts ( $\beta=0.015$ ,  $p<0.10$ ); similarly, Model 4 confirms H3 by revealing the negative influence of the scientific nature of a technology ( $\beta=-0.069$ ,  $p<0.01$ ). Finally, Model 5 supports H4 in that the coefficient of *TechBreadth* is positive and significant ( $\beta=0.340$ ,  $p<0.01$ ).

**Table 3.** Results of Tobit regression (with robust s.e. in parentheses)

	Model 1	Model 2	Model 3	Model 4	Model 5	Model 6
Established		0.206*** (0.031)				0.129*** (0.035)
Established2		-0.026*** (0.008)				-0.008 (0.009)
Scope			0.015* (0.009)			0.015* (0.009)
Scientific				-0.069*** (0.009)		-0.066*** (0.009)
TechBreadth					0.340*** (0.031)	0.115*** (0.041)
Duration	-0.084*** (0.007)	-0.080*** (0.007)	-0.084*** (0.007)	-0.070*** (0.007)	-0.081*** (0.007)	-0.067*** (0.007)
Joint	0.004 (0.032)	0.003 (0.031)	0.000 (0.032)	0.034 (0.031)	0.003 (0.031)	0.026 (0.031)
Claims	0.008*** (0.001)	0.007*** (0.001)	0.008*** (0.001)	0.009*** (0.001)	0.007*** (0.001)	0.007*** (0.001)
TeamSize	-0.011** (0.005)	-0.010* (0.005)	-0.011* (0.005)	-0.009* (0.005)	-0.011* (0.005)	-0.008 (0.005)
Family	0.003 (0.008)	0.004 (0.007)	-0.001 (0.008)	0.013* (0.008)	0.003 (0.007)	0.015* (0.007)
Renewal	0.226*** (0.023)	0.206*** (0.022)	0.226*** (0.022)	0.237*** (0.022)	0.222*** (0.022)	0.220*** (0.022)
dummy PRO	Included	Included	Included	Included	Included	Included
dummy period	Included	Included	Included	Included	Included	Included
dummy U.S.	Included	Included	Included	Included	Included	Included
Constant	-0.393*** (0.043)	-0.663*** (0.052)	-0.417*** (0.045)	-0.408*** (.042)	-0.530*** (0.045)	-0.667*** (0.053)
Log-pseudolikelihood	-2647.94	-2566.64	-2646.26	-2616.84	-2589.93	-2531.81
R2	0.280	0.303	0.282	0.290	0.297	0.313
F	224.42***	210.16***	207.61***	212.79***	219.94***	178.99***

N = 4,363.

\*  $p < 0.10$ .

\*\*  $p < 0.05$ .

\*\*\*  $p < 0.01$ .

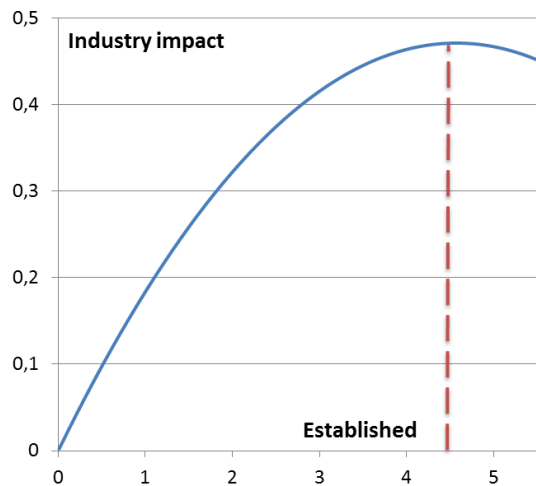

**Figure 1.** Curvilinear effect of *Established* on *IndustryImpact*.

## 5. DISCUSSION

The present paper aims to understand when the research outcomes of PROs influence industry innovation by analysing technology attributes of PROs developed technical solutions (i.e., the level of establishment, the scope of application, the scientific nature, and the technological breadth). Specifically, we conducted this research in the green energy field. Indeed, as per innovation in general, the role public research to correct for the market failures hampering private environmental R&D efforts is extremely important, yet PROs often fail to achieve this goal (Balachandra et al., 2010). Moreover, boosting the development of green energy solutions by the private sector is pivotal for policymakers in order to simultaneously improve economic growth and environmental benefits (Hoppmann et al., 2013; Rennings, 2000).

On the basis of a sample of 4,363 patents registered by PROs during the period 1976-2011 and classified into the “Alternative energy production” and “Energy conservation” technology fields, results of the Tobit regression reveal that the level of establishment of PROs technologies has a positive influence on subsequent industry innovation efforts; only when the level of establishment becomes excessively high this effect turns negative. Furthermore, both the scope of application and the technological breadth manifest a positive influence on the degree to which many companies will build on PROs research outcomes. Finally, we found a negative relationship between the scientific nature of technologies and the breadth of impact that PROs technical solutions have on subsequent private innovation activities. Considering that “understanding the impact of public research on industrial R&D is central to understanding the innovation process itself” (Cohen et al., 2002:1), these results will provide relevant theoretical and policy implications.

### 5.1. *Theoretical implications*

From a theoretical perspective, first, this research investigates a novel and understudied set of antecedents that may explain when outcomes of public R&D efforts provide externalities towards the industry sector, i.e., the technology attributes. To the best of our knowledge, prior research has widely investigated the policy incentives fostering private R&D efforts (e.g., public subsidies) (e.g., Czarnitzki and Lopes-Bento, 2013; OECD, 2006) but negligible efforts have been devoted to examine when the results of public research themselves impact the industry sector. Furthermore, among the few studies examining the results of public research in promoting R&D initiatives related to the private sector (e.g., university-industry-government collaborations and Spin-offs creation) (e.g., Bruneel et al., 2010; Dornbusch and Neuhäusler, 2015), very few of them has narrowed the level of analysis to the technology level (e.g., Shane, 2001), which, instead, has been proved to be pivotal to understand innovation phenomena and the impact of developed technologies (e.g., Ardito et al., 2015; Chen et al., 2011; Nerkar and Shane, 2007). Likewise, studies examining public-private knowledge transfer have mainly focused on firm/university characteristics, modes of knowledge transfer, and proximity dimensions (e.g., geographic) (Agrawal, 2001; Azagra-Caro et al., 2017; Lindelöf and Löfsten, 2004). However, except for Bekkers and Bodas Freitas (2008), knowledge specific characteristics (e.g., codification) have been undervalued; moreover, whether these knowledge characteristics actually help firms to improve their innovation processes has remained unclear. Eventually, these arguments highlight the relevance of our contribution, which refines earlier works on the influence of public research on the industry sector by offering empirical evidence about the role of technology characteristics.

This first contribution goes hand-in-hand with our second contribution. Indeed, we reveal that investigating the role of technology attributes is relevant to assessing the impact of public environmental research on industry innovation efforts, particularly referring to the green energy field. Considering this specific setting is important because extant academic (e.g., Hoppmann et al., 2013) and political debates (OECD, 2012) have devoted particular attention to this sector. Moreover, the role of technology development in the green energy field is central to understand how to promote a shift towards low-carbon societies; thus, some recent studies have recognized factors at the technology level as pivotal to provide information about the development and impact of green energy technologies (Benson and Magee, 2014; Nemet, 2012). Notwithstanding, those studies have not provided insights about the potential influence of technology-level factors, as technology attributes, to explain if green energy technologies developed by PROs may have an impact on subsequent innovation activities by firms.

Third, this study also contributes to the discourse about “where” measuring the influence of a technology. Indeed, a technology may influence the technological landscape of succeeding innovation activities within or beyond a technological, geographic, or institutional domain (e.g., Messeni Petruzzelli, Rotolo, et al., 2015), and our results highlight the types of technology belonging to the public domain that have an impact on the industry domain, as represented by the degree of different companies that build on green energy technologies developed by PROs. In turn, these results may let us add to literature on research evaluation (e.g., Bornmann and Marx, 2014; Lyall et al., 2004). In particular, this literature claims that measuring the societal benefits of public research is still a complex task. However, we believe our approach, which involves the selection of PROs technologies and the adoption of a Herfindahl index measuring the degree of firms building on those solutions, may have provided further insights on how to measure the societal impact of public research.

### 5.2. *Policy implications*

From a policy perspective, we provide guidance on how governments may allocate public money for developing technologies that will be relevant for industry innovation efforts. Indeed, we advise policymakers that public technologies are not all equal with regard to the attractiveness they might have to companies. Thereby, when it is relevant to produce research externalities towards the industry sector, policymakers should design funding schemes directly devoted to develop certain types of technical solutions instead of others. In turn, it is important that PROs receive clear indications regarding the R&D outcomes they are expected to produce. Specifically, considering the analysed setting, where the objective is to achieve better environmental performance while maintaining high level of economic development and both private and public efforts are needed (Albino et al., 2014), we suggest that policymakers invest in strengthening their networks with corporate executives in order to better understand their technology needs. In this way, environmental and business requirements may be better matched; thus, there will be more chances that governments supply relevant green energy technologies to the industry sector, which will set the basis for their future innovation activities. More in detail, we found that green energy technologies that are more established will likely impact industry innovation efforts; conversely, those characterized by a high scientific nature has the opposite effect. Although it may appear that these results may recommend policymakers to disregard more basic research, we advocate that PROs should not be limited to basic research. In other words, PROs should not only devote R&D efforts on basic research, but also continue the technology development process till a level that may be understandable by companies without necessarily focusing on the basic scientific rationale of the developed technologies. This may also help to overcome the double externality problem facing private innovation activities by reducing



knowledge leakage and uncertainty. Furthermore, the scope of application and the technological breadth was revealed to be relevant attributes that make green energy technologies important to firms. This implies that technologies that can be readily applicable to diverse domains or are grounded on a knowledge base that enables many recombination opportunities will likely spread among multiple companies. Therefore, policymakers are advised that developing more pervasive solutions or solutions that may enable pervasive innovation activities (Ardito, Messeni Petruzzelli and Albino, 2016; Gambardella and Giarratana, 2013) should be developed for sustaining industry innovation efforts.

### 5.3. *Limitations*

As with all studies, this paper has some limitations that may point out avenues for future research. First, although the use of patents to capture technology development is very-well established, especially in the green energy field (Albino et al., 2014; Hoppmann et al., 2013; Popp, 2006), we may have missed some inventions because PROs may decide not to adopt a patenting strategy in certain cases and inventions are not always patentable. Thus, further confirmation or additional data may be attained through direct interviews with companies and policymakers. In this way, additional characteristics of technologies (e.g., operational complexity and originality) that cannot be captured with patent-based measures may be also scrutinized. Second, in this research we only focused on the role of technology attributes given the poor attention they have received for analysing the impact of public research. However, we acknowledge that organizational- and environmental-level factors might moderate the technology-level relationships between technology attributes of PROs technical solutions and industry innovation efforts, hence calling for multilevel analyses (e.g., Ardito et al., 2015; Hitt et al., 2007). Third, despite the energy sector is particularly relevant for this research and has some common features with high-tech sectors such as biotechnology and aerospace (Ardito, Messeni Petruzzelli and Panniello, 2016), other industries can be investigated to assure generalizability of results.

## REFERENCES

- Agrawal, A.K., 2001. University-to-industry knowledge transfer: literature review and unanswered questions. *International Journal of Management Reviews* 3, 285-302.
- Ahuja, G., Lampert, C.M., 2001. Entrepreneurship in the large corporation: a longitudinal study of how established firms create breakthrough inventions. *Strategic Management Journal* 22, 521-543.
- Albino, V., Ardito, L., Dangelico, R.M., Messeni Petruzzelli, A., 2014. Understanding the development trends of low-carbon energy technologies: A patent analysis. *Applied Energy* 135, 836-854.
- Alkemade, F., Hekkert, M.P., Negro, S.O., 2011. Transition policy and innovation policy: Friends or foes? *Environmental Innovation and Societal Transitions* 1, 125-129.
- Alnuaimi, T., George, G., 2016. Appropriability and the retrieval of knowledge after spillovers. *Strategic Management Journal* 37, 1263-1279.

- Ardito, L., Messeni Petruzzelli, A., Albino, V., 2015. From technological inventions to new products: A systematic review and research agenda of the main enabling factors. *European Management Review* 12, 113–147.
- Ardito, L., Messeni Petruzzelli, A., Albino, V., 2016. Investigating the antecedents of general purpose technologies: A patent perspective in the green energy field. *Journal of Engineering and Technology Management* 39, 81-100.
- Ardito, L., Messeni Petruzzelli, A., Panniello, U., 2016. Unveiling the breakthrough potential of established technologies: An investigation in the aerospace industry. *Technology Analysis & Strategic Management* 28, 916-934.
- Arrow, K.J., 1962. Economics of welfare and the allocation of resources for invention., in: Nelson, R.R. (Ed.), *The Rate and Direction of Inventive Activity: Economic and social factors*, Princeton University Press: Princeton, NJ, pp. 165–180.
- Azagra-Caro, J.M., Barberá-Tomás, D., Edwards-Schachter, M., Tur, E.M., 2017. Dynamic interactions between university-industry knowledge transfer channels: A case study of the most highly cited academic patent. *Research Policy* 46, 463-474.
- Balachandra, P., Kristle Nathan, H.S., Reddy, B.S., 2010. Commercialization of sustainable energy technologies. *Renewable Energy* 35, 1842-1851.
- Banerjee, P.M., Cole, B.M., 2010. Breadth-of-impact frontier: How firm-level decisions and selection environment dynamics generate boundary-spanning inventions. *Technovation* 30, 411-419.
- Beise, M., Stahl, H., 1999. Public research and industrial innovations in Germany. *Research Policy* 28, 397-422.
- Bekkers, R., Bodas Freitas, I.M., 2008. Analysing knowledge transfer channels between universities and industry: To what degree do sectors also matter? *Research Policy* 37, 1837-1853.
- Benson, C.L., Magee, C.L., 2014. On improvement rates for renewable energy technologies: Solar PV, wind turbines, capacitors, and batteries. *Renewable Energy* 68, 745-751.
- Bornmann, L., Marx, W., 2014. How should the societal impact of research be generated and measured? A proposal for a simple and practicable approach to allow interdisciplinary comparisons. *Scientometrics* 98, 211-219.
- Brooks, H., 1994. The relationship between science and technology. *Research Policy* 23, 477-486.
- Bruneel, J., D'Este, P., Salter, A., 2010. Investigating the factors that diminish the barriers to university–industry collaboration. *Research Policy* 39, 858-868.
- Burhan, M., Singh, A.K., Jain, S.K., Patents as proxy for measuring innovations: A case of changing patent filing behavior in Indian public funded research organizations. *Technological Forecasting and Social Change*.
- Callaert, J., Van Looy, B., Verbeek, A., Debackere, K., Thijs, B., 2006. Traces of Prior Art: An analysis of non-patent references found in patent documents. *Scientometrics* 69, 3-20.
- Capaldo, A., Lavie, D., Messeni Petruzzelli, A., 2017. Knowledge Maturity and the Scientific Value of Innovations: The Roles of Knowledge Distance and Adoption. *Journal of Management* 43, 503-533.
- Chen, C.-J., Chang, C.-C., Hung, S.-W., 2011. Influences of Technological Attributes and Environmental Factors on Technology Commercialization. *Journal of Business Ethics* 104, 525-535.
- Coccia, M., Rolfo, S., 2008. Strategic change of public research units in their scientific activity. *Technovation* 28, 485-494.
- Cohen, J., Cohen, P., West, S.G., Aiken, L.S., 2013. *Applied Multiple Regression/Correlation Analysis for the Behavioral Sciences*. Taylor & Francis.
- Cohen, W.M., Levinthal, D.A., 1990. Absorptive Capacity: A New Perspective on Learning and Innovation. *Administrative Science Quarterly* 35, 128-152.
- Cohen, W.M., Nelson, R.R., Walsh, J.P., 2002. Links and Impacts: The Influence of Public Research on Industrial R&D. *Management Science* 48, 1-23.
- Czarnitzki, D., Lopes-Bento, C., 2013. Value for money? New microeconomic evidence on public R&D grants in Flanders. *Research Policy* 42, 76-89.
- Dornbusch, F., Neuhäusler, P., 2015. Composition of inventor teams and technological progress – The role of collaboration between academia and industry. *Research Policy* 44, 1360-1375.
- Dosi, G., 1982. Technological paradigms and technological trajectories: A suggested interpretation of the determinants and directions of technical change. *Research Policy* 11, 147-162.
- Dosi, G., Nelson, R.R., 2010. Chapter 3 - Technical Change and Industrial Dynamics as Evolutionary Processes, in: Bronwyn, H.H., Nathan, R. (Eds.), *Handbook of the Economics of Innovation*. North-Holland, pp. 51-127.
- EC/EACI, 2011. *Boosting green business*, Executive Agency for Competitiveness and Innovation and European Commission, Luxembourg.
- Fischer, T., Leidinger, J., 2014. Testing patent value indicators on directly observed patent value—An empirical analysis of Ocean Tomo patent auctions. *Research Policy* 43, 519-529.

- Fleming, L., 2001. Recombinant Uncertainty in Technological Search. *Management Science* 47, 117-132.
- Fleming, L., Sorenson, O., 2004. Science as a map in technological search. *Strategic Management Journal* 25, 909-928.
- Foray, D., Mowery, D.C., Nelson, R.R., 2012. Public R&D and social challenges: What lessons from mission R&D programs? *Research Policy* 41, 1697-1702.
- Gambardella, A., Giarratana, M.S., 2013. General technological capabilities, product market fragmentation, and markets for technology. *Research Policy* 42, 315-325.
- Gambardella, A., Giuri, P., Luzzi, A., 2007. The market for patents in Europe. *Research Policy* 36, 1163-1183.
- Geuna, A., Rossi, F., 2011. Changes to university IPR regulations in Europe and the impact on academic patenting. *Research Policy* 40, 1068-1076.
- Gittelman, M., 2006. National institutions, public-private knowledge flows, and innovation performance: A comparative study of the biotechnology industry in the US and France. *Research Policy* 35, 1052-1068.
- Gittelman, M., 2016. The revolution re-visited: Clinical and genetics research paradigms and the productivity paradox in drug discovery. *Research Policy* 45, 1570-1585.
- Griliches, Z., 1987. *R&D, Patents and Productivity*. University of Chicago Press.
- Guan, J.C., Yan, Y., 2016. Technological proximity and recombinative innovation in the alternative energy field. *Research Policy* 45, 1460-1473.
- Haans, R.F.J., Pieters, C., He, Z.-L., 2016. Thinking about U: Theorizing and Testing U- and inverted U-shaped Relationships in Strategy Research. *Strategic Management Journal* 37, 1177-1195.
- Hargadon, A., 2010. Technology policy and global warming: Why new innovation models are needed. *Research Policy* 39, 1024-1026.
- Heeley, M.B., Jacobson, R., 2008. The recency of technological inputs and financial performance. *Strategic Management Journal* 29, 723-744.
- Hendry, C., Harborne, P., 2011. Changing the view of wind power development: More than "bricolage". *Research Policy* 40, 778-789.
- Hitt, M.A., Beamish, P.W., Jackson, S.E., Mathieu, J.E., 2007. BUILDING THEORETICAL AND EMPIRICAL BRIDGES ACROSS LEVELS: MULTILEVEL RESEARCH IN MANAGEMENT. *Academy of Management Journal* 50, 1385-1399.
- Hoppmann, J., Peters, M., Schneider, M., Hoffmann, V.H., 2013. The two faces of market support—How deployment policies affect technological exploration and exploitation in the solar photovoltaic industry. *Research Policy* 42, 989-1003.
- James, S.D., Leiblein, M.J., Lu, S., 2013. How Firms Capture Value From Their Innovations. *Journal of Management* 39, 1123-1155.
- Kaplan, S., Vakili, K., 2015. The Double-Edged Sword Of Recombination In Breakthrough Innovation. *Strategic Management Journal* 36, 1435-1457.
- Katila, R., 2002. New Product Search Over Time: Past Ideas in Their Prime? *Academy of Management Journal* 45, 995-1010.
- Kennedy, P., 2003. *A Guide to Econometrics*. Blackwell.
- Köhler, C., Sofka, W., Grimpe, C., 2012. Selective search, sectoral patterns, and the impact on product innovation performance. *Research Policy* 41, 1344-1356.
- Lee, Y.-G., Lee, J.-H., 2010. Different characteristics between auctioned and non-auctioned patents. *Scientometrics* 82, 135-148.
- Lerner, J., 1994. The importance of patent scope: An empirical analysis. *RAND Journal of Economics (RAND Journal of Economics)* 25, 319-333.
- Lindelöf, P., Löfsten, H., 2004. Proximity as a Resource Base for Competitive Advantage: University-Industry Links for Technology Transfer. *The Journal of Technology Transfer* 29, 311-326.
- Long, J.S., 1997. *Regression Models for Categorical and Limited Dependent Variables*. SAGE Publications.
- Lyll, C., Bruce, A., Firm, J., Firm, M., Tait, J., 2004. Assessing end-use relevance of public sector research organisations. *Research Policy* 33, 73-87.
- Maggitti, P.G., Smith, K.G., Katila, R., 2013. The complex search process of invention. *Research Policy* 42, 90-100.
- Mansfield, E., 1991. Academic research and industrial innovation. *Research Policy* 20, 1-12.
- Martin, B., Tang, P., 2007. THE BENEFITS FROM PUBLICLY FUNDED RESEARCH. Science Policy Research Unit, University of Sussex. Available at <http://citeseerx.ist.psu.edu/viewdoc/download?doi=10.1.1.691.3079&rep=rep1&type=pdf>.
- Martinelli, A., 2012. An emerging paradigm or just another trajectory? Understanding the nature of technological changes using engineering heuristics in the telecommunications switching industry. *Research Policy* 41, 414-429.

- Messeni Petruzzelli, A., Natalicchio, A., Garavelli, A.C., 2015. Investigating the determinants of patent acquisition in biotechnology: an empirical analysis. *Technology Analysis & Strategic Management* 27, 840-858.
- Messeni Petruzzelli, A., Rotolo, D., Albino, V., 2015. Determinants of patent citations in biotechnology: An analysis of patent influence across the industrial and organizational boundaries. *Technological Forecasting and Social Change* 91, 208-221.
- Mowery, D.C., Nelson, R.R., Martin, B.R., 2010. Technology policy and global warming: Why new policy models are needed (or why putting new wine in old bottles won't work). *Research Policy* 39, 1011-1023.
- Murray, F., Stern, S., 2007. Do formal intellectual property rights hinder the free flow of scientific knowledge?: An empirical test of the anti-commons hypothesis. *Journal of Economic Behavior & Organization* 63, 648-687.
- Narin, F., Hamilton, K.S., Olivastro, D., 1997. The increasing linkage between U.S. technology and public science. *Research Policy* 26, 317-330.
- Nemet, G.F., 2012. Inter-technology knowledge spillovers for energy technologies. *Energy Economics* 34, 1259-1270.
- Nemet, G.F., Johnson, E., 2012. Do important inventions benefit from knowledge originating in other technological domains? *Research Policy* 41, 190-200.
- Nerkar, A., Shane, S., 2007. Determinants of invention commercialization: an empirical examination of academically sourced inventions. *Strategic Management Journal* 28, 1155-1166.
- Nooteboom, B., Vanhaverbeke, W., Duysters, G., Gilsing, V., van den Oord, A., 2007. Optimal cognitive distance and absorptive capacity. *Research Policy* 36, 1016-1034.
- Novelli, E., 2015. An examination of the antecedents and implications of patent scope. *Research Policy* 44, 493-507.
- OECD, 2006. *Government R&D Funding and Company Behaviour*, OECD Publishing, Paris.
- OECD, 2012. *OECD Green Growth Studies Energy*. OECD Publishing.
- Oltra, C., Upham, P., Riesch, H., Boso, A., Brunsting, S., Dütschke, E., Lis, A., 2012. Public Responses to Co2 Storage Sites: Lessons from Five European Cases. *Energy & Environment* 23, 227-248.
- Popp, D., 2006. Innovation in climate policy models: Implementing lessons from the economics of R&D. *Energy Economics* 28, 596-609.
- Rennings, K., 2000. Redefining innovation — eco-innovation research and the contribution from ecological economics. *Ecological Economics* 32, 319-332.
- Rogge, K.S., Reichardt, K., 2016. Policy mixes for sustainability transitions: An extended concept and framework for analysis. *Research Policy* 45, 1620-1635.
- Rosenberg, N., Trajtenberg, M., 2004. A General-Purpose Technology at Work: The Corliss Steam Engine in the Late-Nineteenth-Century United States. *The Journal of Economic History* 64, 61-99.
- Sagar, A.D., van der Zwaan, B., 2006. Technological innovation in the energy sector: R&D, deployment, and learning-by-doing. *Energy Policy* 34, 2601-2608.
- Salter, A.J., Martin, B.R., 2001. The economic benefits of publicly funded basic research: a critical review. *Research Policy* 30, 509-532.
- Savino, T., Messeni Petruzzelli, A., Albino, V., 2015. Search and Recombination Process to Innovate: A Review of the Empirical Evidence and a Research Agenda. *International Journal of Management Reviews*, n/a-n/a.
- Shane, S., 2001. Technological Opportunities and New Firm Creation. *Management Science* 47, 205-220.
- Sohn, S.Y., Lee, W.S., Ju, Y.H., 2013. Valuing academic patents and intellectual properties: Different perspectives of willingness to pay and sell. *Technovation* 33, 13-24.
- Sterzi, V., 2013. Patent quality and ownership: An analysis of UK faculty patenting. *Research Policy* 42, 564-576.
- Story, V.M., Daniels, K., Zolkiewski, J., Dainty, A.R.J., 2014. The barriers and consequences of radical innovations: Introduction to the issue. *Industrial Marketing Management* 43, 1271-1277.
- Trajtenberg, M., Henderson, R., Jaffe, A., 1997. University versus Corporate Patents: A Window on the Basicness of Invention. *Economics of Innovation and New Technology* 5, 19-50.
- Veugelers, R., 2012. Which policy instruments to induce clean innovating? *Research Policy* 41, 1770-1778.
- Wiersema, M.F., Bowen, H.P., 2009. The use of limited dependent variable techniques in strategy research: issues and methods. *Strategic Management Journal* 30, 679-692.
- Wooldridge, J., 2012. *Introductory Econometrics: A Modern Approach*. Cengage Learning.
- Ziedonis, A.A., 2007. Real Options in Technology Licensing. *Management Science* 53, 1618-1633.

**THE EFFECTS OF PAY DISPERSION BETWEEN EXECUTIVES AND  
EMPLOYEES OF AN ORGANIZATION ON FIRM PERFORMANCE:  
EVIDENCE FROM TURKEY**

**Ataay, Aylin**

Galatasaray University, Management Department, Istanbul, Turkey

**ABSTRACT**

This study examines the performance consequences of pay dispersion in publicly-listed firms in Turkey for the period 2009 to 2013. Our study focuses on vertical pay dispersion, which reflects intra-firm and vertical differences between pay at two important hierarchical levels: top executive level and lower hierarchical level. We intend to present arguments based on equity theory and tournament theory, and will propose two contradictory hypotheses to test them within the context of an emerging market. Results provided in the present study confirm that pay dispersion between executives and employees has a positive impact on a firm's profitability in Turkey. Our study contributes current empirical evidence by examining vertical pay dispersion in an emerging country context, which may have a different cultural orientation and societal-wide assumptions concerning fairness, power and disparities, relative to its developed country counterparts.

*Keywords: Pay dispersion, pay gap, executive pay, firm performance, emerging economy*

**INTRODUCTION**

Top management compensation research focuses on CEO and executive pay level and structure. There is accumulated empirical knowledge on the antecedents and consequences of executive compensation (Devers et al., 2007; van Essen, Otten and Carberry, 2015; Finkelstein, Hambrick and Cannella, 2009). However, academic and popular interest in the pay gap between employees at the highest and lowest ranks of organizations, or "pay dispersion", is relatively new (Winter-Ebmer and Zweimuller, 1999; Heyman, 2005; Lee, Lev and Yeo, 2008). Existing studies only propose limited insight about the determinants and consequences of pay dispersion. For example, some research has shown that, since employees always compete with one another to gain promotion to managerial positions, and consequently, higher pay levels, pay

dispersion encourages greater efforts and performance on the part of employees (O'Reilly, Main and Crystal, 1988; Ehrenberg and Bognanno, 1990; Becker and Huselid, 1992; Main, O'Reilly and Wade, 1993; Conyon, Peck and Sandler, 2001). Other studies, however, have revealed negative relationships between organizational and individual level outcomes and pay dispersion (Becker and Huselid, 1992; Trevor and Wazeter, 2006; Shaw and Gupta, 2007; Bolino and Turnley, 2008; Dallas, 2011). This study examines the performance consequences of pay dispersion in publicly listed firms in Turkey for the period 2009 to 2013. Our study focuses on vertical pay dispersion, which reflects intra-firm and vertical differences between pay at two important hierarchical levels: the top executive level and lower hierarchical level (Gupta, Conroy and Delery, 2002). We intend to present arguments based on both equity theory and tournament theory, and to propose two contradictory hypotheses that will be tested within an emerging market context. Tournament theory's core assumption is that employees' motivation and performance increase alongside pay disparities between organizational levels. Executive pay level motivates all employees to perform well. Equity theory suggests the opposite; the main predictions underlying this theory advocate that since all employees considered pay level as a reference point for assessing the fairness of their pay and rewards, pay differences provoke feelings of inequity, injustice, and jealousy, which reduce employees' organizational commitment and job satisfaction levels.

The rest of this paper is structured as follow. First, we discuss the theoretical foundation of pay dispersion. Second, we develop our hypotheses. We then present our sample, research model and methods. Finally, we summarize our primary results and conclusions, and discuss the implications of these findings for scholars and professionals.

## **THEORETICAL DEVELOPMENT AND HYPOTHESIS**

### *Theoretical perspectives for vertical pay dispersion and its implications for firm performance*

Scholars have long recognized that the way in which executives, especially CEOs of organizations, are remunerated and rewarded in relation to their colleagues and their employees holds important implications for corporate performance (Cowherd and Levine, 1992; Tosi and Greckhamer, 2004; Connelly et al., 2013). Organizations may adopt a wide variety of compensation systems and practices, highlighting different levels of pay dispersion both among peers (horizontal dispersion) and between different ranks within the company (vertical dispersion). The current study focuses on the dispersion between executives' pay and workers' compensation, in other words, vertical dispersion, which has been the subject of academic research for several decades (Connelly et al., 2013). While researchers agree that this dispersion has risen dramatically the causes and in particular, the effects of this pay gap, are not entirely clear. The theoretical framework of this analysis regarding the impact of vertical compensation dispersion to firm performance has two distinct theoretical bases, which will be reflected in the two different hypotheses.

#### *Tournament theory*

Tournament theory (Lazear and Rosen, 1981), which is based on economic game theory, is one of the foundations of pay dispersion research (Henderson and Fredrickson, 2001; Connelly, Tihanyi, Crook and Gangloff, 2014). Tournament theory proposes that employees are in competition with one another for higher-ranking positions and salaries; consequently employees' efforts increase alongside pay imbalances and as a result of the differences between various organizational levels. Tournament theory accepts a higher level of executive pay as a means for motivating individuals at all organizational levels to exert more effort and to perform well (Becker and Huselid, 1992), and to try and win promotion to a higher level within the firm. This is not only valid where it concerns the ultimate CEO level, but is also true

for employees striving to reach any other managerial position (Cappelli and Cascio, 1991; Henderson and Fredrickson, 2001; Lambert, Larcker and Weigelt, 1993; DeVaro, 2006). Several research findings support these predictions and have disclosed that top executives and especially CEOs serve as significant reference points to employees; thus, vertical disparities in pay levels have substantial consequences for employee behavior (Wade, O'Reilly and Pollock, 2006). The pay disparity is also justified as a tool for attracting and retaining top competencies in the higher ranks of the company (Bloom and Michel, 2002).

Although a number of scholars have attempted to understand the implications of a widening pay gap between top managers and employees (Beaumont and Harris, 2003; Wade et al., 2006), their attempts have failed to reach a consensus regarding its implications. One opinion, which primarily relies on tournament theory arguments, advocates the benefits of a large vertical pay disparity and debates that this will provide encouragement for promotions, motivate higher efforts and competition, and increase performance (Baker, Jensen and Murphy, 1988; Ehrenberg and Bognanno, 1990; DeVaro, 2006). Several empirical findings support this view and have discovered a positive relationship between firm performance and pay dispersion (Main, O'Reilly and Wade, 1993; Lallemand, Plasman and Rycx, 2004; Heyman, 2005).

### *Equity Theory*

A subsequent line of research based on equity theory suggests, however, the opposite argument for vertical pay dispersion. Equity theory states that people expect pay to be distributed according to their relative contributions, and that each employee constantly compares their own contribution to the organization and the rewards received from the organization, relative to their individual reference group. This reference group does not need to comprise only their peers (Kulik and Ambrose, 1992), but will also include those above and below them in the organizational hierarchy, as well as members of other organizations. Employees perceive their outcomes to be unfair when their ratio of input to outcomes falls out of line with their reference points. Through this mechanism, the pay gap can generate a feeling of inequity within the organization. Employees may then attempt to correct this feeling



of inequity (Cowherd and Levine, 1992). This view advocates that since employees observe pay level as an assessment of the fairness of their compensation system, large pay gaps will stimulate feelings of inequity, injustice, and jealousy, which will have a negative effect on their job satisfaction and organizational commitment level (Finkelstein, Hambrick and Cannella, 2009). Hence, scholars taking this perspective generally affirm that a large vertical pay disparity tends to diminish motivation, effort, and cooperation between peers (Cowherd and Levine, 1992). Vertical pay dispersion can similarly stimulate careless risk-taking, reduce employee safety (Becker and Huselid, 1992), and ultimately lead to a higher employee turnover (Bloom and Michel, 2002; Gupta, Conroy and Delery, 2002). Existing empirical evidence supports this perspective, representing a negative relationship between vertical pay dispersion and organizational outcomes (Bloom, 1999; Siegel and Hambrick, 2005; Grund and Westergaard-Nielsen, 2008; Fredrickson, Davis-Blake and Sanders, 2010).

### *Contrasting hypotheses*

As the research findings presented above suggests, these two theoretical perspectives are often considered as contrasting each other. Both theoretical views provide explanations for describing and interpreting results that positively link pay dispersion to firm performance, or that justify the negative effects of a pay gap on organizational performance. When we compare the results previous studies, we observe that accumulated knowledge on the performance implications of pay dispersion had been derived from a developed country context, primarily from the US, where American stock market regulators mandate the disclosure of the gap between the pay of a company's CEO and its top executives, and the median income of its employees. However, a limited number of studies have been conducted outside the US that propose workers respond to vertical pay disparities differently in different countries, depending on the societal context in which they live and country level institutions (Greckhamer, 2016). The present study aims to examine the performance implications of vertical pay dispersion in an emerging country context, i.e., Turkey. Two contrasting hypotheses will be tested in Turkey, which has a specific and different governance and company system compared to its Anglo-Saxon counterparts. The Turkish governance system incorporates characteristics of a family-based system, where financial and capital markets are weak and there is less liquidity for providing external

control; ownership is generally highly concentrated, with pyramidal-type ownership structures. A small number of dominant shareholders control these companies, and there is a low level of legal protection available to minority shareholders (Nilsson, 2007; Oba, Tiğrel and Şener, 2012). The primary objectives are to observe whether empirical evidence supports the tournament theory assertion that vertical pay dispersion will be positively associated with firm performance, or the equity theory assumption that executive and employee pay dispersion will be largely decoupled from performance in Turkey.

Formally stated, the two contrasting hypotheses tested in this study are as follow:

*H1: pay dispersion is positively associated with firm performance in Turkey (tournament theory prediction).*

*H2: pay dispersion is negatively associated with firm performance in Turkey (equity theory prediction).*

## **METHOD**

### *Sample and measures*

Our sample comprises publicly trading companies on the Borsa Istanbul (BIST) in 2009. The data were manually collected for the period 2009 to 2013, for each year. Financial institutions (banks, investment trusts, insurance companies, leasing companies, funds, and factoring companies) were excluded from the sample, because they are regulated according to different accounting rules, and their registration systems are different and therefore, may provide misleading results for the calculation of financial variables. A total of 1278 company-year observations were examined and 117 were excluded from the sample. Since some of these companies delisted from BIST during the study period, or began being traded in the custody market, we could not obtain complete data about their financial figures, and our final sample therefore consisted of 1167 firms. Data were combined from a number of sources, while the majority of our secondary data were taken from KAP (Kamu Aydınlatma Platformu- Public disclosure platform of Turkey, [www.kap.org.tr](http://www.kap.org.tr)) and the Borsa Istanbul (Istanbul Stock Exchange) database. We supplemented these data with information from the annual financial reports of the included companies. However, if any important data were missing for a specific company, this company was not included into the study.

*Dependent variable.* Our dependent variable is the organization's financial performance. We used a widely accepted measure for firm performance and operationalized this variable as average return on assets (ROA), one year after the focal year of analysis. Return on assets, which reflected the profitability of a firm relative to its size, was calculated as the ratio of net income to total assets.

*Independent variable.* Our independent variable is *pay dispersion*. We operationalized this variable as the

ratio of the average top management team's (TMT) total compensation to average employee total compensation. Since Turkish firms are not legally obliged to disclose managerial pay information, most of them prefer not to report detailed compensation figures. The total payments disbursed to the entire top management teams were used as a proxy for TMT pay. This variable was calculated using data that is present in the footnotes of the company's financial reports, according to the title, "Benefits provided to all top executives". This variable comprises the top management team's total annual compensation package, which includes the sum of their annual salaries, cash bonuses, and other long-term remuneration (e.g., David, Kochhar and Levitas, 1998). The ratio of total labor expenses for the firm (excluding TMT pay) to the number of employees was used as a proxy for average employee pay.

*Control variables.* We aimed to control for several other factors that may also have impacted on our dependent variable. First, we controlled for *prior year performance* in the form of return on assets (ROA) one year prior to the focal year of analysis, as prior firm performance is often a strong indicator of future performance, and generally associates with firm resources and pay. *Firm size* was also included in the model. The natural log of assets was employed to operationalize this variable. We also controlled for two industry level factors: *market munificence* and *complexity*. We used Boyd's (1995) operationalization for these measures. Munificence can be defined as the capacity of an industry to support sustained growth. We calculated munificence as the regression of industry sales over time, divided by mean industry sale. Complexity, however, reflected competition level within the industry. We measured complexity using a Herfindahl index; we also included a set of *year* dummy variables to control for temporal effects. Finally, in testing our models, for the impact of pay dispersion on performance, we controlled for *family ownership concentration*, Turkey's unique corporate ownership structure, by including a percentage of the largest controlling family shareholdings. Table 1 shows the descriptive statistics for all the variables used in this study.

## EMPIRICAL EVIDENCE

### *Analysis*

We used an ordinary least squares regression model to test the performance implications of the vertical pay gap. A classical OLS model increases the likelihood of heteroskedasticity and autocorrelation. As our data are longitudinal in nature, with repeated measures for each firm across five years, panel data of this nature are frequently estimated using fixed effects or random effects models. First, we derived firm fixed-effects into equations to correct for unobserved heterogeneity. The results of the Hausman test show significant ( $\chi^2 = 376.54, p < .001$ ) systematic differences in the coefficients produced by the fixed effects and random effects model; as such so we decided to utilize a

fixed-effects model, as opposed to a random effects model.

**Table 1 Descriptive Statistics**

	Mean (s.d)	1	2	3	4	5	6	7	8
1. Pay dispersion	41.604 (117.30)	1							
2. Firm performance	.00125 (.3380)	.033	1						
3. Prior year performance	.0392 (13.872)	-.014	.025	1					
4. Leverage	.4962 (.5096)	.009	-.105**	-.011	1				
5. Munificence	.0807 (.069)	.044	.032	.011	.004	1			
6. Complexity	.0322 (.0296)	.051	.041	.002	.032	.002	1		
7. Firm Size	19.105 (1.761)	.128**	.150**	-.002	.059*	.034	.022	1	
8. Family Ownership	36.63 (33.08)	-.039	.028	-.005	-.022	.012	.043	.040	1

Note: N = 1167

\*\*Correlation is significant at the 0.01 level (2-tailed)

\*Correlation is significant at the 0.05 level (2-tailed)

We examined the impact of pay dispersion on firm performance one year after the focal year (Time t+1), while controlling for the prior year's performance (Time t-1). The results of the tests for hypotheses 1 and 2, which expects a higher pay dispersion to be positively or negatively related to firm profitability, is shown in Table 2. In model 1, we only included the control variables, and the only significant control variables were firm size and firm leverage, indicating a bigger firm size to be positively associated with performance, whereas firm leverage was negatively related with ROA.

The main effect of our independent variable, i.e., vertical pay dispersion, was tested in model 2. The addition of the main effect of the independent variable (i.e., pay dispersion) in model 2 significantly increased the explanatory power of this regression model over model 1. Pay dispersion impact on performance was found to be positive and statistically significant. As hypothesis 1 predicted, pay dispersion had a positive and significant effect on a firm's profitability (beta = .018, p<. 000). This finding supports our hypothesis 1, which is based on tournament theory assumptions.

**Table 2 Regression Analysis Results**

Variables	Model 1	Model 2
Constant	-.649	-.640
Control Variables		
Prior year performance	.024	.027
Leverage	-.119***	-.132***
Munificence	.014	.015
Complexity	.008	.009
Firm size	.173***	.169***
Family ownership concentration	.016	.027
Year effect	Included	Included
Independent Variable		
Pay Dispersion		.018***
Adjusted R2	.207	.217
F	12.989***	10.106***

## DISCUSSION

Based on tournament theory (Lazear and Rosen, 1981; Henderson and Fredrickson, 2001; Connelly et al. 2014;), the empirical evidence provided in the present study confirms that pay dispersion between executives and employees has a positive impact on an organization's profitability.

In the related literature, it has long been suggested that pay dispersion has important consequences for firm performance; however, a full understanding of its impact remains elusive. Some scholars suggest that pay dispersion positively influences effort and performance, while others, emphasizing equity concerns, draw attention to the potential negative performance implications of pay dispersion. In this study, we first developed and then tested these two theoretical explanations of the performance consequences of pay dispersion on manufacturing firms listed on the Istanbul Stock Exchange. Perhaps most important is our finding that intra-firm, inter-rank pay dispersion has significant and positive implications for a firm's profitability. Although the empirical findings of studies examining the effects of pay dispersion within organizations have been contradictory, a smaller number of studies have specifically examined inter-rank pay dispersion between organizational levels, particularly between the highest and lowest levels. Relatively few studies have investigated vertical pay dispersion. Our study contributes current empirical evidence by examining vertical pay dispersion in an emerging country context, which may have a different cultural orientation and

society-wide assumptions of fairness, power and disparities, relative to their developed country counterparts (McDaniel and Gibson, 2012).

Although there may be some exceptions, we assume that top executives are generally interested in increasing their salaries. However, although we found a positive relationship between pay dispersion and short-term performance, our study draws attention to the fact that increasing pay dispersion may have potential negative effects on long-term firm performance (Winter-Ebmer and Zweimuller, 1999; Heyman, 2005).

Academic studies are still working to understand the implications of pay dispersion. By attempting to integrate tournament and equity theory approaches to pay dispersion, we hope that our study brings clarity and academic insight to this discussion from an emerging market perspective. We believe that pay dispersion also has important consequences for human resource management functioning, in terms of affecting recruitment, selection, and the retention of both top managers and other employees. We suggest that developing a more complete understanding of how pay dispersion impacts on human resource policies and practices, TMT recruitment and retention, as well as on other stakeholders, will offer interesting and potentially fruitful research opportunities.

## ACKNOWLEDGEMENT

The author would like to thank Galatasaray University Research Fund for supporting this study under the grant no: 14.102.001.

## REFERENCES

- Baker, G. P., Jensen, M. C., and Murphy, K. J. 1988. Compensation and incentives: Practice vs. theory. *Journal of Finance*, 43: 593-616.
- Becker, B. E., and Huselid, M. A. 1992. The incentive effects of tournament compensation systems. *Administrative Science Quarterly*, 37: 336-350.
- Beaumont, P. B., and Harris, R. I. D. 2003. Internal wage structures and organizational performance. *British Journal of Management*, 41: 53-70.
- Bloom, M. 1999. The performance effects of pay dispersion on individuals and organizations. *Academy of Management Journal*, 42: 25-40.
- Bloom, M., and Michel, J. G. 2002. The relationships among organizational context, pay dispersion, and managerial turnover. *Academy of Management Journal*, 45:33-42.
- Bolino, M. C., and Turnley, W. H. 2008. Old faces, new places: Equity theory in cross-cultural contexts. *Journal of Organizational Behavior*, 29: 29-50.
- Cappelli, P., and Cascio, W. F. 1991. Why some jobs command wage premiums: A test of career tournament and internal labor market hypotheses. *Academy of Management Journal*, 34: 848-868.
- Connelly, B. L., Tihanyi, L., Crook, T. R., and Gangloff, K. A. 2014. Tournament theory: Thirty years of contests and competitions. *Journal of Management*. 40: 16-47
- Connelly, B. L., Tihanyi, L., Crook, T. R., Gangloff, K. A. Conyon, M. J., Peck, S. I., and Sadler, G. V. 2001. Corporate tournaments and executive compensation: Evidence from the U.K. *Strategic Management Journal*, 22: 805-815.
- Connelly, B. L., Haynes, K.T. Tihanyi, L., Gamache, D.L. and Devers, C.E. 2013. Minding the Gap: Antecedents and Consequences of Top Management-to-Worker Pay Dispersion, *Journal of Management*, 20: 1-24.

- Conyon, M. J., Peck, S. I., and Sadler, G. V. 2001. Corporate tournaments and executive compensation: Evidence from the U.K. *Strategic Management Journal*, 22: 805-815.
- Cowherd, D. M., and Levine, D. I. 1992. Product quality and pay equity between lower-level employees and top management: An investigation of distributive justice theory. *Administrative Science Quarterly*, 37: 302-320.
- Cowherd, D., and D. Levine, 1992, Product quality and pay equity between lower-level employees and top management: An investigation of distributive justice theory, *Administrative Science Quarterly* 37, pp. 302-320.
- Dallas, L. 2011. Short-termism, the financial crisis, and corporate governance. *Journal of Corporation Law*, 37: 264-362.
- DeVaro, J. 2006. Strategic promotion tournaments and worker performance. *Strategic Management Journal*, 27: 721-740.
- Devers, C. E., McNamara, G., Wiseman, R. M., and Arrfelt, M. 2008. Moving closer to the action: Examining compensation design effects on firm risk. *Organization Science*, 19: 548-566.
- Ehrenberg, R. G., and Bognanno, M. L. 1990. The incentive effects of tournaments revisited: Evidence from the European PGA Tour. *Industrial and Labor Relations Review*, 43: 74-88.
- Eriksson, T. 1999. Executive compensation and tournament theory: Empirical tests on Danish data. *Journal of Labor Economics*, 17: 262-280.
- Finkelstein, S., Hambrick, D. C., and Cannella, A. A. 2009. *Strategic leadership: Theory and research on executive, top management teams, and boards*. New York: Oxford University Press.
- Fredrickson, J. W., Davis-Blake, A., and Sanders, W. M. G. 2010. Sharing the wealth: Social comparisons and pay dispersion in the CEOs top team. *Strategic Management Journal*, 31: 1031-1053.
- Greckhamer, T. 2016. CEO compensation in relation to worker compensation across countries: The configurational impact of country-level institutions. *Strategic Management Journal*, 37: 793-815.
- Grund, C., & Westergaard-Nielsen, N. 2008. The dispersion of employees' wage increases and firm performance. *Industrial and Labor Relations Review*, 61: 485-501.
- Gupta, N., Conroy, S. A., & Delery, J. E. 2012. The many faces of pay variation. *Human Resource Management Review*, 22: 100-115.
- Henderson, A. D., & Fredrickson, J. W. 2001. Top management team coordination needs and the CEO pay gap: A competitive test of economic and behavioral views. *Academy of Management Journal*, 44: 96-117.
- Heyman, F. 2005. Pay inequality and firm performance: Evidence from matched employer-employee data. *Applied Economics*, 37: 1313-1327.
- Kullik, C.T. and Ambrose, M.L. 1992. Personal and situational determinants of referent choice. *Academy of Management Review*, 17:212-237.
- Lallemand, T., Plasman, R., and Rycx, F. 2004. Intra-firm wage dispersion and firm performance: Evidence from linked employer-employee data. *Kyklos*, 57: 533-558.
- Lambert, R. A., Larcker, D. F., and Weigelt, K. 1993. The structure of organizational incentives. *Administrative Science Quarterly*, 38: 438-461.
- Lazear, E. P., and Rosen, S. 1981. Rank-order tournaments as optimum labor contracts. *Journal of Political Economy*, 89: 841-865.
- Lee, K.W., Lev, B. and Yeo, G.H.H. (2008). Executive pay dispersion, corporate governance and firm performance. *Review of Quantitative Finance and Accounting*, 30: 315-338.
- Main, B.G., O'Reilly C.A and Wade, J.1993. Top executive pay: Tournament or teamwork. *Journal of Labor Economics*, 11: 606-628.
- O'Reilly, C.A., Main, B.G. and Crystal, G.S. 1988. CEO compensation as tournament and social comparison: A tale of two theories. *Administrative Science Quarterly*, 33: 257-274.
- Shaw, J. D., and Gupta, N. 2007. Pay system characteristics and quit patterns of good, average, and poor performers. *Personnel Psychology*, 60: 903-928.
- Siegel, P. A., and Hambrick, D. C. 2005. Pay disparities within top management groups: Evidence of harmful effects on performance of high-technology firms. *Organization Science*, 16: 259-274.
- Tosi, H.L. and Greckhamer, T. 2004. Cultura and CEO compensation. *Organization Science*. 15: 657-670.
- Trevor, C. O., and Wazeter, D. L. 2006. A contingent view of reactions to objective pay conditions: Interdependence among pay structure characteristics and pay relative to internal and external referents. *Journal of Applied Psychology*, 91: 1260-1275.
- Van Essen, M., Otten, J. and Carberry, E.J. 2015. Assessing managerial power theory: A meta-analytic approach to understanding the determinants of CEO compensation. *Journal of Management*, 41: 164-202.
- Wade, J. B., O'Reilly, C. A., and Pollock, T. G. 2006. Overpaid CEOs and underpaid managers: Fairness and executive compensation. *Organization Science*, 17: 527-544.
- Winter-Ebmer, R., and Zweimuller, J. 1999. Intra-firm wage dispersion and firm performance. *Kyklos*, 52: 555-572.





**THE EFFECTS OF PAY DISPERSION BETWEEN EXECUTIVES AND  
EMPLOYEES OF AN ORGANIZATION ON FIRM PERFORMANCE:  
EVIDENCE FROM TURKEY**

**Aylin Ataay**

Galatasaray University, Management Department, Istanbul, Turkey

**ABSTRACT**

This study examines the performance consequences of pay dispersion in publicly-listed firms in Turkey for the period 2009 to 2013. Our study focuses on vertical pay dispersion, which reflects intra-firm and vertical differences between pay at two important hierarchical levels: top executive level and lower hierarchical level. We intend to present arguments based on equity theory and tournament theory, and will propose two contradictory hypotheses to test them within the context of an emerging market. Results provided in the present study confirm that pay dispersion between executives and employees has a positive impact on a firm's profitability in Turkey. Our study contributes current empirical evidence by examining vertical pay dispersion in an emerging country context, which may have a different cultural orientation and societal-wide assumptions concerning fairness, power and disparities, relative to its developed country counterparts.

*Keywords: Pay dispersion, vertical pay dispersion, emerging economy, Turkey*

**INTRODUCTION**

Top management compensation research focuses on CEO and executive pay level and structure. There is accumulated empirical knowledge on the antecedents and consequences of executive compensation (Devers et al., 2007; van Essen, Otten and Carberry, 2015; Finkelstein, Hambrick and Cannella, 2009). However, academic and popular interest in the pay gap between employees at the highest and lowest ranks of organizations, or "pay dispersion", is relatively new (Winter-Ebmer and Zweimuller, 1999; Heyman, 2005; Lee, Lev and Yeo, 2008). Existing studies only propose limited insight about the determinants and consequences of pay dispersion.

For example, some research has shown that, since employees always compete with one another to gain promotion to managerial positions, and consequently, higher pay levels, pay dispersion encourages greater efforts and performance on the part of employees (O'Reilly, Main and Crystal, 1988; Ehrenberg and Bognanno, 1990; Becker and Huselid, 1992; Main, O'Reilly and Wade, 1993; Conyon, Peck and Sandler, 2001). Other studies, however, have revealed negative relationships between organizational and individual level outcomes and pay dispersion (Becker and Huselid, 1992; Trevor and Wazeter, 2006; Shaw and Gupta, 2007; Bolino and Turnley, 2008; Dallas, 2011). This study examines the performance consequences of pay dispersion in publicly listed firms in Turkey for the period 2009 to 2013. Our study focuses on vertical pay dispersion, which reflects intra-firm and vertical differences between pay at two important hierarchical levels: the top executive level and lower hierarchical level (Gupta, Conroy and Delery, 2002). We intend to present arguments based on both equity theory and tournament theory, and to propose two contradictory hypotheses that will be tested within an emerging market context. Tournament theory's core assumption is that employees' motivation and performance increase alongside pay disparities between organizational levels. Executive pay level motivates all employees to perform well. Equity theory suggests the opposite; the main predictions underlying this theory advocate that since all employees considered pay level as a reference point for assessing the fairness of their pay and rewards, pay differences provoke feelings of inequity, injustice, and jealousy, which reduce employees' organizational commitment and job satisfaction levels.

The rest of this paper is structured as follow. First, we discuss the theoretical foundation of pay dispersion. Second, we develop our hypotheses. We then present our sample, research model and methods. Finally, we summarize our primary results and conclusions, and discuss the implications of these findings for scholars and professionals.

## THEORETICAL DEVELOPMENT AND HYPOTHESIS

### *Theoretical perspectives for vertical pay dispersion and its implications for firm performance*

Scholars have long recognized that the way in which executives, especially CEOs of organizations, are remunerated and rewarded in relation to their colleagues and their employees holds important implications for corporate performance (Cowherd and Levine, 1992; Tosi and Greckhamer, 2004; Connelly et al., 2013). Organizations may adopt a wide variety of compensation systems and practices, highlighting different levels of pay dispersion both among peers (horizontal dispersion) and between different ranks within the company (vertical dispersion). The current study focuses on the dispersion between executives' pay and workers' compensation, in other words, vertical dispersion, which has been the subject of academic research for several decades (Connelly et al., 2013). While researchers agree that this dispersion has risen dramatically the causes and in particular, the effects of this pay gap, are not entirely clear. The theoretical framework of this analysis regarding the impact of vertical compensation dispersion to firm performance has two distinct theoretical bases, which will be reflected in the two different hypotheses.

#### *Tournament theory*

Tournament theory (Lazear and Rosen, 1981), which is based on economic game theory, is one of the foundations of pay dispersion research (Henderson and Fredrickson, 2001; Connelly, Tihanyi, Crook and Gangloff, 2014). Tournament theory proposes that employees are in competition with one another for higher-ranking positions and salaries; consequently employees' efforts increase alongside pay imbalances and as a result of the differences between various organizational levels. Tournament theory accepts a higher level of executive pay as a means for motivating individuals at all organizational levels to exert more effort and to perform well (Becker and Huselid, 1992), and to try and win promotion to a higher level within the

firm. This is not only valid where it concerns the ultimate CEO level, but is also true for employees striving to reach any other managerial position (Cappelli and Cascio, 1991; Henderson and Fredrickson, 2001; Lambert, Larcker and Weigelt, 1993; DeVaro, 2006). Several research findings support these predictions and have disclosed that top executives and especially CEOs serve as significant reference points to employees; thus, vertical disparities in pay levels have substantial consequences for employee behavior (Wade, O'Reilly and Pollock, 2006). The pay disparity is also justified as a tool for attracting and retaining top competencies in the higher ranks of the company (Bloom and Michel, 2002).

Although a number of scholars have attempted to understand the implications of a widening pay gap between top managers and employees (Beaumont and Harris, 2003; Wade et al., 2006), their attempts have failed to reach a consensus regarding its implications. One opinion, which primarily relies on tournament theory arguments, advocates the benefits of a large vertical pay disparity and debates that this will provide encouragement for promotions, motivate higher efforts and competition, and increase performance (Baker, Jensen and Murphy, 1988; Ehrenberg and Bognanno, 1990; DeVaro, 2006). Several empirical findings support this view and have discovered a positive relationship between firm performance and pay dispersion (Main, O'Reilly and Wade, 1993; Lallemand, Plasman and Rycx, 2004; Heyman, 2005).

### *Equity Theory*

A subsequent line of research based on equity theory suggests, however, the opposite argument for vertical pay dispersion. Equity theory states that people expect pay to be distributed according to their relative contributions, and that each employee constantly compares their own contribution to the organization and the rewards received from the organization, relative to their individual reference group. This reference group does not need to comprise only their peers (Kulik and Ambrose, 1992), but will also include those above and below them in the organizational hierarchy, as well as members of other organizations. Employees perceive their outcomes to be unfair when their ratio of input to outcomes falls out of line with their reference points. Through this mechanism, the pay gap can generate a feeling of

inequity within the organization. Employees may then attempt to correct this feeling of inequity (Cowherd and Levine, 1992). This view advocates that since employees observe pay level as an assessment of the fairness of their compensation system, large pay gaps will stimulate feelings of inequity, injustice, and jealousy, which will have a negative effect on their job satisfaction and organizational commitment level (Finkelstein, Hambrick and Cannella, 2009). Hence, scholars taking this perspective generally affirm that a large vertical pay disparity tends to diminish motivation, effort, and cooperation between peers (Cowherd and Levine, 1992). Vertical pay dispersion can similarly stimulate careless risk-taking, reduce employee safety (Becker and Huselid, 1992), and ultimately lead to a higher employee turnover (Bloom and Michel, 2002; Gupta, Conroy and Delery, 2002). Existing empirical evidence supports this perspective, representing a negative relationship between vertical pay dispersion and organizational outcomes (Bloom, 1999; Siegel and Hambrick, 2005; Grund and Westergaard-Nielsen, 2008; Fredrickson, Davis-Blake and Sanders, 2010).

### *Contrasting hypotheses*

As the research findings presented above suggests, these two theoretical perspectives are often considered as contrasting each other. Both theoretical views provide explanations for describing and interpreting results that positively link pay dispersion to firm performance, or that justify the negative effects of a pay gap on organizational performance. When we compare the results previous studies, we observe that accumulated knowledge on the performance implications of pay dispersion had been derived from a developed country context, primarily from the US, where American stock market regulators mandate the disclosure of the gap between the pay of a company's CEO and its top executives, and the median income of its employees. However, a limited number of studies have been conducted outside the US that propose workers respond to vertical pay disparities differently in different countries, depending on the societal context in which they live and country level institutions (Greckhamer, 2016). The present study aims to examine the performance implications of vertical pay dispersion in an emerging country context, i.e., Turkey. Two contrasting hypotheses will be tested in Turkey, which has a specific and different governance and company system compared to its Anglo-Saxon counterparts. The Turkish governance system incorporates characteristics of a family-based

system, where financial and capital markets are weak and there is less liquidity for providing external control; ownership is generally highly concentrated, with pyramidal-type ownership structures. A small number of dominant shareholders control these companies, and there is a low level of legal protection available to minority shareholders (Nilsson, 2007; Oba, Tiğrel and Şener, 2012). The primary objectives are to observe whether empirical evidence supports the tournament theory assertion that vertical pay dispersion will be positively associated with firm performance, or the equity theory assumption that executive and employee pay dispersion will be largely decoupled from performance in Turkey.

Formally stated, the two contrasting hypotheses tested in this study are as follow:

*H1: pay dispersion is positively associated with firm performance in Turkey (tournament theory prediction).*

*H2: pay dispersion is negatively associated with firm performance in Turkey (equity theory prediction).*

## **METHOD**

### *Sample and measures*

Our sample comprises publicly trading companies on the Borsa Istanbul (BIST) in 2009. The data were manually collected for the period 2009 to 2013, for each year. Financial institutions (banks, investment trusts, insurance companies, leasing companies, funds, and factoring companies) were excluded from the sample, because they are regulated according to different accounting rules, and their registration systems are different and therefore, may provide misleading results for the calculation of financial variables. A total of 1278 company-year observations were examined and 117 were excluded from the sample. Since some of these companies delisted from BIST during the study period, or began being traded in the custody market, we could not obtain complete data about their financial figures, and our final sample therefore consisted of 1167 firms. Data were combined from a number of sources, while the majority of our secondary data were taken from KAP (Kamu Aydınlatma Platformu- Public disclosure platform of Turkey, [www.kap.org.tr](http://www.kap.org.tr)) and the Borsa Istanbul (Istanbul Stock Exchange) database. We supplemented these data with information from the annual financial reports of the included companies. However, if any important data were missing for a specific company, this company was not included into the study.

*Dependent variable.* Our dependent variable is the organization's financial performance. We used a widely accepted measure for firm performance and operationalized this variable as average return on assets (ROA), one year after the focal year of analysis. Return on assets, which reflected the profitability of a firm relative to its size, was calculated as the ratio of net income to total assets.

*Independent variable.* Our independent variable is *pay dispersion*. We operationalized this variable as the ratio of the average top management team's (TMT) total compensation to average employee total compensation. Since Turkish firms are not legally obliged to disclose managerial pay information, most of them prefer not to report detailed compensation figures. The total payments disbursed to the entire top management teams were used as a proxy for TMT pay. This variable was calculated using data that is present in the footnotes of the company's financial reports, according to the title, "Benefits provided to all top executives". This variable comprises the top management team's total annual compensation package, which includes the sum of their annual salaries, cash bonuses, and other long-term remuneration (e.g., David, Kochhar and Levitas, 1998). The ratio of total labor expenses for the firm (excluding TMT pay) to the number of employees was used as a proxy for average employee pay.

*Control variables.* We aimed to control for several other factors that may also have impacted on our dependent variable. First, we controlled for *prior year performance* in the form of return on assets (ROA) one year prior to the focal year of analysis, as prior firm performance is often a strong indicator of future performance, and generally associates with firm resources and pay. *Firm size* was also included in the model. The natural log of assets was employed to operationalize this variable. We also controlled for two industry level factors: *market munificence* and *complexity*. We used Boyd's (1995) operationalization for these measures. Munificence can be defined as the capacity of an industry to support sustained growth. We calculated munificence as the regression of industry sales over time, divided by mean industry sale. Complexity, however, reflected competition level within the industry. We measured complexity using a Herfindahl index; we also included a set of *year* dummy variables to control for temporal effects. Finally, in testing our models, for the impact of pay dispersion on performance, we controlled for *family ownership concentration*, Turkey's unique corporate ownership structure, by including a percentage of the largest controlling family shareholdings. Table 1 shows the descriptive statistics for all the variables used in this study.

## EMPIRICAL EVIDENCE

### *Analysis*

We used an ordinary least squares regression model to test the performance implications of the vertical pay gap. A classical OLS model increases the likelihood of heteroskedasticity and autocorrelation. As our data are longitudinal in nature, with repeated measures for each firm across five years, panel data of this nature are frequently estimated using fixed effects or random effects models. First, we derived firm fixed-effects into equations to correct for unobserved heterogeneity. The results of the Hausman test show significant ( $\chi^2 = 376.54, p < .001$ ) systematic differences in the

coefficients produced by the fixed effects and random effects model; as such so we decided to utilize a fixed-effects model, as opposed to a random effects model.

**Table 1 Descriptive Statistics**

	Mean (s.d)	1	2	3	4	5	6	7	8
<b>1. Pay dispersion</b>	41.604 (117.30)	1							
<b>2. Firm performance</b>	.00125 (.3380)	.033	1						
<b>3. Prior year performance</b>	.0392 (13.872)	-.014	.025	1					
<b>4. Leverage</b>	.4962 (.5096)	.009	-.105**	-.011	1				
<b>5. Munificence</b>	.0807 (.069)	.044	.032	.011	.004	1			
<b>6. Complexity</b>	.0322 (.0296)	.051	.041	.002	.032	.002	1		
<b>7. Firm Size</b>	19.105 (1.761)	.128**	.150**	-.002	.059*	.034	.022	1	
<b>8. Family Ownership</b>	36.63 (33.08)	-.039	.028	-.005	-.022	.012	.043	.040	1

Note: N = 1167

\*\*Correlation is significant at the 0.01 level (2-tailed)

\*Correlation is significant at the 0.05 level (2-tailed)

We examined the impact of pay dispersion on firm performance one year after the focal year (Time t+1), while controlling for the prior year's performance (Time t-1). The results of the tests for hypotheses 1 and 2, which expects a higher pay dispersion to be positively or negatively related to firm profitability, is shown in Table 2. In model 1, we only included the control variables, and the only significant control variables were firm size and firm leverage, indicating a bigger firm size to be positively associated with performance, whereas firm leverage was negatively related with ROA.

The main effect of our independent variable, i.e., vertical pay dispersion, was tested in model 2. The addition of the main effect of the independent variable (i.e., pay dispersion) in model 2 significantly increased the explanatory power of this regression model over model 1. Pay dispersion impact on performance was found to be positive and statistically significant. As hypothesis 1 predicted, pay



dispersion had a positive and significant effect on a firm's profitability (beta = .018,  $p < .000$ ). This finding supports our hypothesis 1, which is based on tournament theory assumptions.

**Table 2 Regression Analysis Results**

Variables	Model 1	Model 2
Constant	-.649	-.640
<b>Control Variables</b>		
Prior year performance	.024	.027
Leverage	-.119***	-.132***
Munificence	.014	.015
Complexity	.008	.009
Firm size	.173***	.169***
Family ownership concentration	.016	.027
Year effect	Included	Included
<b>Independent Variable</b>		
Pay Dispersion		.018***
Adjusted R2	.207	.217
F	12.989***	10.106***

## DISCUSSION

Based on tournament theory (Lazear and Rosen, 1981; Henderson and Fredrickson, 2001; Connelly et al. 2014;), the empirical evidence provided in the present study confirms that pay dispersion between executives and employees has a positive impact on an organization's profitability.

In the related literature, it has long been suggested that pay dispersion has important consequences for firm performance; however, a full understanding of its impact remains elusive. Some scholars suggest that pay dispersion positively influences effort and performance, while others, emphasizing equity concerns, draw attention to the potential negative performance implications of pay dispersion. In this study, we first developed and then tested these two theoretical explanations of the performance consequences of pay dispersion on manufacturing firms listed on the Istanbul Stock Exchange. Perhaps most important is our finding that intra-firm, inter-rank pay dispersion has significant and positive implications for a firm's profitability. Although the empirical findings of studies examining the effects of pay dispersion within organizations have been contradictory, a smaller number of studies have specifically examined inter-rank pay dispersion between organizational levels, particularly between the highest and lowest levels. Relatively few studies have investigated vertical

pay dispersion. Our study contributes current empirical evidence by examining vertical pay dispersion in an emerging country context, which may have a different cultural orientation and society-wide assumptions of fairness, power and disparities, relative to their developed country counterparts (McDaniel and Gibson, 2012).

Although there may be some exceptions, we assume that top executives are generally interested in increasing their salaries. However, although we found a positive relationship between pay dispersion and short-term performance, our study draws attention to the fact that increasing pay dispersion may have potential negative effects on long-term firm performance (Winter-Ebmer and Zweimuller, 1999; Heyman, 2005).

Academic studies are still working to understand the implications of pay dispersion. By attempting to integrate tournament and equity theory approaches to pay dispersion, we hope that our study brings clarity and academic insight to this discussion from an emerging market perspective. We believe that pay dispersion also has important consequences for human resource management functioning, in terms of affecting recruitment, selection, and the retention of both top managers and other employees. We suggest that developing a more complete understanding of how pay dispersion impacts on human resource policies and practices, TMT recruitment and retention, as well as on other stakeholders, will offer interesting and potentially fruitful research opportunities.

## ACKNOWLEDGEMENT

The author would like to thank Galatasaray University Research Fund for supporting this study under the grant no: 14.102.001.

## REFERENCES

- Baker, G. P., Jensen, M. C., and Murphy, K. J. 1988. Compensation and incentives: Practice vs. theory. *Journal of Finance*, 43: 593-616.
- Becker, B. E., and Huselid, M. A. 1992. The incentive effects of tournament compensation systems. *Administrative Science Quarterly*, 37: 336-350.
- Beaumont, P. B., and Harris, R. I. D. 2003. Internal wage structures and organizational performance. *British Journal of Management*, 41: 53-70.
- Bloom, M. 1999. The performance effects of pay dispersion on individuals and organizations. *Academy of Management Journal*, 42: 25-40.
- Bloom, M., and Michel, J. G. 2002. The relationships among organizational context, pay dispersion, and managerial turnover. *Academy of Management Journal*, 45:33-42.
- Bolino, M. C., and Turnley, W. H. 2008. Old faces, new places: Equity theory in cross-cultural contexts. *Journal of Organizational Behavior*, 29: 29-50.
- Cappelli, P., and Cascio, W. F. 1991. Why some jobs command wage premiums: A test of career tournament and internal labor market hypotheses. *Academy of Management Journal*, 34: 848-868.
- Connelly, B. L., Tihanyi, L., Crook, T. R., and Gangloff, K. A. 2014. Tournament theory: Thirty years of contests and competitions. *Journal of Management*. 40: 16-47

- Connelly, B. L., Tihanyi, L., Crook, T. R., Gangloff, K. A. Conyon, M. J., Peck, S. I., and Sadler, G. V. 2001. Corporate tournaments and executive compensation: Evidence from the U.K. *Strategic Management Journal*, 22: 805-815.
- Connelly, B. L., Haynes, K.T. Tihanyi, L., Gamache, D.L. and Devers, C.E. 2013. Minding the Gap: Antecedents and Consequences of Top Management-to-Worker Pay Dispersion, *Journal of Management*, 20: 1-24.
- Conyon, M. J., Peck, S. I., and Sadler, G. V. 2001. Corporate tournaments and executive compensation: Evidence from the U.K. *Strategic Management Journal*, 22: 805-815.
- Cowherd, D. M., and Levine, D. I. 1992. Product quality and pay equity between lower-level employees and top management: An investigation of distributive justice theory. *Administrative Science Quarterly*, 37: 302-320.
- Cowherd, D., and D. Levine, 1992, Product quality and pay equity between lower-level employees and top management: An investigation of distributive justice theory, *Administrative Science Quarterly* 37, pp. 302-320.
- Dallas, L. 2011. Short-termism, the financial crisis, and corporate governance. *Journal of Corporation Law*, 37: 264-362.
- DeVaro, J. 2006. Strategic promotion tournaments and worker performance. *Strategic Management Journal*, 27: 721-740.
- Devers, C. E., McNamara, G., Wiseman, R. M., and Arrfelt, M. 2008. Moving closer to the action: Examining compensation design effects on firm risk. *Organization Science*, 19: 548-566.
- Ehrenberg, R. G., and Bognanno, M. L. 1990. The incentive effects of tournaments revisited: Evidence from the European PGA Tour. *Industrial and Labor Relations Review*, 43: 74-88.
- Eriksson, T. 1999. Executive compensation and tournament theory: Empirical tests on Danish data. *Journal of Labor Economics*, 17: 262-280.
- Finkelstein, S., Hambrick, D. C., and Cannella, A. A. 2009. *Strategic leadership: Theory and research on executive, top management teams, and boards*. New York: Oxford University Press.
- Fredrickson, J. W., Davis-Blake, A., and Sanders, W. M. G. 2010. Sharing the wealth: Social comparisons and pay dispersion in the CEOs top team. *Strategic Management Journal*, 31: 1031-1053.
- Greckhamer, T. 2016. CEO compensation in relation to worker compensation across countries: The configurational impact of country-level institutions. *Strategic Management Journal*, 37: 793-815.
- Grund, C., & Westergaard-Nielsen, N. 2008. The dispersion of employees' wage increases and firm performance. *Industrial and Labor Relations Review*, 61: 485-501.
- Gupta, N., Conroy, S. A., & Delery, J. E. 2012. The many faces of pay variation. *Human Resource Management Review*, 22: 100-115.
- Henderson, A. D., & Fredrickson, J. W. 2001. Top management team coordination needs and the CEO pay gap: A competitive test of economic and behavioral views. *Academy of Management Journal*, 44: 96-117.
- Heyman, F. 2005. Pay inequality and firm performance: Evidence from matched employer-employee data. *Applied Economics*, 37: 1313-1327.
- Kullik, C.T. and Ambrose, M.L. 1992. Personal and situational determinants of referent choice. *Academy of Management Review*, 17:212-237.
- Lallemand, T., Plasman, R., and Rycx, F. 2004. Intra-firm wage dispersion and firm performance: Evidence from linked employer-employee data. *Kyklos*, 57: 533-558.
- Lambert, R. A., Larcker, D. F., and Weigelt, K. 1993. The structure of organizational incentives. *Administrative Science Quarterly*, 38: 438-461.
- Lazear, E. P., and Rosen, S. 1981. Rank-order tournaments as optimum labor contracts. *Journal of Political Economy*, 89: 841-865.
- Lee, K.W., Lev, B. and Yeo, G.H.H. (2008). Executive pay dispersion, corporate governance and firm performance. *Review of Quantitative Finance and Accounting*, 30: 315-338.
- Main, B.G., O'Reilly C.A and Wade, J.1993. Top executive pay: Tournament or teamwork. *Journal of Labor Economics*, 11: 606-628.
- O'Reilly, C.A., Main, B.G. and Crystal, G.S. 1988. CEO compensation as tournament and social comparison: A tale of two theories. *Administrative Science Quarterly*, 33: 257-274.
- Shaw, J. D., and Gupta, N. 2007. Pay system characteristics and quit patterns of good, average, and poor performers. *Personnel Psychology*, 60: 903-928.
- Siegel, P. A., and Hambrick, D. C. 2005. Pay disparities within top management groups: Evidence of harmful effects on performance of high-technology firms. *Organization Science*, 16: 259-274.
- Tosi, H.L. and Greckhamer, T. 2004. Cultura and CEO compensation. *Organization Science*. 15: 657-670.
- Trevor, C. O., and Wazeter, D. L. 2006. A contingent view of reactions to objective pay conditions: Interdependence among pay structure characteristics and pay relative to internal and external referents. *Journal of Applied Psychology*, 91: 1260-1275.

- Van Essen, M., Otten, J. and Carberry, E.J. 2015. Assessing managerial power theory: A meta-analytic approach to understanding the determinants of CEO compensation. *Journal of Management*, 41: 164-202.
- Wade, J. B., O'Reilly, C. A., and Pollock, T. G. 2006. Overpaid CEOs and underpaid managers: Fairness and executive compensation. *Organization Science*, 17: 527-544.
- Winter-Ebmer, R., and Zweimuller, J. 1999. Intra-firm wage dispersion and firm performance. *Kyklos*, 52: 555-572.

## INVOLVING CUSTOMERS IN NEW SERVICE DEVELOPMENT: PAST, PRESENT AND FUTURE

Athanasopoulou, P.<sup>1</sup>; Giovanis, A.N.<sup>2</sup>; Karounis, V.<sup>1</sup>; Tsoukatos, E.<sup>3</sup>

<sup>1</sup>Sport Management Department, University of Peloponnese, Sparti, Greece

<sup>2</sup>Business Administration Department, Technological Educational Institute of Athens, Athens, Greece

<sup>3</sup>Department of Accounting and Finance, Technological Educational Institute of Crete, Greece

### ABSTRACT

Research on service innovation suggests that involving customers in new service development (NSD) is a major contributing factor to new service success. The objectives of this paper is to provide an overview of the literature regarding the involvement of customers in the development of new services and to offer guidelines for future research. Results show that past research has considered various antecedents and consequences of customer involvement and has also analysed various dimensions of the nature of involvement such as the intensity and modes of involvement and the communication process used to involve customers. Current research is mainly occupied with determining specific managerial practices that can lead to successful involvement of customers; the role of relationships as well as consumer motives, needs and experiences in the involvement process; the selection of customers for involvement and the effect of virtual environments. Future research should focus both on more in-depth, qualitative studies and more detailed quantitative models; analyse both buyer and seller perspectives; develop customer selection guides; formalize the involvement process; determine the role of relationship concepts in involvement and investigate how social media and brand communities can be effectively used for involving customers.

*Keywords: New service development, customer involvement, services, service innovation, co-creation, customer participation, consumer involvement*

### INTRODUCTION

In today's highly competitive and rapidly changing environment, developing successful services fast is a strategic imperative for businesses (Kindström and Kowalkowski, 2009). The advent and use of the Internet has also revolutionised and changed dramatically the role that customers can play in service innovation. Customers are knowledgeable and powerful and supply vast amounts of information on social media and virtual communities that can be used by firms for developing new services. On the other hand, research on service innovation suggests that involving customers in the

development of new services is a major contributing factor to the success of new service offerings (e.g. Alam, 2002; Kristensson, Gustafsson, and Archer, 2004; Carbonell, Rodríguez-Escudero, and Pujari, 2009, 2012; Melton and Hartline, 2010, 2015; Dadfar, Brege, and Semnani, 2013; Zhihong, Duffield, and Wilson, 2015). Therefore, the involvement of customers in the development of new services is an issue that has attracted the attention of researchers during the last 15 years. However, relevant literature is still limited, results are fragmented and there is no framework to address fully the management of customer involvement (CI) in the new service development (NSD) process.

The purpose of this study is twofold, to provide an overview of the literature regarding the involvement of customers in the development of new services and to offer guidelines for future research. Results of this review will help researchers identify the critical issues and concepts related to CI in NSD and shape future research in the field. This is a timely contribution since the importance of the role of customers has increased exponentially during the last few years due to the advent of the Internet and therefore, it is important for firms to manage effectively customer contributions to NSD.

The paper is structured as follows. First, we explain the methodology followed; then we present the results of the review; thirdly we identify the emerging, contemporary issues that need attention and finally we conclude with guidelines for future research.

## **RESEARCH METHODOLOGY**

This review includes the analysis of peer-reviewed literature on CI in NSD. So, all papers included in this review approached CI from the perspective or “co-creation for others” (Witell, Kristensson, Gustafsson, and Löfgren, 2011), that is participating in developing services that can benefit other customers. In order to select articles for inclusion, a set of selection criteria was set. The first was that only academic papers will be used. Practitioner articles were excluded. Secondly, all papers selected had to do with CI in NSD either directly, when the title or the text included these two constructs (CI referred to also as user involvement or co-creation and NSD referred to also as service innovation), or indirectly, because it was inferred by the content of the paper. Conceptual papers and literature reviews were not included in this study. Finally, only papers that used services as a context of investigation were analysed. Relevant papers in product markets were not included in this review.

In order to identify relevant papers a search was initially made on three major business journal databases, namely EBSCO (Business Source Complete), Emerald, and ScienceDirect, using various keywords that appear in the title, abstract or keywords fields. Keywords used included customer involvement, new service development, service innovation, user involvement, co-creation, and customer participation. Carlborg, Kindström, and Kowalkowski (2014) conclude that the first CI paper in services has been published in 2002 so the search was limited to articles published between 2002

and 2016. This search identified a large number of papers (more than 100). However, many of these papers analysed CI from the perspective of co-production in service delivery and many others involved product markets. So, each paper was evaluated individually to determine whether it should be included in the review. Also, all cross-references identified were analysed. Ultimately, a total of 37 studies (from 2002 to 2016) were selected for examination.

The first phase of analysis involved reading all papers in chronological order and gain a total perspective of the evolution of research in the field. In the second step, we tried to categorize the information contained in the from all papers. Eventually, there were seven categories of information analysed: theoretical positioning (the type of service customers (B2B or B2C); the type of perspective (seller or buyer side); the type of service or services involved, and the country from which the sample was drawn); stages of NSD investigated; antecedents of CI; nature and dimensions of CI; consequences of CI; emerging contemporary issues, and future research challenges. From the reading of all papers it became evident that these categories of information are suitable for presenting in detail the content of all papers.

## RESULTS

### *General Observations*

Studies on CI in NSD begin in 2002 (Alam, 2002) but there is an increasing interest in the subject from 2012 onwards. Papers mainly appear in services or new product development journals. Services Journals (Journal of Service Management, Journal of Services Marketing, Journal of Service Research, the Service Industries Journal, International Journal of Quality and Service Sciences and Managing Service Quality) have published more than half of papers (54%) whereas Product Innovation Journals (Journal of Product Innovation Management, Creativity & Innovation Management; Innovation: Management, Policy and Practice, International Journal of Innovation Management, and International Journal of Innovation Science) have published 19% of papers. The rest are split between business-to-business area publications, mainline marketing and management journals and specialized journals that deal with a specific industry (e.g. tourism or banking). This focus on service journals is expected since the subject analyzed deals with the development of new services.

Furthermore, we observe that 18 studies examine the seller side; 12 explore buyers' perspectives in retail services (financial, hotels, hospitals etc.) and seven (7) studies consider both sides of the dyad, buyer and seller. Only 10 (27%) studies are in business-to-business markets and 27 (73%) in retail markets. Moreover, the majority of studies are done in Europe (59%) and within Europe mainly in Scandinavian countries and Spain. The rest of the studies concern the USA, Asia (mainly Taiwan) or

Australia. There is one study that covers USA, Europe, and Asia and therefore, is considered global and two studies that are done online and therefore are not bound to any specific country.

### *Methodology*

In terms of methodology the first studies in the area were mainly qualitative (case studies and interviews) and experiments. However, surveys started increasing from 2012 onwards because the field started to mature and new types of qualitative research emerge such as netnography and action research. Overall, 16 studies are qualitative and 19 quantitative.

### *NSD Stages*

It is important to note that the focus on different stages tends to change as the field matures. In the early years up to 2009 most studies focused on the first stages of the NSD process or even only on idea generation. However, from 2010 onwards researchers prefer to analyze CI in the whole NSD process by considering all stages. In total, 18 studies explore all stages of the NSD process and another four investigate CI irrespective of stage.

### *Antecedents of CI*

The study of antecedents of CI is not very extensive. However, the main antecedents analyzed are classified into three categories:

1. Type of customer that should be involved. Various studies investigate the role of different types of customers such as close and lead (Alam, 2011b; Schumacher and Kuester, 2012), ordinary or guided or consulted or pioneering (Magnusson, Matthing, and Kristensson, 2003; Kristensson et al., 2004; Magnusson, 2009).
2. Key customer characteristics for effective involvement. A number of characteristics are investigated including proactiveness (Alam, 2011b); knowledge and experience (Alam, 2011a, b; Schumacher and Kuester, 2012; Sigala, 2012); being in a close, trusting relationship with the provider (Nicolajsen and Scupola, 2011; Alam, 2011b; Carbonell et al., 2012); lead usersness (Alam, 2011b; Carbonell et al., 2012); customer motives; desires, and emotions (Engstrom and Elg, 2012), and involvement or dissatisfaction with the service (Schumacher and Quester, 2012).
3. The environment. This is mainly shown in Carbonell's work (Carbonell et al., 2009; Carbonell and Escudero, 2014, 2015) where the influence of technological turbulence is investigated.

### *Nature and Dimensions of CI*



The concept of CI has not been determined yet and no formal scale exists so researchers try to conceptualize it by using various types of information. The conceptualization of CI is focused on 4 types of dimensions.

1. Intensity of involvement in each NSD stage (Alam, 2002; 2006; Melton and Hartline, 2010; Paasi, 2014). However, there is no agreement on how intensity can be measured and whether involvement should be intense in all stages.
2. Modes of involvement including focus groups; taking part in an NSD team; retreats; phones, faxes and emails, and brainstorming (e.g. Alam, 2002; 2006) as well as web-based tools such as social media or virtual communities (Ryzhkova, 2012; Sigala, 2012).
3. Communication with customers that focuses on communication skills (Athanasopoulou and Johne, 2004); interaction tactics (Alam, 2011b) and the communication process involved in co-creation (Gustafsson et al., 2012).
4. Managing CI effectively through the NSD process. This area includes studies on how to select the right customers for involvement (Magnusson et al., 2003; Kristensson et al., 2004; and Magnusson, 2009) and in which stages should customers be involved. For example, Melton and Hartline (2015) argue that customers should be involved only in the design stage in the development of radical service innovations. Furthermore, other studies emphasize that the effective management of CI should be characterized by collaborative capabilities; customer orientation; knowledge integration capabilities; effective information recording; reviewing and use; appropriate user motivation and getting users to derive ideas from personal experiences (Kristensson et al., 2008; Ordanini and Parasuraman, 2011; Carbonell and Escudero, 2014;2015; Zhihong et al., 2015).

#### *Consequences of CI*

Another category of variables analyzed by CI researchers involves different types of performance of new services, one financial and three non-financial:

1. Financial performance in terms of sales or profit (Carbonell et al., 2009; Chien and Chen, 2010; Melton and Hartline, 2010; 2015; Weng and Huang, 2012) although most of the time they are not considered alone.
2. Idea quality that is conceptualized with measures such as radicality/innovativeness (Ordanini and Parasuraman, 2011; Melton and Hartline, 2015); novelty/originality (Magnusson et al., 2003; Kristensson et al., 2004, Matthing, Sanden, and Edvardsson, 2004; Magnusson, 2009; Mahr and Lievens, 2012; Carbonell et al., 2012; Carbonell and Escudero, 2014, 2015); perceived value; feasibility or producibility (Magnusson et al., 2003; Kristensson et al., 2004, Matthing et al., 2004;

Magnusson, 2009); knowledge value and relevance (Mahr and Lievens, 2012), volume of ideas (Ordanini and Parasuraman, 2011) and quality of service ideas (Schumacher and Quester, 2012).

3. The quality of the developed service that is measured with concepts such as service quality (Dadfar et al., 2013); service advantage (Carbonell et al., 2012; Carbonell and Escudero, 2014, 2015); superior and differentiated service (Alam, 2002, 2006; Alam and Perry, 2002), and service marketability (Melton and Hartline, 2010).
4. The effectiveness of the development process expressed with many different concepts including process complexity (Melton and Hartline, 2015); speed to market (Alam, 2002, 2006; Alam and Perry, 2002; Athanasopoulou and John, 2004; Carbonell et al., 2012; Carbonell and Escudero, 2014;2015); launch preparation (Melton and Hartline, 2010); role flexibility; teamwork, and cross-functional integration (Chien and Chen, 2010), and overall measures of project (Melton and Hartline, 2010) or process efficiency (Chien and Chen, 2010).
5. Customer satisfaction used in two recent studies (Dadfar et al., 2013; Zhihong et al., 2015). This trend is probably due to the increasing importance that relationships play in CI and customer satisfaction is a major dimension of relationship quality.

#### *Moderating Variables*

The use of moderating variables in CI studies is quite rare. Only Carbonell et al. (2012) and Carbonell and Escudero (2014, 2015) use technological turbulence.

#### *Emerging Contemporary Issues*

The study of CI in NSD reveals the existence of certain important current issues that surface in related research and are expected to guide future research. These include the following:

1. Effectiveness of CI depends on how well the process is managed. CI should be approached as a management process with specific managerial practices that lead to success. Such practices should cover areas such as selecting the best customers for involvement; communicating effectively throughout the NSD process; motivating customers and integrating the knowledge acquired.
2. The selection of stages for CI is not very important in services. Since services have more ad hoc, parallel processes with fewer stages, differentiating CI by stage is not important. What is critical though is to identify the ways CI can become more effective in each stage. For example, researchers should look into which customer or firm actions should be included in each stage and why.
3. The last few years, research on CI in NSD has emphasized the importance of a close relationship with customers. Therefore, firms should select customers that have a close relationship with the

firm for CI. Also, other relationship constructs such as customer satisfaction (a major dimension of Relationship Quality) and service quality are linked to CI. So, there is a need to explore further the role of relationships in effective CI.

4. Many qualitative studies in CI have shown that it is important to get users to derive ideas from their use experiences because experiences create emotions and make it easier for customers to express their needs. Therefore, it is important to understand and manage effectively customer experiences because they can influence CI in NSD. Further analysis of how firms can manage customer experience in relation to CI for NSD is imperative.
5. Selecting customers for CI in NSD is different from New Product Development. Lead customers may not be as useful here. Also, selection of customers will depend on the type of new service sought (incremental or radical). Research shows that for radical innovation, ordinary users are more useful because they have more radical ideas whereas experienced or skilled users are better for incremental innovation. So, the development of guides of customer selection is an important contemporary issue.
6. Due to the advent of the Internet and its importance in the market, another contemporary issue is the role of virtual environments in CI. Related studies look into the role of virtual customer integration platforms in NSD; the use of web-based tools for CI; the nature of lead user participation in brand communities; CI in online channels such as social media and effective management of consumer-generated content.

#### *Future Research Challenges*

Based on the insights of this review we offer a guide for future research.

- In terms of methodology there is a need for more rigorous quantitative studies and more focused and detailed qualitative enquiries that will provide more specific and rich information that will help firms manage the process of CI effectively. Also, the perspectives of both buyers and sellers should be included in future research since the quality of collaboration or relationship is important for new service success.
- More research is needed on the types of customers that are useful for CI. There is a need to develop guides of appropriate customers according to the type of information sought or the type of service developed.
- The nature of CI during NSD needs to be analysed more thoroughly. Specifically, we need answers to the following questions. How do we involve customers (modes) and how intensively?

Which types of customer contributions are sought and under which circumstances? What roles do customers play in CI? Which practices and which customer actions are appropriate for each stage or group of stages of the NSD process? What type of relationship should firms have with customers that get involved in NSD? How should firms communicate with customers and which communication skills should firms have to communicate effectively?

- Measures of new service performance on the project or program level should be analysed further and research should conclude whether it is best to use more financial or non-financial measures and why.
- The use of virtual environments or web-based tools used to transfer customer knowledge to companies should be one the key areas of research in the following years since there is a wealth of customer-supplied information that can only be exploited through online media. The question is how companies can use this data for NSD.
- Finally, future research should address the role of relationships in CI. Specifically, it is important to investigate the role of various relationship concepts (e.g. satisfaction, relationship closeness, relationship quality) in CI and their inter-relationships with service innovation concepts such as effective CI or new service success.

## REFERENCES

- Alam, I. 2002. An exploratory investigation of user involvement in new service development. *Journal of the Academy of Marketing Science*, 30(3): 250-261.
- Alam, I. 2006. Removing the fuzziness from the fuzzy front-end of service innovations through customer interactions. *Industrial Marketing Management*, 35(4): 468-480.
- Alam, I. 2011a. Key customer characteristics for customer-oriented innovation in Australian financial services industry. *Journal of Services Research*, 11(1): 41-60
- Alam, I. 2011b. Process of customer interaction during new service development in an emerging country. *The Service Industries Journal*, 31(16): 2741-2756.
- Alam, I., and C. Perry. 2002. A customer-oriented new service development process. *Journal of Services Marketing*, 16(6): 515-534.
- Athanassopoulou, P., and A. Johne. 2004. Effective communication with lead customers in developing new banking products. *International Journal of Bank Marketing*, 22(2): 100-125.
- Carbonell, P., A.I. Rodríguez-Escudero, and D. Pujari. 2009. Customer involvement in new service development: An examination of antecedents and outcomes. *Journal of Product Innovation Management*, 26(5): 536-550.
- Carbonell, P., A.I. Rodríguez-Escudero, and D. Pujari. 2012. Performance effects of involving lead users and close customers in new service development. *Journal of Services Marketing*, 26(7): 497-509.
- Carbonell, P., and A.I. Rodríguez-Escudero. 2014. Antecedents and consequences of using information from customers involved in new service development. *Journal of Business & Industrial Marketing*, 29(2): 112 – 122.
- Carbonell, P., and A.I. Rodríguez-Escudero. 2015. The negative effect of team's prior experience and technological turbulence on new service development projects with customer involvement. *European Journal of Marketing*, 49(3/4): 278 – 301.
- Carlborg, P., D. Kindström, and C. Kowalkowski. 2014. The evolution of service innovation research: a critical review and synthesis. *The Service Industries Journal*, 34(5): 373-398.
- Chien, S.H., and J.J.Chen. 2010. Supplier involvement and customer involvement effect on new product development success in the financial service industry. *The Service Industries Journal*, 30(2), pp.185-201.

- Dadfar, H., S. Brege, and S.S.E. Semnani. 2013. Customer involvement in service production, delivery and quality: the challenges and opportunities. *International Journal of Quality and Service Sciences*, 5(1): 46-65.
- Engström, J., and M. Elg. 2015. A self-determination theory perspective on customer participation in service development. *Journal of Services Marketing*, 29(6/7): 511-521.
- Gustafsson, A., P. Kristensson and L. Witell. 2012. Customer co-creation in service innovation: a matter of communication?. *Journal of Service Management*, 23(3): 311-327.
- Kindström, D., and C. Kowalkowski. 2009. Development of industrial service offerings: a process framework. *Journal of Service Management*, 20(2): 15-172.
- Kristensson, P., A. Gustafsson, and T. Archer. 2004. Harnessing the creative potential among users. *Journal of Product Innovation Management*, 21(1): 4-14.
- Kristensson, P., J. Matthing, and N. Johansson. 2008. Key strategies for the successful involvement of customers in the co-creation of new technology-based services. *International journal of service industry management*, 19(4): 474-491.
- Magnusson, P. R., J. Matthing, and P. Kristensson. 2003. Management user involvement in service innovation. *Journal of Service Research*. 6(2): 111-124
- Magnusson, P.R. 2009. Exploring the contributions of involving ordinary users in ideation of technology-based services. *Journal of Product Innovation Management*, 26(5): 578-593.
- Mahr, D., and A. Lievens. 2012. Virtual lead user communities: drivers of knowledge creation for innovation. *Research Policy*, 41(1): 167-177.
- Matthing, J., B. Sanden, and B. Edvardsson. 2004. New service development: learning from and with customers. *International Journal of Service Industry Management*. 15(5): 479-498.
- Melton, H., and M. Hartline. 2010. Customer and frontline employee influence on new service development performance. *Journal of Service Research*, 13(4): 411-425.
- Melton, H., and M.D. Hartline. 2015. Customer and employee co-creation of radical service innovations. *Journal of Services Marketing*, 29(2): 112-123.
- Nicolajsen, H.W, and A. Scupola. 2011. Investigating issues and challenges for customer involvement in business services innovation. *Journal of Business & Industrial Marketing*, 26(5): 368-376.
- Ordanini, A., and A. Parasuraman. 2011. Service innovation viewed through a service-dominant logic lens: a conceptual framework and empirical analysis. *Journal of Service Research*, 14(1): 3-23.
- Paasi, J., I. Lappalainen, T. Rantala, and M. Pikkariainen. 2014. Challenges for product and service providers in open innovation with customers in business-to-business markets. *International Journal of Innovation Management*, 18(2): 1-27.
- Ryzhkova, N. 2012. Web-based customer innovation: a replication with extension. *Innovation: Management, Policy & Practice*. 14(3): 416-430.
- Schuhmacher, M.C., and S. Kuester. 2012. Identification of lead user characteristics driving the quality of service innovation ideas. *Creativity and Innovation Management*, 21(4): 427-442.
- Sigala, M. 2012. Social networks and customer involvement in new service development (NSD): the case of [www.mystarbucksidea.com](http://www.mystarbucksidea.com). *International Journal of Contemporary Hospitality Management*, 24(7): 966 – 990.
- Weng, R-H., and C-Y. Huang. 2012. The impact of customer knowledge capability and relational capability on new service development performance: the case of health service. *Journal of Management and Organization*. 18(5): 608-624.
- Witell, L., P. Kristensson, A. Gustafsson, and M. Löfgren. 2011. Idea generation: customer co-creation versus traditional market research techniques. *Journal of Service Management*, 22(2): 140-159.
- Zhihong, L., C. Duffield, and D. Wilson. 2015. Research on the driving factors of customer participation in service innovation in a virtual brand community. *International Journal of Innovation Science*, 7(4): 299-309.

## **SOCIAL MEDIA IMPACT ON NPO BRAND EQUITY: CONCEPTUALIZING THE TRENDS AND PROSPECTS**

**Belenioti, Zoe- Charis<sup>1</sup>; Vassiliadis, Chris A.<sup>2</sup>**

<sup>1</sup>Faculty of Economic & Political Science/ Dept. Journalism & Mass Communications, Aristotle University of Thessaloniki, AUTH, Thessaloniki, Greece

<sup>2</sup>Department of Business Administration, University of Macedonia, UOM Thessaloniki, Greece

### **ABSTRACT**

Previous studies have shown the correlation between marketing communication mix and branding outcomes. Upon the emergence of Web 2.0, influential researchers have highlighted the need for further investigation on how branding models such as the brand equity dimensions (brand awareness, perceived quality, association and brand loyalty) are reshaped or formulated (Berthon, Pitt, Plangger, & Shapiro, 2012; Bruhn et al., 2012; Hennig-Thurau et al., 2010; Kapoor, et al, 2013; Keller, 2009). Nevertheless the advent of social media resurged scholars' attention, still literature into branding equity within social media is extremely limited and fragmented given the embryonic stage of social media research (Bruhn et al., 2012; Langaro et al., 2015 ; Kuvykaite & Piligrimiene 2014 ; Belenioti, 2015; Belenioti et al., 2015; Vassiliadis & Belenioti, 2015 ; Belenioti & Vassiliadis 2016). Thus, both for profit (Kuvykaite & Piligrimiene 2014) and non- profit organizations (NPOs) have been failing to successfully reap all the social media benefits within branding (Belenioti & Vassiliadis, 2016; Vassiliadis & Belenioti, 2015). So far, no single study investigates the impact of social media on brand equity within the non-profit sector. Following the call of Barreda et al. (2015), this study seeks to remedy this problem by conceptualizing the literature of the social media impact on NPOs' brand equity and by providing a new research agenda. For first time, this interdisciplinary project makes a major contribution by enhancing our understanding the link between social media and brand equity in NPOs and by suggesting a new research agenda and managerial implications.

*Keywords: social media, social media branding, branding, brand equity, non- profit organizations (NPOs), npos branding, e-branding*

### **INTRODUCTION**

Since the 1980s, not only have nonprofit organizations (henceforth NPOs) grown but they have also been repeatedly showing their overall positive contribution to our modern society (Laidler-Kylander

2007; Laider-kylander & Simonin 2007; Krueger & Haytko 2015). In the USA, nonprofit organizations are defined as “incorporated entities that qualify for exemption from federal income tax.” (Ibsen and Habermann, 2005:15). According to this definition, voluntary organizations are defined by “legislation or rules laid down by public authorities” (Ibsen & Habermann 2005). Given classification developed by Salamon and Anheier (1996), NPOs has a multidisciplinary character by presenting a wide variety of sectors; from healthcare to recreation services, governmental, non- governmental (NGO’s), or charitable organizations (Salamon & Anheier 1996).

Moreover, Salamon (2000) clarifies that unlike the for profit organizations’ (henceforth FPOs) reality, the *raison d’être* of NPOs is to alleviate global problems instead of raising corporate profits. However, several changes at economical, technological and societal level such as the economic crisis, the increasing need of NPOs for financial viability along with the increasing competition and technological advances (advent of social and digital media) have exhort NPOs to deploy FPOs marketing models (Hudson 2007; Sargeant 2008 ; Laidler-Kylander, and Simonin 2007 ; Dolnicar and Lazarevski, 2009). Nevertheless, still there is a fierce debate regarding branding within NPOs, as while the majority of marketing researchers embrace the beneficial role of branding towards NPOs’ sustainability, the majority of NPOs practitioners appears tentative.

Web 2.0 has definitely emerged new opportunities and challenges for any organization. Particularly, “... social media applications are becoming the new communication status quo” (Belenioti et al., 2015:1). Social media offer a dialogic, well targeted and economic communication. Social media instruments have extended the notion of interaction. However, though NPOs have integrated Web 2.0 tools, they have adopted one way communication, totally different to the e-marketing orientation (Quinton & Fennemore, 2013; Nah & Saxton, 2012) . In addition, previous studies have shown the correlation between traditional and digital marketing communication tools and branding performance (Berthon, et al, 2012; Bruhn et al., 2012; Hennig-Thurau et al., 2010; Kapoor, et al, 2013; Keller, 2009). Nevertheless the advent of social media resurged scholars’ attention, still literature into branding equity within social media is extremely limited and fragmented given the embryonic stage of social media research (Bruhn et al., 2012; Langaro et al., 2015; Kuvykaite & Piligrimiene 2014; Belenioti, 2015; Belenioti et al., 2015; Vassiliadis & Belenioti, 2015; Belenioti & Vassiliadis 2016). Thus, both for profit (Kuvykaite & Piligrimiene 2014) and non- profit organizations (NPOs) (Belenioti & Vassiliadis, 2016; Vassiliadis & Belenioti, 2015) have been failing to successfully reap all the social media benefits within branding. However, this scarcity may be explained by the infant character of this research stream and the social media (Langaro et al., 2015). Thus, far, no single study investigates the impact of social media on brand equity within the non- profit sector. Following the call of various scholars ( Barreda et al. 2015; Kuvykaite and Piligrimiene, 2014; Belenioti & Vassiliadis, 2016; Vassiliadis & Belenioti, 2015) this

study seeks to remedy this problem by conceptualizing the literature of the social media impact on NPOs' brand equity and by providing a new research agenda.

This paper makes a substantial contribution by enhancing our understanding the link between social media and brand equity in NPOs and by suggesting a new research agenda and managerial implications. Particularly, drawing conclusions on 72 papers we reviewed, classified and conceptualized all the available studies by 2017 regarding social media impact and brand equity both within FPOs and NPOs. Given the dearth of studies in NPOs sector, by harnessing the FPOs models within NPOs context, we also suggest a new conceptual model on the social media and NPOs' brand equity.

## THEORETICAL UNDERPINNINGS

### *NPOs in a Nutshell; understanding the value of NPOs in our life*

Evidently, NPOs present a wide variety of service embrace multiple roles such as innovation, advocacy, expressive, and community-building roles in multidisciplinary fields. From healthcare to recreation services, governmental, non-governmental (NGO's), or charitable organizations (Salamon & Anheier 1996) "NPOs are actively engaged in providing services, but doing so with a 'plus'" (Krueger and Haytko, 2015:5)

Moreover, Salamon (2000) juxtaposes that unlike FPOs, the *raison d'être* of NPOs is to alleviate global problems instead of raising corporate profits. Particularly, "[...] the purpose of Non-Profit Organizations (NPOs) is to contribute to and create "social value" in society (Lettieri et al., 2004, p.16)." (Rathi, 2014: 1). The literature on the differential points of NPOs has highlighted six basic characteristics: they are formal, private; self-governing; non-profit distributing; voluntary and collaborative by engaging on share interest, and of public benefit (Salamon and Anheier 1996). Precisely, Oster (1995) and Nah and Saxton, (2012) have urged NPOs to embrace FPOs tactics by deploying more collaborative rather than competitive approaches and by examining thoroughly both their stakeholders' complexity and the importance of their social mission.

### *Towards an FPOs orientation within NPOs context: the NPOs' branding boom*

Several challenges such as reduction of financial support, increasing need for reliance to private sector, growing competition within NPOs industry have propelled them into an FPOs' marketing and branding orientation (Sargeant 2008 ; Laidler-Kylander, and Simonin 2007; Dolnicar and Lazarevski, 2009). Hankinson & Rochester (2005) define as NPOs branding "the deliberate and active management of a bundle of perceptions, both tangible and intangible' in order to communicate consistent and coherent messages to stakeholders" (2005:2).



To Dolnicar and Lazarevski (2009), branding within NPOs still remains a controversial issue; while a majority of NPOs practitioners view branding as a sole business activity, a growing number of marketing researchers as NPOs' branding ardent supporters view branding as the source of NPOs' sustainability and differential advantage (Laidler-Kylander, et al 2007; Waters *et al.*, 2009; Nah and Saxton, 2012; Guo and Saxton, 2013; Belenioti, Tsourvakas and Vassiliadis, 2016; Belenioti, et al ., 2017; Vassiliadis and Belenioti, 2015; Belenioti and Vassiliadis, 2016 ; Khare, 2011). Besides, Williams (2011) believes that technological advances such as the web explosion extol cultural NPOs towards this branding boom.

#### *The importance of NPOs branding*

Recent evidence suggests that NPOs branding is solely focused on building robust psychological associations given their unique nature (Stater, 2009; Vassiliadis and Belenioti, 2015). Evidently, as Stater (2009) states “ [...] NPOs products are often vague and intangible, such as ‘raising awareness’ and ‘ending poverty’. Pricing is difficult in the absence of competitive pressures and traditional measures of production cost and consumer willingness to pay.” (2009:1).

Nonetheless, due to the scarce research within NPOs marketing, several influential researchers have repeatedly encouraged to apply the FPOs marketing framework and harness sectoral marketing knowledge to nonprofit organizations (Stater, 2009; Pope, et al, 2009; Gürel and Kavak, 2010; Chad, et al., 2013). Particularly, the literature has emphasized the importance not only of marketing orientation but also of branding application in NPOs (Padanyi, 2008; Kylander and Stone, 2012). To Laidler-Kylander and Simonin (2012) seven variables drive brand equity: focus, consistency, partnerships, awareness, trust, globalness, and distinctiveness.

Kotler & Keller (2012) agree that brands have served as a means of differentiation and catalyst of financial value for firms. Despite the distinguish nature of NPOs, harnessing branding in this context reveals various similarities with FPOs context. Just as in FPOS, the ultimate scope of NPOs branding is to create differences by delivering a unique identity in consumer minds (Kotler & Keller; 2012; ; Yoo et al., 2000; Aaker, 1992; Keller, 2001; Belenioti and Vassiliadis, 2016). Moreover, both in FPOS and NPOS branding offers various benefits in terms of financial and societal performance (Kolb, 2013; Vassiliadis and Belenioti, 2015). First, through successful branding and positioning NPOs acquire a strong and memorable brand personality that in turn cultivates the brand awareness, build trust and customer loyalty (Stater 2009). Second, a strong NPOs brand with a high brand awareness attract more donors and increase its effectiveness (Wyners & Knowles, 2006; Hudson, 2007; Hankinson & Rochester, 2005; Kylander & Stone, 2012; Stater 2009). Third, from the societal relationship perspective a strong NPOs brand boost the ties with its stakeholders through the consistency and coherence that is achieved in branding (Hudson, 2007; Kylander & Stone, 2012). However, “although having strong brand equity is

certainly no panacea, it is critical for raising funds, implementing the organization's mission and protecting employees and volunteers" (Laidier-kylander and Simonin, 2007 :4 ):-

*Classification of the state of the art within social media brand equity juxtaposition of NPOs and FPOs context*

"The concept of marketing communication tools along with Integrated Marketing Communication (IMC) tools is central to brand equity of any service or product (Keller,1993, 1999, 2001, 2009; Yoo et al.; 2000)" (Belenioti, et.al., 2017:3) both in FPOs and NPOs sector. First, Aaker (1991), recognizes the significant effect of marketing efforts including communication on brand equity. Second, examining how to develop a measurement model of brand equity, Simon and Sullivan (1993) observes that marketing communications as one of the sources driving brand equity. Parallel to, from 1993 to 2009 Keller with his colleagues (Keller,1993, 1999, 2001, 2009; Keller and Lehmann, 2003) repeatedly show the great effect of marketing communication on brand equity. Years later on, Yoo et al. (2000) reproduce Aaker's model by examining the marketing mix efforts as drivers of brand equity. Their study reveals that marketing efforts have a positive influence on all components of brand equity (brand loyalty, brand association, brand awareness and perceived brand quality). Moreover, Chattopadhyay &Shivani (2009) show that both direct and indirect marketing mix have a direct impact on brand equity of a product.

Upon the emergence of Web 2.0, Keller (2009) view marketing communications activities as driver of brand equity and sales.. He also urges scholars to, to explore the influence of e-media on branding in our connected and virtual world (Keller, 2009). Parallel to, "social media is becoming 'an ideal, cost effective, interactive and, above all, targeted communication tool for every organization thanks to its high consumer engagement offered through the eWOM and web- interactivity' (Belenioti et al., 2015:2)" (Belenioti, 2017).Indeed, social media do create a co-value for any product or service that can be communicated and have a significant contribution to the branding and the business to consumer conversation (Langaro et al., 2015; Gensler et al.,2013; Mangold & Faulds, 2009; Bruhn et al., 2012; Weinberg & Pehlivan, 2011).

Therefore, the emergence of these digital technologies has upset the previous theory about the brand or corporate image (Barreda, et, al 2015;Mangold & Faulds, 2009; Bruhn et al., 2012; Kirtiş & Karahan, 2011; Moretti & Tuan, 2014; Weinberg & Pehlivan, 2011; Hutter, et, al., 2013). For instance, nowadays more and more organizations, such as Domino's Pizza, Coca- Cola, Dove or luxury fashion houses such as Luis Vuitton, Gucci, and Chanel, (Kim & Ko 2012) replace traditional media with social media communication. Other brands, both within FPOs & NPOs sector, "humanize" their voice in the social media arena in order to stimuli their audience so as to communicate, to co- create or even to get involved to a social cause under their brand-name (ex ice bucket challenge)(Nah & Saxton 2012; Quinton & Fennemore 2013; Waters & Jones 2011a; Waters & Jones 2011b). Especially for NPOs, social

media offer vast benefits such as low cost, dialogic and direct communication, engagement boost, increase of brand awareness and most importantly community building (Nah & Saxton 2012) along with the donors engagement (Stefanone et al., 2012). Consequently, "...This is where the power of social media can be a game changer .." (Lucky and Rathi, 2013:15).

*The state of the art in social media impact on the NPOs brand equity*

A considerable amount of literature has been published on the use of social media within NPOs context. However, most scholars in the field have merely focused on the frequency, reason and way of social media use (Nah and Saxton, 2012;; Lovejoy and Saxton, 2012; Waters et al., 2009) have examined any aspect of nonprofits' social media use. Other studies highlight common challenges that NPOs have to overcome ,such as the lack of social media integration at a strategic and tactical level (Fletcher & Lee, 2012; Berthon et al., 2012; Hausmann, 2012a; Waters et al., 2009; Lehman & Roach, 2011) or the lack of dialogic communication (Lovejoy and Saxton, 2012; Waters et al., 2009; Nah and Saxton, 2012). Another common strand is the integration of social media in the NPOs context (Stater, 2009; Khare, 2011; Lovejoy and Saxton, 2012; Waters et al., 2009; Waters and Jones, 2011; Nah and Saxton, 2012; Quinton and Fennemore, 2013; Krueger and Haytko, 2015) or the use of social media as Knowledge Management tool (Lucky and Rathi, 2013; Given, Forcier and Rathi, 2013). In addition, donor engagement and development along with volunteer recruitment and engagement is a dominant feature of the recent bibliography (Cool and Watkins, 2012; Boote, Telford and Cooper, 2002; Stefanone *et al.*, 2012). Similarly, to FPOs context, again, the impact of social media on NPOs' brand equity is understudied. No single study investigates the impact of social media on brand equity. Thus, given the dearth of studies, based on the knowledge from FPOs models we propose the following research statement by developing a conceptual model.

*The state of the art in social media impact on the FPOs brand equity*

Given the available recent bibliography, so far only 14 studies have analyzed how social media affect the brand equity dimensions. Precisely only 5 studies deal with the impact of social media on brand awareness (Coursaris, et al., 2013; Hutter et al., 2013; Hassan Zadeh and Sharda, 2014; Barreda et al., 2015; Jensen et al., 2015; Langaro, et al., 2015), 6 studies solely explore the social media impact on brand equity ( Christodoulides and Chernatony, 2010; Leek and Christodoulides, 2011; Bruhn, et al., 2012; Kim and Ko, 2012; Kuvykaite and Piligrimiene, 2014; Kananukul et al., 2015), two studies examine the social media impact on brand loyalty (Laroche et al. 2012; Zheng et al. 2015), while only one study analyzes the impact of social media on consumers' brand perception (Barajas-Portas 2015) Overall, all these studies below clearly indicate that there is a relationship between the social media use and the FPOs' brand equity enhancement .

Research Strands in social media& FPOs branding	Authors
Social media boost brand awareness	Coursaris, Osch and Balogh, 2013; Hutter et al., 2013; Hassan Zadeh and Sharda, 2014; Barreda et al., 2015; Jensen et al., 2015; Langaro, et.al., 2015
Social media boost brand equity	Christodoulides and Chernatony, 2010; Leek and Christodoulides, 2011; Bruhn, Schoenmueller and Schäfer, 2012; Kim and Ko, 2012; Kuvykaite and Piligrimiene, 2014; Kananukul, et al., 2015
Social media affects consumers' brand perception	Barajas-Portas, 2015

Table 1. *Classification of studies on social media and branding*

First, as cited in Bruhn et al. (2012), Stephen and Galak (2009) found that both social and traditional media have significant influence effects on marketing performance. Two years later, Bruhn et al. (2012) Bruhn et al. (2012) also confirm that traditional media has a stronger impact on brand awareness.

In a study investigating the impact of social media activities of luxury fashion brands on value equity, relationship equity, brand equity, customer equity, and purchase intention through a structural equation model, Kim & Ko (2012) show the positive influence of social media marketing on value equity, relationship equity, and brand equity. Moreover, they identify the five constructs of perceived social media activities of luxury fashion brands are entertainment, interaction, trendiness, customization, and word of mouth. They also applaud the contribution of social media on brand and customer equity urging firms to improve their social media communication. However, the study reveals a negative relationship between brand equity and purchase intention in the case of a luxury fashion brand.

In 2014, Kuvykaite & Piligrimiene (2014) examining how consumer engagement correlates with brand equity creation in the social media context, developed an integrated conceptual model comprised of several different constructs. Results show that the most influential stimuli/actions for consumer engagement may have several forms engagement (organizational socialization techniques; helping the customer to understand its expectations; developing its customers' ability to participate; motivating the customer to participate) and may correspond to different level and objects (creation of new products and brand marketing communications, brand buying process).

Similarly, Kananukul et al. (2015) argue that marketing programs contribute on behavioral loyalty through the relationships that are developed during this interaction. Their study links brand trust with brand loyalty and shows that brand loyalty affects customer equity relative to number of purchases and purchase volume, in line with previous findings (Assael, 1992; Dick and Basu, 1994; Keller, 1993). Finally, Lanka, (2016) indicate a positive correlation between social media marketing and brand equity of online companies, while Zailskaite-Jakste and Kuvykaite,(2016) based on a recent

systematic review asserting the relationship between social media and consumer based brand equity developed a conceptual model.

Summing up, the recent literature confirms the association between social media and brand equity along with social media and brand loyalty. Drawing on an extensive range of sources and harnessing the FPOs theory into NPOS social media use is expected to increase brand equity, that in turns increases brand loyalty and intention to repurchase. Figure 1 presents the proposed conceptual model given the available literature.



Figure 1: *Proposed conceptual model derived from literature*

## CONCLUSIONS, IMPLICATIONS, LIMITATIONS & FURTHER RESEARCH

Based on a literature review analysis, this study set out to delineate and conceptualize the social media impact on NPOs' brand equity. Transferring the knowledge from the FPOs models, this study has shown the positive link between social media and brand equity within NPOs industry. This work contributes to existing knowledge by providing a classification of the recent bibliography and by proposing a new research model as depicted on the recent bibliography. These findings may be somewhat limited by the literature review analysis. However, given the infancy of this research field, there is abundant room to explore empirically the influence of social media within this proposed model in different categories NPOs sector (ex. healthcare and cultural NPOs) and to juxtapose potential differences.

## REFERENCES

- Aaker, D. (1992) 'The value of brand equity', *Journal of business strategy*. Available at: <http://www.emeraldinsight.com/journals.htm?articleid=1706628&show=abstract> (Accessed: 10 October 2014).
- Barajas-Portas, K. (2015) 'The Impact of Consumer Interactions in Social Networking Sites on Brand Perception', *Journal of Internet and e-Business Studies*, 2015(1), pp. 1–5. doi: 10.5171/2015.197131.
- Barreda, A. a., Bilgihan, A., Nusair, K. and Okumus, F. (2015) 'Generating brand awareness in Online Social Networks', *Computers in Human Behavior*. Elsevier Ltd, 50, pp. 600–609. doi: 10.1016/j.chb.2015.03.023.
- Belenioti, Z. C. (2015) 'A snapshot of Greek social media users', in *A snapshot of Greek Social Media Users*, pp. 1–15. Available at: <http://meaningacrossmedia.mcc.ku.dk/proceedings/>.

- Belenioti, Z. C. (2017). "Greece", ABC-CLIO, Inc., a California corporation. In Marilyn Andrews and Laura Steckman (Ed.), *Online around the World: A Geographic Encyclopedia of the Internet, Social Media, and Mobile Apps*. ABC-CLIO, Santa Barbara, USA, pp. 110-114
- Belenioti, Z. C., Andronikidis, A. I. and Vassiliadis, C. (2015) 'Classifying and Profiling Social Media Users : An Integrated Approach', in *Proceedings of The Second European Conference on Media & Mass Communication*, pp. 183–204. Available at: [http://iafor.org/archives/proceedings/EuroMedia/EuroMedia2015\\_proceedings.pdf](http://iafor.org/archives/proceedings/EuroMedia/EuroMedia2015_proceedings.pdf)
- Belenioti, Z. C., Gkarane Sofia. and Vassiliadis Chris A. (2017) 'The contribution of social media to small scale events: Boosting the city branding& tourism demand through Thessaloniki Food Festival', in *5th International Conference on Contemporary Marketing Issues ICCMI*, June 21-23, 2017 Thessaloniki, Greece. Thessaloniki, Greece, p. 7877.
- Belenioti ZC., Tsourvakas G., Vassiliadis C.A. (2017) A Report on Museum Branding Literature. In: Kavoura A., Sakas D., Tomaras P. (eds) *Strategic Innovative Marketing*. Springer Proceedings in Business and Economics. Springer, Cham.
- Belenioti, Z. and Vassiliadis, C. (2016) 'Branding in the New Museum Era .', in 'Strategic Innovative Marketing: 4th IC-SIM, Mykonos, Greece 2015', 2016, Springer, pp. 115–121.
- Berthon, P. R., Pitt, L. F., Plangger, K. and Shapiro, D. (2012) 'Marketing meets Web 2.0, social media, and creative consumers: Implications for international marketing strategy', *Business Horizons*. 'Kelley School of Business, Indiana University', 55(3), pp. 261–271. doi: 10.1016/j.bushor.2012.01.007.
- Boote, J., Telford, R. and Cooper, C. (2002) 'Consumer involvement in health research: a review and research agenda', *Health policy (Amsterdam, Netherlands)*, 61(2), pp. 213–236. doi: 10.1016/S0168-8510(01)00214-7.
- Bruhn, M., Schoenmueller, V. and Schäfer, D. B. (2012) 'Are social media replacing traditional media in terms of brand equity creation?', *Management Research Review*, 35(9), pp. 770–790. doi: 10.1108/01409171211255948.
- Chad, P., Motion, J. and Kyriazis, E. (2013) 'A Praxis Framework for Implementing Market Orientation Into Charities', *Journal of Nonprofit & Public Sector Marketing*, 25(1), pp. 28–55. doi: 10.1080/10495142.2013.759816.
- Christodoulides, G. and Chernatony, L. (2010) 'Consumer Based Brand Equity Conceptualization & Measurement: A Literature Review', *International Journal of Market Research*, 52(July), pp. 44–53.
- Cool, B. A. and Watkins, S. C. (2012) '501 ( c ) Social Video Series : Social Media Best Practices for Nonprofits in the Digital Age'.
- Coursaris, C., Osch, V. and Balogh, B. (2013) 'Social media marketing typology : classifying brand Facebook page messages for strategic consumer engagement', 21st European Conference on Information Systems, pp. 1–12. Available at: [http://aisel.aisnet.org/ecis2013\\_cr/46/](http://aisel.aisnet.org/ecis2013_cr/46/).
- Dolnicar, S. and Lazarevski, K. (2009) 'Marketing in non-profit organizations: an international perspective', *International Marketing Review*. Edited by P. Chao, 26(3), pp. 275–291. doi: 10.1108/02651330910960780.
- Fletcher, A. & Lee, M.J., (2012). Current social media uses and evaluations in American museums. *Museum Management and Curatorship*, Vol.27, No.5, pp.505–521.
- Gensler, S., Völckner, F., Liu-Thompkins, Y. and Wiertz, C. (2013) 'Managing brands in the social media environment', *Journal of Interactive Marketing*. Elsevier B.V., 27(4), pp. 242–256. doi: 10.1016/j.intmar.2013.09.004.
- Given, L. M., Forcier, E. and Rath, D. (2013) 'Social media and community knowledge: An ideal partnership for non-profit organizations', *Proceedings of the ASIST Annual Meeting*, 50(1). doi: 10.1002/meet.14505001064.
- Guo, C. and Saxton, G. D. (2013) 'Tweeting Social Change: How Social Media Are Changing Nonprofit Advocacy', *Nonprofit and Voluntary Sector Quarterly*, 43(1), pp. 57–79. doi: 10.1177/0899764012471585.
- Gürel, E. and Kavak, B. (2010) 'A conceptual model for public relations in museums', *European Journal of Marketing*, 44(1/2), pp. 42–65. doi: 10.1108/03090561011008600.
- Hankinson, P. and Rochester, C. (2005) 'The face and voice of volunteering: a suitable case for branding?', *International Journal of Nonprofit and Voluntary Sector Marketing*, 10(2), pp. 93–105. doi: 10.1002/nvsm.15.
- Hassan Zadeh, A. and Sharda, R. (2014) 'Modeling brand post popularity dynamics in online social networks', *Decision Support Systems*. Elsevier B.V., 65, pp. 59–68. doi: 10.1016/j.dss.2014.05.003.
- Hennig-Thurau, T., Malhotra, E. C., Frieger, C., Gensler, S., Lobschat, L., Rangaswamy, a. and Skiera, B. (2010) 'The Impact of New Media on Customer Relationships', *Journal of Service Research*, 13(2009), pp. 311–330. doi: 10.1177/1094670510375460.
- Hutter, K., Hautz, J., Dennhardt, S. and Fuller, J. (2013) 'The impact of user interactions in social media on brand awareness and purchase intention: the case of MINI on Facebook', *Journal of Product & Brand Management*, 22(5), pp. 342–351. doi: 10.1108/JPBM-05-2013-0299.
- Hausmann, A., (2012a). Creating "buzz ": opportunities and limitations of social media for arts institutions and their viral marketing. *International Journal of Nonprofit and Voluntary Sector Marketing*, Vol.17, No. 3, pp. 173–182 (2012).

- Hudson, J. (2007). *The branding of charities*. The Routledge Companion To Nonprofit Marketing, London: Routledge.
- Ibsen, B. and Habermann, U. (2005) 'Defining the Nonprofit Sector: Denmark', Working Papers of the Johns Hopkins Comparative Nonprofit Sector Project, 44.
- Jensen, J. a., Walsh, P., Cobbs, J. and Turner, B. a. (2015) 'The effects of second screen use on sponsor brand awareness: a dual coding theory perspective', *Journal of Consumer Marketing*, 32(2), pp. 71–84. doi: 10.1108/JCM-02-2014-0861.
- Kananukul, C., Jung, S. and Watchravesringkan, K. (2015) 'Building customer equity through trust in social networking sites', *Journal of Research in Interactive Marketing*, 9(2), pp. 148–166. doi: 10.1108/JRIM-03-2014-0019.
- Kapoor, P. S., Jayasimha, K. R. and Sadh, a. (2013) 'Brand-related, Consumer to Consumer, Communication via Social Media', *IIM Kozhikode Society & Management Review*, 2(1), pp. 43–59. doi: 10.1177/2277975213496514.
- Keller, K. L. (1993) 'Conceptualizing, Measuring, and Managing Customer-Based Brand Equity', *Journal of Marketing*, 57(1), p. 1. doi: 10.2307/1252054.
- Keller, K. L. (1999) 'The Brand Report Card', *Harvard Business Review*, pp. 3–10. doi: 10.1016/S0737-6782(00)00083-7.
- Keller, K. L. (2001). *Building Customer-Based Brand Equity : A Blueprint for Creating Strong Brands*. Working Paper. Marketing Science Institute, Report No. 01-107, pp 3-38. doi:10.1080/13527260902757530.
- Keller, K. L. (2009) 'Building strong brands in a modern marketing communications environment', *Journal of Marketing Communications*, 15(2–3), pp. 139–155. doi: 10.1080/13527260902757530.
- Khare, V. P. (2011) 'NPOs Marketing Practices in the USA and France: Differences and Success Factors', *Journal of Marketing Development & Competitiveness*, 5(3), pp. 110–116. Available at: <http://search.ebscohost.com/login.aspx?direct=true&db=buh&AN=64758915&site=ehost-live>.
- Kim, A. J. and Ko, E. (2012) 'Do social media marketing activities enhance customer equity? An empirical study of luxury fashion brand', *Journal of Business Research*. Elsevier Inc., 65(10), pp. 1480–1486. doi: 10.1016/j.jbusres.2011.10.014.
- Kirtis, A. K. and Karahan, F. (2011) 'To Be or not to Be in social media arena as the most cost-efficient marketing strategy after the global recession', in *Procedia - Social and Behavioral Sciences*, pp. 260–268. doi: 10.1016/j.sbspro.2011.09.083.
- Kolb, B. (2013) *Marketing for Cultural Organisations*. Routledge, New York NY.
- Kotler, P. and Keller, K. L. (2012) *Marketing Management*. doi: 10.4135/978145229669.n2040.
- Krueger, J. C. and Haytko, D. L. (2015) 'Nonprofit Adaptation to Web 2 . 0 and Digital Marketing Strategies', *Journal of Technology Research*, Volume 6.
- Kuvykaite, R. and Piligrimiene, Z. (2014) 'Consumer Engagement into Brand Equity Creation', *Procedia - Social and Behavioral Sciences*. Elsevier B.V., 156(April), pp. 479–483. doi: 10.1016/j.sbspro.2014.11.225.
- Kylander, N. and Stone, C. (2012) 'The Role of Brand in the Nonprofit Sector', Nonprofit Management Institute, Stanford, University, Palo Alto, September 2012
- Laidler-kylander, N. and Simonin, B. (2007) 'Modeling Brand Equity in International Nonprofit Organizations : A System Dynamics Approach Modeling Brand Equity in International Nonprofit Organizations : A System Dynamics Approach', *System*, 74, pp. 129–157.
- Langaro, D., Rita, P. and de Fátima Salgueiro, M. (2015) 'Do social networking sites contribute for building brands? Evaluating the impact of users' participation on brand awareness and brand attitude', *Journal of Marketing Communications*, (June 2015), pp. 1–23. doi: 10.1080/13527266.2015.1036100.
- Lanka, S. (2016) 'Effect Of Social Media Marketing On Effect Of Social Media Marketing On Brand', *Management & Marketing* 14(2), pp. 201-216
- Laroche, M., Habibi, M. R., Richard, M. O. and Sankaranarayanan, R. (2012) 'The effects of social media based brand communities on brand community markers, value creation practices, brand trust and brand loyalty', *Computers in Human Behavior*. Elsevier Ltd, 28(5), pp. 1755–1767. doi: 10.1016/j.chb.2012.04.016.
- Leek, S. and Christodoulides, G. (2011) 'Brands: Just for consumers? Introduction to the special issue on B2B branding', *Industrial Marketing Management*. Elsevier Inc., 40(7), pp. 1060–1062. doi: 10.1016/j.indmarman.2011.09.019.
- Lovejoy, K. and Saxton, G. D. (2012) 'Information, community, and action: How nonprofit organizations use social media', *Journal of Computer-Mediated Communication*, 17, pp. 337–353. doi: 10.1111/j.1083-6101.2012.01576.x.
- Lucky, S. and Rathi, D. (2013) 'The Social Media Presence of Non-profit Organizations' in n *Proceedings of the Annual Conference of CAIS / Actes du congrès annuel de l'ACSI*, pp. 1–5. Available at: <http://www.cais-acsi.ca/ojs/index.php/cais/article/view/642>.

- Mangold, W. G. and Faulds, D. J. (2009) 'Social media: The new hybrid element of the promotion mix', *Business Horizons*, 52, pp. 357–365.
- Moretti, A. and Tuan, A. (2014) 'Social media marketing and relationship marketing: revolution or evolution? A first step analysis', *Sinergie Journal*, 93(1), pp. 115–137. Available at: <http://www.sinergiejournal.it/pdf/93/08.pdf>.
- Nah, S. and Saxton, G. D. (2012) 'Modeling the adoption and use of social media by nonprofit organizations', *New Media & Society*, 15(2), pp. 294–313.
- Padanyi, P. (2007). Operationalizing the marketing concept. Achieving market orientation in the nonprofi context in (Eds.) *The Routledge Companion To Nonprofit Marketing*, Routledge London.
- Pope, J. a., Isely, E. S. and Asamoah-Tutu, F. (2009) 'Developing a Marketing Strategy for Nonprofit Organizations: An Exploratory Study', *Journal of Nonprofit & Public Sector Marketing*, 21(2), pp. 184–201. doi: 10.1080/10495140802529532.
- Quinton, S. and Fennemore, P. (2013) 'Missing a strategic marketing trick ? The use of online social networks by UK charities', *International Journal of Nonprofit and Voluntary Sector Marketing*, 51(October 2012), pp. 36–51. doi: 10.1002/nvsm.1450.
- Rathi, D. (2014) 'CAIS Paper: Every Task its Tool , Every Tool its Task: Social Media Use in Canadian Organizations', in *Proceedings of the Annual Conference of CAIS / Actes du congrès annuel de l'ACSI*, pp. 1–6. Available at: <https://journals.library.ualberta.ca/ojs.caais-acsi.ca/index.php/cais-asci/article/view/866>.
- Salamon, L. M. and Anheier, H. K. (1996) 'the International Classification of Nonprofit Organizations', The Johns Hopkins Comparative Nonprofit Sector Project.
- Sargeant, A. and Wymer, W. (2007). *The Routledge Companion To Nonprofit Marketing*, Routledge London.
- Stater, K. J. (2009) 'The Impact of Revenue Sources on Marketing Behavior : Examining Web - Promotion and Place - Marketing in Nonprofit Organizations Behavior : Examining Web-Promotion and', 5142(September).
- Stefanone, M., Anker, A. E., Evans, M. and Feeley, T. H. (2012) 'Click to "like" organ donation: the use of online media to promote organ donor registration', *Progress in Transplantation*, 22(2), pp. 168–174. doi: 10.7182/pit2012931.
- T. Chattopadhyay, S. Shivani, N. K. (2009) 'Determinants of brand equity-A blue print for building strong brand: A study of automobile segment in India', *African Journal of Marketing Management Vol. 1(4)* pp. 109-121
- Vassiliadis C.A. & Belenioti Z.C. (2015) "Museums & cultural heritage via social media: an integrated literature review of social media use in museums", *Tourismos Special Issue*, (Forthcoming, In press).
- Waters, R. D., Burnett, E., Lamm, A. and Lucas, J. (2009) 'Engaging stakeholders through social networking: How nonprofit organizations are using Facebook', *Public Relations Review*, 35(2), pp. 102–106. doi: 10.1016/j.pubrev.2009.01.006.
- Waters, R. D. and Jones, P. M. (2011a) 'Using Video to Build an Organization's Identity and Brand: A Content Analysis of Nonprofit Organizations' YouTube Videos', *Journal of Nonprofit & Public Sector Marketing*, 23(3), pp. 248–268. doi: 10.1080/10495142.2011.594779.
- Waters, R. D. and Jones, P. M. (2011b) 'Using Video to Build an Organization's Identity and Brand: A Content Analysis of Nonprofit Organizations' YouTube Videos', *Journal of Nonprofit & Public Sector Marketing*, 23(3), pp. 248–268. doi: 10.1080/10495142.2011.594779.
- Weinberg, B. D. and Pehlivan, E. (2011) 'Social spending: Managing the social media mix', *Business Horizons*. 'Kelley School of Business, Indiana University', 54(3), pp. 275–282. doi: 10.1016/j.bushor.2011.01.008.
- Williams, E. (2011) 'Branding the art world', *Creative Review*, (October), pp. 52–56.
- Yoo, B., Donthu, N. and Lee, S. (2000) 'An Examination of Selected Marketing Mix Elements and Brand Equity', *Journal of the Academy of Marketing Science*, pp. 195–211. doi: 10.1177/0092070300282002.
- Zailskaite-Jakste, L. and Kuvykaite, R. (2016) 'Conceptualizing the social media communication impact on consumer based brand equity', *Trendy Ekonomiky a Managementu*, 10(25), pp. 68–74. doi: 10.13164/trends.2016.25.68.
- Zheng, X., Chaung, C., Lee, M. and Liang, L. (2015) 'Building brand loyalty through user engagement in online brand communities in social networking sites', *Information Technology & People*, 28(1), pp. 90–106.



## **SOCIAL RESPONSIBILITY IN BANKING: A BIBLIOGRAPHIC REVIEW**

**Bellomo, Mario; La Rosa, Fabio**

Economics and Law Faculty, "Kore" University of Enna, Enna, Italy

### **ABSTRACT**

The present paper proposes a review concerning the topic of social responsibility in banks. In the backdrop of economic crisis which is still ongoing, companies are requested to align with the directives and values of social responsibility. The compliance to social responsibility, nevertheless, cannot only be seen as a commandment imposed and far removed from the competitive and business environment, which passively to adapt to, but rather as an opportunity for diversification and competitive advantage. Such problem is exacerbated in a sector such as banking, in which the elements of competitive differentiation are often ephemeral and volatile, since based on price (especially in the context of loans and services) and performance (in the management of deposits).

This paper focuses on three areas, which have been extensively analyzed by the national U.S. and European literature in the banking sector. In particular, the present study examines: the relationship between social responsibility and income or stock performance of banks; the compilation of the bank operator's rankings, on the basis of results achieved in terms of social responsibility; the impacts of social responsibility in terms of customer satisfaction.

This study proposes to investigate some critical issues, in order to offer interesting ideas for new research into yet unexplored areas.

*Keywords: Social responsibility, performance, regulation, legal enforcement, corporate governance*

### **INTRODUCTION**

Social Responsibility has been studied by academic research since the 70s and 80s. The notion of CSR being a social obligation was first advocated by Carroll (1979, 1991). Carroll's CSR pyramid, one of the best-known CSR models, presents company's social obligations as comprising economic, legal, ethical and philanthropic responsibilities. Carroll (1991) noted that businesses were created as economic entities driven by a profit motive, thus economic performance undergirds the other three CSR components yet only in 2011 Corporate Social Responsibility (henceforth CSR), CSR has been provided with an official definition by the European Commission as "the responsibility of enterprises for their impacts on society". Among the various factors related to CSR, performance, rankings based on the

degree of attention to social responsibility itself, and customer satisfaction have been studied extensively, from both a theoretical and an empirical standpoint. As regards the performance and customer satisfaction, literature shows that people may not believe in an explicit trade-off between being profitable and meeting legal, ethical, and discretionary responsibilities anymore. Yet, banking industry surveys have highlighted a mismatch between customer satisfaction and massive spending on CSR programs. Indeed, the omission of research on the differential impact of CSR initiatives on customer satisfaction is evident. Given both the increasing investment in CSR strategies, and the fact that customer satisfaction mediates firm market value, more awareness of the hierarchy of customer-preferred CSR initiatives is needed in order to enable banks to adapt their CSR programs, to not only benefit the community, but also to improve customer satisfaction (McDonald and Rundle-Thiele, 2008). In reference to compilation of rankings based on the CSR-care, literature underlines that these approaches have the advantage of being quite transparent and objective, as they are based on publicly available information on websites of banks and supranational bodies and reporting specialized NGOs. The biggest flaw of these researches is the limited number of banks for which reports are available, since there is a generalized problem of insufficient disclosure in CSR activities (Scholtens, 2009).

## **AIMS OF THE PAPER**

This paper proposes a review concerning the topic of social responsibility in banks, focusing the attention in detail on: I) the relationship between attention to social responsibility and incomes or stock performance of banks; II) the compilation of rankings of bank operators, on the basis of results achieved in terms of social responsibility: the effects of cultural, ethnic and gender variables on social responsibility indicators; III) social responsibility and its impacts in terms of customer satisfaction. Furthermore, the paper would like to suggest three other areas almost unexplored and therefore susceptible to further research and insights IV) the effects of cultural, ethnic and gender variables on social responsibility indicators; V) the relationship between attention to social responsibility and degree of self regulation and cooperation; VI) the relationship between attention to social responsibility and legal enforcement on a national scale. The importance of the link between the above areas and CSR, particularly the final three areas, calls for an analysis of the current state of knowledge and a systematization of the existing results as preliminary steps to facilitate future studies. In management research, literature is useful to enable the researcher to map and assess the existing intellectual territory and to develop the existing body of knowledge.

In order to make this bibliography as exhaustive as possible, but also having to take into account the inability to analyze the vast literature on CSR, it was decided to concentrate on the most recent researches by selecting those published since 2000 onwards.

## RELATION BETWEEN CSR AND PERFORMANCE OF BANKS

Most of the research on CSR has focused on investigating the connection between CSR and corporate financial performance, while little theoretical attention has been paid to understanding whether corporations act in socially responsible ways or not. The theoretical framework proposed by Campbell (2007) is, in our view, a milestone in literature, able to systematize the socially responsible behavior of businesses and the motivations behind these behaviors. This model, with reference to business in general and not only to banking sector, summarizes the previous literature on CSR in eight postulates according to which companies would be induced to implement CSR activities (see also Shleifer, 2004):

- Companies with poor financial performance and / or acting in a poor economic environment will be less likely to act in a socially responsible way. In fact, if the possibility of obtaining short-term profits are low, the lack of resources could jeopardize the creation of shareholder value (Margolis and Walsh, 2001; Orlitzky *et al.*, 2003).
- Companies will be reluctant to act in a socially responsible manner whether they operate in environments which are too competitive or too little competitive (McCraw, 1984; Schneiberg, 1999).
- Companies will be more inclined to act in a socially responsible way if there is a strong regulation and an effective legal protection of investors especially if such-regulation is based on consensus and negotiation between the government, companies and stakeholders (Grant and Downey, 1996; Siglitz, 2003; Grant, 1997).
- Companies will be more likely to act in a socially responsible way if there is an effective and well-organized system of self regulation based on the threat of intervention by the state or by an industrial crisis of vast proportions (Schneiberg, 1999; Streeck and Schmitter 1985).
- Companies will be more inclined to act in a socially responsible way if there are independent organizations such as NGOs, social movements, press or institutional investors able to monitor their behavior, and if necessary able to mobilize to change it (Aguilera and Jackson, 2003; Driver and Thompson, 2002; Mitchell *et al.*, 1997).
- Companies will be more inclined to act in a socially responsible way if they operate in a context where the demand for such behavior by important stakeholders is institutionalized for example in major economic journals, professional and training curricula, and in other contexts which the participation of managers is required (Aguilera and Jackson, 2003; Dore, 1983; Hall and Soskice, 2001; Whitley, 2004).
- Companies will be more inclined to act in a socially responsible way if they belong to associations of businesses that promote socially responsible behavior (Martin, 2000, 2005, 2006).

- Companies will be more inclined to act in a socially responsible way if they are institutionally engaged in a dialogue with social partners and stakeholders (trade unions, investors, the local community), (e.g., Aguilera and Jackson, 2003; Roe, 2003).

In this context it is worth mentioning the work of Chih and colleagues (2010) which seek to empirically test the Campbell postulates, studying a sample of 520 financial institutions in 34 countries in the period between 2003 and 2005. The authors conclude that there is not any significant relationship between the attention given to CSR and the performance of the financial intermediary. In detail, they encounter a series of other important results, such as: the bigger the company the more socially responsible the actions of the intermediaries, the more intense the competitiveness of the market, the greater the legal protection of investors and finally, the more collaborative and non-confrontational the relations between employers and employees. From the methodological point of view, researchers use the ROA index as independent variables for the studied regression as a proxy for performance, the H statistics index defined by Chih and Cheng (2008), as a proxy of the degree of market competitiveness; the study of the independent variables related to legal enforcement and the degree of cooperation between employers and workers will be dealt with in the last section of this paper.

The dependent variable taken as a proxy of the CSR instead is a dummy variable which takes the value 1 if the intermediary is included in the Dow Jones Sustainability World Index (DJSI World) and 0 otherwise. The curvilinear relation between the degree of competition and the degree of socially responsible behavior proposed by Campbell appears to be confirmed by empirical findings.

Simpson and Kohers (2002) analyzing a sample of 385 US commercial banks in the period between 1993 and 1994 came to the opposite conclusion that is there is a positive and significant relationship between the degree of adherence to CSR and the financial and economic performance of banks. The authors use a measure of the dependent variable CSR derived from the Community Reinvestment Act of 1977 (CRA), which consists of a dummy variable that takes the value 0 if the CRA rating is "improvement needed" and 1 if the CRA rating is "outstanding". The rating, which can assume four levels, is based on 12 items among which are listed the more significant: 1) ability to communicate with members of the community to ensure credit needs; 2) degree of involvement of the BoD in CSR activities; 3) efforts of marketing to make sure that the types of credit offered are widespread in the community; 4) participation in community development projects. In order to measure the dependent variables Simpson and Kohers refer to two distinct indicators: the ROA index and the relationship between losses on loans and the total number of loans. The CRA was enacted to force banks to meet the credit needs of low-middle income customers by financing their housing needs and supporting their economic development. Taking for granted the existence and positivity of the relation between CSR and Financial Performance (henceforth FP), these authors state that the only possible direction future research can

move is to explain, through a theoretical construct, the above relation and identify the direction of it, particularly whether it is CSR to determine FP or vice versa.

Even, Cornett, Erhemjamts and Tehranian (2016) by examining the relation between CSR and performance of banks, in the context of the ongoing financial crisis, found that banks with high scores in terms of CSR show also high performances: being socially responsible is therefore a rewarding behavior. These researchers, based on their empirical findings, argue that big banks, to a greater extent than smaller one, are dedicated to socially responsible initiatives. After 2009, however, there was less attention towards CSR issues by big banks.

## **CLASSIFICATIONS OF INTERMEDIARIES ON THE BASIS OF PERFORMANCE IN TERMS OF CSR**

The scholars who have dealt with this thematic area have sought to draw up rankings of the degree of attention to CSR on the basis of the different items often using the triple-bottom-line theoretical framework by Elkington (1997), widely employed both in the literature and in the best practices. According to Elkington's model, the performance assessment must concern not only the economic aspects, but also the environmental and social ones, thus aiming to create autonomously qualitative and multidimensional indicators (Birindelli *et al.*, 2015; Scholtens, 2009). Usually the methodological approach is the Content Analysis Method (Abbott and Monsen, 1979; Beattie and Thomson, 2007).

CSR is regulated by international and national self-regulatory measures, without binding legal force (soft law). Among the most relevant CSR disposals, we mention the OECD Guidelines (OECD 2011), the ISO 26000 Standard (ISO 2010) and the GRI (acronym for Global Reporting Initiative) Guidelines for Sustainable Reporting.

In the last few decades, the relevance the community and institutions attach to CSR has progressively increase but some authors (Karaibrahimoglu, 2010) think there is a dilemma between the enhancement and the weakening of CSR activities during the economic downturns. The contrast concerns, on one hand, the strengthening of the CSR initiatives required by the increasing social and environmental awareness and, on the other, the tendency of the organizations to limit such investments because of the lack of financial resources.

In this area, widely covered by business literature in general, but a little less by the specific literature about banks, the contribution of Scholtens (2009) seems interesting. This author develops a framework which analyzes 32 major European banks in the 2000-2005 period and comes to a classification of their degree of adherence to CSR principles. The CSR indicators derived from the World Commission on Environment and Development (1987) are dummy variables and are divided into four areas, namely: adherence to codes of ethics and use of sustainability reporting; environmental management;

financially responsible products and social conduct. This approach, according to the author, turns out to be more immediate and transparent than CSR ratings prepared by specialized institutions such as KLD and EIRIS and allows repeatability and verification of results. It also offers both a classification of individual banking institutions and a classification at country level pointing out that banks in the Netherlands, Belgium, Germany, France and the UK get the highest scores in terms of CSR, while banks in Sweden, Italy and Japan register the most disappointing results. The author also finds a positive association between performance in terms of CSR and, respectively, the size and financial standing of the bank as measured by the capital ratios. Along the lines of Scholtens (2009), studying a sample of 30 European banks, has set himself the goal of submitting a ranking indicating the degree of adherence to the values of CSR based on 48 dummy independent variables considered by the authors the most important drivers of CSR in banks. These items are obtained from literature, accounting and financial reporting and the websites of banks and are grouped into four areas of analysis (disclosure, organization and management, offer of socially responsible instruments, adherence to agreements / international standards / certifications and indices). In any case, they are the product of a subjective evaluation process, based largely on the "perceptions" of the respondents (Hillenbrand and Money, 2007). The dependent variables are represented not only by the intermediary position in the aforementioned ranking but also by the ratio between the added value created by the bank and its total assets. The results that the authors come to are that banks should pay more attention to the disclosure of their activities in the field of CSR, since the scores in this area are relatively worse than those achieved in others. The areas of organization and management and offer of socially responsible instruments, are those in which the analyzed banks get the best results, demonstrating great sensitivity in CSR issues, in line with the success of the tools developed to fight against social exclusion and poverty of the poorest social strata and least developed countries. The interpretation of the results relating to the items included in the area and international agreements looks rather ambiguous. If adherence to those standards expected of financial institutions such as UNEP FI and the UN Global Compact Principles appear widespread, it is more difficult to find adherence to those agreements pertaining to specific subject areas such as combating gender discrimination, money laundering, environment protection and human rights.

Weber and colleagues (2005) use a multi-level analysis that begins with the pre-selection of 171 banks that have joined the UNEP Convention of 2001, after identifying the 22 best organizations in terms of sustainability. The authors only interview 8 of those organizations and conduct an in-depth analysis of production processes trying to assess their ability to integrate sustainability into the business strategy. The analysis is performed for three distinct business areas: a) credit business, including microcredit, loans for environmental and social projects with interest rates lower than standard and residential

mortgages aimed at the realization of sustainable housing from an energy and environmental point of view; b) wealth management including asset management and mutual funds investing in sustainable projects; c) investment banking activities promoting the creation of job opportunities for local communities in which the investment is made, the use of renewable resources and projects having a positive impact on local environment. For each area, the authors attempt to identify the leaders in the ability to integrate sustainability into core activities, grouping the banks on three levels depending on the efficiency of the implementation: leaders, mid-level banks, sufficient level banks. The specific identification of the leaders is beyond the scope of this paper, so they will not be detected. The focus of this section is on the study of the method used and its theoretical and practical implications. Finally, the authors identify five models of integration of sustainability in the banking sector: integrating sustainability-related events; sustainability as a new banking strategy; sustainability as value drivers; sustainability as a public mission; and sustainability as a requirement by customers. These models can be effectively employed even in other banks to implement sustainability in their business. The authors suggest five models of integration of sustainability in the banking strategy:

- Integration of sustainability through the creation of technical funds for the purposes of environmental protection, through the introduction of an environmental tax or the use of a global conference on sustainability.
- Sustainability as a new banking strategy from a social and ethical perspective, besides the financial one. This strategy is the one adopted by those banks which only undertake sustainable businesses.
- Sustainability as a value driver in the implementation of sustainable products, eco-mortgages and similar products. The difference with respect to the concept of sustainability as a new banking strategy is that these products and services do not constitute the core business and do not represent the main portion of the bank's revenues. The strategy consists in the use of the concept of sustainability only if it improves profits or the reputation of the bank. Sustainable products coexist with all other standard products and services. The business strategy of the bank as a whole is not pervasively affected by the concept of sustainability.
- Sustainability as a public mission in the event that banks carry out their activities on behalf and in the interest of a public entity as a state, an area (the Swiss cantons) or a local authority.
- Sustainability as a requirement by customers. The bank adjusts its policy to the wishes and needs of customers, by periodically asking them if its actions are consistent with their needs and social sustainability.

The authors conclude by listing some practical suggestions which are able to make the banking sector sustainable in the future: a) bank executives must support integration (top-down process); b)

sustainability has to be integrated into operational activities in terms of products, services and processes; c) the integration of sustainability into the core business of banks; d) the integration of sustainability into the overall business strategy of a bank; e) sustainability is not a soft factor, but a measurable business result.

## **IMPACT OF CSR ON CUSTOMER SATISFACTION**

This thematic area seems scarcely explored as the literature focuses on non-financial companies without investigating what happens with particular reference to the banking sector. In this thematic area most of the research has made use of the theoretical framework based on hierarchy of customer preferences for CSR initiatives by Bhattacharya and Sen (2004). In spite of the notoriety of this model it must be recognized that a comparative analysis of the efficacy of each of the dimensions has not carried out so far.

Bhattacharya and Sen (2004) CSR framework is made up of three broad parts - the company-specific inputs, the internal and the external outputs from consumers - that benefit the focal company, the consumers themselves, and the social issues. The model reflects two sets of "multiplier" factors that moderate the effects of the CSR initiatives on the internal outcomes and that moderate the effects of the internal outcomes on the external outcomes. These factors are broadly classifiable into three categories pertaining to the company, the consumers, and the competition. Because of the heterogeneity of consumer responses, the problem for managers is to understand when, how and why consumers' respond to CSR initiatives, and the above research-guided framework is aimed to face this difficult task.

McDonald and colleagues (2008), starting with a thorough literature review on CSR, ask future research to answer the question whether, for the purpose of customer satisfaction, a customer centered policy or a CSR centered policy give better results for banks. To this end, they seek to establish a ranking of both CSR item and those with a more marked customer focused character, which allows for identification of which items are more interesting and should be further explored. In the non-banking area important research by Luo and Bhattacharya (2006) and Maignan and Ferrell (2001) indicate a positive association between CSR and customer satisfaction, yet the same Luo and Bhattacharya showed that the relation between CSR and customer satisfaction was not always linear, and indeed in the case of companies with limited innovative capacity, it was reversed. McDonald and colleagues (2008) found that surveys conducted by the banks themselves often show that institutions which have made significant investments in socially responsible initiatives have not had a significant return in terms of customer satisfaction. This is confirmed by Pomering and Dolnicar (2006) who, investigating the CSR initiatives of a specific bank have seen how customers prefer initiatives that benefit them



directly, rather than those that benefit their wider community. If it is a fact that customer satisfaction is one of the most important determinants of firm value, banks cannot disregard them in the implementation of socially responsible initiatives.

Ultimately through the use of the multi-dimensional model of CSR Bhattacharya and Sen (2004), McDonald and colleagues (2008) confirm what was argued by the prevailing literature, namely that customer-focused initiatives make it possible to obtain better customer satisfaction than those focusing on CSR, but they also point out that the effects of CSR initiatives in consumer behavior have not yet been sufficiently explored by scientific research. The goal of future research will be to identify a hierarchy of CSR initiatives that would allow banks to focus on those initiatives that give a greater return, even under the profile of customer satisfaction, since according to Auger and colleagues (2006) there is a hierarchy of consumer preferences for ethical and social issues, and therefore not all initiatives in CSR have the same impact in terms of customer satisfaction.

## **EFFECTS OF VARYING CULTURAL, ETHNIC AND GENDER ON CSR**

Among the thematic areas that were not elicited enough by the literature it is that of socio-cultural variables such as gender, ethnicity, professional. The main goal of this section, therefore, is a survey of literature on international, cross-cultural CSR policy in general and cross-cultural CSRO (namely individual orientation towards CSR) in specific. The main theoretical reference model, in this fields are, Carroll's (1979, 1991) framework of CSR and Schwartz's (1999, 2006) theory of cultural value orientations. Carroll defines CSR as the result of the combination of four components: a) economic responsibilities namely profitably producing goods and services requested by society; b) legal responsibility: operating within the laws and the social rules established by society; c) ethical responsibilities: acting by conforming to society's expectations and social rules established, by doing what is right and fair; d) discretionary responsibilities: acting as good citizens contributing to the welfare of the society and the improvement of the quality of life. According to Schwartz cultures could be described in several dimensions and are ordered by importance in relation to one another to form a system of values viewed as interdependent and non orthogonal dimensions (Schwartz, 1992). Schwartz (1992) distinguished seven types of cultural value orientations comprising three polar cultural value dimensions: a) embeddedness versus autonomy; b) hierarchy versus egalitarianism; c) mastery versus harmony.

Literature about this area confirms significant differences in CSR across cultures even within one single internationally operating organization; meeting such differences does not come at the expense of economic performance levels or legal limitations (Van den Heuvel *et al.*, 2014). The most important question arising from this issue is whether CSR-oriented organizations will survive in the long term in

the whirlpool of supercapitalism (Reich, 2007) and hypercompetition (D'Aveni, 1994), which strongly emphasizes shareholder satisfaction.

In this thematic area it is worth quoting the work of van den Heuvel and colleague (2014) that, examining 416 employees of a bank operating internationally, study the orientation and attitude towards CSR depending on one's country. The context studied was geographically divided into three clusters, each corresponding to one of the business units of the bank: Western Europe, English-speaking countries and South Asia. The dependent variable CSR is defined by four distinct components according to Carroll theoretical framework. The authors administered a questionnaire to employees consisting of 44 items, divided into 11 set, each containing 4 items, one for each of the components of CSR identified above, asking them to distribute 10 points among the various items of these 11 sets.

Univariate and Multivariate Analyses of Variance and T-test on independent groups were carried out to verify the research hypotheses, namely the significance of the difference between the averages of the overall scores obtained in the various transnational clusters. In conclusion, the authors confirm their assumptions about the presence of significant differences within a single organization operating at an international level as regards CSR orientation according to their nationality, gender and professional area; such difference it is not significant only for the first component. For example, the Anglo-Saxon countries and those in South Asia give greater weight to competitiveness, economic performance and to the legal component and more limited weight to the ethical component than in Western Europe ones. Western European countries, however, attaches a greater weight to the discretionary component than the Anglo-Saxon countries. This suggests the difficulty in implementing a uniform CSR strategy for all countries. As for gender influence, men generally classify the four responsibilities in order of importance as follows: economic, legal, ethical, and discretionary, whereas women classify economic responsibilities only third after the legal and ethical ones. As for the functional variable, the authors found that employees belonging to the random cluster, compared to CSR experts, believe legal responsibilities to be far more important, while the latter attach more importance to ethical responsibilities. The authors suggest as an additional line of research the study from a transnational perspective, but in the context of a variety of organizations instead of only one since the corporate culture tends to prevaricate and to prevail on the cultural national orientation of employees. Further research on the differences in CSR across various cultures should be undertaken, incorporating various populations in different countries, through multi-national banks with branches across different countries since research is often focused on banks located in just one nation.

## **THE RELATIONSHIP BETWEEN CSR AND RESPECTIVELY LEGAL ENFORCEMENT AND COOPERATION BETWEEN EMPLOYERS AND EMPLOYEES**

This thematic area, while being interesting for its practical implications, definitely appears to be the least explored in the literature, therefore also worthy to be further investigated by future research. The theoretical framework for this area is the same Campbell (2007) model analyzed in section about the performance and a useful research starting point can be represented by the work of Chih and colleagues (2010), partially shown in the section devoted to financial performance and the cash flows linked to adoption of CSR measures. In this section, the aspects related to legal enforcement and the cooperative and self-regulating frameworks, will be briefly analyzed. The authors use three indicators as a proxy of legal enforcement including the Shareholders Right Index (La Porta *et al.*, 1998) which can take values between 0 and 6, where 6 indicates the highest level of protection for shareholders and Legal Enforcement Index, which can assume values between 0 and 10 where 10 corresponds to the greatest possible degree of protection of investors prepared by the legal system; a proxy index of cooperation between employers and employees was derived from the Global Competitiveness Report which may assume values from 1 to 7, where 7 indicates the highest possible degree of cooperation; an index measuring the degree of self-regulation and may assume a value of 1 if the intermediary adopts either the Equator principles or the Wolfsburg principles and 0 if the intermediary does not adopt either of the two principles. The dependent variable, featuring also in this case the CSR, is represented by a dummy variable which takes the value 1 if the intermediary is included in the Dow Jones Sustainability World Index (DJSI World) and 0 otherwise. The authors (Chih, Chih and Chen, 2010) conclude that the financial intermediaries operating in countries with strong legal enforcement measures engage in CSR activities with greater determination while financial intermediaries in those countries with effective protection for investors are less involved in CSR activities; self-regulation in the financial sector has a positive impact on CSR; finally, financial intermediaries in countries with more cooperative relations between employers and workers and high quality management schools will be more attentive to CSR.

## **CONCLUSIONS**

In the present article we have tried to address the issue of social responsibility of banks trying to identify, through a review of recent literature, determinants and effects. Moreover, we have tried to suggest some ideas for future research in CSR fields like those of customer satisfaction and legal enforcement which have been poorly explored so far. The conclusion is that compliance with social responsibility, can not only be seen as a commandment imposed from above, far removed from the

competitive business environment, but rather as an opportunity for the diversification and competitive advantage (Birindelli *et al.*, 2015). This interpretation is even truer in the banking sector, where competitive differentiators are often ephemeral and volatile, since they are based on the price (under loans and services) and performance (in the management of deposits). Yet it cannot be denied that the values of social responsibility are often invoked by the various subject of the system (governments, companies, NGOs) to defend their interests. In particular, governments invoke social responsibility to demand and justify an extension of its regulatory powers, companies set themselves up as bastions of social responsibility to demand more autonomy from regulatory constraints, while NGOs make use of CSR to increase their lobbying powers and to rake in more resources in the form of donations from governments and enterprises (Michael, 2003).

## REFERENCES

- Abbott, W.F, and Mosen, R.J (1979), "On the Measurement of Corporate Social Responsibility: Self Reported Disclosures as a Method of Measuring Corporate Social Involvement", *Academy of Management Journal*, Vol. 22, No 3, pp. 501-515.
- Aguilera, R.V. and Jackson, G. (2003), "The cross-national diversity of corporate governance: Dimensions and determinants.", *Academy of Management Review*, Vol. 28, pp. 447-465.
- Auger, P., Devinney, T.M., and Louviere, J.J. (2006), "Using best-worst scaling methodology to investigate consumer ethical beliefs across countries", *Journal of Business Ethics*, Vol. 70 No. 3, pp. 299-326.
- Beattie, V. and Thomson, S. (2007), "Lifting the lid on the use of content analysis to investigate intellectual capital disclosures in corporate annual reports", *Accounting Forum*, Vol. 31, No. 2, pp. 129-163.
- Bhattacharya, C.B., and Sen, S. (2004), "Doing better at doing good: when, why, and how consumers respond to corporate social initiatives", *California Management Review*, Vol. 47 No. 1, pp. 9-24.
- Birindelli, G., Ferretti, P., Intonti, M. and Iannuzzi, A.M. (2015), "On the drivers of corporate social responsibility in banks: evidence from an ethical rating model", *Journal of Management and Governance*, Vol. 19, pp. 303-340.
- Campbell, J.L. (2007), 'Why Would Corporations Behave in Socially Responsible Ways? An Institutional Theory of Corporate Social Responsibility', *Academy of Management Review*, Vol. 32 No. 3, pp. 946-967.
- Carroll, A.B. (1979), "A three-dimensional conceptual model of corporate performance", *Academy of Management Review*, Vol. 4, pp. 497-505.
- Carroll, A.B. (1991), "The pyramid of corporate social responsibility: Toward the moral management of organizational stakeholders", *Business Horizons*, Vol. 34 No. 4, pp. 39-48.
- Chih, H.L. and Cheng, R.K. (2008), "Banking Competition, Profitability Persistence and Access to Finance: Some International Evidence", Working Paper, College of Business, National Taipei University.
- Chih, H.L., Chih, H.H., and Chen, T.Y. (2010), "On the determinants of corporate social responsibility: International evidence on the financial industry", *Journal of Business Ethics*, Vol. 93 No. 1, pp. 115-135
- Cornett, M.M., Erhemjamts, O., and Tehranian, H. (2016), "Greed or good deeds: An examination of the relation between corporate social responsibility and the financial performance of US commercial banks around the financial crisis", *Journal of Banking & Finance*, Vol. 70, pp. 137-159
- D'Aveni, R. (1994). *Hypercompetition: Managing the dynamics of strategic management*. New York.
- Dore, R. (1983), "Goodwill and the spirit of market capitalism", *British Journal of Sociology*, Vol. 34, pp. 459-482.
- Driver, C. and Thompson, G. (2002), *Corporate governance and democracy: The stakeholder debate revisited*, "Journal of Management and Governance", Vol. 6, pp. 111-130.
- Elkington, J., (1997), "Cannibal with Forks: The Triple Bottom Line of 21st Century Business", Oxford.
- Grant, D. S. (1997), "Allowing citizen participation in environmental regulation: An empirical analysis of the effects of right-to-sue and right-to-know provisions on industry's toxic emissions", *Social Science Quarterly*, Vol. 78, pp. 859- 874.

- Grant, D.S. and Downey, L. (1996), "Regulation through information: An empirical analysis of the effects of statesponsored right-to-know programs on industrial toxic pollution", *Policy Studies Review*, Vol. 14 No. 3/4, pp. 339–352.
- Hall, P. A. and Soskice, D. (2001), "An introduction to varieties of capitalism", in Hall P.A and Soskice D. (Eds.), *Varieties of capitalism: The institutional foundations of comparative advantage*, Oxford University Press, New York, pp. 1-70.
- Hillenbrand, C., and Money, K. (2007). "Corporate responsibility and corporate reputation: Two separate concepts or two sides of the same coin?", *Corporate Reputation Review*, Vol. 10 No. 4, pp. 261-277.
- Karaibrahimoglu, Y.Z. (2010), "Corporate social responsibility in times of financial crisis", *African Journal of Business Management*, Vol. 4 No. 4, pp. 382-395.
- La Porta, R., Lopez-de-Silanes, F., Shleifer A., and Vishny, R.W. (1998), "Law and Finance", *The Journal of Political Economy*, Vol. 106 No. 6, pp. 1113–1155.
- Luo, X., and Bhattacharya, C.B. (2006), "Corporate social responsibility, customer satisfaction and market value", *Journal of Marketing*, Vol. 70 No. 4, pp. 1-18.
- Maignan, I. and Ferrell, O. C. (2001), "Corporate citizenship as a marketing instrument: concepts, evidence and research directions", *European Journal of Marketing*, Vol. 35 No. 3/4, pp. 457-484.
- Margolis, J. D., and Walsh, J. P. (2001), *People and profits? The search for a link between a company's social and financial performance*, Lawrence Erlbaum Associates, Mahwah, NJ.
- Martin, C. J. (2000), *Stuck in neutral: Business and the politics of human capital investment*, Princeton University Press, Princeton, NJ.
- Martin, C. J. (2005), "Corporatism from the firm perspective", *British Journal of Political Science*, Vol. 35, pp. 127–148.
- Martin, C. J. (2006), "Corporatism in the post-industrial age: Employers and social policy in the little land of Denmark", in Campbell L.J., Hall J.A. and Pedersen O.K. (Eds.), *National identity and the varieties of capitalism: The Danish experience*, McGill-Queen's University Press, New York.
- McCraw, T. (1984), *Prophets of regulation*, Harvard University Press, Cambridge, MA.
- McDonald, L and Rundle-Thiele, S.R. (2008), "Corporate social responsibility and bank customer satisfaction: a research agenda", *International Journal of Bank Marketing*, Vol. 26 No. 3, pp. 170-182.
- Michael, B. (2003), "Corporate social responsibility in international development: an overview and critique", *Corporate Social Responsibility and Environmental Management*, Vol. 10 No.3, pp- 115-128.
- Mitchell, R. K., Agle, B. R., and Wood, D. J. (1997), "Toward a theory of stakeholder identification and salience: Defining the principle of who and what really counts", *Academy of Management Review*, Vol. 22, pp. 853–886.
- Orlitzky, M., Schmidt, F. L., and Rynes, S. L. (2003), *Corporate social and financial performance: A meta-analysis*, *Organization Studies*, Vol. 24, pp. 403–441.
- Pomeroy, A. and Dolnicar, S. (2006), "Customers' sensitivity to different measures of corporate social responsibility in the Australian banking sector", in *Australia and New Zealand Marketing Academy Conference (ANZMAC) in Brisbane, 4-6 December 2006*.
- Reich, R. B. (2007), *Supercapitalism: The Transformation of Business, Democracy, and Everyday Life*, Alfred A. Knopf, New York, NY.
- Roe, M. J. (2003), *Political determinants of corporate governance: Political context, corporate impact*, Oxford University Press, New York.
- Schneiberg, M. (1999), "Political and institutional conditions for governance by association: Private order and price controls in American fire insurance", *Politics and Society*, Vol. 27 No.1, pp. 67–103.
- Scholtens, B. (2009), "Corporate Social Responsibility in the International Banking Industry", *Journal of Business Ethics*, Vol. 86, pp. 159–175.
- Schwartz, S.H. (1992), "Universals in the content and structure of values: Theory and empirical tests in 20 countries", in Zanna, M. (Ed.), *Advances in experimental social psychology*, Academic Press, New York, Vol. 25, pp. 1-65.
- Shleifer, A. (2004), "Does competition destroy ethical behavior?", *National Bureau of Economic Research*, Vol. 94 No. 2 May, pp. 414-418.
- Simpson, W. and Kohers, T. (2002), "The Link Between Social and Financial Performance: Evidence from the Banking Industry", *Journal of Business Ethics*, Vol. 35, pp. 97–109.
- Stiglitz, J. E. (2003), *The roaring nineties: A new history of the world's most prosperous decade*, Norton, New York.
- Streeck, W., and Schmitter, P. (1985), "Community, market, state—and associations? The prospective contribution of interest governance to social order.", in Streeck W. and Schmitter P. (Eds.), *Private interest government: Beyond market and state*, Sage, Beverly Hills, CA , pp. 1–29.

- Van den Heuvel, G.G.A., Soeters, J.M.M.L. and Goessling, T. (2014), "Global business, global responsibilities: Corporate social responsibility orientations within a multinational bank", *Business & Society: A Journal of Interdisciplinary Exploration*, Vol. 53 No. 3, pp. 378-413.
- Weber, O. (2005), "Sustainability benchmarking of European banks and financial service organizations", *Corporate Social Responsibility and Environmental Management*, Vol. 12 No. 2, pp- 73-87.
- Whitley, R. (2004), "The social construction of organizations and markets: The comparative analysis of business recipes", in Dobbin F. (Ed.), *The new economic sociology*, Princeton University Press, Princeton, NJ, pp. 162–187.

# FOR LOVE AND MONEY! EMPLOYEES, VOLUNTEERS AND ECONOMIC PERFORMANCES IN USA NONPROFIT ART ORGANIZATIONS

Besana, Angela; Esposito, Annamaria

Business, Law, Economics and Consumer Behavior, IULM, Milan, Italy

## ABSTRACT

The economic performance of nonprofit art organizations is affected by the labour intensity of employees and volunteers.

Marketing and, above all, relationship marketing are very important to engage employees and volunteers, emphasize and strengthen their commitments, and maximize the competitive advantage in a resource-constrained sector. A relationship marketing perspective helps art organization to understand who employees and volunteers are and what drives them, and to create a seamless integration between paid and unpaid workers. This facilitates productive relations among staff and volunteers, and their connections to the organization's goals.

The aim of the paper is to profile 300 nonprofit art organizations in the USA in terms of the relationship between their ratio of employees to volunteers and their economic performances in 2015. Following k-means cluster analysis, three main clusters are significant. The most crowded cluster (130 organizations) shows the highest program service revenue with the greatest share of employees. Marketing staff are essential in the *The Marketing Expert* cluster, who reveals an organization focused on internal labour intensity.

The two remaining clusters show higher fundraising expenses, contributions and ratio of volunteers than *The Marketing Expert*. The external labour intensity of volunteers is essential for art organizations in *The Fundraiser* cluster with the highest gains and solvency.

The paper highlights the joint importance of employees and volunteers in the performance of art organizations, which have so far not been thoroughly investigated using cluster analysis. Relationship marketing plays a pivotal role, which can be further optimized by the managers of these organizations.

*Keywords: economic performance, marketing, USA nonprofit art organizations, employee, volunteer, cluster analysis.*

## INTRODUCTION

Labour intensity is very important in nonprofit organizations, who fulfil missions, which do not only affect economic growth but also build social capital and welfare. Nonprofit art organizations in the USA show high levels of labour intensity (Slavich, Montanari, 2009; Turbide et al., 2009 and 2008), whose pillars are employees with their creative skills on the stage, in museum rooms and marketing offices, and volunteers who, above all, outside of 'creative rooms' support friendships, advocacy, marketing and fundraising goals. The *internal labour intensity* of marketing and fundraising staff is signaled through marketing and fundraising commitments and goals, which can be magnified by the *external labour intensity* of volunteers, who either may support more the fundraising side than the marketing side of art organizations or may support the match of both fundraising and marketing.

Consequently, the economic performance of these nonprofit organizations is affected.

In this context, relationship marketing (Das, 2009; Morgan, Hunt, 1994; Berry, 1995) is an important strategy to attract, maintain, and enhance long-lasting relationships with paid and unpaid staff over time in nonprofit organizations. The marketing perspective allows non-profit organizations to understand who employees and volunteers are and what drives them, allowing nonprofits to identify the strategies most appropriate to managing them. In addition, relationship marketing helps to meet the needs of stakeholders and to provide them with information directly suited to their interests (Bussel, Forbes, 2002, 2006), and to spread awareness of the social values which lead to the achievement of the mission (Sargeant, 2009; Andreasen, Kotler, Parker, 2003).

Adopting a marketing approach allows nonprofit to generate stakeholders trust and commitment (Hussain, Rawjee, Penceliah 2014), and to exploit strategically the valuable resources and capabilities that are at the nonprofit organization's disposal, among which are employees and volunteers. Furthermore, according to some scholars (Colbert 2001; Hill, O'Sullivan and O'Sullivan 1995; Radbourne, Fraser 1996) the more the organization learns about and monitors the stakeholder's needs, preferences, attitudes and concerns, the greater will their satisfaction and commitment level grow. This is especially true for nonprofit art organizations, which are services-oriented organizations, and they are built on relationships (Grönroos, 1994,1996, 2004; Rentschler et al., 2002; Padanyi, Gainer, 2004).

The aim of the paper is to profile 300 nonprofit art organisations in the USA in terms of the relationship between their ratio of employees to volunteers and their economic performance in 2015. Following k-means cluster analysis, three main clusters are significant for volunteering in connection with fundraising (external labour intensity) and employees in connection with marketing and advertising (internal labour intensity).



## **ECONOMICS OF INTERNAL AND EXTERNAL LABOUR INTENSITY IN NON-PROFIT ART ORGANIZATIONS**

Internal labour intensity is depends on creative professionals in non-profit art organizations, whose non progressive production function has been the focus of economic literature for decades (Slavich, Montanari, 2009). The commitment of employees concerns identification with the mission of the organization, long-term relationships and satisfaction. It includes visions and the importance of monitoring for satisfaction. Employees can affect performances and, if they mature with the organization, their advocacy and efforts can impact on both economic and social performances (Hegenbuch, D. J., Little, S. W., Lucas, D. J. 2015). Employees show a labour intensity, which is not subsidiary to the volunteers' one, though some fungible competences can be interchanged (Handy, F., Mook, L. and Quarter, J. 2007). Deviation is possible, if boards do not invest in intensity and trustworthiness (Van Erde, W., Peper, P. 2008).

The external labour intensity is supported by several stakeholders, among them, volunteers, who are not paid by the organizations, though they show advocacy for and commitment to. Nonprofit art organizations have always relied on voluntary relations, while volunteers have invested time, emotions, advocacy, congruent identities, tangible and intangible resources (Carpenter, Myers, 2010; Einolf, Chambré, 2011; Bussell, Forbes, 2007 and 2002). If motivations can range from tangible to intangible (Meier, Stutzer 2008; Ziemek, 2006; Katz, Rosenberg, 2005), the range of variables of the utility function of volunteers include: empathy for a specific good cause, altruism for any good cause, commitment to the welfare of the whole society, self-identification and self-esteem (Chaddha, Rai, 2016). In volunteers' opinions relations gratify them for being in a community with other people and 'empathic souls'.

Employees and volunteers collaborate. From the starting point of their relationship, the selection and governance of volunteers they both need charismatic leaderships and, above all, that the board of nonprofit organization verifies changing viewpoints of volunteers over time (DeVoe, Pfeffer, 2007). Volunteers' levels of satisfaction can change, as well as their impact on turnovers. Employees and audiences are essential to the functioning and revenues of non-profit art organizations Volunteers are essential, too (Ewing, Govekar, Govekar, Rishi, 2002).

Employees and volunteers can be the same people and the latest nonprofit literature is paying attention to the allocation of time, rewards and reputation, when staff-giving (as volunteers in another organization) change relations and governance inside of firms (Rodell, Lynch, 2016; Grant, 2012). This may not be the case with art organizations: employees are fully devoted to their art organization and they can work as volunteers within it (for fundraising events and big donors' events). No literature has been found that looks at art and nonprofit employees working as volunteers in other art and

nonprofit organizations. Only some USA art organizations support their staff-giving (for networks of theatre seasons and productions). In contemporary nonprofit organizations, some staff-giving can be found. Nevertheless volunteering can suffer for recession and millennials, who do not seem to be particularly interested in volunteering (Ertas, 2016; Collins, Long, 2015).

## THE IMPORTANCE OF RELATIONSHIP MARKETING IN NONPROFIT ART ORGANIZATIONS

Relationship marketing (Morgan, Hunt, 1994) is represented by all the marketing activities geared to the creation, to the maintenance and management of relational assets consisting of long-run relationships with stakeholders. Furthermore, according to Buttle (1996), relationship marketing is about healthy relationships characterized by concern, trust, commitment and service. It is about a mutual exchange and fulfilment of promises (Grönroos, 1994). *Adopting a marketing perspective* – without forgetting the ethical dimension and the values which distinguish the economic role played by nonprofit – pushes art organizations toward innovative strategies for the realization of their mission (Lovelock, Weinberg, 1984; Andreasen, Kotler, Parker, 2003; Kolb, 2013) and in a more strategic direction (Conway, 1997).

It must be remembered that relationship marketing is not just about relationships with customers. In fact, a relationship marketing approach is crucial in dealing with different groups of stakeholders (Peck, 1996) and with different relationships between these groups (Christopher, Payne, Ballantyne, 1991; Morgan and Hunt, 1994; Doyle, 1995; Gummesson, 1996).

A relationship marketing approach is important especially in art organizations which are, as nonprofit service-oriented institutions, multi-stakeholders and multipurpose. Consequently, nonprofit organizations have many relationships that are vitally important. At the same time, they have a multitude of constituencies and must work out the relationship with each of them (Drucker, 1991; Peck 1996; Bussel, Forbes, 2006, 2007).

In the arts, in addition to the audience and visitors who are essential to the arts organization's survival (Bussel, Forbes, 2007), there are other stakeholder groups (Andreasen, Kotler, Parker, 2003; Bruce, 1995), amongst them volunteers and employees.

Art nonprofit organizations recruit employees and volunteers and invest time, money and commitment in them (Bussel, Forbes, 2006). To succeed, art organizations must focus on building effective relationships with employees and volunteers, in order to enhance their engagement and ultimately to improve their performance (Kumar, Pansari, 2016; Bussel, Forbes, 2006). To create a seamless integration between paid and unpaid workers, volunteers must be trained, supervised and evaluated as if they were employees.

In order to exploit the relationship marketing potentialities, arts nonprofit organizations must make visible their unique value proposition (Delaney, 2014; Sargeant, 2009; Wyme, Knowles, Gomes, 2006), that is the value that the nonprofit provides to its stakeholders, from the audience to volunteers, from employees to donors and to the community. Often, the unique value proposition is not fully and clearly expressed; nevertheless, its relevance is crucial both for stakeholders, as it allows them to appreciate the distinctive specificities of the organization, and for the organization itself, so that it can explain the value generated by its activities and benefits to those parties willing to offer their resources.

If the unique value proposition is consistent with the mission and it is properly communicated, it can meet stakeholders' needs and allow the art organization to recruit people as volunteers (Wymer, Knowles, Gomes 2006).

When dealing with actual and potential volunteers, employees, audience and other stakeholders, the value proposition is very important. If the value art organizations are offering is close to the value stakeholders are receiving, there should be the basis for a long-lasting relationship. The challenge is to invest in that relationship to ensure, on an ongoing basis, that all involved parties get what they want and need. In fact, people volunteer for specific benefits and will only continue with this activity if they are satisfied (Bussel, Forbes, 2002). Therefore, it is important, when dealing with volunteers, to understand the motivational mix that drives people to invest their time in volunteering (Voss, Voss, 1997), also considering that motivations change over the volunteer life cycle (Bussel, Forbes, 2003). In art organizations volunteers' motivations are often very similar to those of visitors and audience members.

Volunteers can help as *artists* directly performing the mission of the organization or as *fundraisers*, soliciting grants and contributions of money and goods and services from potential donors. They can also be in charge of some of the general activities relating to the accomplishment of the art organizations' mission.

On the one hand, for instance, art organizations can offer to participate in the effort to improve lives through art programs, on the other hand, volunteers can provide ushering, ticket taking and other services, administrative support in the office; the organization and execution of fundraising events and the promotion of nonprofit activities to their friends.

Volunteers might be regarded and managed as a source of labor, as a special type of visitor or audience member, and as part of the organization's public engagement strategy.

Employees and volunteers, working together, can provide funding, audiences, sponsorship, and support as well as act as unpaid advocates for art organizations (Bussel, Forbes, 2003; Raymond, 1992).

## THE STUDY

The main objective of the study is to investigate the impact of employees' and volunteers' activities on the performances of art organizations in the USA. Specific research objectives are represented by the following research questions:

RQ.1 Are art organizations in the USA affected by labour intensity?

RQ.2 If yes, how does it impact on these art organizations' performances?

To answer the research questions, a sample of 300 art museums, symphony orchestras and opera houses in the USA which had the highest total income in 2015 is analyzed. The sample was selected from Guidestar.com databases and clustered, thanks to a k-means cluster analysis, to identify profiles with different labour intensity.

## METHOD

990 forms from the fiscal year 2015 are here analyzed with the Internal Revenue Service (IRS), categories 'A69-Symphony Orchestra', 'A6A-Opera' and 'A51-Art museums': 100 organizations for each category, from the highest to the lowest total income. These reports can be downloaded from the Guidestar website [www.guidestar.org](http://www.guidestar.org) and the main websites of the organizations themselves. The Guidestar website contains 990 forms from nonprofits, such as detailed statements of revenues and expenses and financial statements. The sample adds up to 257 organizations, whose 990 forms were downloadable at [www.guidestar.org](http://www.guidestar.org) or at their own websites at the end of 2016.

As reported in the 990 form glossary revenues of a nonprofit organization in the USA may include: Direct public support: contributions, gifts, grants and bequests received directly from the public. It refers to amounts received from individuals, trusts, corporations, estates, foundations, public charities or raised by an outside professional fundraiser; Government contributions or grants: payments from the Government to a nonprofit organization to further the organization's public programs. Direct public support, Government contributions and grants are summed so that the whole extent of Contributions can be estimated. The other revenue categories are: Program service revenues: fees and other monies received by an organization for services rendered.

If contributions and program service revenues constitute more than 80% of the sample, ancillary revenues derive from Investment income and Other revenues. Revenue diversification will be here analyzed as concerns main categories: Contributions with the target of willingness-to-donate and Program Service Revenue with the target of willingness-to-pay.

Expense categories include: Program Service Expense related to marketing and production of the core business; Fundraising expense and Management and general expense, a miscellaneous cost that is not related to the previous accounting lines. According to IRS standards, if the fundraising expense must

be separately reported, the marketing or advertising expense can be included in the Program service expense. The advertising and marketing expense will here be separately counted so that it can be compared with the fundraising expense. The personnel expense will also be calculated here, in order to appreciate the magnitude of the internal labour intensity of employees.

Next to the analysis of revenue and expense categories, the (Net) Gain or Loss of the year as the difference – positive or negative – between revenues and costs, Net Assets and Total assets are here analyzed.

Economica performance is here connected with the ratio of employees and volunteers in these organizations. These data can be found in the first page of 990Forms.

First of all, these data are entered into Excel and indexed to total revenues – for revenue categories – and total expenses – for expense categories -. Gain or loss is also included in the analysis, indexed to total revenues. The ratio of Net Assets/Total Assets is also calculated, in order to appreciate the solvency of the sample. Employees and volunteers are calculated as ratios of the total employees+volunteers.

Secondly, these ratios are clustered, in order to obtain meaningful groups with relevant and separating features.

Cluster analysis is the process of dividing a set of observations into a number of groups. In particular, K-means clustering is an iterative follow-the-leader strategy. First, the number of clusters,  $k$ , must be specified. Then a search algorithm finds  $k$  points in the data, called seeds, that are not close to each other. Each seed is then treated as a cluster center. The routine goes through the points (rows) and assigns each point to the cluster it is closest to. For each cluster, a new cluster center is formed as the means (centroid) of the points currently in the cluster. This process continues with an alternation between assigning points to clusters and recalculating cluster centers until the clusters become stable. Cluster means show the average performances of significant groups.

## KEY FINDINGS

Having clustered the above-mentioned ratios with *JUMP Statistics*, three clusters are significant in Table 1. Five outliers will not be considered. Clusters are the sum of 252 organizations.

Number of organizations in clusters
-------------------------------------

Ratios	Labels		
	130 organizations The Marketing Expert	35 organizations The Fundraiser with the highest gain and net assets	87 organizations The Fundraiser
Contributions/Total Revenues	0.59	0.71	0.60
Program Service Revenue/Total Revenues	0.30	0.06	0.22
Program Service Expense/Total Expenses	0.76	0.71	0.74
Management and general Expense/Total Expenses	0.16	0.18	0.17
Fundraising Expense/Total Expenses	0.07	0.07	0.10
Advertising Expense/Total Expenses	0.05	0.02	0.04
Gain or Loss/Total Revenues	0.05	0.28	0.09
Net Assets/Total Assets	0.47	0.92	0.84
Personnel Expense/Total Expenses	0.52	0.43	0.36
Employees/Employees+Volunteers	0.70	0.58	0.17
Volunteers/Employees+Volunteers	0.30	0.42	0.82

Table 1. Cluster K-means, 2015's average economic performances of nonprofit art organizations in the USA (ratios) and shares of employees and volunteers.

All clusters show contributions to be the prevailing source of revenue. Nevertheless, one cluster shows the highest program service revenue (30 percent) together with the highest program service expense (76 percent). This most crowded cluster, *The Marketing Expert* shows the highest internal labour intensity, with the highest employees' share, the highest personnel expense, program service expense, advertising expense and the highest program service revenue. With 130 organizations, this cluster is giving evidence of an internal labour intensity. The volunteers' share is 30 percent, the lowest one of the sample. The fundraising expense is as much as in *the Fundraiser with the highest gain and net assets* (7 percent).

*The Fundraiser with the highest gain and net assets* is the least crowded cluster, with 35 organizations. The highest contributions are together with the second highest employees' and volunteers' shares of the sample.

*The Fundraiser with 87 organizations* shows the highest share of volunteers (82 percent) and the second highest gain and net assets. Here, the fundraising expense is the highest of the sample (10 percent).

High shares of volunteers (in clusters labelled as Fundraiser) positively affect gains and solvency in comparison with the most crowded cluster, the Marketing Expert, where volunteers' share is only 30 percent.

## DISCUSSION

The purpose of this article is to understand the impact of employees' and volunteers' activities on the performances of U.S. art organizations.

From the literature, it is apparent that nonprofit art organizations rely on paid and unpaid staff and that relationship marketing is acknowledged as a helpful paradigm for enhancing the connection among art nonprofits and their staff, ensuring that they are connected to the organization's strategic goals.

Volunteers are valuable resources for nonprofit arts organizations and they are actively working, together with employees, to increase and expand engagement with the public, with traditional and nontraditional audiences, with social issues, community needs, as well as other issues related to nonprofit management. Arts nonprofits can see their volunteers not just as a tool that helps them achieve their mission but as part of the mission itself.

To understand if and how art organizations are affected by labour intensity a k-means cluster analysis was conducted, and a profiling of art organizations in the USA detected three different clusters in 2015. The *Marketing Expert* includes 26 museums and 104 symphony orchestras and opera houses. In relation to the literature, the internal labour intensity is here influencing economic sales, so that marketing officers and fundraisers exploit the best of their relationships with multiple stakeholders. Among the museums we can find the International Center of Photography in New York, Los Angeles County Museum, Museum of Fine Arts in Boston, National Academy of Design in New York, Phillips Collection, PS1 in New York and other high-lighted museums, whose employees are fully maturing their fundraising skills. Nevertheless, price and product marketing is constantly improving with flexible pricing, edutainment, local quarters and community empowerment. The American Symphony Orchestra, California Symphony Orchestra, Chicago Symphony Orchestra and Sinfonietta, Cincinnati Symphony and Opera, Dallas Symphony Orchestra, Houston Symphony Society, Kansas City Symphony, Seattle Opera, The Atlanta Opera and the Carnegie Hall can be here praised for their fundraising strategies: memberships, funds, endowments, planned giving and calls for bequests. At the same time, they offer rush tickets (for last minute purchases with discounted price), gift certificates and cards and new-to-opera nights for newcomers with exciting pre-performances, lectures, exclusive behind the scene activities, etc. They provide flexible series like a create-your-own-season-package and a neighborhood series with connections to local restaurants and businesses.

The *Fundraiser* cluster (87 organizations) with the highest share of volunteers and the highest fundraising expense includes 39 museums. Among them, the Dallas Museum of Arts, Detroit Institute of Arts, Columbus Museum of Art, Portland Art Museum and San Diego Museum of Art target the multiple engagement of local and national friends, foundations (corporate, independent and community), sponsors, trusts, planned givers and any other philanthropy. The same and skillful fundraising is present in symphony orchestras and opera houses of this cluster. In relation to the literature, the external labour intensity is playing the pivotal role: a long-lasting relation with volunteers positively affects the motivational mix, engagement, benefits and economic performances. Between these clusters, the Fundraiser with best performances includes 33 museums (out of 35 organizations). MOMA of New York, Whitney Museum, Cleveland Museum of Art, Philadelphia Museums of Art, Denver Art Museum and other 'giants' are here included with their mature reputation, the best-trained volunteers and employees, whose skills are constantly monitored, as these organizations are focused on new targets, in order to exploit willingness-to-donate and willingness-to-pay. In relation to the literature, long-lasting and mature relationships induce the best performances. All clusters profit by gains and net assets. Nevertheless, where volunteers are present at the highest ratios, commitments and advocacy result in the best performances. Art organizations in the USA should not underestimate the importance of their internal and, above all, external labour intensity.

## MANAGERIAL IMPLICATIONS

Managers of art organizations should consider options to spend for internal and external labour intensity, stimulate and develop relations with different focus on employees and volunteers as valuable media to get in touch communities, sponsors' local governments' and other stakeholders' engagement. Managers must be aware that, in order to be competitive, relations needs to be nurtured, monitored, changed and evolved according to the needs of the organization and multiples stakeholders.

As aforementioned, marketing and fundraising have diverse positive effects, if they are carried out with an engagement approach. Engagement and empowerment of who is working 'for love and money', they result in the best economic and social (relational) performances. Managers should become aware that the advocacy of volunteers can determine the best economic performance.

Nevertheless, marketing, fundraising, volunteers' training, monitoring all require significant endeavors, in term of funding, timing, community involvement and stakeholders' engagement. Public-private partnerships are essential for the implementation of the process and in order to ensure its success.



## CONCLUSION

Employees' and volunteers' advocacy, skills and efforts positively impact and affect performances of art organizations in the USA. The cluster analysis confirms both the high level of staff engagement, for different weights of internal and external labour intensity, and economic results, above all, when fundraising is the leading strategy. Increasing fundraising mean increasing contributions, gains and net assets, thanks to the leading role of volunteers, who are calling for communities, friends, sponsors and multiple stakeholders to get involved.

Employees are essential, too. They express their skills both in marketing and fundraising, they train volunteers and they perfectly match with volunteers' commitments. Trade-offs between fundraising and marketing are avoided: resources are optimized for both strategies, so that gains and net assets are maximized.

One limitation concerns the short-term nature of analysis, for only one-year of accounting data, 2015. The very next research will engage in a longer-term analysis and a bigger sample than this one, in order to explore the impacts of labour intensity and relationship marketing on the whole nonprofit cultural industry in the USA, from performing to visual arts.

## REFERENCES

- Andreasen, A. R., Kotler, P. and Parker, D. (2003), *Strategic Marketing for Non-profit Organizations*, Prentice Hall, Upper Saddle River.
- Berry, L. L. (1995), "Relationship marketing of services—growing interest, emerging perspectives", *Journal of the Academy of marketing science*, Vol. 23 No. 4, pp. 236-245.
- Bruce, I. (1995), "Do not-for-profits value their customers and their needs?" *International Marketing Review*, Vol. 12 No. 4, pp 77-84.
- Bussell, H. and Forbes, D. (2003), "The Volunteer Life Cycle: A Marketing Model for Volunteering", *Voluntary Action*, Vol. 5 No. 3, pp. 61-79.
- Bussell, H. and Forbes, D. (2007), "Volunteer Management in Arts Organizations", *International Journal of Arts Management*, Vol. 9 No. 2, pp. 17-28.
- Bussell, H., and Forbes, D. (2002), "Understanding the Volunteer Market: The What, Where, Who and Why of Volunteering", *International Journal of Nonprofit and Voluntary Sector Marketing*, Vol. 7 No. 1, pp. 244-258.
- Bussell, H., and Forbes, D. (2003), "Making Friends: Volunteering in Arts Marketing", in S. Salvemini (Ed.), *Proceedings of the 7th International Conference on Arts and Cultural Management*, Università Bocconi, Milan.
- Bussell, H., and Forbes, D. (2006), "Developing relationship marketing in the voluntary sector". *Journal of Nonprofit & Public Sector Marketing*, Vol. 15 No. 1-2, pp. 151-174.
- Buttle, F. (1996), *Relationship Marketing: Theory and Practice*, Paul Chapman, London.
- Carpenter, J. and Myers, C.K. (2010), "Why volunteer? Evidence on the role of altruism, image, and incentives", *Journal of Public Economics*, Vol. 94 No. 11–12, pp. 911–920.
- Chaddha, M. and Rai, R.S. (2016), "Understanding What Motivates Volunteering in People", *Amity Business Review*, Vol. 17 No. 1, pp.114-121.
- Christopher, M., Payne, A. and Ballantyne, D. (1991), *Relationship Marketing*, Butterworth Heineman, Oxford.
- Colbert, F. (2001). *Marketing culture and the arts*, HEC Press: Montreal.
- Collins, B.K. and Long, L. (2015), "The underemployment puzzle: the effects of overqualification and involuntary part-time status on volunteering", *Public Administration Quarterly*, Vol. 39 No. 4, pp. 569-594.
- Conway, A. (1997), "Strategy versus Tactics in the Not-for-Profit Sector: A Role for Relationship Marketing?" *Journal of Non-Profit and Voluntary Sector Marketing*, Vol. 12 No 2, pp. 120–134.

- Das, K. (2009), "Relationship marketing research (1994-2006): an academic literature review and classification", *Marketing Intelligence & Planning*, Vol. 27 No. 3, pp. 326-363.
- Delaney, B. (2014), *Nonprofit Marketing Handbook: The hands-on guide to marketing and communications in nonprofit organizations*, CyberEdge Information Services, Oakland.
- DeVoe, S. and Pfeffer, J. (2007), "Hourly payment and volunteering: the effect of organizational practices on decisions about time use", *Academy of Management Journal*, Vol. 50 No. 4, pp. 783-798.
- Doyle, P. 1995. "Marketing in the New Millennium", *European Journal of Marketing*, Vol. 29 No 13, pp. 23- 41.
- Drucker, P. (1991), *Managing the Nonprofit Organisation*. Butterworth Heinemann, Oxford.
- Einolf, C. and Chambré, S. M. (2011), "Who volunteers? Constructing a Hybrid theory", *International Journal of Nonprofit and Voluntary Sector Marketing*, Vol. 16, pp. 298-310.
- Ertas, N. (2016), "Millennials and volunteering: sector differences and implications for public service motivation theory", *Public Administration Quarterly*, Vol. 40 No. 3, pp. 517-558.
- Ewing, R.L., Govekar, M.A., Govekar, P.L. and Rishi, M., (2002), "Economics, Market Segmentation and Recruiting: Targeting Your Promotion to Volunteers' Needs", *Journal of Nonprofit and Voluntary Sector Marketing*, Vol. 10 No. 1, pp. 61-77.
- Gainer, B., and Padanyi, P. (2002), "Applying the marketing concept to cultural organisations: an empirical study of the relationship between market orientation and performance", *International Journal of Nonprofit and Voluntary Sector Marketing*, Vol. 7 No. 2, pp. 182-193.
- Grant, A.M. (2012), "Giving Time, Time after Time: Work Design and Sustained Employee Participation in Corporate Volunteering", *Academy of Management Review*, Vol. 37 No. 4, pp. 589-615.
- Grönroos, C. (1994), "Quo Vadis, Marketing? Toward a Relationship Marketing Paradigm", *Journal of Marketing Management*, Vol. 10 No. 5, pp- 347-360.
- Grönroos, C. (1996), "Relationship marketing: strategic and tactical implications", *Management Decision*, Vol. 34 No. 3, pp. 5-14.
- Grönroos, C. (2004), "The relationship marketing process: communication, interaction, dialogue value", *Journal of Business & Industrial Marketing*, Vol. 19 No. 2, pp. 99-113.
- Gummesson, E. (1996), "Mega and Non Relationships in Relationship Marketing", *Irish Marketing Review*, Vol. 9, pp. 9-16.
- Handy, F., Mook, L. and Quarter, J. (2007), "The interchangeability of paid staff and volunteers in nonprofit organizations", *Nonprofit and Voluntary Sector Quarterly*, Vol. 37 No. 1, pp. 76-92.
- Hegenbuch, D.J., Little, S.W. and Lucas, D.J. (2015), "Beyond Association: How Employees Want to Participate in Their Firms' Corporate Social Performance", *Business and Society Review*, Vol. 120 No. 1, pp. 83-113.
- Hill, E., O'Sullivan, C. and O'Sullivan, T. (1995), *Creative Arts Marketing*, Butterworth Heinemann, Oxford.
- Hussain, S. B., Rawjee, V.P. and Penceliah, S. (2014), "The applicability of relationship marketing at non-profit organizations: a developing country perspective", *Problems and Perspectives in Management*, Vol. 12 No. 4., pp 155-160.
- Katz, E. and Rosenberg, J. (2005), "An economic interpretation of institutional volunteering", *European Journal of Political Economy*, Vol. 21 No. 2, pp. 429-443.
- Kolb, B. M. (2013), *Marketing for Cultural Organizations: New Strategies for Attracting Audiences*, Routledge, New York.
- Kumar, V., & Pansari, A. (2016) "Competitive Advantage Through Engagement", *Journal of Marketing Research*, Vol. 53, No. 4, pp. 497-514.
- Lovelock, C. H., Weinberg, C. B. (1984), *Public and nonprofit marketing—cases and readings*, The Scientific Press, Palo Alto.
- Meier, S. and Stutzer, A. (2008), "Is volunteering rewarding in itself", *Economica*, Vol. 75 No. 297, pp. 39-59.
- Morgan, R. M., & Hunt, S. D. (1994), "The commitment-trust theory of relationship marketing", *Journal of Marketing*, Vol. 58 No 3, pp. 20- 38.
- Padanyi, P., and Gainer, B. (2004), "Market Orientation in the Nonprofit Sector: Taking Multiple Constituencies into Consideration", *Journal of Marketing Theory and Practice*, Vol. 12 No. 2, pp. 43-58.
- Peck, H. (1996). "Towards a Framework for Relationship Marketing - The Six Markets Model Revisited and Revised," in 2001-A Vision for the Next 25 Years, *Proceedings of Marketing Education Group Annual Conference*, University of Strathclyde.
- Radbourne, J. and Margaret, F. (1996), *Arts Management – a practical guide*, Allen & Unwin, Sydney.
- Raymond, C. (1992), *Members Matter*, Arts Council of Great Britain. London.
- Rentschler, R., Radbourne, J., Carr, R. and Rickard, J. (2002), "Relationship Marketing, Audience Retention and Performing Arts Organisation Viability", *International Journal of Nonprofit and Voluntary Sector Marketing*, Vol. 7 No 2, pp. 118-130.

- Rodell, J.B. and Lynch, J.W. (2016), "Perceptions of employee volunteering: is it 'credited' or stigmatized' by colleagues?", *Academy of Management Journal*, Vol. 59 No. 2, pp. 611-635.
- Sargeant, A. (2009), *Marketing management for nonprofit organizations*, Oxford University, Oxford.
- Slavich, B. and Montanari, F. (2009), "New trends of managerial roles in performing arts: empirical evidence from the Italian context", *Cultural Trends*, Vol. 18 No. 3, pp. 227-237.
- Turbide, J. and Laurin, C. (2009), "Performance Measurement in the Arts Sector: The Case of the Performing Arts", *International Journal of Arts Management*, Vol. 11 No. 2, pp. 56-70.
- Turbide, J., Laurin, C., Lapierre, L. and Morissette, R. (2008), "Financial Crises in the Arts Sector: Is Governance the Illness or the Cure?", *International Journal of Arts Management*, Vol. 10 No. 2, pp. 4- 13.
- Van Erde, W. and Peper, P. (2008), "Deviant service behavior: coming soon to a theatre near you?", *The Service Industries Journal*, Vol. 28 No. 1, pp. 85-93.
- Voss, G.B. & Voss, Z.G. (1997), "Implementing a relationship marketing programme: A case study and managerial implications", *Journal of Services Marketing*, Vol. 11 No. 4, pp. 278-298.
- Wyme, W., Knowles, P.A. and Gomes, R. (2006), *Nonprofit Marketing: Marketing Management for Charitable and Nongovernmental Organizations*, Sage, Thousand Oaks.
- Ziemek, S. (2006), "Economic analysis of volunteers' motivations: A cross-country study", *Journal of Socio-Economics*, Vol. 35 No. 3, pp. 532-555.

## CAN A HIGH WOMEN QUOTA IN SUPERVISORY BOARDS INFLUENCE ENTERPRISE SUCCESS?

**Binder, B.C.K.**

School of Engineering, Pforzheim University, Pforzheim, Germany

### **ABSTRACT**

Many large companies in Europe include mainly men in supervisory boards and the women quota is often lower than 20 %. In Germany an optional women quota of 30 % in supervisory boards was proposed for capital market oriented companies in 2016. Some assume that without a gender quota the earnings of enterprises would shrink as male and female members in supervisory teams do not work in such a harmonized and structured way. Others think that a women quota in supervisory boards should be requested by law and should not remain optional. In this context, conducting research and analysing the impact of the women's presence in supervisory boards on the success of companies appear as a necessary topic. The present article looks at the companies of EURO STOXX 50 in the year 2015 and their success and tries to establish whether this success can be related to the percentage of female members in supervisory positions. It replicates in this way the study of Binder, Alonso-Almeida and Bremser (2016) which analysed the relationship between female's representation in the management board (executive board) and firm performance (measured by earnings before taxes - EBT) of the EURO STOXX 50 companies in 2014. It is in the same time an extension of the original study as the supervisory board is brought under scrutiny.

*Keywords: women on corporate boards, firm performance, key performance indicators, gender quota, earnings before taxes*

### **INTRODUCTION**

This article contributes to the literature in the field of Key Performance Indicators (KPIs) as success factors e.g. the Earnings before Taxes (EBT). It offers an insight into the relationship between the economic success of 50 European companies and the gender balance on supervisory boards. For this purpose the article builds upon existing literature in the field of KPIs, diversity management, supervisory boards, and women quota, etc. Thus, the paper can help investors or business owners to gain a thorough understanding of the current business environment. The paper is structured as follows: the next section presents the literature review and introduces the hypothesis. Section three contains the research methodology. In section four the findings are discussed. Finally, section five develops insights

for investors and owners and shows the limitations of the study and offers suggestions for future lines of research.

## LITERATURE REVIEW

A controversial issue during the past decades was women's presence in supervisory boards. Women are still the exception in German supervisory boards but their representation increased gradually (Holst and Kirsch, 2014). It can be seen that more women are integrated in supervisory boards in Northern Europe (e.g. Norway, Iceland, Latvia, Finland and Sweden to mention the top 5 countries with the highest women quota). It depends on the examined countries if a study can find a significant link between firm performance and the women quota in supervisory boards. On the one hand, it was shown e.g. for Denmark that a higher women quota in supervisory boards can determine a better company performance (Lückerath-Rover, 2011) but on the other hand, this finding could not be verified for the same country by other studies (Rose, 2007).

Beaufort and Summers (2013) identified at European level a 1.5% change of women representation in mainly male supervisory boards between 2009 and 2013. If women were already member in a supervisory board, the women quota was likely to increase further. When one woman was a board member, the women quota stood at 3.2%; by already 3 women in the supervisory board, the women quota increased to 3.7%. According to the above study the average women quota in supervisory boards in Europe in 2013 was 7.9%. France stood out as a positive example with a women quota of 28.1% in 2013.

Another result was registered by a Catalyst study which examines the relationship between women on corporate boards and their companies' financial performance in the United States (Catalyst, 2007). The study "Women matter. Gender diversity, a corporate performance driver" shows that companies with a higher proportion of women in top management perform better (McKinsey, 2007). Other authors signal rather the lack of evidence that female representation in supervisory boards improves profitability (Ferreira, 2014). It is suggested that rather benefits for the society should be measured when women occupy supervisory board positions. In a study with 108 German large corporations which took place between 2009 and 2013, there was not enough evidence to indicate a significant relationship between gender diversity and firms' financial performance (Dick, 2015).

There are however, institutional factors driving gender quotas in supervisory boards such as e.g. welfare provision for state-owned enterprises, political coalitions and a legacy of initiatives (Terjesen *et al.*, 2015). It is more likely to establish a high gender quota in supervisory board with left-leaning governments. In a survey of 201 Norwegian firms the positive effect of the women quota in supervisory boards is seen in increased board development activities and in a decreased level of conflict (Nielsen,

2010). Another exhaustive study, in which 2.360 companies from the Morgan Stanley Capital International All Country World Index (MSCI ACWI) were observed over a period of 6 years by the Credit Suisse Research Institute (2012) shows as a result a better mix of leadership skills, a wider pool of talent and a better risk aversion, the higher the women quota in supervisory boards in the companies is (Kersley and O'Sullivan, 2012).

What needs to be acknowledged is the fact that gender balance became a priority and diversifying corporate supervisory boards often represent a target to be achieved. Small improvements can be seen with a law instituted quota for women in supervisory boards (Corkery and Taylor, 2012). In Norway, Italy, France, Spain and starting with 2016 also in Germany optional gender quota exist (Sullivan, 2015). Norway was the first country to legislate board quotas in 2004 and many countries followed with law determined or optional women quotas in supervisory boards, however, less than 10 % of the board members consist of women (Dizik, 2015).

Moreover, men in supervisory boards have often better networks and for this reason the male supervisory board managers often recruit male followers which minimizes the women quota in supervisory boards on the long run (Terjesen *et al.*, 2015). Rosa *et al.*, (1996) analysed the impact of gender on small business performance in the United Kingdom (UK) and concluded that there are "some considerable differences by sex in quantitative economic and financial performance measures" (p. 476).

Another study with reversed causality shows that in over 3,876 public companies the presence of independent female directors is necessary in supervisory boards to contribute best to the firms' performance (Terjesen *et al.*, 2015). This means that, when no women are included as supervisory board members, the companies' results are lower (measured by Tobin's Q and shown by the Return on assets ROA). Finally, another study with reversed causality about 151 of the capital market listed German firms shows that only after a critical mass of about 30% (e.g. 3 women in absolute positions) is attained, then a higher firm performance can be reached (Joecks *et al.*, 2012).

The present research focuses on the companies of the EURO STOXX 50 index, and aims at exploring whether there is a link between the EBT of these successful European companies and the number of women in supervisory boards. It has to be noted that the relationship between the EBT and the women quota in management boards was analysed thoroughly by Binder *et al.*, (2016), however, the focus of this article lies on the supervisory board and especially on the link between firms' performance measured by EBT and the proportion of women on the supervisory boards. The following hypothesis is formulated and will be tackled in the following sections:

H1: Enterprises which have a higher gender quota in supervisory boards are more successful and achieve a higher EBT.

## **METHODOLOGY**

The EURO STOXX 50 Index was selected to represent the performance of the 50 largest companies among 19 supersectors in the year 2015. There are enterprises of seven Eurozone countries which are integrated in this index. This index has a fixed number of components and is part of the STOXX blue-chip index family. Moreover, EURO STOXX 50 index is one of the most liquid indices for the Eurozone and serves for benchmarking purposes. The index is a financial control index which ensures stable and up-to-date figures. It represents the performance of only the largest and most liquid companies in a sector (STOXX Limited, 2016).

The research was conducted for the first time at the beginning of the year 2016 and it was carried on in the year 2017. The original study published in 2016 tackled the relationship between EBT and the women quota of executive boards, relying on data extracted from the 2014 annual reports of the fifty EURO STOXX companies and financial websites (compare figure 1).

Nr.	Company's name	Sector	Country	No. of Women	Total supervisory board members	Percentage of Women on the Board	Earnings before Taxes (in Mio. EUR)	Employees total	EBT/Total no. of Employees (in thousands)
1	Air Liquide	Chemicals	FR	5	12	41,67%	2.490,40	50.000	49,81
2	AIRBUS GROUP SE	Industrial Goods & Services	FR	2	12	16,67%	2.359,00	136.574	17,27
3	ALLIANZ	Insurance	DE	4	13	30,77%	9.763,00	142.459	68,53
4	ANHEUSER-BUSCH INBEV	Food & Beverage	BE	2	14	14,29%	11.482,33	150.000	76,55
5	ASML HLDG	Technology	NL	3	9	33,33%	1.856,08	14.681	126,43
6	ASSICURAZIONI GENERALI	Insurance	IT	4	10	40,00%	3.293,00	70.000	47,04
7	AXA	Insurance	FR	5	14	35,71%	7.521,00	98.279	76,53
8	BASF	Chemicals	DE	3	12	25,00%	5.297,00	112.435	47,11
9	BAYER	Chemicals	DE	4	20	20,00%	5.254,00	116.800	44,98
10	BCO BILBAO VIZCAYA ARGENTARIA	Banks	ES	3	12	25,00%	4.428,00	137.968	32,09
11	BCO SANTANDER	Banks	ES	4	11	36,36%	9.172,00	193.863	47,31
12	BMW	Automobiles & Parts	DE	6	20	30,00%	8.706,00	122.244	71,22
13	BNP PARIBAS	Banks	FR	7	14	50,00%	9.790,00	189.077	51,78
14	CARREFOUR	Retail	FR	4	16	25,00%	1.673,00	380.920	4,39
15	DAIMLER	Automobiles & Parts	DE	5	20	25,00%	12.280,00	284.015	43,24
16	DANONE	Food & Beverage	FR	5	13	38,46%	1.925,00	99.771	19,29
17	DEUTSCHE BANK	Banks	DE	7	22	31,82%	-6.261,00	101.104	-61,93
18	DEUTSCHE POST	Industrial Goods & Services	DE	7	20	35,00%	2.055,00	497.745	4,13
19	DEUTSCHE TELEKOM	Telecommunications	DE	8	20	40,00%	4.754,00	225.243	21,11
20	E.ON	Utilities	DE	2	12	16,67%	-5.841,00	56.490	-103,40
21	ENEL	Utilities	IT	2	6	33,33%	5.229,00	67.914	76,99
22	ENGIE	Utilities	FR	11	19	57,89%	-5.262,00	154.950	-33,96
23	ENI	Oil & Gas	IT	1	5	20,00%	-3.535,00	28.246	-125,15
24	ESSILOR INTERNATIONAL	Health Care	FR	3	16	18,75%	1.120,00	61.000	18,36
25	FRESENIUS	Health Care	DE	0	12	0,00%	3.262,00	222.305	14,67
26	GRP SOCIETE GENERALE	Banks	FR	7	14	50,00%	5.878,00	145.700	40,34
27	IBERDROLA	Utilities	ES	5	13	38,46%	2.931,30	30.938	94,75
28	Industria de Diseno Textil SA	Retail	ES	2	8	25,00%	3.212,67	152.854	21,02
29	ING GRP	Banks	NL	2	8	25,00%	5.680,00	54.873	103,51
30	INTESA SANPAOLO	Banks	IT	5	19	26,32%	4.056,00	90.807	44,67
31	L'OREAL	Personal & Household Goods	FR	6	15	40,00%	4.517,40	82.900	54,49
32	LVMH MOET HENNESSY	Personal & Household Goods	FR	4	17	23,53%	5.983,00	125.346	47,73
33	MUENCHENER RUECK	Insurance	DE	8	20	40,00%	3.223,00	43.554	74,00
34	NOKIA	Technology	FI	2	8	25,00%	1.511,00	56.690	26,65
35	ORANGE	Telecommunications	FR	6	15	40,00%	3.197,00	156.000	20,49
36	PHILIPS	Industrial Goods & Services	NL	3	9	33,33%	623,00	112.959	5,52
37	SAFRAN	Industrial Goods & Services	FR	4	17	23,53%	-1.355,00	70.087	-19,33
38	SAINT GOBAIN	Construction & Materials	FR	6	15	40,00%	622,00	170.372	3,65
39	SANOFI	Health Care	FR	5	14	35,71%	5.243,00	115.631	45,34
40	SAP	Technology	DE	4	18	22,22%	3.991,00	76.986	51,84
41	SCHNEIDER ELECTRIC	Industrial Goods & Services	FR	5	13	38,46%	1.736,00	160.000	10,85
42	SIEMENS	Industrial Goods & Services	DE	6	20	30,00%	5.983,00	348.000	17,19
43	TELEFONICA	Telecommunications	ES	2	18	11,11%	316,00	129.890	2,43
44	TOTAL	Oil & Gas	FR	4	12	33,33%	3.677,45	96.019	38,30
45	UNIBAIL-RODAMCO	Real Estate	FR	4	11	36,36%	2.678,30	1.966	1.362,31
46	UNICREDIT	Banks	IT	1	5	20,00%	1.775,88	43.479	40,84
47	UNILEVER NV	Personal & Household Goods	NL	6	11	54,55%	7.133,00	168.921	42,23
48	VINCI	Construction & Materials	FR	6	15	40,00%	3.022,00	185.452	16,30
49	VIVENDI	Media	FR	6	14	42,86%	1.196,00	16.395	72,95
50	VOLKSWAGEN PREF	Automobiles & Parts	DE	3	20	15,00%	-5.688,00	114.006	-49,89

Figure 1: Overview of the 50 EURO STOXX companies from 2015 (Source: own representation based on the information from: <https://www.stoxx.com/index-details?symbol=SX5E>, retrieval date: 03/03/2017)

The current study looks at the number of women in supervisory boards as presented in the 2015 annual reports of the fifty EURO STOXX companies, and data regarding the EBT of each of the fifty companies was collected similarly to the research from 2016, via financial websites.

The composition of EURO STOXX index in 2015 changed slightly in comparison to the year before. Two new companies were included in the EURO STOXX index: Fresenius (Germany) and Safran (France) replaced Repsol (Spain) and REWE (Germany), a change which became effective on September



2015 (STOXX Limited, 2015). The composition change of the index takes place once a year, in September, when only the biggest companies are maintained on the basis of their market capitalization and their price index. Out of the 50 EURO STOXX companies four have e.g. the highest index weights: Total (France) with 4.78%, Sanofi-Aventis (France) with 4.39 %, Bayer (Germany) with 4.29 %, and Anheuser-Busch InBev (Belgium) with 4.11 %.

In order to examine how successful these companies are, the EBT was chosen as being a relevant KPI, taking thus into consideration the fact that companies may face different tax rates in different states. In other words, the lack of a harmonized taxation system across the Eurozone will not affect the results of this study, the EBT making possible a comparison of the 50 EURO STOXX companies at European level.

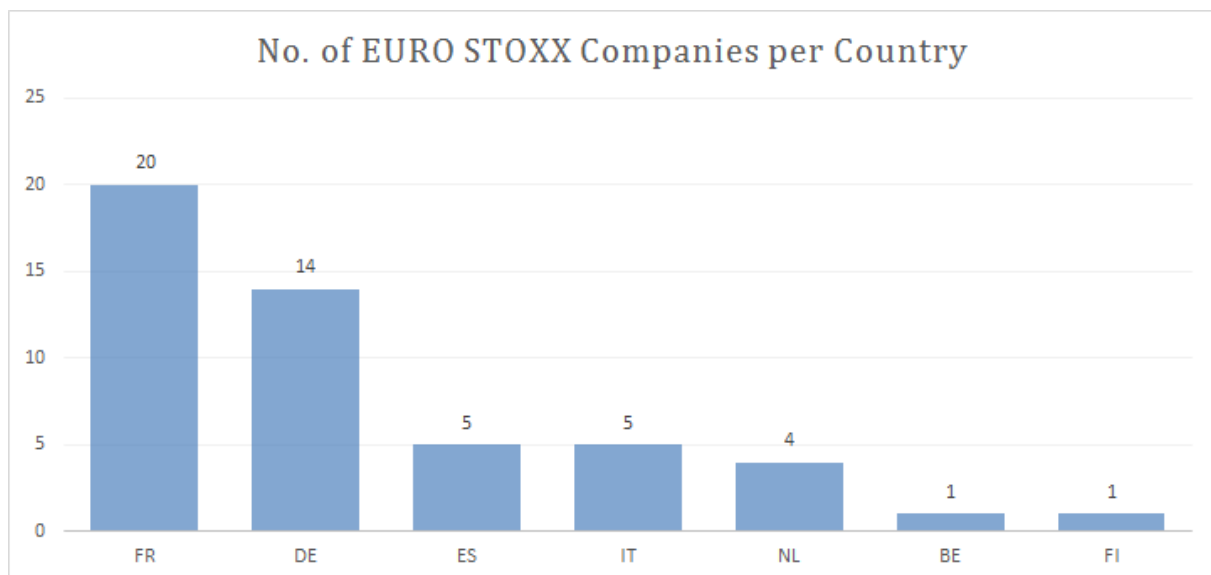

Figure 2: Number of EURO STOXX companies per country (Source: own representation based on the information from: <https://www.stoxx.com/index-details?symbol=SX5E>, retrieval date: 03/03/2017)

## FINDINGS

Figure 2 shows the number of companies that each country has in EURO STOXX 50 index. Most EURO STOXX companies are located in France (20) followed by Germany (14), Spain (5) and Italy (5). The Netherlands has four companies in the EURO STOXX index, while Belgium and Finland have only one big company.

In order to test the raised hypothesis (H1: Enterprises which have a higher gender quota in supervisory boards are more successful and achieve higher EBT), two steps are necessary. In a first step, the EBT and the EBT / employee of the selected companies should be examined. In a second step, the gender

quota per sector and in total should be analyzed for supervisory boards and the findings should be brought together.

Figure 3 shows a top 10 ranking of the EURO STOXX companies according to their achieved EBT in 2015.

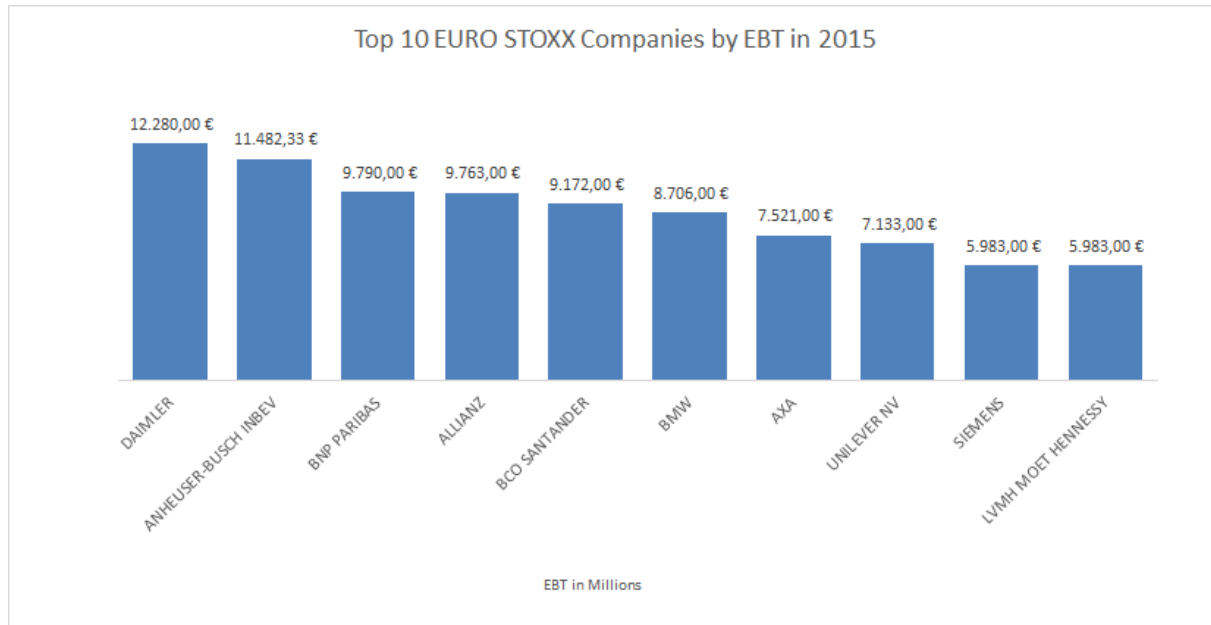
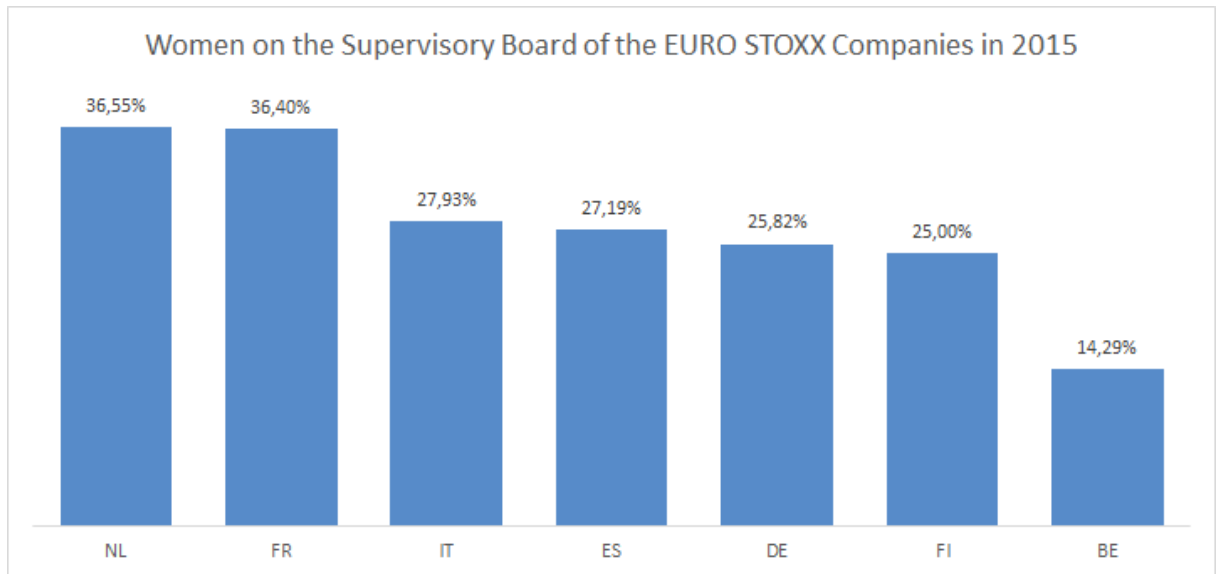

Figure 3: Top 10 EURO STOXX companies by EBT with figures of 2015 in million EUR (Source: own representation – the EBTs of all the 50 companies were taken from <http://www.finanzen.net/> - retrieval date: 03/03/2017)

On the first place in 2015 was Daimler (Germany) with an EBT of €12.3 million, also the highest value of all companies analysed in this study. Daimler has overtaken Volkswagen (Germany), which was on the first place in 2014 with €10.8 million, but it suffered a serious draw back in 2015 due to the emissions scandal. Daimler is followed in the 2015 EBT-ranking by Anheuser-Busch InBev (Belgium) with €11.5 million and BNP Paribas (France) with € 9.8 million.

While in the 2014 EBT-ranking one could find Deutsche Bank (Germany), E-On (Germany), Enel (Italy) or Eni (Italy), in 2015 these four companies are no longer among the biggest companies by EBT. Deutsche Bank e.g. suffered in 2015 claims for compensation and the energy sector went through a critical situation which caused in all cases lower EBTs for these companies.

If by now the focus was on offering a broad insight on the EURO STOXX companies and the KPI EBT, in the following section the emphasis will be on completing this insight by introducing also the information on gender quotas in supervisory boards as found in the annual reports of the EURO STOXX companies. In this respect, figure 4 shows the percentage of women in supervisory boards in each of the 7 countries.



*Figure 4: Number of women on the supervisory board of EURO STOXX companies in 2015 in different countries*

*(Source: own representation – the information with regard to the number of women on the supervisory board was extracted from the 2015 annual reports of the respective companies)*

In six out of the seven countries the women quota in supervisory boards in 2015 is higher than 25% in average. In contrast only in two countries the women quota in management boards in the year 2014 was higher than 25%: This shows that there are more women in supervisory boards than in management boards. The highest women quota in supervisory boards has Netherland with 36.6% followed by France with 36.4%. Additionally, it can be seen that the expected women quota of 30 – 40% is not yet achieved by EURO STOXX companies.

Due to the fact that the countries Germany and France have the highest number of companies in EURO STOXX 50 index and the highest EBT per company and per employee these two countries are examined more closely.

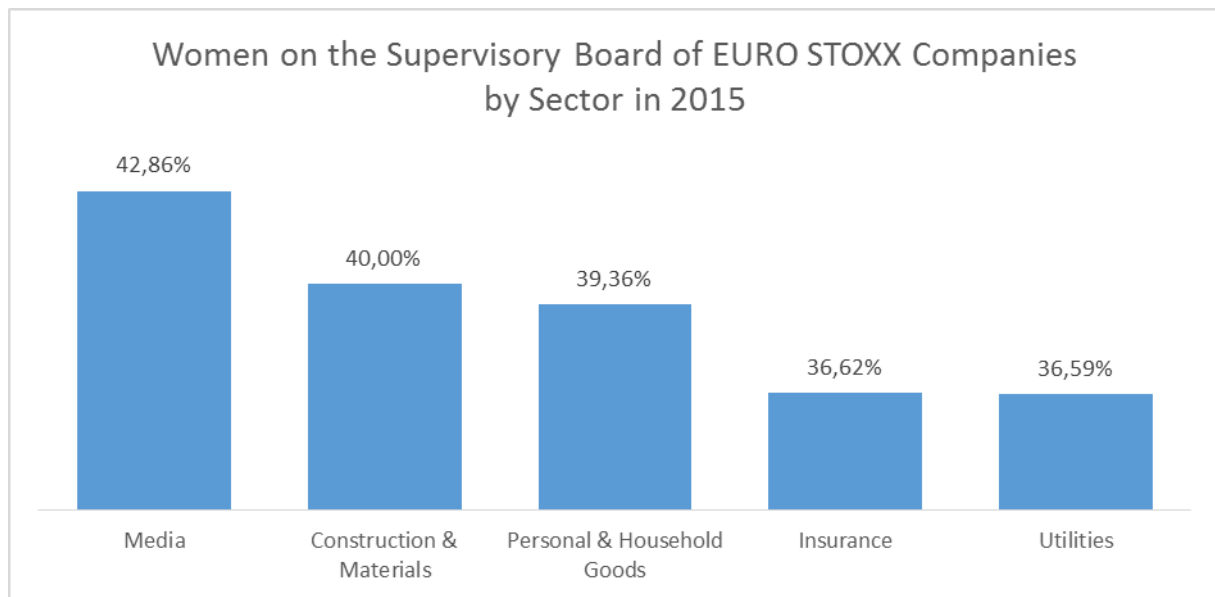

Figure 5: Womens' quota on the supervisory board of EURO STOXX companies in 2015 by sectors – a top five (Source: The information with regard to the number of women on the supervisory board was extracted from the annual reports of the respective companies end of 2015)

The analysis can be deepened by looking at the women quota in different sectors. Figure 5 displays a top 5 ranking of the sectors according to women' presence in supervisory board. The highest women quota in supervisory boards can be seen in the media sector (42.9%). However, this can be misleading as there is only one company – Vivendi (France) – active in this sector. Vinci (France) and Saint Gobain (France) follows with a women quota in supervisory boards of 40.0%, but again these are the only two companies active in the sector 'Construction & Materials'. The sectors 'Personal & Household Goods', 'Insurance', and 'Utilities' follow with more companies that are located in these sectors to strengthen the results. In all of these sectors the women quota in supervisory boards is therefore over 35%. If this value is considered, then this answers the expectations which are entrenched in the law of several countries or in the corporate codes of different companies as recommendation.

Finally, the next figure presents the first three sectors which have the highest women quota in supervisory boards per country.

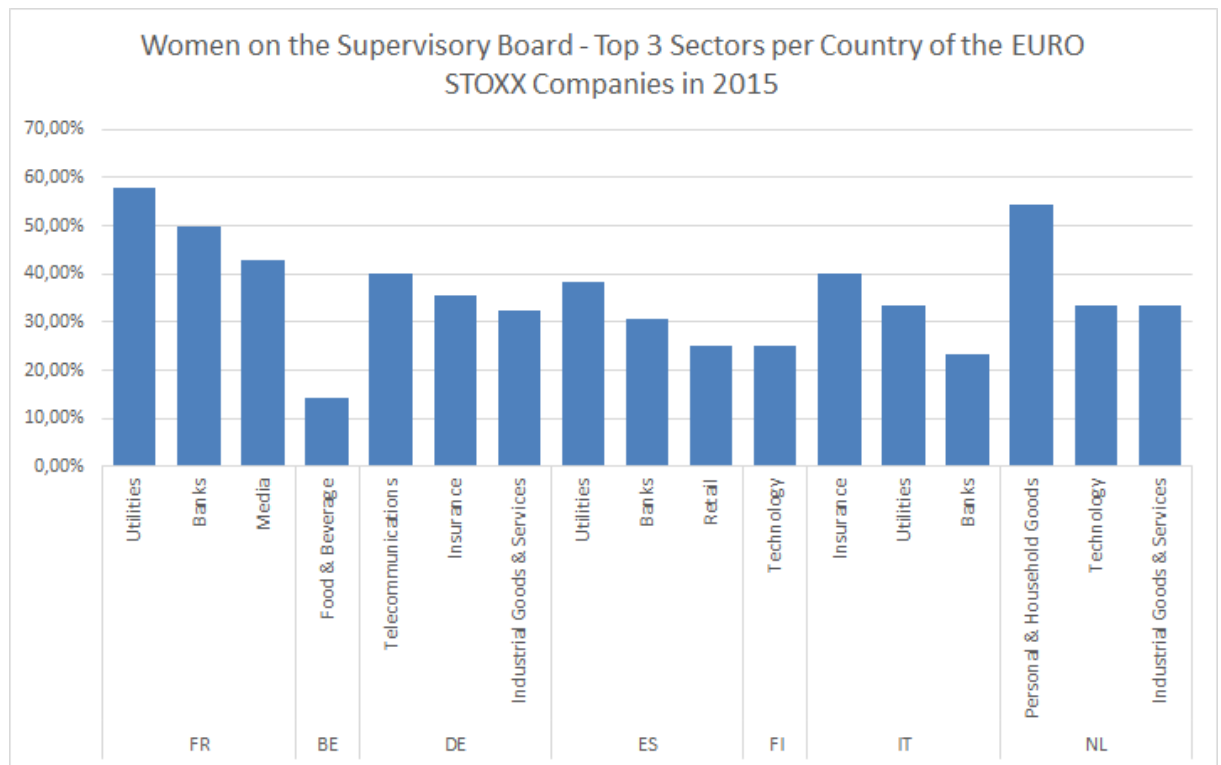

Figure 6: Number of women in the supervisory board in STOXX companies in 2015 in the Top three sectors of each country (Source: own representation – the information with regard to the number of women on the supervisory board was extracted from the 2015 annual reports of the respective companies)

It can be shown that the women quota is high especially in traditional branches such as 'Personal and Household Goods' e.g. in the Netherlands. A relative high women quota can be seen e.g. in France in the branches 'Utilities', 'Banks', and 'Media'. Lower women quota in supervisory boards can be found in new technology branches such as 'Telecommunication' or 'Industrial Goods and Services' e.g. in Germany. This result is significant over all countries.

If France and Germany, the countries with the highest number of companies in the EURO STOXX index are compared, further differences can be identified. In France, the sectors with the highest women representation in the supervisory boards are 'Utilities', 'Banks' and 'Media' with a women quota in supervisory boards of 58%, 50% and 43% respectively.

When these sectors with a high women quota in supervisory boards are compared to the companies with the highest EBT per employee, hypothesis 1 can be verified: in the top 10 companies by EBT per employee all enterprises of the 3 sectors with the highest women quota are present (see figure 7).

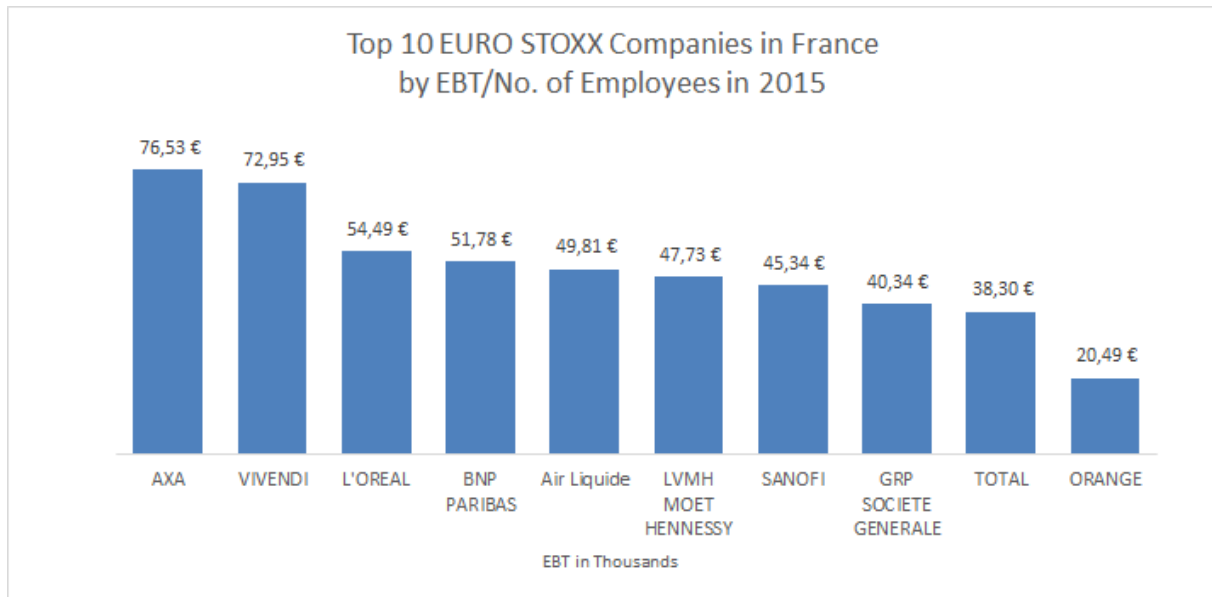

Figure 7: Top 10 EURO STOXX companies in France by EBT / number of employees x 1.000 in 2015 (Source: own representation – the information with regard to the number of women on the supervisory board was extracted from the 2015 annual reports of the respective companies)

If one looks e.g. at the sector 'Banks' enterprises such as BNP Paribas and GRP Société Générale are included in top 10, and in the 'Media' sector the company Vivendi is enclosed in the top 10 best enterprises by EBT per employee. The sector 'Utilities' shows a special situation as the enterprise Engie had a negative EBT in 2015 due to high depreciations and cost saving projects. For this reason Engie was not included in the hypothesis' verification.

In Germany, the highest women quota in supervisory boards is reached in companies from different sectors compared to France: 'Telecommunications' (40%), 'Insurance' (35%) and 'Industrial Goods and Services' (33%). The women quota in Germany is in general much lower. Germany has the most successful companies in terms of EBT and EBT per employee but it has a women quota of only 26%.

The sector 'Automobiles and Parts' in which Germany makes high profits is not even mentioned under the three most important sectors when the women quota in supervisory boards of the EURO STOXX companies is measured. In spite of this, hypothesis 1 (H1: Enterprises which have a higher gender quota in supervisory teams are more successful and achieve a higher EBT.) can be verified.

In the top 10 best companies by EBT per employee in Germany, one can find e.g. in the sector 'Telecommunications' the company Deutsche Telekom. In the 'Insurance' sector Münchener Rück, and Allianz are included as best companies by EBT per employee. Siemens can be seen in the sector 'Industrial Goods and Services' as the best company by EBT per employee. Moreover, in top 10 companies by EBT per employee all enterprises of the 3 sectors with the highest women quota are included (see figure 8).

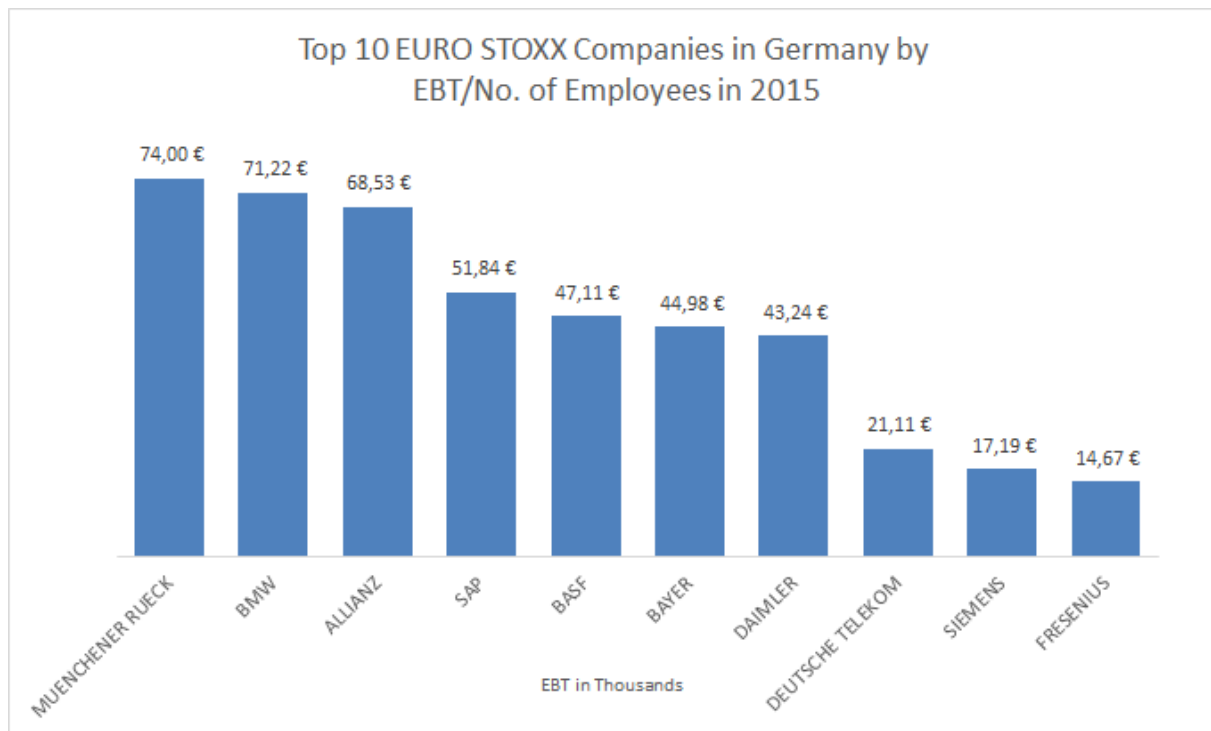

*Figure 8: Top 10 EURO STOXX companies in Germany by EBT / number of employees x 1.000 in 2015 (Source: own representation – the information with regard to the number of women on the supervisory board was extracted from the 2015 annual reports of the respective companies)*

To conclude, France has a higher concentration of women in supervisory positions (36%) as well as a higher number of companies in the EURO STOXX index. However, these companies are less successful than the German companies in terms of EBT per employee. The German companies have a better EBT per employee although the women quota is lower when compared with that of French companies (26%). However, the 26 % women quota seems to lead to better results by EBT per employee in the top 10 companies compared to other German enterprises.

When the correlation between the EBT and the percentage of women on supervisory board is shown in the case of the French companies, all enterprises except of Engie (which registered a negative EBT) show a positive correlation. A similar result can be seen also in the case of German companies after running a correlation for the EBT and the percentage of women on the supervisory board, all companies show a positive correlation. Finally an increasing women quota in the German companies seems to cause an increasing EBT.

## DISCUSSION OF RESULTS AND CONCLUSION

As the statistical analysis of the previous section has shown, hypothesis 1 (H1: Enterprises which have a higher gender quota in supervisory teams are more successful and achieve a higher EBT) can be

supported. Nevertheless, these findings should be treated cautiously. They do not imply that women in supervisory positions are more effective than men. With the exception of three companies, the supervisory boards of the other EURO STOXX 50 companies contain mainly male persons. The success of a company is also a result of the entire supervisory board, male and female alike.

Moreover, a successful result in the form of EBT or EBT per employee for an enterprise is generated mainly by the management board and not by the supervisory board only.

Furthermore, another type of information should be included in future research, such as women qualification, experience, educational background, etc. All these aspects could provide a more realistic image regarding the role of women in supervisory boards and company performance. Moreover, as presented in the literature review, female participation in supervisory boards shows mixed results with regard to company performance. Therefore, a more holistic approach is needed, researching not only the number of women on board but also considering women participation in total workforce, industry' sectors, management, subsidiaries, etc.

In the same time EBT as a performance indicator provides only a rough approximation of company success, a combination of indicators could provide better results. Even the consequent measurement of the KPI EBT per employee in all cases as relative figure brings additional insights. A long term research could bring more results and appropriate solutions to improve the situation of women the boards of companies.

## REFERENCES

- Beaufort V., Summers L., 2013. Women and Corporate Governance: Towards a New Model!, Research Center, ESSEC Working Paper 1312, 01 –44.
- Binder B.C.K., Alonso-Almeida M.M., Bremser K., 2016. Is enterprise success a women's topic, in: Proceedings of Euromed Conference 9, 267 – 278.
- Catalyst, 2007, The Bottom Line: Corporate Performance and Women's Representation on Boards: Available at: <http://www.catalyst.org/knowledge/bottom-line-corporate-performance-and-womens-representation-boards> (accessed 31 March 2017).
- Corkery J.F., Taylor M., 2012. The gender gap: A quota for women on the board Available at: <http://epublications.bond.edu.au/cgi/viewcontent.cgi?article=1026&context=cgej> (accessed 31 March 2017).
- Dick A., 2015. Female directors on German supervisory boards and firms' financial performance, University of Twente: Available at: [http://essay.utwente.nl/67308/1/DICK\\_BA\\_IBA.pdf](http://essay.utwente.nl/67308/1/DICK_BA_IBA.pdf) (accessed 31 March 2017).
- Dizik A., 2015. Do quotas for corporate boards help women advance: Available at: <http://review.chicagobooth.edu/magazine/spring-2015/do-quotas-for-corporate-boards-help-women-advance> (accessed 31 March 2017).
- Ferreira, D., 2014. Board Diversity: Should we trust Research to Inform Policy? in: Corporate Governance: An International Review, (2014), 22(2), 1 - 4.
- Holst E., Kirsch A., 2014. Women still the exception on executive boards of Germany's large firms: Gradually increasing representation on supervisory boards, DIW Economic Bulletin, 4(3), 3-15.
- Joecks J., Pull K., Vetter K., 2013, Gender Diversity in the Boardroom and Firm Performance: What exactly constitutes a "Critical Mass?, Available at: <http://link.springer.com/article/10.1007/s10551-012-1553-6> (accessed 31 March 2017).



- Kersley R., O'Sullivan M., 2012. Credit Suisse Research Institute, 2012. Gender Diversity and Corporate Performance. Available at: <https://publications.credit-suisse.com/tasks/render/file/index.cfm?fileid=88EC32A9-83E8-EB92-9D5A40FF69E66808> (accessed 31 March 2017).
- Lückerath-Rover M., 2011. Women on boards and firm performance.. Available at: DOI: 10.1007/s10997-011-9186-1 at Springerlink.com <https://repub.eur.nl/pub/31183/006695.pdf> (accessed 31 March 2017).
- McKinsey&Company, 2007. Women Matter: Gender Diversity, a Corporate Performance Driver. Available at: <http://www.raeng.org.uk/publications/other/women-matter-oct-2007> (accessed 31 March 2017).
- Nielsen, S. and Huse, M. (2010), The Contribution of Women on Boards of Directors: Going beyond the Surface, in: *Corporate Governance: An International Review*, (2010), 18(2), 136–148
- Rosa, P., Carter, S., Hamilton, D., 1996. Gender as a determinant of small business performance: insights from a British study. *Small Business Economics* 8 (4), 463-478.
- Rose, C., 2007. Does female board representation influence firm performance? The Danish evidence, in: *Corporate Governance: An International Review*, (2007), 15(2), 404-413.
- Sullivan, R., 2015. "Can Gender Quotas get more Women into Boardrooms?" Bloomberg, C: <http://www.bloomberg.com/news/articles/2015-07-01/can-gender-quotas-get-more-women-into-boardrooms-> (accessed 31 March 2017).
- STOXX, 2017. EURO STOXX 50. Available at: <https://www.stoxx.com/index-details?symbol=SX5E> (accessed 03 March 2017).
- Terjesen S, Couto E.B., Francisco P.M., 2015. Does the presence of independent and female directors impact firm performance? Available at: <http://www.companydirectors.com.au/~media/resources/Director-Resource-Centre/GLC/Does-the-presence-of-independent-and-female-directors-impact-firm-performance-A-multi-country-study-of-board-diversity.pdf> (accessed 31 March 2017).
- Terjesen S, Aguilera R.V., Lorenz R., 2015. Legislating a Woman's Seat on the Board: Institutional Factors Driving Gender Quotas for Boards of Directors, in: *Journal of Business Ethics*, (2015), 233-251.
- The EBTs of all the 50 Companies (EvS in German) were taken from <http://www.finanzen.net/> - date of retrieval was the 03. March 2017).

## THE POWER OF NARRATION (STORY) FOR LEARNING AND FOR LIFE: BRIDGING PAST AND FUTURE

**Bombelli, M. Cristina<sup>1</sup>; Jirkovska, Blanka<sup>2</sup>; Sawyer, Carol H.<sup>3</sup>; Wallace, Annika E.<sup>4</sup>; Walling,  
Barbara<sup>5</sup>**

<sup>1</sup>Wise Growth Consultancy; Milano, Italy

<sup>2</sup>Czech Technical University, Masaryk Institute of Advanced Studies, Prague, Czech Republic

<sup>3</sup>College of Business and Public Management, University of La Verne, and School of Information, San Jose State University, California, USA

<sup>4</sup>Franciscan University of Steubenville, Ohio, USA

<sup>5</sup>College of Business and Public Management, University of La Verne, California

### ABSTRACT

The conference session is centered on diverse uses of narration (story) for insight and understanding. Each panelist (see short biographical information) recognizes the research-based power of narration for attention to complexities O'Toole and Bennis identified in their *Harvard Business Review* article "reflecting the complex challenges business leaders face."

The proposal anticipates short (9-12 minutes) well-focused presentations from each of five panelists, with professional visual enrichment. Previous contributions by these panelists for the EMAB conferences in Verona (2015) and in Warsaw (2016) have been highly successful and engaging opportunities. Those presentations, and this one, model an integrated collaborative multi-voice approach that includes hands-on audience participation. Take-away value for participants is enhanced by the interactive design.

For the 2017 conference, the presenters have added to their preparation and the session another voice and yet another perspective, that of a current university student who has experienced a story-based approach in her studies. Narration has strengthened both her present learning and awareness of her own preferred ways of learning to carry forward into career and life. All presenters will link their sharing to the conference theme of bridging past and future.

The goal of the session being prepared for Rome, like the earlier contributions in Verona (curated examples of excellence in teaching and learning) and in Warsaw (cross-cultural skill development) is to provide a platform for thoughtful conversation during the session time as well as throughout the days of the conference. Ongoing networking post-conference is an expectation the presentations will enable.

*Keywords: teaching, consulting, learning, learning theory, narration, story, management education*

## THE POWER OF NARRATION (STORY) FOR LEARNING AND FOR LIFE: BRIDGING PAST AND FUTURE

“Narrative imagining—story—is the fundamental instrument of thought. Rational capacities depend on it. It is our chief means of looking into the future, of predicting, of planning, and of explaining . . . Most of our experience, our knowledge and our thinking, is organized as stories” (Turner in Pink, 2006, p. 101)

“The human brain has always been highly tuned towards narratives, whether factual or not, to justify ongoing actions . . . . Stories motivate and connect activities to deeply felt values and needs” (Schiller, 2017, p. 2).

**This proposal requests a 90-minute session** for the 10<sup>th</sup> Annual EuroMed Academy of Business Conference.

The five individuals who will bring this session to the conference are actively pursuing both consulting and academic careers in three nations. Their professional work is grounded in awareness of the essential nature of *learning about learning*. They are aware of the critique of both managerial practice (Hamel and others) and management development and education (Mintzberg; O’Toole and Bennis, and others). Individually and at times collectively, they have sought out ideas from a range of disciplines to enrich engagement and interaction as they coach, teach, develop and inspire a variety of others, including mid-career and senior managers and governing boards in public, private, and social organizations across economies.

The conference session will be centered on diverse uses of narration (story) for insight and understanding, drawn from research into learning and communication theory. Each panelist recognizes the power of narration to bring attention to the complexities O’Toole and Bennis identified in their *Harvard Business Review* article “reflecting the complex challenges business leaders face.” The conference presenters use narration-based approaches to help ensure “learning approaches infused with multidisciplinary, practical, and ethical questions and analyses” (2005, p. 104). Imagination (a term O’Toole and Bennis highlight) and right brain-centered designs are foundational to the ideas these presenters will bring to the conference. Bridging theory and practice, bridge-building through connecting past, present and future, acknowledging the human need for meaning conveyed through story---all these are central to the ways of working that will be shared and discussed in this session. “Stories are the easiest forms to help others understand complexity” (Crossland, 2008, p. 83).

The presenters have a richness of background and experience. They **live and work** in three different countries (Czech Republic, Italy, United States); together they have **taught** at six different universities; **studied** in multiple disciplines; **consulted** in organizations diverse in focus, sector and size;

**researched** in the fields of organizational development, leadership, management, education, public services, gender issues, sociology, health care, human resources, cross-cultural competence . . .

They themselves are of **four different generations**. Together they have more than 126 years of professional experiences.

For this conference, individually and collaboratively, **they have identified and will each share one example of best-practice use of narrative to address an individual or organizational goal.**

“The story—from Rumpelstiltskin to *War and Peace*—is one of the basic tools invented by the human mind for the purpose of understanding. There have been great societies that did not use the wheel, but there have been no societies that did not tell stories”

(Le Guin in Pink, 2006, p. 105).

This proposal anticipates short (9-12 minutes) well-focused presentations from each of these individuals, with professional visual enrichment. **Previous contributions by these panelists for the EMAB conferences in Verona (2015) and in Warsaw (2016) have been highly successful and engaging opportunities.** Those presentations modeled an integrated and collaborative multi-voice approach that expands a conference panel session to include **engaged hands-on audience participation**. Take-away value for participants is enhanced by this interactive session design.

For the 2017 conference, the presenters have added to their preparation and the session another voice and yet another perspective, that of a current university student who has experienced a story-based approach to her studies. That approach has strengthened both her present learning and her awareness of her own preferred ways of learning which she will carry forward into career and life. All five presenters will link their session sharing to the conference theme of bridging past and future.

The goal of the session being prepared for Rome, like the earlier contributions in Verona (curated examples of excellence in teaching and learning) and in Warsaw (cross-cultural skill development) is to **provide a platform for thoughtful conversation** during the session time as well as throughout the days of the conference. Ongoing networking post-conference is an expectation, an expectation the presentations will enable.

Each presenter will provide one consulting or teaching approach--a focused story-based presentation on the use of narrative. Why use narration? Why use story?

The session will share and illustrate these diverse responses to the questions:

Story connects and makes communication possible.

Story can be a vehicle for empowering women.

Story is an appropriate foundation for scholarly research through sociological narration.

Story is an effective learning entry point.

Story is a skillful means to structure curriculum design and delivery.

## INFORMATION ON PRESENTERS

*Presenter #1 – An executive coach with almost thirty years' experience in university teaching in management and human resources. She has researched and published in the field of management, including attention to generational differences, cross-cultural approaches, and gender studies. A somatic coach, she has created a diversity-focused consulting and training firm.*

*Presenter #2 – A sociologist now teaching and researching, her approach lies in linking academic knowledge with research and consulting activities in organizations. Particular interests include the ageing of population and its consequences, sociology of organizations, organizational development, working conditions and quality of life of employees, and psychosocial determinants of health.*

*Presenter #3 – Her twenty years' management experience in business, government and nonprofit organizations was followed by an award-winning teaching career characterized by attention to design thinking for strengthening graduate management education. She is passionate about the application of the arts, including literature, drama and poetry, and of learning theory in both managerial and educational settings. Her career has been characterized by frequent international work in leadership, organizational change and organizational development.*

*Presenter #4 – At the age of twenty-one, she is in her third year of university studies for a degree in nursing. She is passionate about international relief and hopes to continue to lead medical service projects around the world after graduation. An American, she lived in Europe for five years. She has traveled extensively in fourteen European nations and also in Latin America, where she contributed to a health care service project. Travel feeds her with many stories as does her love of theatre as both a performer and a director.*

*Presenter #5 – She is active in both consulting and teaching to develop individual and organization-based innovative thinking through experiential activities. She has twenty-five years' career expertise in marketing, business development and strategic planning, principally in health care and community-based organizations.*

## REFERENCES

Thoughtfully Curated Consulting and Teaching Practices; a co-authored research paper presented and published in the Conference Proceedings; Sixth Annual EuroMed Academy of Business, Verona, Italy, September 2015.

Kaleidoscope Thinking: Multiple Perspectives on the Development of Cross-Cultural Competence; a co-authored research-based presentation for the Seventh Annual EuroMed Academy of Business, Warsaw, Poland, September 2016

Apker, J. (2012), *Communication in health organizations*, Polity Press, Malden, Massachusetts.

Bennis, W. G. (1996), "The leader as storyteller". *Harvard Business Review* (Jan-Feb): p. 157. <https://hbr.org/1996/01/the-leader-as-storyteller>

Bolman, L. and T. Deal. (2001), *Leading with soul. An uncommon journey of spirit*, Jossey-Bass Publishers, San Francisco, CA.

Bombelli, M. C. (2009), *Alice in business land: On becoming a woman leader*, available in both Italian and English as a kindle e-book.

Crossland, R. (2008), *The leader's voice: How your communication can inspire action and get results!* 2nd ed. SelectBooks, Inc. New York, NY.

Denning, S. (2005), *The leader's guide to storytelling: Mastering the art and discipline of business narrative*, Jossey-Bass, San Francisco, CA.

Denning, S. (2011), "Why Leadership Storytelling is Important", *Forbes*. Jun 8, 2011. Retrieved from <https://www.forbes.com/sites/stevedenning/2011/06/08/why-leadership-storytelling-is-important/#4be65edf780f>

Gardner, H. (2006), *Changing minds; the art and science of changing our own and other people's minds*. Harvard Business Review Press, Massachusetts.

Gardner, H. (1999), *Intelligence reframed; Multiple intelligences for the 21st century*, Basic Books, New York, NY.

Gardner, H. with E. Laskin. (1995), *Leading minds. An anatomy of Leadership*, Basic Books, New York, NY.

Hamel, G. (2012), *What matters now*, Jossey-Bass, San Francisco.

Mintzberg, H. (2004), *Managers not MBAs; A hard look at the soft practice of managing and management development*, Berrett-Koehler Publishers, Inc. San Francisco, CA.

O'Toole, J. and Bennis, W. G. (2005), "How Business Schools Lost Their Way", *Harvard Business Review*, Vol. 83 No. 5, pp. 96-104.

Pearce, T. (2013), *Leading out loud: A guide for engaging others in creating the future*, Jossey-Bass, San Francisco, CA.

Pink, D. H. (2005), *A whole new mind. Why right-brainers will rule the Future*, Riverhead Books, New York, NY.

Sandberg, S. (2013), *Lean in; Women, work and the will to lead*, Knopf, New York.

Sawyer, C. H. (2007), *Reality Surprised--One Novel Used in An Approach to Leadership Development*, paper shared at the conference *The Novel and Organisation*, University of Essex.

Schiller, R. J. (2017), *Narrative Economics*. Cowles Foundation Discussion Paper # 2069. <http://cowles.yale.edu/sites/default/files/files/pub/d20/d2069.pdf>

Turner, M. (1996), *The literary mind: The origins of thought and language*, Oxford University Press, New York.

Vaill, P.B. (1996), *Learning as a way of being; Strategies for survival in a world of permanent white water*, Jossey-Bass Publishers, San Francisco, CA.

Wheatley, M. J. (2007), *Finding our way: Leadership for an uncertain time*, Berrett-Koehler Publishers, Inc. San Francisco, CA.

Yolen, J. (2006), *Take joy. A writer's guide to loving the craft*, *Writer's Digest Books*, Cincinnati, OH.

## REDUCING COSTS OR INCREASING MARKETING: STRATEGIC SUGGESTIONS FOR TOURISM FIRMS IN CRISIS SITUATIONS

Bremser, Kerstin<sup>1</sup>; Alonso-Almeida, María del Mar<sup>2</sup>; Llach, Josep<sup>3</sup>

<sup>1</sup>Faculty of Business & Law, Pforzheim University of Applied Sciences, Pforzheim, Germany

<sup>2</sup>Faculty of Economics and Business Administration, Autónoma University, Madrid, Spain

<sup>3</sup>Business Organization Department, Escuela Politécnica Superior, Girona, Spain

### ABSTRACT

This research tests if the application of proactive measurements during crisis times is best mediated by cost reductions or increased marketing efforts. The research was conducted in 2013 (the fifth consecutive year of falling GDP after the 2008 economic crisis) through a structured questionnaire addressed to owners / managers of Spanish hotels and restaurants in the city of Madrid. Whereas proactive measures undertaken by the hotels and restaurants had a direct and positive impact on income generated, increased marketing measures only partially mediated this result. Cost reductions on the other hand did not show a similar effect. The conclusion highlights that it is recommended for managers and operators for tourism companies to focus on proactive measurements instead of cost reductions in crisis times. Given that the research was undertaken in the capital city of Spain, results may not be applicable to touristic destinations in non-metropolitan areas.

*Keywords: Spain, Crisis, Tourism, Hotel, Restaurant, Proactive Strategies, Crisis Management*

### INTRODUCTION

Recent economic data show that Spain finally has come out of an economic recession that lasted for five consecutive years, from 2009 – 2013 with falling GDP year after year (World Bank). For Spanish companies, 2013 presented the worst crisis year with the numbers of companies declaring bankruptcy reaching an all-time high of 8,724 failing companies, mainly from the construction and services sector (PWC, 2016). Tourism companies that were active in 2013 had until then gone through a series of severe adaption processes in order to survive. Therefore, this research gives insights from these companies that can enable hotels and restaurants from other touristic destinations to improve their own crisis management and to benefit from the lessons learned. Several important touristic destinations are currently facing critical situations, either because of terrorist attacks (i.e. Turkey) or economic problems (i. e. Greece). Additionally, academia will benefit from this research. Previous research has shown that proactive strategies are more effective in crisis situations for the tourism industry than reactive

strategies (Alonso-Almeida and Bremser, 2013, Alonso-Almeida *et al.*, 2015). With this analysis, the authors analyze which actions can actually mediate the effect of proactive strategies.

## LITERATURE REVIEW

### *Strategy development in crisis times*

There is a large body of research elaborating about the success of different strategies in crisis times focusing on the tourism industry. A general understanding exists, that proactive strategies are more effective than reactive ones (Huhtala *et al.*, 2014, Okumus and Karamustafa, 2005, Okumus and Karamustafa, 2005 among others). Proactive strategies are defined as strategies centering on innovations capabilities, marketing, new product development as well as new product introduction (Brzozowski and Cucculelli, 2016, Alonso-Almeida *et al.*, 2015, Ewah, 2013). These strategies are important in order to stay at the forefront of the market and attract customers.

In crisis times, the relation between proactive strategy and performance is debatable. Whereas some research shows, that reactive (cost reduction) and proactive (marketing oriented) strategies show equal results (Köseoglu *et al.*, 2013), most researchers analyzing the period after 2008 point to the success of proactive strategies (Ngo and O'Cass, 2012, Hilmola *et al.*, 2015, Ramos Conti *et al.*, 2015, Simon-Elorz *et al.*, 2015 among others) for different industries and countries. Therefore, we postulate the following hypothesis:

H1: There is a direct and positive relationship between proactive activities and revenues

Performance in this case is measured as total revenues. Compared to other performance measurements commonly employed (EBIT, ROI, Net income, ...) it has the advantage that these numbers are well known by the interviewed persons and also available for small businesses that are below the thresholds for publishing detailed financial statements. Especially in the Spanish restaurant business, many smaller establishments prevail. Most Spanish businesses in the hotel and restaurant sector are either owner-managed with no employees or below a threshold of five employees (FEHR, 2013).

The question now remains, if cost cutting or increased marketing efforts can mediate the success of proactive strategies. In their cover story for Harvard Business Review Gulati *et al.* (2010) conclude that selective cost-cutting with a focus on operational efficiency instead of employee reduction increases the likelihood of post-crisis success. Severe cost cutting will destroy a firm's productive base and inhibit post-crisis recovery. Su and Tang (2016) point out in a recent article after the economic crisis that cost-cutting and product-innovation show similar results with respect to performance, however, fewer firms apply cost-cuttings. These are mostly younger and smaller ones. If cost-cutting is applied, those companies will later on switch to product innovation. Askenazy *et al.* (2013) add that salary reductions flexibilise a firm's cost base and thus allow companies to come out stronger after a crisis. Cowling *et al.*



(2014) suggests that cost-cutting is the most frequently used strategy in crisis times and allows firms to survive a crisis in order to switch to growth-related strategies afterwards. These articles point to a relation between cost-cutting and innovation or growth strategies. Therefore, the authors postulate:

H2: Cost-cutting (COST) positively mediates the relationship between proactive activities and revenues.

On the other hand, Gulati *et al.* (2010) also point to the evidence of many different crisis times where increased marketing efforts helped firms to come out of a crisis. A research undertaken by Rollins *et al.* (2014) shows for the US that during the economic crisis of 2008 most companies did cut their marketing spending. However, those companies that actually increased marketing activities in order to overcome the crisis ended up to be more successful. Here, a redirection of marketing spending is visible towards e-marketing in order to attract different customer segments. Earlier Srinivasan *et al.* (2005) as well as Pearce and Michael (2006) had already pointed out the importance of marketing in recession times. Especially Srinivasan *et al.* (2005) characterizes proactive strategies that enable firms with a strong marketing advantage before the crisis to build on it and increase their competitive advantage. Therefore, it is postulated:

H3: Marketing efforts (MARKETING) positively mediates the relationship between proactive activities and revenues.

The remainder of the paper is structured as followed. The next section presents the methodology employed; subsequently results are presented and discussed. The last section concludes the research, pointing out some limitations as well as recommendations for research and practice.

## DATA AND MEASUREMENTS

### *Sample and method*

Data was collected through face to face interviews with working at restaurants or hotels in the city of Madrid. Table 1 presents the descriptive analysis of the sample (n=339). Mainly, it is composed by hotels (n=178) and restaurants (n=155). Only six responses come from other typology of establishments, which are hostels or bars.

The hospitality industry was selected because of its importance in terms of national GDP. Among the Spanish regions, the capital of Madrid has the highest GDP per capita, and tourism comprises a significant portion of the local labour market (Alonso-Almeida and Bremser, 2013). According to the national federation of the hospitality industry in Spain (FEHR), in 2011 the hospitality sector represented more than 7.2% of the national GDP (FEHR, 2011).

As can be seen in Table 1, more than 85% of the hotels are over 5 years old. On the other hand, the restaurants are equally balanced among different range of ages. However, similar to the hotels, they are mainly over five years old.

	N	%	Hotel	%	Restaurant	%	Others	%
0-2 years	26	7.65	5	2.81	21	13.55	0	0
>2-5 years	57	16.76	21	11.80	36	23.23	0	0
>5-10 years	79	23.24	53	29.78	25	16.13	1	16.67
>10-20 years	75	22.06	43	24.16	31	20.00	1	16.67
>20 years	102	30.29	56	31.46	42	27.10	4	66.66
Total	339	100%	178	100%	155	100%	6	100%

Table 1. Descriptive analysis of the sample by age and typology

The questionnaire was structured in three parts and focused on the period of 2011 – 2012. The first part of the questionnaire included two questions about how the establishment had been affected by a set of impacts and how these impacts have modified the expenditure per client, the price and cost per employee. The second part of the questionnaire included one extensive question about the measure deployed by the establishment to counter the financial crisis. Finally, the last section of the questionnaire collected financial data about the evolution of the establishment during the analysed period.

Precisely, Table 2 presents this data by typology of establishment. We can observe that in both cases the main option selected was a decrease between 1-25 %. Only 47 establishments (13.91%) of the sample declared having an increase of income during the analysed period. According to FEHR (2013), in the last years every year more establishments have stopped their activity within the hospitality industry, reaching the peak of closures in 2013 with more than 45.000.

	N	%	Hotel	%	Restaurant	%	Others	%
decreased >50%	22	6.51	12	6.86	10	6.37	0	0
decreased 26-50%	51	15.09	23	13.14	28	17.83	0	0
decreased 1-25%	138	40.83	73	41.71	60	38.22	5	83.33
Maintained	80	23.67	36	20.57	43	27.39	1	16.66
Increased	47	13.91	31	17.71	16	10.19	0	0
Total	338	100%	175	100%	157	100%	6	100%

Table 2. Descriptive analysis of the sample by income and establishment type

### Measures and Analysis

Based on the above review of the literature several factors were explored in light of testing the stated hypotheses. The respondents were asked to indicate, based on a 5-point Likert scale, their opinions about the different statements. For measuring the earning dimension the ordinal measure, based also on a 5-point Likert scale, presented in Table 2 was used.

The hypotheses were tested using a Partial Least Squares (PLS) approach to SEM (Chin, 1998), using the SmartPLS 2.0 software (Ringle et al., 2005).

The PLS approach's underlying mathematical algorithm makes it suitable for this research, which is characterised by a non-normal distribution. This suitability is attributed to the iterative PLS algorithm (Henseler et al., 2009), which transforms non-normal data in accord with the central limit theorem (Hair et al., 2012). The PLS results are thus robust when using skewed data (Wilden et al., 2013). PLS is referred to as a 'soft modelling' technique because it does not require that restrictive assumptions be made regarding measurement (Sosik et al., 2009); data normality (Fornell & Larcker, 1981) or known distribution (Falk & Miller, 1992); or sample size (Reinartz et al., 2009), unlike other methods. Consequently, we employed PLS because of its overall suitability to our modelling requirements.

CONSTRUCT/indicator	N	Mean	SD
<b>MEASURES1</b>			
<b>Proactive (PRO)</b>			
Employee ideas leading to cost reduction or sales increases receive a prize	337	2.706	1.605
Employee empowerment – Employees are encouraged to solve client demands without contacting their supervisors	335	2.979	1.548
Specific anticrisis methods have been introduced	343	3.282	1.476
An anticrisis plan has been developed	329	2.993	1.473
<b>IMPACTS2</b>			
<b>Cost (COS)</b>			
Employee dismissals/layoffs	343	2.291	1.435
Reduction of direct client services	348	2.146	1.307
Elimination of back-office services	288	2.003	1.305
Incremento de la subcontratación	314	2.321	1.489
<b>Marketing(MKT)</b>			
Company is opening in new international markets	336	2.369	1.545
Company is opening in new market segments	335	2.871	1.558
<b>INCOME3</b>			
Development of income during the last years (2011)?	340	3.229	1.072

<sup>1</sup> In a 5-point Likert scale (1: no use of; 5: totally use)

<sup>2</sup> In a 5-point Likert scale (1: no impact; 5: high impact)

<sup>3</sup> In a 5-point Likert scale (1: decrease more 50%; 2: decrease between 26%-50%; 3: decrease 1%-25%; 4: remain stable;5:increase over 2010)

Table 3. Operationalization of the items

## RESULTS

The results section is structured into two parts that follow the analysis process. First, the measurements and the structural model were assessed. Second, an analytical approach was applied to test the mediation hypotheses. In addition, we assessed the variance accounted for (VAF) to ascertain whether the mediating effect, in each case, is either full or partial. The operationalisation of the items is presented in Table 3 (sample size, mean and standard deviation).

CONSTRUCT / INDICATOR	ITEM RELIABILITY	SIGNIFICANCE (bootstrapping)	CONVERGENT VALIDITY	CONSTRUCT RELIABILITY	
	Loading	t-value	AVE	Composite reliability	Alpha Cronbach
Proactive			0.540	0.819	0.720
Employee ideas leading to cost reduction or sales increases receive a prize	0.584	5.286			
Employee empowerment – Employees are encouraged to solve client demands without contacting their supervisors	0.594	5.575			
Specific anticrisis methods have been introduced	0.862	16.597			
An anticrisis plan has been developed	0.850	17.922			
Cost			0.510	0.805	0.678
Employee dismissals/layoffs	0.734	16.225			
Reduction of direct client services	0.709	16.046			
Elimination of back-office services	0.777	25.851			
Increased outsourcing	0.627	11.817			
Marketing			0.780	0.876	0.718
Company is opening in new international markets	0.876	24.908			
Company is opening in new market segments	0.890	26.423			

*Note: AVE=Average Variance Extracted*

*Table 4. Validation of the measurement model: convergent validity and reliability*

### *Research model assessment*

#### *Assessment of the measurement model*

Because all first-order latent variables are reflective, they were assessed with reference to the reliability and validity attributes of the item scales used. First, individual item reliability was proven to be optimal for most of the measurements because the item standardised loadings were equal to at least 0.707 (Carmines & Zeller, 1979). The items under the suggested optimal threshold were extracted to optimise the model; nine items were dropped. Table 4 shows only those items that passed.

Second, internal consistency reliability was examined through composite reliability (Werts et al., 1974), which fulfils the same task as Cronbach's alpha (Furrer et al., 2012). However, composite reliability is more suitable for PLS because it does not assume that each indicator makes an equal contribution to the

construct (Chin, 1998). All of the latent constructs exceeded the benchmark of 0.7, as suggested by Nunnally (1978) for exploratory research, which confers reliability to the measures (Table 4).

Third, convergent validity demonstrates the unidimensionality of our constructs. The variance in the indicators accounted for this unidimensionality in terms of variance extracted (AVE) and exceeded the 0.5 threshold (Fornell & Larcker, 1981), ensuring that each set of indicators represents the same underlying construct (Henseler et al., 2009) (Table 4).

Finally, discriminant validity, which verifies that each factor represents a separate dimension, was analysed using linear correlations or standardised covariances between first-order factors that examined whether the inter-factor correlations were less than the square root of the average variance extracted (AVE) (Fornell & Larcker, 1981) (Table 5).

PRO	0.734		
COS	0.152	0.714	
MKT	0.218	0.179	0.883

**Note:** Diagonal represents the square root of average variance extracted. The correlations are represented below the diagonal.

Table 5. Validation of the measurement model: discriminant validity

#### Assessment of the structural model

Structural model evaluation in PLS relies on the measures that indicate the model's predictive power (Tenenhaus et al., 2005). The central criterion in this respect is the coefficient of determination ( $R^2$ ). Table 6 shows that the  $R^2$  values for the three endogenous variables in the model well exceeded the minimum value of 0.1 recommended by Falk & Miller (1992).

Additionally, the Stone-Geisser  $Q^2$  statistic (Geisser, 1974) was greater than zero for the four constructs, suggesting that the model has predictive relevance.

Dimensions/ Hypotheses	Path coefficient	Bootstrapping	
		Standard error	t-value
Cost ( $Q^2= 0.012$ )			
Proactive (H2a)	0.180	0.112	1.606
Marketing ( $Q^2= 0.037$ )			
Proactive (H3a)	0.226	0.056	4.027***
Income ( $Q^2= 0.037$ )			
Proactive (H1)	0.087	0.070	1.228
Cost (H2b)	-0.180	0.079	2.275**
Marketing (H3b)	0.175	0.056	3.122**

**Note:** \*\*\* $p$ -value < 0.01 (2.58); \*\* $p$ -value < 0.05 (1.96); \* $p$ -value < 0.1

Table 6. Structural model assessment

Once the model has been assessed and validated, the analysis is extended to examine the mediating effect of both internal processes along the customer perspective in the model.

### *Mediating effects*

The mediation hypotheses (H2 and H3) were tested based on the analytical approach described by Castro and Roldán, 2013 and Picón *et al.*, 2014. Figure 1A shows the total effect (c) of proactive activities on income. Fig. 1B.1 expresses the total effect of proactive activities on income as the sum of the direct (c1) and indirect effect ( $a1*b1$ ) due to the mediation effect of cost. Finally, Fig. 1B.2 shows the total effect as the sum of the direct effect (c2) and the indirect effect caused through marketing ( $d2*e2$ ).

#### *A. Model with total effect*

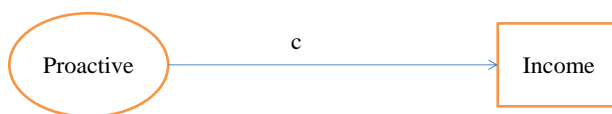

#### *B.1. Model with a COST mediated effect*

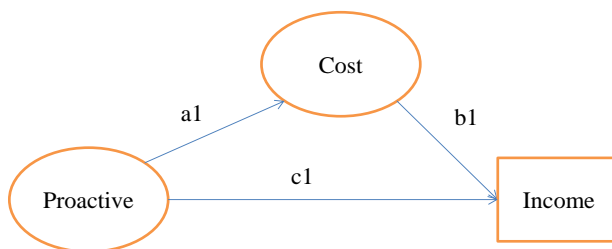

#### *B.2. Model with a MKT mediated effect*

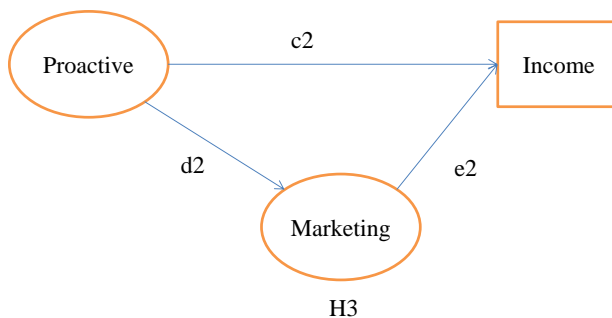
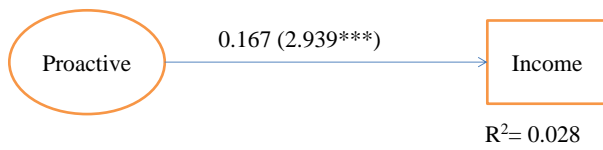

Figure 1. Mediation model

The application of bootstrapping allows for the testing of the mediation hypotheses (Preacher and Hayes, 2008). In the analysis, 5,000 resamples were generated to provide 95% confidence intervals (percentile) for the mediators. As shown in Figure 2A and Table 7, proactive activities has a significant total effect on income ( $c = 0.167$ ;  $t$ -value = 2.939). When adding the mediator effect of costs (Fig. 2B), proactive activities decreases its influence and maintains no significant direct effect on income (H1:  $c1 = 0.086$ ;  $t = 0.840$ ) and there is significance relevance in the chain proactive – costs – income. On the other hand, when the mediation effect is produced by marketing, the influence of proactive activities on

income also decreases ( $c_2=0.097$ ;  $t$ -value= 1.400) but there is significance relevance in the chain proactive activities – marketing – income. Therefore, these results reject H2 but supports H3.

**A. Model with total effect**



**B.1. Model with a COST mediated effect**

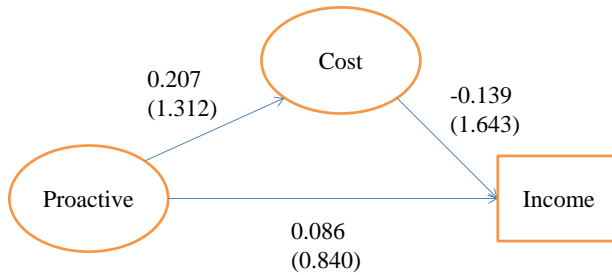

**B.2. Model with a MKT mediated effect**

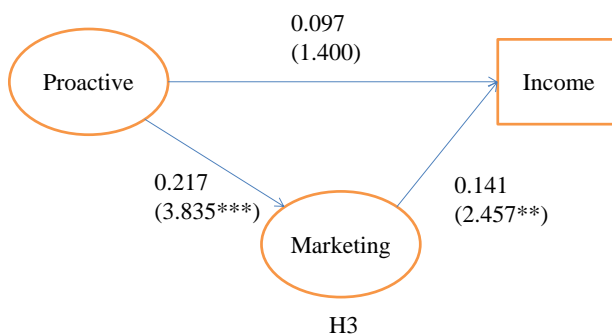

Figure 2. Structural model: Mediation

In addition, in Table 7, the value of variance accounted for (VAF) indicates the relative size of the mediating effect when it is significant (H3). Different authors (among others Shrout and Bolger, 2002; Hair et al., 2014) pointed out that VAF is a good criteria: no mediation (< 20%), the partial mediation (from 20% to 80%) and full mediation (>80%). Hair et al. (2013) showed that the VAF determined the size of the indirect effect in relation to the total effect, and was explained how much of the target construct’s variance was explained by the indirect relationship via the mediator variable. According with VAF value of H3 (VAF=23%) marketing partially mediates the effect of proactive activities on income.

Mediator	Total effect	Direct effect	Indirect effect	Mediated VAF
----------	--------------	---------------	-----------------	--------------

	Proactive → Income		Proactive → Income		Proactive → Income		effect				
	Coefficient	t-value	Coeff.	t-value	Point estimate	Percentile bootstrap		Lower	Upper		
						95% confid. interval					
COST	0.167***	2.939	c1	0.086	0.840	a1*b1	-0.028	-0.068	0.034	NO	-
MKT	0.167***	2.939	c2	0.097	1.400	d2*e2	0.030	0.004	0.063	Partial	23%

*Note: significant at \*\*\*p-value < 0.01 (2.58); \*\*p-value < 0.05 (1.96); \*p-value < 0.1 (1.69)*

VAF>0.80 full mediation, 0.20 ≤ VAF ≤ 0.80 partial mediation, VAF < 0.20 no mediation

Table 7. Mediating effect of COST and MKT between Proactive and Income

## CONCLUSION

The results found are in line with existing research. It has been shown, that proactive strategies have a direct impact upon performance, measured in this case as income. Interesting to look at, are the mediating effect. Marketing activities partially mediate the effect on income whereas costs do not. That marketing activities show a partial mediation is not surprising since they draw on the newly empowered employees and benefit from anti-crisis plans and measures that streamline marketing efforts into promising market segments or international markets. For practitioners this implies that measures strengthening employee empowerment should go hand in hand with other activities that rely on empowered employees. Thus, the newly empowered will be motivated to pursue the firm's strategy.

Cost-cutting effects show no mediation on income. This could also be expected. Cost-Cutting focusing on outsourcing and dismissals or layoffs have a negative influence on employee motivation and therefore are therefore contrary and difficult to communicate measurements if the company on the other hand also wants to increase employee empowerment. Care should be taken from the part of practitioners not to decide for the easiest measures in times of crisis (cost savings are often considered to be easy and ready at hand) but instead to carefully find a balance between the different necessary actions undertaken.

Researchers can base future research on these findings. It would be interesting also to see moderator effects of cost or marketing activities. Caution has to be taken when applying the research to other industries or destinations. Since the sample was small and covered only one region, results are not easily transferable to other cities, countries or regions.

## REFERENCES



- Alonso-Almeida, M.d.M. and Bremser, K. (2013), "Strategic responses of the Spanish hospitality sector to the financial crisis", *International Journal of Hospitality Management*, Vol. 32 No. March, pp. 141–148.
- Alonso-Almeida, María del Mar, Bremser, K. and Llach, J. (2015), "Proactive and reactive strategies deployed by restaurants in times of crisis", *International Journal of Contemporary Hospitality Management*, Vol. 27 No. 7, pp. 1641–1661.
- Askenazy, P., Bozio, A. and García-Peñalosa, C. (2013), "Dynamique des salaires par temps de crise", *Notes du conseil d'analyse économique*, Vol. 5 No. 5, p. 1.
- Brzozowski, J. and Cucculelli, M. (2016), "Proactive and Reactive Attitude to Crisis: Evidence from European Firms", *Entrepreneurial Business & Economics Review*, Vol. 4 No. 1, pp. 181–191.
- Carmines, E. G., Zeller, R. A. (1979), "Reliability and Validity Assessment", Sage Publications, London, New Delhi,
- Castro, I. and Roldán, J.L. (2013), "A mediation model between dimensions of social capital", *International Business Review*, Vol. 22 No. 6, pp. 1034–1050.
- Chin W (1998), The partial least squares approach to structural equation modelling. In: Marcoulides GA (ed) *Modern methods for business research*. Lawrence Erlbaum, Mahwah NJ, pp 295-336.
- Cowling, M., Liu, W., Ledger, A. and Zhang, N. (2014), "What really happens to small and medium-sized enterprises in a global economic recession? UK evidence on sales and job dynamics", *International Small Business Journal*, Vol. 33 No. 5, pp. 488–513.
- Ewah, S.O.E. (2013), "Marketing research as a proactive strategy for the performance of business: The Nigerian experience", *International Journal of Business & Economic Development*, Vol. 1 No. 3, pp. 108–122.
- Falk, R. F., Miller, N. B. (1992), "A primer for soft modeling", University of Akron Press, Ohio
- FEHR (2011), *Los sectores de la hostelería 2011*. Federación Española de Hostelería, Madrid (Spain). Retrieved from: <http://www.fehr.es/documentos/publicaciones/descargas/des-70.pdf>
- FEHR (2013), *Los sectores de la hostelería 2013*, Federación Española de Hostelería, Madrid (Spain). Retrieved from: <http://www.fehr.es/libreria/detalle-publicaciones.php?publicacionesID=120>
- Fornell, C., Larcker, D. F. (1981), "Evaluating structural equation models with unobservable variables and measurement error", *Journal of Marketing Research*, Vol. 18 No. 1, pp. 39-50.
- Furrer, O., Tjemkes, B., Henseler, J. (2012), "A model of response strategies in strategic alliances: a PLS analysis of a circumplex structure", *Long Range Planning* Vol. 45, pp. 424-450.
- Geisser, S. (1974), "A predictive approach to the random effect model", *Biometrika* Vol. 61, No. 1, pp. 101-107.
- Gulati, R., Nohria, N. and Wohlgezogen, F. (2010), "Roaring Out of Recession. (cover story)", *Harvard Business Review*, Vol. 88 No. 3, pp. 62–69.
- Hair, J. F., Ringle, C. M., Sarstedt, M. (2013), "Editorial: Partial Least Squares Structural Equation Modeling: Rigorous applications, better results and higher acceptance", *Long Range Planning*, Vol. 46, No. 1-2, pp. 1-12.
- Hair, J. F., Sarstedt, M., Hopkins, L. and Kuppelwieser, V. G. (2014), "Partial least squares structural equation modeling (PLS-SEM): An emerging tool in business research", *European Business Review*, Vol. 26 No. 2, pp. 106–121.
- Hair, J. F., Sarstedt, M., Pieper, T.M. and Ringle, C.M. (2012), "The Use of Partial Least Squares Structural Equation Modeling in Strategic Management Research: A Review of Past Practices and Recommendations for Future Applications", *Analytical approaches to strategic management: Partial Least Squares modeling in strategy research*, Vol. 45 No. 5–6, pp. 320–340.
- Henseler, J., Ringle, C., Sinkovics, R. (2009), "The use of partial least squares path modeling in international marketing". In: Sinkovics R, Ghauri P (eds), *Advances in International Marketing*, Elsevier, Oxford, pp 277-319
- Hilmola, O.-P., Lorentz, H., Hilletoft, P. and Malmsten, J. (2015), "Manufacturing strategy in SMEs and its performance implications", *Industrial Management & Data Systems*, Vol. 115 No. 6, pp. 1004–1021.
- Huhtala, J.-P., Sihvonen, A., Frösén, J., Jaakkola, M. and Tikkanen, H. (2014), "Market orientation, innovation capability and business performance", *Baltic Journal of Management*, Vol. 9 No. 2, pp. 134–152.
- Köseoglu, M.A., Topaloglu, C., Parnell, J.A. and Lester, D.L. (2013), "Linkages among business strategy, uncertainty and performance in the hospitality industry: Evidence from an emerging economy", *International Journal of Hospitality Management*, Vol. 34 No. 0, pp. 81–91.
- Ngo, L.V. and O'Cass, A. (2012), "Performance implications of market orientation, marketing resources, and marketing capabilities", *Journal of Marketing Management*, Vol. 28 No. 1/2, pp. 173–187.
- Nunnally, J. (1978), "Psychometric Methods", McGraw-Hill, New York.
- Okumus, F. and Karamustafa, K. (2005), "Impact of an economic crisis. Evidence from Turkey", *Annals of Tourism Research*, Vol. 32 No. 4, pp. 942–961.
- Pearce, J.A. and Michael, S.C. (2006), "Strategies to prevent economic recessions from causing business failure", *Business Horizons*, Vol. 49, pp. 201–209.

- Picón, A., Castro, I. and Roldán, J.L. (2014), "The relationship between satisfaction and loyalty: A mediator analysis", *Journal of Business Research*, Vol. 67 No. 5, pp. 746–751.
- Preacher, K.J. and Hayes, A.F. (2008), "Asymptotic and resampling strategies for assessing and comparing indirect effects in multiple mediator models", *Behavior Research Methods*, Vol. 40 No. 3, pp. 879–891.
- PWC (2016), *El número de concursos de empresas se sitúa en niveles del inicio de la crisis: Baremo Concursal 2016*, Spanien.
- Ramos Conti, C., Goldszmidt, R. And Carvalho de Vasoncelos, F. (2015), "Strategies for superior performance in recessions: por or counter-cyclical?", *RAE: Revista de Administração de Empresas*, Vol. 55 No. 3, pp. 273–289.
- Reinartz, W., Haenlein, M. and Henseler, J. (2009), "An empirical comparison of the efficacy of covariance-based and variance-based SEM", *International Journal of Research in Marketing*, Vol. 26 No. 4, pp. 332–344.
- Rollins, M., Nickell, D. and Ennis, J. (2014), "The impact of economic downturns on marketing", *Advancing Research Methods in Marketing*, Vol. 67 No. 1, pp. 2727–2731.
- Shrout, P. E., Bolger, N. (2002), "Mediation in experimental and non-experimental studies: new procedures and recommendations", *Psychological Methods*, Vol. 7, No. 4, pp. 422–445.
- Simon-Elorz, K., Castillo-Valero, J.S. and Garcia-Cortijo, M.C. (2015), "Economic Performance and the Crisis: Strategies Adopted by the Wineries of Castilla-La Mancha (Spain)", *Agribusiness*, Vol. 31 No. 1, pp. 107–131.
- Sosik, J.J., Kahai, S.S. and Piovosio, M.J. (2009), "Silver Bullet or Voodoo Statistics?", *Group & Organization Management*, Vol. 34 No. 1, pp. 5–36.
- Srinivasan, R., Rangaswamy, A. and Lilien, G.L. (2005), "Turning adversity into advantage. Does proactive marketing during a recession pay off?", *International Journal of Research in Marketing*, Vol. 22 No. 2, pp. 109–125.
- Su, Z. and Tang, J. (2016), "Product innovation, cost-cutting and firm economic performance in the post-crisis context: Canadian micro evidence", *Journal of Centrum Cathedra*, Vol. 9 No. 1, pp. 4–26.
- Tenenhaus, M., Vinzi, V. E., Chatelin, Y.-M., Lauro, C. (2005), "PLS path modeling", *Computational Statistics and Data Analysis*, Vol. 48, No. 1, pp. 159–205.
- Werts, C. E., Linn, R. L., Jöreskog, K. G. (1974), "Intraclass reliability estimates: testing structural assumptions". *Educational and Psychological Measurement*, Vol. 34 No. 1, pp. 25–33.
- Wilden, R., Gudergan, S.P., Nielsen, B.B. and Lings, I. (2013), "Dynamic Capabilities and Performance: Strategy, Structure and Environment", *PLS applications in strategic management: Partial Least Squares modeling in strategy research*, Vol. 46 No. 1–2, pp. 72–96.
- World Bank (2017), *Crecimiento del PIB (% anual)*, retrieved from: <http://datos.bancomundial.org/indicador/NY.GDP.MKTP.KD.ZG?end=2015&locations=ES&start=2006> (accessed 7 March 2017).

## FEATURES AND BUSINESS OPPORTUNITIES OF PIEDMONT AGRITOURISMS

**Broccardo, Laura; Culasso, Francesca; Giacosa, Elisa; Truant, Elisa**

Dept. of Management, University of Turin, Italy

### ABSTRACT

Agritourism has considerably achieved a greater importance in the last decade, underling a continuous growing, also for the Italian economy, with an annual rate greater than 4%.

Despite this relevance, the definition is not everywhere aligned, depending on the geographic areas in which agritourisms are located. The research focuses on agritourisms of Piedmont region, one of the North Italian regions characterized by a significant concentration of agritourism farms, providing accommodation, food and agricultural experiences.

The research, conducted by an empirical analysis, aims to analyze the state of the art of agritourism management depicting the main features of agritourims, with a particular emphasis on type of services offered, dimensional features, type of customers, type of manages that run such business, key financial data.

Final results show that the agritourism analyzed can be classified within the Phillip et al. (2010) framework as Working Farm, Indirect Contact (WFIC). The work shares understanding of agritourism key features as a starting point to continue the scientific and educational development of this business.

*Keywords: Italian agritourism, hospitality model, management features, new opportunities.*

### INTRODUCTION

In Italy, the phenomenon of agritourism began to spread in the mid-60s and there were first attempts to regulate the sector in the '80s with the Law 730/1985, later repealed by Law 96/2006. The Law 96/2006 specifies the definition and establishes characteristics of agritourisms. In particular, an agritourism is the activity done by a farmer when offers tourists, in the own funds, food and accommodation, using their products and sometimes organizing recreational and cultural activities. This definition explicitly requires that farmers cultivate lands, make forestry or farm animals, since agritourisms are ancillary to agriculture and complementary to traditional production. Indeed, the Law 96/2006 aims to support agriculture through the promotion of appropriate forms of tourism in the countryside, through which protecting, qualifying and enhancing the specific resources of each territory and promoting the

maintenance of human activities in rural areas, with a differentiation of farm incomes and the promotion of rural culture and food education.

Each Italian Region also approves specific regulations with the aim of governing the creation and the management of these structures. For example, the Piedmont Regional Law 2/2015 regulates the agritourism activities in this local territory.

Italian and Regional Laws then assign an important task to farms, since they should be able to convey to the tourists everything that characterizes a territory: culture, history, traditions, landscape, environment, food and wine, cuisine. However, they should also transmit the rural values such as the respect for nature, the hospitality, the love of the countryside, the pleasure of consuming healthy and genuine products of the territory, the cycle of time and the seasonality.

Basing on this evidence the main purpose of this research is to investigate the features of agritourism in Piedmont, a relevant region in Italy for agritourism business.

An overview of the main literature on agritourism is presented in the next section, and then the methodology design including the research questions is described, followed by findings, discussion and conclusion of the work.

## LITERATURE REVIEW

The agribusiness sector is one of the most representative economic activity in terms of employment and companies revenues in Italy. For instance, in Piedmont area on 2010 (Istat - VI agricultural Census data) there were 67.148 agribusiness firms (4,1% of the Italian firms in the sector) with 1.010.780 ha of UAA (Utilised Agricultural Area). This extension - near to 8% of Italian agricultural surface – is also due to an increasing number of fusions producing a larger average size of the firms (15,14 ha per firm in Piedmont against 7,96 ha per firm in Italy).

The agribusiness context is composed by several segments such as food and wine, which are the most representative economic activities in many countries in terms of employment and companies revenues (Bigliardi and Galati, 2013; Giacosa et al., 2014a; Menrad, 2004; Vrontis et al., 2016).

Agribusiness is mainly characterized by micro, small and medium enterprises, which are frequently rooted in the territory in which they are located. In this context, the agribusiness represents a set of values, symbols, and traditions (Giacosa et al., 2014b). In addition, family firms are common in this context, due to both the tradition of some long-standing family companies across generations and the entrepreneurship of producers (Contò and Lopez, 2008). However, due to limited financial resources and a consolidated mind of set, these enterprises tend to be closed to the internationalization process (e.g. they do not sell their products abroad), thus reducing their business opportunities.

In agribusiness sector, agritourism represents a significant subset.

Agritourism definition and typologies are not everywhere valid and universal, since they usually depend on the geographic areas in which they are located (Gil Arroyo et al., 2013), considering both the natural, economic and socio-demographic characteristics of a Country, but also the different influence that is associated with the presence or the lack of legal framework and policies correlated with the business model of agritourism. In U.S., for example, there is a lack of laws through which regulate the development and the marketing of these kinds of business activities (Carpio et al., 2008; McGehee, 2007), while in Europe agritourism definitions are legally formulated and correlated to particular incentives and/or subsidies (Hegarty and Przeborska, 2005; Kizos and Iosifides, 2007; Sonnino, 2004).

The lack of an unambiguous definition around the world and the presence of cognitive differences about the meaning and features of agritourisms create many problems especially in the academic literature. Indeed, the absence of a unique definition does not favour the development of a homogeneous field of studies on the sector and does not promote the dissemination of specific research in the field (Phillip et al., 2010).

In particular, the inconsistencies in defining agritourisms in literature are correlated to four particular issues (Gil Arroyo et al., 2013).

The first one refers to the identification of an appropriate setting that usually includes farms, but sometimes also ranches, nurseries and other off-farms facilities (the EU defines the term "farm" as an agricultural holding under a unique management that consists of both agricultural production and of non-agricultural activities).

Another issue is the typology of experience done by customers in an agritourism, debating whether farming should be working or also non-working (in EU, the definition of agritourism typically includes the meaning of entrepreneurial diversification of working farms activities).

In addition, another possible matter is related to the kind of activities that an agritourism should do, debating whether including only hospitality correlated services (i.e., lodging, food services and event programming) or also educational/recreational activities.

Last issue is about the meaning of the term "tourism" in the concept of "agritourism", debating whether considering it as a minimum number of overnight staying or a minimum distance from the customer's house.

In order to solve these issues, Phillip et al. (2010) proposed a multiple-definition of agritourisms, classifying them in five groups, on the basis of the offered activities: i) Non-Working Farm (NWF), where non-working farms serve only for scenery goals; ii) Working Farm, Passive Contact (WFPC), where there is not a strong interaction between customers and working-farms; iii) Working Farm, Indirect Contact (WFIC), where the interaction between customers and working-farms is strong, but

only focused on the exchange of agricultural products; iv) Working Farm, Direct Contact, Staged (WFDCS), where the interaction between customers and working-farms is strong and it is focused both on the exchange of agricultural products and on the experience of agricultural operations, that are staged or linked to predetermined tours; and v) Working Farm, Direct Contact, Authentic (WFDA), in which customers are directly involved in agricultural operations, exchanging their labour for food and accommodations.

Basing on the literature definition of agritourism this paper aims to analyse the key features in Piedmont agritourism with a particular focus on services offered, dimensional features, customers, ownership and management, key financial data.

## METHODOLOGY DESIGN

The research focuses on agritourisms located in Piedmont region. This business is particular interesting for the Italian economy due to its continue growth, with an annual rate greater than 4% (Istat source). In the North of Italy there is the main concentration of agritourism farms, providing accommodation (41%); in addition, the 45% of agritourisms providing food services are located in the Italian northern regions.

The choice of the Piedmont Region is also driven by the relevance of this geographical area, as Piedmont is one of pre-eminent regions in terms of agri-tourist supply and which has a strong attraction for tourists such as natural resources, countryside and food and wine. Moreover, the landscape of Langhe-Roero and Monferrato became a World Heritage Site of UNESCO.

The research was conducted through an empirical analysis, using the questionnaire method (Corbetta, 1999) sent by e-mail to all the agritourisms located in Piedmont region. More specifically, the data, both qualitative and quantitative, were collected via an on-line questionnaire using the database provided by the same Region.

The questionnaire was created in June 2016 and sent by e-mail, together with a letter of presentation and a compilation guide, to the selected companies in the months of July, August and September 2016. The compilation period was about 3 months, with several requests made by telephone in order to solicit the answers. The sample is composed by 111 agritourisms that correspond to a response rate of 11%.

In order to verify the coherence of answers, some "test questions" were included in the questionnaire.

The questionnaire was chosen because it is a method that allows researchers to obtain a significant amount of data that can be used for statistical investigation. In accordance with the main literature on these topics (Chenhall, 2003), the evidence was studied using descriptive statistics. Descriptive analyses were conducted to develop a socio-demographic profile (e.g., age, gender) of managers involved in

agritourisms as well as to describe their type of engagement. Descriptive statistics were also conducted to identify characteristics of agritourism.

Basing on the methodology followed by different studies on this topic (Arroyo et al. 2013), the research investigates the key features of Piedmont agritourism with a particular emphasis on type of services offered, dimensional features, type of customers, type of managers that run such business, key financial data.

In accordance with the research purpose, the following research question was formulated: *“What are the main dimensional and organizational features of Piedmont agritourisms?”*

## FINDINGS

### *The management features*

The analysis focuses on the features of family members that run such business. The next graph shows the number of family components involved in agritourism activities.

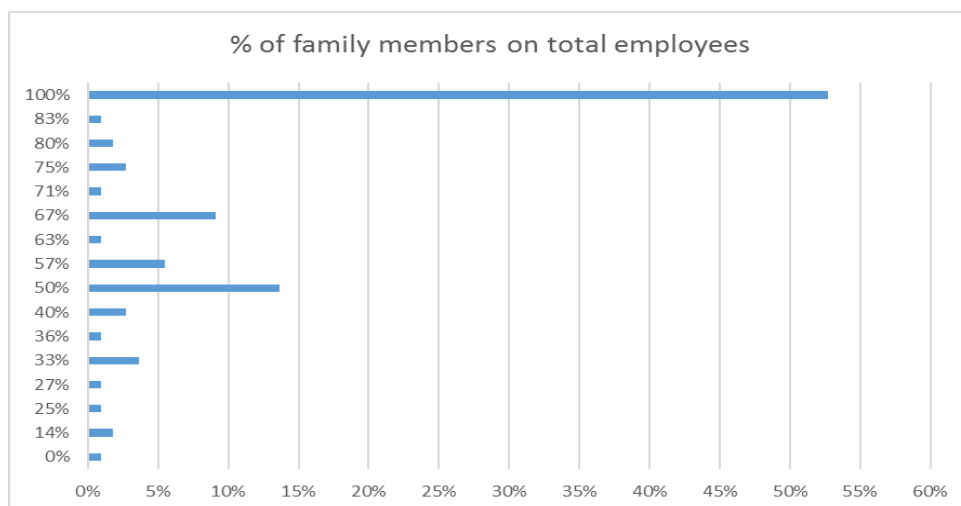

Figure 1. Number of family members involved in agritourism activities.

From the previous figure it emerges that the great majority of the sample (53%) manages the agritourism only with family members, without involving external workers. The number of generations involved in running the agritourisms are following described.

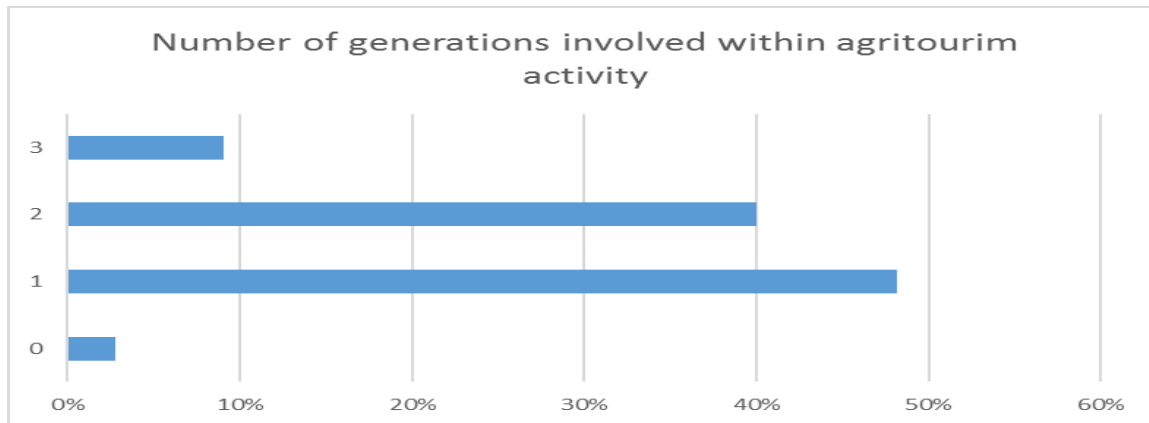

Figure 2. Number of generations.

The previous figure shows that the majority of agritourisms are managed by the first or the second generation of entrepreneurs.

#### *The financial features*

This section provides financial data of the analysed agritourisms.

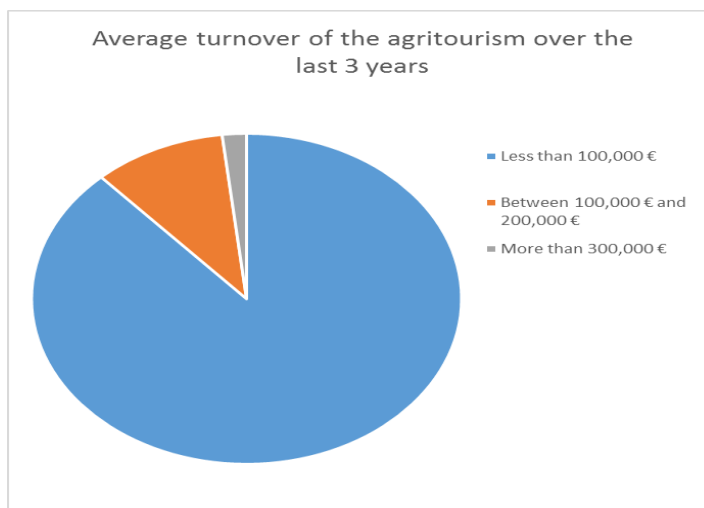

Figure 3. Average turnover over the last 3 years.

The previous figure shows that the agritourisms have generally small dimension as the declared turnover is lower than 1000,000 euros.



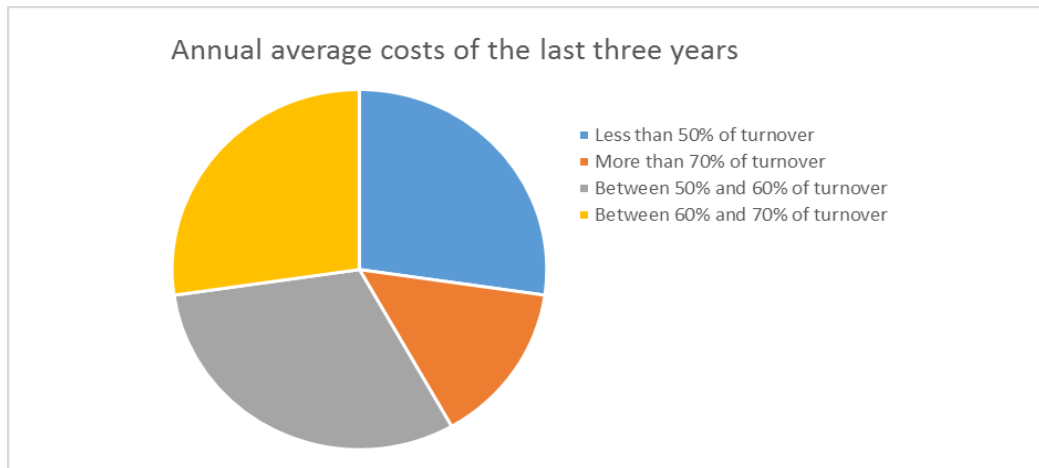

Figure 4. Annual average costs related to turnover.

As regards the cost composition in relation to turnover, it emerges that the 31% shows annual costs between 50 and 60% of turnover, while the 27% has annual costs less than 50% of turnover or between 60% and 70% of total turnover.

#### *State of the art and new opportunities*

According to the purpose of the research we firstly investigated the type of services offered by the agritourisms of the sample.

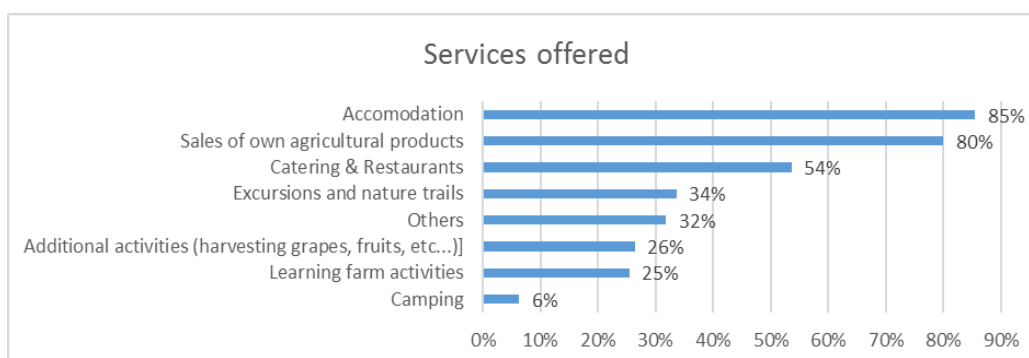

Figure 5. Type of agritourism services offered.

Basing on the previous graph, the types of services more widespread are those linked to the accommodation, sales of own agricultural products and Catering & Restaurants, while camping activities are the less widespread.

The next figure focuses on the customers with a particular attention on the customers' origins: Italian and foreign.

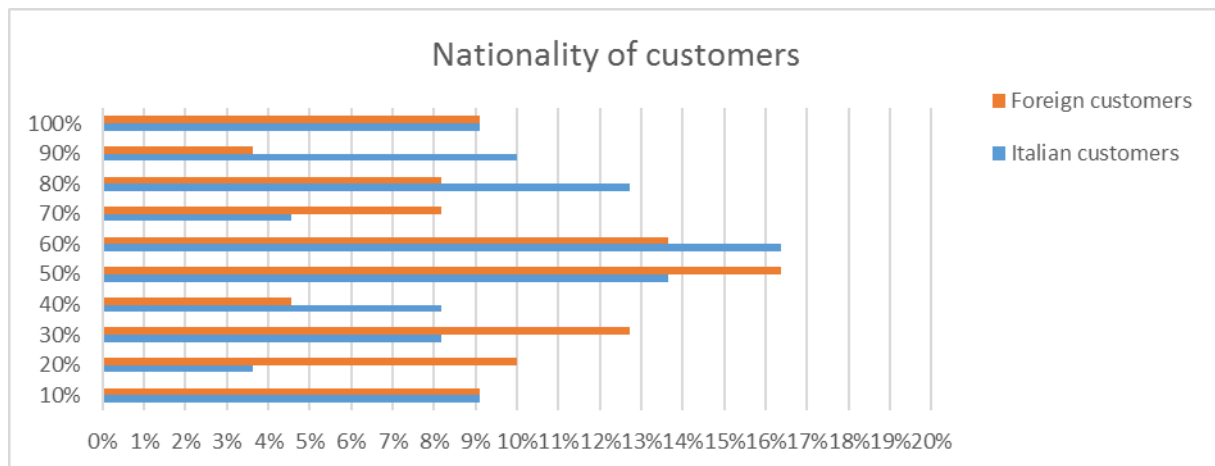

Figure 6. Nationality of customers.

The previous figure shows the different classes – Italian and foreign- of customers declared by the sample. For example, the 16% of the sample works with 60% of Italian customers and 50% of foreign customers and the 4% of the total sample works with the 20% of Italian clients and 90% of the foreign ones. The next graph shows the customers composition differentiated between young (18-35), families and over 65 years old.

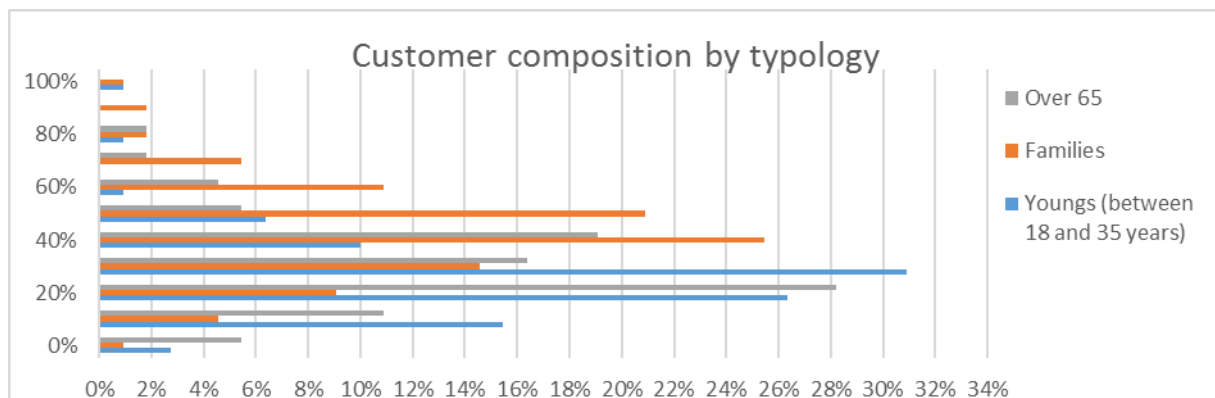

Figure 7. Customer composition by typology.

Analysing the previous graph, it emerges that around the 30% of the sample works with the 30% of young customers, while the 25% of the sample works with the 40% of families and the 28% of the sample works with the 20% of customers over 65 years.

## DISCUSSION AND CONCLUSION

As underlined by the literature, about management features it emerges that the great majority of the sample manages the agritourism only with family members, without involving external workers, confirming that family firms are prevalent in this field (Contò and Lopez, 2008).

Furthermore, the research highlights that the majority of agritourisms are managed by the first or the second generation of entrepreneurs, underlining as the agritourisms phenomenon is quite recent.

Referring to the dimensional features, financial data endorse the small size of Piedmont agritourism, characterized by a turnover lower than 1,000,000 euros (Giacosa et al, 2014). However, the sample shows a good level of profitability due to the limited weight of the cost structure.

Referring to the state of the art and new opportunities, the agritourism services offered are those linked to the accommodation, sales of own agricultural products and Catering & Restaurants, while camping activities are the less widespread. Basing on this evidence and referring to the Philip et al (2010) framework the great majority of agritourism analysed can be classified within the third category of working farm, indirect contact (WFIC). In this group the interaction between agritourism and customer is mainly limited to the sale of agricultural products. In addition, we observed other two aspects about agritourism customers. The first one underlines a good balance of the customers' origin, both at national and foreign level, and the second one shed the light on the good balance also of the customer typology, identified as young customers, families and customers over 65 years.

Although the study focuses on a relevant Italian territory, caution is advised to extrapolate results beyond this region or the Italian territory due to the different regional or national legislation.

Despite the limitations of this study, due to a regional focus, results from this study carry some relevant implications for the theory and practice of agritourism. Indeed the work shares understanding of agritourism key features as a starting point to continue the scientific and educational development of this business.

This study also provides further insights on the types of experiences visitors (state of the art and new opportunities) seek, and consequently agritourism can address their offer on new customers demand, developing the range of new agricultural services. Basing on these evidences future studies should deeply analyze the key factors belonging to the agritourism business model, also enriching the sample, comparing different relevant Italian regions.

## REFERENCES

- Bigliardi, B. and Galati, F. (2013), "Innovation trends in the food industry: the case of functional foods", *Trends in Food Science & Technology*, Vol. 31 No. 2, pp. 118-129.
- Carpio C., Wohlgenant M., Boonsaeng, T. (2008). The demand for agritourism in the United States. *Journal of Agricultural and Resource Economics*, 33(2), 254-269.
- Chenhall, R. H. (2003). Management control systems design within its organizational context: findings from contingency-based research and directions for the future. *Accounting, organizations and society*, 28(2), 127-168.
- Contò, F. and Lopez, A. (2008), *Organizzazione territoriale e sviluppo locale nell'area dell'Alto Tavoliere. Capitale umano e territori intelligenti nell'esperienza del Distretto Agroalimentare del Tavoliere*, FrancoAngeli, Milano.
- Corbetta, P. (1999). *Metodologia e tecniche della ricerca sociale*. Il Mulino, Bologna.

- Giacosa, E., Giachino, C., Bertoldi, B. and Stupino, M. (2014a), "Innovativeness of CerettoAziendeVitivinicole: A First Investigation into a Wine Company", *International Food and Agribusiness Management Review*, Vol. 17 No. 4, pp. 223-236.
- Giacosa, E., Giovando, G. and Mazzoleni, A. (2014b), "Wine sector as a driver of growth for the Italian economy", in 2nd International Symposium Systems Thinking for a Sustainable Economy. *Advancements in Economic and Managerial Theory and Practice Conference Proceedings*, January 23-24, Roma, Italy, pp. 1-17.
- Gil Arroyo C., Barbieri C., Rich, S. (2013), *Defining agritourism: A comparative study of stakeholders' perceptions in Missouri and North Carolina*, *Tourism Management*, 37, 39-47.
- Hegarty, C., & Przeborska, L. (2005). Rural and agri-tourism as a tool for reorganizing rural areas in old and new member states e a comparison study of Ireland and Poland. *International Journal of Tourism Research*, 7(2), 63-77.
- Kizos, T., & Iosifides, T. (2007). The contradictions of agrotourism development in Greece: evidence from three case studies. *South European Society & Politics*, 12(1), 59-77.
- McGehee, N. (2007). An agritourism systems model: a Weberian perspective. *Journal of Sustainable Tourism*, 15(2), 111-124.
- Menrad, K. (2004), "Innovations in the food industry in Germany", *Research Policy*, Vol. 33 No. 6-7, pp. 845-878.
- Phillip, S., Hunter, C., & Blackstock, K. (2010). A typology for defining agritourism. *Tourism Management*, 31, 754-758.
- Sonnino, R. (2004). For a 'piece of bread'? Interpreting sustainable development through agritourism in Southern Tuscany. *Sociologia Ruralis*, 44(3), 285-300.
- Vrontis, D., Bresciani, S., and Giacosa, E. (2016), "Tradition and innovation in Italian wine family businesses", *British Food Journal*, Vol. 118 No. 8, pp. 1883-1897.

## FRAMING THE TEMPORAL DIMENSIONS OF A BRAND

**Brunetti, Federico<sup>1</sup>; Confente, Ilenia<sup>1</sup>; Kucharska, Wioleta<sup>2</sup>; Kaufmann, Hans Ruediger<sup>3</sup>**

<sup>1</sup>Department of Business Administration, University of Verona, Italy.

<sup>2</sup>Marketing Department, Faculty of Management and Economics, Gdansk University of Technology, Poland.

<sup>3</sup>Department of Management, University of Nicosia, Cyprus.

### ABSTRACT

Drawing on existing research dealing with time in brand and brand management, this paper aims at providing a comprehensive and coherent framework of some time-related concepts, with a special emphasis on what happens when a brand reaches the senescence stage.

In addition, it strives to consider what happens when a brand becomes long-lived enough, looking at the brand's customer base. While undoubtedly time affects customers' age and generations, the demand side of the brand-customer relationship is actually under-researched. Finally, a research agenda is developed, in order to improve what is currently known about such an important but neglected topic as the effects that the passing of time has both on the brand and on the consumers it addresses to.

*Keywords: Brand longevity, brand survival, brand life-cycle, brand senescence, brand decline, brand death, target age, target generation, time-framed brand.*

### INTRODUCTION

Time represents a relevant dimension that affects marketing management, from product life-cycle, to logistics management, from improving and providing an effective customer service to time to market for succeeding and gaining a competitive advantage. This dimension can also be considered when focusing on brand strategy.

Whatever facet of a brand one considers, the passing of time exerts an influence. To name just a few, brand identity is not identical forever, brand personality modifies from time to time, brand equity changes over time. The elements of the brand identity change: think of the visual identity first; as far as the brand is seen having a human-like personality, it can naturally modify itself; brand equity rankings issued by various organizations show different results year after year.

In the academic literature, several time-related concepts linked to brands can already be found: brand senescence (Ewing, 2009), brand revitalization and brand death (Thomas and Kohli, 2009), brand survival (Wilcox et al., 2008), brand heritage (Urde, 2007) and so on. One way or another, all of them

essentially focus on a particular stage of the life-cycle and look just at the supply side of the brand-audience relationship, i.e. the company's perspective.

Although the dimension of time is for sure an extremely important matter in everyday business, however two topics are still lacking of analysis from an academic perspective. The first one is the development of a comprehensive framework of the concepts related to time in brand and brand management. The second under-researched topic has to do with the effects the passing of time has on the audience the brand speaks to.

This paper has two main aims: the first is providing scholars with a comprehensive framework of the time-related concepts in brand and brand management; the second is suggesting a research agenda to start taking into account the temporal dimension of the audience of the brand, particularly related to the age and generations of the audience in relation to the age of the brand and its longevity.

The contribution of the article will be twofold: first, having a clearer list of the time-related concepts and of the mutual relationships existing among them; second, having some thoughtful directions for future research in the field of brand longevity that can take in due account the effects of the passing of time on the brand's customer base..

The remainder of the paper is organized as follows: first a literature background about brand and its relationships with time and time-related concepts will be illustrated. After this, a comprehensive framework putting together brand's time-related concepts will be introduced. Finally, a discussion about the main directions for a research agenda about the topic will be suggested.

## **LITERATURE BACKGROUND ON TIME-RELATED BRAND CONCEPTS**

As pointed out before, time represents a crucial element that might affect the management of several marketing dimensions. First of all, the management of brand in time is a crucial part of a long distance brand strategy. Previous literature has considered time applied to brand and brand strategy in several manners. Companies can decide to focus on different strategies to survive across the years. For instance, brand managers must maintain consistency to create strong, specific and easy to recognise images associated with their brands (Delgado-Ballester et al. 2012; Keller et al. 2001; Park et al. 1986); yet, at the same time, they must opt for maintaining brand relevance, which may require to be updated (Aaker, 2012; Holt and Cameron, 2010; Kapferer, 2014). Creating higher acquisition and retention rates leads to increased willingness to pay higher margins by customers (Stahl et al., 2012).

Brand relevance across time is a key issue in order to retain customers considered by previous research after 2005. However, depending on authors, context, and time when their studies were undertaken, the factors indicated as crucial for maintenance of brand relevance change. For instance, Bennett & Rundel-Thiele (2005) introduced the *Brand Loyalty Life Cycle Model*. When analysing brand

equity components, they observed that generally, over the years, customers' attachment to brands decreases. The authors suggest that brand loyalty declines for two main reasons: firstly, the quality levels of branded products have risen to a standard where they no longer clearly differentiate the competing brands within the category, secondly: the perception of brands has a different meaning for new consumers than for long-time heavy users. Based on this study, brand relevance is an important longevity factor.

Another time related theme that previous literature considers is brand survival and its predictors. When studying brand survival in the wine industry, Wilcox *et al.* (2008) listed from Aaker *Brand Equity Model* (Aaker, 1991) two components: brand awareness and perceived quality. Their results suggest that brand awareness can be a good predictor of brand ability to survive in time. Referring to the brand equity framework, Thomas & Kohli (2009) claim that most brands with high levels of awareness or positive brand image are candidates for revival. They emphasise that branding is an exercise in patience. Most brands take a long time to build, and a long time to die. This process is a challenge in a corporate system, which usually rewards managers based on short-term performance. In their opinion, the brand revitalization process can be kick-started by addressing the causes of the decline; understanding why it may have failed to maintain its relevance; adjusting this, if necessary; and re-educating the market about new identity.

Referring to the holistic approach of brand management, another stream of research related to time is related to brand evolution. A close attention should be paid to the research by Merrilees (2005) who stresses the importance of brand evolution as a necessary component of a successful marketing strategy. Merrilees has also introduced the idea of three key constructs as a framework for analysing rebranding decisions: brand vision, brand orientation, and brand strategy implementation. Based on that, we can conclude that brand managers should continuously reassess brand vision relevance and company's brand orientation level and the ability to successfully implement its strategy in relation to the market. The opinion that brands need to be revised and reassessed is discussed by Tjiptono *et al.* (2006), who even state that brand is a specific asset which can be 'temporarily dead' and then reintroduced to the market. Tjiptono lays out four brand-specific characteristics: brand origin and brand ownership, brand architecture, brand scope, and brand size which are responsible for brand longevity defined as a continued presence of a brand in the relevant market. The bottom line is that a brand strategy should be continuously reassessed.

Focused on the last step of a brand life cycle, Ewing *et al.* (2009) point out that brands should be immortal and only managerial incompetence results in brand death. They refer to Groucutt (2006, p. 106) who argues that brand life expectancy can be increased by innovation and repositioning. Ewing *et al.* (2009) have introduced a model of *Brand Senescence*, where the key point is to help managers to

recognise the moment when a brand starts to become irrelevant and needs to be innovated to survive. The model is composed of the following factors: constitutive utility (wellbeing and reflexive effects) and symbolic utility (symbol boredom and status relevance/irrelevance). The essence of this model is that successful brand attracts aspirational interest from non-owners who hold that successful brand in high esteem. As more non-owners achieve their goal and become associated with the brand they aspire to, the value for previous owners decreases. In the long run, the brand ultimately declines and runs out of aspirational consumers. Thus, the *Brand Senescence* model suggests that the key factor for a brand to be immortal is the ability to inspire people and be aspirational.

Another interesting research aspect of brand longevity related to Brand Life Cycle is explored by Butterfield (2007). This article draws the attention to the fact that brands and products have the same lifecycle. The key actions which help to renew brand's lifetime are adaptation and rejuvenation driven by innovation and re-positioning of the brand. Likewise, Bivainiene (2010) discussed the theoretical concept of the Brand Life Cycle Model. She highlighted that brand identity, and consequently brand image, is a key factor related to the brand life cycle, because it influences brand association by customers. Her model proposition is based on three principles: brand identity related to personal values and emotions gives the benefit of self-expression which reflects customer's image, brand identity as a root of customer-brand relationship, and brand identity as a reflection of brand coherence which reacts to changes adequately. In the context of brand life, the brand image is analysed as a result of consumers' opinions and actions. Not only, the brand image is the result of the relationship it has with the consumer, and the way she/he perceives and recognizes herself/himself with brand's values, cognitive characteristics and emotions (Kaufmann et al., 2012). Referring to brand consistency across time as a part of the literature review, it is worth having a closer look at studies of Rindell (2013). Rindell investigated the influence of inputs from consumers' past experiences of a company on their current image-construction processes. She found out that consumer images generated by relevant past experiences are a direct and influential input into real-time corporate image formation. Based on their qualitative researches she also introduced two concepts: "image heritage" and "image-in-use" - respectively, distinguishing consumers' past-based images from those they construct in real time. Image heritage is moderated by three principal variables: timespan of awareness, content of earlier experiences, and key temporal focus. Referring to "image heritage" Rindell & Iglesias (2014) conducted an online qualitative survey with regard to brand image construction processes over time. Their results suggest that time and context dimensions of brand experiences are strongly related to further brand images. In essence, past images from past experiences influence how present experiences are interpreted into current images and future expectations. In connection with our study it means that managers should, in systematic way, identify these specific memorable moments (time



and context) which are most crucial for the consumers' brand image construction processes and transfer these findings onto brand management processes. This will allow them to follow the customer's lifetime and make brands always relevant. The idea of the influence of "image heritage" on strategy brand management was continued by Rindell *et al.* (2015). The findings of their researches suggest that key challenge for making brand always relevant across time is to find the right balance between company's and customer's and other stakeholders' brand image heritage.

According to the importance of the concept of "Brand heritage", Urde *et al.* (2007) and later on Balmer and Burghausen (2015) pointed out that brand heritage is a denotation of longevity. As Urde claimed, longevity does not necessarily result in a brand heritage, it can, however, be its key element. This can be especially true for family-owned brands. Moreover, even timelessness can be considered as an important brand attribute: "The problem is that the quality of timelessness takes years to develop, even decades. You cannot just decree it. A brand has to pay its dues - it has to come to stand for something in the eyes of the world" (Wetlaufer, 2001, p. 122). Therefore, brand heritage as source of longevity is important for companies with a long tradition, where company heritage and brand heritage are very closely related.

Beverland *et al.* (2015) examined existing theories on brand consistency and relevance and concluded that although these theories present some guidelines to help brand managers resolve the competing imperatives of brand consistency and relevance, following them would assure sustainable performance of a brand rather than brand development. In consequence, they introduced their own concept of *Brand Ambidexterity*, where brands managers need to find the appropriate balance between consistency and relevance based on the idea of service-dominant logic (Merz *et al.*, 2009) and through the methodology of design thinking (Brown, 2009; Dorst, 2011) which can stimulate brand innovation. In their opinion, the combination of these two approaches is the best way to succeed in search for the right balance across years. Service Dominant Logic is about customer centricity as a fundamental company's mindset (Lusch & Vargo, 2014). Design Thinking Methodology focuses on how things (e.g. products and brands) ought to be to achieve novelty and workable solutions (Cross, 2011; Kimbell, 2011). Beverland *et al.* (2015) suggested that brand managers become more like designers when adopting a design thinking approach to brand management and that *Brand Ambidexterity* concept helps brand managers possess a capability of building two things: consistency and relevance of brands.

Urde (2016) introduced the Brand Core concept and how it has been evolving over time. This paper defined a set of core brand values supporting a brand promise defined as a sum of inner meanings of a brand, to communicate its value proposition and to clarify its position (de Chernantony, 2009). The Brand Core is based on three management perspectives: PATHOS - appealing to emotions and the

will of customers, ETHOS – appealing to brand personality, and LOGOS – appealing to reason and understanding of customers. These three perspectives give a fundamental meaning to the brand promise, and vice versa, as a point of reference in long-term management. The presented framework is intended to be an aid for the strategic brand management, to explore the core of the brand (universal criteria) and for its consistent management (continuity criteria) and communication over time (dynamic criteria). Urde (2016) suggests that management must measure the essential brand core elements over time. By tracking the internal foundation and commitment of the brand – combined with external appreciation and perceptions of the brand promise and the core values – management can continuously evaluate the strength and performance of the brand core. Such a managerial tool serves as an early warning system and an essential guide in strategic brand management.

### A PROPOSED FRAMEWORK OF TIME-RELATED BRAND CONCEPTS.

Past research has undoubtedly examined many time-related concepts in brand and brand management. Quite often, however, each concept is considered in relative isolation from the other ones, so that the knowledge available is somehow disconnected. In the following figure, we try to put such concepts together in order to create a single coherent framework.

**Fig. 1 – Time-related brand concepts**

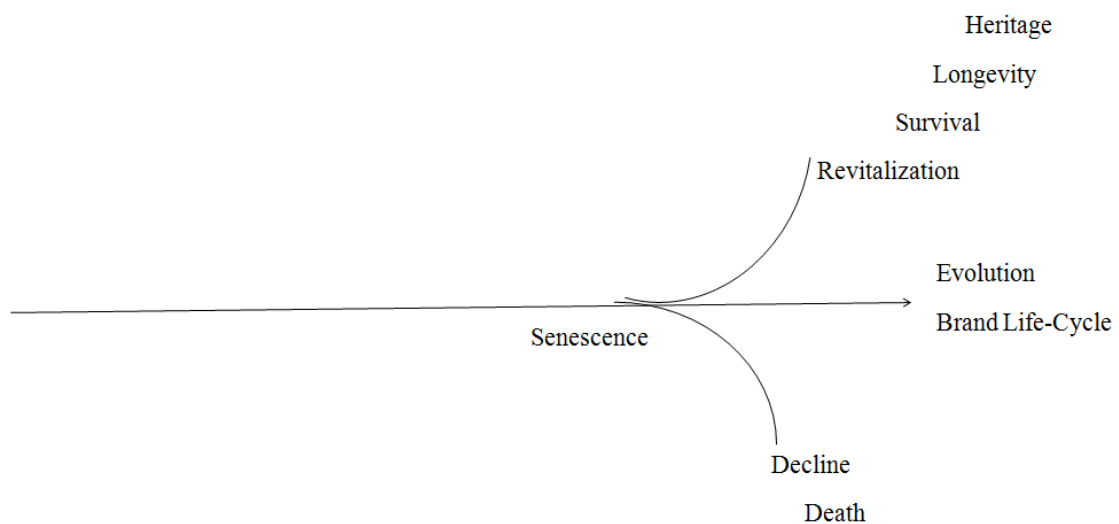

According to a general life-cycle model, sooner or later at a certain stage brand senescence will occur. Depending on which brand strategy marketers implement different scenarios will happen. In the worst case, brand decline will follow and, unless marketers are able to put the brand back on a revitalization track, it will likely result in brand death. On the other side, after senescence brand can be revitalized and consequently it will survive, thus resulting in brand longevity. It is very likely that

such brand will be able to benefit from a certain amount of heritage, since some time will be obviously elapsed.

## **TOWARDS A RESEARCH AGENDA ON BRAND AND TIME-RELATED CONCEPTS**

The extant literature on time-related concepts applied to branding research raises some questions. With few exceptions, published research in this domain focuses primarily on a specific period of time (often the decline phase) or focuses on just one dimension or element regarding branding strategy (brand meaning, brand design, brand core etc.). In addition, no research summarizes existing works on overall time-related concepts of brand. The academic debate remains open about which brand strategies are better to follow in order to guarantee brand survival and longevity.

In light of the quoted works, being relevant and always up to date seems for a brand to be a better strategy than only to be consistent. On the other side, brand heritage, as an outcome of longevity, may be a strong element lending weight and making a brand stand out in the market. Managers responsible for brands with a background abundant with traditions should, as much as others, follow Brand Life Cycle in order to maintain Brand Core Relevance. Strategies for finding and implementing the appropriate balance between consistency and relevance vary, and depend on several aspects, namely: the market, industry and product category as well as the already discussed brand heritage.

For the above reasons, some of still open and unanswered questions that future research can address may be the following:

- what are the main drivers for brand longevity maintenance? Some empirical research is needed for providing best practices of brand survival and longevity (Tjiptono et al., 2006; Wilcox et al., 2008);
- is it better to be a timeless brand that relies on tradition and heritage (Urde et al., 2007) or being a “up to date” brand that continuously rejuvenates itself and to survive (Thomas and Kohli, 2009)?

Beyond the above questions, further aspects are still missing.

Actually, no one can hardly deny that reaching a certain extent in longevity is for any brand both difficult and fruitful. Consequently, a good number of papers deal with the issue of getting old enough, since longevity is reckoned as a positive result to obtain. Longevity means heritage and heritage is in turn a good driver of brand equity (Rindell et al., 2015).

But, to the best of our knowledge, no research has ever considered the effects of brand longevity on the brand’s customer base and its implications on brand management. In other words, the demand side of the relationship with the brand has been totally neglected.

When time goes by, in fact, it is highly presumable that customers of different ages will be part of the same customer base. In addition, the more the brand is long-lived the more various the ages will be.

Therefore brand managers will be confronted with the necessity of managing a brand that speaks to a differently aged audience.

So, it seems quite interesting to investigate what happens in the brand's customer base when the brand's life spans over a certain number of years.

To analyze the issue of the temporal heterogeneity of the customer base, we need to introduce three concepts:

*Calendar time*: the year or, for the sake of simplicity, the decade we are referring to: 1970, 1980, 1990, etc.;

*Target age* of consumers: the typical age of customers the brand is addressing; let's say teenagers, people in their twenties, thirties and so on;

*Generation*: target age linked to calendar time. Customers belonging to a target age born in a given decade. For example, starting with 1950 as calendar time, teenagers who were born in 1950, 1960, 1970, 1980, 1990 and 2000; people in their twenties who were born in 1950, 1960, 1970, 1980, 1990; people in their thirties who were born in 1950, 1960, 1970, 1980; people in their forties who were born in 1950, 1960, 1970, 1980 and so on.

Based on these premises, some open research questions are:

- as a brand reaches a certain longevity, are managers aware of the different clusters of consumers based on their age and/or generation?
- how is it possible to distinguish among customers, according to their generation?
- do all the long-lived brands have the same composition in terms of age and generation of the customer base?
- in case a brand's customer base is made of different ages and/or generations, do these different groups of customers share the same brand image or not?
- in case of multiple generations in the customer base, how can marketers manage the coexistence of such generations, in terms for instance of brand identity?
- is it possible to predict brand survival in the future observing the time-related dimensions of the brand's customer base?

Based on these questions, further research is needed in order to better explore this phenomenon. In addition, beyond conceptual research, additional empirical research about this topic is called for. Qualitative studies could better delve into the subject, for instance better defining the antecedents and consequences of brand longevity across time. Later on, quantitative studies could validate the results from the qualitative studies, testing hypotheses about the existence of some relationships among brand longevity and customer's base age and generation.

## REFERENCES

- Aaker, D. A. (1991), *Managing Brand Equity: Capitalizing on the Value of a Brand Name*, The Free Press, New York, NY.
- Balmer, J. M., & Burghausen, M. (2015). Explicating corporate heritage, corporate heritage brands and organisational heritage. *Journal of Brand Management*, 22(5), 364-384.
- Batra, R., Ahuvia, A. and Bagozzi, R. P. (2012), "Brand love", *Journal of Marketing*, 76 (2), 1-16.
- Beverland, M. B., Wilner, S. J., & Micheli, P. (2015). Reconciling the tension between consistency and relevance: design thinking as a mechanism for brand ambidexterity. *Journal of the Academy of Marketing Science*, 43(5), 589-609.
- Bennett, R., & Rundel-Thiele, S. (2005). The brand loyalty life cycle: Implications for marketers. *Journal of Brand Management*, 12(4), 250-263.
- Bivainiene, L. (2010). Brand Life Cycle: Theoretical Discourses. *Economics & Management*, 15, 408-414.
- Brown, T. (2009). *Change by design: How design thinking transforms organizations and inspires innovation*. New York: HarperCollins.
- Burmans, C., Jost-Benz, M. and Riley, N. (2009), "Towards an identity-based brand equity model", *Journal of Business Research*, 62 (3), 390-397.
- Butterfield, L. (2007). Brand survival: Do brands really last forever?. *Strategic Direction*, 23(3), 10-12.
- Cross, N. (2011). *Design thinking: Understanding how designers think and work*. London: Bloomsbury.
- de Chernatony, L. (2009), Towards the holy grail of defining' brand, *Marketing Theory*, 9 (1), 101-104.
- Delgado-Ballester, E., Navarro, A., & Sicilia, M. (2012). Revitalising brands through communication messages: the role of brand familiarity. *European Journal of Marketing*, 46(1/2), 31-51.
- Dorst, K. (2011). The core of 'design thinking' and its application. *Design Studies*, 32(6), 521-532.
- Ewing, M. T., Jevons, C. P., & Khalil, E. L. (2009). Brand death: A developmental model of senescence. *Journal of Business Research*, 62(3), 332-338.
- Groucutt J. (2006) The life, death and resuscitation of brands. *Handbook of Business Strategy*. 101-106.
- Kapferer, J. N. (2014). Brands and innovation. In K. Kompella (Ed.), *The definitive book of branding* (pp. 149-170). London: Sage.
- Karjalainen, T.-M., & Snelders, D. (2010). Designing visual recognition for the brand. *Journal of Product Innovation Management*, 27(1), 6-22.
- Kaufmann, H.R., Correia Loureiro, S., Basile, G. & Vrontis, D. (2012). The increasing dynamics between consumer social groups and brands. *Qualitative Research: An International Journal*, 15 (44), 404-419 .
- Keller, K. L. (2001). *Building customer-based brand equity: A blueprint for creating strong brands*. Cambridge, MA: Marketing Science Institute.
- Kimbell, L. (2011). Rethinking design thinking: part I. *Design and Culture*, 3(3), 285-306.
- Lusch, R. F., & Vargo, S. L. (2014). *The service-dominant logic of marketing: Dialog, debate, and directions*. Routledge.
- Merrilees, B. (2005). Radical brand evolution: a case-based framework. *Journal of Advertising Research*, 45(2), 201-210.
- Merz, M. A., He, Y., & Vargo, S. L. (2009). The evolving brand logic: a service-dominant logic perspective. *Journal of the Academy of Marketing Science*, 37(3), 328-344.
- Park, C. W., Jaworski, B. J., & MacInnis, D. J. (1986). Strategic brand concept-image management. *Journal of Marketing*, 50(4), 621-635.
- Rindell, A. (2013). Time in corporate images: Introducing image heritage and image-in-use. *Qualitative Market Research: An International Journal*, 16(2), 197-213.
- Rindell, A., & Iglesias, O. (2014). Context and time in brand image constructions. *Journal of Organizational Change Management*, 27(5), 756-768.
- Rindell, A., Santos, F. P., & de Lima, A. P. (2015). Two sides of a coin: Connecting corporate brand heritage to consumers' corporate image heritage. *Journal of Brand Management*, 22(5), 467-484.
- Stahl, F., Heitmann, M., Lehmann, D. R., & Neslin, S. A. (2012). The impact of brand equity on customer acquisition, retention, and profit margin. *Journal of Marketing*, 76(4), 44-63.
- Wilcox, J. B., Laverie, D. A., Kolyesnikova, N., Duhan, D. F., & Dodd, T. H. (2008). Facets of brand equity and brand survival: a longitudinal examination. *International Journal of Wine Business Research*, 20(3), 202-214.
- Tjiptono, F., Craig-Lees, M., & Layton, R. (2006). Understanding brand longevity. In *Proceedings of ANZMAC 2006 Conference: Advancing Theory, Maintaining Relevance*, Queensland University of Technology, Brisbane, Australia, 4-6.

- Thomas, S., & Kohli, C. (2009). A brand is forever! A framework for revitalizing declining and dead brands. *Business Horizons*, 52(4), 377-386.
- Urde, M., Greyser, S. A., & Balmer, J. M. (2007). Corporate brands with a heritage. *Journal of Brand Management*, 15(1), 4-19.
- Urde, M. (2016). The brand core and its management over time. *Journal of Product & Brand Management*, 25(1), 26-42.
- Wetlaufer, S., Arnault, B. (2001) 'The Perfect Paradox of Star Brands: An interview with Bernard Arnault of LVMH', *Harvard Business Review*, October, p 122-46.
- Verganti, R. (2011). Designing breakthrough products. *Harvard Business Review*, 89(10), 114–120.

## HOW FOUNDERS VIEW THE DEVELOPMENT OF CUSTOMER- AND BRAND-ORIENTED CAPABILITIES OF THEIR YOUNG FIRM

Buttenberg, Katharina

Department of Global Economics, University of Latvia, Riga, Latvia

### ABSTRACT

With a recently increased interest in entrepreneurship, the founding and growth of new firms is more than ever an important factor for economic growth. Entrepreneurs and founders are facing many challenges. Strategic and functional marketing capabilities are a key driver to provide strong sustainable economic value. Therefore, founders need to acquire and develop these capabilities in the early beginning of the firm.

**Purpose:** This paper aims to shed light on the specific characteristics of customer- and brand-oriented marketing capabilities for young firms and how their impact on business performance is analyzed.

**Design / methodology / approach:** Adopting a case study methodology through in-depth interviews with founders and CEOs, 14 young firms in Germany and the USA were analyzed.

**Findings:** The paper gives an overview of the specific requirements for customer- and brand-oriented marketing capabilities in young firms as drivers of business performance and proposes a framework for the assessment these capabilities.

**Practical implications:** The proposed framework and learnings offer founders, managers of nascent firms and start-up investors orientation on how to strategically evaluate marketing capabilities and take strategic choices on their acquisition and development.

**Research limitations:** The findings in this paper are qualitative and need to be quantified in a next step.

**Originality/Value:** The research investigates marketing capabilities that are specific to new firms in order to support their strategic decision-making on customer- and brand-oriented marketing capabilities.

*Keywords: young firm, start-up, brand-orientation, customer-orientation, marketing capabilities, business performance, marketing, branding, life-cycle, resource-based theory.*

### INTRODUCTION

Global and national business theories and practice:  
bridging the past with the future

ISSN: 2547-8516  
ISBN: 978-9963-711-56-7

Scholars of the Resource-Based Theory (RBT) of the firm consider the development of resources and capabilities as main factor for the competitive advantage of a firm. In opposition to other theories, entrepreneurs can influence the success of their organization by aggregating or creating a unique set of assets, differentiating their firm from other competitive organizations. Marketing and especially the development of marketing capabilities have been found to be one of the main frameworks to analyze and explain competitive advantages and even forecast performance outcomes in the RBT framework (e.g. Kozlenkova et al., 2014, p. 1). From the business-side as well as in academic research, there is a growing interest in the measurement of the contribution of the marketing-discipline on performance and first research has already indicated a positive impact of marketing capabilities on business performance. There are two main types of capabilities – customer-oriented and brand-oriented capabilities, which drive brand equity and organizational performance. The two concepts of marketing capabilities are based on two different views of the firm – the “outside-in” and the “inside-out” view of the firm, which both need to be considered when building successful brands (e.g. Urde et al., 2013, pp. 14–15). Customer-oriented marketing capabilities such as customer relationship management, market sensing capabilities or product development capabilities have been proven to contribute to business performance. The same holds true for brand-oriented capabilities such as branding, pricing or functional brand implementation and marketing communication. Analysis comparing customer-oriented and brand-oriented marketing capabilities has provided differing results. Higher levels of customer- and brand-oriented marketing capabilities have been found to result in higher financial performance (e.g. Vorhies et al., 2011, p. 752) Even though the overall effect of these marketing capabilities on profit growth rates is positive, there have been findings on some different directions in the effects of revenue growth and margin growth rate (Morgan, Slotegraaf et al., 2009, pp. 289–290). Later research confirms that the combination of customer- and brand-oriented capabilities is beneficial to business performance and improves the outcome and even future earnings of the firm (e.g. Angulo-Ruiz et al., 2014, p. 395). These previous findings prompt strong causal relationship between marketing capabilities – customer- and brand-oriented – and business performance. Hence, customer- and brand-oriented resources and capabilities need to be acquired and developed over time to support firms in their different stages of the life cycle to provide as competitive advantage (e.g. Sirmon et al., 2010, p. 1387) and contribute to firm performance.

## **OBJECTIVE OF THE STUDY**



The goal of this research is to gain insight from young firms on the marketing-capabilities they had developed, their strategic view on marketing capabilities in their current stage of the life cycle and their judgment on the impact of their marketing capabilities on their business performance. Authors define the components of constructs measuring marketing capabilities in different ways. Marketing capabilities have been previously described as capabilities involved with the creation and management of brands, the management and development of customer relationships and the building of marketing innovation and knowledge on a strategic as well as a functional level. Based on an in-depth literature review of marketing capabilities in the RBT literature, the author has developed a general classification of marketing capabilities into a marketing capabilities matrix. The first dimension of these marketing capabilities is customer- and brand-orientation. In the second dimension, these capabilities are broken down in strategic and functional marketing capabilities (Buttenberg, 2015, p. 36). This research is a supplement to the previously identified concepts, allowing the researcher to further structure the findings generated for the marketing matrix. The results of the qualitative analysis provide information for the selection of the items to be included in the latent constructs of customer-based and brand-based marketing capabilities as well as business performance for future research.

## **ENTREPRENEURIAL CHALLENGES IN YOUNG FIRMS**

Depending on their stage in the life cycle, firms are facing different challenges also in terms of development of firm value. Especially for young firms, where structures are still small, environmental conditions are a greater threat to the survival than they are to older and bigger firms. Young firms most likely have less resources available than larger firms and they are less structured and strategically planned (Gilmore, et al., 1999, p. 29). There is also a greater risk of failure for firms, when they are young of age and still small (Thornhill & Amit, 2003, p. 497). Capabilities might not be fully developed and market-based information will still be limited (Sinkula, 1994, p. 36). But – due to its small size and its newness – it is easy for young firms to act highly entrepreneurial, to innovate and quickly react to environmental changes (Weerawardena, 2003, p. 18). In the modern entrepreneurship literature, entrepreneurs are forming opportunities themselves, it is an important topic for CEOs and managers especially of young firms to acquire and develop capabilities that support business performance. In addition to entrepreneurial orientation, well-developed marketing skills can support innovation in these turbulent environments and contribute to the development of strategic orientations (Miller, Droge, & Toulouse, 1988, pp. 550–551). In the last decades, the discipline of marketing has been striving to become more accountable for business performance. Recent literature and analysis has shifted the previous sole focus of functional marketing activities to a focus on the brand as the center of marketing and models have been conceptualized to assess the return on marketing investment. Unfortunately,

empirical analysis focused on the development of marketing-capabilities in young firms is rare. This is surprising, since under the light of the creation of sustained competitive advantages, marketing capabilities deserve close attention. They can provide multiple benefits to young firms, not only in terms of financial performance and market effectiveness, but also argue for shareholder value (Srivastava et al., 1998, pp. 8 pp.), or for attracting and maintaining employees, a very scarce resource in young firms (Lievens, 2007, pp. 62). The few papers identified which analyze marketing capabilities in young firms mainly focus on brand-oriented marketing capabilities and are aimed at exploring the developments of marketing and brands in new firms. Especially the qualitative papers are concerned with founders or CEOs of new firms and analyze their perception of relevance of marketing, how they create the brand and make first branding decisions and measure their marketing activities. In regards to branding, there are two authors who have specifically engaged with the topic of the development of a brand in new firms. While Rode and Vallaster analyzed the status of branding with companies at the age between two and four years, Bresciani and Eppler focused more on the relevance of the brand, the attitude towards branding and the brand building process itself of companies with an age up to five years. Findings were that most companies at the age of up to four years had not decided on their final brand including strategic branding elements such as positioning, values etc. as well as their final functional elements such as name and logo (Rode & Vallaster, 2005, pp. 125–128). Of the slightly older companies (up to five years of age), most had already defined their strategic elements, but the functional elements were still unclear. (Bresciani & Eppler, 2010, pp. 359–361) Regarding marketing-communication, both studies confirmed the financial constraints. They also highlighted a lack of professionalism in communication and the lack of identifying suitable target audiences.

## **CUSTOMER- AND BRAND ORIENTED MARKETING CAPABILITIES**

The discipline of Marketing itself is a core and long-developed discipline, which has evolved quite considerably in the last decades. Strategic and functional marketing capabilities are a key driver to provide strong sustainable economic value (e.g. Rust, Ambler, et al., 2004, p. 77), which is typically half of the market capitalization of a mature firm. Contemporary theories of marketing have raised the purpose of marketing from mere communicative support for sales and product presentation towards a more integrated, strategic role as value-driver with focus on shareholder returns (e.g. Day & Fahey, 1988, pp. 46). Also the focus of marketing has changed from a sole focus on how the brand is communicated to the inclusion of an outside-in view, traditionally based in customer behavior theory and customer satisfaction theories. Customer- and brand-oriented marketing capabilities are representing different views on the firm – the outside-in and the inside-out view. These views also hold different implications and are based on different organizational assumptions. The customer-oriented

approach is highlighting the outside-in view of the consumer on the firm. The theoretical base for customer-orientation roots in customer-behavior- and customer-satisfaction theories. Culturally, organizations which are very consumer-oriented set high importance on the fulfillment of customer needs, also on the individual level of the employee (Saxe & Weitz, 1982, p. 343). Consumer-oriented organizations display market-oriented behaviors such as a strong focus on individual customer needs and adherence to its changes. They also strategically segment their customers to better focus on specific characteristics of separate groups (Urde et al., 2013, pp. 14 pp). Especially capabilities in regards to the management of the customer relationship or market sensing capabilities as well as more functional capabilities such as the generation of customer feedback on products and product development capabilities have been proven to be connected to firm performance and profitability by a wide stream of research. The concept of brand-orientation is putting the brand as strategic hub in the center of its' focus. High brand-orientation stands for a marketing strategy and marketing activities centered on the brand. Successful brands create awareness for the firm and evoke positive associations, support of a positive brand image and differentiate the brand towards competitors (Aaker, 1991, pp. 15 pp). Culturally, brand-oriented organizations share a strong brand-philosophy throughout the whole organization, framing how they operate from the inside-out. Capabilities such as branding capability, pricing or brand performance as well as more functional brand-oriented capabilities like the definition of the brand name and logo, market planning, marketing communication or marketing implementation fall in this group. Especially in the birth phase of a young firm, where resources are scarce and the organization is not structured, firms need to focus on the important capabilities to acquire and develop. Marketing capabilities can significantly support firm value. They are amongst the key capabilities firms have to develop to gain insights on customers, build customer relationships and leverage them for their success and create their own brand and brand elements, communicate it and position the firm against competitors. Even though several authors have already engaged in the analysis of marketing in the context of the Resource-Based Theory and have proven a significant impact of these capabilities on business performance, there are only few authors who have analyzed them in the context of small firms.

## **METHODOLOGY**

As previously mentioned the constructs of marketing capabilities vary between authors and how they classify and compose the single components of these constructs in different ways. Since the topic of marketing capabilities in young firms is a quite untouched subject of research, the author wanted to ensure that all relevant components of customer-oriented and brand-oriented capabilities and business performance indicators for young firms are considered. Because the research question posed by the

author is also still a much undefined topic and previous research is limited, the author identified it as appropriate approach to analyze her research question. To assess the characteristics of marketing capabilities as well as business performance in young firms, the author decided to use semi-structured expert interviews as most appropriate research instrument. As the goal of this research is to gain insight from young firms on the marketing-capabilities, the author has based the surveys on the previously identified capabilities, which are a supplement to concepts of customer- and brand-oriented marketing capabilities identified in the literature review, allowing the researcher to further structure the findings previously generated and specify them to the requirements of young firms. To better understand the specific marketing capabilities needed and developed by young firms, qualitative in-depth interviews were conducted. The author adopts the principles of the key informant technique identifying interview-partners (Gläser & Laudel, 2006). Based on this technique, the ideal informant should have a role in community in which he has permanent access to the information sought, he should have transformed this information into knowledge and should be willing to share this knowledge (Tremblay, 1957, p. 692). Since the goal of the author is to analyze firm-level performance, the author focuses on the founders of single-business firms with an age of maximum ten years. The interview partners all hold CEO positions and are owners of their firm at the time of the interview. To avoid any bias in the firms selected due to the focus on a specific market, industry, product or country, a broad variation of firms was selected. The products and services produced by the firms vary from marketplaces and services to technical devices. Also, the company size varies very much, but the majority of the companies have only a low number of employees at the time of the interviews. To avoid national differences, the companies are chosen from two countries, Germany and the USA, the two strongest economies for innovation following the small economies of Switzerland and Singapore (Weissenberger-Eibl, et al., 2013, p. 21). This broad variety enables the author to recognize general marketing capabilities for young firms and identify performance indicators applicable to various markets. Table 1 provides an overview on the firms.

Company / CEO	Product / Service Description	Founding Year	Founders	Employees at the time	Country
A	Subscription cancelling service	2008	2	8	Germany
B	Individual car-wrapping	2012	2	0	Germany

C	Video technology nurse service	2013	5	20	USA
D	Online and offline art auctions	2012	3	171	Germany
E	Sports performance tracker	2011	2	6	USA
F	Baby shopping community	2013	2	5	Germany
G	Restaurant coupon service	2014	2	0	USA
H	Content software	2013	3	0	USA
I	Language learning software	2014	1	0	USA
J	Booking tool for fitness clubs	2013	2	3	Germany
K	Online tracking optimization tool	2012	2	24	Germany
L	Electricity management device	2013	3	2	USA
M	Stand-up comedy theater	2010	3	3	USA
N	Consulting for usability design	2013	1	0	Germany

Source: construct by author

Table 1 *Profiles of CEOs interviewed and their firms*

For the interviews, the questions and an interview-guide are prepared according to the guidelines for such qualitative interviews with knowledge carriers. The questionnaire was split in different sections covering questions about the founders who were selected as respondents, their firms and their current stage of development as well as their marketing capabilities and their measures for the success of these capabilities and the business. To enhance descriptive validity, the interviews with the founders were taped and transcribed by the author for further analysis. In regards to interpretative validity, the author adjusts the language and usage of the terms for the constructs based on the language used by the respondents during the interviews, as recommended by experts. To ensure that the meaning of the expressions is interpreted correctly and to avoid any misunderstandings, the author asks the interviewees to explain the terms and then used them in the rest of the interview in the meaning they have defined (e.g. Polkinghorne, 2005, p. 139). The main structure of the survey and the sections are listed in Table 2.

Section	Content
Information of founder	Confirmation of Name Position in the firm Role in the founding of the firm

Information on purpose of the firm	Questions on "big idea" Description of product / service Industry of operation Market environment
Brand-oriented marketing capabilities	Description of brand Reason for development of brand Purpose of brand Brand elements
Customer-oriented marketing capabilities	Participants in brand-development Process of brand / product development Brand-meaning for customers and stakeholders Differentiation of brand
Performance indicators	Indicators of success of brand Indicators of success of firm Performance indicators of brand Performance indicators of firm
Outlook	Future development of brand and firm
Firm data	Size of founding team Number of employees Founding date

Source: structure by author

Table 2: *Sections of qualitative questionnaire*

The questions generated by the author are pre-tested for logical consistency and unambiguity with seven managers holding leadership positions in startup-accelerators, venture capital firms and entrepreneurial consulting in the startup-environment as well as two academic marketing experts. In preparation for the interview, the author researched the financial background data if available on the firm and the founder or CEO who would be the interview partner. For cost and time reasons, the interviews are mostly held via skype. The consent of the participant and the technical setup provided, the interviews are video conferences and taped so the author is able to transcribe them for further analysis.

## RESULTS

The interviews varied very much depending on the level of knowledge and affinity towards marketing of the respondents. The values and perceptions of the founders are significantly shaping the organizational development and strategy of the firm. The founding team, their values and personalities have a major impact on decisions regarding marketing capabilities. Decisions on which capabilities to focus on and which marketing activities to pursue are significantly influenced by the founders' competitive orientation, risk-taking and innovation-capabilities. All founders interviewed confirmed the importance of marketing capabilities. However, they were in different stages in the development of

these capabilities. Every firm had already created a brand, even if it was only preliminary and had developed first marketing capabilities. Below, the developments are described in detail.

#### *Customer-oriented marketing capabilities*

Every founder who has been interviewed holds a perception of their customers and their needs. However, not all hold the same level of detail and some are only based on assumptions. Firms of which the founders had been previously working in the industry or had in-depth experience in the field the firm is operating in are defining their products for a clearly segmented and defined customer-base or in case of firm L several customer-personas. Given the often limited resources and budget, it was even recommended to focus on a very small and specific target audience in the beginning, because it is linear and homogenous in their interests and therefore easier to identify and market to. The founder of firm D indicated that the customer-base of his company changed over time and described that they had different requirements to his service and subsequently the marketing capabilities. Same was confirmed by several founders, who explained that they were adapting the product based on customer feedback. This finding confirms previous findings on small firms, which have been found to build their innovation capabilities directly through feedback from consumers because they more directly interact with them than bigger firms (Merrilees et al., 2011, p. 374). These learnings clearly indicate that in terms of strategic customer-oriented marketing capabilities, young firms start by identifying a customer need, very often in their immediate environment and then develop it through further customer feedback, very often in direct interaction with customers. The firms also use this direct interaction to build trust and relationships with potential customers and existing customers. Even though customer feedback has been indicated as important factor for the founders, the generation of feedback is mainly qualitative and unstructured. Sources are direct selling activities, contact with customers who bought or used the product or service or social media feedback from internet platforms such as Facebook. Only three firms (D, F and K) had systematic structures or regular cycles of generating user feedback for example through focus groups or customer surveys. To the contrary, two firms (G, J) even reported difficulty in generating quantitative direct feedback from customers for example through surveys. These sources are also suggested by literature for young firms. However, the use of sources like government agencies, trade associations, or similar associations as indicated by literature (e.g. Alvarez & Barney, 2010, p. 563), was not applied by the interview partners. However, whenever possible, all firms tracked user behavior to generate knowledge to further develop their products and services. Since the product is still in the product or service prototyping phase or produced / provided in small quantities, the firms are still very flexible in adjusting their differentiation towards competitors, even re-defining the market they were operating in. For example, the service of firm F was first conceptualized for the market of consumer electronics instead of baby products. The firms are still very focused on the development and

specification of their product / service. Even firms that were older like A (founded in 2008) and E (founded in 2011) were still optimizing their service and product and worked on customizability and differentiation towards competitors based on customer feedback. Based on these findings, it is clear that functional customer-oriented marketing capabilities are still in development. However, as previously mentioned, there is not so much need for systematic interaction with customers or CRM because there is a lot of direct interaction with the target audience, topic of the interaction mainly being the product / service.

When looking at the development of measurable indicators for customer-oriented marketing capabilities on the strategic and functional level, the following definitions can be derived:

Strategic Customer-Oriented Marketing Capabilities: The anticipation of customer needs and requirements are seen as clear advantage and the development of customer responsiveness is an objective. This goes in line with findings of previous research (e.g. Hooley et al., 2005, p. 26) and therefore needs to also be included as item in the assessment of these capabilities for young firms. To cover the strong customer-oriented mindset and strategic generation input of customer feedback throughout the organization, it is most appropriate to adapt a reduced version of the customer-oriented selling construct of the Selling Orientation - Customer Orientation Scale from Saxe and Weitz to cover these strategic customer-oriented marketing capabilities. It includes and summarizes all relevant components applied by the other customer-oriented strategic constructs (Saxe & Weitz, 1982, pp. 345–346). It has been widely used and adapted in literature for the analysis of strategic customer-orientation in marketing (e.g. Homburg, Wieseke, & Bornemann, 2009; Ramaswami et al., 2009; Bagozzi et al., 2012). This construct reflects the previously described direct contact with the customer and the capabilities required in the early stages of young firms. The benefit of this construct is that the items are focusing on the direct interaction between the firm and the customer and it also includes components that are measuring the relationship between the customer and the firm. Both are important for young firms to be successful and the main characteristics of customer-oriented marketing capabilities at that age.

Functional Customer-Oriented Marketing Capabilities: The main part of functional customer-orientation for young firms is the ability to understand the needs of the customers and to adjust and customize the products based on the needs. This goes in line with the findings in literature on the general functional customer-oriented marketing capabilities. (e.g. Hooley et al., 2005, p. 20; Song et al., 2007, p. 21). It was also found that the development of high quality products can contribute to a positive reputation-development especially for new firms (Petkova, Rindova, & Gupta, 2008, p. 328). These product-related factors have also been described by the interviewed founders as the main items of functional customer-orientation. The firms are still developing their products and services and are



seeking for customer-input to develop them and product-related capabilities are highly relevant to them. There is still no clear definition of customer needs and the firms have to react quickly to the changing market environment. Therefore, product management and differentiation capabilities such as the capability of the firm to provide a valuable, unique, in-imitable and un-substitutable product or service to the customer and to use the feedback generated to improve the product as well as the ability to develop the product faster than competitors, are key functional capabilities in customer-orientation for young firms in this phase and have to be included in the assessment. These factors can be evaluated through the scale for product uniqueness developed by Steensma and Corley (Steensma & Corley, 2000, p. 1067). The author has identified this scale as one of the most suitable scales for young firms to assess the functional components of the customer-oriented marketing capabilities in her empirical research. This concise scale not only provides measures on the customer-oriented marketing capabilities of product management. but it also puts them into competitive perspective.

#### *Brand-oriented marketing capabilities*

The topic of brand and branding was perceived very differently by the different founders. The term brand and brand-oriented capabilities were described and explained very differently by the several the founders. According to their records, they had all created a brand that was clearly differentiated based on the market characteristics of their product or service and the identified potentials. The level and depth of this strategic brand-orientation varied very much between the firms: Some founders defined brand as name and color of the logo (founder I), others defined it as key differentiator (founder D) and some as personality (founder L). Even though they were very articulate about their product / service and its' benefits, the majority of the respondents could not clearly describe the values their firm was standing for and how the differentiate in their positioning against competitors. This goes in line with the findings of other research in the field of startups and branding, which also highlighted this lack of clarity (Rode & Vallaster, 2005, pp. 125–126). The creation of the strategic and functional brand was described as an iterative process. Founder N mentioned that even though the theoretical steps were clear to her, she wasn't able to plan the process, because according to her experience, it develops over time and in cycles of evolution. Some founders approached these strategic brand-oriented activities very consciously and integrated it in their business strategy whereas others relied more on their intuition. Especially experienced founders, who had been previously working in the industry or founded firms before, are using their strategic brand-knowledge to differentiate the brand and conduct marketing tests. Based on the learnings gathered, adjust their brand strategy. Four of the fourteen brands had already undergone re-branding. Founder D even stated that he is redefining and readjusting his brand strategy on a regular basis. The marketing capability of pricing was mentioned by

some of the founders as differentiator and they tested different pricing- and payment-models. Firm H even defined their new pricing model as one of their key differentiators, offering their services on a subscription-basis in comparison to the single-payment models used by competitors. Also specific channel strategies were integrated in the branding strategy. Firm G for example leverages their B2B customers as multipliers for their service and their brand. The founder of firm E also stated that since he did not have a product to show yet, the capability of branding, including strong values, a clear brand personality, the understanding of the competitive environment and a clear concept for a pricing and channel strategy is helping to sell the idea of the product to investors and other stakeholders such as strategic business partners. In terms of functional brand-oriented marketing capabilities, the name was described as the most important element of the brand. Other functional brand elements such as design varied based on the product or service. Founder B stated that a professional logo and website can make the company look professional, representative and bigger. This was also confirmed by the reports of founder K, who also mentioned strong branding guidelines and consistency in communication as main factor of success. However, the creation of the name is the central and main element of the functional brand. Important criteria for a successful brand name were a descriptive character, distinctiveness, memorability and a clear indication of the benefit of the product / service. These criteria were also identified by other researchers (e.g. Aaker, 1991, p. 196). Founder A and founder K stated that their name represented their services functionality and was well-understood, which helped a lot in becoming successful. This feedback is similar to findings in previous studies (e.g. Kohli & La Bahn, 1997, p. 69). The name of the service and website of firm F is close to the name of one of its' competitors and it is pronounced in the same way. He reported this to be a disadvantage, because customers confuse his service and the service of the competitor. Also, promotion through recommendation via word of mouth is not easy if the name is not clearly spelled. Another important factor that was described by almost all founders when choosing a name is the availability of the web address of the name to ensure that marketing activities promoting the brand did not lead people to find the wrong page in the internet. This has also been identified as important factor in other research (Bresciani & Eppler, 2010, p. 359). The emotional value of a brand was described by founder L, who said that they changed their name to evoke different emotional reactions and perceive the brand as more personal and less functional. The ideal brand name for founder G was to have name which could also be used as verb (e.g. google is used as googling). The identification of the right name is an iterative but non-structured process spent significant time in finding a name.

When looking at the development of measurable indicators for brand-oriented marketing capabilities on the strategic and functional level, the following definitions can be derived:

Strategic Brand-Oriented Marketing Capabilities: For the development of the strategic brand-oriented marketing capabilities, it is crucial to understand the market conditions as well as the potential for differentiation of the own brand. Therefore, founders who had previous experience in the industry of their startup, described this knowledge as clear advantage. Many pathbreaking decisions regarding the strategic setup of the brand are made in the early stages of the firm: how does the firm want to present itself, which values it stands for, what the personality is and what benefits it wants to communicate. Brand-orientation plays a key role in shaping the business model. Very often at this stage, a rather narrow interpretation of branding as just being the brand name and logo is exhibited (e.g. Wong & Merrilees, 2005, p. 157). However, it is of essence, that in the early stage of development, the firm exhibits strategic capabilities such as an understanding of the market and its' characteristics, determines differentiation characteristics for the service or product, develops a pricing strategy and a communication channel strategy in order to be successful. Based on these findings for young firms, the author decided to draw from the "Marketing Proficiency" indicator created by Song and Montoya-Weiss (Song & Montoya-Weiss, 2001, p. 79). It summarizes an elaborate set of capabilities, which cover the main factors of strategic brand management also for young firms and therefore the author sees it as adequate measure use to assess brand-oriented strategic marketing capabilities.

Functional brand-oriented marketing capabilities: In terms of functional brand-oriented marketing capabilities, the name of the product or service is the most important element of the brand at this stage of the firm. Other brand elements such as design varied very much in development amongst the different young firms. Other functional brand-oriented marketing capabilities mentioned by authors in the previous literature reviews, such as marketing programs, advertising initiatives and the selection of appropriate marketing channels, were not (yet) seen as important factors. Young firm are still in the process of developing functional brand-oriented marketing capabilities. In most cases, brand guidelines are not developed and marketing planning and communication are not developed yet. Also financial constraints are limiting marketing activities and subsequently the development of capabilities in this field (e.g. Bresciani & Eppler, 2010, pp. 359–361). The brand name is the first functional element of a brand that most firms develop. It is also the most important element of the brand and the most difficult to change. Based on these findings, the author has identified naming-related criteria as best indicators for the assessment of functional brand-oriented marketing capabilities. As base for the scale, the items used are based on the indicators defined by Aaker about successful brand naming (Aaker, 1991, p. 196). The scale has been enhanced by the inclusion of the requirement regarding the availability of the web-address (URL) which have also been confirmed by the founders in the interviews and the potential of the name to be "verbalized" (e.g. google => googling). The identification of the right name is an iterative but non-structured process spent significant time in finding a name. Due to its' significant importance,

the author decided to put a focus on naming for the analysis of functional brand-oriented marketing capabilities.

### *Business performance*

The indicators for business performance mentioned in the interviews varied by founder based on the stage of the firm and the complexity of the market environment. The youngest firms, which were still in the stage of conceptualizing their products or services, measured their performance in terms of the relationships they were establishing with opinion leaders. For the firms that were already in the development of their product, market adoption was stated as crucial topic. Therefore, another popular measure, which was used by the majority of the founders interviewed, was the number of customers using the service and returning customers. For some firms in the early stages, the usage of the product or service is more important than financial performance and it is offered to potential customers without payment or at a reduced price. This indicator of usage or trial as indicator for business performance is common and rather specific for young firms and not as common in other research assessing performance in relation with capabilities. Based on these findings, the author decided to include the usage of the product or service and the purchase of the product or service in the construct of business performance. Finally, most firms reported to use revenue, profit and indicators for market adoption to measure business success. Since numbers are still small, they often look at growth rates more than actual numbers and are also focusing on returns. Regarding the specific measurement of the impact of the brand and marketing activities, most founders reported that the effort for measuring the success was too high at this stage of the organization. Therefore, most firms also indicated that they turned to business performance indicators to measure the performance of their marketing efforts.

When looking at the development of measurable indicators for business performance, the author has decided to measure organizational effectiveness based on business performance. The assessment of business performance is therefore composed of two sets of items, financial performance and product market performance.:

Financial performance: As identified in qualitative research, there is no specific differentiation for the measurement of financial indicators for young firms. The author therefore turned to the widely used and renowned financial performance scale from Gupta and Govindarajan (Gupta & Govindarajan, 1984, p. 34), which includes a broad spectrum of financial measures and covers the most relevant performance measures and has been preferably adapted in SME-research. The indicators covered include all measures mentioned in the interviews and range from sales levels to the ability to fund business growth from profits.

Product market performance: The number of customers engaging with the product or service is seen by many start-ups as early indicator for future performance. Getting customers to test the product or service and use it is very important for young firms to generate first trial and confirm customers into paying customers. Therefore, the author has decided to include market effectiveness measures based on the concept of Vorhies and Morgan (Vorhies & Morgan, 2005, p. 92) and the measures used by managers to assess marketing-related activities (Mintz & Currim, 2013, p. 20) as indicators for product market performance. These measures for business performance include number of customers using the products without payment and the number of returning customers without payment. Finally, the number of buyers as well as repeat buyers are also included in this indicator.

Another observation to be mentioned for the assessment of the development of marketing capabilities is the role of the founders in the development of the firm. Their values and perceptions are significantly shaping the priorities and the strategic setup of the firm. The decision, which capabilities to focus on and which marketing capabilities to acquire and develop, is significantly influenced by the founders' competitive orientation, risk-taking and innovation-capabilities (e.g. Covin & Slevin, 1989). Therefore, when modeling customer- and brand-oriented marketing capabilities for young firms, it is important to consider this factor of strategic posture in the assessment. There is a substantial body of research, dedicated towards the characteristics of strategic posture. The concept of strategic posture by Covin and Selvin is a commonly used measure for the competitive orientation of the firm (Covin & Slevin, 1989, p. 75). It is defined by the way management addresses innovation, their motivation to take risks for their business and how proactive they are in addressing development. To ensure that this special situation of founders and young firms is reflected, the author recommends to introduce the concept in the assessment of business performance, which moderates the relationship between marketing capabilities and business performance.

## DISCUSSION

Depending on the stage of development in the life cycle, firms are confronted with different requirements and challenges in regards to the development of their capabilities. Young firms are facing special challenges in the establishing of capabilities while they are still developing their strategy and their organization. Marketing capabilities are amongst the key capabilities to drive business performance and need to be developed already early in the beginnings of the firm. The effect of management attitude and the underlying strategic assumptions about the market on the development and the focus of marketing capabilities cannot be underestimated. The results of the interviews show that founders are well aware of the importance of marketing capabilities. However, the knowledge about and professionalization of these capabilities varies in between firms. The development of

customer-oriented marketing capabilities is very often based on the experience of the founders in the industry. Feedback is mainly gathered through personal interaction with customers and there is no systematic process for input. There is a very strong focus on product-development, which is also reflected in the focus of functional customer-orientation. Based on these findings, it can be clearly stated, that customer-oriented marketing capabilities are acquired and developed differently in young firms in comparison to older firms. Also the focus of brand-oriented marketing capabilities in young firms is slightly different. Since the functional brand is not yet defined, naming and the creation of corporate design are most prevalent. The identification of the right name is an iterative but non-structured process spent significant time in finding a name. The development of other brand elements and brand guidelines varied very much between the firms. One more thing to highlight is that besides the criteria of name clarity and distinctiveness, the suitability for internet-usage (e.g. no other users of the keyword) needs to be considered. The concept of a brand itself and the level and depth of strategic brand-orientation varied very much between the firms. Depending on their brand-orientation and knowledge, the brands were at different stages of development. Brand differentiation and testing is highly relevant at that stage to generate valuable learnings for the next stage of development. As previously described, managers of young firms have to be innovative and open to innovation, proactive and embrace risk-taking to ensure the success of their firm. This also holds true for marketing capabilities. The development of customer- and brand-oriented marketing capabilities is an iterative process and the capabilities need to be constantly assessed and adapted to the new challenges of the firm.

## CONCLUSIONS

This paper makes a contribution to the understanding of the development of marketing capabilities in young firms. It adds to existing knowledge by further exploring the concept of life cycle development in regards to the Resource-Based Theory and its' definition of capabilities. Limitations of the study include the focus on only the development of marketing capabilities. Other capabilities which are closely connected to marketing capabilities such as research and development or innovation are not considered. Also, the focus of the research is on the internal view of the firm and the external environment and the market are not considered. The use of a qualitative method represents another limitation, which does not allow for generalization. In a next step, these findings need to be quantified. The novelty of this research lies in the analysis of marketing capabilities which are specifically important for young firms and how founders develop these capabilities. It adds to existing literature by investigating if the customer- and brand-oriented marketing capabilities deemed necessary, also apply to the specific situations of firms in the early stages of development. Since

marketing capabilities are a key driver to provide strong sustainable economic value, it is important for young firms to develop them early on to support them in their different stages as competitive advantage.

## REFERENCES

- Aaker, D. A. (1991). *Managing brand equity: Capitalizing on the value of a brand name*. New York, Toronto, New York: Free Press; Maxwell Macmillan International.
- Alvarez, S. A., & Barney, J. B. (2010). Entrepreneurship and Epistemology: The Philosophical Underpinnings of the Study of Entrepreneurial Opportunities. *Academy of Management Annals*, 4(1), 557–583. doi:10.1080/19416520.2010.495521
- Bresciani, S., & Eppler, M. J. (2010). Brand new ventures? Insights on start-ups' branding practices. *Journal of Product & Brand Management*, 19(5), 356–366. doi:10.1108/10610421011068595
- Buttenberg, K. The classification of customer- and brand-oriented marketing capabilities. *Transnational Marketing Journal*, 3 (1), pp. 26 - 44 ISSN: 2041-4684
- Day, G. S., & Fahey, L. (1988). Valuing Market Strategies. *Journal of Marketing*, 52(3), 45–57. doi:10.2307/1251449
- Gilmore, A., Carson, D., O'Donnell, A., & Cummins, D. (1999). Added Value: A Qualitative Assessment Of SME Marketing. *Irish Marketing Review*, 12(1), 27–35. Retrieved from <http://search.proquest.com/openview/f54bebd494ced5067e19eb5668619dfc/1>
- Gläser, J., & Laudel, G. (2006). *Experteninterviews und qualitative Inhaltsanalyse als Instrumente rekonstruierender Untersuchungen (2., durchges. Aufl)*. Lehrbuch. Wiesbaden: VS, Verl. für Sozialwiss.
- Kohli, C., & La Bahn, D. W. (1997). Observations: Creating Effective Brand Names: A Study Of The Naming Process. *Journal of Advertising Research*, 37.1(1), 67–75.
- Kozlenkova, I. V., Samaha, S., & Palmatier, R. W. (2014). Resource-based theory in marketing. *Journal of the Academy of Marketing Science*, 42(1), 1-21. doi:10.1007/s11747-013-0336-7
- Lievens, F. (2007). Employer branding in the Belgian Army: The importance of instrumental and symbolic beliefs for potential applicants, actual applicants, and military employees. *Human Resource Management*, 46(1), 51–69. doi:10.1002/hrm.20145
- Merrilees, B., Rundle-Thiele, S., & Lye, A. (2011). Marketing capabilities: Antecedents and implications for B2B SME performance. *Special Issue on Industrial Marketing Strategy and B2B Management by SMEs*, 40(3), 368–375. doi:10.1016/j.indmarman.2010.08.005
- Miller, D., Droge, C., & Toulouse, J.-M. (1988). Strategic Process And Content As Mediators Between Organizational Content And Structure. *Academy of Management Journal*, 31(3), 544–569. doi:10.2307/256459
- Rode, V., & Vallaster, C. (2005). Corporate Branding for Start-ups: The Crucial Role of Entrepreneurs. *Corporate Reputation Review*, 8(2), 121–135. doi:10.1057/palgrave.crr.1540244
- Rust, R. T., Ambler, T., Carpenter, G. S., Kumar, V., & Srivastava, R. K. (2004). Measuring Marketing Productivity: Current Knowledge and Future Directions. *Journal of Marketing*, 68(4), 76–89. doi:10.1509/jmkg.68.4.76.42721
- Saxe, R., & Weitz, B. A. (1982). The SOCO Scale: A Measure of the Customer Orientation of Salespeople. *Journal of Marketing Research*, 19(3), 343–351. doi:10.2307/3151568
- Sinkula, J. M. (1994). Market Information Processing and Organizational Learning. *Journal of Marketing*, 58(1), 35–45. doi:10.2307/1252249
- Sirmon, D. G., Hitt, M. A., Arregle, J.-L., & Campbell, J. T. (2010). The dynamic interplay of capability strengths and weaknesses: investigating the bases of temporary competitive advantage. *Strategic Management Journal*, 31(13), 1386–1409.
- Srivastava, R. K., Shervani, T. A., & Fahey, L. (1998). Market-Based Assets and Shareholder Value: A Framework for Analysis. *Journal of Marketing*, 62(1), 2–18. doi:10.2307/1251799
- Tremblay, M.-A. (1957). The Key Informant Technique: A Nonethnographic Application. *American Anthropologist*, 59(4), 688–701. doi:10.1525/aa.1957.59.4.02a00100
- Urde, M., Baumgarth, C., & Merrilees, B. (2013). Brand orientation and market orientation — From alternatives to synergy. *Journal of Business Research*, 66(1), 13–20. doi:10.1016/j.jbusres.2011.07.018
- Weerawardena, J. (2003). The role of marketing capability in innovation-based competitive strategy. *Journal of Strategic Marketing*, 11(1), 15. doi:10.1080/0965254032000096766
- Weissenberger-Eibl, M. A., Frietsch, R., Hollanders, H., Rammer, C., & Schubert, T. (2013). *Innovationsindikator 2013*. Karlsruhe: Deutsche Telekom Stiftung.

## TOWARDS A LIFE-CYCLE MODEL OF INTER-FIRM NETWORKS: PHYSIOLOGICAL AND PATHOLOGICAL PATH OF EVOLUTION

Cantele, Silvia; Vernizzi, Silvia

Department of Business Administration, University of Verona, Italy

### ABSTRACT

This paper presents a model of a network life cycle based on the literature on network and alliance evolution. Although networks are considered strategically relevant to firms' success, particularly in a context of small businesses, many studies have reported a high failure rate of inter-firm cooperation strategies. The literature on whole networks has mainly been devoted to network structures, governance and outcomes, whereas longitudinal studies on network evolution and critical factors leading to untimely termination are scant. Starting from these premises, this paper describes the first part of a more comprehensive research project aimed at defining the critical issues that occur in each stage of a network life cycle, by matching different literature streams (network evolution and life cycles, network termination) with subsequent empirical investigations into business network contracts drafted following a specific regulation introduced in Italy in 2009.

Through an analysis of the first stream of literature, we propose here a life-cycle model comprising the following stages: formation, operation, performance evaluation, consolidation and decline. These stages belong to what we call the "physiological life cycle", and each stage can result in a "pathological pathway" determined by specific critical factors that can undermine the successful evolution of the network. The whole research project provides a theoretical contribution to this specific stream of research, as well as relevant managerial implications, by describing and testing the main issues that a network manager should be ready to face in the dynamics of network operations.

*Keywords: networks, inter-firm network, business network, network life cycle, network evolution, network termination, strategic alliances, business network contract.*

### INTRODUCTION

Network relationships are often strategic for the success of firms, especially small businesses, which usually face resource and knowledge constraints. The literature on networks is vast and focused on various topics, such as the structure of relationships, the governance of networks and the prospective outcomes for member firms (Provan *et al.*, 2007). In this paper, the perspective chosen is that of inter-



firm networks, namely, networks created among firms, and the level of analysis is the network itself. The idea is that a formalized network is an institution separated from its partners that has its own life and evolution in a context that can be conceptually isolated, even if it experiences influences from the macro level (the environment) and the micro level (single-partner firms). The paper is part of a more comprehensive research stream starting from the emergence of a new form of organization, the “business network contract”, created in Italy by a specific regulation in 2009.

Previous studies conducted on this topic have revealed the strategic factors affecting the success of this kind of network (Cantele and Vernizzi, 2014; Cantele *et al.*, 2016) and the impact of network relationships on firm performance (Cantele and Vernizzi, 2015, 2016).

The Italian experience appears to be successful, considering the increasing number of contracts that have been drafted since the regulation came into force. At the end of 2011, the number of contracts drafted was 214, with 1,065 firms engaged; by April 2017, 3,588 contracts had been drafted, involving 18,079 firms.

However, some studies assert that cooperation strategies such as alliances have a high rate of failure, thus challenging the shared idea of their critical relevance through evidence of the difficulties of carrying on such relationships with effective outcomes (the “alliance paradox”, Kale and Singh, 2009). Consequently, studies on inter-firm networks are increasingly expected to describe their evolutionary pathway through longitudinal studies (Provan *et al.*, 2007), which can capture the dynamics of networks and the risk they face in the different stages of their lives. The main implicit risk is ending cooperation without attaining the strategic purposes for which the network was created.

This paper is aimed at defining a theoretical framework based on the literature on networks and strategic alliance dedicated to life-cycle models and evolutionary pathways; the idea is that networks and strategic alliances undergo an evolution through stages similar to the life cycle, a model already used at the product, firm and industry level. Instead of describing the antecedents or success factors broadly studied in the literature (Christoffersen, 2013), the focus is on critical factors that can prevent the network from following its physiological path of evolution, leading to the untimely termination or stagnation of relationships.

The first part of the project is presented here, with an analysis of the (scant) literature on network life cycles or network evolution, and a first theoretical contribution in terms of defining the stages as well as a preliminary recognition of the main aspects considered critical because they can prevent positive network dynamics.

## NETWORK LIFE-CYCLE MODELS

The literature on networks has considered different forms of evolution and change, which are useful for understanding network forms of cooperation from a dynamic perspective.

Some authors describe the evolution of networks (or similar inter-organizational forms of cooperation, such as strategic alliances) in terms of stages in a life-cycle model. The life-cycle model was first introduced by Alfred Chandler in 1962 to describe the development and growth of organizations over time. If we consider networks higher-level institutions separated by the firms they connect, it is possible to hypothesize similar stages in their lives.

Wegner et al. (2015) analysed 28 small-firm networks in Brazil and proposed a life-cycle model based on three main stages: birth and formalization, development and consolidation, and decline and eventual closure. They analysed the literature and interviewed experts to arrive at a shared vision of stages in the life cycle. They also defined some dimensions for understanding which of the following stages a network has reached: engagement/commitment; governance; information exchange; management; process and routines; service portfolio offered by the network; and trust. Among the critical factors that led to termination, from the qualitative analysis, they identified the following: work overload on a small number of members in charge of organizing activities, lack of commitment from many participants (which reduced the remaining members' motivation), differing business profiles among network members, insignificant outcomes from collaborative strategies, dependency of the small-firm network on the public program and a lack of continuity in the consulting support that it offered. To counter these factors, they suggested implementing higher managerial efforts; creating a managerial structure (such as a network manager); and cooperating with other networks to increase scale and cost sharing and larger networks, because the smallest were usually weak.

Ahlström-Söderling (2003) presented a longitudinal case study of a small-firm network in the wood-manufacturing industry in Sweden. He described the evolution of the network in terms of a "living" system encompassing three main phases: formative, normative and integrative. The normative phase can be divided into two parts so that four stages emerge, including two relevant dimensions of relationship orientation and task orientation. The first stage (formative) is characterized by high levels of relationship and task orientation: in this phase, entrepreneurs are connected with strong ties to define how their vision can be implemented. The first half of the second stage (normative) is characterized by high task orientation but a lower level of relationships: here, the network strives for maximization/optimization through increased standardization and formalization. In the second half of the second stage (normative), the focus is more on internal efficiency in the network, rather than on products and market; this phase is characterized by low task and relationship orientation. Finally, in the fourth stage (integrative), the relationship orientation increases (while task orientation remains

low). In the network, a new organization emerges with a renovated style of leadership and new firms emerging, and this leads to a renewal in the project, which defines the start of a new cycle.

Kale and Singh (2009) analysed strategic alliances and described them as increasingly relevant to competitive success but paradoxically difficult to conduct in a successful manner so that they do not come to an end before reaching their aims. The life cycle of strategic alliances comprises three main stages: formation and partner selection, governance and design, and post formation alliance management. Each of these stages is characterized by critical factors that can lead to unsuccessful outcomes if they are not managed appropriately. In the formation stage, partner selection is critical: partners have to be complementary in terms of non-overlapping resources, compatible in terms of working styles and culture, and committed to supplying resources in the alliance but also to making short-term sacrifices to reach long-term alliance objectives. In the second stage, the governance of the alliance should be designed, with equity ownership or contractual provisions that clearly define mutual rights and obligations. However, governance also comprises some soft components, referred to as relational governance, such as trust and reputation. Finally, in the alliance management, it is important to establish coordination mechanisms, such as programming, hierarchy and feedback; in this phase, major stress is placed on the development of trust, which many studies indicate is a critical success factor because it helps partners to work more cooperatively. If these are the drivers of strategic alliance success through their different stages, it is important to work on building blocks of alliance capabilities in firms. From this point of view, the main suggestions of the authors are to have prior alliance experience; create a dedicated alliance function; and implement firm-level processes to accumulate and leverage alliance management, know-how and skills within the firms.

Kumar (2014) presented a life-cycle model of strategic alliance based on three main stages: formation, operation and outcome. In the formation stage, the allying firms engage in the task of negotiating the contract. In the operation stage, the partners begin to implement the negotiated agreement. The outcome stage gives the partners the opportunity to assess the alliance performance. Each of these stages is characterized by specific ambiguities, which require appropriate management to avoid critical factors leading to alliance termination. In the formation stage, the main risk is partner ambiguity, which refers to the suitability and appropriateness of partners, in terms of complementarity, compatibility and commitment. In the operation phase, the ambiguity usually involves process discrepancies, which means that partners are not interacting with each other effectively because of different factors such as opportunistic behaviour, cultural clashes, fairness concerns and inadequate managerial mechanisms. In the outcome stage, evaluative ambiguity refers to the decision to persist with the alliance when it is experiencing an unfavourable outcome discrepancy (the alliance is not meeting its expected goals); in this case, the discrepancy in outcomes could stem from environmental volatility or problems in the

alliance, and could also reflect unrealistic or divergent expectations for the alliance. The author suggests precise managerial strategies to cope with these ambiguities and their characteristic occurrence, which could compromise the evolution of the alliance through its life-cycle stages.

Jap and Anderson (2007) considered inter-organizational relationships and used two different theoretical frameworks to describe the life cycle and the development of relationships. There are five or six stages in the life cycle: (1) awareness of the possibilities another organization presents, (2) exploration, (3) expansion (build-up), (4) maturity, (5) decline and (6) eventual dissolution. Their hypothesis relates to the idea that some relationship properties are low in exploration, higher in expansion, highest in maturity and lowest in decline; these properties are goal congruence, information exchange norms, relationship harmony, overall dependence of the parties on the relationship, idiosyncratic time investments by one side, idiosyncratic adaptation investments of existing routines by one side, bilateral idiosyncratic investments, the organization's trust in other organizations, the organization's willingness to take risks, the organization's outcome given the comparison level of alternatives, and the inverse of the number of seriously considered alternative partners. From their quantitative analysis, they found that these properties do not usually reach a zenith in the maturity phase, because the levels in this phase are similar to those of the build-up phase or lower. Some properties also follow a different pattern: information exchange norms and goal congruence reach their maximum level in the expansion phase rather than in maturity, when the lowest properties are usually in decline.

This first part of the literature analysis is based on the idea that networks evolve through certain predefined stages, similarly to what happens in biological life cycles. If each stage is characterized by some specific aspects, the risk of not evolving to the subsequent stage depends on the respective factors, and the effect of regression at any stage is stagnation and probable dissolution of the network.

## **NETWORK EVOLUTION WITHIN ITS EXTERNAL ENVIRONMENT**

Another branch of the literature is dedicated to network evolution, and aims to describe the possible patterns of change without referring to predefined and consecutive stages such as in a life-cycle model. In these studies, the evolution of networks is usually described with reference to the industry (Valdaliso *et al.*, 2016), the environment (Koka *et al.*, 2006), the relationship with other networks (Lin *et al.*, 2010) or the technology life cycle (Codini, 2015; Suire and Vicente, 2014), or the relationships entered into by the firm along its life cycle (Hite and Hesterly, 2001; Strobl and Kronenberg 2016).

Valdaliso *et al.* (2016) examined six clusters in the Basque region by tracing their possible evolutions within the industry to which they belonged. The industry evolves through a life-cycle model comprising three main stages: an embryonic stage with small output; a growing stage; and a mature

stage, with a decline in the number of companies and employees. By combining the industry and cluster evolutions, four scenarios are defined: adaptation/renewal, when both industry and cluster are developing; sustainment and maturity, when both are not changing noticeably; transformation, when the industry is not evolving but the cluster is; and lock-in and decline, in the case of a cluster not evolving in the context of industry development. The contribution of the article lies in its evidence that clusters do not necessarily evolve in line with their industry, and the driving factors behind cluster evolution are the cluster's knowledge base, social capital and public policies.

Koka *et al.* (2006) proposed a framework of four patterns of network change, depending on certain environmental characteristics. The two environmental dimensions analysed are uncertainty and munificence. Environmental uncertainty has been defined as the inability of a firm's managers to "accurately assess the external environment of the organization or the future changes that might occur in that environment" (Dickson and Weaver, 1997, p. 405), and munificence refers to the extent to which resources available to a firm are plentiful or scarce, after taking into account the number of firms competing for those resources (Anderson and Tushman, 2001). Munificence is also an index of the capacity (Dess and Beard, 1984) of the environment to support the firm and its strategies. Four environmental scenarios are possible by considering the matching of increases or decreases in the two considered dimensions (uncertainty and munificence). The evolution of networks can be defined with reference to their creation or deletion, and portfolio size and range, and is labelled consistently with each scenario: network shrinking (decrease in uncertainty and munificence), network churning (increase in uncertainty and decrease in munificence), network strengthening (decrease in uncertainty and increase in munificence) and network expansion (increase in uncertainty and in munificence). The patterns of change do not only depend on environmental evolution because their scope is moderated by the strategic orientation of the firm.

Lin *et al.* (2010) referenced the patterns of network change (Koka *et al.*, 2006), but introduced a third dimension of change determined by relationships with other networks, such as inter-network co-evolution which is the simultaneous changes and developments in networks (the selection, retention and variation of network actors) caused by the interactions between networks that are linked by technology and institutional ties. It is necessary to consider all the levels involved when studying networks: the macro level refers to network-environment relationships, the meso level to the single network and the micro level to each firm participating in the network. The idea is that changes occur both from the top down (mainly through institutional ties) and from the bottom up (mainly through technology ties).

Other authors have analysed the impact of technology on networks and clusters. Suire and Vicente (2014) studied clusters and their resilience, such as the ability to develop by disconnecting their life

cycle from those of the technology they produce, and Codini (2015) analysed the evolution of network relationships during the different stages of the technology life cycle, in terms of different categories of stakeholders, which are revealed as fundamental in passing through these stages.

When networks are perceived as a combination of different relationships in which a firm engages in its operating activity, it is possible to analyse how these relationships evolve along the whole firm life cycle within its specific stages.

Hite and Hesterly (2001) analysed the evolution of networks (relationships with different actors created to obtain legitimacy and consensus) within the first stages of a firm (emergence and early growth) and found that the networks tend to evolve from being “identity-based”, when some type of personal or social identification with the other actor motivates or influences economic actions (Granovetter, 1992; Uzzi, 1996), to being a “calculative network” (Williamson, 1993), that is, an egocentric network in which the focal actor’s ties are primarily motivated by expected economic benefits. This evolution is led by three main evolutions. The first is from embedded ties (relationships characterized by trust and reciprocity) to arm’s-length ties (relationships based on impersonal ties, motivated by self-interest). The second is from cohesion to bridging structural holes, which means passing from a dense mutual network to a network useful to connect firms that would not be connected otherwise). The third transformation is from path dependence to an intentionally managed network, which outlines the change from pre-existent social networks of the entrepreneurs to new relationships in which the firms try to gain the new resources needed to operate.

When the single firm is the level of analysis, it is also possible to study how the network of relationships evolve in the whole life-cycle model of the firm. Strobl and Kronenberg (2016) presented a case of Alpine hospitality entrepreneurs and identified which relationships proved to be more relevant across the stages of existence or survival, success, take-off and resource maturity.

In a completely different context, Roloff (2008) described the life-cycle model of a multi-stakeholder network, in which stakeholders are defined “as groups or individuals who can affect or are affected by the solution to the problem addressed by the network” (Roloff 2005, p. 12). Even though this kind of organization (e.g., the UN Global Compact) is completely different from a business network, the stages described are useful in an approach where the network is, in general, a group of relationships among different people or organizations. The model describes how this group organizes the decision-making process to solve a “common problem” addressed by the network in seven stages: initiation, deliberation (comprising acquaintance, first agreement and second agreement), action (comprising implementation and consolidation) and, finally, institutionalization/extinction.

## **PROPOSED MODEL OF THE NETWORK LIFE CYCLE**

The literature on networks, strategic alliances and similar forms of inter-organizational cooperation has proposed various life-cycle models, based on the identification of a number of stages ranging from three to seven.

	Stages of the life cycle					
References	Preliminary	1	2	3	4	5
Wegner et al., 2015		Birth and formalization	Development	Consolidation	Decline	Dissolution
Dwyer et al., 1987		Awareness	Exploration	Expansion	Commitment	Decline/dissolution
D'Aunno and Zuckerma n, 1987		Emergence (of coalition)	Transition (to a federation)	Maturity	Critical crossroads	
Ring and Van de Ven, 1994		Negotiation	Commitment	Execution	Assessment	Discharge
Spekman et al., 1998	Anticipation and engagement	Valuation	Coordination	Investment	Stabilization	Decision
Zineldin, 2002		Discovery	Development	Commitment	Loyalty	
Ahlström-Söderling, 2003		Formative	Normative	Normative	Integrative	
Roloff, 2008	Initiation	Deliberation: acquaintance	Deliberation: first and second agreement	Action: implementation	Action: consolidation	Institutionalization/ extinction
Jiang et al., 2008		Partner selection	Structuring and negotiation	Implementation	Performance evaluation	
Kale and Singh, 2009		Alliance formation and partner selection	Alliance governance and design	Post formation alliance management		
Kumar, 2014		Formation	Operation	Outcome		
Valdaliso et al., 2016		Emergence	Growth	Sustainment	Decline	

Table 1. Different stages of life-cycle models presented in the literature

Table 1 synthesizes the analysed models, which differ in the number of stages and their definitions. Some proposals start the analysis of stages by including the preliminary activities carried out before formalization of the network (e.g., Spekman *et al.*, 1998; Roloff, 2008). As for the final stages, some models distinguish between decline and dissolution, or present a final “stabilized” structure stemming from the experience gained through the life cycle (e.g., institutionalization, stabilization). When strategic alliances are considered, a finale phase dedicated to performance evaluation or outcome definition is included. From this point of view, a network among organizations with common aims is

considered successful when it attains its objectives. Therefore, this is a necessary step towards further actions such as termination of the alliance rather than a restatement of new strategic purposes. The central parts of the models comprise a varied number of phases, from two to three. After a first stage of “formation”, when the network is not yet at operating speed, the second stage involves development or growth, and the third usually refers to maturity or consolidation.

Matching the different models found in the literature, we propose a network life-cycle model for business network contracts. In this case, the preliminary part of the network is already defined by the drafting of the contract, although some changes can occur, for example, in the participants’ firms (i.e., when a partner leaves or others join the network) or in the design and governance of the network, since the contract can contain only a general agreement without defining process specifics. The proposed model will be empirically tested on case studies of networks and encompass the different stages of the model in the second stage of the overall research project. The purpose of the future research is to describe the model in its phases, but also to define the critical aspects that hinder the evolution of networks through the different stages and lead to termination without successful attainment of the proposed aims.

The proposed stages are:

1. **Formation:** In this stage, the partners negotiate in more detail the purpose of the network, the governance structure, the management and organization of activities, the game rules and the task attributed to each, as well as the services offered by the network.
2. **Operation:** In this stage, activities and initiatives are implemented, the organization and management are tested and the first preliminary results are recognized. This is also the stage in which relational capabilities are put into action and the first problems or conflicts have to be solved within the network.
3. **Performance evaluation:** After a suitable period of activities, the output and outcomes of the activities are evaluated by the network members, to reach the crucial decision that leads to the definition of the fourth stage.
4. **Decline or consolidation:** If the performance evaluation is positive and the experience of relationships and problem-solving is good, the network is destined for consolidation. In this case, new strategic purposes are defined or the same are repropounded for future periods. If something goes wrong, it is highly probable that the network will decline and be closed.



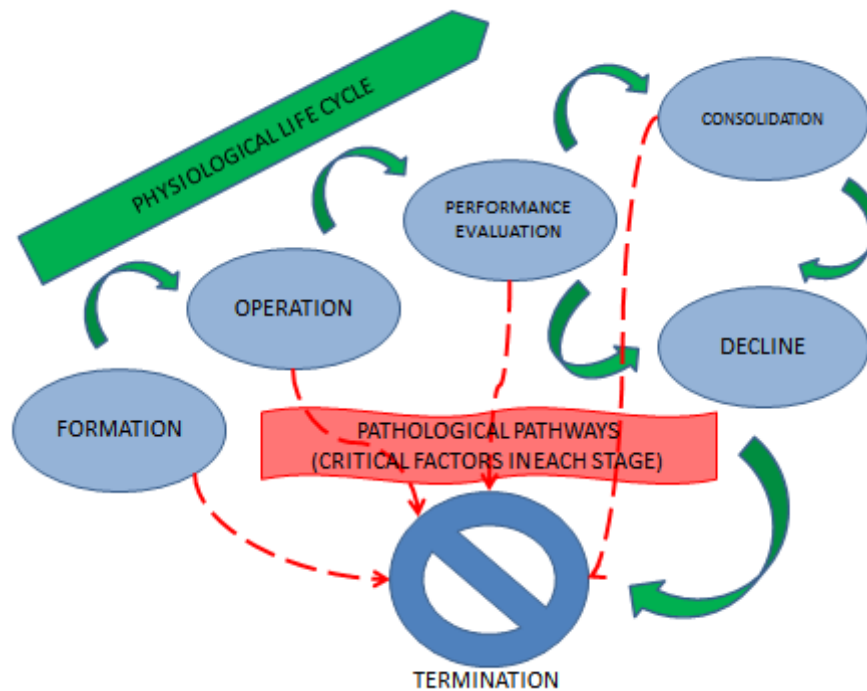

Figure 1. The proposed model of the network life cycle.

Figure 1 illustrates the proposed model, in which the physiological life cycle is described as the “normal” evolution through the stages of formation, operation, performance evaluation, consolidation and decline. Pathological pathways are deviations from the expected evolution, occurring when critical factors specific to each phase cannot be solved in a timely and reasonable way, leading to untimely termination, without reaching the planned strategic purposes of the network.

For example, in the formation phase, the critical factors highlighted by the literature are partner compatibility and complementarity or the absence of prior alliance experience (Kale and Singh, 2009), cultural clashes and the absence of prior relationships among participants (Kumar, 2014) or different business profiles (Wegner *et al.*, 2015). When these factors are present (from the beginning because they mainly refer to subjective features of the participants), it is likely that the network will never reach the operation regime, so the “pathological pathway” leads to termination or stasis already in the formation phase. Similarly, in the operation phase, other critical aspects can occur: lack of commitment (Kale and Singh 2009; Wegner *et al.*, 2015), a low level of information exchange (Jap and Anderson, 2007; Kumar, 2014), work overload for a few firms (Wegner *et al.*, 2015), low harmony and trust in the relationships (Jap and Anderson, 2007; Kale and Singh, 2009), and absence of governance or managerial mechanisms (Kale and Singh, 2009; Kumar, 2014). In this case, the termination or stasis will occur before a consolidated operation regime is attained, when the aims of the network would be actually pursued and the first results would start to be evaluated. In the performance evaluation phase, the critical factors are outcome discrepancies among firms, the fact of basing the assessment on unrealistic

expectations (Kumar, 2014), the discovery of low goal congruence (Jap and Anderson, 2007) or partner opportunism (Kumar, 2014), and the difficulties of keeping parties interested (Wegner *et al.*, 2015), probably because of different subjective perceptions of outcomes and of partner attractiveness (Jap and Anderson, 2007). In such cases, participants are not really able to assess the performance of their network participation in terms of the originally stated purposes, and so the pathological pathway is characterized by premature termination, occurring without the partners reaching a conscious shared decision to close a non-successful cooperation or to continue a fruitful one.

## CONCLUSION

This paper is a first step of a more comprehensive research framework, aimed at describing the risks of failure in inter-organizational cooperation in the context of an evolutionary model of relationships. In this paper, we selected and analysed the relevant literature on network evolution, starting from a life-cycle model that is usually used for single organizations but is here applied to second-level institutions (such as networks, alliances and other forms of inter-organizational structures).

Research on success factors is vast in the field of networks and alliances; nonetheless, several studies have suggested that all the kinds of inter-firm cooperation are often not as successful as they were hoped to be, with high failure rates of alliances described in several studies, leading to the so-called “alliance paradox” (Kale and Singh, 2009).

To evaluate the success of inter-firm cooperation, it is necessary to define performance at the network level (for a classification see Christoffersen *et al.*, 2014). From a generic definition of performance, we can assume that a network is performing when it reaches its strategic objectives. This usually requires an evolutionary pathway through which the network is formed, developed and consolidated with its tasks (the physiological life cycle in Figure 1). This means that when unfavourable circumstances occur (the critical factors in the pathological pathways in Figure 1), the evolution of the network through the proposed stages is put at risk, with a higher probability of termination before reaching the original purposes of the strategic cooperation.

From this point of view, unsuccessful outcomes can stem from early-stage termination (occurring during the life-cycle stages prior to physiological decline), or from a situation of stasis, in which the network exists but is not at all active.

Some critical factors have already been investigated in the articles dedicated to the management of networks or strategic alliances, and were partially presented in the previous section. These factors will be further analysed in the second part of the research project, by introducing at each stage critical factors that have been highlighted in another stream of literature, namely, that of network or alliance termination, and by adding insights from the empirical data collection, which is already under way by

means of interviews and focus groups with network managers and partners. The development of further studies could also benefit from longitudinal case studies in which network evolution pathways could be observed during their complete life cycles.

However, this research has already provided some relevant managerial recommendations through its descriptions of the pathological pathways that network managers have to avoid to ensure the long life and above all successful existence of networks. It may also be useful to policymakers in defining what kind of support is really needed, for example, probably not fountain financing, but rather specific training dedicated to enhancing soft skills and managerial competencies among network partners.

## REFERENCES

- Ahlström-Söderling, R. (2003), "SME strategic business networks seen as learning organizations", *Journal of Small Business and Enterprise Development*, Vol. 10 No. 4, pp. 444–454.
- Anderson, P. and Tushman, M.L. (2001), "Organizational environments and industry exit: the effects of uncertainty, munificence and complexity", *Industrial and Corporate Change*, Vol. 10, pp. 675–711.
- Cantele, S. and Vernizzi S. (2014), "Antecedents and critical success factors in contractual networks: new insights from Italian case studies", in 7th Euromed Conference Book of Proceedings, Kristiansand, September 18-19, 2014, Euromed Press, pp. 2035–2038.
- Cantele, S. and Vernizzi S. (2015), "The effect of network participation on firm performance: a matched-pairs analysis", in 8th Annual Conference of the EuroMed Academy of Business Innovation, Entrepreneurship and Sustainable Value Chain in a Dynamic Environment, Verona – Italy, 16th-18th September 2015, Euromed Press, pp. 482–494.
- Cantele, S. and Vernizzi S. (2016), "Value co-creation and entrepreneurial challenges in business networks: what factors impact upon the performance of firms in networks?", in Kaufmann, H. R. and Riad Shams, S. M. R. (Eds), *Entrepreneurial Challenges in the 21st Century: Creating Stakeholder Value Co-Creation*, Palgrave Macmillan, pp. 47–68.
- Cantele, S., Vernizzi, S. and Ricciardi, F. (2016), "The emerging wave of agility-oriented business networks in Italy: a new strategy for facing global competition", *World Review of Entrepreneurship, Management and Sustainable Development*, Vol. 12 No. 2/3, pp. 270–284.
- Chandler, A. D. (1962), *Strategy and structure: Chapters in the history of the American enterpris*, MIT Press, Cambridge.
- Christoffersen, J. (2013), "A review of antecedents of international strategic alliance performance: synthesized evidence and new directions for core constructs", *International Journal of Management Reviews*, Vol. 15 No. 1, pp. 66–85.
- Christoffersen, J., Plenborg, T. and Robson, M.J. (2014), "Measures of strategic alliance performance, classified and assessed", *International Business Review*, Vol. 23 No. 3, pp. 479–489.
- Codini, A.P. (2015), "Business networks along innovation life cycle", *Journal of Business & Industrial Marketing*, Vol. 30 No. 3/4, pp. 329–341.
- D'Aunno, T.A. and Zuckerman, H.S. (1987), "A life-cycle model of organizational federations: the case of hospitals", *Academy of Management Review*, Vol. 12, No. 3, pp. 534–545.
- Dess, G.G. and Beard, D.W. (1984), "Dimensions of organizational task environments", *Administrative Science Quarterly*, Vol. 29, pp. 52–73.
- Dickson, P. and Weaver, K.M. (1997), "Environmental determinants and individual level moderators of alliance use", *Academy of Management Journal*, Vol. 40, pp. 404–425.
- Dwyer, F.R., Schurr, P.H. and Oh, S. (1987), "Developing buyer-seller relationships", *Journal of Marketing*, Vol. 51, No. 4, pp. 11–27.
- Granovetter, M.S. (1992), "Problems of explanation in economic sociology", in Nohria, N. and Eccles, R. (Eds), *Networks and Organizations*, Harvard Business School Press, Boston, MA, pp. 25–56.
- Hite, J.M. and Hesterly, W.S. (2001), "Research notes and commentaries the evolution of firm networks: from emergence to early growth of the firm", *Strategic Management Journal*, Vol. 22 No. 3, pp. 275–286.

- Jiang, X., Li, Y. and Gao, S. (2008), "The stability of strategic alliances: characteristics, factors and stages", *Journal of International Management*, Vol. 14 No. 2, pp. 173–189.
- Jap, S.D. and Anderson, E. (2007), "Testing a life-cycle theory of cooperative interorganizational relationships: movement across stages and performance", *Management Science*, Vol. 53 No. 2, pp. 260–275.
- Kale, P. and Singh, H. (2009), "Managing strategic alliances: what do we know now, and where do we go from here?", *The Academy of Management Perspectives*, Vol. 23 No. 3, pp. 45–62.
- Koka, B.R., Madhavan, R. and Prescott, J.E. (2006), "The evolution of interfirm networks: environmental effects on patterns of network change", *Academy of Management Review*, Vol. 31 No. 3, pp. 721–737.
- Kumar, R. (2014), "Managing ambiguity in strategic alliances", *California Management Review*, Vol. 56 No. 4, pp. 82–103.
- Lin, H.M. et al. (2010), "Inter-network co-evolution: reversing the fortunes of declining industrial networks", *Long Range Planning*, Vol. 43 No. 5–6, pp. 611–638.
- Provan, K.G., Fish, A. and Sydow, J. (2007), "Interorganizational networks at the network level: a review of the empirical literature on whole networks", *Journal of Management*, Vol. 33 No. 3, pp. 479–516.
- Ring, P.S. and Van de Ven, A.H. (1994), "Developmental processes of interorganizational relationships", *The Academy of Management Review*, Vol. 19 No. 1, pp. 90–118.
- Roloff, J. (2005), "Deliberative Multistakeholdernetzwerke: Informelle Kooperationen zwischen Unternehmen, Zivilgesellschaft und Staat", *Forum Wirtschaftsethik*, Vol. 13 No. 3, pp. 6–19.
- Roloff, J. (2008), "A life cycle model of multi-stakeholder networks", *Business Ethics: A European Review*, Vol. 17 No. 3, pp. 311–325.
- Spekman, R.E., Forbes, T.M., Isabella, L.A. and Macavoy, T.C. (1998), "Alliance management: a view from the past and a look to the future", *Journal of Management Studies*, Vol. 35 No. 6, pp. 747–772.
- Strobl, A. and Kronenberg, C. (2016), "Entrepreneurial networks across the business life cycle: the case of Alpine hospitality entrepreneurs", *International Journal of Contemporary Hospitality Management*, Vol. 28 No. 6, pp. 1177–1203.
- Suire, R. and Vicente, J. (2014), "Clusters for life or life cycles of clusters: in search of the critical factors of clusters' resilience", *Entrepreneurship & Regional Development*, Vol. 26 No 1–2, pp. 142–164.
- Uzzi, B. (1996), "The sources and consequences of embeddedness for the economic performance of organizations: the network effect", *American Sociological Review*, Vol. 61, pp. 674–698.
- Valdaliso, J.M., Elola, A. and Franco, S. (2016), "Do clusters follow the industry life cycle?: diversity of cluster evolution in old industrial regions", *Competitiveness Review*, Vol. 26, No. 1, pp. 66–86, available at: <http://dx.doi.org/10.1108/CR-02-2015-0006>.
- Wegner, D., Alievi, R.M. and Begnis, H.S.M. (2015), "The life cycle of small-firm networks: an evaluation of Brazilian business networks", *BAR – Brazilian Administration Review*, Vol. 12 No. 1, pp. 39–62.
- Williamson, O.E. (1993), "Calculativeness, trust, and economic organization", *The Journal of Law and Economics*, Vol. 36 No. 1, Part 2, pp. 453–486.
- Zineldin, M. (2002), "Developing and managing a romantic business relationship: life cycle and strategies", *Managerial Auditing Journal*, Vol. 17 No. 9, pp. 546–558.

## THE ROLE OF BIG DATA IN VALUE CO-CREATION FOR THE KNOWLEDGE ECONOMY

Caputo, Francesco<sup>1</sup>; Evangelista, Federica<sup>2</sup>; Perko, Igor<sup>3</sup>; Russo, Giuseppe<sup>2</sup>

<sup>1</sup>Department of Pharmacy, University of Salerno, Fisciano, Italy

<sup>2</sup>Department of Business and Law, University of Cassino and Southern Lazio, Cassino, Italy

<sup>3</sup>Faculty of Economics and Business, University of Maribor, Maribor, Slovenia

### ABSTRACT

For a long time, managerial and organizational studies have debated the topic of value co-creation, underlining the need to involve all actors in shared pathways to “collect and use” their information. In recent years, thanks to advancements in knowledge offered by information and communication technologies (ICTs) and computer science related to Big Data, new opportunities have emerged with reference to the “use” of information to improve the quality and effectiveness of organizational strategies. Reflecting on these opportunities, this paper aims to analyse the topic of Big Data in the light of service logic and systems thinking, underlining the implications for organizations’ strategies and survival. The principal aim is to define some essential key points for organizations interested in the “use” of Big Data, offering them the opportunity to improve the positive effects of efficient, effective and sustainable use of information and thus build value co-creation strategies in the emerging knowledge economy.

*Keywords: Big Data, Value co-creation, Service Logic, Systems Thinking*

### INTRODUCTION

Over time, society has progressively shifted from a tangible and linear structure to a more indefinable and articulated configuration (Stacey *et al.*, 2000; McElroy, 2003; Stacey, 2007; Rotmans and Loorbach, 2009). Traditional managerial and organizational approaches have been gradually acknowledged as inadequate to support the understanding and managing of emerging phenomenon. Therefore, new skills and capabilities are needed to face the challenges imposed by the knowledge economy (Teece *et al.*, 1997; Hefley and Murphy, 2008; Schmenner *et al.*, 2009; Barile *et al.*, 2014, 2015a).

According to Kessels (2004), in emerging social and economic configurations “the application of knowledge adds more value than the traditional economic factors like capital, raw materials and labour” (p. 165). Recognizing the relevance of this perspective, the real problem concerns how to

determine the ways in which knowledge affects an organization's ability to generate value (Matusik and Hill, 1998; Tsai, 2001; Carlucci *et al.*, 2004; Del Giudice *et al.*, 2016).

With the aim of investigating this issue, several researchers have analysed the ways in which knowledge is shared among different entities (Gruber, 1995; Nonaka *et al.*, 2000; Barile *et al.*, 2015b; Saviano *et al.*, 2016), the dimensions and processes able to support or hinder knowledge sharing (Haldin-Herrgard, 2000; Caloghirou *et al.*, 2004; Evangelista *et al.*, 2016) and the role of technologies in supporting knowledge sharing (Alavi and Leidner, 2001; Earò, 2001; Ipe, 2003). All these contributions have offered relevant advancements in knowledge and stimuli in terms of reflections in the field of knowledge management, but the basic assumptions on which they are based are changing as a consequence of the emerging topic of Big Data (Zikopoulos and Eaton, 2011; McAfee *et al.*, 2012; Provost and Fawcett, 2013).

As posited by Davenport *et al.* (2012), Big Data support the learning of organizations that are "beginning to understand their business environments at a more granular level, are creating new products and services, and are responding more quickly to change as it occurs" (p. 43). In this vein, they offer the opportunity to combine more different sources in common and shared pathways useful for supporting several organizational activities (Hampton *et al.*, 2013; Callebaut, 2012; Chen and Zhang, 2014).

Analysing the role of Big Data, it can be argued that they support alignment between organizations' strategies and environmental trends by offering organizations the opportunity to develop in-depth understanding of the elements that affect social and economic dynamics (Chen *et al.*, 2012; Snijders *et al.*, 2012). Thus, Big Data appear to constitute a considerable opportunity for organizations, but – widening the perspective – some drawbacks, for instance ethical issues, can be identified if they are not correctly used (Gantz and Reinsel, 2012; Fan and Bifet, 2013; European Commission, 2016). In this vein, several research questions can be defined with reference to the advantages of investing in the management of big data and there are some doubts in terms of the capabilities of organizations to use Big Data effectively to improve the quality of their strategies.

In line with this, the increasing attention paid by organizations to Big Data could be a hazard if they are not aware of how they can be used and what is needed to exploit them. To enhance the existing literature on these topics, the rest of paper is structured as follows: in the next section, a possible theoretical and conceptual framework to broaden knowledge of the ways in which Big Data could affect organizations' performance and strategies is proposed. A conceptual model designed to enrich the state of the art of the role of Big Data in the knowledge economy is then defined in light of service logic and systems thinking. In the fourth section, the theoretical and practical implications of the

reflections herein are analysed and finally some conclusions and future directions for research are proposed.

## **THEORETICAL AND CONCEPTUAL FRAMEWORK**

### *A service view of Big Data*

As underlined by several researchers and practitioners, we are living in a service economy (Gallouj, 2002; Lusch *et al.*, 2007; Vargo and Lusch, 2008; Buera and Kaboski, 2012; Metcalfe, and Miles, 2012). According to Barrett *et al.* (2015), “the complexity of intra-organizational structures and interorganizational value networks create new demands for professional coordination services internal to the firm (e.g., supply chain management) or outsourced to specialized firms (e.g., supply chain mediation, third and fourth party logistics, professional service firms)” (p. 135). This increasing attention focused on the service domain has progressively required a radical change in perspective, supporting the emergence of a new service-dominant paradigm in which all social and economic activities can be analysed in terms of the services exchanged; these are obtained through interplay between resources, and the competences and knowledge of all actors involved (Barile *et al.*, 2012; Golinelli *et al.*, 2012; Lusch and Vargo, 2014; Polese *et al.*, 2016).

According to Vargo *et al.* (2008), in this emerging scenario, organizations should move beyond the traditional “industrial view”, which is based on transactional approaches, instead building shared pathways with all the actors involved in their ecosystem to co-create value. To implement this approach, organizations should build collaborative pathways based on resource sharing and reciprocal understanding (Barile and Saviano, 2010).

In this line, the relevant change is a shift from a vision based on hierarchical and mono-directional relations between organizations and markets to one based on collaboration and bi-directional relations, as shown in Figure 1.

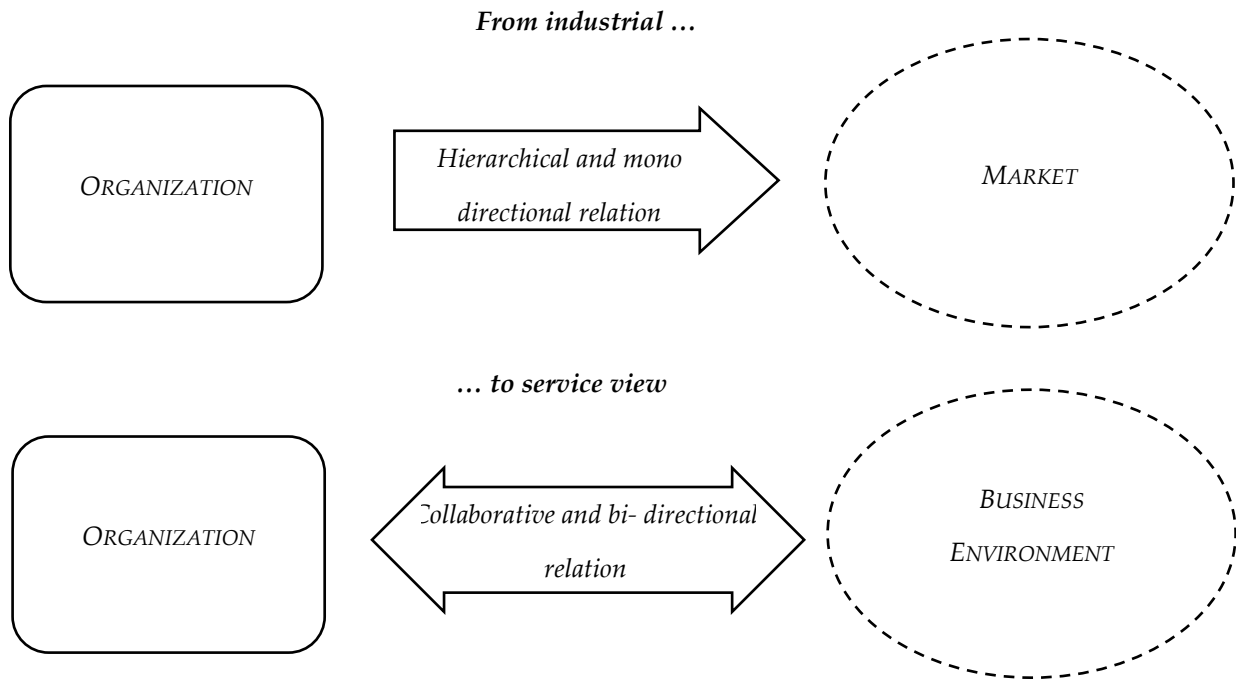

Figure 1. From industrial to service view (Source: Authors' elaboration)

According to the representation shown in the Figure 1, the emerging social and economic configurations require that organizations constantly adapt their strategies and behaviours on the basis of information provided by the business environment. Business environment involves all important partners, significantly affecting the success of a firm: customers, suppliers, shareholders, employees, sub-contractors, regulators potential local and global partners, etc (Perko et al., 2015). In past years, this process required direct interaction between organizations and markets to acquire the information needed to improve the general quality of the strategies adopted (Henderson and Venkatraman, 1993; Reich and Benbasat, 2000). Today, thanks to the opportunities provided by Big Data, a new general pathway can be defined as shown in Figure 2.

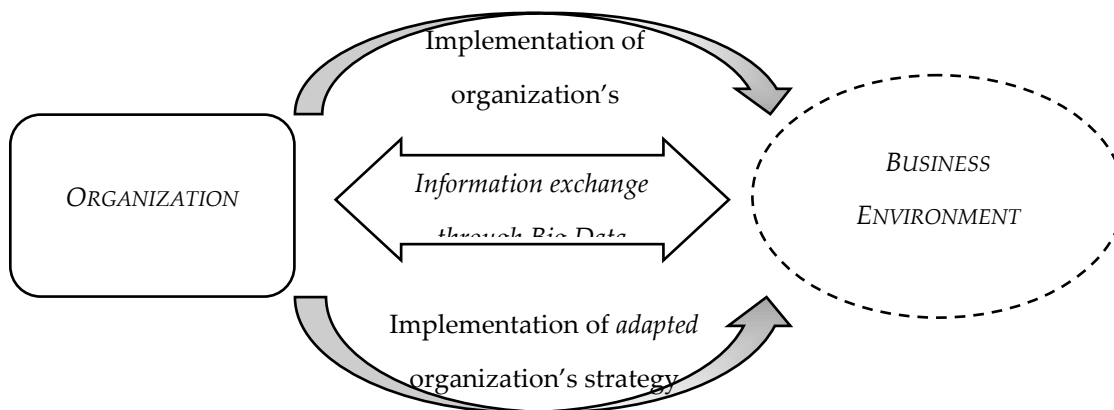

Figure 2. The role of Big Data in the implementation of organization's strategy (Source: Authors' elaboration)



Specifically, Big Data offer organizations a synthesis of the “relevant” information offered by the business environment, combining different sources of information to support the definition of strategies and behaviours aligned with the “average trends” of the business environment expectations. By this means, Big Data reduce the efforts required of organizations for the acquisition and use of data related to market trends, but at the same time they also reduce organizations’ ability to build direct relationships with the actors involved in their ecosystem. Thus, in a service economy Big Data reduce organizations’ ability to personalize their value propositions because they address organizations’ strategies in light of the average trends of market. Therefore, it is possible to state that:

*Big Data improve the quality of organizations’ strategies in a service economy only in the case that there is strong similarity between the actors involved in the ecosystem.*

#### *A systems view of Big Data*

The knowledge economy can be considered to be the results of a networked environment in which all actors exchange information with the principal aim of ensuring survival over time. According to this definition, the knowledge economy can be viewed as a system in which all the parts interact through the exchange and sharing of information. These processes support the actors’ ability to improve the quality, efficiency, effectiveness and sustainability of their pathways and strategies on the basis on the information provided by the external environment (Di Nauta *et al.*, 2015).

This synthetic description offers a general picture of the ways in which the actors define their pathways, highlighting the existence of a strong interrelation among all the actors involved in the same environment. With reference to this, a relevant issue emerges with reference to the variables and dimensions able to affect the exchange and sharing of information between the actors involved in the same pathway (Lee, 2001; Tsai, 2002; Blumenberg *et al.*, 2009; Ekinci and Baykasoglu, 2016). To address this issue, an interesting contribution is offered by systems thinking as a general interpretative framework in which the relevance of interaction among the parts to ensure the survival of the whole is underlined (Beer, 1979; Checkland, 1981; Emery, 1981; Capra, 1996; Jackson, 2003; Golinelli, 2010; Barile, 2013; Barile *et al.*, 2016).

Among the research streams rooted in systems thinking, interesting contributions to broadening perspectives in the study of Big Data can be derived from the viable systems approach (VSA). According to the VSA, every kind of social and economic configuration aimed at ensuring survival in a specific context can be considered a system and can be represented in terms of information units, interpretation schemes and categorical values (Barile, 2009; Saviano *et al.*, 2014). More specifically, information units comprise the information on which systems’ strategies and decisions are based, interpretation schemes are the ways in which the available information is organized and filtered to

support systems' strategies and decisions and categorical values are the strong beliefs that underlie systems' decisions and behaviours.

Adopting the interpretative lens offered by the *vSA*, it can be argued that in the knowledge economy every interaction among different systems is based on information sharing, information coding and information filtering as shown in Figure 3.

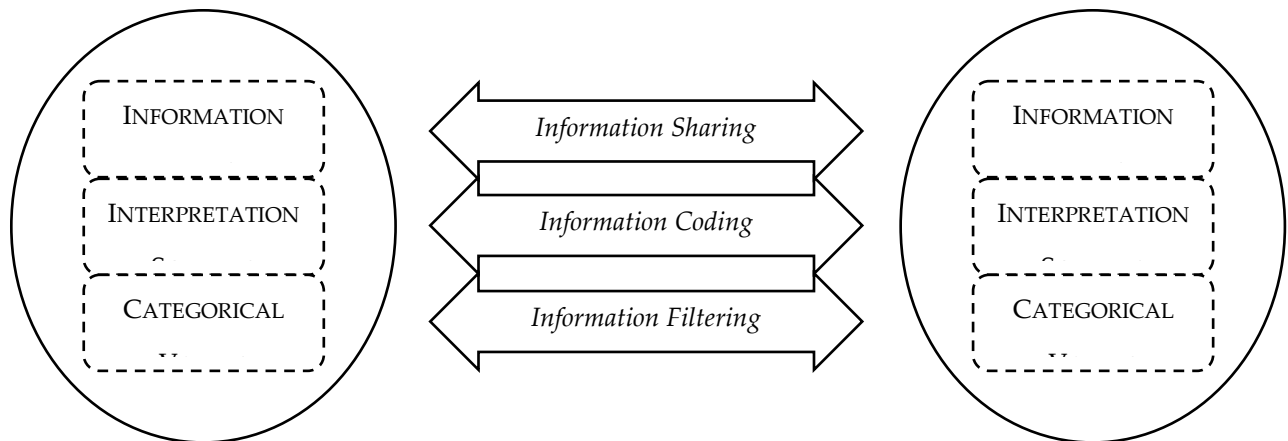

Figure 3. A representation of the information interaction process in the light of *vSA* (Source: Authors' elaboration)

Enriching this modelling with previous contributions provided by studies on the topic of Big Data, it can be observed that Big Data reduce the effort required for information sharing and coding by offering organizations opportunities to pay particular attention to the selection of information considered relevant and aligned in light of prevalent strong beliefs. Therefore, it is possible to state that:

*Big Data reduce the effort required of systems' for information sharing and coding and they offer systems the opportunity to pay greater attention to the information filtering process.*

## BIG DATA AS A VALUE DRIVER

In the last few years, the topic of Big Data has attracted increasing attention from several researchers and practitioners in a multi- and trans-disciplinary debate principally oriented to investigating the ways in which it is possible to acquire, code and use large amounts of data to improve the efficiency, effectiveness and sustainability of organizations' strategies (Dumbill, 2013; Swan, 2013). According to this perspective, several contributions have analysed the ways in which big data can be managed with the support offered by information and communication technologies (Chen and Zhang, 2014; Di Fatta *et al.*, 2016) and increasing attention has been paid to the opportunities for organizations to use "more information" in the planning and implementation of their strategies (Sagiroglu and Sinanc, 2013). Despite the relevance of this approach, it seems to be strictly related to a quantitative view in which

the focus is only on the amount of information that organizations can use to achieve their aims (Caputo *et al.*, 2016c). With the aim of enriching this perspective by highlighting the “qualitative” contribution of Big Data to organizations’ strategies, this paper adopts the interpretative lens provided by service logic and systems thinking to show the lights and shadows of Big Data.

In line with the interpretative contributions provided by service logic and systems thinking, Big Data can be considered the source of a radical change in ways of managing the interactions between organizations and environment, reducing the effort of acquiring and coding information. Reflecting on this opportunity, it is necessary to specify that the acquisition and codification of information represent only two steps in the interaction processes between organizations and environment. In this line, Big Data can offer organizations useful support in the management of interactions with the environment, but they cannot be considered the only driver.

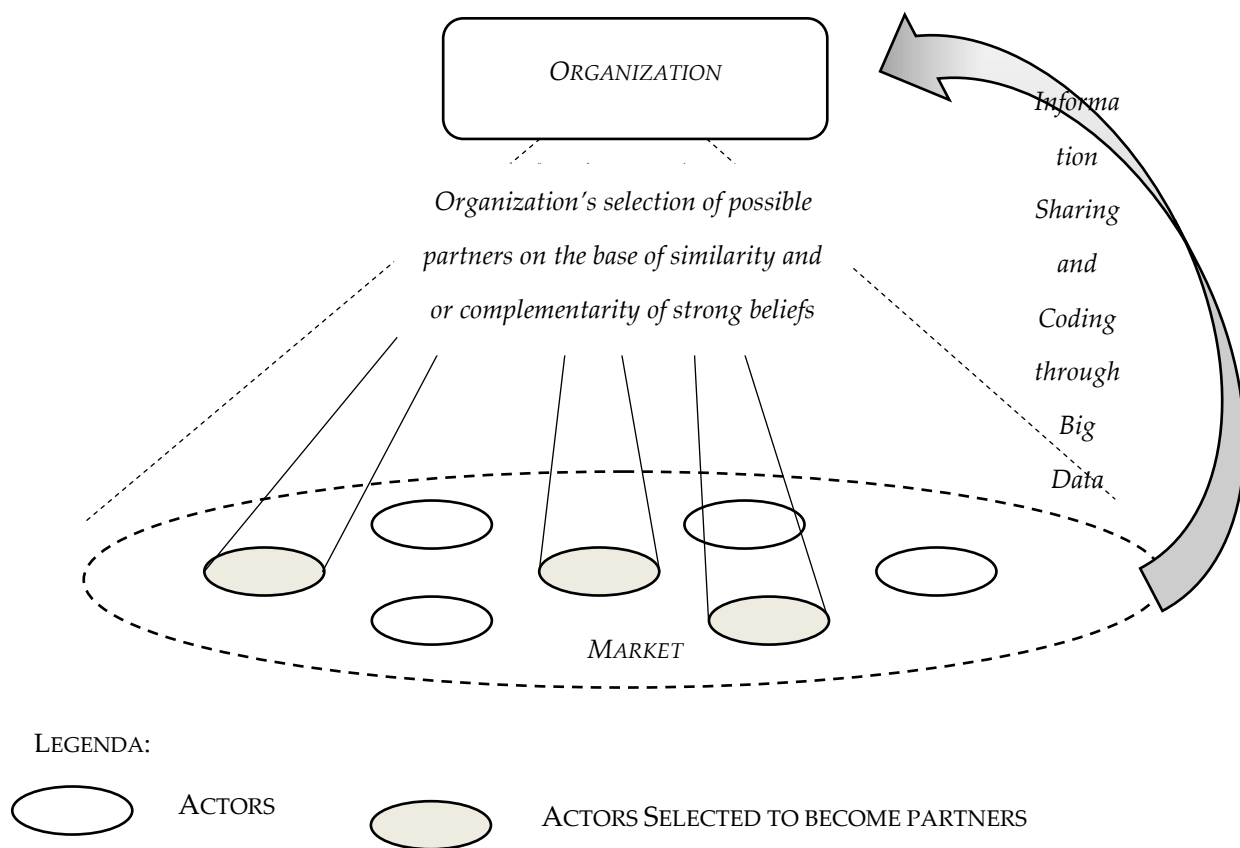

Figure 4. A representation of the role of Big Data in supporting organization's selection of possible partners for suitable value co-creation strategies (Source: Authors' elaboration)

By reducing the time and resources required for the acquisition and codification of information, Big Data offer organizations the opportunity to pay greater attention to the “qualitative dimensions” of

strategies. Exploiting Big Data, organizations can focus more intently on the identification of actors aligned with their own strong beliefs and involve them in building effective strategies based on collaboration and value co-creation, as shown in Figure 4.

However, Big Data can be considered a value driver for organizations only in the case that the advantages offered in terms of more available information are used effectively to filter the environment with the aim of identifying possible partners inspired and affected by similar or complementary strong beliefs and thus enabling them to develop joint strategies for value co-creation (Caputo, 2016; Caputo *et al.*, 2016b).

## **THEORETICAL AND PRACTICAL IMPLICATIONS**

Over time, the attention paid to information flows and processes has been progressively influenced by the increasing relevance of quantitative approaches (Bhatt, 2001). In this vein, Big Data can be considered the last representation of organizations' willingness to obtain more information to better define their strategies (Wu *et al.*, 2014).

Despite the relevance of this approach, as underlined in the previous pages it cannot be considered exhaustive in terms of understanding and managing social dynamics. A more extensive approach is required to capture all the opportunities offered by the knowledge economy also in the light of a qualitative approach.

By following this pathway, this paper highlights the opportunities offered by Big Data for improving organizations' ability to identify compatible actors and develop joint strategies. Focusing on the reflections provided in the previous pages, several implications can be derived both from theoretical and practical perspectives.

More specifically, from the theoretical point of view, it is necessary to undertake the following:

- expand studies on Big Data by introducing specific references to the ways in which information is filtered on the basis of organizations' strong beliefs;
- enrich the existing managerial and organizational literature in light of the opportunities offered by Big Data to gain an understanding of the market and build stronger relationships with the actors involved in the same ecosystem;
- develop a multi- and trans-disciplinary conceptual framework able to link the advancements in knowledge offered by information and communication technologies with the organizations' need to enrich the quantitative perspective with a more qualitative view.

At same time, from a practical point of view, it is necessary to:

- investigate the ways in which organizations use Big Data to define their strategies and behaviours;
- analyse organizations' perceptions of the role and contributions of Big Data in building value co-creation strategies in the knowledge economy;
- develop cross-cultural studies with the aim of enriching studies on Big Data using culturally based variables and dimensions.

## CONCLUSIONS AND FUTURE DIRECTIONS FOR RESEARCH

In the post-modern era, information can be considered the most relevant resource for every kind of organization interested in survival over time (Castells, 2011). The progress and advancements in knowledge derived from information and communication technologies and computer sciences offer organizations the opportunity to overcome the limitations imposed by a scarcity of information. In coming years all actors will be able to access and use amounts of information that today we cannot even imagine. Thus, in the future the real competitive advantages for organizations will not be related to the amount of information available, but to the ways in which this information is subjectively filtered and used to build shared pathways for value co-creation strategies.

Big Data can be considered the last evidence of an evolving knowledge society in which the boundaries imposed by time and space are progressively disappearing and new rules are emerging. In this emerging scenario, the real challenge for organizations concerns the identification of non-imitable pathways rather than the acquisition of more information with respect to competitors. Big Data offer organizations a relevant opportunity by reducing the time and resources required for the acquisition and coding of information. Nowadays, organizations should use this "saving" and the greater availability of information to select possible partners inspired by similar or complementary strong beliefs, leading to the potential to develop shared strategies for value co-creation.

To support this process, further research is required to investigate the psychological and cognitive domains able to affect organizations' strategies by defining their strong beliefs. Such research could develop instruments, tools and models to support the identification and selection of possible partners for suitable value co-creation strategies.

## REFERENCES

- Alavi, M., and Leidner, D. E. (2001), "Review: Knowledge management and knowledge management systems: Conceptual foundations and research issues", *MIS quarterly*, Vol. 25 No. 1, pp. 107-136.
- Barile, S., Saviano, M., and Caputo, F. (2014), "A systems view of customer satisfaction", in National Conference "Excellence in quality, statistical quality control and customer satisfaction". University Campus "Luigi Einaudi", University of Turin, September 18-19.

- Barile, S., Saviano, M., and Caputo, F. (2015a), "How Are Markets Changing? The Emergence of Consumers Market Systems", in Dominici G. (Ed.), *The 3rd International Symposium Advances in Business Management. "Towards Systemic Approach"* (pp. 203-207), Busyness Systems. E-book Series, Avellino.
- Barile, S., Saviano, M., Polese, F., and Caputo, F. (2015b), "T-Shaped People for addressing the Global Challenge of Sustainability. In Gummesson, E., Mele, C., Polese, F. (2015), *Service Dominant Logic, Network and Systems Theory and Service Science: Integrating three Perspectives for a New Service Agenda*, Giannini, Napoli.
- Barile, S. (2009, July), "The dynamic of informative varieties in the processes of decision making", in *The 3rd International Conference on Knowledge Generation, Communication and Management*, Orlando, Florida.
- Barile, S. (Ed.) (2013), *Contributions to theoretical and practical advances in management. A Viable Systems Approach*, Aracne, Roma
- Barile, S., and Saviano, M. (2010), "A new perspective of systems complexity in service science", *Impresa, Ambiente, Management*, Vol. 4 No. 3, pp. 375-414.
- Barile, S., Lusch, R., Reynoso, J., Saviano, M., and Spohrer, J. (2016), "Systems, networks, and ecosystems in service research", *Journal of Service Management*, Vol. 27 No. 4, pp. 652-674.
- Barile, S., Pels, J., Polese, F., and Saviano, M. (2012), "An introduction to the viable systems approach and its contribution to marketing", *Journal of Business Market Management*, Vol. 5 No. 2, pp. 54-78.
- Barrett, M., Davidson, E., Prabhu, J., and Vargo, S. L. (2015), "Service innovation in the digital age: key contributions and future directions", *MIS quarterly*, Vol. 39 No. 1, pp. 135-154.
- Beer, S. (1979), *The heart of enterprise*, John Wiley & Sons, New York.
- Bhatt, G. D. (2001), "Knowledge management in organizations: examining the interaction between technologies, techniques, and people", *Journal of knowledge management*, Vol. 5 No. 1, 68-75.
- Blumenberg, S., Wagner, H. T., and Beimbom, D. (2009), "Knowledge transfer processes in IT outsourcing relationships and their impact on shared knowledge and outsourcing performance", *International Journal of Information Management*, Vol. 29 No. 5, pp. 342-352.
- Buera, F. J. and Kaboski, J. (2012), "The rise of the service economy", *The American Economic Review*, Vol. 102 No. 6, pp. 2540-2569.
- Callebaut, W. (2012), "Scientific perspectivism: a philosopher of science's response to the challenge of big data biology", *Studies in History and Philosophy of Science Part C: Studies in History and Philosophy of Biological and Biomedical Sciences*, Vol. 43 No. 1, pp. 69-80.
- Caloghirou, Y., Kastelli, I., and Tsakanikas, A. (2004), "Internal capabilities and external knowledge sources: complements or substitutes for innovative performance?", *Technovation*, Vol. 24 No. 1, pp. 29-39.
- Capra, F. (1996), *The web of life: A new scientific understanding of living systems*, Anchor, New York.
- Caputo, F. (2016), "A focus on company-stakeholder relationships in the light of the Stakeholder Engagement framework", in Vrontis D., Weber Y., Tsoukatos E. (eds.) *Innovation, Entrepreneurship and Digital Ecosystems* (pp. 455-470), EuroMed press, Cyprus.
- Caputo, F., Del Giudice, M., Evangelista, F. and Russo, G. (2016a), "Corporate disclosure and intellectual capital. The light side of information asymmetry", *International Journal of Managerial and Financial Accounting*, Vol. 8 No. 1, pp. 75-96.
- Caputo, F., Evangelista, F. and Russo G. (2016b), "Information Sharing and Communication Strategies: a Stakeholder Engagement view", in Vrontis D., Weber Y., Tsoukatos E. (eds.) *Innovation, Entrepreneurship and Digital Ecosystems* (pp. 436-442), EuroMed press, Cyprus.
- Caputo, F., Formisano, V., Buronova, B. and Wallezky, L. (2016c), "Beyond the digital ecosystems view: insights from Smart Communities", in Vrontis D., Weber Y., Tsoukatos E. (eds.) *Innovation, Entrepreneurship and Digital Ecosystems* (pp. 443-454), EuroMed press, Cyprus.
- Carlucci, D., Marr, B. and Schiuma, G. (2004), "The knowledge value chain: how intellectual capital impacts on business performance", *International Journal of Technology Management*, Vol. 27 No. 6-7, pp. 575-590.
- Castells, M. (2011), *The rise of the network society: The information age: Economy, society, and culture*, John Wiley & Sons, New York.
- Checkland, P. (1981), *Systems thinking, systems practice*, John Wiley & Sons, Chichester.
- Chen, C. P. and Zhang, C. Y. (2014), "Data-intensive applications, challenges, techniques and technologies: A survey on Big Data", *Information Sciences*, Vol. 275, pp. 314-347.
- Chen, H., Chiang, R. H. and Storey, V. C. (2012), "Business Intelligence and Analytics: From Big Data to Big Impact", *MIS quarterly*, Vol. 36 No. 4, pp. 1165-1188.
- Davenport, T. H., Barth, P. and Bean, R. (2012), "How big data is different", *MIT Sloan Management Review*, Vol. 54 No. 1, pp. 43-46.

- Del Giudice, M., Caputo, F. and Evangelista, F. (2016), "How are decision systems changing? The contribution of social media to the management of decisional liquefaction", *Journal of Decision Systems*, Vol. 25 No. 3, pp. 214-226.
- Di Fatta, D., Caputo, F., Evangelista, F., and Dominici, G. (2016), "Small world theory and the World Wide Web: Linking small world properties and website centrality", *International Journal of Markets and Business Systems*, Vol. 2 No. 2, DOI: 10.1504/IJMABS.2016.080237.
- Di Nauta, P., Merola, B., Caputo, F. and Evangelista, F. (2015), "Reflections on the Role of University to Face the Challenges of Knowledge Society for the Local Economic Development", *Journal of Knowledge Economy*, pp. 1-19. DOI:10.1007/s13132-015-0333-9.
- Dumbill, E. (2013), "Making sense of big data", *Big Data*, Vol. 1 No. 1, pp. 1-2.
- Earl, M. (2001), "Knowledge management strategies: Toward a taxonomy", *Journal of management information systems*, Vol. 18 No. 1, pp. 215-233.
- Emery, F. E. (Ed.) (1981), *Systems thinking: selected readings*, Penguin books, New York.
- Ekinci, E. and Baykasoglu, A. (2016), "Modelling complexity in retail supply chains", *Kybernetes*, Vol. 45 No. 2, pp. 297-322.
- European Commission (2016), Regulation (Eu) 2016/679 of the European Parliament and of the Council of 27 April 2016 on the protection of natural persons with regard to the processing of personal data and on the free movement of such data, and repealing Directive 95/46/EC (General Data Protection Regulation)
- Evangelista, F., Caputo, F., Russo, G. and Buhnova B. (2016), "Voluntary corporate disclosure in the Era of Social Media", in Caputo F. (Ed.), *The 4rd International Symposium Advances in Business Management. "Towards Systemic Approach"* (pp. 124-128), Business Systems. E-book series, Avellino.
- Fan, W. and Bifet, A. (2013), "Mining big data: current status, and forecast to the future", *ACM SIGKDD Explorations Newsletter*, Vol. 14 No. 2, pp. 1-5.
- Gallouj, F. (2002), *Innovation in the service economy: the new wealth of nations*, Edward Elgar Publishing, London.
- Gantz, J. and Reinsel, D. (2012), *The digital universe in 2020: Big data, bigger digital shadows, and biggest growth in the far east*, IDC iView: IDC Analyze the future, 2007 (pp. 1-16).
- Golinelli, G. M. (2010), *Viable systems approach (VSA): Governing business dynamics*, Cedam, Padova.
- Golinelli, G. M., Barile, S., Saviano, M. and Polese, F. (2012), "Perspective shifts in marketing: toward a paradigm change?", *Service Science*, Vol. 4 No. 2, pp. 121-134.
- Gruber, T. R. (1995), "Toward principles for the design of ontologies used for knowledge sharing?", *International journal of human-computer studies*, Vol. 43 No. 5, pp. 907-928.
- Haldin-Herrgard, T. (2000), "Difficulties in diffusion of tacit knowledge in organizations", *Journal of Intellectual capital*, Vol. 1 No. 4, pp. 357-365.
- Hampton, S. E., Strasser, C. A., Tewksbury, J. J., Gram, W. K., Budden, A. E., Batcheller, A. L. and Porter, J. H. (2013), "Big data and the future of ecology", *Frontiers in Ecology and the Environment*, Vol. 11 No. 3, pp. 156-162.
- Hefley, B. and Murphy, W. (Eds.) (2008), *Service science, management and engineering: education for the 21st century*, Springer Science & Business Media, New York.
- Henderson, J. C. and Venkatraman, H. (1993), "Strategic alignment: Leveraging information technology for transforming organizations", *IBM systems journal*, Vol. 32 No. 1, pp. 472-484.
- Ipe, M. (2003), "Knowledge sharing in organizations: A conceptual framework", *Human Resource Development Review*, Vol. 2 No. 4, pp. 337-359.
- Jackson, M. C. (2003), *Systems thinking: Creative holism for managers*, Wiley, Chichester.
- Kessels, J. (2004), "The knowledge revolution and the knowledge economy. The challenge for HRD", in Lee M., Stewart J., Woodall J. (eds.), *New Frontiers in HRD*. Routledge Studies in Human Resource Development, Routledge, London.
- Lee, J. N. (2001), "The impact of knowledge sharing, organizational capability and partnership quality on IS outsourcing success", *Information & Management*, Vol. 38 No. 5, pp. 323-335.
- Lusch, R. F. and Vargo, S. L. (2014), *Service-dominant logic: Premises, perspectives, possibilities*. Cambridge University Press, Cambridge.
- Lusch, R. F., Vargo, S. L. and O'Brien, M. (2007), "Competing through service: Insights from service-dominant logic", *Journal of retailing*, Vol. 83 No. 1, pp. 5-18.
- Matusik, S. F. and Hill, C. W. (1998), "The utilization of contingent work, knowledge creation, and competitive advantage", *Academy of management review*, Vol. 23 No. 4, pp. 680-697.
- McAfee, A., Brynjolfsson, E., Davenport, T. H., Patil, D. J. and Barton, D. (2012), "Big data. The management revolution", *Harvard Business Review*, Vol. 90 No. 10, pp. 61-67.

- McElroy, M. W. (2003), *The new knowledge management: Complexity, learning, and sustainable innovation*, Routledge, London.
- Metcalf, J. S. and Miles, I. (Eds.) (2012), *Innovation systems in the service economy: measurement and case study analysis*, Springer Science & Business Media, New York.
- Nonaka, I., Toyama, R. and Nagata, A. (2000), "A firm as a knowledge-creating entity: a new perspective on the theory of the firm", *Industrial and corporate change*, Vol. 9 No. 1, pp. 1-20.
- Perko, I., Primec, A. and Horvat, R. (2015), "Sharing business partner behaviour", *Kybernetes*, Vol. 44 No. 6-7, pp. 1030-1048.
- Polese, F., Caputo, F., Carrubbo, L. and Sarno, D. (2016), "The value (co)creation as peak of social pyramid", in Russo-Spena T., Mele C. (eds.), *Proceedings 26th Annual RESER Conference, "What's ahead in service research: new perspectives for business and society"* (pp. 1232-1248), RESER, University of Naples "Federico II".
- Provost, F. and Fawcett, T. (2013), "Data science and its relationship to big data and data-driven decision making", *Big Data*, Vol. 1 No. 1, pp. 51-59.
- Reich, B. H. and Benbasat, I. (2000), "Factors that influence the social dimension of alignment between business and information technology objectives", *MIS quarterly*, pp. 81-113.
- Rotmans, J. and Loorbach, D. (2009), "Complexity and transition management", *Journal of Industrial Ecology*, Vol. 13 No. 2, pp. 184-196.
- Sagioglu, S. and Sinanc, D. (2013, May), "Big data: A review. In Collaboration Technologies and Systems (CTS)" in 2013 International Conference on (pp. 42-47), IEEE.
- Saviano, M., Parida, R., Caputo, F. and Datta, S.K. (2014), "Health care as a worldwide concern. Insights on the Italian and Indian health care systems and PPPs from a VSA perspective", *EuroMed Journal of Business*, Vol. 9 No. 2, pp. 198-220.
- Saviano, M., Polese, F., Caputo, F. and Wallezky, L. (2016), "A T-shaped model for rethinking higher education program", in 19th Toulon-Verona International Conference Excellence in Services - Conference Proceedings, pp. 425-440.
- Schmenner, R. W., Van Wassenhove, L., Ketokivi, M., Heyl, J. and Lusch, R. F. (2009), "Too much theory, not enough understanding", *Journal of Operations Management*, Vol. 27 No. 5, pp. 339-343.
- Snijders, C., Matzat, U. and Reips, U. D. (2012), "'Big Data': big gaps of knowledge in the field of internet science", *International Journal of Internet Science*, Vol. 7 No. 1, pp. 1-5.
- Stacey, R. D. (2007), *Strategic management and organisational dynamics: The challenge of complexity to ways of thinking about organisations*, Pearson education, New York.
- Stacey, R. D., Griffin, D. and Shaw, P. (2000), *Complexity and management: fad or radical challenge to systems thinking?*, Routledge, London.
- Swan, M. (2013), "The quantified self: Fundamental disruption in big data science and biological discovery", *Big Data*, Vol. 1 No. 2, pp. 85-99.
- Teece, D. J., Pisano, G. and Shuen, A. (1997), "Dynamic capabilities and strategic management", *Strategic management journal*, Vol. 18 No. 7, pp. 509-533.
- Tsai, W. (2001), "Knowledge transfer in intraorganizational networks: Effects of network position and absorptive capacity on business unit innovation and performance", *Academy of management journal*, Vol. 44 No. 5, pp. 996-1004.
- Tsai, W. (2002), "Social structure of "coopetition" within a multiunit organization: Coordination, competition, and intraorganizational knowledge sharing", *Organization science*, Vol. 13 No. 2, pp. 179-190.
- Vargo, S. L. and Lusch, R. F. (2008), "From goods to service (s): Divergences and convergences of logics", *Industrial Marketing Management*, Vol. 37 No. 3, pp. 254-259.
- Vargo, S. L., Maglio, P. P. and Akaka, M. A. (2008), "On value and value co-creation: A service systems and service logic perspective", *European management journal*, Vol. 26 No. 3, pp. 145-152.
- Wu, X., Zhu, X., Wu, G. Q. and Ding, W. (2014), "Data mining with big data", *IEEE transactions on knowledge and data engineering*, 26(1), 97-107.
- Zikopoulos, P. and Eaton, C. (2011), *Understanding big data: Analytics for enterprise class hadoop and streaming data*, McGraw-Hill Osborne Media, New York.

## CAN BRAND ENTERTAINMENT STRENGTHEN A BRAND?

Caratù, Myriam; Sfodera, Fabiola

Department of Communication and Social Research, University "Sapienza", Rome, Italy



## ABSTRACT

The paper is framed in the academic debate regarding evolution and paradigmatic changes of the branding strategies adopted in the new postmodern marketing era. Its purpose is exploring whether or not a branded content, beyond being an engaging touch-point for the customers, can be an Integrated Marketing Communication tool effective in strengthening a brand. The findings, synthesized in a holistic conceptual framework, reveal that a branded content strategy can boost in the audience a positive attitude toward the brand, by operating on Brand Image and Brand Awareness (components of Brand Knowledge that, in turn, influences Brand Equity). This conceptual model, verified through a quali-quantitative research carried on across two countries, represents an attempt to fill a gap in the existing literature about brand entertainment: by assuming that branded content is the natural evolution of the advertising in the new postmodern era, the paper represents the first attempt to frame it in a branding model. Hence, the originality and value of the study, since - unlike what happened with regard to advertising - branded content has never been linked with brand equity. From the managerial point of view, the study helps businessmen in moving forward from the traditional perspective of advertising, while suggesting a new approach in getting useful insights about the branding policy: from a "push" to a "pull" communication.

*Keywords: Brand Entertainment, Branded Content, Advertising, Integrated Marketing Communication, Content Marketing, Branding, Brand Equity, Promotion.*

## 1. INTRODUCTION

In recent years, several studies (Boyland, E. J., & Halford, J. C., 2013; Hansen, F., & Christensen, L.B. 2003; Percy, L., 2003) have focused on advertising and its link with branding and brand equity, while proposing even a theoretical frame for embedding advertising in the branding model (De Mooij, M., & Hofstede, G, 2010, Erdem, T., & Sun, B., 2002). Differently, there is a lack of documents aimed at proposing a theoretical framework, in this sense, in the literature regarding branded content - even though the latter represents the natural evolution of advertising in the modern era. In fact, brand(ed) entertainment, quite literally, means 'entertainment by or in conjunction with a brand', and since the origins of TV brands have always been integrated with media products, giving birth to the so-called product placement. However, in the branded entertainment, also called advertainment- as a convergence of advertising and entertainment - the products are no longer just 'placed', but woven into the entertainment content, building a stronger emotional connection with the consumer (Hudson, S., & Hudson, D., 2006): branded entertainment is a sign of the new fast-changing, growing socio-economical

environment where the classic advertising is not efficient anymore, because of the obstacle of the so-called '*marketing clutter*', which prevents people from accepting in their life any other promotional messages, since their threshold of attention is now full and - in a sense - trained to push away the thousands of messages that bombard our lives everyday, everywhere. In this totally branded media world, moreover, people react in discordant ways: for some, seeing brands everywhere is a source of irritation, while other derive amusement from spotting them (Lehu, J.M.,2007). Hereafter, entertainment and irritation are factors that directly contribute to the attitude of the audience towards a brand (Aldas-Manzano J. et al., 2013). This is the reason why marketing communication has changed its features, today: within the so-called "*long-tail economy*" (Anderson, C.,2007) and the structure of the new media environment (abundance of media, audience fragmentation and polarization, product-portfolio of the firms, overall power shift on communication) the customers' audience is spawn between many and diversified media, especially the new digital ones, and the traditional communication is no more effective in creating brand loyalty and fight that "*continuous partial attention*" (Stone, L., 1998) that the consumers have developed towards the pounding media pressure present in their lives. No wonder if the advertising of the the last twenty years make of *interactivity*, *emotional touch-points* and *user-generated contents* the "must" of the new marketing communication, which, over time, has come to value the importance of *engaging* the consumers - more and more *pro-sumers* (Toffler, A., 1980), as in producers of contents themselves. Connecting with the *pro-sumers* through a *communitarian/participative* approach is, at the same time, the aim of the marketing communication and a useful tool to position the brand in the competitive scenario and in the consumers' "*mindscape*" (mind landscape). Not by chance, in the last years, some scholars (Lundqvist, A. et al. 2013; Woodside, A. G., 2010; Herskovitz, S. and Crystal. M., 2010) have found a creative approach to position the brand in the consumers' minds: the *brand storytelling*, which aims at creating a brand positioning based on a fictional story that has a setting, characters, a narrative plot and a well-defined language ascribable to the brand values. The narrative, here, links the brand to the consumers, going deep into their memory, leveraging on the mental associations and connecting to the stories and experiences of the individual, and very often this fiction is based on the storytelling of the brand heritage: this forms interesting solutions in the new digital environment, where the storytelling has become cross medial (trans-media storytelling), since all the elements of the fiction get dispersed systematically across different medium, each giving its own contribution to the story that at the end results coordinated, in a real optic of Integrated Marketing Communication. What has been just outlined is the context where branded entertainment finds its "*raison d'être*": blending Branding, Storytelling and Viral, it can be defined as the production of contents realized by the company/brand itself, which is able to attract the audience on themes pertinent to the brand values and objectives but, nevertheless, not immediately amenable to the brand products

and services (Bonsignore, P. and Sassoon J., 2014). It can be proposed also on the traditional media (TV, cinema) but it is important to underline that what is intrinsic to its interactive and participative nature is the connection with the new digital media, not by chance expression of the new active consumer. It can be argued that Branded Entertainment is son of the new market and new economy abovementioned and at the same time a symptom of the shift from the old “push” communication strategy (e.g. marketing/advertising clutter) to the new “pull” one (e.g. audience engagement).

## 2. LITERATURE REVIEW AND HYPOTHESES DEVELOPMENT

The *research questions* of this study therefore are: the branded content can also be an effective tool of a company’s branding process? Moreover can it influence brand equity? From an initial literature review, has emerged that, nowadays, brand entertainment – alongside with branded content – is an effective touch-point to engage the audience and retain the customers, and a marketing strategy increasingly adopted by brand-holders, even in disparate fields (Hudson, S., & Tung, V., 2016; Lei, S. S. I., Pratt, S., & Wang, D., 2016; Holt, D.; 2016). However, we already mentioned the lack of documents - in the literature reviewed – that propose a theoretical framework to explain brand entertainments’ influence on brand equity in a systematic way. So, in order to fill this gap, this study has tried to understand what is the incidence of Branded Content on the brand system through acting on the aspects influencing Brand Equity and to individuate the main factors influencing the branded content marketing strategy, both from the contextual perspective and from the brand holders’ perspective.

### 2.1 Branded Content and Branding

The already mentioned shift in the marketing perspective (see Introduction) represents also a redirection of focus in the companies’ corporate communication: no more pivoted the *product offering* itself but instead on the *brand system*. In fact, if advertainment has grown mainly in reaction to the increasing advertising clutter, escalating advertising costs, and the reduced effectiveness of traditional advertising messages, in the modern fragmented market and related “fragmented marketing” (relational/event/B2B/B2C - marketing etc.), the need for promoting the *brand* instead than the products themselves becomes fundamental to approach an audience that does not care anymore about the tangible attributes but rather to the intangible ones. Hence, the need no longer for *product* integration (that is the logic of the product placement) but rather for *brand* integration in the media content is a crucial step towards the *branded entertainment*: this, in fact, marks a shift from the intrusive advertisement pushed at the audiences who are engaged in other content (interruptive/push strategy= intrusion-based marketing= hard-sell approach) to a kind of advertising of such merit or interest that the audience actively seeks it out (interactive/pull strategy= invitation-based marketing=soft-sell

approach) (Lotz, D. A. 2007). Moreover, another difference with the old logic of product placement is the advantage, in the branded content, of new technologies (Grainge, P., 2012): according to Valero, D. (2014) the latter is organic (brand and content are at the same level of importance and totally integrated in the creation of the show) and seamless (defragmenting the brand from the story is impossible). Therefore, if irritation in the product placement is neutralized by the degree of integration, and if this can be applied to the branded entertainment in slightly different terms (no longer “less irritation” but rather “more involvement”), we could state that, the thinner is the aforesaid “line”, the bigger will be the audience engagement. The level of integration in different advertainment typologies is indeed proportional to the degree of integration: less in the product placement, more in the product integration, even more in the branded content (Russell, C.A. 2007). Hence, ***hypothesis 1:** the more is the level of integration between the brand and the media content, the more likely will be a positive attitude towards the brand.* For what concerns instead the format used for proposing a branded content - especially on the TV, it is important to mention that there are several mainly common formats - according to some researches appeared the Italian Cultural Observatory on Brand Activity. For instance, the TV-movie and the Collection (that recalls the form of the sit-com), TV Series and Serialized Series and, finally, Reality/Talent Show. The choice of the media then, as well as the one of the formats where to convey the branded content message, is relevant in engaging the target audience in terms of: opportunity to see (which has a direct effect on brand awareness) and customer retention (that influences brand loyalty). It also has an indirect effect on the brand image, since the brand personality must have congruence with the media and format chosen (Repetto, M., 2006): for instance, is rather unlikely that a brand involved in a Reality TV/Talent Show will reach the target aged 50-60, and even if it happened, there is a high probability that it will not be perceived positively, given the idiosyncrasy of the above-mentioned target towards this form of entertainment. ***Hypothesis 2:** the type of media and format chosen for branded content has an indirect effect on brand image.* However, the choice of media and format needs to be contextualized in different media cultures, and consequentially it undergoes different audio-visual policies: for instance, Kevill, S. and Connock, A. (2013) underline that in the UK branded content suffers of more restrictions than in other countries, (e.g.US and Italy). This is explained through the analysis of the regulatory frame, looser for what regards the advertising in the US, and much more liberal about product placement and branded content. It can be argued that: ***(hypothesis 3)** the less the regulatory restrictions, the more is the insinuation of sponsoring third-parties in the media contents.* Besides the media culture, however, there is another culture to consider: the brand culture. The literature review in fact indicates that a branded content, essentially, is about that very emotional engagement that a product can give only if associated to a set of values and beliefs, which are enclosed in the so-called *brand culture*, appropriately narrated through the brand storytelling – as already mentioned (see

Introduction). Herskovitz, S. and Crystal, M., 2010 explain how brand storytelling can be a catalyst of the process of brand learning for the customer, which allows landing faster to the step of the “call-to-action” of the AIDA Model (Lewis, St Elmo E. 1898), that means purchase intention. Besides the storytelling, there is also another factor to take into account – when thinking about an effective branded content: the communicational pact embedded in the branded content. In this sense, the managerial literature (Branded Content LAB 2013) suggests that a high level of *brand storytelling* is an optimal tool for branded content to raise brand awareness and reach a good purchase intention, but only if associated to an *explicit valorisation* of the communicational pact with the audience. In this research, in fact, are outlined four different valorisations of the latter - according to its different degree of *innovation*, *involvement* and *storytelling*: the first is the *explicit valorisation* of the communicational pact (even though there is no effective centrality of the product, this form results very strong about the purchase motivation, thanks to high levels of involvement and innovation); the second is the *ludic valorization*, which is not finalized to the commercial purpose (it takes advantage of the mechanism of empathy generated by the pure fun, but it does not grant any return on investments either on the brand image or on the purchase intention, since the experience is standing alone). Then there is the *seductive valorization*, in between the involvement and the storytelling: it is weak on innovation, and it does not highlight the concrete aspects of the product/brand. Finally, the *instrumental valorization*: although being more capable of highlighting the product/brand, this results less functional to the purpose of branded content if compared to the 1<sup>st</sup> and 3<sup>rd</sup> valorisations: here, the communicational code is closer to the traditional advertising and therefore less able to boost the specific aspects of the Branded Entertainment. From the studies just mentioned, indeed, it is possible to develop the next two hypotheses: ***hypothesis 4*** (if a brand wants to raise brand awareness in order to reach a good intention-to-buy, this is more likely with an explicit valorisation, combined with a good level of Storytelling) and ***hypothesis 5*** (the more articulated is the “Brand Storytelling”, the more likely the intention-to-buy and purchasing effect will be). The very same research just mentioned (Branded Content Lab 2013) has also defined the three most common marketing approaches of the managers (problematic, critic and editorially-led approach) towards branded content: the first is ruled by the objectives of the *reputation and brand building*, but less by the ones of customer generation/retention. The second is more focused on *commercial* objectives, while the latter - used by those managers who normally choose the branded content marketing as a marketing strategy - pursues the objectives of the *traffic generation* (on the brand website or company blog) and the one of the support to the *commercial action* (customer retention, prospect generation and brand loyalty). Hence, the ***hypothesis 6***: the marketing approach influences the decision to use a branded content and also the choice of its type. The abovementioned ‘critic’ and ‘problematic’ approaches’ clusters of marketing managers struggle - unlike the editorially-led

approach cluster– in seeing the branded content as a highly effective marketing strategy, mainly because of difficulties encountered in its assessment and measurement. It can be implied that *the type of assessment influences the perception of branded entertainment as a strategy for brand-holders* (***hypothesis 7***). Finally, in closing the literature review, it is worth to go back to the hypothesis 2, which can be integrated with what found by analysing the regulatory frames analysed in this research (Romani Decree, 2010; Ofcom Broadcasting Code, 2010, Audiovisual & media policy, 2012). The latter, in fact, legislate about other issues – more cultural and ethical than strictly legal - besides the integrity of broadcasters from the presence of advertising and third-parties sponsors in media content: for instance, these laws focus on the protection of the minors, or the banning of product placement relative to tobacco, prescription-only medicines and alcoholic drinks, and also about the independency of the current affairs and news programs, which must be devoid of brand placement in order to maintain its status “super-partes” - as well as the religious programs. According still to Kevill and Connock (2013), this does not necessarily happen in other markets like the US one or the Chinese one, so it is easy to prove that the media culture (not only laws but also shared beliefs and costumes of a society) influences the likelihood of having a branded content marketing strategy, since if there are too many restrictions about the branded content it is likely that marketing managers of some companies (e.g. a tobacco company) will not choose branded content as a tool of their strategy. ***Hypothesis 8: the type of media ethic and culture is tightly connected to the legal frame and this influences the likelihood of having branded entertainment as a marketing strategy for the brand holders***

## 2.2 The theoretical frame

By accepting the hypotheses just developed, a conceptual framework (Figure 1) has been created in order to demonstrate the relationships between branded content and the brand system. In particular, through *brand storytelling*, the *branded content* (whose creation is influenced both by the contextual frame and the brand-holders' perspective) influences the *attitude of the audience towards the brand*, acting as a catalyst on *brand building* (or *brand shift*) and *brand knowledge* (composed of *brand awareness* and *brand image*). These three last mentioned factors directly operate on *brand equity*. To achieve this original conceptual model, the study has analysed and tested with positive results several factors, attaining thus some main outcomes: a) the incidence of branded content on three factors influencing brand equity: brand awareness, brand building and brand image; b) an analysis of the characteristics that branded content needs to have in order to engage the audience (level of integration, brand storytelling, consistency with the format and type of media chosen, type of valorization); c) the main factors influencing the branded content marketing strategy, both from the contextual perspective and from the brand holders' perspective; d) cross-sectional main differences among the Italian audience and the

British one in perceiving branded content. The overall assumption hereby is that, beyond being a mere tool for entertaining the audience and the brands' customers, branded content boosts in the audience a positive attitude toward the brand, building the brand in the consumers' minds and therefore affecting positively the brand equity. Here, the definition of 'brand equity' and the related theoretical frame taken in consideration, among the various branding models, is the *Customer Based Brand Equity model*, outlined by Keller, K.L. (1993), according to whom: 'Customer-based brand equity is defined as the differential effect of brand knowledge on consumer response to the marketing of the brand. (...) Brand knowledge is defined in terms of brand awareness and brand image and is conceptualized according to the characteristics and relationships of brand associations described previously. Consumer response to marketing is defined in terms of consumer perceptions, preferences, and behaviour arising from marketing mix activity (e.g., brand choice, comprehension of copy points from an ad, reactions to a coupon promotion, or evaluations of a proposed brand extension)''

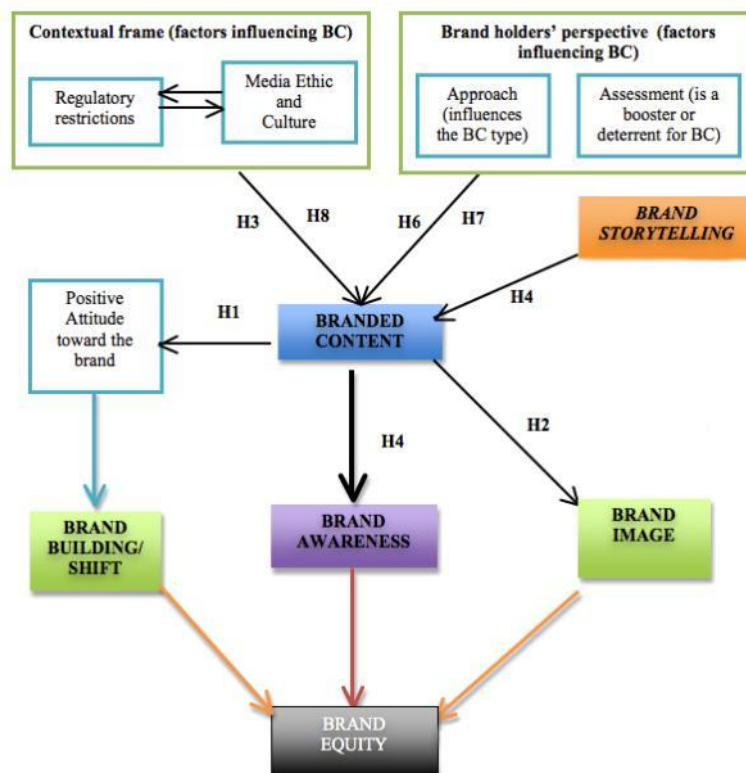

Figure 1. Branded Content: a perspective in the Branding frame

### 3. THE EXPLORATIVE STUDY

#### 3.1 Methodology

In order to validate the hypotheses and the related conceptual frame just outlined, the authors have carried out an empirical research across two countries (UK, Italy), consisting of: an on-line quantitative

questionnaire among a sample audience of 347 individuals (175 Italian 169 British), 11 qualitative semi-structured interviews among international media companies with internal creative divisions for brand entertainment. As far as it concerns the qualitative research, altogether, 11 vis-a vis interviews were conducted to subjects in high-level corporate roles (e.g., VP, Marketing Director, Director of Ad Sales, Creative Director) of media companies, branded content companies, broadcasters and media agencies. The data for the quantitative research, instead, has been collected through an Internet-mediated questionnaire submitted via Facebook, email and LinkedIn, with a redemption of 99% (344 valid responses). The sampling has been stratified and non probabilistic, with a random selection. Besides the place of residence, the sample has been identified on the basis of other 3 parameters: gender (M/F), profession (professional/self-employed, employee, student/unoccupied) and age/generations - as identified by de Pelsmacker et alii, 2013: baby boomers (age: 46-65) generation X (36-45) and generation Y (20-35). The task was to watch and assess two branded content videos, chosen because of their features dichotomized: a 10' documentary B2C "made in Italy" ("Illy Artists of the Taste") and a B2B "made in UK" branded content ("Bacardi True Original", a 2' video streamed on YouTube and meant for bartenders). Through the questionnaire (4 questions about the individuals socio-demographic profile and 5 questions about the videos' perception) the sample has expressed its attitude towards branded content, allowing the researchers to evaluate: a) the effects of a branded content on the brand knowledge (brand awareness and brand image) in a sample audience; b) cross-sectional main differences in perception of the branded content among different generational targets and individuals living in different countries' media contexts.

### *3.2 Hypotheses testing and main findings*

The data obtained from the explorative study have been used to validate the hypotheses developed after the literature review. Following, the results of every hypothesis' testing:

- H1 (*accepted*). To test this hypothesis, the first step was to understand which one of the two branded videos taken in consideration in the quantitative questionnaire has shown more integration between the brand and the media content - according to the questionnaire interviewees' perception who responded to the Q2: "In your opinion, which is the role of the brand(s) in this kind of content? From graph 1 it is possible to notice that the sum of the percentages of people who considered the brand Illy as "part of the story" and/or "protagonist of the story" is 51,5 %, while 47,4% with respect to Bacardi where - moreover - many people (29,4%) recognize the branded video as "simple advertising".



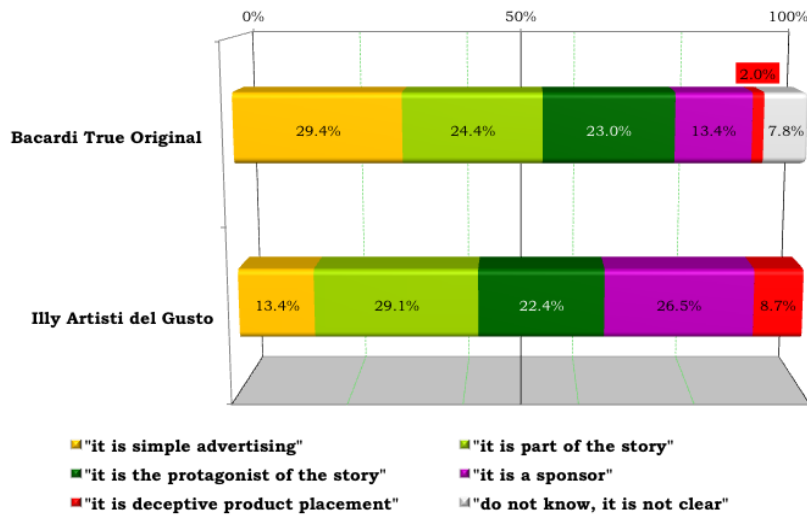

Graph 1. The role of the brand in the content. Source: Own production from primary research data

The next step to test the hypothesis was to see if the brand that has resulted to be the most integrated with the content (Illy) generates the best brand attitude toward the brand: question n°3 (Q3). Every possible response to the question corresponded to a certain brand objective: *“It makes me wanting to try the product”* → Intention to buy/Prospect Generation; *“It suggested new advantageous uses of the product”* → Lead Generation and/or Customer Retention; *“It makes me wanting to know the brand”* → Prospect Generation; *“It brought me closer to the brand”* → Customer Retention; *“It increased my trust in the brand”* → Customer loyalty (as defined by Delgado-Ballester, E. and Munuera-Aleman, J.L, 2001); *“It changed my attitude toward the brand”* → Brand Shift or Brand Building.

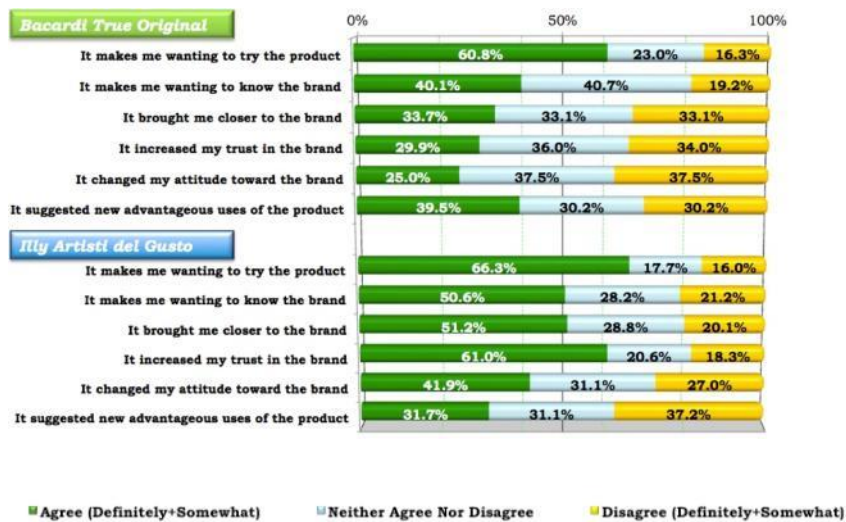

Graph 2. Branded content’s effect on attitude towards product and brand (Q3 responses) - Total averages (of both branded contents). Source: Own production from primary research data

As it is possible to see from the graph 2, Illy has more percentages of agreement than Bacardi with the statements/responses regarding the brand: it can be affirmed that it generates the best brand attitude

toward the brand, therefore the hypothesis seems to be supported both by secondary and primary research, and then accepted.

- H2 (*accepted*). According to the quantitative data, Illy's branded content - more than Bacardi's one - inspires a positive attitude in the people interviewed, because it is a documentary streamed on a big broadcaster, and this format is more adapt to increase trust because it has more time to set a connection with the audience, which is more difficult to reach at the same extent with a branded video of 2'.

- H3 (*accepted*). The qualitative data are consistent with this hypothesis, since the Ofcom Broadcasting Code 2010 and the BBC Editorial Guidelines (documents handled by the director of one of the companies interviewed) suggests that there cannot be logos well visible on the screen, while the EU branded content law (Audio-visual and media policy) allows this.

- H4 (*accepted*). The hypothesis' statement is consistent with the quantitative data, since both the branded videos s *explicit valorisation* and a high level of *brand storytelling*, and as it can be seen from the responses to the Q1 (*"Have you recognized the presence of one or more brand(s) in these videos"* Yes/No), 98,8% of the interviewed has answered 'Yes', while only 1,2% has not recognized brands in these videos. That is the level of *brand recognition* that, together with the *brand recall*, constitute the brand awareness, which in turn is a component of the brand knowledge - a parameter affecting directly the brand equity: the level of brand recognition here means that the brand awareness of the audience is significantly high.

- H5 (*rejected*). To test this hypotheses, we took in consideration the Q4 of the qualitative questionnaire: *"How much do you agree, on a scale from 1 to 5, with the statement 'the video made me wanting to try the product'?"*. The majority of the interviewees agreed that Illy's video makes them wanting to try the product (66% against 60% of Bacardi). However, the results to Q5 showed that it was Bacardi to result the branded video with a higher level of Brand Storytelling, denying the hypothesis' correlation.

- H6 (*accepted*). The hypothesis is consistent with the qualitative because both the branded videos analysed show several characteristics of the second cluster of managers, the ones which pursues the objectives of the *traffic generation* (on the brand website or company blog) and support to the *commercial action* (customer retention, prospect generation and brand loyalty) within the dimensions of entertainment and engagement. This is confirmed also by the qualitative data: both Illy and Bacardi fall within the category of *editorially-led marketing approach*, even though belonging to different sectors, since Illy is addressed to the customers (B2C field), while Bacardi wants to engage the bartenders, both as mavens and fellow businessmen (B2B field).

- H7 (*accepted*). The hypothesis is consistent with the quantitative data collected from the branded content agency Precious Media and the media agency Repucom: the Valuation Model of the latter and the Master Assessment Method of the first are, in fact, their strengths in presenting the results to their

customers, since they use KPIs bounded to the media world, but also are connected to the Return of Marketing Investments, which is the kind of data that brand-holders and managers currently understand and use to evaluate any marketing tool that could be useful for their own brands - branded content included.

- H8 (*accepted*). The hypothesis is consistent with the qualitative data, since BBC's representative *Philip Almond* - Director of Marketing & Audiences at BBC- has confirmed the impossibility of the BBC to make branded content, while instead BBC Worldwide can do that, since operates outside UK.

#### 4. MANAGERIAL IMPLICATIONS AND CONCLUSIONS

From the data analysis of the quantitative research it has emerged that branded content is an effective marketing communication tool, since the sample has responded positively to Q3, and regardless Place of Residence, Age/Generation, Gender and Profession. In fact, the Place of Residence has not resulted to be a significant variable because both people living in UK and in Italy have appreciated the branded content as a tool for getting them closer to the brand and the product (see graph 3), entailing that in Italy and UK the audiences are positioned on a similar level in accepting the branded content.

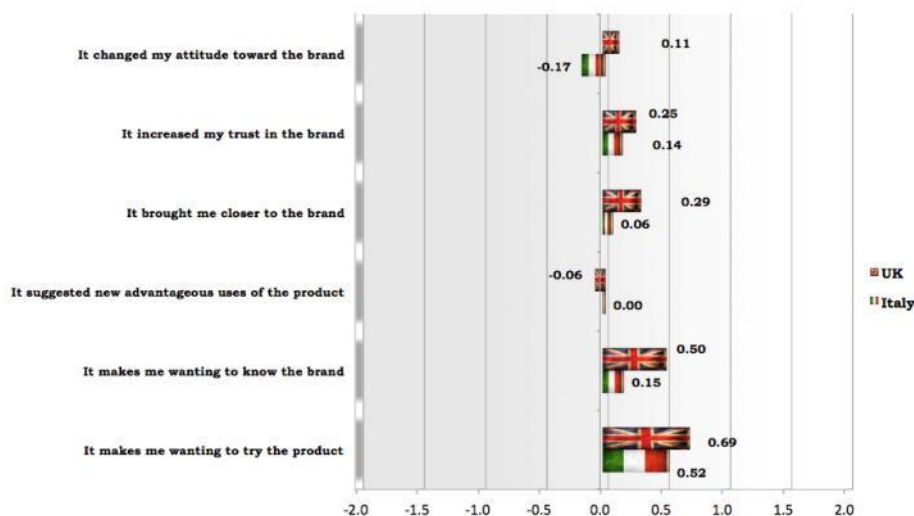

Graph 3 - Branded content's effect on attitude towards product and brand (Q3 responses) – Total averages (of both branded contents) per category: Place of Residence. Source: Own production from primary research data

From the managerial point of view, this is important for brand-holders when planning their communication strategy, because they can rely on branded content effectiveness in both the countries. The same results appear about different generations: the variable age/generation, in fact, has resulted to be not very significant either in the variance of the responses.

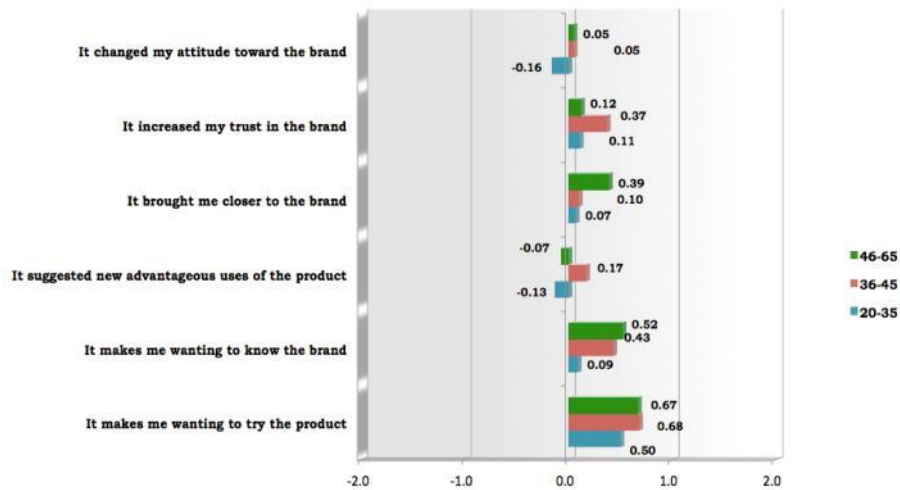

Graph 4 – Branded content’s effect on attitude towards product and brand (Q3 responses)– Total averages (of both branded contents) per category: Age/Generation. Source: Own production from primary research data

In definitive, this means that branded content is an effective marketing communication tool well received both by different age ranges (though very dissimilar) and by the British and Italian audiences (despite of the considerable socio-cultural differences that cross the two countries). In addition, the results confute also the assertion (Branded Content LAB 2013) that a B2B content cannot use a same marketing approach both for stakeholders and consumers, since here Bacardi has proven to be effective on a consumers’ sample.

## 5. LIMITATIONS AND FURTHER RESEARCH

The overall conclusion, hereby, is that our hypotheses are worth to be further investigated in a research or conceptual study, in order to understand how and how much branded content can influence brand equity. However, there are some limits to be considered in reading this overall conclusion: the branded entertainment panorama here analysed only refers to Occidental productions (mainly European, Canadian and American), as all together they constitute the magnitude of worldwide distribution. In addition, there is a possibility that the brands appearing in the TV shows are currently running a marketing campaign, which may influence the effectiveness of the branded content. Moreover, on the ground that the Keller’s brand equity model is a static framework, only short-term memory effects (brand recall) has been investigated for the case studies analysed - thus excluding effectiveness on long-term memory, which would have required a longitudinal study. For what regards the primary research, further research needs to be considered in order to close some gaps: firstly, from the research does not appear a direct correlation between the branded content strategy and the effect on the brand

holders' sales, due to the fact that the brand holders and the company interviewed preferred not to disclose the revenues in terms of ROMI (because of privacy issues). Secondly, when analysing the legislative frame in Italy, which allows state-owned broadcasters like RAI to have product placement, an unexpected variable emerged from the words of Eleonora Costa (Head of Marketing at Endemol Italia): the economical one. That is why, in analysing the contextual frame, future research should investigate a broader set of variables – besides the legislative one – that influence the branded content's creation. Finally, for what regards specifically the quantitative research, further investigation should be made in order to analyse the effect of all the variables on branded content's perception (also Gender, Profession) that in this study have not been analysed with the same attention paid to the other variables (Place of Residence, Age/Generation).

## REFERENCES

- Aldas-Manzano, J., Curras-Perez, R., Sanchez-Garcia, I. (2013). "Factors contributing brand attitude in advergames: Entertainment and irritation", *Journal of Brand Management* 04-05/2013, Vol.20(5), 374-388.
- Anderson, C. (2007). *The long tail: How endless choice is creating unlimited demand*. Random House.
- BBC Editorial Guidelines. Available at: <http://www.bbc.co.uk/editorialguidelines/page/guidelines-editorial-integrity-product-placement> (accessed: 12/01/2015).
- Bonsignore, P., Sassoon J. (2014). *Branded Content-La nuova frontiera della comunicazione d'impresa*. FrancoAngeli, Milano.
- Boyland, E. J., & Halford, J. C. (2013). "Television advertising and branding. Effects on eating behaviour and food preferences in children". *Appetite*, 62, 236-241.
- Branded Content LAB – a project of University of Milan "Cattolica" and UPA (2013) "Le strategie di Branded Content Marketing delle aziende operanti in Italia", by R. Nelli, P.Bensi and A.Carminati. Report 2/2013.
- De Mooij, M., & Hofstede, G. (2010). "The Hofstede model: Applications to global branding and advertising strategy and research", *International Journal of Advertising*, 29(1), 85-110.
- De Pelsmacker, P., Geuens, M.; Van den Bergh, J. (2013). *Marketing Communication: A European Perspective*, 5th Edition, Pearson Education Limited.
- Delgado-Ballester, E., & Luis Munuera-Alemán, J. (2001) "Brand trust in the context of consumer loyalty", *European Journal of Marketing*, 35(11/12), pp. 1238-1258.
- Directive "Audio-visual and Media Policy" of the European Commission, (2012). Available at:[http://ec.europa.eu/archives/information\\_society/avpolicy/reg/tvwf/advertising/product/index\\_en.htm](http://ec.europa.eu/archives/information_society/avpolicy/reg/tvwf/advertising/product/index_en.htm) (Accessed: 23/10/2016)
- Erdem, T., & Sun, B. (2002). "An empirical investigation of the spillover effects of advertising and sales promotions in umbrella branding", *Journal of Marketing Research*, 39(4), 408-420.
- Grainge, P. (2012) "A song and dance: Branded entertainment and mobile promotion", *International Journal of Cultural Studies*, 15(2): 165–180.
- Hansen, F., & Christensen, L. B. (Eds.). (2003). *Branding and advertising*. Copenhagen Business School Press, DK.
- Herskovitz, S. and Crystal. M. (2010). "The essential brand persona: storytelling and branding", *Journal of Business Management*, Vol. 31 N. 3 2010, pp. 21-28
- Holt, D. (2016). "Branding in the age of social media", *Harvard business review*, 94(3), 13.
- Hudson, S., & Hudson, D. (2006). "Branded entertainment: a new advertising technique or product placement in disguise?", *Journal of Marketing Management*, 22(5-6), 489-504.
- Hudson, S., & Tung, V. (2016). "Appealing to tourists via branded entertainment: From theory to practice", *Journal of Travel & Tourism Marketing*, 33(sup1), 123-137.
- Keller, K.L. (1993). "Conceptualizing, Measuring, and Managing Customer-Based Brand Equity", *Journal of Marketing*, 57
- Lehu J. M. (2007). *Branded Entertainment: Product Placement & Brand Strategy in the Entertainment Business*, Kogan Page

- Lei, S. S. I., Pratt, S., & Wang, D. (2016). "Factors influencing customer engagement with branded content in the social network sites of integrated resorts". *Asia Pacific Journal of Tourism Research*, 1-13.
- Lewis, St Elmo E. (1898). *Financial Advertising (The History of Advertising)*. Garland
- Lotz, D. A. (2007) *Television will be revolutionized*. New York University Press
- Lundqvist, A., Liljander, V., Gummerus, J. et al. (2013). "The impact of storytelling on the consumer brand experience: The case of a firm-originated story", *Journal of Brand Management* 20: 283. doi:10.1057/bm.2012.15
- Ofcom's "Broadcasting Code Review and Annexes" (2010) Available at: <http://stakeholders.ofcom.org.uk/consultations/bcrtv2010/statement/> (accessed: 05/02/15)
- Percy, Larry (2003) "Advertising and brand equity", Hansen, F., & Christensen, L. B. (Eds.), *Branding and advertising*. Copenhagen Business School Press, DK. 12-21.
- Repetto, M. (2006) "L'advertainment tra fiction e reality. Prospettive di sviluppo nell'era digitale", *Brand Life*.
- Reuters Institute for the Study of Journalism- Oxford University (2013) "Ask the Audience: Evaluating New Ways to Fund TV Content" by S.Kevill, A. Connock, Available at: <https://reutersinstitute.politics.ox.ac.uk/publication/ask-audience> (accessed: 20/10/2016).
- Romani Decree (2010). Available at: <http://www.camera.it/parlam/leggi/deleghe/10044dl.htm> (Accessed: 12/01/2016)
- Russell, C. A. (2007) "Advertainment: Fusing Advertising and Entertainment". Available at: [http://www.bus.umich.edu/facultyresearch/researchcenters/centers/yaffe/downloads/advertainment\\_teaching\\_materials.pdf](http://www.bus.umich.edu/facultyresearch/researchcenters/centers/yaffe/downloads/advertainment_teaching_materials.pdf) (accessed: 18/07/2016)
- Stone, L. (1998) transcript of Stone's talk at the 2006 "O'Reilly Emerging Technology" conference. Available at: <http://lindastone.net/qa/continuous-partial-attention/> (Accessed: 05/03/2017)
- Toffler, Alvin (1980) *The Third Wave*. Bantam Books Publisher
- Valero, D. (2014). *Branded Entertainment: Deal making Strategies & Techniques for Industry Professionals*. J. Ross Publishing
- Woodside, A. G. (2010) "Brand-Consumer Storytelling Theory and Research: Introduction to a Psychology & Marketing Special Issue", *Psychology & Marketing*, Vol. 27(6): 531-540
- [www.brandforum.it](http://www.brandforum.it) (website of the Italian Cultural Observatory on Brand Activity)

## TECHNOLOGY TRANSFER AS DRIVER OF SMART GROWTH: A QUADRUPLE / QUINTUPLE INNOVATION FRAMEWORK APPROACH

Carayannis, Elias<sup>1</sup>; Caputo, Francesco<sup>2</sup>; Del Giudice, Manlio<sup>3</sup>

<sup>1</sup>George Washington University School of Business, Washington, DC

<sup>2</sup>Department of Pharmacy, University of Salerno, Fisciano, Italy

<sup>3</sup>Department for Research, University of Rome "Link Campus", Rome, Italy

### ABSTRACT

In recent years, increased attention is being given to the concept of knowledge and its management implications for the future of business. Today, these works are also influenced by the recent developments in technology transfer, seen as a 'pathway' for accelerating economic system growth and advancement.

Starting from these preliminary reflections, this research consists in a proposed system for classifying international literature on the topic of Knowledge and Technology Transfer (K&T2). The links connecting the various works is re-interpreted - including through several case studies - in the context of the Quadruple / Quintuple Innovation Helix Framework (Carayannis et al., 2015a; 2016b), outlining the possible implications of a change in perspective for traditional models.

The proposed reflections are the first step whereby management studies can be used to define new models and instruments for managing the complex relationship between Knowledge and Technology Transfer in the multi-actor knowledge era. For professional communities, these reflections offer useful indications on how to define management models that can help them to gain a greater understanding of the dynamics of context and, therefore, introduce better means of governance.

A new and different approach to technology transfer is proposed in this paper. Technology transfer is analyzed not only in terms of the practical implications of knowledge management, but also by highlighting the two-way relationship between knowledge and technology, together with the need to develop a common model for the actors involved in the processes of generation and transfer. This model can be used to increase the positive effects of the processes on company dynamics and to address the issues of increased scarcity of resources and greater competitive rivalry.

*Keywords: Knowledge; Technology Transfer; Knowledge and Technology Transfer; Service Systems; Quadruple Innovation Helix Framework; Quintuple Innovation Helix Framework; Information asymmetry*

## INTRODUCTION AND SOME PRELIMINARY REFLECTIONS ON EVOLUTION AND CHANGES IN THE KNOWLEDGE ERA

Many changes have occurred to influence the market and its evolution over the past few years. Globalization, changes to consumer behaviour, greater competitiveness and the pressure from scarce resources are only some of the issues that organizations, institutions and, more in general, social actors have had to face over recent times

In evolving, society has upset the traditional balance among the actors involved in social and economic processes, meaning that it is now necessary to re-think models and instruments which are no longer capable of handling the emerging challenges of context (Carayannis and Stewart 2013; Cecere 2015).

Accordingly, several research streams are being developed to propose more efficient solutions that focus on different aspects, such as *customer behaviour* (Hallowell 1996; Jensen 2015), *effects of rules and protocols* (Bettman and Park 1980; Sadiq and Governatori 2015), *systems of accountability* (Roberts and Scapens 1985; Gray et al. 1996; Bebbington et al. 2014), *development of core competences* (Teece and Pisano 1994; Prahalad and Hamel 2006; Holahan et al. 2014), *management and governance of complexity* (Espejo 1992; McElroy 2000) and so on.

All these studies have offered interesting contributions to the advancement and understanding of knowledge systems and social phenomena, but their focus is limited and, in some cases, cannot provide a general overview of the processes taking place (Carayannis and Alexander, 1999, Di Nauta et al. 2015, Caputo, 2017).

To overcome these limitations, it is necessary to extrapolate common elements from the recent developments and analyse their properties more thoroughly, with the view of defining a general scheme that can help in the understanding and management of new socio-economic configurations.

By observing the recent pathways from both economic and social point of view, it is possible to note that “perspectives from and about different parts of the world and diverse human, socio-economic, technological, and cultural contexts are interwoven to produce an emerging new worldview on how specialized knowledge, that is embedded in a particular socio-technical context, can serve as the unit of reference for stocks and flows of a hybrid, public/private, tacit/codified, tangible/virtual good that represents the building block of the knowledge economy, society, and polity” (Carayannis and Campbell 2012: 3).

It is clear, at this point, that the key element in the recent developments is knowledge, seen as a “critical factor affecting an organization’s ability to remain competitive in the new global marketplace” (Bollinger and Smith 2001: 8).

Nevertheless, the traditional approach to knowledge is not useful for understanding the new world that is emerging before our eyes and, apparently, it cannot cope with explaining the processes on which the new reality is based. To overcome these limitations, it is necessary to combine studies on



knowledge with the 'strong' contribution of works on the technology-based approach to management (Del Giudice et al., 2012; Battistella et al. 2015; Di Fatta et al., 2016; Caputo and Wallezky, 2017).

Several solutions have been proposed in these contributions, stressing the potential influence of technology to management processes, in order "to understand knowledge and its uses in various aspects of the business, the motivational and attitudinal factors necessary to get people to create, share, and use knowledge effectively, and the ways to use technology to enhance knowledge activities" (Davenport and Völpel 2001: 2015).

The real advancements of studies on the contribution of technology to the processes of management are, in any case, concerned with clarifying the ways by which knowledge can be encapsulated into a tangible resource (software, processes, databases, etc.) and transferred to other actors (Blackler 1995; Del Giudice et al., 2016)

By offering explanations through technology-based studies, it is possible to understand how a conceptual idea becomes concrete and how it impacts on the general socio-economic environment. However, it is still not possible to understand why some ideas become tangible and can easily be transferred in the form of new technology, while other equally good ideas come across many more hurdles in the process of turning into actual real new technology.

In the following sections, the paper contains a short analysis and classification of the studies covering the relationship between Knowledge and Technology Transfer (section two) with a summary of the methodological approach and the research pathway. A possible conceptual framework built upon the Quadruple Helix model is then proposed, to help the understanding of the elements that impact on a potential Knowledge and Technology Transfer (K&Tt) process (section three). The key elements for a new common model of management are then presented (section four) with several final remarks and practical implications (section five).

## **THE CONTRIBUTION OF LITERATURE IN THE MANAGEMENT AND UNDERSTANDING OF TECHNOLOGY TRANSFER**

The growing complexity of the relationships on which civil society and economic activity are founded is such that new models of management are needed to propagate behavioural patterns based on the tacit and shared knowledge that is connected by means of organizational routines (Bogenrieder and Nooteboom 2004; Barile et al. 2013; Del Giudice et al. 2013a).

In recent years, the growing attention on this topic has had a positive influence in seeding and creating knowledge and has also underlined the relevance of knowledge-sharing as a critical element in the success of organizations and for the process of co-creating knowledge (Del Giudice and Maggioni 2014; Caputo and Evangelista, 2017).

By recognizing that the new market is configured as a cognitive entity, it is possible to understand how the transfer of critical knowledge from one actor to another can help in managing the barriers to knowledge transfer (Ardichvili et al. 2003; Del Giudice et al. 2017) and of contextualization (Nonaka and Takeuchi 1995).

Starting from these assumptions, it is possible to note how the relationship between knowledge, technology and the process of turning an idea into a physical reality - “tangibilization” - (Hyötyläinen and Möller 2007) has been emphasized in various contributions to literature. The worth of these studies is to have proposed solutions for encapsulating knowledge into a physical medium and, therefore, helping the process of transferring it from one actor to other, as an ongoing operation over time (Newell et al. 2009). In this perspective, it can be underlined that knowledge is made up of several components and that it can be embedded in different devices (Sharif and Ramanathan 1987). Knowledge concerns both the technological and physical characteristics of what is being transferred (the technoware component) and typically resides in the easily transferable physical support.

These different contributions are strongly influenced by the transactional approach, where knowledge is considered a resource that should be “sold” to the market and technology is the instrument that ensures its transfer (Chapman and Buckley 1997).

It is necessary to specify that knowledge transfer can concern different elements, such as *technology* (Flannery et al. 1994), *knowledge* (Liyanage et al. 2009) and *know-how* (Ferdows 2006). For each of them, it is possible to identify several forms of transfer each with their own properties and processes (Davenport and Prusak 2000).

In this articulated scenario, technology transfer is seen as an active process in which technology is transferred between distinct entities (Amesse and Cohendet 2001; Cummings and Teng 2003; Bozeman et al. 2015).

Autio and Laamanen (1995: 652) have defined the transfer of technology as an “intentional, goal-oriented interaction between two or more social entities, during which the pool of technological knowledge remains stable or increases through the transfer of one or more components of technology”.

Technology transfer is, therefore, a process-oriented interaction between two or more entities, with the purpose of improving the transferred technology (Argote and Ingram 2000).

Several authors (Flannery et al. 1994; Gilbert and Cordey-Hayes 1996) have identified the temporal stages involved in a “transfer process” and Szulanski, in 2000, identified the following phases:

- The *start-up phase* arises from the need for technology and knowledge to be expressed in their relative context. The discovery of a gap between existing technology and knowledge and the contextual need drives the search for external solutions.

- The second phase is *implementation*. After the decision to transfer knowledge has been made, attention shifts to the exchange of information and resources between companies. The companies form relationships to interact together and simplify the flow of information and resources. In this step, there can be issues relating to an inability of bridging the communication gap between the source and the recipient of the technology.
- Once the recipient has started to use the transferred technology, the *ramp-up* phase begins. The main interest, in this phase, is to identify and solve unexpected problems connected to the new context in which the technology has been inserted.
- In the final phase, *integration*, new technology gradually becomes routine and generates know-how. Technology is integrated into the organization, losing its novelty but, if the receiver is unable to change and integrate it, the technology could be abandoned, with the receiver turning back to the previous state. The problems in this case could depend on organizational balance and on the ability of overcoming internal resistance to change.

The transfer process illustrated above underlines the fact that it is not simple to implement technology transfer in practice. The process is possible only if the recipient learns the new techniques and acquires new knowledge, otherwise, the recipient will not be able to take full advantage of the all benefits (Carayannis et al., 2006). Gaining greater understanding of the developments in the approach to Knowledge and Technology Transfer can be useful, especially in connection with the role of the user, who is not simply a recipient but an actor who can collaborate to the creation, design and transfer of knowledge and technology (Stewart 1987; Terrett 1998).

It is clear that, when technology is transferred, the knowledge and the skills needed to use it should also be integrated within the company that will use the technology. The transfer of know-how is the link between knowledge and technology (De Toni et al. 2012)

In this framework, collaboration and integration are essential elements for the aim of producing and transferring knowledge and technology that can support management activity.

Although the topic of technology transfer is a highly debated subject, with many studies focusing on particular aspects of technology transfer, there are few comprehensive studies that deal with the parameters and levers that are to be considered when designing and implementing a process of technology transfer.

In the knowledge era, technology transfer between the involved companies can be represented by a two-way arrow. This metaphor implies that the transfer concerns reciprocity and feedback. The process requires interaction among the parties and the relational context is a significant aspect (Carayannis et al 2016b; in press b).

Organizational culture is increasingly being recognized as a major barrier to technology transfer because it influences, at different levels, the creation, sharing and use of knowledge.

De Long and Fahey (2000: 116) identified four ways in which culture influences behaviour and, specifically, by:

- moulding the assumptions about what knowledge is and which knowledge is worth managing;
- defining the relationship between individual and organizational knowledge, determining who is expected to control any specific knowledge, as well as who must share it and who can hoard it;
- creating the context for social interaction that determines how knowledge will be used in particular situations;
- shaping the processes by which new knowledge -with its accompanying uncertainties- is created, made legitimate and distributed within organizations.

These four points can be used to suggest what actions in particular can be taken by managers to assess the different aspects of culture most likely to influence knowledge-related behaviour. By underlining the central role of users as key actors who can influence all the phases of the processes on which Knowledge and Technology Transfer are based (Seufert et al. 1999), the four points also provide a summary of the more recent approaches to K&Tt.

Starting from this contribution, the growing feeling is that there is a need to change the approach to Knowledge and Technology Transfer from a transactional approach to a relational approach, where the aim is to involve and exploit the knowledge of the interested actors (Grönroos 1997; Paun 2011; Campanella et al. 2013a, 2013b; Carayannis et al. 2014).

The contributions offered in the literature on the topic of knowledge and technology transfer can be synthesized into three different phases:

- *First phase*, based on 'selling' knowledge and technology to users outside the process of generating the knowledge and technology and who even, sometimes, are not able to understand the value of the resources purchased, or manage them appropriately.
- *Second phase*, in which the processes of generation and transfer of knowledge and technology open up to potential users, in order to gain a greater understanding of their needs.
- *Third phase*, where producers and users are part of the same process and their collaboration and integration is essential in achieving the joint aim of producing and transferring knowledge and technology in support of management activity.

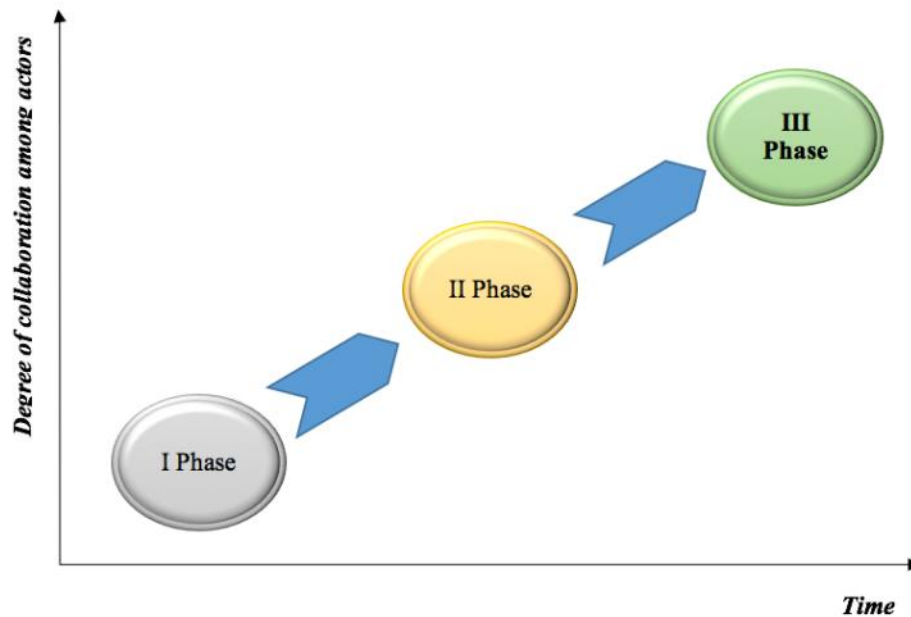

Figure 1. A representation of evolution in the approach of K&Tt (Source: Our elaboration)

#### *Methodology approach and pathway of research*

In the current socio-economic environment -in which models and behaviour are driven by globalization, competitiveness and scarcity of resources- knowledge can play a significant role, but it can no longer be held within individual productive units or be managed in a hierarchical manner. Knowledge must, necessarily, be shared at all levels of business systems and outside these systems.

The transfer of knowledge between two specific entities can take place through several ways. These include selling knowledge, opening and integrating knowledge between companies and sharing knowledge.

The paper consists in a qualitative analysis (Maylor and Blackmon 2005; Myers 2013) of the relationship between Knowledge and Technology Transfer, in which it is emphasized that the development of approaches based on collaboration and integration can enable companies to share knowledge and start a seeding process in a virtuous circle of knowledge co-creation.

The specific aim in the paper is to analyse the shift from a transactional to a relational approach, offering a possible conceptual framework that can help researchers and professionals in the understanding and governance of a changing scenario (Barile et al. 2015a).

As result, in our research, we have paid particular attention to the following aspects:

- the importance of knowledge in the emerging socio-economic environment;
- the contribution of technology transfer as a means to combine the competence and capabilities of different actors within the same processes, with the purpose of increasing the opportunities for sharing knowledge/technology;

- the Quadruple Helix model as a framework for stimulating changes to the rules of knowledge co-creation;
- the need for management models that can help in the process of moving from a transactional to a relational approach.

Data acquisition was conducted through a single-method approach using secondary research sources.

These sources include, but are not limited to:

- three databases, specifically EBSCO, Google Scholar and Scopus;
- existing literature on Knowledge and Technology Transfer;
- articles and evidence from the companies that have applied the Quadruple Helix model.

The findings of the study are presented and discussed in the following sections.

## **BUILD UPON THE QUADRUPLE / QUINTUPLE INNOVATION HELIX FRAMEWORKS TO DEFINE A NEW PERSPECTIVE IN THE STUDY OF TECHNOLOGY TRANSFER**

The approach to the management, creation and dissemination of knowledge was -for a long time- influenced by a transactional approach in which 'resource knowledge' was produced by a specific group of actors or company area and "sold" to the market as way of solving an existing problem (Massingham 2014).

This approach was based on an ability to 'read' market progress and -applying a problem-solving logic- propose customized solutions in situations where traditional instruments could not help.

Over time, this logic identified, in the support offered by technology, a tool that could improve the traditional instruments used to study the market, in terms of their rapidity of application and affordability. This was a great opportunity to optimize traditional management instruments and define new business models.

Unfortunately, the expanding market competitiveness, the effects of globalization and the pressure of resource scarcity have together compromised the balance between approach to knowledge management, the contribution of technology and its application to business. More and more often, market dynamics follow a non-linear logic whereby there is the need to improve models and instruments -with the involvement of the various actors- so that they all play an active role in the production of new knowledge and its contextual use in addressing the challenges imposed by market change (Barile 2013; Carayanniset al., 2014; 2016a).

"Knowledge then is not transferred but must be continuously created and recreated through networking as individuals come to share a common understanding or a common frame of reference" (Swan et al. 1999: 263).

There is, to all effects, a shift from a *linear approach* -in which knowledge is generated, layered (“the stratification of knowledge”), transformed into tangible objects (such as technology innovation) and then transferred to the user- to a *cyclic approach*, in which generation of knowledge requires the involvement of the user and, consequently, the contextual elaboration and transfer of technology to back the understanding and management of market dynamics (Carayannis and Grigoroudis, 2014, 2016a; Carayannis et al., 2015b).

This shift is the beginning of a new era in management studies.

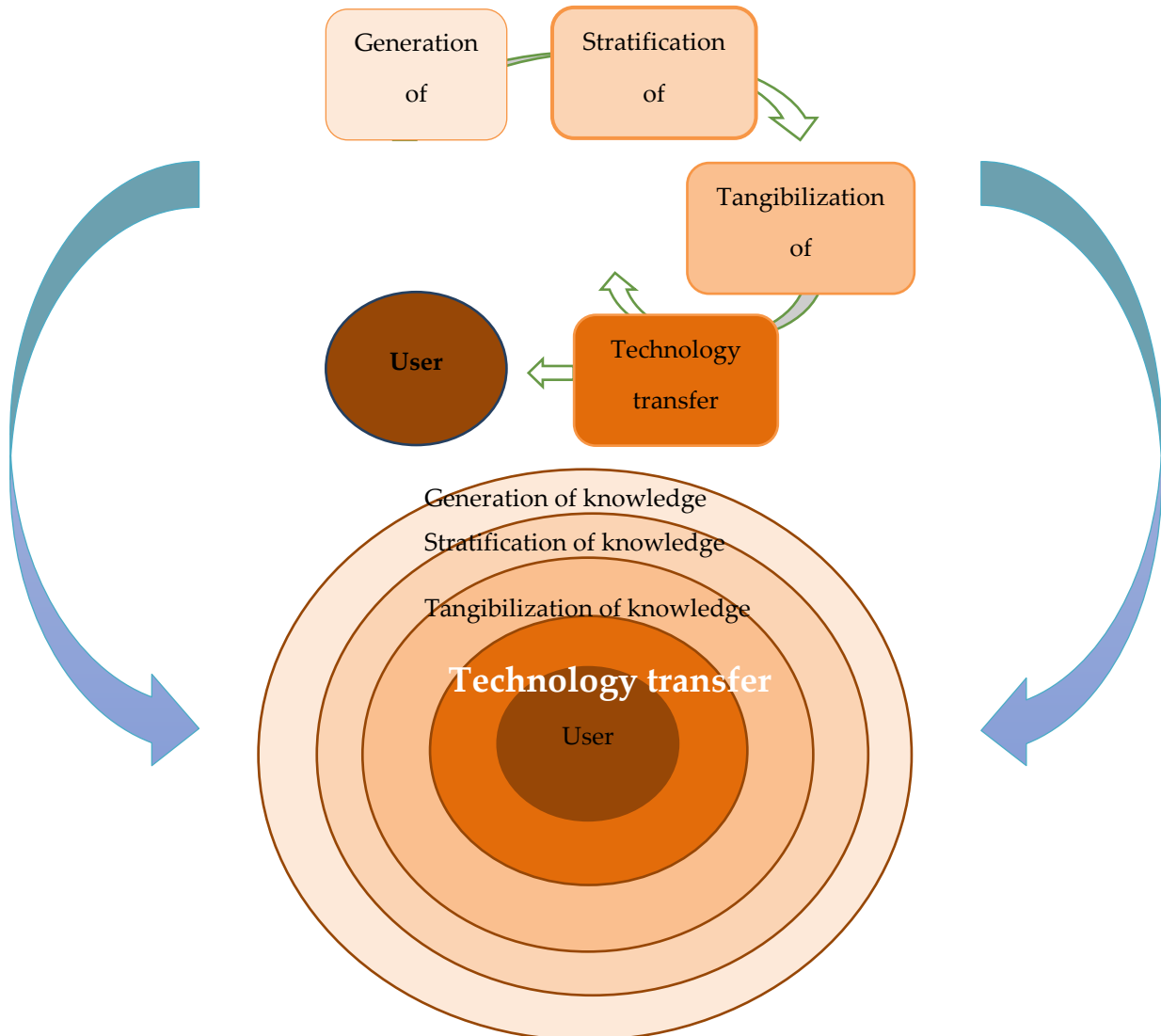

Figure 2. From linear approach to cyclic approach in the knowledge and technology transfer process (Source: Our elaboration)

The new challenge for researchers and professionals is to understand how Knowledge and Technology Transfer is linked and what implications are concerning the new emerging balance.

This challenge must be met with a new approach combining competences, knowledge and capabilities. In addition, researchers are faced with two significant questions: *Who are the actors involved in the K&Tt process?* and *How can the relationships among these actors be understood and managed?*

Carayannis and Campbell (2012) offer a contribution along these lines. Building upon the “Triple Helix” model developed by Etzkowitz and Leydesdorff (2000), they include a “fourth helix” alongside the helices of University, Industry and Government. The fourth helix is the “media-based and culture-based public” as well as the “civil society” (Carayannis and Campbell 2012: 13).

The potential contribution of this model lies in the fact that it highlights the opportunities generated by the synergic collaboration among the interested actors. In this perspective, Etzkowitz and Zhou have analyzed the implications of introducing a fourth helix to the original model, emphasizing that “introduction of a fourth helix might cause a triadic model to lose its creative dynamic. Nevertheless, an expanded model is required to incorporate a critical dimension” (2006: 78).



Figure 3. A representation of the Quadruple Helix model (Source: Adaptation from Carayannis and Campbell, 2012: 14)

In our perspective, the model proposed in Figure 3 shows the actors involved in the knowledge and technology transfer process, underlining, at the same time, the importance of culture as an element with significant influence over the relationships between the involved actors (Carayannis and Campbell, 2009; Barile and Saviano 2014).

According to our view, the concept at the basis of this model is that value co-creation, perceived as “joint problem solving, which involves supplier and customer resources integrated in a collaborative interaction process. Suppliers apply their specialized professional skills, methods and judgment, while customers contribute resources such as knowledge, in order to create optimal value-in-use” (Aarikka-Stenroos and Jaakkola 2012: 17).



This is a paradigmatic change from the traditional approach to managing business activities since it combines the traditional *competitive oriented approach* with a *collaborative perspective*, involving all the interested actors and exploiting their potential, with the function of achieving aims that are not possible through an individual approach (Saviano and Caputo 2013; Iandolo et al. 2013).

However, looking at the model presented in Figure 3 to illustrate technology transfer, it may seem that, to make the transfer easy, it is simply request to link the various actors together and involving them in the same structure. In this perspective, it is hard to explain why some processes fail even though they consist in linking different actors within the same structure. In our view, the reason for this can be explained by including other elements in the Quadruple Helix model (Tab. 1).

<i>Examples</i>	<i>Causes of failure</i>
<p><b>Skolkovo Innovation Center</b> is “composed of companies and start-ups, developing innovative technologies (currently numbering over 1,000), a Technopark, the Skolkovo Institute of Technology (Skoltech), a new graduate research” (<a href="http://sk.ru/foundation/about/">http://sk.ru/foundation/about/</a>).</p> <p>This centre was planned with the aim of attracting economic and human resources interested to the topic of technology innovation.</p>	<p>These initiatives were planned without taking into account the needs or trends of the territory. The relative programmes are only concerned with the tangibilization of new ‘idea’, but do not relate to the territory. The perspective followed is influenced by a transactional approach to technology transfer.</p>
<p><b>Tech City</b> in UK “was launched in Shoreditch in 2010 by the UK Prime Minister David Cameron to support the East London tech cluster known as Silicon Roundabout. We have since grown our support to Greater London and other cities around the UK” (<a href="http://www.techcityuk.com/about-us/">http://www.techcityuk.com/about-us/</a>).</p>	
<p><b>Nordic Climate Cluster (NoCC)</b> “was launched on 7 April 2008.,[...their] partners aim to create global centres of excellence in environmentally friendly energy and improved environmental technologies through industrial and scientific collaboration” ( <a href="http://www.nordforsk.org">http://www.nordforsk.org</a>).</p>	

Table 1. Examples of failures in K&Tt the process and the relative explanation under the proposed perspective

From this point of view, the real challenge in terms of managing the co-creation process in the context of knowledge and technology transfer is to find a means of improving the alignment in culture and values between the actors. Only in this way is it possible to imagine an easy approach to co-creating knowledge and, consequently, a greater probability for improving and optimizing technology transfer among the actors (Carayannis and Alexander, 1999; Alvesson 2000; Barile et al. 2014; Polese et al. 2016; Dominici et al. 2017).

The focus should then shift from the technical instruments that support technology transfer to the social aspects that impact on the process of alignment. The reason for this is to back a change in perspective, so that technology and knowledge are not simply resources to sell according to a *transactional approach* -in a win-lose logic where one actor can evolve only by hurting the others- but it is need to shift toward a *relational approach* where knowledge and technology are co-created in an open socio-technical system where production and transfer are simultaneous (Golinelli et al. 2012; Calabrese et al. 2017; Tronvoll et al. 2017).

Due to the developments taking place, there is the need for a greater investigation into the role played by the ‘fourth helix’ in the process of co-creation. This process can help us to understand the importance of alignment among the actors in terms of “degree to which an organization’s design, strategy, and culture are cooperating to achieve the same desired goals. It is a measurement of the

agreement or relative distance between several ideal and real elements of organizational life" (Sender 1997: 23).

In this perspective, K&T processes should be analysed not so much in terms of "managed process of conveying a technology from one party to its adoption by another party" (Souder et al. 1990: 5), but as "intentional, goal-oriented interaction between two or more social entities, during which the pool of technological knowledge remains stable or increases through the transfer of one or more components of technology" (Autio and Laamanen 1995: 647).

The implications of the proposed change are important if analysed with reference to the conceptual framework proposed in the Quadruple Helix model because "Media-based and culture-based public" and "civil society" cannot simply be considered as another dimension in the same process, but as the key indicators for identifying possible pathways of alignment among the three other helices (Carayannis et al., 2017b; in press a).

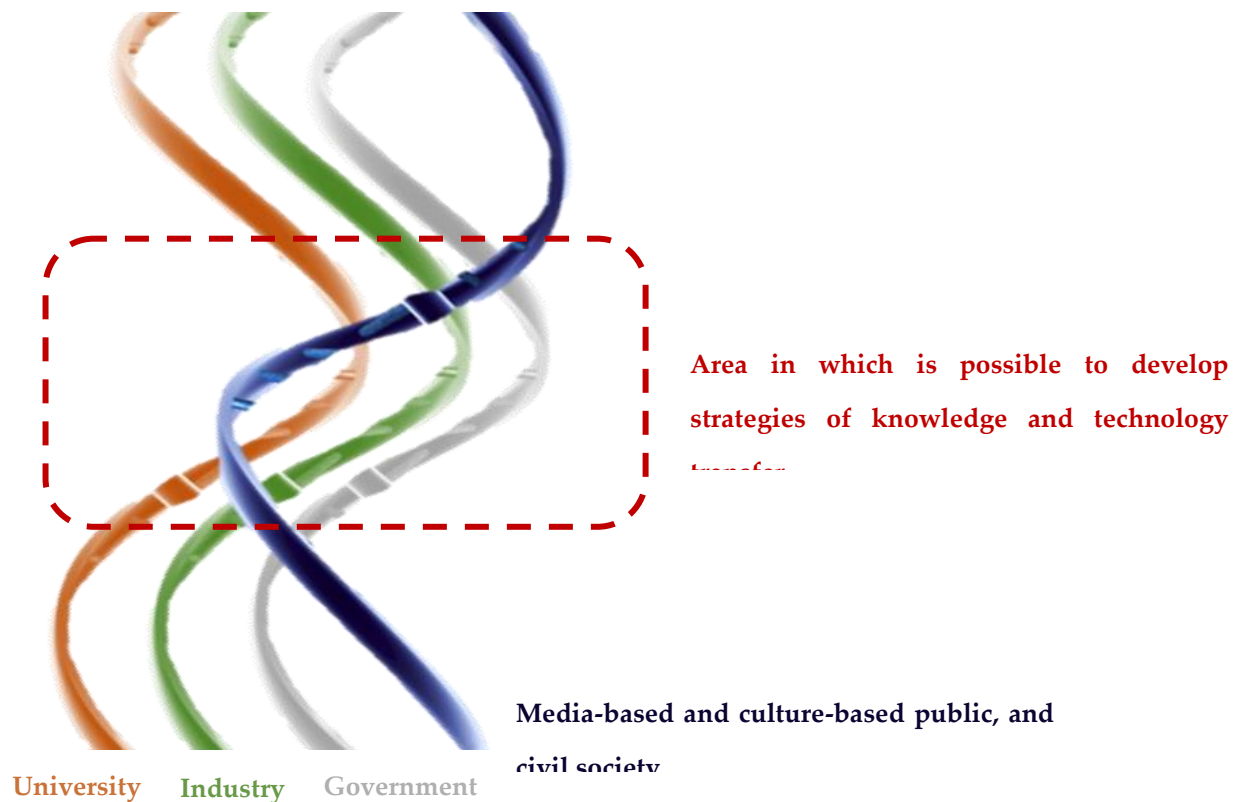

Figure 4. A re-reading of Quadruple Helix model (Source: Our elaboration from Carayannis and Campbell, 2012: 14)

In other words, media-based and culture-based public, and civil society -taken together, as one- can be seen as the 'element' required to connect the actors in the Triple Helix Model, directing their actions and strategies toward common aims. The real advancement in the management of technology transfer in the knowledge era is to recognize the importance of this element in terms of identifying *how* and *if* it

is possible to replicate the cases of success involving unplanned cultural and social alignment (Table 2).

<i>Examples</i>	<i>Causes of success</i>
<p>“The <i>Global Cleantech Innovation Programme (GCIP)</i> for small- and medium-sized enterprises (SMEs) is a far-reaching programme that leverages the power of entrepreneurship to address the energy, environmental and economic problems. [...] It selects start-ups in each country to participate in a competitive national programme that trains, mentors, promotes them as well as connects them with potential investors, customers and partners”.</p> <p>(<a href="http://www.unido.org/en/what-we-do/environment/energy-access-for-productive-uses/partnerships-and-networks/global-cleantech-innovation-programme.html">http://www.unido.org/en/what-we-do/environment/energy-access-for-productive-uses/partnerships-and-networks/global-cleantech-innovation-programme.html</a>)</p>	<p>Programmes involve actors that are influenced by a similar perspective concerning the management of natural, economic and human resources.</p> <p>They are based on the continuous interaction among all the actors involved in the network with the purpose of improving informational and cultural alignment.</p>
<p>The <i>Global Network of Regional Sustainable Energy Centres</i> “respond to the urgent need for increased regional cooperation and capacities to mitigate existing barriers to renewable energy and energy efficiency investment, markets and industries. They complement and strengthen ongoing national activities in the areas of policy and capacity development, knowledge management and awareness raising, as well as investment and business promotion. There is a common understanding that some ‘soft’ barriers for RE&amp;EE can be addressed more effectively and at a lower cost through regional approaches and methodologies”.</p> <p>(<a href="http://www.unido.org/en/what-we-do/environment/energy-access-for-productive-uses/partnerships-and-networks/global-network-of-regional-sustainable-energy-centres.html">http://www.unido.org/en/what-we-do/environment/energy-access-for-productive-uses/partnerships-and-networks/global-network-of-regional-sustainable-energy-centres.html</a>)</p>	
<p>The <i>Low Carbon Low Emission Clean Energy Technology Transfer (LCET)</i> is promoted by the United Nations Industrial Development Organization (UNIDO) and the Ministry of Economy, Trade and Industry of Japan (METI). It is articulated “in three phases to promote the transfer of low carbon technologies:</p> <ul style="list-style-type: none"> <li>- Develop selection criteria to initially identify and screen technologies that could be replicated and repeatedly demonstrated.</li> <li>- Conduct a feasibility study of identified LCETs vis-à-vis the current techno-socioeconomic needs; and</li> <li>- Implement pilot projects, including capacity building, for local counterparts”.</li> </ul> <p>(<a href="http://www.unido.org/en/what-we-do/environment/energy-access-for-productive-uses/partnerships-and-networks/low-carbon-technology-transfer.html">http://www.unido.org/en/what-we-do/environment/energy-access-for-productive-uses/partnerships-and-networks/low-carbon-technology-transfer.html</a>)</p>	

Table 2. Examples of success in the K&Tt process and the relative explanation under the proposed perspective

Therefore, alignment towards the same entity of media-based and culture-based public and civil society is a preliminary condition for every process of Knowledge and Technology Transfer, because transfer of knowledge is only possible between actors who share the same system of meaning (Trompenaars 1995). Consequently, only when all the actors are ‘culturally aligned’ is it possible to consider improving the transfer and, therefore, overcome the traditional logic of competitiveness.

From this perspective, there is the need to shift from models in which technology transfers are seen as cases of *linear information transmission* to models in which they are seen as *processes of interrelating and sense-making* (Weick 1990).

## THE NEED FOR A COMMON AND SHARED MANAGEMENT MODEL

The need for a management model common to all the different actors involved in the Knowledge and Technology Transfer process is a challenge insomuch as it requires a blend of sometimes very different models, information, aims and perspectives (Edvardsson et al. 2012).

It is possible, in this respect, to follow a pathway set out in a study on Information Asymmetry, which involves the analysis of the relationship whereby the “inability to assess quality represents exposure

to two different forms of supplier opportunism, namely, (1) misrepresentation of an outlet's true characteristics and (2) actual quality cheating" (Mishra et al. 1998: 278).

The general part of this study proposes a system of rules, indications, awards and penalties to discourage opportunistic behaviour and to direct individual behaviour towards a common pathway defined through a top down approach (Healy and Palepu 2001; Bhargava and Chen 2012).

While recognizing the contribution of these studies towards solving other problems connected to the transactional approach, we think that they could be used more effectively to understand problems relating to technology transfer if they are combined with the recent advancements in research on Service Systems and, specifically, with studies on the value co-creation (Edvardsson et al. 2011; Grönroos 2011; Wetter-Edman et al. 2014).

In our perspective, a combination of the two approaches can offer interesting stimuli to the debate on Knowledge and Technology Transfer because, by starting from the differences among the actors involved, it is possible to show that it is impossible to shape the way they behave exclusively through a systems of rules.

By overcoming this information asymmetry, it is first necessary to create an improved and more complex system based on the cognitive alignment between the actors (Del Giudice et al. 2013b; Caputo 2016; Caputo et al. 2016a). A new approach for defining strategies, partnership and alliance is also required to overcome the traditional transactional approach which is no longer suitable for addressing the challenges imposed by the current context (Webster 1992; Gummesson 2002; Soto-Acosta et al. 2010).

The success of a programme for Knowledge and Technology Transfer should be evaluated in terms of a possible alignment between the actors. The reason for this is that only by developing models that can handle the problem of *cognitive distance* - "defined broadly as the degree of diversity in research methodologies and in the use and interpretation of knowledge, can influence the process of technology transfer" (Muscio and Pozzalli 2013: 489) - is possible to conceive a socio-technical environment in which knowledge and technology are generated in function of the specific contextual evolution and can be easily transferred and, therefore, be understood more readily and managed more effectively (Meroño-Cerdan et al. 2005, Soto-Acosta et al. 2015).

By moving from a top-down alignment imposed from above to a bottom-up cognitive alignment, it becomes possible to avoid any type of opportunistic behaviour and, at same time, direct all energy, resources and technology along the same pathway, with positive effect on the value of the achieved result (Palacios-Marqués et al. 2015; Caputo et al. 2016b).

Obviously, the proposed change is not simple to implement because it involves altering the traditional and well-consolidated approach to business and to processes of knowledge and technology. It

requires investment in developing the social dimension of the transfer process, because the problem of cognitive distance can be overcome only through continuous interaction. In addition, the approach to human resources must be re-thought together with moving from a logic of 'resource to use' to a vision of 'value to improve'.

To enact the proposed change, there is the need to, for example:

- conceive an educational system which does not only teach the principles of competitiveness,
- develop a social system capable of promoting common values and styles of life,
- promote interaction and relationships not only within the boundaries of specific projects and/or directed at specific aims,
- improve the expertise of policy makers, managers and organizations in terms of finding and promoting pathways for cognitive alignment within organizations and with external actors.

The investment is considerable and it requires substantial effort on the part of policy makers, managers and organizations but, in our view, the opportunities are greater than the costs.

## **FINAL REMARKS, PRACTICAL IMPLICATIONS AND POSSIBLE FUTURE LINES OF RESEARCH**

The possible implications of shifting from the traditional approach to Knowledge and Technology Transfer to a new vision based on relational logic are significant for both researchers and professionals.

A change in perspective in the models of management and governance represents, in the proposed perspective, a challenge that cannot be ignored. University, Industry, Government and civil society are called to work together to face the challenges of this new era (Carayannis and Rakhmatullin 2014), where knowledge is the key resource for competitive advantage in every type of organization (Porter and Miller 1985). Its effects can emerge and it can become tangible only if the actors are able to find a common point of contact (Coleman 1988).

From this point of view, *media-based and culture-based public, and civil society* are the elements to be investigated in order to understand the conditions under which Knowledge and Technology Transfer can be easily promoted.

Many aspects should be considered from this point of view, such as the impact of ethical and cultural variables, the desire on the part of the players to act towards a common goal, institutional and governmental influence and so on.

The work proposed in this research is a first conceptual step, which can be used as the basis on which to build instruments and models for measuring the opportunities linked to the cultural and cognitive alignment of actors during the processes of technology transfer. In this light, a new fascinating

challenge emerges for both researchers and professionals. This is the need to develop a stronger cross-disciplinary approach based on contamination among the different research streams that have recently been examining the role of culture, information and cognitive aspects within the processes of knowledge and technology transfer. A possible aim to pursue is to define the indicators, tools and benchmarks that can help managers to identify the areas in which interaction and transfer are more easily achieved because they are underpinned by the implicit alignment of the actors.

The paper represents a first possible step in a pathway requiring cross-disciplinary contributions. It is a call to the many different actors, urging them to work together towards defining a more efficient, effective and sustainable model in which government, industry, academia and civil participants can work together with the aim to build a sustainable future (Barile et al. 2017; Carayannis et al., 2017a; Saviano et al. 2017a, 2017b).

Perhaps a new path is opening before our eyes and maybe it is time to follow it together.

## REFERENCES

- Aarikka-Stenroos, L., Jaakkola, E. (2012), "Value co-creation in knowledge intensive business services: A dyadic perspective on the joint problem solving process", *Industrial Marketing Management*, Vol. 41 No. 1, pp. 15-26.
- Alvesson, M. (2000), "Social identity and the problem of loyalty in knowledge-intensive companies", *Journal of Management Studies*, Vol. 37 No. 8, pp. 1101-1122.
- Amesse, F., Cohendet, P. (2001), "Technology transfer revisited from the perspective of the knowledge-based economy", *Research Policy*, Vol. 30 No. 9, pp. 1459-1478.
- Argote, L., Ingram, P. (2000), "Knowledge transfer: A basis for competitive advantage of firms", *Organizational Behaviour Human Decision Processes*, Vol. 82 No. 1, pp. 150-169.
- Ardichvili, A., Page, V., Wentling, T. (2003), "Motivation and barriers to participation in virtual knowledge-sharing communities of practice", *Journal of Knowledge Management*, Vol. 7 No. 1, pp. 64-77.
- Argote, L., McEvily, B., Reagans, R. (2003), "Organizational learning curves: A method for investigating intra-plant transfer of knowledge acquired through learning by doing", *Management Science*, Vol. 49 No. 4, pp. 571-582.
- Autio, E., Laamanen, T. (1995), "Measurement and evaluation of technology transfer: review of technology transfer mechanisms and indicators", *International Journal of Technology Management*, Vol. 10 No. 7-8, pp. 643-664.
- Barile, S. (2013, Ed.), *Contributions to Theoretical and Practical Advances in Management. A Viable Systems Approach*, Roma, Aracne.
- Barile, S., Saviano, M. (2014), "Resource integration and value co-creation in cultural heritage management", in Aiello L. (Ed.), *Management of cultural products: e-relationship marketing and accessibility perspectives* (pp. 58-82), New York, IGI Global.
- Barile, S., Carrubbo, L., Iandolo, F., Caputo, F. (2013), "From 'EGO' to 'ECO' in B2B relationships", *Journal of Business Market Management*, Vol. 6 No. 4, pp. 228-253.
- Barile, S., Saviano, M., Caputo, F. (2015a), "How Are Markets Changing? The Emergence of Consumers Market Systems". In Dominici G. (Ed.), *The 3rd International Symposium Advances in Business Management. "Towards Systemic Approach"* (pp. 203-207). Busyness Systems. E-book Series: Avellino.
- Barile, S., Saviano, M., Iandolo, F., Caputo, F. (2017), "La dinamica della sostenibilità tra vortici e correnti: un modello a Tripla Elica", In Borgonovi E., Ailello G. (eds.), *Sviluppo, sostenibilità e competitività delle aziende: il contributo degli economisti aziendali. Atti del Convegno Nazionale dell'Accademia Italiana di Economia Aziendale 2016*, Il Mulino, Bologna.
- Barile, S., Saviano, M., Polese, F. (2014), "Information asymmetry and co-creation in health care services", *Australasian Marketing Journal (AMJ)*, Vol. 22 No. 3, pp. 205-217.

- Battistella, C., De Toni, A. F., Pillon, R. (2015), "Inter-organisational technology/knowledge transfer: a framework from critical literature review", *The Journal of Technology Transfer*, pp. 1-40.
- Bebbington, J., Unerman, J., O'Dwyer, B. (2014), *Sustainability accounting and accountability*, London, Routledge.
- Bettman, J. R., Park, C. W. (1980), "Effects of prior knowledge and experience and phase of the choice process on consumer decision processes: A protocol analysis", *Journal of Consumer Research*, Vol. 7 No. 3, pp. 234-248.
- Bhargava, H. K., Chen, R. R. (2012), "The benefit of information asymmetry: When to sell to informed customers?", *Decision Support Systems*, Vol. 53 No. 2, pp. 345-356.
- Blackler, F. (1995), "Knowledge, knowledge work and organizations: An overview and interpretations", *Organization Studies*, Vol. 16 No. 6, pp. 1021-1046.
- Bogenrieder, I., Nooteboom B. (2004), "Learning groups: what types are there?", *Organization Studies*, Vol. 25 No. 2, pp. 287-314.
- Bollinger, A. S., Smith, R. D. (2001), "Managing organizational knowledge as a strategic asset", *Journal of Knowledge Management*, Vol. 5 No. 1, pp. 8-18.
- Bozeman, B., Rimes, H., Youtie, J. (2015), "The evolving state-of-the-art in technology transfer research: Revisiting the contingent effectiveness model", *Research Policy*, Vol. 44 No. 1, pp. 34-49.
- Calabrese, M., Iandolo, F., Caputo, F., Sarno, D. (2017), "From mechanical to cognitive view: The changes of decision making in business environment", in Barile, S., Pellicano, M., Polese, F. (eds.) *Social Dynamics in a System Perspective*, Springer, New York.
- Campanella, F., Del Giudice, M., Della Peruta, M. R. (2013a), "The role of information in the credit relationship", *Journal of Innovation and Entrepreneurship*, Vol. 2 No. 1, pp. 1-16
- Campanella, F., Della Peruta, M. R., Del Giudice, M. (2013b), "The Role of Sociocultural Background on the Characteristics and the Financing of Youth Entrepreneurship. An Exploratory Study of University Graduates in Italy", *Journal of the Knowledge Economy*, Vol. 4 No. 3, pp. 244-259.
- Caputo, F. (2016), "A focus on company-stakeholder relationships in the light of the Stakeholder Engagement framework", in Vrontis D., Weber Y., Tsoukatos E. (eds.) *Innovation, Entrepreneurship and Digital Ecosystems* (pp. 455-470), EuroMed press, Cyprus.
- Caputo, F. (2017), "Reflecting upon Knowledge Management studies: insights from Systems thinking", *International Journal of Knowledge Management studies* (in press).
- Caputo, F., Evangelista, F. (2017), "Information sharing and cognitive involvement for sustainable workplaces", in Leon R.D. (Ed.), *Managerial Strategies for Business Sustainability during Turbulent Times*. IGI Global, New York.
- Caputo, F., Evangelista, F., Russo, G. (2016a), "Information Sharing and Communication Strategies: a Stakeholder Engagement view", in Vrontis D., Weber Y., Tsoukatos E. (eds.) *Innovation, Entrepreneurship and Digital Ecosystems* (pp. 436-442), EuroMed press, Cyprus.
- Caputo, F., Formisano, V., Buronova, B., Wallezky, L. (2016b), "Beyond the digital ecosystems view: insights from Smart Communities", in Vrontis D., Weber Y., Tsoukatos E. (eds.) *Innovation, Entrepreneurship and Digital Ecosystems* (pp. 443-454), EuroMed press, Cyprus.
- Caputo, F., Wallezky, L. (2017), "Investigating the users' approach to ICT platforms in the city management", *Systems*, Vol. 5 No. 1. doi:10.3390/systems5010001.
- Carayannis, E. G., Campbell D. F. J. (2012), *Mode 3 knowledge production in quadruple helix innovation systems*, New York, Springer.
- Carayannis, E. G., Rakhmatullin, R. (2014), "The Quadruple/Quintuple Innovation Helixes and Smart Specialisation Strategies for Sustainable and Inclusive Growth in Europe and Beyond", *Journal of the Knowledge Economy*, Vol. 5 No. 2, pp. 212-239.
- Carayannis, E. G., Sindakis, S., Walter, C. (2014), "Business model innovation as lever of organizational sustainability", *The Journal of Technology Transfer*, Vol. 40 No. 1, pp. 85-104.
- Carayannis, E.G., Alexander, J. (1999), "The wealth of knowledge: converting intellectual property to intellectual capital in co-opetitive research and technology management settings", *International Journal of Technology Management*, Vol. 18 No. 3-4, pp. 326-352.
- Carayannis, E.G., Alexander, J. (1999), "Secrets of success and failure in commercialising US government R&D laboratory technologies: a structured case study approach", *International Journal of Technology Management*, Vol. 18 No. 3-4, pp. 246-269.
- Carayannis, E. G., Campbell, D. F. (2009), "'Mode 3' and 'Quadruple Helix': toward a 21st century fractal innovation ecosystem", *International Journal of Technology Management*, Vol. 46 No. 3-4, pp. 201-234.
- Carayannis, E., Grigoroudis, E. (2014), "Linking innovation, productivity, and competitiveness: Implications for policy and practice", *Journal of Technology Transfer*, Vol. 39 No. 2, pp. 199-218.
- Carayannis, E., Grigoroudis, E. (2016a), "Using multiobjective mathematical programming to link national competitiveness, productivity, and innovation", *Annals of Operations Research*, Vol. 247 No. 2, pp. 635-655.

- Carayannis, E.G., Grigoroudis, E. (2016b), "Quadruple innovation helix and smart specialization: Knowledge production and national competitiveness", *Foresight and STI Governance*, Vol. 10 No. 1, pp. 31-42.
- Carayannis, E.G., Grigoroudis, E., Campbell, D.F.J., Meissner, D., Stamati D. (in press a), "'Mode 3' universities and academic firms: Thinking beyond the box trans-disciplinarity and nonlinear innovation dynamics within cooperative entrepreneurial ecosystems", *International Journal of Technology Management* (accepted).
- Carayannis, E.G., Grigoroudis, E., Del Giudice, M., Della Peruta, M.R., Sindakis, S. (2017a), "An exploration of contemporary organizational artifacts and routines in a sustainable excellence context", *Journal of Knowledge Management*, Vol. 21 No. 1, pp. 35-56.
- Carayannis, E.G., Grigoroudis, E., Goletsis, T. (2016a), "A multilevel and multistage efficiency evaluation of innovation systems: A multiobjective DEA approach", *Expert Systems with Applications*, Vol. 62, pp. 63-80.
- Carayannis, E.G., Grigoroudis, E., Pirounakis, D. (2015a), "Quadruple innovation helix and smart specialization: Knowledge production and national competitiveness", *Asia-Pacific Tech Monitor*, July-September, 19-27.
- Carayannis, E.G., Grigoroudis, E., Sindakis, S., Walter, C. (2014), "Business model innovation as antecedent of sustainable enterprise excellence and resilience", *Journal of the Knowledge Economy*, Vol. 5 No. 3, pp. 440-463.
- Carayannis, E. G., Popescu, D., Sipp, C., Stewart, M. (2006), "Technological learning for entrepreneurial development (TL4ED) in the knowledge economy (KE): case studies and lessons learned", *Technovation*, Vol. 26 No. 4, pp. 419-443.
- Carayannis, E. G., Stewart, M. R. (2013), "Obsessed maniacs and clairvoyant oracles: empirically validated patterns of entrepreneurial behavior", *Journal of Innovation and Entrepreneurship*, Vol. 2 No. 2, DOI: 10.1186/2192-5372-2-2.
- Carayannis, E.G., Provance M., Grigoroudis, E. (2016b), "Entrepreneurship ecosystems: An agent-based simulation approach", *Journal of Technology Transfer*, Vol. 41 No. 3, pp. 631-653.
- Carayannis, E.G., Goletsis, Y., Grigoroudis, E. (2015b), "Multi-level multi-stage efficiency measurement: the case of innovation systems", *Operational Research: An International Journal*, Vol. 15 No. 2, pp. 253-274.
- Carayannis, E.G., Goletsis, Y., Grigoroudis, E. (2017b), "Composite innovation metrics: MCDA and the quadruple innovation helix framework", *Technological Forecasting and Social Change* (in press).
- Cecere, G. (2015), "The economics of innovation: a review article", *The Journal of Technology Transfer*, Vol. 40 No. 2, pp. 185-197.
- Chapman, M., Buckley, P. J. (1997), *Markets, transaction costs, economists and social anthropologists. Meanings of the Market*, Oxford, Berg.
- Coleman, J. S. (1988), "Social capital in the creation of human capital", *American Journal of Sociology*, Vol. 94, pp. 95-120.
- Cummings, J. L., Teng, B. (2003), "Transferring R&D knowledge: The key factors affecting knowledge transfer success", *Journal of Engineering and Technology Management*, Vol. 20 No. 1, pp. 39-68.
- Davenport, T. H., Prusak, L. (1998), *Working knowledge: How organizations manage what they know*, Boston, Harvard Business School Press.
- Davenport, T. H., Völpe, S. C. (2001), "The rise of knowledge towards attention management", *Journal of Knowledge Management*, Vol. 5 No. 3, pp. 212-222.
- De Long, D. W., Fahey, L. (2000), "Diagnosing cultural barriers to knowledge management", *Academy of Management Perspective*, Vol. 14 No. 4, pp. 113-127.
- De Toni, A. F., Biotto, G., Battistella, C. (2012), "Organizational design drivers to enable emergent creativity in web-based communities", *The Learning Organization*, Vol. 19 No. 4, pp. 335-349.
- Del Giudice, M., Ahmad, A., Scuotto, V., Caputo, F. (2017), "Influences of Cognitive Dimensions on the Collaborative Entry Mode Choice of Small and Medium-Sized Enterprises", *International Marketing Review*, Vol. 34 No. 5, (in press).
- Del Giudice, M., Caputo, F., Evangelista, F. (2016), "How are decision systems changing? The contribution of social media to the management of decisional liquefaction", *Journal of Decision Systems*, Vol. 25 No. 3, pp. 214-226.
- Del Giudice, M., Carayannis, E. G., Della Peruta, M. R. (2012). *Cross-Cultural Knowledge Management and Open Innovation Diplomacy: Definition of Terms*. In *Cross-Cultural Knowledge Management* (pp. 117-135). Springer New York.
- Del Giudice, M., Della Peruta, M. R., Maggioni, V. (2013a), "Collective Knowledge and Organizational Routines within Academic Communities of Practice: an Empirical Research on Science-Entrepreneurs", *Journal of the Knowledge Economy*, Vol. 4 No. 3, pp. 260-278.
- Del Giudice, M., Della Peruta, M. R., Maggioni, V. (2013b), "Spontaneous processes of reproduction of family-based entrepreneurship: an empirical research on the cognitive nature of the spin-offs", *Journal of Innovation and Entrepreneurship*, Vol. 2 No. 1, pp. 1-14.



- Del Giudice, M., Maggioni, V. (2014), "Managerial practices and operative directions of knowledge management within inter-firm networks: a global view", *Journal of Knowledge Management*, Vol. 18 No. 5, pp. 841-846.
- Di Fatta, D., Caputo, F., Evangelista, F., Dominici, G. (2016), "Small world theory and the World Wide Web: Linking small world properties and website centrality", *International Journal of Markets and Business Systems*, Vol. 2, No. 2, DOI: 10.1504/IJMABS.2016.080237
- Di Nauta, P., Merola, B., Caputo, F., Evangelista, F. (2015), "Reflections on the Role of University to Face the Challenges of Knowledge Society for the Local Economic Development", *Journal of the Knowledge Economy*, pp. 1-19.
- Dominici, G., Yolles, M., Caputo, F. (2017), "Decoding the dynamics of value cocreation in consumer tribes. An Agency Theory approach", *Cybernetics and Systems. An International Journal*, Vol. 48 No. 2, pp. 84-101.
- Dubina, I.N., Campbell, D.F.J., Carayannis, E.G., Chub, A.A., Grigoroudis, E., Kozhevina O.V. (in press b), "The balanced development of the spatial innovation and entrepreneurial ecosystem based on principles of the systems compromise: A conceptual framework", *Journal of the Knowledge Economy*.
- Edvardsson, B., Skälén, P., Tronvoll, B. (2012), "Service systems as a foundation for resource integration and value co-creation", *Review of Marketing Research*, Vol. 9 No. 2, pp. 79-126.
- Edvardsson, B., Tronvoll, B., Gruber, T. (2011), "Expanding understanding of service exchange and value co-creation: a social construction approach", *Journal of the Academy of Marketing Science*, Vol. 39 No. 2, pp. 327-339.
- Espejo, R. (1992), "Management of complexity in problem solving", *Transactions of the Institute of Measurement and Control*, Vol. 14 No. 1, pp. 8-16.
- Etzkowitz, H., Leydesdorff, L. (2000), "The dynamics of innovation: from National Systems and "Mode 2" to a Triple Helix of university-industry-government relations", *Research Policy*, Vol. 29 No. 2, pp. 109-123.
- Etzkowitz, H., Zhou, C. (2006), "Triple Helix twins: innovation and sustainability", *Science and Public Policy*, Vol. 33 No. 1, pp. 77-83.
- Ferdows, K. (2006), "Transfer of changing production know-how", *Production and Operations Management*, Vol. 15 No. 2, pp. 1-9.
- Flannery, W. T., Spivey, W. A., Alter, W. A. (1994), "A heuristic model of the technology transfer process in federal laboratories", *Technology Management*, Vol. 1 No. 3, pp. 94-100.
- Golinelli, G. M., Barile, S., Saviano, M., Polese, F. (2012), "Perspective Shifts in Marketing: Toward a Paradigm Change?", *Service Science*, Vol. 4 No. 2, pp. 121-134.
- Gray, R., Owen, D., Adams, C. (1996), "Accounting & accountability: changes and challenges in corporate social and environmental reporting", UK, Prentice Hall.
- Grönroos, C. (1997), "Value-driven relational marketing: from products to resources and competencies", *Journal of Marketing Management*, Vol. 13 No. 5, pp. 407-419.
- Grönroos, C. (2011), "Value co-creation in service logic: A critical analysis", *Marketing Theory*, Vol. 11 No. 3, pp. 279-301.
- Gummesson, E. (2002), "Relationship marketing in the new economy", *Journal of Relationship Marketing*, Vol. 1 No. 1, pp. 37-57.
- Hallowell, R. (1996), "The relationships of customer satisfaction, customer loyalty, and profitability: an empirical study", *International Journal of Service Industry Management*, Vol. 7 No. 4, pp. 27-42.
- Healy, P. M., Palepu, K. G. (2001), "Information asymmetry, corporate disclosure, and the capital markets: A review of the empirical disclosure literature", *Journal of Accounting and Economics*, Vol. 31 No. 1, pp. 405-440.
- Hyötyläinen, M., Möller, K. (2007), "Service packaging: key to successful provisioning of ICT business solutions", *Journal of Services Marketing*, Vol. 21 No. 5, pp. 304-312.
- Holahan, P. J., Sullivan, Z. Z., Markham, S. K. (2014), "Product development as core competence: how formal product development practices differ for radical, more innovative, and incremental product innovations", *Journal of Product Innovation Management*, Vol. 31 No. 2, pp. 329-345.
- Iandolo, F., Calabrese, M., Antonucci, E., Caputo, F. (2013), "Towards a value co-creation based healthcare system", in Gummesson, E., Mele, C, Polese, F. (Eds.), *The 2013 Naples Forum on Service. Service Dominant Logic, Networks & Systems Theory and Service Science: Integrating three Perspectives for a new Service Agenda*, Naples, Giannini editore.
- Jensen, H. R. (2015), "Creating and maintaining sustainable relationships with customers in consumer markets", in *Proceedings of the 1997 World Marketing Congress* (pp. 631-635), New York, Springer International Publishing.
- Liyanage, C., Elhag, T., Ballal, T., Li, Q. (2009), "Knowledge communication and translation - A knowledge transfer model", *Journal of Knowledge Management*, Vol. 13 No. 3, pp. 118-131.

- Massingham, P. (2014), "An evaluation of knowledge management tools: Part 1-managing knowledge resources", *Journal of Knowledge Management*, Vol. 18 No. 6, pp. 1075-1100.
- Maylor, H., Blackmon, K. (2005), *Researching business and management*, New York, Palgrave Macmillan.
- McElroy, M. W. (2000), "Integrating complexity theory, knowledge management and organizational learning", *Journal of knowledge management*, Vol. 4 No. 3, pp. 195-203.
- Meroño-Cerdan, A. L., Soto-Acosta, P. (2005), "Examining e-business impact on firm performance through website analysis", *International Journal of Electronic Business*, Vol. 3 No. 6, pp. 583-598.
- Mishra, D. P., Heide, J. B., Cort, S. G. (1998), "Information asymmetry and levels of agency relationships", *Journal of Marketing Research*, Vol. 54 No. 4, pp. 277-295.
- Muscio, A., Pozzali, A. (2013), "The effects of cognitive distance in university-industry collaborations: some evidence from Italian universities", *The Journal of Technology Transfer*, Vol. 38 No. 4, pp. 486-508.
- Myers, M. D. (2013), *Qualitative Research in Business & Management*, London, UK, Sage.
- Newell, S., Robertson, M., Scarbrough, H., Swan, J. (2009), *Managing knowledge work and innovation*, Basingstoke, UK, Palgrave Macmillan.
- Nonaka, I., Takeuchi, H. (1995), *The knowledge creating organization: how Japanese companies create the dynamics of innovation*, New York, Oxford University Press.
- Palacios-Marqués, D., Soto-Acosta, P., Merigó, J.M. (2015), "Analyzing the effects of technological, organizational and competition factors on Web knowledge exchange in SMEs", *Telematics and Informatics*, Vol. 32 No. 1, pp. 23-32.
- Paun, F. (2011), "From Managing Information Asymmetries Towards a Systemic Asymmetries Approach in Technology Transfer and Innovation Strategies: An Economic Analysis of the SME Strategy at ONERA-The French Aerospace Lab (TM)", *IUP Journal of Knowledge Management*, Vol. 9 No. 4, pp. 27-52.
- Polese, F., Caputo, F., Carrubbo, L., Sarno, D. (2016), "The value (co)creation as peak of social pyramid", in Russo-Spena T., Mele C. (eds.), *Proceedings 26th Annual RESER Conference, "What's ahead in service research: new perspectives for business and society"* (pp. 1232-1248), RESER, University of Naples "Federico II".
- Porter, M. E., Millar, V. E. (1985), "How information gives you competitive advantage", *Harvard Business Review*, Vol. 63 No. 4, pp. 149-167.
- Prahalad, C. K., Hamel, G. (2006), "The core competence of the corporation", in Hahn, D., Taylor, B. (eds.) *Strategische Unternehmensplanung. Stand und Entwicklungstendenzen* (pp. 275-292), Berlin Heidelberg, Springer.
- Roberts, J., Scapens, R. (1985), "Accounting systems and systems of accountability—understanding accounting practices in their organisational contexts", *Accounting, Organizations and Society*, Vol. 10 No. 4, pp. 443-456.
- Sadiq, S., Governatori, G. (2015), "Managing regulatory compliance in business processes", in vom Brocke, J., Rosemann, M. (Eds.), *Handbook on Business Process Management. Strategic Alignment, Governance, People and Culture* (pp. 265-288), Berlin Heidelberg, Springer.
- Saviano, M., Barile, S., Spohrer, J., Caputo, F. (2017a), "A service theory contribution to the global challenge of sustainability", *Journal of Service Theory and Practice*, Vol. 27, No. 5, (in press).
- Saviano, M., Caputo, F. (2013), "Managerial Choices between Systems, Knowledge and Viability", in Barile S. (Ed.), *Contributions to Theoretical and Practical Advances in Management. A Viable Systems Approach* (pp. 219-242), Rome, Aracne.
- Saviano, M., Nenci, L., Caputo, F. (2017a), "The financial gap for women in the MENA region: a systemic perspective", *Gender in Management: an International Journal*, Vol. 32, No. 4, (in press).
- Saviano, M., Polese, F., Caputo, F., Wallezky, L. (2016), "A T-shaped model for rethinking higher education program", in 19th Toulon-Verona International Conference Excellence in Services - Conference Proceedings (pp. 425-440).
- Sender, S. W. (1997), "Systematic agreement: A theory of organizational alignment", *Human Resource Development Quarterly*, Vol. 8 No. 1, pp. 23-40.
- Seufert, A., Von Krogh, G., Bach, A. (1999), "Towards knowledge networking", *Journal of Knowledge Management*, Vol. 3 No. 3, pp. 180-190.
- Soto-Acosta, P., Casado-Lumbreras, C., Cabezas-Isla, F. (2010), "Shaping human capital in software development teams: the case of mentoring enabled by semantics", *IET Software*, Vol. 4 No. 6, pp. 445-452.
- Soto-Acosta, P., Popa, S., Palacios-Marqués, D. (2015), "E-business, organizational innovation and firm performance in manufacturing SMEs: An empirical study in Spain". *Technological and Economic Development of Economy*, DOI: 10.3846/20294913.2015.1074126.
- Souder, W. E., Nashar, A. S., Padmanabhan, V. (1990), "A guide to the best technology-transfer practices", *The Journal of Technology Transfer*, Vol. 15 No. 1-2, pp. 5-16.

- Stewart Jr, C. T. (1987), "Technology transfer vs. diffusion: A conceptual clarification", *The Journal of Technology Transfer*, Vol. 12 No. 1, pp. 71-79.
- Swan, J., Newell, S., Scarbrough, H., Hislop, D. (1999), "Knowledge management and innovation: networks and networking", *Journal of Knowledge Management*, Vol. 3 No. 4, pp. 262-275.
- Szulanski, G. (2000), "The process of knowledge transfer: A diachronic analysis of stickiness", *Organizational Behavior and Human Decision Processes*, Vol. 82 No. 1, pp. 9-27.
- Teece, D., Pisano, G. (1994), "The dynamic capabilities of firms: an introduction", *Industrial and corporate change*, Vol. 3 No. 3, pp. 537-556.
- Terrett, A. (1998), "Knowledge management and the law firm", *Journal of knowledge management*, Vol. 2 No. 1, pp. 67-76.
- Trompenaars, F. (1995), *Riding the Waves of Culture: Understanding Cultural Diversity in Business*, London, Nicholas Brealey.
- Tronvoll, B., Barile, S., Caputo, F. (2017), "A systems approach to understanding the philosophical foundation of marketing studies", in Barile, S., Pellicano, M., Polese, F. (eds.) *Social Dynamics in a System Perspective*. Springer, New York.
- Webster Jr, F. E. (1992), "The changing role of marketing in the corporation", *The Journal of Marketing*, Vol. 56 No. 5, pp. 1-17.
- Weick, K. E. (1990), "Technology as equivoque: Sensemaking in new technologies", in Goodman, P. S., Sproull L. S. (Eds), *Technology and Organisations* (pp. 1-44), San Francisco, CA: Jossey-Bass.
- Wetter-Edman, K., Sangiorgi, D., Edvardsson, B., Holmlid, S., Grönroos, C. Mattelmäki, T. (2014), "Design for Value Co-Creation: Exploring Synergies between Design for Service and Service Logic", *Service Science*, Vol. 6 No. 2, pp. 106-121.
- Wolpert, J. D. (2002), "Breaking out of the innovation box", *Harvard Business Review*, Vol. 80 No. 8, pp. 77-83.

## RECENT ISSUES ON CORPORATE GOVERNANCE: THE EFFECTS OF THE “PRECAUTIONARY RECAPITALISATION”

Cardi, Mavie

Department for Research, University of Rome "Link Campus", Rome, Italy.

### ABSTRACT

The paper concerns recent issues on corporate governance, in terms of impact on the stability and safety of financial system as a whole and, in particular, in the context of “precautionary” recapitalisation.

The research moves from some recent trends of the international discipline, Basel III above all, and *Directive* No. 2013/36/EU (so called CRD IV), as well as the *Draft Guidelines on internal governance*, recently published by the *European Banking Authority* (EBA), that gave new input to banking corporate governance regulation.

The analysis summarizes the objectives of the current regulation and the reasons of the special nature of corporate governance of banks due to the public interest and institutional function performed by financial intermediaries in the economic process, compared to non financial either industrial companies.

A particular case study concerns - in this context - the measures recently introduced by Italian legislation, with regard to the so called *precautionary* banking recapitalisation and the effects of these measures on corporate governance.

*Keywords: Corporate Governance, Risk Management, Regulatory Framework, Basel III, CRD IV, Italian Precautionary Recapitalisation, Restructuring Plans.*

### INTRODUCTION

In the recent trends of international discipline, corporate governance has increasingly taken on a role of safeguarding the stability of financial systems.

The inadequacy of the previous regulatory framework in guaranteeing correct mechanisms of prevention of an excessive risk taking has demonstrated the critical importance of corporate governance for the proper functioning of the banking sector and the economy as a whole.

In the light of evidence revealed by the financial crisis, international regulation is going to be implemented orienting corporate governance mainly towards criteria of safeguarding banks' stability.

This road to reform is still on-going.

In this context, the Italian financial sector has been recently involved in a renewed government intervention, due to the public *precautionary recapitalisation* introduced by the 2016-2017 Italian laws. These measures will produce implications on corporate governance too, affecting banks' risk-taking decisions and management.

Indeed, the process of "banking recapitalisation" is assigned to *State intervention* tools, subject to the EU standards and in compliance with specific conditions related to capital and governance of the bank involved. In particular, this measure is allowed through capital injections only with regard to a capital shortfall under the *adverse scenario* of a *stress test*. This means that the bank must be solvent, being necessary that it fulfils the minimum capital requirements (i.e. Pillar 1 requirements).

Precautionary interventions are based on the European regulatory framework represented by the 2014/59/EU *Directive (Bank Recovery and Resolution Directive - BRRD)* being compliant with EU's State aid regime.

Nevertheless, in this context all the overall post-crisis process of regulatory revision must be considered.

First of all, we refer to the *Capital Requirements Regulation - CRR (575/2013)* and *Capital Requirements Directive - CRD IV (2013/36/EU)*, that transposed into European law the international framework (Basel III) developed by the *Basel Committee on Banking Supervision (BCBS)*: an entire framework that is still in progress.

The objective of the *CRD IV Directive* in the field of corporate governance is to impose principles aimed at guaranteeing the effective supervision by the "*management body*" - namely by non-executive directors - and together the control by *Competent Authorities* on the adequacy of the internal governance arrangements.

Furthermore, the strengthening of the regulatory capital framework, both in terms of quality and quantity, indirectly contributes to contain the excessive risk appetite of the management.

In addition, the *Guidelines on internal governance* issued by EBA, recently subject to consultation process, further enrich the framework in this field. In fact, "*the Draft Guidelines have been developed on the basis of Article 74 of Directive CRD IV, which mandates the EBA to further harmonise institutions' governance arrangements, processes and mechanisms across the EU and Competent Authorities will be expected to implement the Guidelines by mid-2017*" (EBA 2016).

Thus, a holistic framework is being developed, at a national and international level, centered on better managing risks and medium term performances.

In fact, the crucial role of *general economic interest* assigned to banks in the economy, by intermediating funds from savers and depositors to activities that help drive economic growth, underlies the reasons

of the specificity of corporate governance regulation (compared to the regulatory principles of governance of non financial firms).

There are, indeed, at least two key factors distinguishing the governance of banks from that of non financial firms: *“the first is that banks have many more stakeholders than non financial firms. The second is that the business of banks is opaque and complex and can shift rather quickly”* (Mehran *et al.*, 2011).

Banks' safety and soundness are key factors for financial stability. A weak corporate governance - if related to *Global Systemically Important Banks* (G-SIBs) - plays a negative role in the financial system as a whole, having impact on the banking sector and the general economy.

Capital on the one hand and governance on the other hand represent the fundamental *safeguards* in face of risks and their potential impact on economic balance.

Capital requirements and risk governance are in some way connected to each other by an *institutional* link for the achievement of the same objectives: safeguard of banks' stability and of general economic interests.

The aim of this survey is to provide an overview of the main changes that have occurred in international regulation of corporate governance, with particular attention to functions and competences of the management body and, on the other hand, to the tasks of Competent Authorities. The complex regulatory framework imply that banks must pursue the best strategies to comply with it and to deal with the impacts on their business.

## **THE REGULATORY FRAMEWORK OF CORPORATE GOVERNANCE IN THE BANKING SECTOR**

The need to strengthen the corporate governance of banks emerged more vigorously after the financial crisis, which highlighted the presence of weaknesses, especially regarding the specific issue of risk governance. Although, corporate governance in financial institutions was not the main cause of the financial crisis, however, in many instances, boards and senior management of financial firms failed to understand the characteristics of the new, highly complex financial products they were dealing with and were often unaware of the aggregate exposure of their companies, and consequently largely underestimated the risk they were running (de Larosiere Group, 2009).

Indeed, the strengthening of the governance approach was already previously a topic of interest of the international institutions, even though limited to setting out non-binding principles through the issuing of best practices, updated at various times (OECD, 1999; OECD, 2004; BCBS, 1999; BCBS, 2006).

As outlined before, in the years following the crisis, one of the primary objectives of the revision of European rules had been to enhance the way how banks govern themselves and how supervisors oversee this critical area. This was due to the acquired awareness (BCBS, 2015) of negative and

potentially systemic externalities of ineffective schemes of governance. In fact, “*controlling excessive risk taking also requires regulation of corporate governance*” (Schwarcz, 2017).

This resulted in the centrality of governance profiles not only in the framework of regulation but also of supervision.

At the regulation level, CRD IV *Directive* provides a first explicit and systematic placement of governance in the context of primary regulation.

The rules that the *Directive* dedicates to the themes of corporate governance and remunerations, grouped in a specific section (articles 88-95), are aimed at defining the governance arrangements ensuring an effective and prudent management, through reduction in excessive risk taking.

Two of the main key points of the CRD IV regulation are:

- the reinforcing of the collective oversight and risk governance responsibilities of the board;
- the objective to emphasise key components of risk governance such as *risk culture*, *risk appetite* and their relationship to a bank’s *risk capacity*.

Both the aspects, deeply connected to each other, are aimed at safeguarding conditions of stability and solidity in the financial system, through sound and prudent management of financial institutions, considering the role of general economic interest that they play and the resulting *systemic risks*.

Hence, banks’ activity should be oriented to the correct identification and assessment of risks which characterise it.

A sound corporate governance approach seems to be the prerequisite of an effective achievement of prudential requirements (particularly, stricter capital adequacy) and it has similar importance in terms of stability. In fact, according to *Whereas no. 44* of CRD IV “*Competent Authorities should be entrusted with ensuring that institutions have a good organisation and adequate own funds, having regard to the risks to which the institutions are or might be exposed*”.

Moreover, banks need to look for new management strategies to increase their capitalization in a context of decreasing banking profits (Tutino *et al.*, 2015).

As outlined above, to the “management body” is awarded a central role, with strong emphasis on the competences regarding risk management.

Financial institutions which are significant in terms of their size, internal organisation and the nature and complexity of their activities must set up internal committees (nomination committee, risk committee and remuneration committee), composed of members of the management body who do not have executive function.

This is properly due to the *operational focus* represented by risk management and thus by the necessity of committees supporting this specific activity. In particular, to the risks committee is assigned the

function of supporting the activities falling in the risk appetite area, while the control committee deals with risk accountability.

The development of the activity is therefore supported by procedures, processes and programmes in which the board plays the leading role.

In fact, the board (also according to its internal structure) deals with the risk appetite formulation (through the RAS – *Risk Appetite Statement*), related to the aggregate level and types of risk that a bank is willing to assume, decided in advance and within its risk capacity, to achieve its strategic objectives and business plan.

Furthermore, the board takes on a specific responsibility for the sphere of risk accountability, by constantly monitoring the management, with a specific focus on the adequacy of the *risk management system*. Also the adjustment interventions, in case of deviation from the prearranged objectives, fall into this context.

This close connection between the board and the management is confirmed by the arrangement of the RAF - *Risk Appetite Framework*. In this document its outlined the overall approach, including policies, processes, controls and systems, through which risk appetite is established, communicated and monitored; types and the levels of risks considered as compatible with the firm's situation, are also explained. Therefore, RAF must be aligned with the bank's strategy; the business units will tend to operate within the limits and along the direction outlined.

The implementation of the rules regarding corporate governance has developed parallel to the definition of the objectives to be achieved in terms of interests needing protection.

In this sense, the set of rules introduced by Basel III regarding the capital levels has a further indirect effect on risk management mainly orienting the activity towards medium-long term performance. This is because - other things being equal - the current regulation "*by increasing the quantity and improving the quality of regulatory capital, contributes to align the goals of managers with those of shareholders, so reducing the excessive risk appetite of the management and, more generally, the typical agency problems that usually arise between banks' managers and shareholders*" (Vento and La Ganga, 2014).

## **THE EUROPEAN SUPERVISION OF CORPORATE GOVERNANCE IN THE BANKING SECTOR**

The above mentioned regulatory innovations not only outline a *new paradigm* of corporate governance but also strengthen the forms of *public control* based on it.

Corporate governance profiles are object of a specific activity of supervision by the competent authorities, within the SREP process (*Supervisory Review and Evaluation Process*), in line with the crucial role they play within the regulatory framework.



The Guidelines published by EBA “for common procedures and methodologies for the supervisory review and evaluation process (SREP)” (EBA, 2015) confirm the importance attributed to the mechanisms of governance in the processes of supervision.

In addition, the ECB has adopted three high-level priorities to guide its supervision throughout 2017. The aim of Single Supervisory Mechanism (SSM) is to ensure that directly supervised banks address key risks effectively: “to enable banks to address these key risks effectively, European banking supervision has streamlined its supervisory priorities. For 2017 three priority areas will guide banking supervision:

1. business models and profitability drivers;
2. credit risk, with a focus on NPLs and concentrations;
3. risk management” (ECB, 2017).

The institutional control is periodical and pervasive and envisage instruments of reaction if any possible weaknesses arise.

As regards governance, SREP assessment is *qualitative*, and embraces different aspects. First, the assessment concerns the functioning and effectiveness of the board and the decision-making process, particularly on key issues such as *strategy, risk awareness and management, transparency* towards shareholders, availability of adequate information, and so on. Secondly, it concerns the banks’ risk appetite frameworks and the extent to which an appropriate *risk culture* is effectively ensured throughout the organisation, starting from the board and working down the hierarchical ladder. Third, it concerns the remuneration policies, also in the light of the EBA guidelines, looking specifically at the different components of remuneration and dividend *distributions*. Finally, it concerns the *internal control* functions, internal audit, as well as the risk management and compliance function (Angeloni, 2017).

Within the assessment process Supervisory authorities, in fact, formulate a judgment – expressed by a score (from 1 to 4) – on the adequacy of the mechanisms of the corporate governance and internal controls. The assessment influences the overall outcome of SREP and is aimed at assessing the *effectiveness* of governance arrangements, corporate culture and *values*, and the ability of members of the management body to perform their duties.

The CRD IV *Directive* also disciplines the corrective actions that Authorities shall take against possible weaknesses; among the main consequences, they could take decisions directly affecting the governance arrangements, in terms of strengthening the implemented arrangements, processes, mechanisms and strategies.

*“By its nature, governance supervision is less subject to precise quantification and measurement, and relies more on subjective supervisory judgement. In relation to this, and more generally, we need to keep in mind that supervision is not an exact science, which can be conducted following a fully codified methodology. Whether it will become so in the future is a question for academics. Since for now it is not, it is essential that legislation and*

*standards do not try to limit, beyond a certain point, the room for supervisory discretion, lest making the whole supervisory process unworkable and ineffective. This point is particularly important in Europe now, while the legislators are engaged in the first major revision of our banking law since the launch of the banking union”* (Angeloni, 2017).

The same *Directive* assumes (*Whereas 54*) the need of monitoring by the Competent Authorities of the adequacy of internal arrangements of governance. This is in order to avoid potential harmful effects linked to the presence of ineffective corporate governance arrangements which can lead to moral hazards by the management.

In the same circumstance the opportunity that *“Those principles and standards should apply taking into account the nature, scale and complexity of institutions’ activities”* is emphasized. In fact, the principle of proportionality has a crucial role in order to obtain an effective regulation as well as for financial supervision, which tend to significantly influence strategies and activities, with the aim of addressing the latter towards *“traditional”* less risky and more efficient business models.

Furthermore, the complexity, the increasing number and the frequent revisions of the rules imply high costs of compliance, thus creating competitive disadvantages for smaller banks. Regulatory requirements contained in CRR/CRD IV *“should be proportional to the size and systemic risk footprint of banks of differing dimension, complexity and business model”* (Masera, 2016).

## **RECENT REGULATION ON PRECAUTIONARY RECAPITALISATION: THE ITALIAN CASE**

The recent development of Italian banking regulation has enlightened the interest and renewed the debate about the role of public intervention and its desirability in management of banking crisis.

The *Decree* n. 237/2016 (hereinafter the Decree) was adopted by the Italian Government on 23 December 2016, on the legal assumption of the need of urgent measures for the protection of savings in the banking sector. The Parliament approved it with law n. 15, 17 February 2017.

The new regulation introduces temporary measures (but with implications in the medium-long term) and involves the *“State”* in the credit process: something already seen in the past and now repropounded (although in a very different context).

The regulation, in fact, provides state intervention instruments, in order to safeguard stability in banking and financial sector.

The most significant measures aim to establish a legal framework for extraordinary public financial support to Italian banks under the conditions and within the limits set by *Regulation* (EU) No 806/2014 of the European Parliament and of the Council (*SRM Regulation*) and according to the Italian transposition of the *Directive* 2014/59/EU (*Bank Recovery and Resolution Directive - BRRD*). On the basis of

this *Directive*, in order to remedy a serious disturbance in the economy of a Member State and preserve financial stability, the provision of such public financial support must *not be conferred* to a bank that is *failing* or likely to fail.

To this end, a set of specific institutional tools has been developed. The Decree provides for three categories of extraordinary public intervention: a) a State guarantee of banks' newly *issued liabilities*; b) a State guarantee of *Emergency Liquidity Assistance* (hereinafter ELA) operations conducted by Bank of Italy; c) a *precautionary recapitalisation*.

The arrangement of precautionary interventions opens the way to a new perspective for the Italian banking system not limited to the use of private capital but relying on the process of recapitalisation through public intervention.

The regulation appears to be compliant with the European regulatory framework concerning the conditions necessary for the grant of public financial aid. The reference is to the BRRD *Directive* and to the regulation establishing the *Single Resolution Mechanism* (SRM), which provides uniform rules and a uniform procedure for the resolution of credit institutions and investment firms in the framework of the SRM and the Single Resolution Fund.

The European frame defines, in fact, the necessary conditions enabling the grant of extraordinary public aid without involving resolution measures.

In accordance with the European Union's state aid regime, the liquidity support measures should be *precautionary* and *temporary* and granted to banks with positive equity. Under the aforementioned Decree, the Ministry of Economy and Finance (MEF) is authorised until 31 December 2017 to intervene by subscribing to or purchasing shares issued by Italian banks. Such intervention may only be requested by a bank which, based on an adverse scenario under a national, EU or SSM-wide stress test exercise, needs to strengthen its capital.

## **THE IMPLICATIONS OF PRECAUTIONARY RECAPITALISATION ON CORPORATE GOVERNANCE**

The procedure of request for State support implies a particular impact on corporate governance as well as on the setting out of corporate strategies. The bank is required to submit a capital raising plan to the Competent Authority, namely the ECB for significant credit institutions and the Bank of Italy for less significant institutions. The adequacy of the plan is assessed by the Competent Authority.

The banks benefiting from the government aid are thus required to present a *restructuring plan* submitted to the European Commission in order to be evaluated with regard to compliance with state aid rules. The plan must give reasonable evidence of the perspective profit earning capacity and bank's

long term sustainability, without requiring additional public intervention. The precautionary recapitalisation is conditional on the Commission's approval of the restructuring plan.

In the case of provision of collateralisation of the Bank of Italy's liquidity operations, in order to face severe crises of liquidity, the respect of the restructuring plan is also due to the necessity to limit the overdraft on liquidity provided by the central Bank.

Bank risk mitigation through the *massive use of government guarantees*, using the instrumentation of guarantees for the liabilities and for ELA, may be measured and compared with patterns evaluating its impact on *banks' risk-taking incentives*. In the current academic and political debate, *"government guarantees are considered to be an effective tool to prevent the occurrence of panic crises and mitigate their negative effects. However, their provision can distort banks' risk-taking incentives and induce them to take excessive risk. Because of this moral hazard problem, the provision of guarantees can lead to the perverse outcome of increasing the overall instability in the banking sector and magnify the costs for the government providing them"* (Allen *et al.*, 2017).

The request of precautionary recapitalisation clearly results in management and governance implications for the bank.

In particular, the bank is required to undertake some commitments on the basis of EU's state aids rules and principles, specifically enacted for the banking sector, and aimed at avoiding the waste of resources.

Furthermore, the capital subscription can be subject to the MEF for the revocation or substitution of executive directors or director general of the involved banks or to the limitation of remunerations of the upper bodies.

As to the restructuring plan, to be submitted to the Ministry and to the Competent Authority, the request must be supported by information and documents related to: the *amount* of the subscribed shares for which the Ministry's intervention is requested; a list of the bank's instruments and loans which would be subject to *burden-sharing* measures, indicating their economic value, arranged by an independent expert; an estimate of the actual value of the bank's *assets* and *liabilities*, for the purposes of assessing compliance with the *"no-creditor-worse-off-than-in-insolvency"* principle.

The restructuring plan – implying specific management objectives the claiming bank will have to achieve – is notified to the EU Commission. State precautionary intervention will be arranged only if the Commission delivers a positive outcome of the assessment with regard to the *compatibility* with the internal market.

As it is known, the first beneficiary under the above mentioned framework is intended to be Banca Monte dei Paschi di Siena (MPS), the third-largest Italian banking group, and the Decree contains specific provisions for the application of the measures to MPS.

The 2016 European stress tests conducted by the EBA showed a very severe impact for MPS in the “adverse” scenario, related to CET1 shortfall. The bank was still solvent, respecting the minimum capital requirements and had thus prepared a recapitalisation, by a private capital increase, with the original intention of avoiding the resort to public resources.

Having failed this initiative, the necessity of extraordinary and temporary state financial support became concrete. According to ECB, the mentioned shortfall translates into a capital requirement of EUR 8.8 billion. The ECB’s communication related to the capital shortfall opened the articulated process regulated by the Decree.

As effect, shareholders will be subject post money to the decrease of their stock proportionally to the capital increase.

The contents of the restructuring plan has a significant role in this context. It is aimed at guaranteeing the effectiveness of the business model in the long term, minimising competitive distortion and, consequently, strengthening its resilience against the hypothetical adverse scenario.

Therefore, the bank management will be required to take on non-negotiable commitments, also in terms of business strategies, subject to constant *institutional* monitoring.

In this context, the theme of corporate governance - specially with regard to the internal governance - is crucial with regard to the measures that the bank - requesting a precautionary recapitalisation - will have to adopt in order to achieve the envisaged enhancement, that is to say *central elements* of the *planning process* itself and of the bank’s perspectives.

## REFERENCE

- Allen, F., Carletti, E., Goldstein, I. and Leonello, A. (2017), “Government guarantees and financial stability”, working paper no. 2032, European Central Bank, february.
- Angeloni, I. (2017), “Systemic risk mitigation: the roles of capital and corporate governance” paper presented at 2017 Conference on “Banks, Systemic Risk, Measurement and Mitigation”, 17 March 2017, Università La Sapienza, Rome, available at: <https://web.uniroma1.it>
- BCBS - Basel Committee on Banking Supervision (1999), “Enhancing corporate governance”, available at: <http://www.bis.org/bcbs>
- BCBS - Basel Committee on Banking Supervision (2006), “Enhancing corporate governance”, available at: <http://www.bis.org/bcbs>
- BCBS - Basel Committee on Banking Supervision (2015), “Corporate Governance Principles for Banks”, available at: <http://www.bis.org/bcbs>
- de Larosièrè Group (2009), “High Level Group on Financial Supervision in the EU” - Report, available at: <http://www.ec.europa.eu>
- EBA - European Banking Authority (2015), “Guidelines on common procedures and methodologies for the Supervisory Review and Evaluation Process (SREP)”, available at: <http://www.eba.europa.eu>
- ECB - European Central Bank (2017), “ECB Banking Supervision: SSM supervisory priorities 2017”, available at: <https://www.bankingsupervision.europa.eu>
- Masera, R. (2016), “The emerging Basel 4: critical points for banks and the economy”, *Bancaria*, 1.
- Mehran, H. Morrison, A. and Shapiro J. (2012), “Corporate Governance and Banks: What Have We Learned from the Financial Crisis?” in Dewatripont, M., Freixas X. (Eds), *The crisis aftermath: new regulatory paradigms*, CEPR.

OECD Organisation for Economic Co-operation and Development (1999), "OECD Principles of Corporate Governance", available at: <http://www.oecd.org>

OECD – Organisation for Economic Co-operation and Development (2004), "OECD Principles of Corporate Governance", available at: <http://www.oecd.org>

Schwarcz, S. L. (2016), "Misalignment: Corporate Risk-Taking and Public Duty", *Notre Dame Law Review*, 92, pp. 1-50.

Tutino, F., Brugnoli, G. C., Siena, M. G. (2015), "Italian banks facing Basel 3 Higher Capital Requirements: Which Strategies Are Actually Feasible?", in Beccalli, E., Poli, F. (Eds.), *Bank Risk, governance and Regulation*, Palgrave Macmillan, pp. 206 - 233.

Vento, G. A., La Ganga, P. (2014), "Corporate Governance of Banks and Financial Crisis: Can the Post- crisis Rules Make Banks Safer?", in Lindblom, T. et al. (Eds.), *Governance, Regulation and Bank Stability*, Palgrave Macmillan, a division of Macmillan Publishers Limited, pp. 48-76.

## ENHANCING TOURISM DURING 2007-2013 PROGRAMMING PERIOD IN ROMANIA: THE CASE OF BRASOV GROWTH POLE

Catana, Aida; Manea, Daniela; Titan, Emilia

Economic Cybernetics and Statistics Doctoral School, University of Economic Study, ASE, Bucharest, Romania

### ABSTRACT

The tourism dynamics analyzed in the context of the access to the European Structural and Cohesion Funds within the programming period 2007-2013 is correlated with the evolution of the different relevant aspects: the evolution of the structure corresponding to touristic units, the dynamic of the lodging units or the analysis of the average duration of the stay as well as the manner in which the financial resources have been used. With an allocation of 74.3 million euro in the programming period 2007-2013, the Brasov Growth Pole has pursued the contribution to the achievement of economic and social development in a sustainable manner. The implementation of projects with European financing in areas such as public utilities, transport, social and educational infrastructure have generated changes in different sectors, including tourism, which this paper proposes to present. The evolution of the tourism, its dynamics at the level of each locality that is part of the Brasov growth pole are presented by the statistical analysis. The effects of the European financing obtained from Regional Operational Programme 2007-2013 are thus reflected in the sustainable development of the Brasov growth pole from the point of view of the dynamic of tourism.

*Keywords: EU Funds, tourism, statistical analysis, regional development, growth pole*

### INTRODUCTION

In compliance with European and different national policies, the concept of the growth poles was accepted as centers for urban development in 2008. The growth poles were mentioned under different names: "developing engines" or "engines of economic development" in the programming documents such as National Development Plan 2007-2013, National Strategic Reference Framework 2007-2013. The Regional Operational Programme 2007-2013 includes as a recognition of their importance one specific priority axis for growth poles development having an allocation of 1,391.17 million euro for the development of the growth poles in Romania, including Brasov. Moreover, as a confirmation of the central role should be played by tourism, the Priority Axis 5 of the Regional Operational

Programme named „Sustainable development and promotion of tourism“ had an allocation of approximately 663 million Euros, representing 18 percent of the total allocation.

## **THE CHALLENGES AT THE EUROPEAN UNION LEVEL AND ROMANIA THE FIELD OF TOURISM AND GROWTH POLES AS CENTERS OF URBAN DEVELOPMENT**

The most important objective during the programming period 2007-2013 for new-Member States especially Romania was the first objective: economic and social cohesion.

### *The role of the tourism and of the growth poles as means for urban development – relevant contributions*

The positive effects of the tourism sectors on the economic development was undisputed and there are studies showing that the tourism has two actions, both to support the functioning of the existing companies and to stimulate the local companies to innovate and generate new jobs and economic welfare (Nissan et al, 2011). In the programming period 2007-2013, EU structural and cohesion funds were used by the Member State to support tourism as is the case in Czech Republic where a record-breaking amount of money is being invested in tourism (Vystoupil and Šauer, 2010). In Romania, the role of structural funds in the development of tourism in Romania has been both relevant as well as significant (Jaliu, 2012) especially for tourism business environment, as a catalyst for entrepreneurship in the respective industry (Padurean et al, 2015).

The evolution of the tourism sector is connected with different other sector such as transport policy and infrastructure (Stanciulescu et al, 2006), the capacity of the regional planning (Baidal, 2004) or structural changes in social environment generated by the reactions of local communities regarding tourism and tourists (Tsartas, 2003). The complexity of the growth pole concept is given by the number of cross-cutting issues such as spatial planning, quality of transport infrastructure, public services – health, utilities, and environment which need to be subject of the necessary supplementary policies (Christofakis and Papadaskalopoulos, 2011). In Romania, the concept of growth poles was developed in relation with the functional networks or the polycentric development approach and reduction of the regional disparities, the diffusion of the growth being made through various channels to certain variable terminals of an entire economy (Antonescu, 2011)

### *Increasing function of the tourism sector – policies and allocation of the funds at European level*

The programming period 2007-2013 had a consistent allocation for tourism, considered one of the areas with the largest contribution in fulfilling the three objectives set at the EU level: convergence, regional competitiveness and employment, European territorial cooperation.

The allocation for tourism in the 2007-2013 programming period was over 1% of the budget, Romania having an allocation of 1.9%.



TOURISM 2007-2013						
Objective	Community Amount €	Tourism		Of which		
		Amount €	%	Promotion of natural assets	Protection and development of natural heritage	Improve tourist services
TOTAL	344,321,833,061	6,324,393,750	1.8%	0.3%	0.4%	1.1%
Romania	19,213,036,712	358,815,896	1.9%	0.3%	0.6%	0.9%

Table 1. Allocation at EU level and Romania for tourism, Source EU Cohesion Policy: Tourism, [http://ec.europa.eu/regional\\_policy/themes/index\\_en.htm](http://ec.europa.eu/regional_policy/themes/index_en.htm)

Moreover, during the programming period, the European Commission has made it clear that it has a major interest in this area, saying that it generates economic development and jobs. The coordinated approach of the initiatives linked to tourism, took into account that the European tourism industry sums up around 1.8 million businesses, mainly SMEs, and employs approximately 5.2% of the workforce, generating over 5% of EU GDP.

#### *Programming documents in Romania for 2007-2013 and their priorities*

In the 2007-2013 programming period, Romania has received support in tourism, given the inclusion of this area in the priorities set by the National Development Plan 2007-2013. Thus, in 2004, the year in which the elaboration of the NDP starts, Romania is, in terms of GDP/inhabitant, at approx. 31% of the EU average. In order to reduce these disparities the NDP 2007-2013 global goal was established "Reducing the socio-economic disparities between Romania and the Member States of the European Union as fast as possible", estimating that by 2013 Romania could recover approximately 10 percentage points of the overall gap compared to the EU, reaching approximately 41% of the EU average.

The development of the local and regional tourism was one of the sub-priorities proposed for the increase of tourist attractiveness of regions by creating adequate infrastructure and improving specific services, the development of alternative forms of tourism, the protection and promotion of the natural and cultural heritage at local and regional level. Although in 2003 the contribution of tourism to Romania's GDP was only 2.19% it was considered that all the 8 regions have a valuable potential, whose exploitation requires overcoming key challenges among which the instability of the institutional authorities responsible for developing policies and strategies in the field and the low level of infrastructure especially in terms of transport, communications and services.

## **THE DYNAMICS OF TOURISM DEVELOPMENT IN THE CENTRU REGION AND THE CASE OF THE BRASOV GROWTH POLE**

The region for development Centru covers 8 counties located in the central part of Romania, as the region's name says. The region has a lot of beautiful surroundings, Carpathian Mountains and their

specific natural heritage. This is one of the reason to choose this region as a subject for this paper: the huge potential of the tourism sector and the opportunity to access EU structural and cohesion funds to address the needs.

*The priorities – tourism and urban development, including the growth poles, at regional level*

The importance of the tourism is also demonstrated in the Central Region Development Plan for 2007-2013, the basic document in the regional development planning for which the structural funds were allocated through the Regional Operational Programme 2007-2013.

According to data presented in the Region Development Plan, at the level of the region in the year 2005 Brasov had a share of 44.8% in terms of accommodation capacity. However, Brasov county, as well as the other counties in the region were affected in terms of the urban development by an old infrastructure (water, sewage, heating, gas, waste collection, etc.), lack of urban facilities, inadequate urban planning (parking spaces, sidewalks, public spaces, parks and other recreational facilities, lighting, etc.), many historical and cultural objectives in the state of degradation, lack of access conditions in public buildings for persons with disabilities, poor local public transport network in large urban centers.

*Brasov growth pole – tourism dynamics*

The Brasov Growth Pole received an allocation of 74.3 million euro in the programming period 2007-2013, according to the provisions of the Regional Operational Programme 2007-2013, Priority Axis 1. The developed and implemented projects were in different sectors (figure 1). The effects were significant in different fields such as: education and lifelong learning, including e-learning, health, employment, infrastructure or public utilities. All the improvements have contributed to a better environment for tourism sector.

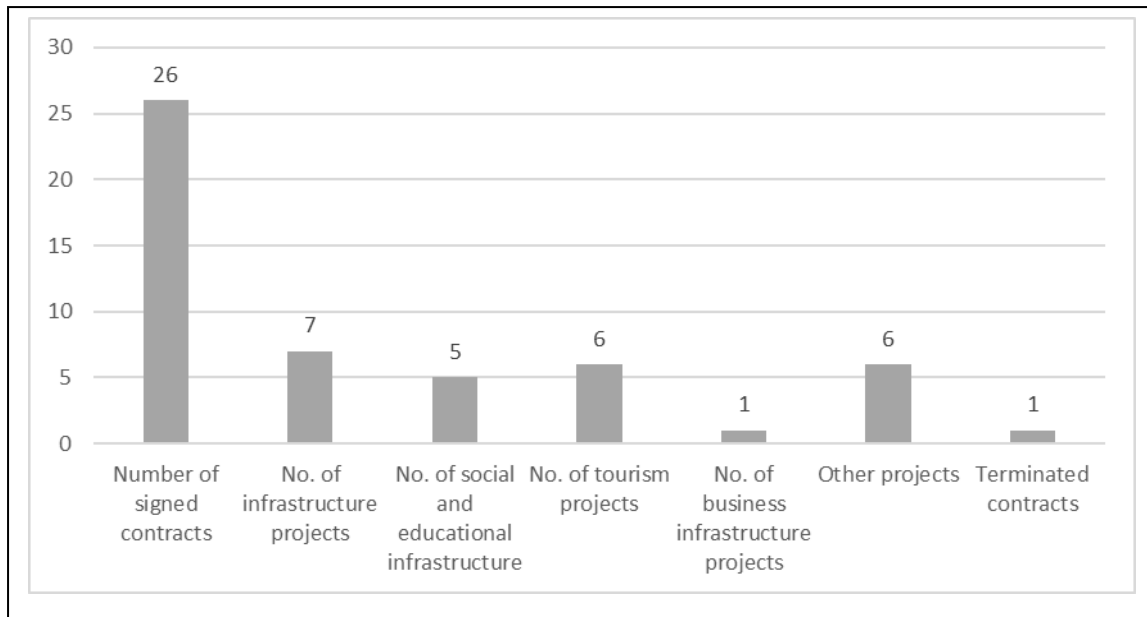

Figure 1 Brasov growth pole-projects financed by Regional Operational Programme 2007-2013

The available data from 2008 to 2013 presents evolutions of different indicators. The dynamic of the lodging units at the level of the pole has an ascending trend, the indicator registering an increase by 55% in the year 2013 compared to the year 2008. With regard to the evolution of the lodging capacity the same trend is maintained, the growth from 2008 compared to 2013 being 2%. The evolution of the structure corresponding to touristic units at the level of the localities in the pole in the year 2013 compared to the year 2008 allows the enunciation of the following observations: Brasov municipality holds 41% of the touristic lodging units from the pole in the year 2013, compared to 39% in the year 2008; Predeal Town held in the year 2008 a percentage of 38% of the touristic lodging units from the pole, and this percentage would diminish by approximately 10 per cent in the year 2013 (29% of the touristic lodging units from the total pole); The towns of Rasnov, Zarnesti and Sacele hold percentages exceeding 5%, in growth in 2013 compared to 2008. A comparative analysis of the average lodging capacity (accommodations/ touristic unit) at the level of the localities in the Brasov growth pole reveals significant increases for the localities of Codlea, Sacele and Tarlungeni.

The analysis of the average duration of the stay in the year 2013 compared to the year 2008, at the level of the localities in the pole, shows a growth thereof only for Harman locality. For the other localities in the pole the average duration of the stay remained constant or recorded decreases. A particular situation can be found in the case of Halchiu locality, which used to hold the greatest duration of the stay in the year 2008 (approximately 10 days), where, beginning with the year 2012 no touristic unit would exist at the level of the locality.

With regard to the evolution of the lodging capacity use rate at the level of the towns in the pole different evolution trends can be noticed, as follows: a descending evolution trend in the case of Rasnov Town; a similar evolution is registered in the case of the towns of Brasov and Predeal, with a diminishment trend over the last 2 years of the analysis (2012 and 2013); Rasnov Town is the only locality where the lodging capacity use rate grows in the year 2013 compared to 2012.

## CONCLUSIONS

The importance given to the tourism sector both at the EU level and national level have been reflected at the regional level in Romania. Thus, it was possible both to include tourism as a priority in the Regional Development Plan 2007-2013 and to have financial support to enhance the tourism at local level. The direct allocation for urban development and especially for the growth poles made possible to solve the problems in different fields such as infrastructure, education or employment. These are pre-conditions for tourism development and the evolution at the level of the Brasov growth pole proves these.

## REFERENCES

- Antonescu, D. (2011), "Noile perspective teoretice ale dezvoltării economice la nivel regional", *Studii Economice*, pp. 1-26.
- Baidal, Josep A. Ivars (2004), "Regional tourism planning in Spain: Evolution and Perspectives." *Annals of tourism research* 31.2, pp. 313-333.
- Christofakis, Manolis, and Athanasios Papadaskalopoulos (2011), "The Growth Poles Strategy in regional planning: The recent experience of Greece." *Theoretical and Empirical Researches in Urban Management* 6.2, pp.5.
- Jaliu, Dragoş Dumitru (2012), "The effectiveness of public policies and Structural Funds in enhancing tourism development. The case of Romania." *Theoretical and Applied Economics* 12.12, pp. 37.
- Nissan, Edward, Miguel-Angel Galindo, and María Teresa Méndez (2011), "Relationship between tourism and economic growth." *The Service Industries Journal* 31.10, pp. 1567-1572.
- Padurean, Mihaela Ana, Ana-Maria Nica, and Puiu Nistoreanu (2015), "Entrepreneurship in tourism and financing through the Regional Operational Programme." *Amfiteatru Economic* 17.38, pp. 180.
- Stanciulescu, G. C., et al. (2006), "The analysis of the tourism development in European countries." *Economic Computation and Economic Cybernetics Studies and Research* 40.3/4 pp. 33-47.
- Tsartas, Paris (2003), "Tourism development in Greek insular and coastal areas: sociocultural changes and crucial policy issues." *Journal of Sustainable Tourism* 11.2-3, pp. 116-132.
- Vystoupil, Jiří, and Martin Šauer (2010), "Regional operational programs as an instrument of tourism support in the Czech Republic." *Regionální studia* 2010.1, pp. 38-50.
- COM(2010) 352 final, "Europe, the world's No 1 tourist destination – a new political framework for tourism in Europe", available at <http://eur-lex.europa.eu/LexUriServ/LexUriServ.do?uri=COM:2010:0352:FIN:en:PDF>, accessed at 22 April 2017
- COM(2007) 621 final, "Agenda for a sustainable and competitive European tourism" available at <http://eur-lex.europa.eu/LexUriServ/LexUriServ.do?uri=COM:2007:0621:FIN:EN:PDF>, accessed at 22 April 2017
- COM(2006) 134 final, "A renewed EU Tourism Policy: Towards a stronger partnership for European Tourism" available at <http://eur-lex.europa.eu/legal-content/EN/TXT/PDF/?uri=CELEX:52006DC0134&from=RO>, accessed 22 April 2016

Government of Romania (2005) "National Development Plan 2007-2013" [pdf], available at: [http://old.fonduri-ue.ro/res/filepicker\\_users/cd25a597fd-62/Doc\\_prog/PND\\_2007\\_2013/3\\_NDP2007\\_2013\(eng.\).pdf](http://old.fonduri-ue.ro/res/filepicker_users/cd25a597fd-62/Doc_prog/PND_2007_2013/3_NDP2007_2013(eng.).pdf), accessed 20 February 2017

Government of Romania (2007), "National Strategic Reference Framework 2007-2013", available at [http://old.fonduri-ue.ro/res/filepicker\\_users/cd25a597fd-62/Doc\\_prog/CSNR/1\\_CSNR\\_2007-2013\\_\(eng.\).pdf](http://old.fonduri-ue.ro/res/filepicker_users/cd25a597fd-62/Doc_prog/CSNR/1_CSNR_2007-2013_(eng.).pdf), accessed 22 March 2017

Government of Romania (2007), "Regional Operational Programme 2007-2013" (2007), available at [http://old.fonduri-ue.ro/res/filepicker\\_users/cd25a597fd-62/Doc\\_prog/prog\\_op/1\\_POR/POR.pdf](http://old.fonduri-ue.ro/res/filepicker_users/cd25a597fd-62/Doc_prog/prog_op/1_POR/POR.pdf), accessed at 22 March 2017

"Planul Integrat de Dezvoltare Urbană (PIDU) pentru polul de creștere (PC) Brașov" [pdf] available at: <http://www.brasovcity.ro/documente/public/constructii-urbanism/planul-integrat-de-dezvoltare-urbana.pdf>, accessed 14 October 2014

"Planul de Dezvoltare al Regiunii Centru pentru perioada 2007-2013 " (2008) [pdf], available at: [http://www.adrcentru.ro/Document\\_Files/adplanulregional/00000021/9591f\\_PDR-2007-2013.pdf](http://www.adrcentru.ro/Document_Files/adplanulregional/00000021/9591f_PDR-2007-2013.pdf), accessed 14 October 2014

[http://ec.europa.eu/regional\\_policy/sources/activity/statistics/2007\\_tourism.pdf](http://ec.europa.eu/regional_policy/sources/activity/statistics/2007_tourism.pdf)

## **POLITICAL CORPORATE SOCIAL RESPONSIBILITY IN THE TURKISH BUSINESS CONTEXT**

**Cemek, Elif**

Institution of Social Sciences, Galatasaray University, Turkey, [ecemek@gsu.edu.tr](mailto:ecemek@gsu.edu.tr)

### **ABSTRACT**

This study aims to reveal the factors that cause the businessmen in Turkey to conduct political corporate social responsibility activities. The factors affecting corporations' political corporate social responsibility practices depend both on the context of the corporations and their institutional environments. Therefore, understanding and assessing the corporations' political and economic contexts and the national business system, in which they are embedded are of critical importance in order to extract these factors. With this aim, memoirs of businessmen are gathered and scrutinized using thematic analysis. Emerging themes resulting from the analysis include legitimacy, sustainable development, increasing competitiveness, weakness of the state, state repression, protection of commercial interests and religion. In other words, findings of this study show that the public policies of the governments in education, health and political areas, the religious tendencies of the businessmen, weaknesses of the governments, responding to the increasing market competition and protection of the commercial interests are the main drivers for Turkish businessmen to conduct political corporate social responsibility activities.

*Keywords: Corporate Social Responsibility, Political Responsibility, Corporate Citizenship*

### **INTRODUCTION**

Firms have resorted to different strategies in order to maximize profit and attain legitimacy as a result of their CSR activities. However, in today's society, firms seem to appear to provide public goods and services where governments fail. Going beyond their economic role, firms started to gain a state-like role and led the emergence of political corporate social responsibility (P-CSR) concept by extending dimension of CSR into politics concomitantly. The aim of this study is to reveal the factors that cause the businessmen in Turkey to conduct P-CSR activities. Therefore, the progress of P-CSR concept, its antecedents and theoretical approaches to P-CSR is explained at first. Besides, the role of Turkish firms, factors affecting their involvement in public policy arenas and the types of their activities in those initiatives are investigated. In this regard, the internal and external contingencies surrounding firms in Turkey are focused in order to depict the factors that led firms implement P-CSR activities. The data of

the study gathered from the memoirs of Turkish businessmen. The factors influencing businessmen to take part in the governmental arenas are examined through thematic analysis which is a qualitative method that helps reveal both implicit and explicit meanings of documents.

## **POLITICAL CORPORATE SOCIAL RESPONSIBILITY**

Political corporate social responsibility (P-CSR) is an outcome of the extension of CSR concept through a series concept such as corporate citizenship (CC), triple bottom line which refers to social, economic and environmental responsibilities of the firms in addition to their financial liabilities to the stakeholders (Yip, Van Staden, and Cahan, 2011). There is a range of research pertaining to CSR literature that signals an expansion in the dimensions of corporations' CSR activities towards political elements (Bendell and Kearins, 2005; Dubbink and Smith, 2011; Matten and Crane, 2005; Moon, Crane and Matten, 2005; Scherer and Palazzo, 2007;2011; Palazzo and Scherer, 2008;). Considering all the studies regarding P-CSR so far, there is yet no consensus on the definition of the term. In line with this, Scherer and Palazzo (2011) explain P-CSR as follows: *In a nutshell, political CSR suggests an extended model of governance with business firms contributing to global regulation and providing public goods.* On the other hand, Frynas and Stephens, (2015) defines P-CSR as *activities where CSR has an intended or unintended political impact, or where intended or unintended political impacts on CSR exist.*

The range of corporations' involvement in the arenas beyond their economic activities has been addressed from different perspectives as well. For example, Scherer and Palazzo's (2007) conception of P-CSR is based on the Habermas's deliberative democracy that search for universal philosophical foundations. However, Edward and Willmot (2011) claim that P-CSR needs to be constructed on a perspective that recognises difference, contestation and undecidability. On the other hand, Matten and Crane (2005), Moon, Crane and Matten, (2005) or Scherer and Palazzo (2007; 2011) granted a crucial role to globalization in the formation of corporations' political entity. Despite the effects of globalization, political understanding of CSR from CC still view governments as the most crucial actors in their own national borders (Matten and Crane, 2005). CC reveals the role of firms in directing citizenship rights (social, civil and political rights such as working conditions, protection of citizens' property or voting) for stakeholders (Matten and Crane, 2005). However, Makinen and Korula (2012) state that both Scherer and Palazzo (2007) and Moon, Crane and Matten (2005) overemphasize the interaction between globalization and political role of firms. Whelan (2012) claims that P-CSR should not be viewed as a result of globalization process rather it constitutes a possible figure of globalization. In return for these criticism, Scherer et al. (2016) state that P-CSR does not only fulfil the gaps in the global governance but also in local and regional governance because of the heterogeneity of nation-states which recently regain power through increasing tribalism.

## **POLITICAL CORPORATE SOCIAL RESPONSIBILITY IN TURKISH BUSINESS CONTEXT**

While government agencies have been viewed as the only political actor considering social welfare and firms as economic actor, the line between these territories has blurred (Scherer, Palazzo, 2009). Depending on the societal/statist context which is a company embedded, CSR may be used as a political tool since domestic institutions may view CSR activity within or outside the decision making process of businesses (Detomasi, 2008). For example, in corporate-centred contexts, corporate agency perspective plays the initial role in the formation of social responsibility initiatives by ignoring a societal perspective (De Geer, Borglund and Frostenson, 2009). Therefore, it is required to give insight about Turkish business context and the effects of globalization on its economy which shape firms' engagement into political activities.

### *National business system in Turkey*

Since its foundation in 1923 until 1980s, Turkey passed through an economic system in which large family firms became the dominant actors in an economic structure with frequent direct state interventions at the organization of economic activities and industrialization (Yamak, 2006). Turkish businessmen view state both as the source of obstacles they are confronted and as the enabler of their financial resources and social positions concurrently (Bugra, 1994). After successive economic crises in 1994, 2000 and 2001, the importance of governance has been recognized (Onis, 2006), corporate governance gained attention and with the support of international organizations such as WB, OECD and GCGF, principles of corporate governance have been published in 2005 relying on 1999 OECD principles. In Turkey, where corporate ownership belongs to families who own more than 50% of shares, mechanism for protection of institutional owners and shareholder rights is relatively weak (Yamak and Ertuna, 2012; Yurtoglu, 2000). Number of firms quoted on Istanbul Stock Exchange (Borsa Istanbul/BIST) is highly restricted compared to developed countries and firms seem unwilling to go for initial public offerings with the fear of losing their authority in the company and the cost of compliance with principles of corporate governance (Yamak and Ertuna, 2012). It is obvious that incompetence in Turkish business system and political/economic instability support each another by influencing capital markets negatively. However, intermittent improvements in economy, politics and national business system encourage Turkish businessmen to comply with global markets considering dynamics of the context. In line with this, Turkish businessmen attempted to bolster their position in society through social responsibility initiatives in order to compete in global markets and adapt legal and institutional changes into Turkish business context.

### *Political Corporate Social Responsibility in Turkey*



Concept of corporate social responsibility has been recognised as equal to philanthropy in Turkey. Recent understanding of Philanthropy goes back to pre-Islamist Turkish states (Alakavuklar, Kilicaslan and Ozturk, 2009). Today, there are many Vakifs that were founded for philanthropy purposes and administered by large family businesses in Turkey. However, recent understanding of CSR in modern Turkey is a result of changing market conditions worldwide. CSR as a concept appeared in practice-related magazines in the late 1960s (Yamak, 2007) but philanthropy placed as the initial practices of nonmarket activities in most of the companies' annual reports (OECD, 2006).

Approving the claim that the line between economic and political areas gets blurred by Scherer et al., (2009), Turkish firms has tended to perform social responsibilities in public areas going beyond their profit seeking activities. Common CSR activities of the firms are related to education, environmental protection, civil society, art and culture (Capital, 2010; 2011; 2012). A field study held by Atakan and Iscioglu (2009) show that consumers expect firms to act responsibly in terms of society, consumers, employees, state and environment and perform activities in education, health and environment. Another study conducted on 322 firms quoted in ISO 500 in 2008 show that Turkish firms recognize business sustainability and profit maximization as their most important responsibilities (Suher, 2010). Also, legal regulations, common practices in the industry or pressure of foreign markets act more intensely on environmental activities of firms compared to expectations of customers or community (Küskü, 2007). Most of the studies on the role of Turkish business in society are about corporate social responsibility approach. However, Turkish firms have not been fully committed to rights of CC such as human rights and employee rights in CSR activities. Turkish firms strengthened their position in markets with prevailing privatization in last three decades but these transitions confronted Turkish firms with societal problems such as education and health. Therefore, firms focused on such public issues mostly in their CSR practices. While corporate social responsibility of Turkish firms relies on philanthropy and traditions, how did political corporate social responsibilities of firms emerge in Turkey? The changing role of Turkish firms in society can be understood deeply through an analysis of its societal, political and economic contexts that involve important milestone of Turkey's transition such as administrative crises, military regimes, economic crises and failing coalition governments. Nevertheless, contribution of businessmen to society are proportionate to strength they have (Davis, 1968). Political conditions, community expectations, relations with state and attempts to minimize governmental interventions are the factors that shape political responsibilities of firms (Detomasi, 2008) and these conditions depend on the societal context firms embedded in. This study aims to understand the emergence of firms' political social responsibilities, their position in markets and their interaction with the political, economic and social actors. In other words, it is aimed to reach factors

that cause firms undertake political responsibilities and grasp the role of globalization together with local and regional dynamics on these initiatives.

## **METHOD**

This study will be conducted in an emerging country context where the interactions between firms, society and the state may be more strained. It addresses a research agenda that is a compilation of memoirs of businessmen with a range of different background and experience with economic, social and political actors emerging in Turkish Business Context. This enquiry into the firms' political responsibilities requires a qualitative study which enables deeper understanding of the phenomena. We will analyse the emergence of political corporate social responsibilities of businessmen through thematic analysis which uses similar methods and shares the same purposes with qualitative content analysis (Zhang and Wildemuth, 2009). Thematic analysis may be an essentialist or realist method which reports the experiences, meanings or realities of individuals, a constructionist method which shows how public discourse effect the individuals or a contextualist method that individuals make sense of their experiences and that there is a broader social entourage effecting these meanings in return (Braun and Clarke, 2006). Since the flexibility and practicality of thematic analysis help reflect the reality beyond what is visible and reach the implicit truth (Braun and Clarke, 2006) this method will enable to extract the factors that lead Turkish businessmen to perform political activities. Instead of random sampling which is generally used in quantitative studies (Zhang and Wildemuth, 2009), we resort to purposive sampling and pick up prominent businessmen, a total number of eight, as the sample of this enquiry. The names of 8 businessmen whose memoir books have been analysed are as follows Akin Ongor, Vehbi Koc, Nejat Eczacıbası, Kemal Sahin, Muharrem Eskiyapan, Sakip Sabancı, Üzeyir Garih. Data gathered to cover the information related to emergence of firms' political responsibilities and their interactions with societal, political and economic actors. In the analysis, categories have been built firstly and then main themes have been identified in the light of these categories which have helped answering the research question. The commercial initiatives of businessmen who constitute the sample of this study go back to foundation of the Turkish Republic. Since political, societal and economic context of firms effect their political responsibilities; the memoirs of these businessmen may provide deeper and broader insight of military coups and regimes, economic crises, coalition governments, transition to market economy and economic/political relations with the Western countries. Since family businesses dominate Turkish business context, largest family groups have constituted the sample and their owners and top managers' memories have been subject of the analysis.

## FINDINGS

As a result of Thematic Analysis, seven main themes and related categories were reached. Themes clustered as follows: *local and international expectations, sustainable development, weakness of state, state pressure, increasing competitiveness, protection of commercial interests/lobbying and religion*. These themes show which factors are effective in undertaking political social responsibility for businessmen.

*Local and international expectations:* Turkish businessmen are trying to gain legitimacy in society by emphasizing how they commit their wealth for the advantage of country and drawing attention to their social contributions instead of success (Bugra, 1994). Among the activities that businessmen conducted for legitimation are social aid, improvement of education and health services, art and culture events, environmental awareness, establishing environmental associations respectively. Businessmen often emphasize their contribution to society and environment and express that they fulfil their responsibilities to society and meet community expectations thereof. Citizens may demand firms to provide services which granted as the role of state, in other words, political expectations may emerge by public (Matten and Crane, 2005). Turkish businessmen have seemed to meet such political expectations in order to remain legitimacy.

*In a manner of speaking, I resorted to Nejat Eczacibasi many times in order to receive support for Kenter Theater. I have never returned unanswered. As for support of state, I went Ankara with my file in every changing period. It has always been delayed because of other prominent problems... (Eczacibasi, 1994).*

In another example;

*"They have applied from there, they said. Please, build a school for us too. We agreed...We built a primary school there too (Eskiyapan, 2009).*

Because of community demands raised to businessmen in public service areas, it was proposed:

P1: Public demands positively affect firms' P-CSR activities.

In the aftermath of embracing neoliberal policy, Turkish economy has extended to foreign markets and the role of the government has been tried to minimize with the help of international organizations such as IMF, WB and OECD (Önis and Bakir, 2007). In the context of liberalization and the military coup in 1980, businessmen seemed to act as political actor.

*We managed to break the resistance of French government indirectly which have been maintaining in the visits of French ministers since 1980s. I enabled French ministers to come together with the senior authorities of Turkish government (Sabanci, 2004). It is in the interest of the country that businessmen with strong international connections should be active in influencing government policies (Garih, 2001).*

Therefore, it was proposed: P2: Considerations of legitimacy in international markets positively affects firms' P-CSR activities.

*Sustainable development*: Sustainable development has been defined as a concept which contains environmental, economic and social factors (Boele et al., 2001). Businessmen needs to reconsider their role within the society according to changing societal circumstances to be able to operate in the long term and sustain profitability (Van Marrewijk, 2008).

*Since it cannot be expected to maintain an organization healthy in an unhealthy condition, the common sense of an industrialist will and should force him/her to deal with the social issues... (Eczacıbaşı, 1982). Economy and ecology needs to be considered together. This is not something to put off (Şahin, 2000).*

The reason why Turkish businessmen found environmental entities (Tema Vakfi, Tema Vakfi Avrupa) and their concern for societal development is to sustain their activities in a healthy society. Sustainable development can be reached through a holistic view towards economy, society and environment (Van Marrewijk and Were, 2003).

So that, it was stated:

P3: Sustainable development positively affects firms' P-CSR activities.

*Weakness of state*: Firms may assume a state-like role where state system gets weak and government policies fail to provide citizenship rights (Matten and Crane, 2005). Firms may involve in societal issues where public authorities are unable or unwilling to fulfil this role (In their memoirs, businessmen express that private enterprises are ready to support governments where government is weak or governmental policies seem insufficient. Particularly, businessmen addressed their concerns on the inefficiency of 1980 military regime in economic policies, regression in the markets and the failures of weak coalition governments and gave advices both on economic and political policies. Businessmen mentioned their concerns on the break of democracy resulting with economic regression and political instabilities and their relations with the governments as follows:

*Today, our country needs unity and togetherness more than ever. Meanwhile private enterprise is ready to take part in the economic mobilization that the country needs and it will succeed without doubt (Eczacıbaşı, 1982). I have suggested that we should establish a constitution that enables progress in every direction, in a stable political life that does not allow pauses in democracies... I have repeated these opinions on every occasion to the press members who met with me during 1980 and 1983 in which we paused parliamentary democratic life for the third time (Koc, 1984).*

In addition, businessmen addressed that governments with failing political and economic practices posed damages in markets. The reason why is that successive disruptive crises occurred in 1970s and thereafter weak coalition governments with failing financial policies came to power in a long term, specifically from 1989s to 2000s (Önis and Bakir, 2007).

*After about one year of Cyprus operation, I wrote a letter to Bülent Ecevit on August, 1975 “a common government with Demirel seems to be the only remedy of dealing with internal and external impasses; the coalition of two large parties may overcome economic depression” I said.*

Another example is that;

*The president of central bank, “as we all know, the banking sector is experiencing a serious crisis ... we wish you to buy 51% of shares of Bank Ekspres and provide financial support so that you can make this bank swim. I make this request from you due to difficulties in the country and the industry”. We did not want to buy a bank; we buy to contribute Turkish banking sector, just because the state wants us... (Ongor, 2010).*

The failures of government policies in stopping terrorism have an impact on firms to undertake responsibilities in solving this issue as well. In relation to this, businessmen stated that they are expected to take part actively in eliminating the terrorism through investments. Even, one of the prominent businessmen, Sakıp Sabancı, prepared a comprehensive report on economic development of the region in order to prevent prevailing terrorism. For example, *“According to the information given to me, the size of 22 provinces in Eastern Anatolia that is effected by terrorism is the 29.77% of the territory of Turkey”... Private enterprises should invest in Eastern Anatolia. State should establish factories in Eastern Anatolia... ‘By this way both terrorism is prevented and immigration stops...’ This is a very frequent recurring view. (Sabancı, 1996).*

Therefore, it was suggested:

P4: Weakness in economic and political power of government positively affects firms’ P-CSR activities.

*State Pressure:* Turkish businessmen frequently claimed that governmental policies and the attitude of government officials to businessmen had an impact on conducting social responsibility activities and the areas they will be contributing to society. Especially during the authoritarian regime of military businessmen have repeatedly mentioned and pointed to Kenan Evren’s (the leader of military regime) iterative recommendations to invest in educational field. For example,

*Of course, my Pasha, we said, and we returned to the establishment. And after a few days past, I said in the board meeting, I told the situation. Let us build an Industrial Vocational School, too. They agreed... (Eskiyapan, 2009).*

Hence, following propositions suggested:

P5: Responding governmental demand positively affects firms’ P-CSR activities.

*Increasing competitiveness:* Scherer and Palazzo (2011) claim that globalization is the main driver of corporations’ politicization. Businessmen in Turkey, seem to involve in societal issues with the impact of liberalization. In 1980, Turgut Ozal initiated a period in which market economy dominated in

Turkey (Önis, 2006) so that the firms became open to the competition and thus they were forced to increase both their legitimacy in terms of society and innovativeness.

*The sense of success in competition should be as in the direction of producing better goods cheaper through researches, creating innovations and expanding market shares, dealing more with the problems of society that the firm operates in (Eczacıbaşı, 1982, 247).*

When market economy has penetrated into markets in 1990s, businessmen foreseen a couple of societal reforms that will enable them to compete with their western rivals. Therefore, they stated that they are ready to take responsibility in these initiatives.

*...Inspired by the strategies anticipated by the institutions of the Western Countries, let us try to think what we need to do in order to accelerate development of our institutions and compete with the West by considering the current trends. Environmentalism, innovation, high efficiency should be the fundamental elements of continuous restructuring (Garih, 1995).*

So that it was stated:

P6: Increasing competition through globalization positively affects firms' P-CSR activities.

*Protection of commercial interests/Lobbying:* In their memories, businessmen have iteratively noted that the experiences of private enterprises in economic policies should be exploited and this will be effective in the faster development of the society. However, businessmen as political actor seemed to interact with state to be able to sustain their operations and ease commercial activities (Hadani, 2012) Trade associations (TUSIAD, MUSIAD, SIAD etc.) presenting business groups, have had an impact on the societal demands for a smoother progress of Turkish economy and democracy (Keyman and Koyuncu, 2005). Acting as pressure groups these associations have attempted to convert state into an effective, accountable and transparent mechanism (Keyman and Koyuncu, 2005). Nevertheless, businessmen try to influence governmental policies by acting in political areas (Hillman, Keim and Schuler, 2004). *The businessman involves in the policy unavoidably. However, it would be right to influence the government by the channel of associations if it is objectionable to serve as a partisan. In addition, supporting the candidates from every party who is familiar with the problems of free enterprise and who will take care of benefits of this country; raising candidates and attempting to send them to the parliament is supposed be the task of the business world as much as its right. Businessmen, especially in Turkey, have perceived their social and political responsibilities. Especially, they are trying to carry out this in the recent times (Garih, 2001).*

Therefore, it was suggested: P7: Protection of commercial interest positively affects firms' P-CSR activities.

*Religion:* Businessmen often included in their memoirs the importance of values such as charity, zakat, thankfulness and faithfulness and the need to share their properties with society through Vakifs in accordance with their beliefs. However, firms in Turkey exhibit their charity activities as CSR practices

in their annual reports (Ertuna and Tukul, 2009). According to memoirs, it seems that they try to take advantage of endeavours in social issues for improving corporate reputation.

*I have decided to do charity work since 1948 to be able to share my happiness with others and express my gratitude to God... Afterwards, I provided services in areas of education, health and culture. In 1969, I gathered all of them under the roof of Vehbi Koc Vakfi (Koc, 1984). For example, I told Necmettin Erbakan before Customs Union "Turkey is a part of Europe. This work is for the interest of Turkey. There was also mister Ali with me (Ali Akkanat). Pointing out him, I said, he is from Konya too, he has built a beautiful mosque in Konya. These are individual concrete examples." (Şahin, 2008).*

So that, it was stated: P8: Religion positively affects firms' P-CSR activities.

## DISCUSSION

The objective of this study was to explore factors affecting the politicization of firms that engage in social issues beyond economic sphere in an emerging country context. The factors influencing businessmen to conduct political responsibility activities are clustered around seven main themes. Including *local and international expectations, sustainable development, weakness of state, state pressure, increasing competitiveness, protection of commercial interests/lobbying, and religion*, these themes show what is important for businessmen while conducting political social responsibility activities.

According to the findings, external drivers have an important effect on firms' political social responsibility activities. In other words, Turkish businessmen feel the pressure of external actors such as community or governmental agencies. Both Scherer and Palazzo (2007; 2011) and Moon, Crane and Matten (2005) state that globalization has the initial role on the politicization of corporations. In line with this, Turkish firms are involved in political societal issues in order to compete with international rivals after the penetration of market economy in 1980s. Also, businessmen emphasize the importance of implying western strategies such as "environmentalism", "innovation", "high efficiency". This shows that prevailing globalization has impact on the political activities of firms as Scherer and Palazzo (2007; 2011) claims. Together with this, businessmen mention frequently about the impact of authoritarian regimes or vulnerable governments on their political responsibility activities. Most of their societal initiatives seem to be geared by these state agents. In other words, failing government systems and their disruptive economic policies lead businessmen to engage in resolving public issues. Therefore, it supports the claim of Matten and Crane (2005) who views governments as the most crucial actors in their own national borders (Matten and Crane, 2005). On the other hand, Turkish firms attempt to influence government policies and regulations by involving in societal issues. Businessmen sometimes express their will for novel regulations that allow "progress in every

direction". Firms may involve in political activities in order to ease their commercial activities (Hadani, 2012), and avoid future government demands (Baron, 2002).

As a consequence, this study shows what motivates Turkish businessmen to undertake PCSR activities by showing internal and external dynamics that push firms to act in political areas in an emerging country context. The study is not without limits, it relies upon the memoirs of businessmen which constitutes biased interpretations and restricted insight. For further research, including other businessmen into the sample and using different data sources such as newspapers, business magazines could enable to make comparisons while providing thick and deeper insights on firms' PCSR activities. Moreover, it may be supported with quantitative analysis by using companies' data in similar areas.

## REFERENCES

- Alakavuklar, O.N., Kılıcaslan, S. and Ozturk, E.B. (2009), "Türkiye'de hayırseverlikten kurumsal sosyal sorumluluğa geçiş: Bir kurumsal değişim öyküsü", *Yönetim Araştırmaları Dergisi*, Vol. 9 No. 2, pp. 103-143.
- Atakan, M.G.S. and Iscioglu, T.E. (2009), "Türk tüketicilerinin bakış açısıyla işletmelerin kurumsal sosyal sorumluluk faaliyetleri", *Öneri Dergisi*, pp. 125-133.
- Baron, D. P. (2002), "Private politics and private policy: A theory of boycotts".
- Bendell, J. and Kearins, K. (2005), "The political bottom line: The emerging dimension to corporate responsibility for sustainable development", *Business Strategy and the Environment*, Vol. 14 No. 6, pp. 372-383.
- Braun, V. and Clarke, V. (2006), "Using thematic analysis in psychology", *Qualitative Research in Psychology*, Vol. 3 No 2, pp. 77-101.
- Bugra, A. (1995), *Devlet ve İşadamları: State and business in modern Turkey, a comparative study*, İletişim Yayınları.
- Capital (2010), "Corporate social responsibility in Turkey", available at: <http://www.capital.com.tr/arastirmalar/siralama-ataklarla-degisiyor-haberdetay-492> (accessed 18 December 2013).
- Capital (2011), "Corporate social responsibility in Turkey", available at: <http://www.capital.com.tr/yonetim/pazarlama/yeni-sosyal-sorumluluk-gercekleri-haberdetay-7294?sayfa=2> (accessed 18 December 2013).
- Capital (2012). "Corporate social responsibility in Turkey", available at: <http://www.capital.com.tr/yonetim/liderlik/siralama-yine-cok-hareketli-haberdetay-8271> (accessed 18 December 2013).
- Davis, K. (1968), "Understanding the social responsibility puzzle: What does the businessman owe to society?", *Business Horizons*, Vol. 10 No. 4, pp. 45-50.
- De Geer, H., Borglund, T. and Frostenson, M. (2009), "Reconciling CSR with the role of the corporation in welfare states: The problematic Swedish example", *Journal of Business Ethics*, Vol. 89 No. 3, 269-283.
- Detomasi, D.A. (2008), "The political roots of corporate social responsibility", *Journal of Business Ethics*, Vol. 82 No. 4, pp. 807-819.
- Dubbink, W. and Smith, J. (2011), "A political account of corporate moral responsibility", *Ethical Theory and Moral Practice*, Vol. 14 No. 2, pp. 223-246.
- Eczacıbaşı, N.F. (1982), *Kuşaktan Kuşağa*, Dr. Nejat Eczacıbaşı Vakfı Yayınları, İstanbul:
- Edward, P. and Willmott, H. (2011), "Political Corporate Social Responsibility: Between Deliberation and Radicalism".
- Eskiyapan, M. (2009), *Babam Nuh Ağa ve Ben: Hayatım, Anılarım, Yeniden Grup Matbaası*, İstanbul.
- Frynas, J.G. and Stephens, S. (2015), "Political corporate social responsibility: Reviewing theories and setting new agendas", *International Journal of Management Reviews*, Vol. 17 No. 4, pp. 483-509.
- Garih, Ü. (1995), *Deneyimlerim IV*, Cem Ofset Matbaacılık Sanayi AŞ, İstanbul.
- Garih, Ü. (2001), *Deneyimlerim VI*, Cem Ofset Matbaacılık Sanayi AŞ, İstanbul.



- Hadani, M. (2012), "Institutional ownership monitoring and corporate political activity: Governance implications", *Journal of Business Research*, Vol. 65 No. 7, pp. 944-950.
- Hillman, A.J., Keim, G.D. and Schuler, D. (2004), "Corporate political activity: A review and research agenda", *Journal of Management*, Vol. 30 No. 6, pp. 837-857.
- Koc, V. (1984), *Hatıralarım Görüşlerim Öğütlerim*, Vehbi Koc Vakfı, İstanbul.
- Küskü, F. (2007), "From necessity to responsibility: Evidence for corporate environmental citizenship activities from a developing country perspective", *Corporate Social Responsibility and Environmental Management*, Vol. 14 No. 2, pp. 74-87.
- Mäkinen, J. and Kourula, A. (2012), "Pluralism in political corporate social responsibility", *Business Ethics Quarterly*, Vol. 22 No. 04, pp. 649-678.
- Matten, D. and Crane, A. (2005), "Corporate citizenship: Toward an extended theoretical conceptualization", *Academy of Management Review*, Vol. 30 No. 1, pp. 166-179.
- Moon, J., Crane, A. and Matten, D. (2005), "Can corporations be citizens? Corporate citizenship as a metaphor for business participation in society". *Business Ethics Quarterly*, Vol. 15 No. 03, pp. 429-453.
- Ongor, A. (2010), *Benden Sonra Devam*, Alametifarika, İstanbul.
- Önis, Z. (2006), "Turkey's encounters with the new Europe: Multiple transformations, inherent dilemmas and the challenges ahead". *Journal of Southern Europe and the Balkans*, Vol. 8 No. 3, pp. 279-298.
- Önis, Z. and Bakır, C. (2007), "Turkey's political economy in the age of financial globalization: The significance of the EU anchor", *South European Society & Politics*, Vol. 12 No. 2, pp. 147-164.
- Palazzo, G. and Scherer, A. G. (2008), "Corporate social responsibility, democracy, and the politicization of the corporation", *Academy of Management Review*, Vol. 33 No. 3, pp. 773-775.
- Sabancı, S. (1988), *Gönül Galerimden*, Kent Basımevi, İstanbul.
- Sabancı, S. (1993), *Daha Fazla İş Daha Fazla Aş*, A4 Ofset Basımevi.
- Sabancı, S. (1996), *Doğu Anadolu Ekonomik ve Sosyal Kalkınma Politikaları Raporu: Özel Sektör Ağırlıklı Ekonomi ve Sosyal Kalkınma Atılımını Başlatıp Yürütecek Teşkilatlanma Önerisi (2. Baskı)*, Graffito AŞ Basımevi, İstanbul.
- Sabancı, S. (2004), *Biraktığım Yerden Hayatım*, Doğan Kitapçılık, İstanbul.
- Şahin, K. (2000), *Zirvedeki Şahin*, Hayat Yayıncılık, İstanbul.
- Scherer, A. G. and Palazzo, G. (2007), "Toward a political conception of corporate responsibility: Business and society seen from a Habermasian perspective", *Academy of Management Review*, Vol. 32 No. 4, pp. 1096-1120.
- Scherer, A. G. and Palazzo, G. (2011), "The new political role of business in a globalized world: A review of a new perspective on CSR and its implications for the firm, governance, and democracy". *Journal of Management Studies*, Vol. 48 No. 4, pp. 899-931.
- Scherer, A. G., Rasche, A., Palazzo, G and Spicer, A. (2016), "Managing for political corporate social responsibility: New challenges and directions for PCSR 2.0", *Journal of Management Studies*, Vol. 53 No. 3, pp. 273-298.
- Suher, İ. K. (2010), "Major approaches for the corporate social responsibility communication: An observation for Turkish corporate websites", *Research Yearbook*, 595.
- Van Marrewijk, M. and Werre, M. (2003), "Multiple levels of corporate sustainability". *Journal of Business Ethics*, Vol. 44 No. 2-3, pp. 107-119.
- Van Marrewijk, M. (2008), "A typology of institutional frameworks supporting corporate sustainability", available at: <http://citeseerx.ist.psu.edu/viewdoc/download?doi=10.1.1.488.5204&rep=rep1&type=pdf> (accessed 10 December 2013).
- Whelan, G. (2012), "The political perspective of corporate social responsibility: a critical research agenda", *Business Ethics Quarterly*, Vol. 22, pp. 709-737.
- Yamak, S. (2006), "Changing institutional environment and business elites in Turkey", *Society and Business Review*, Vol. 1 No. 3, pp. 206-219.
- Yamak, S. (2007), *Kurumsal Sosyal Sorumluluk Kavramının Gelişimi*, Beta, İstanbul.
- Yamak, S. and Ertuna, B. (2012), "Corporate governance and initial public offerings in Turkey", *Global Perspectives on Corporate Governance and Initial Public Offerings*, pp. 470-98.
- Yip, E., Van Staden, C. and Cahan, S. (2011), "Corporate social responsibility reporting and earnings management: The role of political costs", *Australasian Accounting Business & Finance Journal*, Vol. 5 No. 3, pp. 17-33.
- Yurtoglu, B. B. (2000), "Ownership, control and performance of Turkish listed firms", *Empirica*, Vol. 27 No. 2, 193-222.

Zhang, Y. and Wildemuth, B. M. (2009), *Qualitative Analysis of Content: Applications of Social Research Methods to Questions in Information and Library Science*, ed. Barbara M. Wildemuth, West Port, Connecticut: Libraries Unlimited, 308.

## THE RELATIONSHIP BETWEEN LEADERSHIP COMPETENCIES AND SUCCESSFUL ORGANISATIONAL CHANGE

Chatzoglou, Prodromos<sup>1</sup>; Dimitrelos, Georgios<sup>2</sup>;

Chatzoudes, Dimitrios<sup>1</sup>; Aggelidis, Vasileios<sup>1</sup>

<sup>1</sup>Department of Production and Management Engineering, Democritus University of Thrace, Xanthi, Greece / Hellenic Open University, Greece

<sup>2</sup>Hellenic Open University, School of Social Sciences, Greece

### ABSTRACT

Nowadays, all organisations are operating in a highly competitive environment that requires change in order to successfully adapt to new market conditions. In this environment, it is of vital importance to examine the role of various human factors in the successful management and implementation of change initiatives. After all, effective leadership is one of the most significant factors that positively influence organisational change. However, for leaders to be able to effectively manage the change process, they must possess a specific set of competencies. The aim of the present study is to investigate the relationship between leadership competencies and the success of the organisational change process. An original research model (conceptual framework) has been designed, incorporating a number of the most well-known leadership competencies. A quantitative research was conducted and a structured questionnaire was used in order to collect the primary data needed to empirically test the proposed research model. The final sample of the present research consists of 124 managers from companies that operate in the medical equipment sector. The results of the statistical analysis suggest that there are statistically significant relationships between age, education, previous education / training, previous experience and leadership competencies. Moreover, it has also been shown that there is a statistically significant positive relationship between cognitive, functional and personal and social competencies, vision and goal-setting, innovative approach and the success of the organisational change process.

*Keywords: Cognitive competencies, Functional competencies, Personal competencies, Social competencies, Vision and Goal-setting, Organisational change.*

### INTRODUCTION

Continuous organisational change is a necessary prerequisite for retaining a solid competitive advantage and satisfying the constantly differentiated needs of the customer base (May and Stahl, 2016;

Price and Chahal, 2006). The need for change is both influenced by external factors (e.g. changes in legislation, increased competition), as well as internal factors (e.g., integration of new technologies, strategic decisions). However, the implementation of changes is a complicated organisational process that is not always successful (Price and Chahal, 2006; Will, 2015). In fact, the failure rate is often quite high, i.e. almost 70% (Werkman, 2009).

The reasons for failure are varied. Several researchers focused specifically on employees and their inherent resistance to change (Oreg, 2006; Rafferty and Jimmieson, 2016), while others focused on other factors like organisational culture (Dark *et al.*, 2017; Schein, 1999), organisational size (Haveman, 1993; McGuinness and Cronin, 2016), identification of business objectives (Zorn *et al.*, 1999), the fact that changes are starting from top to bottom (Haveman, 1993; Kuusela *et al.*, 2016) and the sources of communication (Allen *et al.*, 2007).

Since organisational changes occur from the highest to the lowest levels, managers and their leadership competencies play an important role in the successful implementation of change initiatives (Alavi and Gill, 2016; Senior and Fleming, 2006). Managers are those who prepare the organization for the change process and, given their implementation skills, are the ones who have to persuade employees to accept the implemented changes (Pagon *et al.*, 2008).

Effective leadership is considered an important factor for achieving successful organisational change (Agote *et al.*, 2016; Bakari *et al.*, 2017; van der Voet, 2016). According to Deal and Kennedy (2000), effective leadership brings effective change. Organisational change is a complex process associated with continuous problem-solving and effective leaders play an important role in solving the problems associated with the implementation of change. In order to do so, leaders have to possess the appropriate competencies, since competencies represent the “*ability to manage knowledge and other skills*” (Gruban, 2003, cited in Olan *et al.*, 2012, p. 24).

The aim of the present study is to investigate the relationship between leadership competencies and successful organisational change. An integrated research model examining the leadership competencies required to achieve effective organisational change is developed, based on the existing pool of relative knowledge (literature review analysis). Moreover, the research model is empirically tested, using a newly-developed structured questionnaire.

## LITERATURE REVIEW

### *The importance of organisational change and the role of leadership*

It is widely accepted that, in a time where everything changes rapidly, an organization cannot survive without change (Kempster *et al.*, 2014). The benefits of change include (Hottenrott *et al.*, 2016; Teo *et al.*,

2013): (a) improvements in organisational efficiency, (b) increased competitiveness, (c) enhanced customer satisfaction, and (d) increased employee productiveness.

Appropriate leadership requires leaders with the right mix of relevant competencies. Several researchers (e.g. Ben Lahouel *et al.*, 2016; Deal and Kennedy, 2000) examined the relationship between leadership skills and organisational change. The importance of appropriate leadership stems from the fact that a successful leader can resolve a multitude of problems related with the overall climate of the organisation, such as cultural differences and refusal of employees to accept the change and the new philosophy (Heifetz and Lauree, 1997; May and Stahl, 2016).

There are many theories that attempt to explain the competencies of an efficient leader. Some of these theories include: (a) the “Contingency Theory” (Fiedler, 1996), which argues that the optimal course of action for any leader depends upon the internal and external circumstances, (b) the “Path-Goal Theory” (House, 1971), which focuses on the importance of incentives, (c) the “Transformational Leadership theory” (Burns 2003), which focuses on confidence and motivation, and (d) the “Managerial Grid Theory” (Blake and Adams, 1991), which focuses on the leader’s interest to attract and retain customers. The various authors and their respective theories look at the effective leader from a different point of view. All opinions, however, agree that in order to become an effective leader and to be able to successfully manage difficult situations, such as change, one should possess specific competencies.

#### *Leadership competencies*

According to Clarke (2004), every organization and every leader should have a clear vision and specific goals. These two elements complement each other; when leaders have a clear vision and specific goals, they are able to gain the trust of the employees. These managers are, moreover, able to ensure the viability, the competitiveness (Ristic and Cekerevac, 2012) and, finally, the sustainability of their organization (Kotter, 2007). Therefore, it is understood that the ability to behave as a “true leader” (setting a clear vision and specific goals), can ensure the success of a change process. This is because employees are highly motivated, have increased trust, completely understand their roles and responsibilities and, thereby, accept the relevant changes and strive for their successful implementation.

Any vision, no matter how well-defined, cannot be achieved if the organisation has a shortage of innovative policies and strategies (Ifinedo, 2008). It is essential for a leader to be innovative, so as to be able to effectively address various organisational issues; innovativeness can ensure the long-term viability of the organization (Jick, 2001). This argument has been supported by several previous studies. For example, Montgomery and Arensdorf (2012) suggested that leadership competencies are associated with the extent to which a leader is innovative. Moreover, Trepanier *et al.* (2016) argued that it is important for leaders to take risks, in order to improve the overall quality of the provided services.

In addition, DeRue and Wellman (2009) suggested that leaders should develop leadership competencies through education and experience (Farr and Brazil, 2009). Moreover, according to Supamanee *et al.* (2011), these cognitive competencies are affected by prior knowledge and education. They constitute a combination of systematic knowledge and experiences that are accumulated over time (Pagon *et al.*, 2008).

Furthermore, possessing functional competencies is a decisive factor, especially during a major change in an organization. Functional competencies refer to the skills that managers use when they solve a problem or perform an activity (Pagon *et al.*, 2008). The importance of these competencies is very high, since they are significantly linked to firm performance (Droge *et al.*, 1994; Hill and Jones, 2001; Li, 2000). In that direction, Lloyd (2010) argued that leaders should have certain interpersonal capabilities. Moreover, Li (2000) concluded that the most important of the leadership competencies is the marketing capability. On the same vein, Eddy *et al.* (2009) highlighted that it is essential for a leader to be able to communicate effectively with both employees and clients. Finally, Malloch and Melnyk (2013) argued that, nowadays, leaders should use media services and digital technology, since these platforms facilitate the collaboration between various stakeholders and enhance the rapid exchange of information.

Finally, East *et al.* (2012) claim that leaders should also develop personal and social leadership competencies. According to Murray (2003), these competencies have a significant effect on organisational performance. Jurkowsi and Hanze (2012) concluded that social competencies are enhanced when interacting and collaborating with employees. In addition, Madden (2011) argued that the most successful leaders are characterised by social and emotional leadership competencies; such skills enable them to remain focused on the objectives of the company and face the various arising problems. Moreover, Riggio and Lee (2007) found that personal and social competencies affect the success of a leader, while Savicevic *et al.* (2013) suggested that a successful leader should be characterised by “self-concept”.

#### *Factors affecting the growth of leadership competencies*

Toor and Ogunlana (2008) argue that it is important for leaders to develop competencies that enable them to achieve their business goals, always taking into consideration the constantly changing external environment. Their study concluded that successful leaders should possess cooperative, communicative, personal and interpersonal competencies (Toor and Ogunlana, 2008). The background of managers, their personal characteristics (e.g. personality), as well as their previous work experience and education / training have an important influence in the development of leadership competencies (Pagon *et al.*, 2008).

Previous experiences (personal or professional), but mainly the educational / training record of managers significantly contribute to the development of leadership competencies (Louw *et al.*, 2012). Jantti and Greenhalgh (2012) suggested that prior knowledge (educational background) and feedback with employees and other leaders are very important factors for the development of leadership competencies.

Demographic characteristics (Muethel *et al.*, 2012) and physical appearance (Sczesny *et al.*, 2006) also affect the degree to which leadership competencies are developed. Sczesny (2003) and Sczesny *et al.* (2004) suggested that there are social stereotypes about the characteristics of a successful leader.

Furthermore, people with different backgrounds develop different attitudes and values (Dole and Schroeder, 2001). Personality plays an important role, since it dictates the way managers behave and, therefore, it significantly affects the development of their competences. For example, managers with a strong personality are able to influence the behaviour of others (Dole and Schroeder, 2001). Muller and Turner (2010) suggest that the attitude and the emotional skills of leaders have a significant impact on the accomplishment of company objectives. On the same vein, Muller *et al.* (2012) observed that emotional and managerial competencies are highly associated with the achievement of company objectives.

Finally, Groves and Feyerherm (2011) argue that nationality influences leadership competencies. More specifically, they found that nationality and cultural characteristics significantly affect the success of the leader and, thus, the performance of the company. Similarly, Poloski Vokic *et al.* (2007) found that the majority of Croatian leaders have significant differences regarding their age, their level of prior knowledge and their experience, compared to the leaders of other European countries and, thus, these differences negatively affect their performance.

## RESEARCH HYPOTHESES

The present study has adopted the view of Pagon *et al.* (2008), according to which leadership competencies consist of three dimensions: (a) cognitive, (b) functional, and (c) personal/social. Moreover, two other leadership competencies that may ensure the success of a change process were included in the proposed research model (in line with the literature of the field, e.g. Jick, 2001; Nanus 1992). The two competencies are: (d) vision and goal-setting competencies, (e) innovative approach competencies. Additionally, (f) the personality of the leader has also been incorporated into the proposed research model (see, Smollan *et al.*, 2010). Finally, (g) demographics and previous work experience are also included, since these factors have been also suggested by the relevant literature (e.g. Louw *et al.*, 2012).

Several researchers have attempted to study the relationship between leadership competencies and organisational change (Trinka, 2004; Pagon *et al.*, 2008; Dubey and Samar, 2011). All of them have examined a different mix of competencies, in order to understand the way they are related to successful organisational change (Virtanen, 2000; Pagon *et al.*, 2008). They have concluded that most of these competencies affect the success of a change process.

Dubey and Samar (2011) concluded that in order to enhance firm performance and facilitate any change, managers should firstly improve their functional competencies (H2). Moreover, Pagon *et al.* (2008) concluded that managers' personal and/or social competencies are highly associated with job effectiveness (H3). Finally, Alkahtani *et al.* (2011) established a significant relationship between leadership style and the effectiveness of managers during a change process (H1). Based on the above, the following research hypotheses are proposed:

**H1.** Cognitive competencies positively affect organisational change.

**H2.** Functional competencies positively affect organisational change.

**H3.** Personal / social competencies positively affect organisational change.

Felkins (1993) highlighted the importance of vision and goal-setting competencies for successfully managing organisational change. They argued that unmet organisational objectives, poor internal communication and lack of top-management commitment may impede the overall change process. Other researchers (e.g. Avery, 2004; Barling *et al.*, 1996) also examined the relationship between vision and goal-setting competencies and performance outcomes, concluding that these competencies significantly affect organisational change.

**H4.** Vision and goal-setting competencies positively affect organisational change.

Several other researchers have thoroughly examined the relationship between leader innovative competencies and organisational change, arguing that leader innovativeness contributes to the success of the overall change process and increases the efficiency of the organization (Koene *et al.*, 2002; Waldman *et al.*, 2001). Moreover, they concluded that an organisational change process that is based on innovative methods has a statistically positive impact on organisational performance (Basile and Faraci, 2015).

**H5:** Innovative approach competencies positively affect organisational change.

According to Alkahtani *et al.* (2011), not all managers can bring about or lead change. Dole and Schroeder (2001) underlined that managers with different personalities behave differently during organisational change. Several researchers have measured personality through the well-known "Big Five" model. In that direction, Vakola *et al.* (2004) found a positive relationship between extraversion, openness to experience, conscientiousness and agreeableness, on the one hand, and acceptance of



change, on the other. Judge *et al.* (1999) discovered seven personality traits (grouped into two main categories: positive self-concept and risk tolerance) predicting reactions towards change. Finally, Wanberg and Banas (2000) revealed that self-esteem, optimism and perceived control were related to change acceptance.

**H6:** The personality of a leader positively affects organisational change.

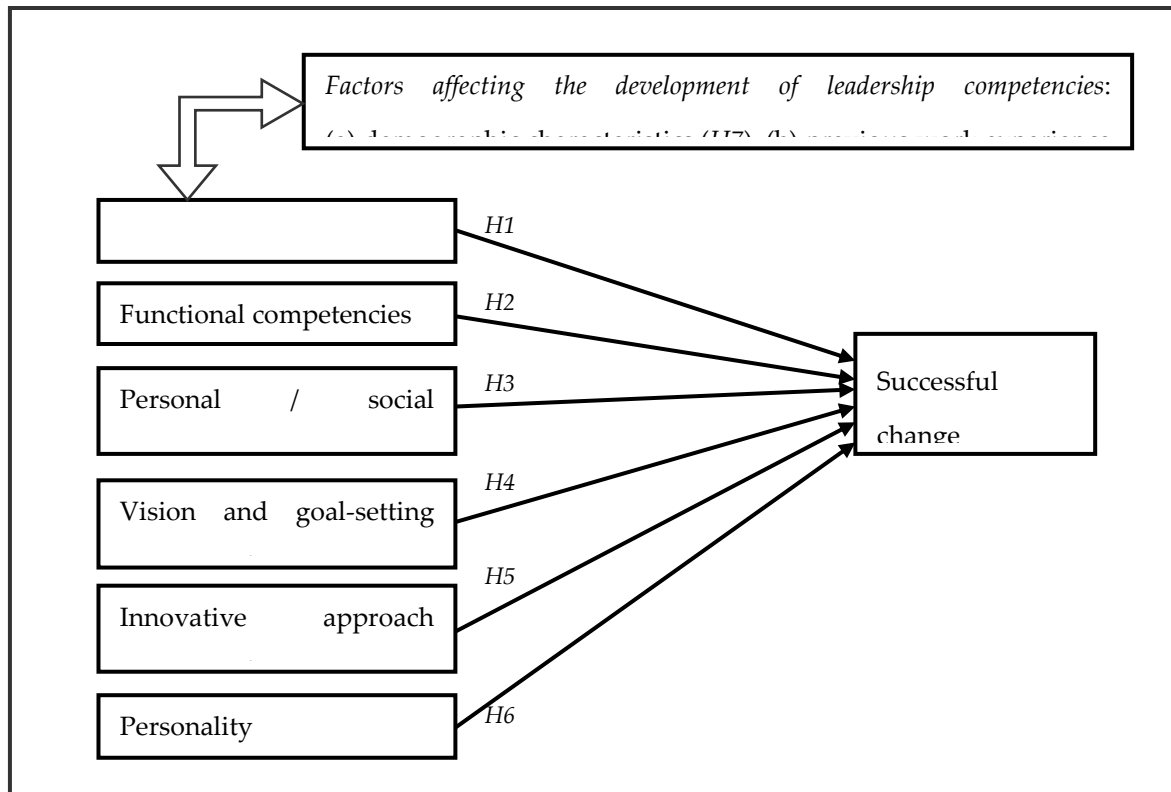

Figure 1. Research model

In addition, the various socio-demographic characteristics of leaders differentiate the extent to which specific competencies are being developed and, thus, indirectly affect the way leaders look at organisational change. This argument is demonstrated by numerous studies. For example, several researchers argue that there is a relationship between gender and leadership competencies (Sczesny *et al.*, 2006; Sczesny *et al.*, 2004), or age and leadership competencies (Muethel *et al.*, 2012; Sczesny *et al.*, 2004). Finally, other researchers (Groves and Feyerherm, 2011; Poloski Vokic *et al.*, 2007) have found that nationality influences leadership competencies. Based on the above, the following research hypothesis is proposed:

**H7:** Demographic characteristics affect the development of leadership competencies.

Finally, previous experiences (personal or professional) and education significantly contribute to the development of leadership competencies (Louw *et al.*, 2012). According to the findings of Louw *et al.*

(2012), managers with more experience develop enhanced social skills and can better handle circumstances of intense change. In that direction, Jantti and Greenhalgh (2012) suggested that prior knowledge and feedback are very important for the development of leadership competencies.

*H8*: Previous work experience affects the development of leadership competencies.

## RESEARCH METHODOLOGY

A quantitative approach was used in order to collect the necessary and appropriate data and empirically test the proposed research model. More specifically, a structured questionnaire was developed and addressed to a number of companies (managers). The questionnaire-approach was chosen because it is one of the most common, valid and reliable methods of written communication between researchers and research subjects, while it is also anonymous.

The questionnaire was created based on items adopted from previous relevant studies of the field. Most of the questions were adopted from the work of Pagon *et al.* (2008), while for one construct (“innovative approach competencies”), the questions used were developed by the researchers in collaboration with a small group of practitioners who were used as consultants. All questions (items) were measured on a five-point Likert scale.

The target-population of the present study consisted of companies that belong in the medical equipment sector. Communication with these companies was established through personal contact and e-mails. The final sample consists of managers from different hierarchical levels. The final sample consists of 124 managers from companies operating in Greece.

## ANALYSIS AND RESULTS

### *Descriptive statistics*

The sample consists mainly of male participants (71%). Most participants are highly educated (29,1% hold a university degree, 54,8% a Master’s degree, and 16,1% a PhD). They are very experienced in the field of medical equipment (mean = 11,63; Std. Dev. = 5,405) and in their current job placement (mean = 8,71; Std. Dev. = 5,287). They are Senior Managers (11,3%), Marketing Managers (9,7%), Sales Managers (16,1%), Product Managers (16,1%), Finance Managers (8,1%), HR Managers (4,8%), etc. Their average age is 40 years (mean = 40,3; Std. Dev. = 6,137). Finally, they work for medium and large companies, while the average employee number of these companies is 146 (mean = 145,76; Std. Dev. = 149,270, mode = 350).

As far as the questions used to measure the main factors of the research model are concerned, the analysis has shown that firms offer rather limited education / training to their managers (mean = 3,36).

More specifically, with the exception of two items, most responses are neutral (around 3, on a five-point Likert scale). The two exceptions are the items “informal education” (mean = 3,81) and “seminars, workshops and conferences” (mean 3,68) (see Table 1). Thus, it is concluded that education / training provided to managers is mostly informal, or based on seminars and workshops. The typical organized education / training is applied moderately.

On the other hand, managers have replied that they possess all capabilities included in the questionnaire, since for all five categories the average values are very high (see Table 2). Of course, these results should be treated cautiously, since they are the product of self-assessment (self-assessment bias).

	On-the-job training	Full formal education	Informal education	Formal training in administration	Formal training in teamwork	Seminars, workshops and conferences	Total
Mean	3,31	3,15	3,81	3,31	3,24	3,68	3,36
Mode	3,00	4,00	4,00	3,00	3,00	4,00	3,00
Std. Deviation	0,96	0,95	0,84	0,99	0,87	1,07	0,62

Table 1. Descriptive statistics of “previous education / training”

	Cognitive competencies	Functional competencies	Personal / social competencies	Vision and goal-setting competencies	Innovative approach competencies
Mean	4,17	4,08	4,25	4,18	4,38
Mode	5,00	3,40	4,75	4,50	5,00
Std. Deviation	0,60	0,62	0,60	0,47	0,79

Table 2. Descriptive statistics of “competencies”

#### Factor analysis

To test the sampling adequacy, the Kaiser-Meyer-Olkin (KMO) measure was used. KMO assesses the structure validity of the research factors. As presented in Table 3, KMO values for all factors (except for two cases in which KMO is marginally below the accepted threshold) are higher than 0,60 (Fabrigar and Wegener, 2011), ranging from 0,620 to 0,780. This means that factor analysis is appropriate for the specific data set.

Total Variance Explained (TVE) measures the extent to which each factor can explain the variance of the corresponding items. For a factor to be significant, its TVE score should be above 60,00. TVE explains what percentage of the total information included in all variables is represented by the factor (Henson and Roberts, 2006). In this study (Table 3), the TVE score is higher than 60,00 for most factors, but values marginally below 60,000 are still accepted.

For convergent validity to be demonstrated, items loadings need to exceed the minimum value of 0,60. In the present study, from the initial 56 items, 16 items were excluded. In the final step, Cronbach alpha

was used in order to test the internal consistency of all factors. A value over 0,6 assures the reliability of the factors. Empirical results, see Table 3, indicate that all factors that were examined are reliable.

	Variables excluded	KMO	TVE	Factor Loadings	Cronbach Alpha
Cognitive competencies	2	0,620	58,981	0,59 - 0,83	0,75
Functional competencies	2	0,780	58,468	0,68 - 0,79	0,80
Personal / social competencies	2	0,747	64,293	0,78 - 0,83	0,81
Vision and goal-setting competencies	1	0,578	68,830	0,65 - 0,95	0,76
Innovative approach competencies	0	0,620	81,425	0,78 - 0,96	0,84
Personality	4	0,682	57,690	0,51 - 0,80	0,76
Successful change management	4	0,722	59,798	0,75 - 0,94	0,72

Table 3. Factor analysis

	A	B	C	D	E	F	G
Age	0,232**		0,285**				
Education	0,220*	0,331**	0,385**	0,219*	0,341**	0,225*	
Job experience	0,305**		0,275**	0,393**		0,280**	0,234**
Job experience at position	0,303**	0,224*	0,346**	0,273**		0,322**	0,160*
Education / training		0,390**	0,297**		0,273**	0,186*	0,232**
A. Cognitive competencies	1	0,440**	0,818**	0,624**	0,746**	0,711**	0,345**
B. Functional competencies		1	0,613**	0,569**	0,569**	0,514**	0,544**
C. Personal / social competencies			1	0,409**	0,782**	0,544**	0,321**
D. Vision and goal-setting competencies				1	0,467**	0,731**	0,352**
E. Innovative approach competencies					1	0,608**	0,443**
F. Personality						1	0,411**
G. Successful change management							1

\* Correlation is significant (2-tailed) at the 0,05 level (2-tailed).

\*\* Correlation is significant (2-tailed) at the 0,01 level (2-tailed).

Table 4. Correlations Analysis

#### Correlation analysis

Correlation analysis was used in order to assess the relationships between the various factors of the study. More specifically, the Spearman's correlation coefficient was used. According to Table 4, a significant relationship has been found between "age" and "cognitive competencies" ( $r=0,23$ ) and "age" and "personal / social competencies" ( $r=0,28$ ). These relationships reveal that older managers have developed higher cognitive and personal / social competencies. Other researchers also examined the influence of demographic characteristics on leader competencies (Pagon *et al.*, 2008; Muethel *et al.*, 2012; Sczesny *et al.*, 2006).

Moreover, statistically significant relationships have been found between "education" and all the competencies of the research model. These results indicate that managers with higher education tend to develop enhanced competencies in all areas. These results are also supported by Louw *et al.* (2012), who

indicate that the educational / training record of a manager contributes significantly to the development of leadership competencies. Based on the above paragraphs, hypothesis H7 is supported.

Significant relationships have been also found between “job experience in the field of medical equipment” and “cognitive competencies”, “functional competencies”, “personal / social competencies”, “vision and goal-setting competencies”, “personality” and “successful change management”. These results indicate that managers with higher job experience in their field have enhanced competencies and are more effective during the change management process. Several other researchers (Louw *et al.*, 2012; Jantti and Greenhalgh, 2012) have concluded that there is a relationship between job experience and successful change management. Similarly, total years of “job experience” and “education / training” are significantly related with most of the above factors. Based on these findings, hypothesis H8 is fully supported.

Finally, the results also provided support for H1, H2, H3, H4, H5 and H6. All the independent factors of the proposed research model seem to have a statistically significant impact on the main dependent factor (“successful change management”). “Functional competencies” ( $r=0,55$ ) and “innovative approach competencies” ( $r=0,44$ ) are two factors with the highest effect on the success of the change management process.

## CONCLUSIONS

The aim of this study was to investigate the relationship between leadership competencies and successful organisational change. A new research model has been developed, examining the influence of different leadership competencies, demographics, personality traits, and prior knowledge and experience on the overall success of the change process.

The results have shown that the extent to which managers develop some competencies depends upon their demographic characteristics. For example, older managers develop cognitive and personal / social competencies to a greater extent. Moreover, managers with higher education and previous education / training develop enhanced competencies in mostly all areas. These results are also supported by previous studies (e.g. Muethel *et al.*, 2012; Sczesny *et al.*, 2006), who suggest that leadership competencies are influenced by demographical characteristics, such as gender, age and nationality. Furthermore, the importance of job experience is high, since the results suggest that managers with higher job experience (in general and in particular) develop more competencies.

The most significant result of the present study is the empirical support for the relationship between leadership competencies and successful change management. The important role of competencies

comes from the fact that managers are those who prepare the organization for the change process and, given the appropriate skills, they are the ones that can make employees positively accept the whole process (Pagon *et al.*, 2008). The relationship between leadership competencies and organisational change has been supported by other studies (e.g. Trinka, 2004; Pagon *et al.*, 2008).

In conclusion, the process of change is a quite difficult and complex. Managers play a very important role, as they are the ones that organize the process and come in direct contact with employees in order to convince them about the necessity of change. In this sense, the efficiency of the process depends not only on their personal characteristics (demographics) but, also, on whether managers have developed the right mix of competencies to deal with different situations. Executives who do not possess the right skills, are not able to effectively complete the changes or to encourage employees to accept them. Therefore, organizations should employ people with substantial and varied abilities but, also, invest in education and training in order to develop firm-specific skills.

## REFERENCES

- Agote, L., Aramburu, N. and Lines, R. (2016), "Authentic leadership perception, trust in the leader, and followers' emotions in organizational change processes", *The Journal of Applied Behavioral Science*, Vol. 52, No. 1, pp. 35-63.
- Alavi, S. B. and Gill, C. (2016), "Leading Change Authentically How Authentic Leaders Influence Follower Responses to Complex Change", *Journal of Leadership & Organizational Studies*, Vol. 24, No. 2, pp. 157-171.
- Alkahtani, H., Abu-Jarad, I., Sulaiman, M. and Nikbin, D. (2011), "The impact of personality and leadership styles on leading change capability of Malaysian managers", *Australian Journal of Business and Management Research*, Vol. 1, No. 2, pp. 70-99.
- Allen, J., Jimmieson, N.L., Bordia, P. and Irmer, B. (2007), "Uncertainty during Organizational Change: Managing Perceptions through Communication", *Journal of Change Management*, Vol. 7, No. 2, pp. 187-210.
- Avery, G.C. (2004), *Paradigms of Leadership: Theory and Cases*, Sage, Thousand Oaks.
- Bakari, H., Hunjra, A. I. and Niazi, G. S. K. (2017), "How Does Authentic Leadership Influence Planned Organizational Change? The Role of Employees' Perceptions: Integration of Theory of Planned Behavior and Lewin's Three Step Model", *Journal of Change Management*, Vol. 17, No. 2, pp. 155-187.
- Barling, J., Weber, T. and Kelloway, E.K. (1996), "Effects of Transformational Leadership Training on Attitudinal and Financial Outcomes: A Field Experiment", *Journal of Applied Psychology*, Vol. 81, pp. 827-832.
- Basile, A. and Faraci, R. (2015), "Aligning management model and business model in the management innovation perspective: The role of managerial dynamic capabilities in the organizational change", *Journal of Organizational Change Management*, Vol. 28, No. 1, pp. 43-58.
- Ben Lahouel, B., Ben Lahouel, B., Montargot, N. and Montargot, N. (2016), "Exploring change conversations through the rhetoric of French leaders", *European Business Review*, Vol. 28, No. 4, pp. 486-502.
- Blake, R. and Adams, A. (1991), *Leadership Dilemmas-Grid Solutions*, Gulf Publishing, Houston.
- Burns, J. M. (2003), *Transforming leadership: A new pursuit of happiness*, Atlantic Monthly Press, New York.
- Clarke, N. (2004), "HRD and the challenges of assessing learning in the workplace", *International Journal of Training and Development*, Vol. 8, No. 2, pp. 140-156.
- Dark, F., Whiteford, H., Ashkanasy, N. M., Harvey, C., Harris, M., Crompton, D. and Newman, E. (2017), "The impact of organisational change and fiscal restraint on organisational culture", *International Journal of Mental Health Systems*, Vol. 11, No. 1, pp. 11-27.
- Deal, T. E. and Kennedy, A. A. (2000), *Corporate Cultures. The Rites and Rituals of Corporate Life*, Perseus Publishing, Cambridge.
- DeRue, D.S. and Wellman, N. (2009), "Developing Leaders via Experience: The Role of Developmental Challenge, Learning Orientation, and Feedback Availability", *Journal of Applied Psychology*, Vol. 94. No. 4, pp. 859-875.

- Dole, C. and Schroeder, R. (2001), "The impact of various factors on the personality, job satisfaction and turnover intentions of professional accountants", *Managerial Auditing Journal*, Vol. 16, No. 4, pp. 234-245.
- Droge, C., Vickery, S. and Markland, R.E. (1994), "Sources and Outcomes of Competitive Advantage: An exploratory Study in the Furniture Industry", *Decision Sciences*, Vol. 25, No. 5/6, pp. 669-689.
- Dubey, R. and Samar, S. (2011), "Study on Effect of Functional Competency on Performance of Indian Manufacturing Sector", *International Journal for Engineers and Engineering Management*, Vol. 3, No. 3, pp. 1-15.
- East, J., Gierke, G. and Raber, M. (2012), "Learning to lead in a global community", *Conference Proceedings 2012, 119th ASEE Annual Conference and Exposition, San Antonio*.
- Eddy, L.L., Doutrich, D., Higgs, Z.R., Spuck, J., Olson, M. and Weinberg, S. (2009), "Relevant nursing leadership: An evidence-based programmatic response", *International Journal of Nursing Education Scholarship*, Vol. 6, No. 1, pp. 1-17.
- Fabrigar, R. and Wegener, T. (2011), *Exploratory Factor Analysis (Understanding Statistics, Oxford University Press, UK*.
- Farr, J.V. and Brazil, D.M. (2009), "Leadership skills development for engineers", *Engineering Management Journal*, Vol. 21, No. 1, pp. 3-8.
- Felkins, P.K. (1993), *Change management. A model for effective organizational performance, Quality Resources, New York*.
- Fiedler, F. (1996), "Research on Leadership Selection and Training: One View of the Future", *Administrative Science Quarterly*, Vol. 41, pp. 241-250.
- Groves, K.S. and Feyerherm, A.E. (2011), "Leader cultural intelligence in context: Testing the moderating effects of team cultural diversity on leader and team performance", *Group and Organization Management*, Vol. 36, No. 5, pp. 535-566.
- Haveman, H.A. (1993), "Organizational size and change: diversification in the savings and loan industry after deregulation", *Administrative Science Quarterly*, Vol. 38, pp. 20-50
- Heifetz, R.A. and Laurie, D.L. (1997), "The work of leadership", *Harvard Business Review*, Vol. 75, pp. 124-134.
- Henson, R. K. and Roberts, J. K. (2006), "Use of exploratory factor analysis in published research: Common errors and some comment on improved practice", *Educational and Psychological Measurement*, Vol. 66, No. 3, pp. 393-416.
- Hill, C.W.L. and Jones, G.R. (2001), *Strategic Management: An Integrated Approach, Houghton Mifflin Company, USA*.
- Hottenrott, H., Rexhäuser, S. and Veugelers, R. (2016), "Organisational change and the productivity effects of green technology adoption", *Resource and Energy Economics*, Vol. 43, pp. 172-194.
- House, R. (1971), "A Path-Goal Theory of Leader Effectiveness", *Administrative Science Quarterly*, Vol. 16, No. 3, p. 321-328.
- Ifinedo, P. (2008), "Impacts of business vision, top management support, and external expertise on ERP success", *Business Process Management Journal*, Vol. 14, No. 4, pp. 551-568.
- Jantti, M. and Greenhalgh, N. (2012), "Leadership competencies: A reference point for development and evaluation", *Library Management*, Vol. 33, No. 6, pp. 421-428.
- Jick, T. (2001), "Vision is 10%, implementation is the rest", *Business Strategy Review*, Vol. 12, No. 4, pp. 36-38.
- Judge, T. A., Thoresen, C. J., Pucik, V. and Welbourne, T. M. (1999), "Managerial coping with organizational change", *Journal of Applied Psychology*, Vol. 84, No. 1, pp. 107-122.
- Jurkowski, S. and Hänze, M. (2012), "Cooperative learning from the perspective of social competencies: A study of the relationships of social competencies to learning outcomes, experience of learning, and collaboration product in different collaboration arrangements", *Unterrichtswissenschaft*, Vol. 40, No. 3, pp. 259-276.
- Kempster, S., Higgs, M. and Wuerz, T. (2014), "Pilots for change: exploring organisational change through distributed leadership", *Leadership & Organization Development Journal*, Vol. 35, No. 2, pp. 152-167.
- Koene, B.A.S., Vogelaar, A.L.W. and Soeters, J.L. (2002), "Leadership effects on Organizational Climate & Financial performance: Local Leadership in chain Organizations", *Leadership Quarterly*, Vol. 13, pp. 193-215.
- Kotter, J.P. (2007), "Leading change: Why transformation efforts fail", *Harvard Business Review*, Vol. 85, No. 1, pp. 96-103.
- Kuusela, P., Keil, T. and Maula, M. (2016), "Driven by aspirations, but in what direction? Performance shortfalls, slack resources, and resource - consuming vs. resource - freeing organizational change", *Strategic Management Journal*, Vol. 38, No. 5, pp. 1101-1120.
- Li, L.X. (2000), "An Analysis of Sources of Competitiveness and Performance of Chinese Manufacturers", *International Journal of Operations and Production Management*, Vol. 20, No. 3, pp. 299-315.
- Lloyd, F.R. (2010), "Do not trust your rearview mirror: The business world has evolved, and leadership requirements have changed dramatically", *Hart's E and P*, Vol. 87, No. 7, pp. 76-89.

- Louw, L., Pearse, N.J. and Dhaya, J. (2012), "The role of experience in the development of social competencies", *SA Journal of Human Resource Management*, Vol. 10, No. 1, pp. 1-9.
- Madden, J.R. (2011), "Overcoming collaboration barriers in affordable housing public-private partnerships", *Academy of Management Proceedings*, No. 1, pp. 1-6.
- Malloch, K. and Melnyk, B.M. (2013), "Developing high-level change and innovation agents: Competencies and challenges for executive leadership", *Nursing Administration Quarterly*, Vol. 37, No. 1, pp. 60-66.
- May, G. and Stahl, B. (2016), "The significance of organizational change management for sustainable competitiveness in manufacturing: exploring the firm archetypes", *International Journal of Production Research*, Vol. 55, No. 15, pp. 4450-4465.
- McGuinness, S. and Cronin, H. (2016), "Examining the relationship between employee indicators of resistance to changes in job conditions and wider organisational change: evidence from Ireland", *Evidence-based HRM: a Global Forum for Empirical Scholarship*, Vol. 4, No. 1, pp. 30-48.
- Montgomery, J.F. and Arensdorf, J. (2012), "Preparing globally competent leaders through innovative study abroad experiences", *Journal of Leadership Studies*, Vol. 6, No. 1, pp. 64-71.
- Muethel, M., Gehrlein, S. and Hoegl, M. (2012), "Socio-demographic factors and shared leadership behaviors in dispersed teams: Implications for human resource management", *Human Resource Management*, Vol. 51, No. 4, pp. 525-548.
- Muller, R. and Turner, J.R. (2010), "Attitudes and leadership competences for project success", *Baltic Journal of Management*, Vol. 5, No. 3, pp. 307-329.
- Muller, R., Geraldi, J. and Turner, J.R. (2012), "Relationships between leadership and success in different types of project complexities", *IEEE Transactions on Engineering Management*, Vol. 59, No. 1, pp. 77-90.
- Murray, P. (2003), "Organisational learning, competencies, and firm performance: Empirical observations", *The Learning Organisation*, Vol. 10, No. 5, pp. 305-316.
- Nanus, B. (1992), *Visionary Leadership: Creating a Compelling Sense of Direction for Your Organization*, Jossey-Bass, San Francisco.
- Olan, L., Sainger, B., Sentosa, I. and Ming, C. (2012), "An Empirical Testing of Managerial Competencies of Industrial Managers in Sichuan Province of China", *International Journal of Independent Research and Studies*, Vol. 1, No. 1, pp. 23-32.
- Oreg, S. (2006), "Personality, context, and resistance to organizational change", *European Journal of Work and Organizational Psychology*, Vol. 15, No. 1, pp. 73-101.
- Pagon, M., Banutai, E. and Bizjak, U. (2008), "Leadership competences for successful change management. A preliminary study report", University of Maribor, Slovenia, pp. 1-73.
- Pološki Vokić, N., Marić, I. and Hernaus, T. (2007), "Global orientation and global competencies of Croatian top managers", *Drustvena Istrazivanja*, Vol. 16, No. 3, pp. 533-555.
- Price, A. D. F. and Chahal, K. (2006), "A strategic framework for change management", *Construction Management and Economics*, Vol. 24, pp. 237-251.
- Rafferty, A. E. and Jimmieson, N. L. (2016), "Subjective Perceptions of Organizational Change and Employee Resistance to Change: Direct and Mediated Relationships with Employee Well - being", *British Journal of Management*, Vol. 28, No. 2, pp. 248-264.
- Riggio, R.E. and Lee, J. (2007), "Emotional and interpersonal competencies and leader development", *Human Resource Management Review*, Vol. 17, No. 4, pp. 418-426.
- Ristic, S. and Cekerevac, Z. (2012), "Development of leadership competence and self-improvement of the leaders", *Komunikacije*, Vol. 14, No. 2, pp. 76-81.
- Savicevic, D., Cvijetić, M. and Ivanković, Z. (2013), "Competence self-concept of leaders in education", *Metalurgia International*, Vol. 18, No. 1, pp. 175-177.
- Schein, E.H. (1999), *The Corporate Culture Survival Guide*, Jossey-Bass, San Francisco.
- Sczesny, S. (2003), "The Perception of Leadership Competence by Female and Male Leaders", *Zeitschrift fur Sozialpsychologie*, Vol. 34, No. 3, pp. 133-145.
- Sczesny, S., Bosak, J., Neff, D. and Schyns, B. (2004), "Gender stereotypes and the attribution of leadership traits: A cross-cultural comparison", *Sex Roles*, Vol. 51, No. 11-12, pp. 631-645.
- Sczesny, S., Spreemann, S. and Stahlberg, D. (2006). "Masculine = competent? Physical appearance and sex as sources of gender-stereotypic attributions", *Swiss Journal of Psychology*, Vol. 65, No. 1, pp. 15-23.
- Senior, B. and Fleming, J. (2006), *Organizational change*, Prentice Hall, USA.
- Smollan, R., Matheny, J. and Sayers, J. (2010), "Personality, affect and organizational change a qualitative study", In: W. F. Zerbe, N. M. Ashkanasy, and C. E. J. Hartel, *Research on emotions in organizations*, Vol. 6, pp. 85-112, Emerald Insight, Bingley, UK.



- Supamanee, T., Krairiksh, M., Singhakhumfu, L. and Turale, S. (2011), "Preliminary clinical nursing leadership competency model: A qualitative study from Thailand", *Nursing and Health Sciences*, Vol. 13, No. 4, pp. 433-439.
- Teo, S. T., Pick, D., Newton, C. J., Yeung, M. E. and Chang, E. (2013), "Organisational change stressors and nursing job satisfaction: the mediating effect of coping strategies", *Journal of Nursing Management*, Vol. 21, No. 6, pp. 878-887.
- Toor, S.R. and Ogunlana, S.O. (2008), "Leadership skills and competencies for cross-cultural construction projects", *International Journal of Human Resources Development and Management*, Vol. 8, No. 3, pp. 192-215.
- Trepanier, S., Crenshaw, J. T. and Yoder-Wise, P. S. (2016), "Risk Taking", *Nursing Administration Quarterly*, Vol. 40, No. 4, pp. 307-311.
- Trinka, J. (2004), "Building great leaders at the IRS", *Industrial and Commercial Training*, Vol. 36, No. 6/7, pp. 262-264.
- Vakola, M., Tsaousis, I. and Nikolaou, I. (2004), "The role of emotional intelligence and personality variables on attitudes towards organizational change", *Journal of Managerial Psychology*, Vol. 1, No. 2, pp. 88-110.
- van der Voet, J. (2016), "Change leadership and public sector organizational change: examining the interactions of transformational leadership style and red tape", *The American Review of Public Administration*, Vol. 46, No. 6, pp. 660-682.
- Virtanen, T. (2000), "Changing competences of public managers: tensions in commitment", *The International Journal of Public Sector Management*, Vol. 4, No. 13, pp. 333-341.
- Waldman, D., Ramirez, G., House, R. and Puranam, P. (2001), "Does leadership matter? CEO leadership attributes and profitability under conditions of perceived environmental uncertain", *Academy of Management Journal*, Vol. 44, pp. 134-143.
- Wanberg, C. R. and Banas, J. T. (2000), "Predictors and outcomes of openness to changes in a reorganizing workplace", *Journal of Applied Psychology*, Vol. 85, No. 1, pp. 132-142.
- Werkman, R. (2009), "Understanding failure to change: a pluralistic approach and five patterns", *Leadership & Organization Development Journal*, Vol. 30, No. 7, pp. 664-684.
- Will, M. G. (2015), "Successful organizational change through win-win: How change managers can create mutual benefits", *Journal of Accounting & Organizational Change*, Vol. 11, No. 2, pp. 193-214.
- Zorn, T.E., Christensen, L.T. and Cheney, G. (1999), *Do We Really Want Constant Change?*, Berrett-Koehler, San Francisco.

## MARKETING AND PR ACTIVITIES OF THE LEADING WORLD UNIVERSITIES: MODERN TOOLS AND DEVELOPMENT TRENDS

Chernysheva, Anna; Kalygina, Valentina; Zobov, Alexander

Faculty of Economics, RUDN University, Moscow, Russia

### ABSTRACT

The present article summarizes the main aspects of marketing evolution, which is characterized by the development of both “inward” – throughout the whole system of company’s business-process, and “outwards” – into the social and political society sphere. These processes are described on the example of the research of marketing and PR-activities of the leading world universities. The research was conducted by the Marketing department of RUDN University in the spring of 2016 in the frame of Russian Academic Excellence Project 5-100.

As part of the study the methods and tools of the universities’ promotion were examined and summarized through the corporate websites, social media and traditional media. The conclusions about the running information traffic which is generated by the universities and which is focused on both external and internal target audience were done.

*Keywords: Total marketing, PR in higher education, research of PR-activities, marketing in higher education, new media, social media, websites of universities*

### INTRODUCTION

The Russian system of higher professional education, which boasts Universities with traditions that trail back down through the centuries – as well as reflecting the pride of their own formidable academic reputations – now faces an arduous task: how to keep in step with the current pace of international development while not undermining its own excellent academic antecedents. The launch of the Project 5-100 sent a new satellite into orbit to assist in the process of revamping Russian higher education and make and giving it a contemporary. The goal of Project 5-100 is to maximize the competitive position of a group of leading Russian universities in the global research and education market. "Excellence Initiatives"

similar to the Russian Academic Excellence Project 5-100 are now among the in-vogue imperatives of many governments. Their aim is to better the system of higher education and anchor their national Universities to loftier positions in the global ratings. In 2015, the Russian University of Friendship of Peoples (PFUR – RUDN University) was among the winners in the competition to receive state

support in the framework of the 5-100 Project. In the frame of this project the scale researches of marketing and PR-activities of the leading world universities were starting in order to study their experience in the fields of promotion of their brands.

Marketing tools and technologies have become full, mandatory elements for not only proper functioning of commercial enterprises but also for politics, education, medicine, sport, nonprofit organization. They are also extremely important for the Universities. Well-formed marketing policy can help universities boost rankings, manage crises, increase donations, attract promising students, recruit academic staff, create their brands and etc.

Assessing the development of marketing both the concept and the complex of practice activities it's necessary mark its total character. Marketing is growing of both "inward" – throughout the whole system of company's business-process, and "outwards" – into the social and political society sphere. Marketing tools the effectiveness of which has been proven in business are adapting to the features of non-commercial organizations and specific spheres of society. To be fair, it should be mentioned that Philip Kotler, in 1989 (Kotler, 1989) noted the growth of the use of the marketing concept by non-profit organizations to improve their basic indicators. Russian universities have just faced challenges in international competition. Taking into consideration this circumstances the study of the leading world universities' modern marketing tools directed to the promotion of their brands and eventually to the increasing of their competitiveness has a huge practical value for Russian universities. The Benchmarking can be very useful for understanding the modern marketing tools in higher education in order to survive in this competition.

Back in 1963, J. Marston proposed a formula for successful Public Relations Formula – RACE (Research – Action – Communication – Evaluation) (Marston, 1963). We will not go into the depth of this formula, although each of these aspects deserves a separate consideration. But we have just determinate that before anything can be done, it is necessary to conduct detailed studies.

As mentioned above the analysis of the word university' marketing activity was conducted in the frame of the project 5-100. The first wave of this research was dedicated to the PR activity of the universities through the Internet. And in this Paper we would like to focus on this issue.

S. Catlip, A. Center, G. Broom suggested the following definition: "The PR is a management function that facilitates the establishment or maintenance of mutually beneficial relations between the organization and its public on which its success or failure depends" (Gatlip et.al., 1994). So we can assume that the proper use of PR tools will be very helpful for universities for the achieving their goals. Regardless of the university structure, public relations and promotion (also called integrated marketing communication) were being used at colleges and universities long before the terms "marketing" or "integrated marketing" came into play (Morris and Cejda, 2001).

## RESEARCH AND METODOLOGY

The research was conducted by the leading experts of Marketing Department with the participation of the senior students in the frame of TOP-5-100 project.

The study was carried out during the period from April to September 2016.

19 universities with classical method of education were selected. The main criterion for the choice was the high performance rating in QS World University Rankings, because the main objective of RUDN University is to improve its indicators in this Ranking.



Figure 1. The main objectives of RUDN university in the 5-100 project.

Source: About the project 5-100. <http://www.rudn.ru/5-100r/about>

But a sample based only on this criterion would imply research of universities that are not competitors of the RUDN University, targeting another core audience. So additional criteria were added:

1. There are universities from all continents must be presented in the sample
2. The universities with the similar with RUDN indicators must be included to the sample.

So the following universities were selected:

NN	University	Country	QS World University Rankings
1	University of Illinois at Urbana-Champaign	USA	59
2	Cornell University	USA	17
3	Yale University	USA	15
4	University of Toronto	Canada	34
5	Universidade Estadual de Campinas	Brazil	195
6	Universidad de Buenos Aires	Argentina	124
7	Lund University	Sweden	70
8	University of Copenhagen	Denmark	69

9	Uppsala University	Sweden	102
10	University of Amsterdam	Netherlands	55
11	Ruprecht-Karls-Universität Heidelberg	Germany	66
12	Aalborg University	Denmark	356
13	Tsinghua University	China	25
14	National University of Singapore	Singapore	12
15	The University of Hong Kong	Hong Kong	30
16	Seoul National University	South Korea	36
17	The Australian National University	Australia	19
18	The University of Melbourne	Australia	42
19	University of Cape Town	South Africa	171

Table 1. *Target sample of the study*

Depending on the nature of the tasks and sources of information, various methods of analyzing are used. According to the degree of formalization, all methods are divided into formalized and expert.

The formalized methods include economic-statistical (extrapolation and correlation-regression), as well as structural. In this case, time-series data obtained on the basis of representative statistics are studied.

When it is impossible to obtain sufficient statistical information, expert methods of analysis are used. The expert method is based on the ability of specialists conducting research to find solutions to a specific problem.

Execution of examination consists of the following stages:

1. Preliminary stage
2. Group development
3. Preparation of research and Research
4. Processing and analysis of results

The indicator of the generalized opinion of the experts conducting the study is a simple and weighted average ( $\overline{C}_j$  and  $C_j$ ) values of compliance with the eligible selection criteria.

$$\overline{C}_j = \frac{\sum_{i=1}^m c_{ij}}{m} \quad (1)$$

$$C_j = \frac{\sum_{i=1}^m c_{ij} \times k_i}{\sum_{i=1}^m k_i} \quad (2)$$

m – N of experts (i – 1, 2...m)

$c_{ij}$  – percentage estimate given by the  $i$ -th expert of the correspondence of the  $j$ -th criterion to the exposed selection conditions.

$k_i$  – competence of the  $i$ -th expert

The indicators of the degree of

The degree of consensus between the opinions of various experts is also of interest. The coefficient of variation of the estimates  $V_j$ , the correspondence of the  $j$ -th criterion to the exposed selection conditions, is calculated in the following sequence. The variance  $\sigma_j^2$  and the standard deviation  $\sigma_j$  of the estimations, the correspondence of the  $j$ -th criterion to the exposed selection conditions

$$\sigma_j^2 = \frac{\sum_{i=1}^m (c_{ij} - C_j)^2}{m} \quad (3)$$

$$\sigma_j = \sqrt{\sigma_j^2} \quad (4)$$

Then, the coefficient of variation  $V_j$  of the estimates, of the compliance of the  $j$ -th criterion with the exposed selection conditions is determined:

$$V_j = \frac{\sigma_j}{C_j} \times 100\% \quad (5)$$

The smaller the coefficient of variation, the higher the degree of consistency of expert opinions. If  $V_j < 33\%$ , the opinions of experts are considered to be consistent, and the received value is taken as the final group estimate.

When analyzing the obtained average group estimate, it is necessary to determine the size of the area in which the future value of the estimated value will fall with a given probability  $P$ . This area is determined by the magnitude of the possible limiting error of the mean  $\Delta$ :

$$C_j - \Delta_j \leq C_j \leq C_j + \Delta_j \quad (6)$$

$$\Delta_j = t \times \mu_j \quad (7)$$

Where  $t$ - confidence ration (Student's T-Test)

$\mu$  - The mean square error of the arithmetic mean

$$\mu_j = \frac{\sigma_j}{\sqrt{m}} \quad (8)$$

In the process of the study, the criteria selection was recognized as reliable, and the experts' opinions - agreed, while the maximum error limit was not more than 5%.

A research hypothesis reflected rather obvious tendency that takes place in modern marketing in general and in marketing in higher education in particular. We mean that all major marketing communications are increasingly shifting to the Internet. Actually from the mid-1990 s onwards, the purpose and value of the Internet and then social media gradually engaged the interest of public relations practitioners and evaluators (Watson, 2012) but for the universities this direction has become very important not so long ago, but is becoming more and more important. According to the results of Hanover Research, “perhaps the largest area of innovation and growth in higher education marketing and branding, as well as in recruitment, is in the online and digital space. Although there is still some doubt that institutions are using technology to its full potential, particularly with social media and other emerging platforms, a recent survey by the University of Massachusetts Dartmouth indicated that nearly 100 percent of institutions polled use some form of social media as part of their marketing and overall operations” (Hanover Research, 2014).

That’s why it was decided to analyze the specific practice of the selected universities in so called new media namely websites and social networks and in traditional mass media. In the process of research, it was decided not to specifically distinguish between marketing activities and PR activities. In our opinion, in real practice these types of university activities are realized in a single process, first of all, when the tools of communication influence are investigated. One of the first scholars who argue for the integration of marketing and PR in higher education was B.A.Miklich (Miklich, 1988).

Each university was analyzed in the following area.

Sites: languages; Structure; Interesting facts or sections, which attract the attention; mentioning of the website in Internet; PR activity highlighted on the site; conferences and other scientific events, which took place in the university; papers and other scientific publications; scientific achievements; international cooperation; sections that are not on the sites of RUDN.

Social networks: social networks where the university is presented; number of subscribers; the main information presented in the network; Interesting facts or sections, which attract the attention; PR activity highlighted in the network; conferences and other scientific events, which took place in the university; papers and other scientific publications; scientific achievements; international cooperation.

Traditional mass media (press, radio, TV): scientific articles of the academy staff; Interview of the representatives of academy staff to mass media; mentioning about the university in news, expert reviews, articles; participation of university staff in public speeches as experts; other forms of information about the university.

It should be said that the main goal of our research was to study how to use modern means of communication for PR

Taking into account the collected and analyzed significant factual material, we've concentrated on the main results of the research without their detailed elaboration. This research is planned to be carried out annually, expanding the number of research universities to 50 including a number of Russian universities and universities from the CIS countries.

## ANALYSIS AND RESULTS

### **Websites of the universities**

The university's website is the first source to be contacted in order to obtain information about the university. Therefore it is very important that it reflects all the opportunities and dignities of the university.

In the opinion of Wendy G. Ford, very little literature exists on the functional purpose of a college's Web site (Ford, 2011). The main elements of the analyzed universities websites are given above. Due to certain limitations, we present only some of the results of our study on the issue.

First of all it was revealed that the most part of the selected universities has sites with several language versions. Sites in English are dominated. 95% of universities have version in English, 37% of them – in English only, 53% - in two languages: on the local language and in English and just 5% of the sites has version in additional language besides English and local language.

In the course of the study the following interesting sections and features of site navigation were identified:

1. News about the achievements of the universities
2. Job opportunity in social network
3. Rector's blog
4. Information about graduates
5. Donations
6. Tips
7. Job opportunities
8. Cooperation
9. Comfortable navigation
10. Objects of the university for the year
11. Join programmes
12. Research portal on-line

The most prevalent positions which were indicated by the students as the potential users were "Interesting design", "Comfortable navigation" (42% of the universities). Next by popularity are "Comfortable interface" and "Events in the University on the first page (37%)". News about the achievements" attracted the attention in 26% of the universities, but Job opportunity in social



networks”, comfortable search at courses and “Information about graduates” in 11% of the universities.

Information about the studied universities (and about their sites) could be found in the Internet-sources, dedicated to the education abroad (58%). Also more than a half addresses of the sites can be found on the most popular web-site Wikipedia (53%) .

### **Social networks**

As part of the study it was indicated that all the analyzed universities make active use for their promotion the following popular social networks; YouTube, Facebook, Twitter, Instagram. It’s absolutely true that people usually become motivated to share important information with their friends on the network, because they expect their experience to be helpful or of any use to someone ( Gajic, 2012).

While the higher the university in the QS Ranking the greater its presence in global social networks. Absolute leader in the number of subscribers in all social networks is Yale University (USA) – more than 80 000 subscribers.

The most popular social networks among the universities are: Twitter (83% has it), Facebook (78%), YouTube and Instagram. Exceptions are Chinese universities; in particular Tsinghua University in social networks is not represented at all.

On YouTube usually scientific events are loaded as well as Awards ceremony of competitions and Olympiads, video for the different festivities, exhibitions and festivals. Sometimes you can find interesting information about the university, interview with representative of science, video clip about students’ life.

On Facebook the universities usually place information about scientific events, PR events, articles’ review, and scientific achievements of the universities. More than a half of the information is occupied by non-scientific announcements, such as: international internships, student events, concerns, exhibitions, festivals, alumni meetings, competitions, prizes, interesting facts about the university, the city where the university is located, the country in general, also tips for students.

Twitter links to the publication of the official site of the University, as well as on the photos and videos published by the university.

In Instagram, the information about university life in all its manifestations: scientific achievements, awards, prizes, studies, articles, exhibitions, competitions and other. Also student photos and video materials about current events are presented.

In general universities quite broadly cover interesting facts about themselves in social networks, which causes interest both for entrants and their parents, and for the students themselves to their university and its life.

In the course of the study the following interesting sections were identified:

1. Photo and video from the scientific and non-scientific events
2. Actual problems of the universities
3. The results of R&D
4. Traditions, customs and symbols of the country
5. Internship, joined programs
6. Students life
7. International cooperation
8. Sports achievements
9. Charity events
10. Information about honorable graduates
11. Congratulations students

The most popular are news of the university (25%), then photos and videos of the university and its students (17%), another interesting fact in social networks is student life (12%) and interesting scientific development of universities (10%).

Very interesting examples specific to individual universities were identified. For example, University of Hong Kong has its own Smartphone application where you can find the following information: the main news, current events, students' life, map, library's news, foods, timetable, bus schedule.

University of Copenhagen has launched application for Smartphones through which UCPH students can see on-line the timetable of lessons and exams; receive notifications of upcoming events, contact with lecturers and access lectures.

### **Mass Media**

As part of study it was made an attempt to estimate the scale and features of the using by the universities of traditional mass media for their promotion. It was discovered that it's quite difficult to find published articles and speeches of the university representatives. Such informational actions leave few "traces" in the information space. Therefore, we had to evaluate this channel by indirect indicators, using the links to them from the university websites, social networks and specialized portals on the Internet.

Many universities have published articles in popular science journals; however, not all the universities have a single server, database, archive for the references to specific sites and sources of all articles. Most articles are scattered on the Internet, which makes it very difficult to find them.

In the course of research it was revealed that a number of universities use very actively the speeches in the genre of «conversations with an expert" and interview with the representatives of the universities. These tools are placed not only in traditional mass media but also on the web-sites and in social

networks. Moreover according to the rough estimates obtained in the course of the study it turned out that 30-35% of total number of all interviews and expert speeches is related to the traditional mass media.

It should be noted the main part of the interviews is mainly focused on the acute issues of economics, sociology and medicine. Interviews about university life are just in fourth place and mainly placed in the social networks.

## SUMMARY AND CONCLUSIONS

The results of this study allow us to formulate the following conclusions.

1. All leading universities generate a significant, and apparently increasing, information flow directed at a wide variety of external and internal target groups. External ones are employers, the scientific and educational community, applicants and their parents, state and non-profit organizations. Internal - students, teaching staff, university faculty.
2. Such huge information flow implies the existence of an administrative and proactive system for the content creation, its editing and transmission. In fact we can state a full-fledged marketing information system in the analyzed universities, focused primarily on the maximum PR-activity.
3. Marketing and PR-activities of the universities are increasingly shifting to the Internet. The importance of direct advertising in traditional mass media is declining. More and more this activity goes to the Internet. The main communication channels are the university's website and the world's major social networks. Even the promotion in traditional media is provided by a complex of electronic communications.
4. All these tendencies form extremely urgent challenges for Russian universities. A serious reorganization of marketing approaches is needed, for the increasing their recognition and attractiveness in the world market of higher education.
5. This research can be useful for the following study of the marketing activity of universities. Further researches should explore such topics as the influence of certain factors on the choice of the university, adaptation of marketing programs to the local markets, promotion of the university's brand in foreign markets, the possibility of applying the marketing tools of foreign universities to promote their own university etc.

## REFERENCES

- Cutlip, S.M., Center A.H., Broom G.M. *Effective Public Relations: 7th Edition*. - N.J.: Englewood Cliffs, 1994.-P. 6
- Ford, G. Wendy. "Evaluating the Effectiveness of College Web Sites for Prospective Students", *Journal of College Admission*, 2011. Available at: [file:///C:/Users/user/Downloads/Effective-websites%20\(1\).pdf](file:///C:/Users/user/Downloads/Effective-websites%20(1).pdf) (accessed 10.06.2017)

- Gajic, Jelena Importance of marketing mix in higher education institutions. *Journal of Applied Science* 9(1). Belgrade, January 2012, p.29-141
- Hanover Research (2014). "Trends in Higher Education Marketing, Recruitment, and Technology", *Academy Administration Practice*, Washington, 2014.
- Kotler, Philip. "Strategies for Introducing Marketing into non-profit organization", *Journal of Marketing*, 43 (January), Vol. 43, p. 37-44.
- Marston, John E. "The Nature of Public Relations", McGraw-Hill Book Company, NY, 1963
- Morris L. Michelle, Brent D. CejdaI. "Integrated marketing in higher education", *Research Report*. West Texas Higher Education Research Consortium, 2001, p. 52.
- Miklich, B.A. (1988). "An integrated marketing effort: How it is implemented". *Journal of Marketing for Higher Education* 1, 1988, 15-30.
- Watson, T. "The evolution of public relations measurement and evaluation", *Public Relations Review* (2012), doi:10.1016/j.pubrev.2011.12.018

## THE LONG-TERM EFFECTS OF CVDS ON ECONOMIC DEVELOPMENT: THE CASE OF BANGALORE

Chinnaswamy, Anitha K.<sup>1</sup>; Garcia-Perez, Alexeis<sup>1</sup>; Marshall, Ian M.<sup>1</sup>; Naguib, Raouf<sup>2</sup>

<sup>1</sup>Faculty of Business and Law, Coventry University, UK

<sup>2</sup>BIOCORE Research & Consultancy International, UK and The Faculty of Science, Liverpool Hope University

### ABSTRACT

The aim of this paper is to demonstrate the economic and health burden of Cardiovascular diseases (CVDs) in the context of Bangalore during the period 2010-2013. A data set containing in excess of 1 million historic records corresponding to all-cause mortality was obtained from the central repository data register. After a data quality assessment, a dataset of n=183,893 was obtained. Spatial analysis was carried out to highlight the hotspots of CVD. Potential Years of Life Lost due to CVD and Present Value of Lifetime Earnings were computed. CVDs were responsible for 25% of the total of potential years of life lost. The potential value of lifetime earnings highlighted a loss in excess of 8 billion INR over the four years. CVD poses a tremendous challenge for socio-economic development, and there is an urgent need for a strategic action to promote CVD prevention and enable a sustainable development for the economy.

**Keywords:** Cardiovascular diseases, economic health burden, GIS spatial analysis, Bangalore, potential years of life lost, present value of lifetime earnings.

### INTRODUCTION

Cardiovascular diseases are the world's leading cause of mortality. According to the World Health Organisation (WHO, 2013), an estimated 17.3 million people per year die of CVDs worldwide. Thus, CVD-related deaths accounts for 3 times more than those related to infectious diseases, including HIV/AIDS, Tuberculosis and Malaria combined (Beaglehole and Bonita, 2008). The World Health Organisation estimate that by 2030 the number of deaths due to CVD will increase to 23.6 million, remaining as the single leading cause of death globally (WHO, 2013). Bloom et al. (2011) state that over half of those who die from chronic non-communicable diseases such as CVD are generally in the prime of their productive years. This loss of lives may therefore have a significant impact not only on

society but also on the economies of the nations. This is particularly true for low- and middle-income countries as they bear the burden of over 80% of CVD-related deaths per year worldwide.

Despite the abundance of studies stressing the fact that CVDs have a direct impact on socio-economic development, limited research has been conducted to quantify such a burden to the context of a region, a nation or even a city. This highlights the need for research which informs decision making in addressing the challenges posed by CVDs to society.

#### *Cardiovascular diseases in the context of India*

India is set to become the world's youngest nation by 2020, when the country is expected to have 64% of its population in the working age group. While the western economies, Japan and even China are aging, this demographic potential presents India with an unprecedented edge due to a significant growth rate (The Hindu, 2013).

There is however a threat to India's economic growth. India has witnessed a significant increase in CVDs over the recent decades (Gupta et al., 2011) and CVD has become the top cause of mortality in the country (Ramaraj and Chellappa, 2008). In 1990, CVDs accounted for 63% of all deaths in India, which contributed to 17% of worldwide mortality. Research conducted in the early 2000s by the World Health Organisation (WHO) estimated that by 2010, 60% of the world's cardiac patients would be Indians (Ghaffar et al., 2004). Furthermore, Gaziano (2006) predicted that in this decade 50% of the Indian population who die from CVD will be below the age of 70.

The human, social and economic consequences of CVDs are felt by the society in large. The effects of CVD are not only a health concern but also affects the social aspects of life. As the disease correlates to a decreased life expectancy, there is a huge impact on the individual as well as their family (HealthTalk, 2014). Individuals are known to be concerned about not being able to see their children or grandchildren grow up, they also go through a range of emotions that include anxiety, loss of confidence, anger, frustration, irritability and short temperedness, and depression.

Healthcare in India is highly privatised, with most of the outpatient or inpatient care sourced through the private sector (NSSO, 2006). The large population lacks any form of health cover with nearly 90% of the population paying for healthcare as out-of-pocket (OOP) expenditures (MOHFW, 2005). This form of OOP expenditures has catastrophic effects on households where an individual is affected by CVD. India is witnessing more and more younger people affected by CVD in the country, with an increasing number of them being the sole bread winners for the family has a devastating social and economic impact on individuals and their households.

In abstract economic terms, India was estimated to have lost US\$8.7 billion due to affliction from CVD and diabetes up until the end of the last decade (Ajay and Prabhakaran, 2010), and the WHO estimated that this figure reached US\$237 billion in over the 10-year period between 2005 and 2015

(Goenka et al., 2009). Furthermore, the GDP of the country was estimated to have fallen by 1% due to the combined economic impacts of CVD and diabetes (Prabhakaran et al., 2016; Abegunde and Stanciole, 2006). There is scientific evidence that indicates that Indians tend to acquire the disease at least 10 years earlier than their western counterparts (Vamadevan et al., 2011). This will have a significant impact on the economically active population due to disability and premature death as a result of the disease. However, despite the relevance of the subject there has been a limited number of studies that highlight the statistics of CVD and its actual economic impact in India. Without an understanding of the economic burden of CVDs, it is difficult for decision makers to determine the approach and allocation of resources for management of CVD prevention and control strategies.

This research has been set to demonstrate the potential impact that CVDs may have on socio-economic development. The study is based on the city of Bangalore due to its economic significance for the country's development. By analysing CVD mortality in Bangalore and its impact on economic growth, this research has highlighted the imperatives of a strategy to raise awareness at all levels, from policy makers to the public, on the relevance and potential approaches to CVD prevention and control. To achieve this aim, a data set containing in excess of 1 million historic records corresponding to all-cause mortality in Bangalore was analysed using a Geographic Information System. Hotspots of CVDs in Bangalore were identified, Potential Years of Life Lost due to CVDs and Present Value of Lifetime Earnings were computed, relating these to geographic locations across the city.

## **METHODS**

### *Case study rationale*

Although there is a devastating social and economic burden of CVD in India, there have been limited studies to highlight the economic losses that result from these diseases. Access to quality, reliable data about the disease and its impact on society and economy is one of the key barriers to research in this area. Access to a novel data set from Bangalore paved the way to initiate this research, which carried out an intensive examination of mortality and its relation to CVD, taking the Indian city as a case study. Other factors including the explanatory nature of the research, the fact that the phenomenon was to be studied in its real-life context and the multitude of variables related to CVD and its impact on economy and society, made case study an ideal approach to the conduct of this research (Yin, 2009).

### *Case study area*

Bangalore is the capital of the Indian state of Karnataka and is home to several major industries, as well as commercial and educational centres. It is also a leading hub for Information Technology (IT)

and biotechnology centres. Bangalore is popularly known as the 'Silicon Valley' of South-East Asia. In addition to the wealth of employment and educational opportunities Bangalore offers, it also enjoys a pleasant climate. Bangalore has hence witnessed a population boom with an increased migration subsequently influencing the infrastructure of the city (Aranya 2003). Bangalore has a population of 8.4 million people making it the third largest city in India. The economic growth and the urban evolution have contributed to cultural shifts in lifestyles and behaviours in the city. Although Bangalore is inundated with issues derived from the incidence of CVDs in its population, not enough research has been done to understand the incidence of the diseases and no known study highlights the CVD mortality statistics and their economic impact. This makes of the context of Bangalore an ideal case scenario for the study of the subject.

#### *Data collection*

Data was obtained from the administrative body responsible for the civic and infrastructural assets of the Greater Bangalore metropolitan area, (the Bruhat Bengaluru Mahanagara Palike – BBMP hereafter). For the purposes of this research, the central repository centre was visited and authorisation was obtained to collect the inputted records from the system. Given the perceived importance of this research and the potential benefits associated to its findings, the researchers were provided with access to the entire database, including a total of  $n = 1,090,899$  historic records for the years 1930–2013. Each of these records included date of death, address, age, gender and cause of death.

#### *Pre-analysis of the data collected*

A statistical software package, IBM SPSS20, was used for the analysis of the data collected. The variables to be analysed were geographical zone, age groups, year of death, place of death, gender and the cause of death. The data was coded according to cause of death by using the International Classification of Diseases, Tenth Revision, Clinical Modification (ICD-10-CM). ICD-10-CM is a system used by physicians and other healthcare providers to classify and code all diagnoses, symptoms and procedures recorded in conjunction with hospital care in the United States. ICD-10-CM codes start from A00-Z99, with CVD mortality codes ranging between I00–I99.

#### *Data cleansing and reduction*

The data set was subjected to descriptive statistical analysis to determine its quality in terms of the parameters described in Table 1. The initial analysis showed that not all of the original  $n=1,090,899$  records had the cause of death recorded. The absence of cause of death does not assist in the analysis of death rates attributed to specific conditions such as CVD. Hence those records were deemed invalid for the purpose of this research.



A second stage in the process of data reduction consisted of the contextual analysis of the data. Given the potential variations in CVD-related statistics as well as in the socio-economic background of Bangalore over the period covered by the data set (1930–2013), the researchers concluded that not all data was valid for the study. It was decided to focus on the data for the last four years (2010–2013), which consisted of a dataset with  $n=183,893$ . For the purpose of data quality assessment, the resulting dataset was finally subjected to data quality assessment using the parameters defined by Turner (2002), summarised in Table 1.

Table 1: *Dimensions of Data Quality (Turner, 2002)*

<b>Dimension</b>	<b>Description</b>
Amount of data	Sufficiency/Insufficiency of information
Timeliness	Freshness and up-to-date state of information
Objectivity	Whether the information was objectively collected
Relevancy	Whether the information is useful/relevant/appropriate/applicable to intended purpose
Completeness	The expectation that certain attributes are expected to have assigned values in a dataset
Accuracy	The level to which stored data agrees with accepted sources of correct information
Access security	Whether the information is protected against unauthorised access

The accuracy of the dataset resulted in 19.4% of the initial number of records being discarded as the cause-of-death recording was either absent or inaccurate. As the geographic distribution of deaths is vital to determine the trends and patterns of deaths, it is necessary that all records have the address of the deceased accurately recorded. The current Medically Certified Cause of Death (MCCD) recording practice in Bangalore does not prioritise the recording of the address of the diseased. This resulted in a further reduction of the valid dataset.

As a conclusion of this stage of the data reduction process the assessment of the current data quality issues in recording mortality events conducted by Chinnaswamy (2015), determined that the system for Bangalore had a completeness level of 73%.

## RESULTS OF THE DATA ANALYSIS

This section presents a comprehensive analysis of the CVD deaths in Bangalore. Descriptive statistics highlight overall CVD deaths in the city and CVD deaths by zone. Spatial statistics using a GIS map the CVD deaths highlighting the hotspots of the disease in the city. The rate of death, potential years of life lost due to CVD and the present value of lifetime earnings for CVD are computed in this section.

#### *Descriptive analysis of CVD mortality*

The statistical analysis of the data revealed that the total Non-Institutional deaths over the years 2010-2013 were 86,818 of which 33,075 deaths were due to CVD and 53,743 deaths were due to all other causes. CVDs over the four years on an average contributed to 38.10% of all deaths. Zones West and East had the highest mortality followed by zones South and Mahadevapura. However, when the percentage of total deaths is considered, CVD deaths in zone East was the highest contributing to 50% of the total deaths.

#### *Mapping of CVD deaths using Geographic Information Systems*

The place where a person lives can influence and often determine their health and health-related quality of life and well-being. Numerous studies have highlighted the relationship between proximity to polluting sources such as highways and the risk of CVD. To aid in determining levels the rates of CVDs in the city, a Geographical Information System (GIS) was employed. GISs have the capability to identify the geographical and geospatial pattern of disease occurrences. Due to their strong capability to perform spatial analysis and decision making capabilities, GIS is gaining popularity in environmental and demographic research areas. An Environmental Health Information System (ENVHIS) based on GIS was developed which allowed the integration of data available and perform spatial analysis. Choropleth maps of the population highlighting the zones with the highest population were produced. CVD deaths were then geocoded for every zone was also integrated as a layer in the GIS-based system. Overlay techniques were used to superimpose the layers and visualise any patterns. The zones with the highest CVD levels were mapped. Hotspots were also determined at the zonal level (Figure 1).



Figure 1: Deaths by zone

This analysis highlighted that the zones West, East and South have the highest CVD mortality rates across the region (Figure 1). Table 2 represents the analysis of deaths by age groups and gender. Although in absolute numbers the quantity of CVDs are highest for the age group 75+, when CVDs affecting early death i.e. below 70 years of age the total number of deaths is 41,388 contributing to 66% of total CVD deaths. This is an important factor to consider as the younger a person dies, the more socio-economic impact there is on the individual’s family and the community at large.

Table 2: CVD deaths by age groups and gender

Row Labels	<20	20-24	25-29	30-34	35-39	40-44	45-49	50-54	55-59	60-64	65-69	70-74	75+	Grand Total
F	1976	367	412	348	601	775	1203	1356	1876	2292	2842	2620	7461	24129
M	2573	491	720	946	1572	2093	2914	3295	4005	4352	4379	4060	7388	38788
<b>Grand Total</b>	<b>4549</b>	<b>858</b>	<b>1132</b>	<b>1294</b>	<b>2173</b>	<b>2868</b>	<b>4117</b>	<b>4651</b>	<b>5881</b>	<b>6644</b>	<b>7221</b>	<b>6680</b>	<b>14849</b>	<b>62917</b>

However, rather than counting every death as equal, a measure potential years of life lost (PYLL) measurement can provide an appropriate measure of socio-economic impact by recognising that death at younger ages has higher impact than deaths at older ages which is discussed in the following section.

Disability Adjusted Life Years (DALY) measures the losses from disability or death with diseases accounting for more DALY having a higher public health impact (Murray and Lopez 2006). Health measures are then taken to reduce the number of DALY. The DALY has become a key measure employed by the WHO and countries generally perform DALY calculations to assess and monitor their population's health and to set priorities within their health sector.

DALY formula

DALY are the sum of years of life lived with disability (YLD) and Years of potential life lost (YPLL), per disease category or outcome, and per age and gender:

$$\text{DALY} = \text{YLD} + \text{YPLL}$$

The YLDs are the morbidity component of the DALYs, and are proportional to the number of incident cases and the severity of the disease:

$$\text{YLD} = \text{Number of Cases} * \text{Disease Duration} * \text{Disability Weight}$$

The YPLLs are the mortality component of the DALYs, and are proportional to the number of deaths and the average age of death. As the comprehensive morbidity data was not available for Bangalore, only the YPLL was calculated.

Years of potential life lost (YPLL), also sometimes referred to as potential years of life lost (PYLL) is defined as an estimate of the average years a person would have lived if he or she had not died prematurely (Gardner and Sanborn, 1990). Hence it can be described as a measure of premature mortality. PYLL gives more weight only to deaths that occur among younger people.

#### *Calculation*

The years of potential life lost is calculated by setting an upper reference age, this reference age normally corresponds to the life expectancy of the study population. The reference age in developed countries is usually set at 75, but this is lower in developing countries. PYLL is expressed with respect to the reference age [75]. For the purposes of this analysis, an upper reference age was first set to calculate the potential years of life lost. The upper reference age refers to the life expectancy of the Indian population, which has been determined to be 66.21 years (Chauhan and Aeri, 2013). In order to calculate an individual PYLL, the difference between the person's age at death and the reference age is calculated. If the person's age at death is higher than the reference age, it is set at 0. There is no negative PYLL, for example:

1. Reference age = 66; Age at death = 60;  $\text{PYLL}[66] = 66 - 60 = 6$
2. Reference age = 66; Age at death = 6 months;  $\text{PYLL}[66] = 66 - 0.5 = 65.5$
3. Reference age = 66; Age at death = 70;  $\text{PYLL}[66] = 0$

$$\text{PYLL} (66)(t) = \sum_{i=0}^{66} [D_A (66 - A)]$$

- $\text{PYLL} (66)$  is the total PYLL as a result of CVD, at time period  $t$
- $D_A$  - the number of CVD per age group
- $A$  - the age at death by CVD per age group
- $i$  - the number of age groups for  $A$  from 0 to 66

To calculate the PYLL for the population over a certain period, the individual PYLLs are summed for all individuals in that population who died in that year. Potential Years of Life Lost (PYLL) provides a way of weighting deaths occurring at younger ages that is preventable. This was undertaken as a cause-specific mortality for Bangalore and it was determined that CVD accounts for 25% of all PYLL in Bangalore during 2010-2013.

Because PYLL gives more weight to deaths among younger individuals, it is the favoured metric among those who wish to draw attention to those causes of death that are more common in younger people. Table 3 provides the PYLLs due to CVD according to age, gender and zone for Bangalore. It can be seen from the table that the middle age groups 35-39, 40-44, 45-49 have the highest PYLLs. For both the genders, the most affected age group is 45-49 after which the PYLL has a decline. However, CVDs have a prominent effect on males with over twice as many PYLL lives lost in males compared to women of the same age group.

Table 3: PYLLs according to age groups, gender and zone

	<20	20-24	25-29	30-34	35-39	40-44	45-49	50-54	55-59	60-64
<b>F</b>	<b>29365</b>	<b>15764</b>	<b>15738</b>	<b>11623</b>	<b>17006</b>	<b>18187</b>	<b>22242</b>	<b>18191</b>	<b>15855</b>	<b>8109</b>
Bommanahalli	915	344	566	300	482	392	680	538	493	247
Byatarayanpura	616	87	272	197	284	570	777	420	587	318
Dasarahalli	392	476	423	196	793	568	677	420	365	218
East	5647	2707	2340	2214	3370	3695	4992	4272	4036	2013
Mahadevapura	1713	1493	1529	1232	1319	1345	1818	1194	1069	555
RR Nagar	805	797	536	363	512	859	849	703	491	245
South	14278	6286	6622	4720	6733	6456	7435	6285	5315	2729
West	4999	3574	3450	2401	3513	4302	5014	4359	3499	1784
<b>M</b>	<b>38748</b>	<b>21079</b>	<b>27422</b>	<b>31471</b>	<b>44464</b>	<b>49124</b>	<b>53569</b>	<b>43974</b>	<b>33290</b>	<b>14762</b>
Bommanahalli	1361	684	1020	1033	1191	1666	1908	1392	1159	498
Byatarayanpura	248	344	707	1067	1668	2042	1802	1485	1247	519
Dasarahalli	221	811	797	960	1858	1616	1991	1512	1137	428
East	7835	3551	4705	6565	8382	10236	12169	10054	8085	3572
Mahadevapura	3026	1528	2216	2343	4134	3790	3847	3311	2564	1086
RR Nagar	1250	863	1018	1169	2088	1758	2104	1527	1319	576
South	17451	8466	10258	11159	14479	15608	17127	13863	10152	4697
West	7356	4832	6701	7175	10664	12408	12621	10830	7627	3386
<b>Grand Total</b>	<b>68113</b>	<b>36843</b>	<b>43160</b>	<b>43094</b>	<b>61470</b>	<b>67311</b>	<b>75811</b>	<b>62165</b>	<b>49145</b>	<b>22871</b>

India is the second most populous country in the world and is projected to be the world's most populous country by 2022. More than 50% of its population is below the age of 25, and more than 65% is below the age of 35. By 2020, the average age of an Indian will be 29 years and the country will thus become the world's youngest country with 64% of its population in the working age group. This demographic potential offers an unprecedented edge and economists believe it could add a significant 2% to the GDP growth rate. While the country's young demographic base is beneficial for India's growth, the threat of CVD to the population is a major challenge. With CVD contributing to over 25% of all PYLLs, there is an urgent need to address the prevention of CVD to all age groups, but in particular the younger population as valuable lives are lost to the disease.

*Present value of lifetime earnings – Loss*

This section describes the estimation of the present value of lifetime earnings (PVLE) for CVD for 2010-2013. PVLE is a simple quantitative measure used to quantify the expected value of lost earnings as contributed to the society by an individual if he or she was able to live out a full lifespan (National Center for Injury Prevention and Control, 2003). The potential economic losses to society are estimated by computing the PVLE for different age and gender groups. The average lifetime earnings for each 5-year age group by gender was obtained from the estimation as provided by Menzin et al. (2012). The estimation is based on the assumption that that all working-age individuals (>20 years) would continue to be employed. Table 4 shows the estimation of PVLE earnings by age and gender. The average lifetime earnings are multiplied by the number of premature deaths for each age group and for every gender group to calculate the expected value of lost earnings in each group. All the monetary values are expressed in Indian Rupees (INR).

Table 4: PVLE according to age groups and gender

Age Range	Male	Female	Grand Total	PVLE_M	PVLE_F	Loss_M	Loss_F	PVLE_Total
20-24	491	367	858	462,821	189,944	227245111	69709448	
25-29	720	412	1132	480,238	210,247	345771360	86621764	
30-34	946	348	1294	475,296	218,157	449630016	75918636	
35-39	1572	601	2173	462,776	212,727	727483872	127848927	
40-44	2093	775	2868	441,539	192,864	924141127	149469600	
45-49	2914	1203	4117	408,132	162,927	1189296648	196001181	
50-54	3295	1356	4651	354,499	119,883	1168074205	162561348	
55-59	4005	1876	5881	277,836	65,703	1112733180	123258828	
60-64	4352	2292	6644	181,310	16,512	789061120	37845504	
65-69	4379	2842	7221	96,659	6,699	423269761	19038558	
70-74	4060	2620	6680	54,819	3,799	222565140	9953380	
75+	7388	7461	14849	16,056	1,113	118621728	8304093	
	<b>38788</b>	<b>24129</b>	<b>62917</b>			<b>7,697,893,268</b>	<b>1,066,531,267</b>	<b>8,764,424,535</b>

This allows to conclude that the PVLE lost due to CVDs in Bangalore during 2010-2013 was INR 8,764,424,535. As presented in Table 7, it can be noted that the value of lifetime earnings varies for different ages and for genders. For men, the highest peak is at the age groups 25-29 while for women the highest age group is 30-34. It then begins to decrease at a fast rate in the middle age groups. It can be inferred that men have higher lifetime earnings in comparison with women, reflecting their potential for higher market earnings. For males, the highest potential earning groups are 25-29 and their earnings are over 40% higher than for women; by ages 65-69, men's lifetime earnings are almost 10 times that for women in India.

Lifetime earnings are perceived as a vital component of cost-of-illness studies and is a good approach that values life where productivity is based on an individual's earnings. Pre-mature mortality can hinder the labour force and impact the nation's economic resources considerably. The PVLE measure can highlight the growing economic concern due to early deaths due to a disease and hence promoting interventions.

*Present value of lifetime earnings – Zonal*

As highlighted above, the zones with the highest CVD mortality were East, South and West. The distribution of deaths by gender and age groups was categorised and the PVLE computed for the respective zones by gender and age groups (Table 5). The analysis revealed that the zone West had the highest loss of approximately 2.8 billion INR followed closely by Zone South with 2.7 billion INR. Only these three zones contribute to 87% of the total PVLE in Bangalore.

Table 5: *PVLE according to age groups, gender and zone*

	20-24	25-29	30-34	35-39	40-44	45-49	50-54	55-59	60-64	65-69	70-74	75+	Grand Total	PVLE_Total
<b>East</b>	<b>146</b>	<b>184</b>	<b>264</b>	<b>416</b>	<b>597</b>	<b>938</b>	<b>1085</b>	<b>1458</b>	<b>1677</b>	<b>1681</b>	<b>1687</b>	<b>3766</b>	<b>14920</b>	
F	63	61	66	119	158	271	320	486	581	675	726	1898	5888	
M	83	123	198	297	439	667	765	972	1096	1006	961	1868	9032	
PVLE_F	11966472	12825067	14398362	25314513	30472512	44153217	38362560	31931658	9593472	4521825	2758074	2112474	228410206	
PVLE_M	38414143	59069274	94108608	137444472	193835621	272224044	271191735	270056592	198715760	97238954	52681059	29992608	1714972870	<b>1,943,383,076</b>
<b>South</b>	<b>342</b>	<b>443</b>	<b>476</b>	<b>748</b>	<b>938</b>	<b>1325</b>	<b>1492</b>	<b>1827</b>	<b>2087</b>	<b>2316</b>	<b>1993</b>	<b>4264</b>	<b>19928</b>	
F	146	174	141	238	274	400	463	619	747	930	803	2157	7822	
M	196	269	335	510	664	925	1029	1208	1340	1386	1190	2107	12106	
PVLE_F	138659120	30696062	37959318	29994507	45901632	44641998	47953200	30420489	10220928	5004153	3533070	893739	425878216	
PVLE_M	438291487	94126648	127854624	155029960	225184890	270999648	327911575	285893244	219022480	129523060	75979134	19106640	2368923390	<b>2,794,801,606</b>
<b>West</b>	<b>196</b>	<b>266</b>	<b>287</b>	<b>501</b>	<b>708</b>	<b>957</b>	<b>1134</b>	<b>1335</b>	<b>1501</b>	<b>1707</b>	<b>1663</b>	<b>3993</b>	<b>15304</b>	
F	83	90	72	124	183	270	326	412	505	693	652	2060	5922	
M	113	176	215	377	525	687	808	923	996	1014	1011	1933	9382	
PVLE_F	15765352	18922230	15707304	26378148	35294112	43990290	39081858	27069636	8338560	4642407	2476948	2292780	239959625	
PVLE_M	90712916	127743308	136409952	231850776	312609612	390582324	402001866	370911060	272146310	164996913	91163997	64111608	2655240642	<b>2,895,200,267</b>
<b>Grand Total</b>	<b>684</b>	<b>893</b>	<b>1027</b>	<b>1665</b>	<b>2243</b>	<b>3220</b>	<b>3711</b>	<b>4620</b>	<b>5265</b>	<b>5704</b>	<b>5343</b>	<b>12023</b>	<b>50152</b>	<b>7,633,384,949</b>

Bangalore is one of the fastest growing economic hubs in India and has an estimated economic growth of 10.3%. With the highest IT-related exports in the country, Bangalore's 523 billion (US\$7.8 billion) economy makes it an important economy for India as a whole. Forbes (ICFN, 2013) has described Bangalore as one of "The Next Decade's Fastest-Growing Cities". The city is also home to over 10K-dollar millionaires and over 60,000 super-rich people. However, with the loss of life due to CVD and its associated economic costs, prevention of CVD should be of high priority for the city. The middle age adults have a prime contribution to Bangalore's economy and the loss of early CVD deaths will have a significant socio-economic burden.

## DISCUSSION

A key strength of this study consists of having used data collected by BBMP and the application of an established methodology to estimate the value of productivity losses for the Indian city of Bangalore. The analysis of deaths by zone, gender and age groups has also highlighted the patterns of CVD deaths across the city. However, the analysis was limited by a number of issues related to the nature of the data available for the research. Some of these are highlighted in this section. Although estimates of PVLE have been provided, there is uncertainty over the correct valuation of the average lifetime earnings. While we have used the best approach to valuation based on the available data, the application of a different method might result in a different estimation. Additionally, age-adjusted

rates of death could not be determined due to data non-availability, as the population census data does not include the breakdown of age groups.

Finally, using the data available this study could only provide economic estimates related to lifetime earnings for CVD mortality. We are unable to calculate DALYs or loss to households or caring activities because of the unavailability of comprehensive morbidity data. Bangalore has a disintegrated system for morbidity data collection which does not facilitate the estimation of other factors that would help project the economic consequences of CVD prevalence.

## CONCLUSIONS

To the best of our knowledge, this study is the first of its kind to provide estimates of CVD statistics and economic implications for a city, based on a country where CVD has been recognised as a major healthcare burden. These findings are applicable to many other cities and countries, which have a similar socio-economic profile to Bangalore. The impact of CVD can be measured as economical, societal or individual. The economic impact measures how the interventions and the subsequent results had an impact on the economy. Ill health adversely affects the development of human capital, which is crucial for a developing economy. The societal impact focuses on the society as a whole. Many of the risk factors that contribute to CVD are further compounded by underlying socio-economic factors as well as environment factors. The right investments will lead not only to better health, but also to longer and more productive lives. This will impact the individual, the individual's family, society and community at large.

CVD in Bangalore is established as not only as a health threat but also a major risk to the economy and development of the city. The analysis in this paper has highlighted that CVDs contribute to approximately 38% of the total deaths in the city, with more men being affected by the disease than women. The study also explored the extent of the PYLL and PVLE losses to Bangalore for the years 2010-2013, estimated in excess of 8 billion INR (more than \$120M).

It is any government's priority to provide public health programmes and a CVD management program to face the challenges of CVD health issues. The WHO (2011) states that over 50% of the CVDs can be prevented with early interventions. Quality treatment, early diagnosis, good quality medical and nursing care, specialist services - such as surgery and rehabilitation for those with CVD or who are at risk - will facilitate patient recovery and/or wellbeing. The government as a major priority must focus on prevention, diagnosis and treatment.

Evidence has indicated that with timely effective treatment and adequate intervention and prevention measures, the suffering due to CVD can be reduced and prevented. CVD policies are to be based on the best available evidence-based approaches that result from well-conducted, systematic



reviews of the relevant evidence. Policies must evolve to incorporate the conclusions of important new research as it becomes available. The spatial analysis conducted allowed for different zones of the city to be identified as the hotspots of CVD, which is also contributing to the highest PVLE. This enables governments to introduce interventions in the zones at most risk first, and this can be achieved through monitoring policies, comprehensive advice services, identification of populations at risk, increasing awareness among public health officials, doctors, health workers on the possible links of air pollution and CVD, and support the raise of public awareness about the health impacts of air pollution.

This research also supports decision makers in designing population-wide interventions such as those raising awareness of factors related to CVD, such as smoking, healthy eating or a healthy lifestyle. Knowledge of dietary factors, for example, can lead to transformational influence on diet and other lifestyle behaviours that can have a direct impact on these diseases in the society. For interventions to take effect it is important to make the interventions people-centric. Thus, the following measure should be promoted:

Bangalore will benefit from evidence-based programs that address the risk factors for CVD. A multi-stake holder approach must be implemented to advocate effective prevention policies to improve population health and tackle inequalities linked to CVD. Additionally, the city would benefit for a revised approach to data collection which would enable future research to provide more accurate advice by including, for example, a breakdown of age groups in the mortality data. Further research could seek to conduct a similar research in other countries with different socio-economic backgrounds, looking for relevant data sets which could allow for more detailed analyses, e.g. by determining age-adjusted rates of death, or estimating losses to households due to CVD.

## ACKNOWLEDGEMENTS

The authors wish to thank the BBMP for providing the data used for the purposes of this research.

## REFERENCES

- Abegunde, D. and Stanciole, A. (2006) An Estimation of the Economic Impact of Chronic Noncommunicable Diseases in Selected Countries: World Health Organization, Department of Chronic Diseases and Health Promotion (CHP)
- Ajay, V. S. and Prabhakaran, D. (2010) 'Coronary Heart Disease in Indians: Implications of the INTERHEART Study'. *Indian Journal of Medical Research* 132 (5), 561-566
- Aranya R. (2003) Globalisation and Urban Restructuring of Bangalore, India: Growth of the IT Industry, its spatial dynamics and local planning responses. 39th ISOCARP Congress; India
- Beaglehole, R. and Bonita, R. (2008) 'Global Public Health: A Scorecard'. *Lancet* 372, 1988-1996
- Bloom, D.E., Cafiero, E.T., Jané-Llopis, E., Abrahams-Gessel, S., Bloom, L.R., Fathima, S., Feigl, A.B., Gaziano, T., Mowafi, M., Pandya, A., Prettner, K., Rosenberg, L., Seligman, B., Stein, A.Z., and Weinstein, C. (2011). *The Global Economic Burden of Noncommunicable Diseases*. Geneva: World Economic Forum.

- Chauhan, S. and Aeri, B., T. (2013) 'Prevalence of Cardiovascular Disease in India and its Economic Impact- A Review'. *International Journal of Scientific and Research Publications* 3 (10)
- Chinnaswamy, A.K., Balisane, H., Nguyen, Q.T., Naguib, R.N.G., Trodd, N., Marshall, I.M., Yaacob, N., Santos, G.N., Vallar, E.A., Galvez, M.C., Shaker, M.H., Wickramasinghe, N., and Ton, T.N. (2015) Data Quality Issues in the GIS Modelling of Air Pollution and Cardiovascular Mortality in Bangalore. *International Journal of Information Quality* 4(1):64-81
- Gardner, J., W., and Sanborn, J., S. (1990) 'Years of Potential Life Lost (YPLL)--what does it Measure?'. *Epidemiology* 1 (4), 322-329
- Gaziano, T., Reddy, K., S., and Paccaud, F., et al. (2006) Cardiovascular Disease. in: Jamison DT, Breman JG, Measham AR, et al, Eds. *Disease Control Priorities in developing world*. . Oxford: Oxford University Press
- Ghaffar, A., Reddy, K. S., and Singhi, M. (2004) 'Burden of Non-Communicable Diseases in South Asia.' *Bmj* 328, 807-810
- Global Status Report (2014) Global status report on noncommunicable diseases WHO, 2014.
- Goenka, S., Prabhakaran, D., Ajay, V. S., and Reddy, K., S. (2009) 'Preventing Cardiovascular Disease in India - Translating Evidence to Action.' *Current Science* 97 (3), 367-377
- Gupta, R., Gupta, S., Joshi, R., and Xavier, D. (2011) 'Translating Evidence into Policy for Cardiovascular Disease Control in India'. *BioMed Central* 9 (8)
- HealthTalk (2014) 'Coping emotions after heart attack' [online] available from <<http://www.healthtalk.org/peoples-experiences/heart-disease/heart-attack/coping-emotions-after-heart-attack#ixzz4kvagTFKT>> [Dec 14 2014]
- ICFN (2013) Bangalore 'The Fastest Growing City' in India. [online] available from <<http://www.icfn.in/blog/bangalore-the-fastest-growing-city-in-india/>> [Jan 04 2015]
- Menzin, J., Marton, J. P., Menzin, J. A., Willke, R. J., Woodward, R. M., and Federico, V. (2012) 'Lost Productivity due to Premature Mortality in Developed and Emerging Countries: An Application to Smoking Cessation'. *BMC Medical Research Methodology* 12 (1), 87
- MOHFW (2005) National Health Accounts India. New Delhi: National Health Accounts Cell, Ministry of Health and Family Welfare, Government of India;
- Murray, C., J., L. and Lopez, A., D. (1996) *The Global Burden of Disease: A Comprehensive Assessment of Mortality and Disability from Diseases, Injuries, and Risk Factors in 1990 and Projected to 2020*. Geneva, Switzerland: Published by the Harvard School of Public Health on behalf of the World Health Organization and the World Bank
- National Center for Injury Prevention and Control. (2003). PVLE [online] available from <<http://www.cdc.gov/injury/index.html>> [June 11 2012]
- NSSO (2006) Morbidity, Health Care and Condition of the Aged. New Delhi: Ministry of Statistics and Program Implementation, Government of India. Contract No.: Report No 507 (60/25.0/1).
- Prabhakaran, D., Jeemon, P. and Roy, A. (2016) 'Cardiovascular Diseases in India'. *Circulation* 133 (16), 1605-1620
- Ramaraj, R., and Chellappa, P. (2008) 'Cardiovascular Risk in South Asians'. *Postgrad Medical Journal* 84, 518-523
- The Hindu (2013) India is set to become the youngest country by 2020. [online] available from <<http://www.thehindu.com/news/national/india-is-set-to-become-the-youngest-country-by-2020/article4624347.ece>> [February 3 2015]
- Turner, S. (2002) 'Defining and Measuring Traffic Data Quality: White Paper'. Prepared for Federal Highway Administration: Washington D.C.
- Vamadevan, A., S., Shah, B., R., Califf, R., M., and Prabhakaran, D. (2011) 'Cardiovascular Research in India: A Perspective.'. *American Heart Journal* 161, 431-438
- WHO (2005) Preventing chronic diseases: a vital investment. [online] available from <[http://www.who.int/chp/chronic\\_disease\\_report/contents/en/index.html](http://www.who.int/chp/chronic_disease_report/contents/en/index.html)> [July 11 2012].
- WHO (2009) Cardiovascular Diseases. [online] available from <[http://www.who.int/cardiovascular\\_diseases/priorities/en/index.html](http://www.who.int/cardiovascular_diseases/priorities/en/index.html)> [July 11 2012].
- WHO (2011) Cardiovascular Diseases [online] available from <[http://www.wpro.who.int/mediacentre/factsheets/cardiovascular\\_disease/en/](http://www.wpro.who.int/mediacentre/factsheets/cardiovascular_disease/en/)> [May 14 2013]
- WHO (2013) Noncommunicable diseases [online] available from <[http://www.wpro.who.int/mediacentre/factsheets/fs\\_20120926e/en/](http://www.wpro.who.int/mediacentre/factsheets/fs_20120926e/en/)> [Dec 13 2015]
- WHO (2014) Global status report on noncommunicable diseases 2014 [online] available from <<http://www.who.int/nmh/publications/ncd-status-report-2014/en/>> [Dec 13 2015]
- Yin, R. K. (2009) 'Case study research; design and methods', London, Sage Publications.

## CROWD-FOODING. THE ROLE OF CROWDFUNDING PLATFORMS IN THE FOOD INDUSTRIES OPEN INNOVATION

Cillo, Valentina<sup>1</sup>; Cardinali, Silvio<sup>2</sup>; Dell'Anno, Davide<sup>3</sup>; Bertoldi, Bernardo<sup>4</sup>

<sup>1</sup>Link Campus University, Italy

<sup>2</sup>Università Politecnica delle Marche, Italy

<sup>3</sup>Università degli Studi della Campania "Luigi Vanvitelli", Italy

<sup>4</sup>Università di Torino, Italy

### ABSTRACT

*The goal of this paper to analyze the effects of crowdfunding on the open innovation capabilities of the agri-food business. The research is based on a survey methodology, which is useful to enhance the generalization of results (Dooley, 2001).*

*The paper builds on the theoretical framework and the consequent conceptual model to conduct the empirical research, which follows two main steps. First, the literature review led us to develop the questionnaire and therefore the variables of our model. Second, we have tested the model and the hypotheses through hierarchical regression model, which was considered a suitable method in innovation management studies.*

*Keywords: open innovation, crowdfunding, access to new knowledge, agri-food business*

### INTRODUCTION

Open innovation is becoming increasingly important in the food sector. According to Sarkar and Costa (2008), there is rapid growth in the number of open innovation projects.

Around the world, consumers are increasingly opting for specialized diets that address their desire to eat organic, low-fat, low-carb, or eliminate ingredients based on food sensitivities, allergies or personal convictions. Approximately two-thirds of the respondents (64%) in Nielsen's new Global Health and Ingredient-Sentiment Survey said they follow a diet that limits or prohibits consumption of at least some foods or ingredients (Nielsen Research, 2016). Moreover, a majority of European consumers are believers in positive nutrition, with 56% using food/drink to improve health (Vitafoods Europe, Datamonitor Consumer Survey, 2016).

In order to address these challenges, the Italian agri-food business have to increase their innovative capacity by creating new products and services, commanding a premium (OECD,2013)

As Michael Porter states (2007), the actual models of competitiveness rely on radical innovations and home based factor endowments in achieving competitive

advantages. As presented by Carayannis and Wang (2009), there are two types of competitiveness: resource-led and innovation-led competitiveness. The resource-led competitiveness model states that higher productivity results from through lower cost of natural resources or lower costs of an unskilled labor force. On the other hand, the innovation-led competitiveness model emphasizes that a higher productivity is achieved through a higher efficiency and this is based on knowledge and innovation. This means that the fast development of technologies and the rapidly changing markets, combined with increased global competition (also due to relieve of EU's protection measures) and changing customer demands, imply that a firm's focus on production capacity and cost reduction can only generate a temporary competitive advantage. In this scenario, Knowledge management (KM) has already been recognized as a key managerial process necessary for achieving competitive advantage (Carayannis, 1999; Argote and Ingram, 2000; Dias and Bresciani, 2006). Specifically, it assumes that tangible resources are sources of competitive advantages only when they are applied with certain knowledge (Grant, 1996), consequent to the difficulty of imitating knowledge (literature (Nonaka, 1994; Spender, 1994; Nonaka and Takeuchi, 1995; Alavi and Leidner, 2001; Soto-Acosta and Merono-Cerdan, 2008; Bresciani, 2010).

Despite of this, innovation is becoming increasingly complex and expensive making difficult for individual businesses to develop and introduce new products and processes independently. Innovation has become an unavoidable interplay of various parties who combine their knowledge and turn problems into design requirements. This is the reason why the concept of open innovation introduced by Chesborough (2003) has thus become a key concept. This term characterises the shift to a system in which chain partners, knowledge institutions, governmental bodies and even competitors work together to develop new products and processes quickly and effectively.

In order to assess these challenges, this study would analyze agri-food business typically described as a relatively mature and slow-growing area of business. Small agri-food business displays a relatively low level of R&D investment and are quite conservative in the type of innovations they introduce to the market(Costa & Jongen, 2006). Moreover they shows much lower innovation-absorption capabilities than their larger counterparts and a lack of effective technology transfer and flexible IP-

management rules (OECD, 2015; FAO,2015). Due to the lower innovation-absorption capabilities and to the limited resources for in-house R&D, agri-food business must maintain a broad network of partners to provide them with scientific and technological input (Knudsen, 2007). In the current dynamic environment, firms increasingly have to heighten internal Knowledge Management Capacity (KMC) in order to manage inward and outward flows of knowledge exploiting and exploring external opportunities (Santoro, Vrontis, Thrassou, Dezi,2017).

IT applications could allow firms in conveying relevant information useful to reconfigure innovative mechanisms (Del Giudice and Della Peruta, 2016). In particular, Web 2.0 technologies are empowering firms to outsource their internal business tasks and activities to individuals, or the crowd, on the Internet who are capable of completing these business tasks. The crowd can also invest in business ideas and projects that are initiated by entrepreneurs in the crowd who do not have the traditional monetary resources, such as banks and investment agencies, to implement their ideas. These entrepreneurs can pledge for financial resources from the crowd in various open social communities. This emerging approach of raising money via the Internet is called crowdfunding. Massolution reported that the volume of crowdfunding grew 81% from 2011 and reached \$2.7 billion in 2012. In addition, the reward-based type of crowdfunding [3,4] was expected to reach \$1.4 billion in 2013.

As a result, we propose that open innovation is directly associated with innovation capacity, and that crowdfunding positively affects the relationship between open innovation and Innovative capacity.

The paper is structured as follows. First, we review extant literature on the application of the open innovation and Knowledge management concepts in the food industry. Next, we analyze the impact of the crowdfunding on open innovation. Finally, we summarise the conclusions of our analysis, draw implications for the future of open innovation in the food sector and highlight areas where more empirical research is needed

## **THEORETICAL BACKGROUND AND HYPOTHESES**

### *Open innovation in the agri-food business*

Recent important changes in the nature of both food demand and supply, coupled with an ever-increasing level of competitiveness, have rendered innovation not only an unavoidable corporate activity, but also one that is increasingly vital for overall agribusiness profitability.

Recent general advances in areas like biotechnology, nanotechnology and preservation technology offer an unprecedented number of opportunities for

added-value applications in the food industry, many of which have the potential to adequately meet modern consumer demand (Juriaanse, 2006).

Such perceived wariness, together with the necessary stringency of legal requirements related to safety, transforms food product and process innovation in a highly complex, time-consuming and risky endeavour, and hence one not to be lightly undertaken.

Many of the emerging technologies that can potentially sustain (or complement) a wave of successful new food applications (e.g. nanotechnology) are being developed outside the processing industry. The pressure on these organizations forces them to continuously adapt to the environmental shifts (Greenwood & Hinings, 1996) and to create organizational forms able to provide faster and innovative response to market threats and opportunities (Coleman, 2009).

On another hand, drivers of opening up in food industry are closely related to the growing number of chain actors, the contradictory requirements of chain actors, the heterogeneous needs/new trends in consumers' demand, the Mass customization market and to the Legislators (Sarkar, Costa, 2008; Bilgiliardi, Galati, 2013).

The market issues and the number of actors of different sectors involved in food production, together with their difficulty to single-handedly meet all the heterogeneous requirements of intermediate customers, end-users and legislators, determine that innovation activities must be carefully coordinated. This in turn compels innovation processes to be managed both within and across organizational boundaries along the value chain (Costa & Jongen, 2006; Grunert et al., 2005; Mikkelsen et al., 2005).

Cooperating with others on the development and commercialization of new products and technologies is an important way to innovate. This is one of the several ways to start 'open innovation' (Chesbrough et al., 2006). Open innovation can be defined as the combination of internal and external paths for both the development and commercialization of new technologies and products (Chesbrough et al., 2006). Open innovation (OI) could involve outside-in and inside-out flows of technologies and ideas (defined as 'technology acquisition' and 'technology exploitation') (Lichtenthaler, 2008).

The establishment and management of inter-organizational relationships with customers, competitors, suppliers, public and private research institutions or even seemingly unrelated businesses, with the aim of acquiring additional knowledge and skills for innovation processes are increasingly growing (Gatignon, Tushman, Sith, & Anderson, 2002; Hauser, Tellis, & Griffin, 2006; OECD & Eurostat, 2005). Amongst the highest profile adopters of OI is Procter & Gamble (P&G), with former CEO, AG Lafley, inspiring a culture change from “not invented here” to “proudly invented elsewhere”. P&G’s Connect & Develop (C&D) programme has been highly successful, producing more than 35% of the company’s innovations, including Pringle Prints, and billions of dollars of revenue.

Another example of the application of OI in the food sector is International Flavors and Fragrances. IFF taps into the creative potential of its customers when conceptualising and designing products. Using an internet toolkit with a large database of flavours, the company involves the customer when creating a new flavour. Co-creation allows it to increase its ability to meet individual customer expectations and to reduce time-to-market.

Despite of this, Open innovation (OI) approach works well for the high-tech industry but it doesn’t well perform for the low-tech industries. Moreover, given the high number of actors of different areas involved in Italian food supply as well as their difficulties to single-handedly meet all the heterogeneous requirements of intermediate customers, end-users and legislators (Costa & Jongen, 2006; Grunert et al., 2005; Mikkelsen, Kristensen, & Nielsen, 2005), cross-boundary innovation management should thus be a widespread practice in food value chains and networks.

Consequently, the goal of this study is to analyze open innovation capabilities in small and medium agri-food business, focusing on the role of readiness to collaborate, partner intensity (Ahn et al., 2016) and openness variety capabilities (Laursen and Salter, 2006; Aloini et al., 2015).

As Mortara (2007) argued, agri-food sector recognises the potential power of OI: the ‘outperformers’ in the food industry use external sources of innovation. From this perspective, OI could improve successful approach to achieving sustained high growth and containing innovation costs.

By cooperating in networks, firms have better access to new knowledge enhancing the innovative potential of an organization. Moreover, by cooperating with different partners along the value chain, firms are able to cover a larger part of the value chain. This can lead to increased added value for customers by offering a total solution. At the same time, by combining (financial) resources in which cost and risk reduction play a crucial role, new knowledge can be developed which was impossible for each member to obtain alone. Open innovation will lead to added value for participating firms (De Rochemont et al., 2007).

The next section will explore the role of knowledge management as a key to open innovation.

*Knowledge management: key to open innovation*

The trend towards open innovation requests an integrative perspective and calls into question traditional perspectives on firm boundaries (Chesbrough, 2006; Santos and Eisenhardt, 2005; West, 2008) considering knowledge exploration, retention, and exploitation inside and outside organizational boundaries. These dynamics describe 'knowledge capacities' as a firm's capabilities of managing different knowledge processes.

Quantitative empirical studies on external knowledge sourcing provide evidence that involving a large number of external sources of knowledge in innovation is a promising choice for large firms (Lakhani et al. 2006; Laursen and Salter 2006). Open innovation scholars also agree that external sourcing of knowledge does not replace in-house R&D and highlight the importance of "absorptive capacity," which allows firms to identify, absorb, and make use of external knowledge (Cohen and Levinthal 1990; Dahlander and Gann 2010).

According to the Community Innovation Surveys (OECD, 2016) conducted on more than 1300 European innovative food firms, since most food firms don't have the competencies nor the capital needed to innovate on their own, they need to find partners to join forces in open innovation collaborations. However, Small and Medium Sized Enterprises (SMEs) in the food sector often face difficulties in establishing a strategic and efficient network.

Agri-food companies are as innovative as companies in other industrial sectors, but the innovations developed are largely incremental (about 2/3 of innovations). Between 2006 and 2008, 44% of companies implemented a product or process innovation. If we broaden the measure of innovation to take account of intangible innovation (organisation, marketing), 61% of agro-food companies report that they innovated between 2006 and 2008 (Lesieur, 2011). Organisational innovations are, incidentally, the most used category of innovation because 36% of agro-food companies implement them, regardless of size. The proportion of companies who innovate decreases for the other kinds of innovation (32% for marketing or process, 28% for products).

Following these evolutionary analyses, a large number of works have been concerned with the role of the diverse relationships and cooperation developed by firms with other stakeholders to "absorb" (Cohen, Levinthal, 1989; 1990) external knowledge. The idea of these authors is that the capacity of a firm to exploit external knowledge is a critical determinant of its capacity for innovation: a firm will be more or less able to exploit the technological opportunities of its environment depending on its knowledge-base and the learning process that occurs within this.

The survival of a brand in this kind of market depends on its capacity to distinguish itself from its competitors, this capacity being reflected in particular in a strategy of innovation in products and processes (Martin et al., 2006 a). In particular, companies with fewer than 50 employees, and



particularly those with fewer than 20 employees, favour changes in their organisation and marketing innovations slightly more than technological innovations. With few resources to develop innovations (R&D staff but more generally human and financial resources), these SMEs innovate in an incremental way by continuously improving their organisation, their products and processes.

To capture internal and external knowledge exploration, retention, and exploitation, six knowledge capacities are needed (Argote et al., 2003; Lane et al., 2006): inventive, absorptive, transformative, connective, innovative, and desorptive capacity.

	Knowledge exploration	Knowledge retention	Knowledge exploitation
Internal (Intrafirm)	Inventive capacity	Transformative capacity	Innovative capacity
External (Interfirm)	Absorptive capacity	Connective capacity	Desorptive capacity

Fig. n 1 Capability-based view of open innovation processes (Chesbrough, 2003, Argote et al., 2003; Zollo and Winter, 2002)

When adopting an open innovation approach, firms tend to build up collaborations with actors of their ecosystem, which generate vibrant inward and outward flows of knowledge (Chesbrough, 2006). The role of absorptive capacity in agri-food business is critical to compensate for lower internal research capabilities (Carpenter et al., 2003; Dyer et al., 2004; Huston and Sakkab, 2006).

While inventive capacity refers to internally exploring new knowledge, absorptive capacity relates to exploring external knowledge. Based on Cohen and Levinthal's (1990) original definition of recognizing, assimilating, and applying external knowledge, Zahra and George (2002) differentiated between potential and realized absorptive capacity. In a similar vein, Lane et al. (2006) distinguished exploratory, transformative, and exploitative learning processes. Following these reconceptualizations, absorptive capacity in the knowledge management capacity framework focuses on knowledge acquisition, i.e. potential absorptive capacity (Zahra and George, 2002) and exploratory learning (Lane et al., 2006). Because of this focus on knowledge exploration processes (Lichtenthaler, 2009), it does not guarantee successful knowledge commercialization, which is part of the knowledge exploitation processes. External knowledge sourcing may span various kinds of external innovation partners, who relate to different knowledge flows and can provide access to widely differing knowledge domains such as science, technology, design, societal trends, customer insights and product-market trends (von Hippel 1988; Sidhu, Volberda, and Commandeur 2004)

On another hand, due to the lower innovation-absorption capabilities and to the limited resources for in-house R&D, agri-food business must also maintain a broad network of partners to provide them

with scientific and technological input (Knudsen, 2007) Interorganizational relationships, e.g. alliances, may be considered as a firm's external knowledge retention (Grant and Baden-Fuller, 2004; Gulati, 1999). Similar to internal knowledge retention, external networks have to be maintained and managed over time (Kale and Singh, 2007). From this perspective, connective capacity refers to a firm's ability to retain knowledge in interfirm relationships, it comprises elements of alliance capability (Kale and Singh, 2007) and relational capability (Lorenzoni and Lipparini, 1999).

Connectivity capacity is closely related to absorptive capacity. As a matter of fact, the more knowledge a company has in a particular field, the easier it is to manage interfirm relationships and to profit from external knowledge retention. Accordingly, connective capacity comprises the process stages of maintaining knowledge in interorganizational relationships and subsequently reactivating this knowledge (Garud and Nayyar, 1994; Grant and Baden-Fuller, 2004).

To be effective, agri-food business need to improve also Innovative capacity transmuting knowledge and converting this knowledge into new products or services (Khilji et al., 2006). In order to generate innovations from internal or external knowledge and improve commercialization opportunities, a company needs sufficient prior knowledge (Kogut and Zander, 1992; Smith et al., 2005).

Despite of this, it should not be overlooked that Italy is mainly composed by SMEs and, under a family control (Maggioni & Del Giudice, 2012). For this reason, we do not have to be satisfied with some best practices, but we must act in a systematic way in Italy. Moreover, it is necessary to trigger a virtuous circle that increases the awareness of the importance, rather of the need, of investing massively on digital innovation at all levels. Because digitalism is a transversal gap, a decisive step in this direction can only begin to argue in the light of the ecosystem for firms, universities and institutions and civil society to join forces and travel united (Carayannis & Campbell, 2012).

Even if SMEs have increased their activity in open innovation, inbound open innovation is far more diffused than outbound open innovation (van de Vrande et al. 2009). Moreover, due to the resource constraints and the role of informal interorganizational relationships in innovation, SMEs prefer nonmonetary activities such as networking and informal knowledge sourcing over pecuniary and complex transaction-based ones, such as acquisitions and in-licensing.

All these factors could negatively affect absorptive capacity as well as the ability to externally exploit knowledge.

Open innovation proposed by knowledge management literature suggested that firms can and should use external as well as internal ideas, and internal and external paths to market, as they look to advance their technology (Chesbrough, 2004; p. 1). Thus, new innovation models entail new forms of interactions and collaborations for fostering new products and processes development (Wang et al.,

2015; Chebbi et al., 2015) and within varying contexts (Bresciani et al., 2013; Ferraris and Santoro, 2014).

Exploiting internal and external knowledge flows, and developing digital ecosystems through new ICTs, could be essential in bearing the acquisition and management of knowledge (Del Giudice and Straub, 2011).

Crowdfunding could represent a novel mechanism of fundraising to cope the resource constraints as well to improve formal interorganizational relationships. According to some scholars, crowdfunding is based on digital platform embedded in the current financial innovation (Moenninghoff & Wieandt, 2013), which operates in order to produce convergent innovation (Dubé et al., 2014). It means innovation that produces both economic and social (human) outcomes.

As also Loren (2011) suggested, open innovation can be implemented using crowdsourcing, or the issuance of a challenge to a group of experts and non experts found outside the organization, using an Internet-based platform. More thoroughly, Chesbrough and Appleyard identify four challenges for effectively managing open innovation processes:

- attracting participation from a broad group and sustaining it over time;
- effectively competing for contributors in a world with a limited supply;
- effectively setting the tone and expectations for the meaning of involvement on the part of users through careful leadership and agenda formation; and
- finding ways to profit from activities carried out in an open environment. (Chesbrough and Appleyard, 2007).

In the next section we will analyze the role Crowdfunding in open innovation.

#### *Crowdfunding for open innovation: hypotheses development*

The concept of “crowdfunding” is related to the one of “crowdsourcing”, which refers to the outsourcing to the “crowd” of specific tasks, such as the development, evaluation or sale of a product, by way of an open call over the internet (Howe, 2008). The type of contributions by the investor – and related rewards - may vary, depending on the internet platforms, the type of firms and the projects. Indeed, as new platforms are created across countries, in a context of low regulation, new features and business models are continuously emerging. The types of funding may range from donations to equity, thus giving rise to processes with different degrees of complexity and different contractual relationships between the firm and the individual investor (Kleeman et al. 2008).

Crowdfunding has been proved as useful tool to connect entrepreneurs, researcher and potential funders, individuals who can supply financial capital (Wheat et al., 2013; Marlett, 2015). This is

possible thanks to intermediation internet based platforms, which act as marketplace where is possible to collect and canalize the scattered unlocked private capitals to sustain business ideas, also decreasing the weight of geographical proximity in the innovation process (Agrawal et al., 2011).

Despite the advantages, adopting open innovation throughout crowdfunding platforms is a challenging process (De Jong, 2007 and Chesbrough et al., 2006). Collaborating with a number of partners is more complex because of increased coordination and control efforts (Doz and Hamel, 1998 and Das and Teng, 2002). Previous research has demonstrated that many firms do not feel comfortable in these 'open' scenarios in which the return especially depends on the partnering actors. Networks of innovating partners bring with them significant strategic and organizational challenges, about which there is little prior knowledge (Vanhaverbeke and Cloudt, 2006). Moreover, prior research shows that the failure rate of bilateral alliances is quite high, ranging from 50-75% (De Rochemont et al., 2007). Cooperating in groups with an increased number of participants raises the likelihood of conflicting interests, and consequently, could lead to a breakdown of the cooperation (Park and Russo, 1996).

For the above reasons we can hypothesized what follows:

*Hp. 1: The greater Knowledge exploitation through ICT, the Higher level of Open Innovation*

*Hp. 2: The higher level of Open Innovation, the higher the effects of Knowledge exploitation through ICT on Open Innovation*

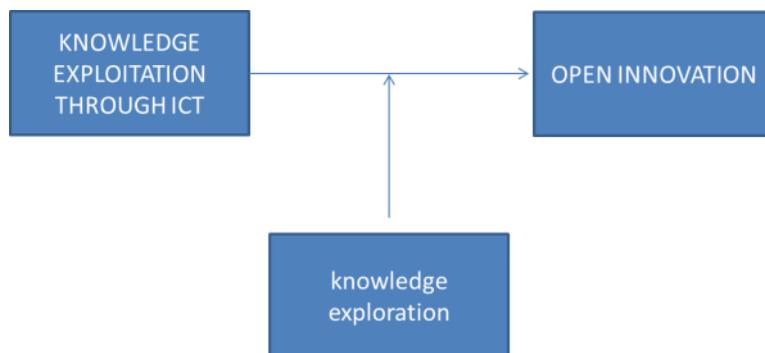

Fig 2 Conceptual Model

## METHODOLOGY

### Research sample and design

The research involves data gathered from European agri-food business involved in crowdfunding campaigns on Kickstarter and Indiegogo platforms. An email with invitation to participate in the survey along with a letter containing an explanation of the study's purpose was sent to all the firms. In total 192 firms have expressed the interest in entering the study. A questionnaire, composed of several questions (open and closed), was sent to these firms, which was answered and returned by 80 firms, which represents the final sample. The answers for all the variables and general information of the firm were gathered from the different key managers to avoid concerns regarding common method bias. Therefore, the research is based on a survey methodology, which is useful to enhance the generalization of results (Dooley, 2001).

The paper builds on the theoretical framework and the consequent conceptual model to conduct the empirical research, which follows two main steps. First, the literature review led us to develop the questionnaire and therefore the variables of our model. Second, we have tested the model and the hypotheses through regression model, which was considered a suitable method in innovation management studies. The questions were stated according to a funnelling technique. Therefore, general questions were followed to the specific one. In this way, we have collected general information about the time successful gain of the Crowdfunding campaign goals, strategies firm such as number of employees, industry, financial data, etc. Consequently, specific questions were outlined and focused mainly open innovation, knowledge exploration and knowledge exploitation. The single questions of the questionnaire have been separated in order to reduce the risk of rationalizing the answers of the respondents. Moreover, we placed dependent and independent variables in different position within the questionnaire to limit potential common method variance.

#### Variables employed

Data acquired from the questionnaire were used to develop the variables of the quantitative study. Accordingly, variables were developed using multi-item scales according to relevant literature to ensure their validity. In particular, we asked to respondent to evaluate several statements with a seven-points likert scale.

With regard to knowledge exploration as dependent variable, it measures the ability of a firm of developing new products or services, creating dialogues, learning and communities of practices, and explore knowledge externally (Edvardsson, 2008; Parida et al., 2012). To assess knowledge exploration we asked to the respondent to indicate the importance of: a) exploring external knowledge; b) developing innovative ideas and knowledge regarding products and processes; c) exploring innovative ideas and knowledge externally (Lichtenthaler and Lichtenthaler, 2009).

With regard to Open Innovation we focused on the combination of internal and external dimension (Chesbrough et al., 2006). In this regards, we asked to indicate the level of: a) Partner Intensity (Laursen and Salter, 2006; Aloini et al., 2015); b) Openness variety (Laursen and Salter, 2006; Aloini et al., 2015); c) Interaction with Experts on Intellectual Property Rights (IPR) (Bessant and Rush 1995; Hurmelinna-Laukkanen, Kyläheiko, and Jauhiainen 2007).

Finally, we employed the variable ICT knowledge exploitation according to the literature which emphasises its role for knowledge storage and sharing (Merono-Cerdan et al., 2007). In detail, we asked to evaluate the usage of collaborative technologies for knowledge sharing and the ICT adoption.

**Table 1. Variables and items**

Dimension	Items	Related literature
Open innovation	Partner Intensity	Laursen and Salter, 2006; Aloini et al., 2015
	Openness variety	Laursen and Salter, 2006; Aloini et al., 2015
	Interaction with Experts on Intellectual Property Rights (IPR)	Bessant and Rush 1995; Hurmelinna-Laukkanen, Kyläheiko, and Jauhiainen 2007
Knowledge exploration	Readiness to collaborate	Ahn et al., 2016
	Absorptive capacity	Lichtenthaler and Lichtenthaler, 2009
	Inventive capacity	Lichtenthaler and Lichtenthaler, 2009
Knowledge	Converting knowledge into new products or	(Khilji et al., 2006).

Exploitation through ICT	services	
-----------------------------	----------	--

Finally, we assessed internal consistency of each independent variable (*Cronbach's alpha Open innovation=0.841; Cronbach's alpha knowledge exploitation ICT =0.898; Cronbach's alpha Knowledge exploration=0.937*), which shows good results.

Finally, we controlled for several variables that can influence the other variables and the analyses. We controlled for the size of the firm (calculated as the number of employees of the firm) because it can be considered as a measure of greater capabilities (Dewar and Dutton, 1986). Second, the age of the firm (calculated as the number of years since founding) can detect the experience of the firm accumulated through the years (Huergo and Jaumandreu 2004). The log term of these two variables has been processed in the models.

## DISCUSSION AND CONCLUSION

Descriptive statistics show that most of the firms of the sample are small (the average number of employees is 98.90), spend internal R&D 10% in average and they are rather innovative in terms of (1) knowledge exploration (5.369), (2) knowledge retention (5.10) and (3) knowledge exploitation through ICT (5.108). This positively affect (4) open innovation performance in terms of partner intensity, openness variety e Interaction with expert on Intellectual Property Rights (5.25). Then, they have (5) a good performance in terms of time to successful gain crowdfunding campaign goals (65%).

**Table 2. Descriptive statistics**

	N	Min	Max	Mean	Standard dev.
Size	80	2	172	98.90	252.502
Age	80	3	95	25.61	24.117
R&D	80	0.00	0.480	0.100	0.126
Open innovation	80	2.50	7	5.255	1.270
ICT knowledge exploitation	80	2	7	5.108	1.173
Knowledge exploration	80	2.33	7	5.369	1.027

We tested the hypotheses using regression analysis and the results are presented in table 3. We developed three models that test the direct effect of knowledge exploitation through ICT on open innovation and the moderating effect of knowledge exploration.

In detail, in model 1 just the control variables are entered, which effect is non-significant. In model 2 the effect of ICT knowledge exploitation and Open Innovation are considered. Knowledge exploitation

through ICT is positively and significantly associated with Open Innovation (0.180;  $p < 0.05$ ). Model 3 considers the moderating effect of knowledge exploration on the relationship between ICT knowledge exploitation and Open Innovation, which is positive and significant (0.623;  $p < 0.001$ ). Finally, we can conclude that HP 1 and HP 2 are both confirmed by our analyses.

**Table 3. Results of regressions**

Variable	OPEN INNOVATION	OPEN INNOVATION	OPEN INNOVATION
	Model 1	Model 2	Model 3
logSize	-0.130 (-1.315)	-0.077 (-1.216)	-0.072 (-1.166)
logAge	-0.037 (-0.370)	0.000 (-0.005)	0.008 (0.132)
R&D	0.179 (1.958)	0.069 (1.170)	0.044 (0.768)
KNOWLEDGE EXPLOITATION THROUGH ICT (KEI)		0.180 (2.877)*	0.396 (5.904)***
KNOWLEDGE EXPLORATION (KE)		0.340 (5.459)***	0.493 (6.285)***
KEI*KE			0.623 (7.325)***
R <sup>2</sup>	0.051	0.620	0.647
Adjusted R <sup>2</sup>	0.027	0.603	0.629
F-value	2.125	37.785***	35.120***

Notes: \* $p < 0.05$ ; \*\* $p < 0.01$ ; \*\*\* $p < 0.001$

The first conclusion to be drawn from our review and analysis is that the time to successful gain Crowdfunding goals is positively related to Open Innovation.

Knowledge Exploitation through ICT measured through the capability of Converting knowledge into new products or services. From this perspective, Crowdfunding could help agri-food business to improve Innovative capacity transmuting knowledge and converting this knowledge into new products or services (Khilji et al., 2006).

Moreover, results show that open innovation takes place within the food sector, in spite of this being known as a relatively more traditional and mature industry. In particular our sample shows a good performance in openness variety (considering the number of external sources involved in the innovation process) and partner intensity (assessing the depth of the relationship between the focal firm and the extern context). At the same time, sample shows a moderate level in Interaction with expert on Intellectual Property Rights. In order to improve successful knowledge commercialization, Interaction with Experts on Intellectual Property Rights (IPR) is fundamental. To access technological knowledge, SMEs may rely on intermediate service providers. Experts on IPR can provide crucial information services that help to bridge the gap between a technological opportunity and its successful commercialization (Bessant and Rush 1995). However, the involvement of IPR experts is costly and also requires SMEs to deal with complex regulations and drawn-out patent protection



procedures. Thus, it may make it more difficult to quickly move an idea to the commercialization stage (Hurmelinna-Laukkanen, Kyläheiko, and Jauhiainen 2007). Interaction with Network Partners could address this challenge creating longterm relationships with network partners as well as joint value rather than efficient transactions. (Nooteboom et al. 2005).

The second conclusion to be drawn from our review and analysis is that Active investments by the crowd improve access to new knowledge. Entrepreneurs offer investors to become active in the initiative, next to offering rewards to them. This may provide valuable feedback to the entrepreneur on potential market demand and product characteristics that the market may prefer most. Also, the active involvement may be structured in forms discussed above under the concept of crowdsourcing. Making investors become active by giving making investors become active by giving.

We also found evidence of a good effect of the ICT knowledge exploitation on the relationship between open innovation practices and knowledge exploitation. It reflects the Innovative capacity of business and the related capability to applicate knowledge that has been explored and retained inside or outside the firm (Khilji et al., 2006; Lane et al., 2006). Therefore, we could assess that Crowdfunding positively affect innovative capacity as a firm's ability to internally exploit knowledge. Crowdfunding seems a successful approach to achieving sustained high growth and containing innovation costs. Combining financial resources in which cost and risk reduction play a crucial role, new knowledge can be developed which was impossible for each member to obtain alone. By cooperating in networks, firms have better access to new knowledge enhancing the innovative potential of an organization. By cooperating with different partners along the value chain, firms are also able to cover a larger part of the value chain. This can lead to increased added value for customers by offering a total solution

Our analysis of crowdfunding practices provides avenues for future research. One urgent question is the relation with intellectual property rights. Entrepreneurs making use of crowdfunding will need to disclose some of their ideas to the crowd well in advance, creating risks of idea stealing due to the fact that potentially valuable information is put into the public domain. In the next reserch we will also analyze which kind of business models of crowdfunded ventures and crowdfunding platforms perform better in terms Access to new knowledge by cooperating in networks. To this aim we will use classification proposed by Lambert and Schwienbacher.

Moreover, open innovation strategies come in a variety of forms and, as such, are also met with a wide variety of outcomes. Consequently, there is a clear need for a better understanding of open innovation in the food sector, which should be addressed by the performance of more and more focused case-studies and empirical research.

Another interesting question concerns the informational content for entrepreneurs for obtaining the crowd committing capital. To which extent this affect the precision about potential demand that the entrepreneurs may receive for his product as well as which remuneration scheme for the crowd generates the most information about potential demand.

## REFERENCES

- Agarwal, R., Audretsch, D., & Sarkar, M. B. (2010). Knowledge spillovers and strategic entrepreneurship. *Strategic Entrepreneurship Journal*, 4(4), 271-283.
- Alavi, M., & Leidner, D. E. (2001). Review: Knowledge management and knowledge management systems: Conceptual foundations and research issues. *MIS quarterly*, 107-136.
- Andries, P., & Czarnitzki, D. (2014). Small firm innovation performance and employee involvement. *Small Business Economics*, 43(1), 21-38.
- Argote, L., & Ingram, P. (2000). Knowledge transfer: A basis for competitive advantage in firms. *Organizational behavior and human decision processes*, 82(1), 150-169.
- Avermaete, T., Viaene, J. and Morgan, E. J. (2002). "Impact of knowledge on innovation in small food firms," *Communications in Applied Biological Sciences*, vol. 67, no. 4, pp. 46-50
- Bader, K., & Enkel, E. (2014). Understanding a firm's choice for openness: strategy as determinant. *International Journal of Technology Management* 23, 66(2-3), 156-182.
- Barney, J. (1991). Firm resources and sustained competitive advantage. *Journal of management*, 17(1), 99-120.
- Bettis, R. A., & Hitt, M. A. (1995). The new competitive landscape. *Strategic management journal*, 16(S1), 7-19.
- Burtch, G., Ghose, A., Wattal, S., (2011). "An empirical examination of the antecedents and consequences of investment patterns in crowd-funded markets", *SSRN Electronic Journal*
- Busenitz, L., Fiet, J., Moesel, D., (2005). "Signaling in venture capitalist—new venture team funding decisions: does it indicate long-term venture outcomes?", *Entrepreneurship Theory and Practice* 29, 1–12
- Chen, Y., Vanhaverbeke, W., & Du, J. (2015). The interaction between internal R&D and different types of external knowledge sourcing: an empirical study of Chinese innovative firms. *R&D Management*.
- Cheng, C. C., & Shiu, E. C. (2015). The inconvenient truth of the relationship between open innovation activities and innovation performance. *Management Decision*, 53(3), 625-647.
- Chesbrough, H. (2003) *Open Innovation: The New Imperative for Creating and Profiting from Technology* (Boston: Harvard Business School Press).
- Chesbrough, H. (2004). Managing open innovation. *Research-Technology Management*, 47(1), 23-26.
- Chesbrough, H. W. (2006). *Open innovation: The new imperative for creating and profiting from technology*. Harvard Business Press.
- Cohen, W. M., & Levinthal, D. A. (1990). Absorptive capacity: A new perspective on learning and innovation. *Administrative science quarterly*, 128-152.
- Cohen, W. M., Levinthal, D. A. (1990). "Absorptive Capacity: A New Perspective on Learning and Innovation", *Administrative Science Quarterly*, Vol. 35, No. 1, Special Issue: Technology, Organizations, and Innovation. (Mar., 1990), pp. 128-152
- Cooper, R., (1994). "Determinants of timeliness in product development", *Journal of Product Innovation Management* 11, 381–396
- Dahlander, L., & Gann, D. M. (2010). How open is innovation?. *Research policy*, 39(6), 699-709.
- Darroch, J., & McNaughton, R. (2002). Examining the link between knowledge management practices and types of innovation. *Journal of intellectual capital*, 3(3), 210-222.
- Del Giudice, M., & Maggioni, V. (2014). Managerial practices and operative directions of knowledge management within inter-firm networks: a global view. *Journal of Knowledge Management*, 18(5), 841-846.
- Del Giudice, M., Carayannis, E. G., & Maggioni, V. (2016). Global knowledge intensive enterprises and international technology transfer: emerging perspectives from a quadruple helix environment. *The Journal of Technology Transfer*, 2(42), 229-235.
- Dell'Anno, D., Del Giudice, M. (2015). "Absorptive and desorptive capacity of actors within university-industry relations: does technology transfer matter?", *Journal of Innovation and Entrepreneurship* 4 (1), 13

- Du Chatenier, E., Biemans, H. J. A., Verstegen, J. A. A. M., & Mulder, M. (2007, June). Collaborative knowledge creation in open innovation teams. In Eighth International Conference on HRD Research and Practice Across Europe (pp. 27-29).
- Franke, N., Shah, S., (2003). "How communities support innovative activities: an exploration of assistance and sharing among end-users", *Research Policy* 32, 157-178
- Galizzi, G. and Venturini, L. (1996). *Economics of innovation: the case of food industry*, Physica-Verlag
- Ghosh, D., Das, S., Baghchi, D. and Smarta R. B. (2012). *Innovation in healthy and functional foods*, CRC Press Llc
- Gompers, P., Lerner, J., (2004). *The Venture Capital Cycle*, MIT Press
- Hansen, M.T., Nohria, N. and Tierney, T. (1999), "What's your strategy for managing knowledge?", *Harvard Business Review*, Vol. 77 No. 2, pp. 106-16.
- Harison, E., & Koski, H. (2010). Applying open innovation in business strategies: Evidence from Finnish software firms. *Research Policy*, 39(3), 351-359.
- Hartog, D. N., & Verburg, R. M. (2004). High performance work systems, organisational culture and firm effectiveness. *Human Resource Management Journal*, 14(1), 55-78.
- Heisig, P. (2009). Harmonisation of knowledge management-comparing 160 KM frameworks around the globe. *Journal of knowledge management*, 13(4), 4-31.
- Henri Inkinen, (2016) "Review of empirical research on knowledge management practices and firm performance", *Journal of Knowledge Management*, Vol. 20 Issue: 2, pp.230-257, <https://doi.org/10.1108/JKM-09-2015-0336>
- Ichniowski, C., Shaw, K., & Prennushi, G. (1997). The effects of human resource management practices on productivity: A study of steel finishing lines. *The American Economic Review*, 291-313.
- Jongen, W. (2005). *Innovation in agri-food systems: product quality and consumer acceptance*, Wageningen Academic Pub
- Kamhawi, E. M. (2012). Knowledge management fishbone: a standard framework of organizational enablers. *Journal of Knowledge Management*, 16(5), 808-828.
- Karabell, Z., (2013). "The kickstarter economy: how technology turns us all into bankers", *Atlantic Monthly*
- Lagnevik, M. (2003). *The dynamics of innovation clusters: a study of the food industry*, Edward Elgar Publishing
- Lang, T., Barling, D. and Caraher, M. (2009). *Food policy: integrating health, environment and society*, Oxford: Oxford University Press
- Lazear, E. P. (1996). Performance pay and productivity (No. w5672). National bureau of economic research.
- Liao, Y. S. (2011). The effect of human resource management control systems on the relationship between knowledge management strategy and firm performance. *International Journal of Manpower*, 32(5/6), 494-511.
- Lopez-Nicolas, C., & Soto-Acosta, P. (2010). Analyzing ICT adoption and use effects on knowledge creation: An empirical investigation in SMEs. *International Journal of Information Management*, 30(6), 521-528.
- Lubatkin, M. H., Simsek, Z., Ling, Y., & Veiga, J. F. (2006). Ambidexterity and performance in small-to medium-sized firms: The pivotal role of top management team behavioral integration. *Journal of management*, 32(5), 646-672.
- March, J. G. (1991). Exploration and exploitation in organizational learning. *Organization science*, 2(1), 71-87.
- Merono-Cerdan, A. L., Soto-Acosta, P., & López-Nicolás, C. (2007). Analyzing collaborative technologies' effect on performance through intranet use orientations. *Journal of Enterprise Information Management*, 21(1), 39-51.
- Morgan, K.J. and Sonnino, R. (2008). *The School Food Revolution: Public Food and the Challenge of Sustainable Development*. London: Earthscan
- Naqshbandi, M. M., & Naqshbandi, M. M. (2016). Managerial ties and open innovation: examining the role of absorptive capacity. *Management Decision*, 54(9), 2256-2276.
- Nonaka, I. (1994). A dynamic theory of organizational knowledge creation. *Organization science*, 5(1), 14-37.
- Palacios-Marqués, D., Soto-Acosta, P., & Merigó, J. M. (2015). Analyzing the effects of technological, organizational and competition factors on Web knowledge exchange in SMEs. *Telematics and Informatics*, 32(1), 23-32.
- Pascucci, F., Cardinali, S., Gigliarano, C., Gregori, G.L. (2017). "Internet adoption and usage: evidence from Italian micro enterprises", *International Journal Of Entrepreneurship And Small Business*
- Petroni, G., Venturini, K., & Verbano, C. (2012). Open innovation and new issues in R&D organization and personnel management. *The International Journal of Human Resource Management*, 23(1), 147-173.
- Petruzzelli, A. M. (2014). Balancing knowledge exploration and exploitation within and across technological and geographical domains. *Knowledge Management Research & Practice*, 12(2), 123-132.

- Pisano, P., Pironti, M., Bertoldi, B. (2009). "A Relationship Between Propensity to Innovation and Risk Capital. An Empirical Analysis", Proceedings of the 5th European Conference on IS Management, Leadership and Governance: ECMLG2009
- Poetz, M., Schreier, M., (2012). "The value of crowdsourcing: can users really compete with professionals in generating new product ideas?", *Journal of Product Innovation Management* 29
- Ribeiro, C. (2010). *Innovation in Food Engineering*, London: Taylor & Francis
- Santoro, G., Vrontis, D., Thrassou, A., & Dezi, L. (2017). The Internet of Things: Building a knowledge management system for open innovation and knowledge management capacity. *Technological Forecasting and Social Change*.
- Scott, G., & Chaston, I. (2013). Open innovation in an emerging economy. *Management Research Review*, 36(10), 1024-1036.
- Scuotto, V., Santoro, G., Bresciani, S., Del Giudice, M., "Shifting Intra and Inter Organizational Innovation Processes toward Digital Business. An empirical analysis on SMEs", *Creativity and Innovation Management*. DOI: 10.1111/caim.12221
- Soto-Acosta, P. & Cegarra-Navarro, J. G. (2016). New ICTs for knowledge management in organizations. *Journal of Knowledge Management*, 20(3), 417-422.
- Soto-Acosta, P., Popa, S., & Palacios-Marqués, D. (2016). Social web knowledge sharing and innovation performance in knowledge-intensive manufacturing SMEs. *The Journal of Technology Transfer*, 1-16.
- Spender, J. C. (1996). Making knowledge the basis of a dynamic theory of the firm. *Strategic management journal*, 17(S2), 45-62.
- Teece, D. J. (2007). Explicating dynamic capabilities: the nature and microfoundations of (sustainable) enterprise performance. *Strategic management journal*, 28(13), 1319-1350.
- Traill, W. B. and Pitts, E. (1998). *Competitiveness Food Industry*, Blackie Academic & Professional
- Tsui, A. S., Pearce, J. L., Porter, L. W., & Tripoli, A. M. (1997). Alternative approaches to the employee-organization relationship: Does investment in employees pay off? *Academy of Management journal*, 40(5), 1089-1121.
- Vrontis, D., Thrassou, A., Santoro, G., & Papa, A. (2016). Ambidexterity, external knowledge and performance in knowledge-intensive firms. *The Journal of Technology Transfer*, 1-15.
- West, J., & Bogers, M. (2014). Leveraging external sources of innovation: a review of research on open innovation. *Journal of Product Innovation Management*, 31(4), 814-831.
- West, J., & Lakhani, K. R. (2008). Getting clear about communities in open innovation. *Industry and Innovation*, 15(2), 223-231.
- Zahra, S., (1991). "Predictors and financial outcomes of corporate entrepreneurship: an exploratory study", *Journal of Business Venturing* 6, 259

## GOVERNANCE OF NON-PROFIT INSTITUTIONS: A MANAGERIAL ISSUE?

**Civitillo, Renato**

Sannio University, Department of Law, Economics, Management and Quantitative Methods-DEMM,  
Benevento, Italy

### ABSTRACT

The nonprofit phenomenon is a topic conceptually much debated by scholars who deal with this both in Italy and in the international context. Often, the lack of profit in nonprofit organizations, together with the limited availability of financial resources, determining the crucial issues and difficult to overcome: the voluntary (or, in more general terms, the absence of profit-making) tends to give a little consideration to the use of practices and traditional management tools generally considered business reality.

Based on what mentioned above, this work is aimed at giving response to the theme of the relationship between nonprofit and its requirements of professionalization or management overhaul.

Highlighting those items might be useful for the management of nonprofit organizations: in this sense, if the critical factors just mentioned make up for these potential causes of problems, then, and on the other hand, the effective and efficient their presence would guarantee the achievement of any one or more competitive advantages, by means of their appropriate and adequate enhancement.

*Keywords: nonprofit; third-sector; management*

### THE “NONPROFIT”: WHAT IS IT?

The nonprofit phenomenon is a logical category of difficult discussion. If we omit the fundamental clarification of the necessary distinction between nonprofit and third sector, we can say that the difficulties of interpretation are found in the definition of the concept: in fact, it appears to be ambiguous, owing to the vagueness of its use in everyday language, either (and more) in view of its application to empirical reality, because of the many and varied traditionally made organizational forms, related to that term.

Consequently, it is not difficult to imagine the essentially residual use of nonprofit concept, generally deputed to indicate any form of organization in which citizens act in the public arena.

This conceptualization is also the form “healthy” nonprofit that justifies the system of protection generally provided by the different legal systems. On the opposite end of this continuum, however, we find the form that we could call “pathological”, if we refer to the group forms aimed exclusively to the enjoyment of facilitating measures (primarily tax, as well as competitive, labor disputes and other) and without, therefore, the actual social utility fees which, however, they should represent their fundamental assumptions. On this point, it really is necessary to note that there are several authors (Moro, 2014) who believe that the “deviant” forms of nonprofit don’t constitute the mere and simple distortions of the original associative phenomenon, but manifestations of the inherent characteristics of the same. This critical reflection is not insignificant, because it allows us to highlight the crucial point of the matter: the proper conceptualization of the nonprofit.

It can be seen, in fact, that it is extremely difficult to identify a universally shared definition of “nonprofit sector” although, on the other hand, several were the scientific attempts to initiate in-depth studies and specific on the subject. In this sense, an essential point of reference is the definition elaborated during extensive international survey organized, since 1990, from Johns Hopkins University and sponsored by the University of Baltimore. At the head of this project, the researchers Lester Salamon and Helmut Anheier, in 1996, in order to systematically collect information on the sector of the nonprofit organization, conducted a comparative study between thirteen countries, taking its cue from the need to ensure proper supervision of third Sector through a general reconfiguration of social and economic life that, until then, was anchored to the ideal presence of only two actors: the state and the market. In other words, a similar conceptual approach did not consider the existence of “private” organizations in the form, but having substantially purposes related to the public sphere.

From the analysis of the main reference literature, it is possible to identify certain requirements that typically can be found within the nonprofit organizations:

- The private nature;
- The prohibition of the distribution of the assets of the organization itself;
- The ability to self-government of their organizational structure;
- Voluntariness, which characterizes involving stakeholders who are part of them (Salamon, 1999).

The definition just introduced clearly shows the breadth of the boundaries within which they would contain a wide and varied range of organizations that qualify as nonprofit and differentiated according to the aims pursued and the type of activity.

This aspect highlights how the nonprofit phenomenon is characterized by several limits and criticality (Fiorentini, 1997; Barbetta, Cima & Zamaro, 2003; Bronzetti, 2007; Sargeant, 2009) that can be divided into:

- 1) definitional issues: they relate to the construction of the remaining subjects (and objects) to encompass the “nonprofit sector”. In other words, the concept has always been rebuilt in the negative, starting with the definition of what is or is not, well, what should not be.
- 2) evaluation issues: concern the absolute quantitative element prevails (financial, income, employment, etc.) in the evaluation of the nonprofit phenomenon that, too often, is abandoned to an appreciation of isolated and limited to this (single) dimension.
- 3) The “reverb” effect: the positive effect generated by certain types of activity (and thus of organizations) to all those included in the vast and heterogeneous logical container namable “nonprofit”. In short, the positive image of part of actually being part of the nonprofit is actually reverberated throughout the whole that, therefore, benefits from the gratitude and social utility products on the one hand (often limited) the whole context (Abrahamson & Baumard, 2008; Cho, Laine, Roberts & Rodrigue, 2015).

Much of the first highlighted problems resides in the difficult conceptual delimitation of the nonprofit, which fall within institutions for purposes of social, moral and cultural and whose activities range from those of a cultural, educational and recreational, to those typical scope health, environmental or social assistance to the promotion and development of civil rights, volunteers and many others (ICNPO).

Actually, we can affirm that the social objectives that distinguish this particular phenomenon are a factor which does not simplify the management of these bodies but, on the contrary, makes it even more complex and problematic: we are referring to the fact that such entities, regardless of their extreme characterization “social”, typically represent business entities, both for the features characteristic and for the operating modalities.

## **THE “NONPROFIT” SECTOR: WHY?**

The various interpretive and conceptual difficulties here shortly outlined have further place in the scientific results of researches conducted by many scholars of the nonprofit phenomenon and aimed at answering a seemingly too banal question: why does nonprofit exist?

The answers to this dilemma have always been attracted to the consideration of the typical functions exercised by nonprofit organizations and, therefore, for reasons unrelated to the necessity of a company. The Third Sector in practice exist in response to so-called “state failures” (Winston, 2007; Dolfisma, 2013; Zagrebelsky, 2014), essentially constituting an alternative to the State in the production

of public goods (Weisbrod, 1972; Phelps, 1975). On the other hand, different and opposite explanations are represented by another theory inspired by macroeconomic motives, which considers the existence of the nonprofit sector as a response to “market failures” or “profit oriented” companies: it would be the maximization of profit to generate such failures due to information asymmetries which, on the other hand, could be reduced by the reality of nonprofit distribution constraints in the nonprofit sector (Hansmann, 1980).

These theoretical interpretations, although very interesting, focus the discussion exclusively on considerations of economic and general, leaving out any type of economic-business aspect considering the “nonprofit sector”. Moreover, the use of a business approach (Bronzetti, 2007) in the Third Sector is not only crucial to the business nature of nonprofit organizations, but also represents the necessary reading key to unify different positions and apparently alternatives (such as those synthetically theoretical before mentioned). The Third Sector can in fact be seen as an element of interconnection between the Public and Private sectors: this border position is, however, materially represented by well-defined economic institutions: business organizations.

However, it should be noted that some of the business philosophy has even assumed managerial repercussions depending on the typology, the specific characteristics and the purposes of the companies: such an interpretation would seem to indicate that the “nonprofit” own features could make it negligible or even, misleading compliance management criteria such as cost effectiveness, systemic vision and decision-making autonomy. In fact, on the contrary, the characteristic of durability, of business organizations, it implies that any activity can be defined as such only if the management activities are continuously and consistently oriented to the above criteria as well as the achievement of corporate typical economic balances.

In fact, in organizations can coexist both “original” or “derivative” (or delegated) purposes: the first are in the whole category of human needs and their satisfaction, the latter are the ones that make every single corporate institution unique. The element which, however, both supports is represented by the capacity to generate value that represents the only condition capable of ensuring the existence of an organized entity qualifying as a “business organization”.

This nonprofit interpretation has not always been so deserved. On the contrary, the social aspect has always monopolized the vision of nonprofit entities that, starting from this and combining with the nonprofit purpose, has been predominantly and primarily focused on the poor (or worse, nothing) attention to proper management of a business organization. In that sense, the same “profit” to “nonprofit” distinction has led to the wrong conviction that the term “nonprofit” implies, signifies and requires the mere denial or rejection of profit or indeed the abandonment of any logic of managerial management (Cavaliere & Ferraris Franceschi, 2010).



## THE ITALIAN “NONPROFIT” SECTOR: THE “NONPROFIT” IN THE PROVINCE OF BENEVENTO

According to the latest Istat (Italian Institute of Statistics) census available at December 31, 2011, non-profit institutions in Italy are 301,191, an increase of 28% compared to the data available in 2001.

Overall, third sector organizations account for 6.4% of legal-economic units across the national territory, while non-profit accounts for 3.4% of the total number of employees. Regardless of their employment dimension, non-profit institutions are, in some sectors, the main productive reality of the country. In the figure below, the distribution of the institutions active in the Third Sector in the Italian regions is shown in percentages (*Figure 1*).

A recent statistical survey (Civitillo, 2016) attempted to illustrate the main features and criticalities of the non-profit phenomenon in the Province of Benevento through the use of a questionnaire. The questionnaire was administered to a statistically representative sample of n. 250 institutions.

The *Figure 2* highlights clearly how the figure of the President is normally present in all non-profit institutions belonging to the survey. Collegiate bodies, however, such as the Assembly of Members or the Steering Committee are still quite widespread, though not present in all the realities. The Director, on the contrary, is only present in an association, thus highlighting a particularly poor use of this managerial role.

The *Figure 3*, moreover, shows that planning and programming tools usually used in Non-profit institution analyzed in the survey are mainly made up of Annual Plan of activities, which means that these types of functions are basically set on a short-term vision (a single year).

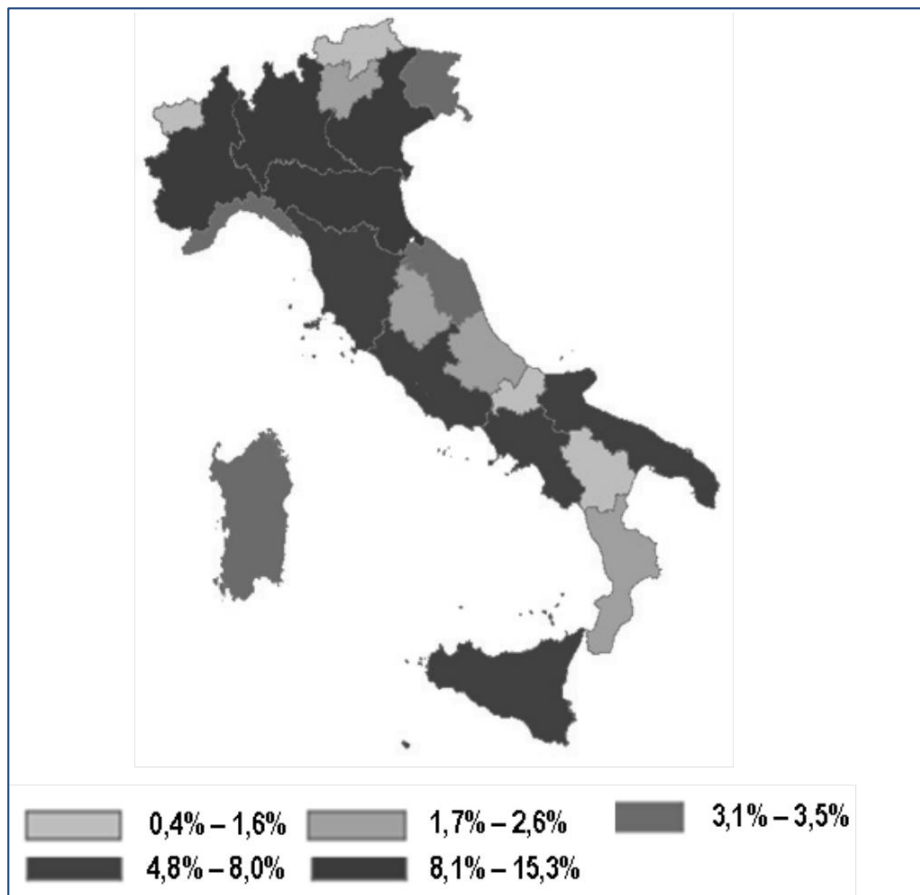

Figure 1. Italian Non-profit institutions by Region (%). Source: Istat, 2013.

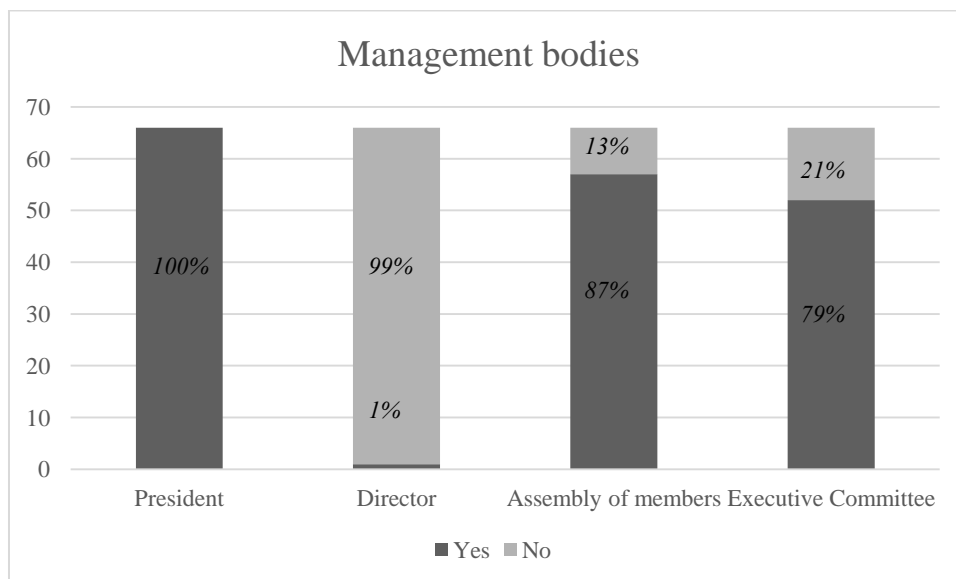
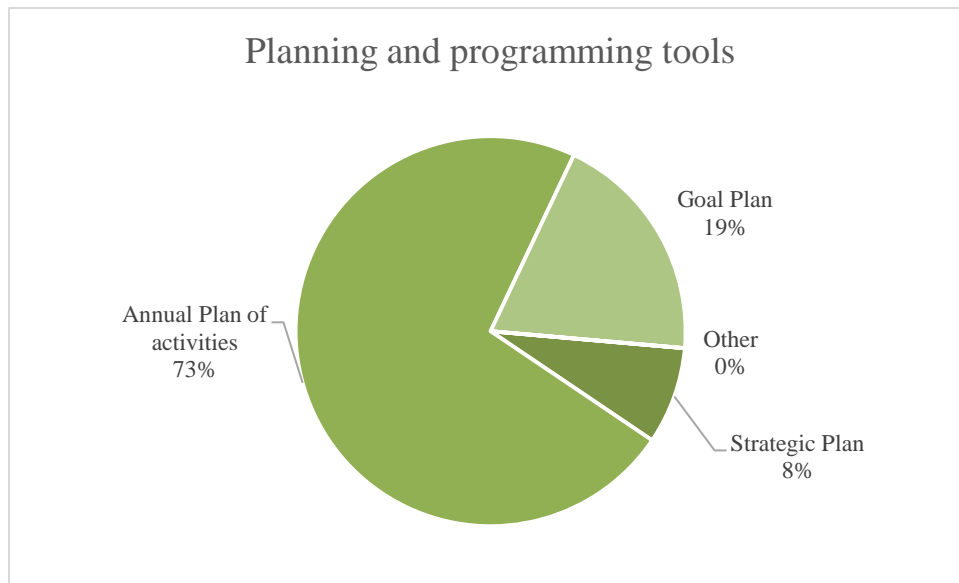

Figure 2. Management bodies in Non-profit institution in the Province of Benevento. Source: our elaboration, 2015.



**Figure3. Planning and programming tools in Non-profit institution in the Province of Benevento.**

**Source: our elaboration, 2015**

The sudden growth of the industry has given increasing attention to managerial tools and techniques for improving the management of increasingly complex and articulated organizations. This requirement was mainly met by the acquisition of typical methodologies of profit oriented companies. However, it is necessary to point out that this push to the management mentioned above has been, for the most part, limited - simplistically - to sterile attempts to import instruments, criteria and logic typical of the "profit" sector within Third Sector organizations, with the aim to meet the specific and contingent needs of each and every time considered to be remarkable. This approach undoubtedly represents one of the greatest limitations that, in our view, has contributed to hindering the efficient and effective development of the phenomenon. In fact, the failure to construct a concrete "professionalization" of non-profit - to be understood as a complete and accomplished process of "managerialisation" - has often led to stunted and improvised practices of Third Sector organizations, which are basically incapable of relying on management skills capable of ensure the necessary "professional" orientation.

## **THE "NONPROFIT" MANAGEMENT: A (POSSIBLE) GOVERNANCE MODEL (?)**

*The key factors to be considered*

The synthetic analysis outlined in the previous pages may be useful to highlight some considerations that characterize the nonprofit phenomenon and the Third Sector which, in general, have known over the last decades a huge expansion (Salamon & Anheier, 1996; Speckbacher, 2003). Such an evolution

could simply be interpreted as a response to a sharp increase in the demand for goods and services of general interest by the community, which in turn finds an explanation in the crisis of the so-called welfare state conjugated to the apparent demographic revolutions of society. Hence, as we all know, the Third Sector has seen its prevalent framing in terms of an organizational, alternative and intermediate model between the state and the market, which is responsible for ensuring the production, provision or protection of certain categories of public goods Guaranteeing the collective good of citizens (or their categories).

It is, therefore, quite obvious that such a logical approach has determined, by intimately and deeply conditioning it, the genesis of the phenomenon, as well as its subsequent evolution: all the major regulatory interventions of the Third Sector have never been animated by the necessary coordination of a discipline that has become increasingly complex and unstable by the rule stratification itself and the presence of ever-uniform approaches (Cavalieri & Ferraris Franceschi, 2010).

The traditional nonprofit conceptual approach is based on its categorization (and denomination) as an intermediate figure between the state and the market, which would result - inter alia - from the same term "Third Sector". However, this value has certainly been reduced from the consideration of the current evanescence of the ideal border between the public and private sectors, which increasingly rely on numerous elements of mutual interconnection (for example, the various forms of cooperation and public-private partnerships, which are increasingly widespread).

It is precisely on the basis of the setting outlined above that it can be seen how the "business" nature of nonprofit organizations is precisely in the need to guarantee the generation of public value through their production processes aimed at meeting individual and collective needs.

It should be noted, however, that, according to best literature (Moore, 1995; Catturi, 2003), the public value can ideally be split into two components: the proposed value and the recognized value. The first is the combination of utilities incorporated into goods and services produced and sold over a period of time, where the latter is linked to the actual capacity to respond to the demand and to meet its needs. In the context just outlined, the proposed value becomes recognized only when it is accepted, since the value attributable to an asset or service cannot be identified solely with reference to the utility it incorporates, above all, the actual demand for the asset of service by a consumer who, therefore, chooses as a means of satisfying one or more needs.

In addition, it is added that, in identifying the value created by a nonprofit organization, one cannot neglect how its action is aimed at satisfying the needs of individuals or families, as well as towards the overall and systemic needs of the community. Therefore, it becomes useful to distinguish, respectively, an individual dimension and a plurality of public value (Bozeman, 2007; Benington &

Moore, 2011; West & Davis, 2011), where the first one obviously is insufficient to achieve the overall economic viability of management (Borgonovi & Mussari, 2011).

This allows, therefore, to highlight with certainty that the reasons for the Third Sector's intervention in the socio-economic system cannot be traced back to the mere market failures or the public sector: on the contrary, nonprofit organizations would retain an autonomy, representing an alternative response to the needs of the community. In this sense, nonprofit, having experienced a phase of downsizing due to the prevalence of capitalist economy models, finds its reason for being in the need to bring the person back to the center of social and economic processes (Ricci & Stefanini, 2016), constituting a key element of the whole process of creating value for the public. In this perspective, the issue of generating value leads to the recognition that *«nonprofit is not a second best but a way to re-interpret creatively and efficiently the role of the social state. Nonprofit is an important interlocutor for the formulation of economic-social policies as a reader of needs, a response innovation factor, a subsidiary of subsidiarity and a mediator between vertical and horizontal subsidiarity»* (Benevolo & Caselli, 2011).

What is said, on the other hand, makes it possible to spell out the close bond between economy and sociality: one of the central aspects of the phenomenon of the so-called civil economy is represented by the rejection of the classic separation between "for-profit" and "non-profit" (Bruni & Zamagni, 2015). The obvious multiformity of business expressions finds in one of its clearer and broader manifestations typical of the civil economy: these are organizations that synthesize both for-profit and nonprofit entities. The result is the actual impossibility of their possible placement or for-profit, owing to the strongly social significance of their respective purposes or to the "nonprofit" institutions, since it is not a priori aprioristically excluded, Eventual distribution of wealth among the various business entities involved in the overall management activity. It is clear, therefore, that what has been said before: the traditional "nonprofit" boundaries are now considerably deteriorated and nuanced so as to involve considerable categorization problems and a correct understanding of the overall reality (Austin, 2000; Ben-Ner, 2002): nonprofit organizations highlight more and more characteristics typically belonging to the business world, while on the other hand, the various forms of volunteering are unable - as far as they have been pointed out - to overlook the vital logic of enterprise and managerialization to which the entire Third Sector must necessarily inspired (Civitillo, 2016).

In fact, the voluntary (or, in more general terms, the absence of profit-making) of typically Third Sector organizations tends to give a little consideration to the use of practices and traditional management tools generally considered business reality. The voluntary nature of nonprofit organizations is certainly a distinguishing feature and, therefore, to take into due consideration, but

*[...] if market economies are about profit, why do some organizations elect not to make profit?*  
(Anheier, 2014, p. 196).

The same concept of value has undergone a profound evolution, especially as far as the business economy is concerned. Specifically, the traditional vision focused solely on the concepts of profitability and profitability has been overcome to benefit from new paradigms which, based on the need to ensure the effective and efficient fulfillment of the needs and expectations of all business stakeholders, aim at the creation of Value in its traditional economic style, but also (and above all, in certain respects) of a social type (Molteni, 2004): *«the value creation has an economic-strategic nature and involves relationships, skills, experiences, in order to create value for use for stakeholders»* (Benevolo & Caselli, 2011).

It is clear, then, that the main problem of this work is the need for a complete rethinking of the whole framework, not just legal-normative but (and more, we might say) theoretical-conceptual (Civitillo, 2016).

The sudden growth of the sector has given increasing attention to managerial tools and techniques to improve the management of increasingly complex and articulated organizations. This requirement was fulfilled mainly through the acquisition of typical profit-oriented businesses methodologies. However, the use of nonprofit budgeting and reporting techniques poses many difficulties: poor managerial skills have led to sterile attempts to import tools, criteria and logic typical of the “profit” sector in nonprofit organizations. This approach undoubtedly represents one of the greatest limitations that in our opinion has contributed to hindering the efficient and effective development of the nonprofit phenomenon.

The analysis of critical issues and considerations on the level of professionalization of nonprofit, however, have the ability to bring out certain elements probably crucial to the closing of this research reflections.

First of all, the variety of activities provided by nonprofits represents a sure element of complication: in this perspective, the criticality of the accounting information system of any kind of organization becomes even more pronounced with regard to nonprofit companies. These have - physiologically - distinctive and distinctive features compared to the generality of companies traditionally meant: hence, the necessity of providing an information and accounting system adapted to these specific needs (Marcon & Tieghi, 2010).

Nonprofit entities are characterized by management operations that are not the subject of traditional business accounting (Civitillo, 2016). The Third Sector, for example, is characterized by the conditions for acquiring the factors of production and the sale of goods and services that may be very different from those of the capitalist markets: the acquisition of free inputs, the sale of goods and services without direct consideration, acquiring legacies and donations, and many more. Nonetheless, the need for adequate accounting systems clashes, in nonprofit organizations, with accounting systems that are

elementary and inefficient (Bandini, 2013). As highlighted by several scholars (Bandini, 2013), the reasons for this are connected, once again, with the lack of managerial culture. In this sense:

*'There is not always sufficient emphasis on managerial culture - and related tools - needed to manage well and knowingly a nonprofit organization'* (Bandini, 2013, pp. 152-153)

The financial statements and the entire accounting document system are the most important tool for presenting the financial and economic situation and the most effective way to meet the needs of their stakeholders and to provide an overview of the state of health of the organization, especially for a nonprofit company (Civittillo, 2016). Consequently, a specific aspect to reflect is the need to ensure that this set of information is appropriate to the reality to which it relates, and is capable of ensuring the completeness, consistency and transparency of them with respect to the multiplicity of internal and external subjects, in any way related to the company itself. Such a need can only be answered with the regulatory apparatus that should provide an information and accounting system that is at least proportionate to the relevance of the Third Sector which is ever greater, as we have been able to perceive earlier.

The need for information transparency, on the other hand, directly involves the need to

*'report on the use of economic and financial resources, the correctness with which the actors involved in the management, the adequacy and the responsiveness of behaviors Assumed in relation to the objectives set, and with direct and indirect results, actually achieved in the short and long term'* (Ricci, 2012, p. 245).

This is, as already explained above, the concept of accountability.

From this definition, we can argue that an adequate degree of accountability, especially for nonprofit entities, is able to ensure not only the clarity of information about the organization, but above all the due responsibility of the directors regarding the pursuit of the goals and of goals previously defined.

The relational ability typical of nonprofit organizations, consisting of a dense network of relationships with numerous and varied stakeholder categories, combined with the social aims pursued, denotes a clear need for transparency of the entire management activity, especially with regard to public financial resources just above highlighted. This need for transparency is evident, cannot be achieved solely through budget documents or through traditional financial programming and control instruments, as they are almost sterile to only communicate a few tangible aspects of management activity and, on the other hand, they are not able to provide a transparent view of the social goals which similar organizations are generally inspired. Such information, albeit important, must necessarily be supplemented by other documents able to describe, also from a qualitative point of view, the degree of achievement of the objectives of nonprofit companies: the reason for this need lies in the finding that, for these, the accounting records and the financial statements are unable to ensure

the effective and efficient achievement of the aims pursued by them. In this sense, social reporting and the use of “wider” (or non-financial) reporting tools in nonprofit institutions could certainly be a valid support for the information and management correctness mentioned above.

Indeed, the use of accounting-related tools that are not merely quantitative and/or accounting based, can certainly provide significant potential benefits, representing in some sense the necessary completion of traditional corporate accounting systems. At the same time, social reporting becomes more effective in controlling activities, as it is geared towards the overall management of stakeholder relations.

The last consideration on the subject addressed in this work can only be related to the lack of financial resources, one of the main concerns of the nonprofit phenomenon. With regard to this, it is largely perceptible, as evidenced by the findings of the empirical study previously outlined, that the tendency of insufficient financial resources is a problem noticed by nonprofit companies as well as transversal to most of their different types.

Moreover, the considerable expansion of the Third Sector registered over the last decades, as mentioned, has not been devalued as well as profound changes in the different operating paradigms of nonprofit business realities. In this direction, the remarkable and rapid growth of the community’s social needs was supported by a clear expansion of the range of services offered by nonprofit organizations (Civitillo, 2016). However, this increase was not only of a quantitative nature, as the continuous evolution of social needs demanded and determined an enrichment of the qualitative level of output and outcome of the nonprofit sector. Such quantitative growth, coupled with the continued reduction of public-sector financing flows, has therefore created the preconditions for the tightening and progressive worsening of the financial conditions of nonprofit organizations.

It is no coincidence, therefore, that fund raising has therefore become a matter of special attention by the Third Sector. Fund raising can be generally defined as a synonym for financial resources collection. However, national and above all international scientific literature tends to identify with this term a considerably wider, articulate and broader concept in its scope (Allison & Kaye, 2005; Morton, 2012). The real and concrete utility of fund raising is, in fact, not simply the material money procuring, without any pretense of systematicity and coordination. Fundraising tools, on the contrary, must be seen as important strategic tools. In this perspective, they are aimed to:

*‘Qualitative and quantitative development of incomes’* (Bandini, 2013, p. 190),

in perfect coordination with the goals of the organization.

The mere attempts to raise financial resources with no strategy and coordination, on the other hand, cannot qualify as real fundraising forms, and can be confined to simple fundraising and thus, paradoxically, of effective and effective positive impact on the structure of a nonprofit organization:



the absence of a co-ordinated and finalized approach could in fact result in inefficient use of the resources thus acquired.

Developing an adequate fundraising strategy as a process requires intense system design activity to be truly effective. The purpose of this research is not an exhaustive discussion of fundraising techniques and tools, but it is still necessary to point out the decisive importance of the proper identification of the underlying motives which should underestimate every attempt in this direction. Determining the financial need it considers necessary cannot ignore the highlight of the organization's mission as well as the main activities that characterize the entire organizational structure. Such basic information will be crucial for the proper identification of the so-called "fund raising markets" to be addressed and of the tools to be used for the collection of financial resources, albeit in the previously mentioned systemic and coordinated sense (Civitillo, 2016).

With regard to this last aspect, the so-called "digital fund raising" is particularly relevant. The new frontiers of digital and telematics technology have upset the company's operating rules not only with regards to the aspect of external communication (eg web site, social network, etc.) or in relation to internal computerization (eg management software Management and control, computerized databases, etc.). For nonprofit organizations, specifically, new IT technologies are indeed a very powerful tool for overall and overall improvement of their financial structure. In the United States, to cite one of the most striking examples, financial resources channeled to the Third Sector through new online channels represent more than 14% of the total donations (Bandini, 2013). The example given above, however, must be properly understood in order to avoid any dangerous misunderstandings. The obvious enormous scope of digital fund raising cannot currently be interpreted merely as a possible and additional tool for nonprofit companies, thus legitimizing behavior that tends to consider such a mere integrative eventuality. The US context must necessarily make it clear that the implementation of such digital innovations is, in essence, a new strategic direction to be pursued by trying to pursue maximum efficiency and effectiveness. On the contrary, the superficial consideration of digital fund raising in the terms just portrayed could result not only in a lack of strategic opportunity, but especially in the risk of pursuing other poorly effective choices. In this sense, digital fund raising represents a crucial strategic choice to ensure the improvement of the overall conditions of nonprofit organizations with implementation difficulties, among other things, definitely not prohibitive considering the tools it uses. The fulcrum is represented by the web site that should not only perform a simple informational and relational function since, as mentioned above, it could be an important (if not the main) tool for the implementation of digital fundraising solutions. The website, however, is not the only digital channel available to nonprofit organizations in this sense: email, social networking, and search engine indexing are also crucial tools in fundraising through digital channels.

However, it is crucial to point out that the mere availability of the aforementioned means is not automatically a source of “digital” financial resources. How easy it is to understand, each of these communicative vectors is effective for fund raising only if structured according to the strategy designated and pursued by the specific nonprofit entity. The ultimate goal, therefore, should be to ensure adequate visibility, engagement, fidelity and sensitization of users of digital platforms by creating spontaneous but strongly engaging relationships. In this way, fundraising becomes an indirect but almost consequential effect on the “digital” structure of the organization itself.

*May we have a model?*

The concluding considerations outlined in the last part of this paper allow us to identify the factors on which to act for the design of effective governance strategies.

The typical system of programming and control of nonprofit entities is not unlike any type of corporate organization (Anthony, 1992), articulating in the following phases (*Figure 4*):

- 1) Planning;
- 2) Programming (and formalization of objectives);
- 3) Measurement of management and reporting outcomes;
- 4) Analysis of results (and feedback).



**Figure 4. The business planning system. Our elaboration 2017.**

Nevertheless, the nonprofit sector is characterized by a different logical setting of the organizational-management planning phase. The traditional business programming paradigm is based on the

optimization (or maximization) of economic convenience (Figure 5). Basically, the definition of the kind of needs to be met would affect the entire organizational structure, determining the choices on the identification of processes of activity and, consequently, human resources needed for the latter.

The paradigm of nonprofit organizations, however, is characterized by a completely opposite approach. In this case, it is the knowledge of the motivations of the people who make up the organization that, together with the study of needs, allows to define the organizational structures and processes (Figure 6).

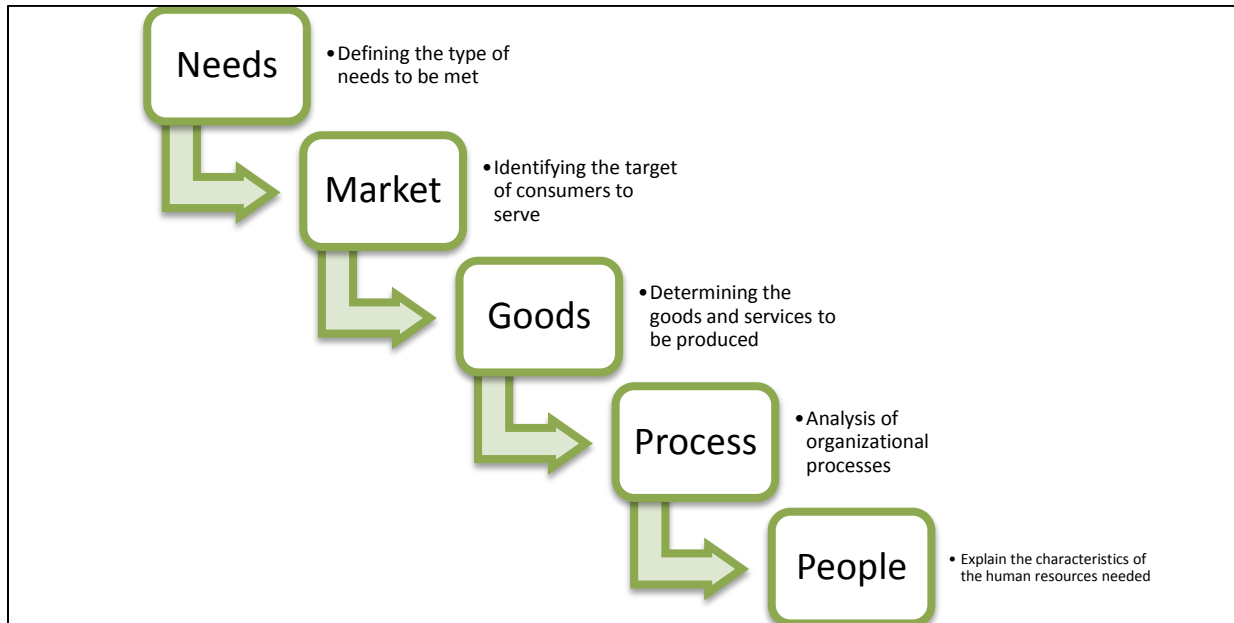

Figure 5. The traditional business programming paradigm. Our elaboration 2017.

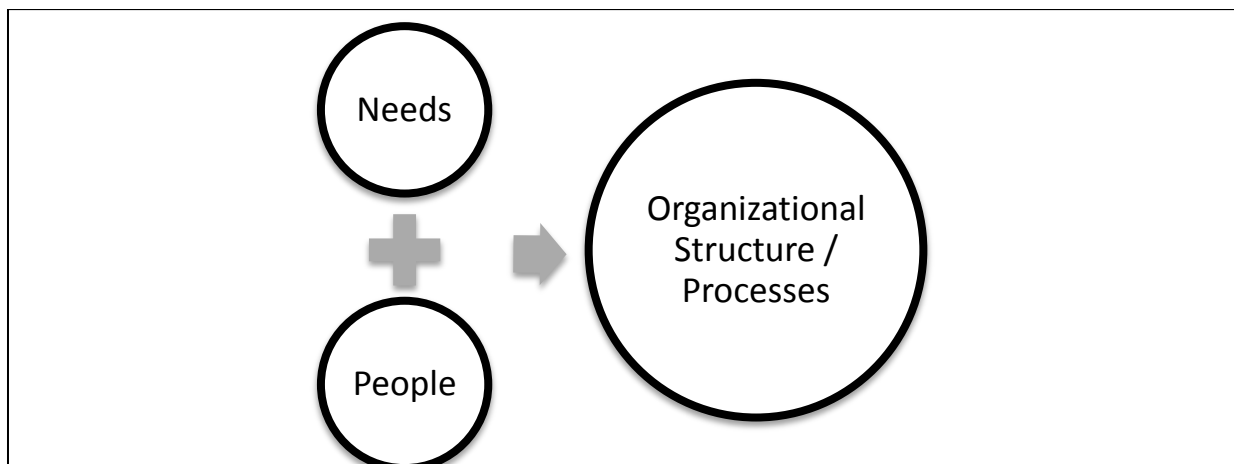

Figure 6. The paradigm of nonprofit organizations. Our elaboration 2017.

On the other hand, however, highlighting such key elements could be useful for the management of nonprofit organizations: in this sense, if the critical factors mentioned above constitute potentially

critical causes for them, on the other hand, the effectiveness and efficiency of their presence could ensure the achievement of one or more competitive advantages through their appropriate and appropriate enhancement. In other words, a systemic view of nonprofit, consequent (even) to the correct weighting of these components, could be the interpretative tool of the whole phenomenon: critical factors would thus become successful factors. In fact, this could even allow the identification of constituent elements of a conceptual reference model that seeks to highlight the ideal trajectory of the management of nonprofit organizations. In this sense, the model would represent a system of constituent elements bound by relational constraints according to universal interaction laws (Popper, 1994). A possible pattern schematization attempt is summarized in Figure 7.

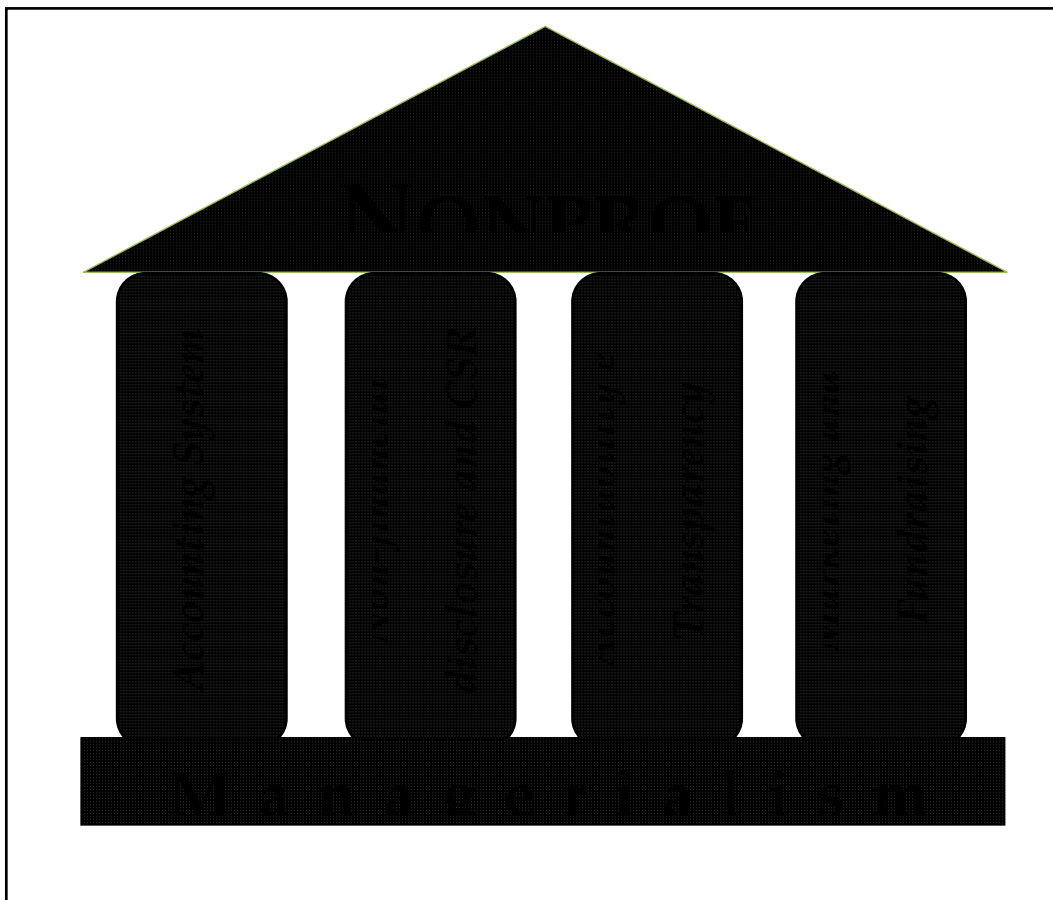

Figure 7. The “nonprofit” management: a (possible) governance model (?). Our elaboration 2017.

The proposed conceptual model, which is the result of the above considerations, is ideally structured on the key factors mentioned above:

- 1) The accounting system;
- 2) Non-financial disclosure processes and tools and the Corporate Social Responsibility;
- 3) An adequate level of accountability and organizational transparency;
- 4) Marketing activities and the fundraising system.

These “conceptual pillars” should represent the backbone of a nonprofit organization that can qualify characterized by sufficient levels of effectiveness and management efficiency.

The accounting system, for example, is undoubtedly an important element for any corporate organization, as well as for nonprofit organizations. It is, in fact, the logical and substantive assumption for each phase of the business planning system mentioned in Figure 1: Both the planning and programming phases, and the resulting measurement, reporting and analysis of the results activities cannot take place without the accounting support which, in its function of the company information system, is able to provide the management with the appropriate informational information necessary to management.

However, it should be pointed out that the accounting system alone is unable to provide some necessary information that does not have an accounting nature: financial and asset information should at least be supplemented by information of different kinds. The wide range of stakeholders cannot be satisfied solely by the accounting data: it is therefore necessary to accompany the budgetary information those generated by non-financial disclosure tools: Social reports, sustainability reports and other similar documents can provide information the knowledge of which is crucial, especially for the mission of the nonprofit reality. For their effectiveness, however, the mere introduction of such reporting documents is not enough: in this way, they would constitute a simple bureaucratic fulfillment depriving them of value and meaning. In contrast, an information “extended” is only guaranteed by the natural implementation of sequential activities of disclosure, grouped according to organizational characteristics and management specifications: only an accomplished social reporting process may be able to make fluid the activities and documents system and to provide information about the organization that is really “integrated”.

The “enlarged” disclosure processes and activities mentioned above are based on adequate levels of accountability and organizational and management transparency. Although the term accountability is a rather complex and chameleonic concept (Sinclair, 1995; Mulgan, 2000), it “implies the duty to act in a responsible way and to be accountable to others for one’s actions, in order to maintain effective and logical links between planning, deciding, action, and verification” (Ricci, 2016, 2017). In the nonprofit sector, it is essential to report on the use of financial and non-financial resources, the correctness of the behavior of the subjects involved in the management, the adequacy and compliance of the behaviors undertaken with the objectives set, as well as the results actually achieved: its importance for any type of business organization, especially for nonprofits, is evident.

Finally, we cannot overlook the importance of fundraising. As already explained above, fundraising

should be an integrated system of tools aimed at the qualitative and quantitative development of the revenue of nonprofit organizations. On the contrary, fundraising is not the inorganic and unorganized collection of monetary resources as it should be perfectly aligned with the purposes of the organization, its mission and, of course, the activities it exercises. This therefore involves a close connection between fundraising and marketing.

However, this structure, in turn, must necessarily “rely” on a solid conceptual basis of managerialism: the characteristic of professionalism that should permeate every aspect of the organizational and managerial structure. In this sense, it is transversely structured across the whole structure, which is fundamental to the stability of the same “conceptual pilates” mentioned above.

In relation to the issue of management and its relevance to nonprofit organizations, several scholars have shown that it is no longer exclusively attributable to profit oriented organizations, arguing that:

*«Twenty years ago, management was a dirty word for those involved in nonprofit organizations. It meant business, and nonprofits prided themselves on being free of the taint of commercialism and above such sordid considerations as the bottom line. Now most of them have learned that nonprofits need management even more than business does, precisely because they lack the discipline of the bottom line» (Drucker, 1989).*

## REFERENCES

- Abrahamson E., Baumard, P (2008), What lies behind organizational façades and how organizational façades lie: An untold story of organizational decision making, in Gerard G., Hodgkinson P., Starbuck W.H. (Eds.), The Oxford handbook of organizational decision making, Oxford University Press, Oxford;
- Allison M., Kaye J. (2015). Strategic Planning for Nonprofit Organizations: A Practical Guide for Dynamic Times, John Wiley & Sons Inc., New Jersey;
- Anheier, H. K. (2014). Nonprofit organizations: theory, management, policy, second edition, NY: Routledge;
- Anthony R.N., Young D.W. (1992), Controllo di gestione per il settore non profit, McGraw-Hill, Milano, 1992;
- Austin, J. E. (2000), Strategic collaboration between nonprofits and business, Nonprofit and voluntary sector quarterly, 29(suppl 1), 69-97.
- Bandini F. (2013), Economia e management delle aziende nonprofit e delle imprese sociali, Cedam, Padova;
- Barbetta G. P., Cima S., Zamaro N. (2003), Le istituzioni non profit in Italia, Il Mulino, Bologna;
- Ben-Ner A. (2002), The Shifting Boundaries of the Mixed Economy and the Future of the Nonprofit, Annals of Public and Cooperative Economics, 73(1);
- Benevolo C., Caselli C. (2011), Il contributo del non profit nel sistema delle filiere di creazione del valore, in Borgonovi E., Mussari R. (a cura di), Collaborare e competere per un mercato responsabile e solidale, Il Mulino, Bologna;
- Benington J., Moore M.H. (ed.) (2011), Public Value Theory and Practice, Palgrave Macmillan, New York;
- Borgonovi E., Mussari R. (ed.) (2011), Collaborare e competere per un mercato responsabile e solidale, Il Mulino, Bologna;
- Bozeman B. (2007), Public Values and Public Interest: Counterbalancing Economic Individualism, Georgetown University Press, Washington D.C.;
- Bronzetti G. (2007), Le aziende non profit, Franco Angeli, Milano;
- Bruni L., Zamagni S. (2015), Economia Civile, Il Mulino, Bologna;
- Catturi G. (2003), L'azienda universale, Cedam, Padova;

- Cavaliere E., Ferraris Franceschi R. (2010), *Economia aziendale*. Volume I. Attività aziendale e processi produttivi, Giappichelli, Torino;
- Civitillo R. (2016), *L'aziendalità del volontariato. Il non profit nella Provincia di Benevento*, Franco Angeli, Milano;
- Cho C.H., Laine M., Roberts R.W., Rodrigue M. (2015), *Organized hypocrisy, organizational façades, and sustainability reporting*, *Accounting, Organizations and Society*, n. 40, p. 78-94;
- Dolfsma W. (2013), *Government Failure: Society, Markets and Rules*, Edward Elgar Publishing, Cheltenham (UK) and Northampton (MA-USA);
- Drucker, P. (1989), "What Business Can Learn from Nonprofits", *Harvard Business Review*, July-Aug.;
- Fiorentini G. (1997), *Organizzazioni non profit e di volontariato. Direzione, marketing e raccolta fondi*, Etas, Milano;
- Hansmann H. (1980), *The role of Nonprofit Enterprise*, *Yale Law Journal*;
- ICNPO, *International Classification of Nonprofit Organizations*;
- Marcon G., Tieghi M. (2010), *Sistema informativo e misurazioni economiche nelle aziende non profit*, in Zangrandi A. (a cura di), *Aziende non profit. Le condizioni di sviluppo*, Egea, Milano;
- Molteni M. (2004), *Responsabilità sociale e performance d'impresa. Per una sintesi socio-competitiva*, Vita e Pensiero, Milano;
- Moore M.H. (1995), *Creating Public Value: Strategic Management in Government*, Harvard University Press, Cambridge;
- Moro G. (2014), *Contro il non profit*, Laterza, Bari;
- Mulgan R. (2000), *Accountability: an ever-expanding concept?*, *Public Administration*, 78(3), 555-573;
- Phelps E.S. (1975), *Altruism, morality and economy theory*, Russell Sage Foundation;
- Popper K.R. (1994), *The myth of the framework. In defence of science and rationality*, Routledge, Abingdon;
- Ricci P. (2017) "Corporate Social Responsibility" in *Global Encyclopedia of Public Administration, Public Policy and Governance*, Springer International Publishing, 2017, Switzerland;
- Ricci P. (2016) "Accountability" in *Global Encyclopedia of Public Administration, Public Policy and Governance*, Editor: Ali Farazmand, Springer International Publishing Switzerland;
- Ricci P., Stefanini P. (2016), *Benessere e sicurezza: la persona al centro. Dialogo tra Paolo Ricci*, Università del Sannio e Pierluigi Stefanini, Gruppo Unipol, in *L'impresa di domani: innovativa sostenibile inclusiva*, Il Salone della CSR e dell'innovazione sociale: riflessioni, contributi, esperienze, Egea, Milano, p. 107-109;
- Ricci P. (ed.) (2012), *L'economia d'azienda: paradigmi e declinazioni*, Giuffrè Editore, Milano, 2012;
- Salamon L. (ed.) (1999), *Global Civil Society, Volume One: Dimensions of the Nonprofit Sector*, The Johns Hopkins Center for Civil Society Studies Baltimore;
- Salamon L. M., Anheier H. K. (1996), *The emerging nonprofit sector: an overview*, Manchester University Press, Manchester and New York;
- Sargeant A. (2009), *Marketing Management for Nonprofit Organizations*, Oxford University Press, Oxford;
- Speckbacher, G. (2003), *The economics of performance management in nonprofit organizations*, *Nonprofit Management and Leadership*, 13(3), John Wiley & Sons Inc., New Jersey;
- Sinclair, A. (1995), *The chameleon of accountability: forms and discourses*, *Accounting, Organizations and Society*, 20(2-3), 303-326;
- Weisbrod B.A. (1972), *Toward a theory of the Voluntary non profit sector in a three sector economy*, University of Wisconsin-Madison;
- West K., Davis P. (2011), *What is the public value of government action? Towards a (new) pragmatic approach to values questions in public endeavours*, *Public Administration*, 89(2);
- Winston C. (2007), *Government Failure versus Market Failure: Microeconomics Policy Research and Government Performance*, Brookings Institution Press, Washington;
- Zagrebel'sky G. (2014), *Contro la dittatura del presente*, Editori Laterza, Roma.

## A WEB OF EMOTIONS –THE EFFECT OF ONLINE BRAND EXPERIENCE ON BRAND LOYALTY

Cleff, Thomas; Walter, Nadine

Pforzheim University, Pforzheim, Germany

### ABSTRACT

The article analyses how online brand experience can be measured and determines its impact on brand loyalty. Similar to offline brand experience, online brand experience is broken down into sensory, affective, cognitive, behavioral and relational elements of brand experience. This is based on the believe that – although online brand experience lacks physical presence such as a store – it has the possibility to create a virtual brand experience through visual, audible, gambling or community-based features. Therefore, the brand elements of offline brand experience are applied to online brand experience. Since online brand experience engages customers' feelings and emotions, it can lead to an improved brand image and to behavioral and attitudinal brand loyalty. The present empirical research investigates the influence of the five different types of online brand experiences – sensory, affective, cognitive, behavioral, and relational – and the website usability on brand loyalty through an empirical study of the travel website qyer.com in China. Respondents (n=69), i.e. users of the qyer.com website, confirm through a standardized online survey, the positive impact of online brand experience on brand loyalty. Especially affective and behavioral brand experience impacts brand loyalty largely - sensory, cognitive and relational brand experiences have a slightly lower but significant impact. Website usability shows the lowest impact. The study proves the significance of online brand experience to create brand loyalty and identifies the most important dimensions of brand experience.

*Keywords: Brand experience, online brand experience, brand loyalty, travel*

### INTRODUCTION

Brand experience engages the customers' senses and emotions. It can create an emotional connection to a brand leading to an improved brand image and an increased brand loyalty. In a physical store customers can use all five senses and see, touch, smell, taste or try out a brand. Online brands lack this physical presence, but they have the possibility to create a virtual brand experience through audio, video, games or communities. Especially interactivity with users offers an opportunity to create an



emotional bond possibly even stronger than the offline brand experience. This can lead to a favorable attitude and repeat purchase of the brand, hence to increased brand loyalty.

## **THEORETICAL BACKGROUND**

### *Brand Experience*

#### *Definition of brand experience*

Brand experience was firstly mentioned in the pioneering article by Holbrook and Hirschman (1982) "The Experiential Aspects of Consumption: Consumer Fantasies, Feelings, and Fun". The authors identify new consumption patterns "that relate to the multi-sensory, fantasy, and emotive aspects of product use" (Holbrook and Hirschman, 1982). In contrast, traditional marketing saw buyers rather as rational decision-makers who base their purchasing choice on functional features and where buying is mainly a necessary act to supply needed goods. Experiential marketing acknowledges that consumers are also emotionally driven and aim to achieve sensual and pleasurable experiences (Cleff et al., 2014). Brakus et al., (2009) sees brand experience as "subjective, internal consumer responses (sensations, feelings, and cognitions) and behavioral responses evoked by brand-related stimuli that are part of a brand's design and identity, packaging, communications, and environments". An experience should consist of "personal relevance, novelty, surprise, learning and engagement" (Poulsson and Kale, 2004). Sensual elements of an experience are even believed to have a greater impact on shaping customer preferences than the attributes of a product or service (Zaltmann, 2003; Lou et al., 2011). Since brand experience engages the customers' sense and emotions, it can create an emotional connection to the brand leading to an improved brand image and brand loyalty (Schmitt, 1999; Brakus et al., 2009).

#### *Reasons for the evolution of experiential marketing*

The transition from traditional marketing towards experiential marketing has occurred as a result of three major developments over the last years (Chu et al., 2013): Firstly, advertising overexposure by traditional communication channels forces marketers to change their ways to gain consumers' attention and reach them with their messages (Mortimer, 2009). Secondly, saturation of markets has led to fierce global competition – driven by the phenomenon that functional product benefits are becoming exchangeable. This complicates strategies for companies to differentiate on functional product features (Fransen and Lodder, 2010). Pine and Gilmore (1998) claim that since "goods and services become commoditized, the customer experiences that companies create will matter most". Thirdly, more and more consumers lead hedonistic lifestyles and look for pleasurable experiences (Fransen and Lodder, 2010), which experience marketing is able to provide.

#### *Measuring brand experience*

Various researchers have made efforts to develop operational typologies to scale and measure brand experience. The common belief is that a customer experience should be holistic and multidimensional (Gentile et al., 2007). Drawing from various psychological and behavioral studies this includes three main dimensions of experiences: sensation, cognition and affect. Most brand experience frameworks have these elements in common, such as Hirschman and Holbrook (1986), Pine and Gilmore (1998), Schmitt (1999) and Brakus et al. (2009). Hirschman and Holbrook (1986) propose the Thought-Emotion-Activity-Value (TEAV) model with four dimensions: "thought" includes cognitive processing (i.e. mental events); "emotion" involves feelings, expressive behaviors, and physiological responses; "activity" includes physical and mental events; "value" includes evaluative judgements. These four areas were empirically validated by Lofman (1991) through a large exploratory study. Pine and Gilmore (1998) sort experiences into four "e"-categories: entertainment, educational, esthetic (aesthetic) and escapist, according to where they fall along the dimensions "active/passive participation" and "immersion versus absorption". These four categories were validated in an empirical study by Sands et al. (2008). Schmitt (1999) identifies five different types of experiences: sensory experiences (SENSE), affective experiences (FEEL), creative cognitive experiences (THINK), physical experiences, behaviors and lifestyles (ACT) and social experiences that result from relating to a reference group or culture (RELATE). Tsaur et al. (2006) have validated these five dimensions in an empirical study on the Taipei Zoo. Brakus et al. (2009) came to the conclusion that brand experience is influenced by brand-related stimuli that constitute "subjective, internal consumer responses", such as sensations, feelings and cognitions, and behavioral responses. As a result, Brakus et al. (2009) constructed a brand experience scale with four dimensions: sensory, affective, behavioral and intellectual. This builds on the work of Schmitt (1999): The categories SENSE, FEEL, ACT and THINK of Schmitt (1999) are analogous to the categories "sensory", "affective", "behavioral" and "intellectual" of Brakus et al. (2009). Schmitt (1999) however, has included with the fifth dimension RELATE an important element which "relates to the need to be perceived positively by others" (Schmitt, 1999). This includes social-identity experiences that result from belonging to a group. Since this is especially important in online channels (e.g. websites, social media, brand communities), this dimension has proven relevant in further empirical studies (Cleff et al., 2014).

### *Online Brand Experience*

#### *Introduction to online brand experience*

Brands use their online presence as touch points with their customers. The Internet and its various channels (including the Website, blogs, social media, chat rooms, interactive images and virtual communities) have established themselves as essential within an integrated marketing communication campaign. Companies inform, share and co-create experiences with brands online (Simon et al., 2013;

Prahalad and Ramaswamy, 2004). Van Noort et al. (2012) state that “consumers increasingly consider brand web sites as the most important medium to seek and find information”. In addition, brands have built up internet shopping platforms which show significant numbers of users and transaction volumes. With the increasing expansion of the virtual marketplace, the topic has drawn the attention of researchers and online brand experience has emerged at the beginning of this century as a new research area.

#### *Definition of online brand experience*

Online brand experience is linked to various other concepts: Online customer experience (Rose et al., 2012), customer experience in online environments (Novak et al., 2000), Web experience (Constantinides, 2004; Lin et al., 2008), brand experience on the web (Ha and Perks, 2005), consumers’ online flow experience (van Noort et al., 2012), virtual experiential marketing (Luo et al., 2011) and online purchase experience (Jin and Park, 2006). The essence of all concepts remains the same: During their online activities, users are immersed in an experience which is “cognitive and affective” in nature (Morgan-Thomas and Veloutsou, 2013). It combines cognitive responses (such as usability and functionality of a website) with affective experiences (hedonistic experiences that bring fun and enjoyment). In contrast to brand experience that directly targets the senses, virtual experiential marketing relies on interfaces that act as a replacement for “real world experiences” (Luo et al., 2011).

The scope of online brand experience varies. On the one hand, scholars see it as marketing for pure online brands such as retailers and search engines (Morgan-Thomas and Veloutsou, 2013). On the other hand, it can also be seen as a general concept to add experiential marketing to websites. This would also include brands that have a physical presence (a brick and mortar store) and at the same time an online presence. Without store atmospherics and its sensual clues (especially touch, taste and smell), the challenge for pure online brands to create a brand experience is even larger than for offline brands (Morgan-Thomas and Veloutsou, 2013). Therefore, online brands have to use visual (i.e. color, graphics, layout, design, animations) and auditory clues to arouse emotional responses (Lou et al., 2011). However, some authors argue that for pure online brands, the continuous active relationship and its two-way interaction with the user offer additional possibilities for interactivity and engagement with the customer, an offline brand does not have (Morgan-Thomas and Veloutsou, 2013).

#### *Measuring online brand experience*

An operational categorization to measure (offline) brand experience exist (Schmitt, 1999; Brakus et al., 2009) but there is no framework for the conceptualization of online brand experience. However, online brand experience is closely linked with two neighboring research areas: Firstly, scales that are focusing on the rather technological usage of the website (website functionality) or secondly, online brand experience based on the construct of flow (flow online brand experience).

The first research area, website functionality, focuses on the 'mechanical' usability of the website. The most analyzed areas are functionality factors (including usability, e.g., site navigation or ordering/payment process, and interactivity, e.g. customer service or interaction with personnel) and psychological factors (e.g., transaction security, data safety, guarantees/return policy) (Constantinides, 2004). Scholars that focus on online experience are also part of this research area, for example Jin and Park (2006) analyze website design, order fulfillment, communication, merchandising, security/privacy and promotion. Although this research area provides important aspects to analyze the functional aspect of the website with the aim to increase conversion and sales, it lacks relevant factors to create a hedonistic brand experience. The factors analyzed are necessary (i.e. without them a brand experience cannot be achieved), but they are not sufficient (i.e. they alone do not create a true brand experience). Therefore, they are pure hygiene factors.

The second research area, flow customer experience, focuses on the construct of flow in the context of online customer experience (Novak et al., 2000; van Noort et al., 2012; Rose et al., 2012; Lou et al., 2011; Mathwick and Rigdon, 2004). The authors are building on the work of Csikszentmihalyi (1990 and 1997). He originally defines flow as an optimal mental state of complete immersion in an activity. Flow experiences can happen in daily life, e.g. at the workplace, in education or in sports. Hoffman and Novak (1996) have applied this psychological concept to online customer experience. When performing online tasks flow is created through "high levels of skill and control, high levels of challenge and arousal and focused attention and is enhanced by interactivity and telepresence" (Hoffman and Novak, 1996). However, for measuring the ability of companies to provide a sensual experience, these variables are only partly usable. Although variables like telepresence, time distortion and arousal measure the level of customer experience well, other variables of the construct, such as skill, control, speed or challenge are only necessary conditions for online brand experience – but not sufficient to create a true brand experience. Flow includes unfortunately also many hygiene factors and can therefore not serve as a true indication for online brand experience.

As a summary, none of the two research areas can serve as the theoretical foundation for a quantitative validation, since both lack relevant factors for brand experience. However, (offline) brand experience categorization frameworks exist that have proven in various studies to measure brand experience well (Brakus et al., 2009), so we believe that with some adaption they should also provide a good basis to measure online brand experience. The source of experience – no matter if it is offline or online – does not fundamentally change the nature of the experience. This still consists of the five elements "sensory, emotional, cognitive, behavioral, and relational" (Schmitt, 1999). Therefore, we believe an adaptation of the brand experience framework to online brand experience would provide additional insights to this research area. We therefore use the dimensions sensory, affective, cognitive, behavioral and relational.

In addition to these brand experience dimensions, we recognize the need for hygiene factors to ensure the necessary conditions for a brand experience are given. Limited web functionality is a key source for online dissatisfaction and can diminish brand experience (Constantinides, 2004). Website usability ensures the easy use of the website including browsing convenience, site navigation and accessible information. Therefore, we include the website usability dimension (USE) to our research framework. The brand experience model will therefore consist of six dimensions (sensory, affective, cognitive, behavioral, relational, usability).

#### *Brand loyalty*

Two types of brand loyalty concepts exist: behavioral and attitudinal loyalty (Day, 1969). Traditionally, literature describes the loyalty concept with an emphasis on the behavioral aspect, which defines behavioral loyalty by “consequential actions, such as repeat purchases, share of wallet and word of mouth marketing” (Lou et al., 2011). According to this definition, brand loyalty has been measured by indicators such as repeat purchase frequency or relative volume of same brand purchasing. The loyalty concept has been enriched later by taking into account the attitudinal perspective. Dick and Basu (1994) suggested in their theoretical model that a favorable attitude and repeat purchase were required to define loyalty. East et al. (2005) empirically validated this concept and confirmed the theory that consumer loyalty is characterized by both, a favorable attitude and repeat purchase. Bandyopadhyay and Martell (2007) have built on this by a broad empirical study and have found that behavioral loyalty is influenced by attitudinal loyalty. Therefore, we will use in this research both, behavioral and attitudinal brand loyalty, in the construct.

## **CONCEPTUAL FRAMEWORK AND HYPOTHESES**

Experiential marketing engages the consumer through senses and emotions. A holistic experience leads to an emotional fulfillment creating a special bond with the brand (Morrison and Crane, 2007). This can lead to a more positive brand image perception and a stronger brand loyalty. Previous research has analyzed the effect of (offline) brand experience on various aspects of the brand. Empirical research has found a positive impact on brand attitude and brand relation (Fransen and Lodder, 2010), on satisfaction/behavioral intention (Tsauro et al., 2006), and on brand loyalty (Yoo and Donthu, 2001; Brakus et al., 2009; Cleff et al., 2014). Regarding online brand experience, there are also various studies that confirm the positive impact on certain brand dimensions, such as on brand relationship (Morgan-Thomas and Veloutsou, 2013), on brand trust (Ha and Perks, 2005) and especially on brand loyalty (Jin and Park, 2006; Luo et al., 2011; Mathwick and Rigdon, 2004; Rose et al., 2012). Loyalty is confirmed in

most studies with behavioral and attitudinal dimensions. Therefore, we assume that there is a positive relationship between online brand experience and (behavioral and attitudinal) brand loyalty:

H1: Online brand experience elements have a positive effect on brand loyalty

In addition to the overall construct online brand experience, we intend to analyze the relationship of the dimensions sensory, affective, cognitive, behavioral and relational. The brand experience construct is based on the fact that these experience dimensions are evoked by brand-related stimuli. However, we are aware that there is no “one-to-one related correspondence” (Brakus et al., 2009), i.e. that one certain stimulus triggers one certain brand experience type, but rather several dimensions. However, we want to find out if online experiences are fundamentally different from traditional brand experiences of customers. Therefore, we examine all factors separately.

#### *Sensory brand experience*

Since online brands lack the possibility to create a physical experience, not all senses can be stimulated in an online experience. Out of the five traditionally recognized senses (sight, sound, smell, touch, taste) smell, touch and taste cannot be perceived. However, “the more senses an experience engages, the more effective and memorable it can be” (Pine and Gilmore, 1998). Therefore, sight and sound play a crucial part to compensate and to ensure an arousing and memorable sensory experience. Visual stimulants, such as colors, graphics, layout, design, animations or audio elements like music and podcasts are key. Especially the combination of sight and sound can stimulate a high level of arousal. Therefore, we believe that a remarkable online sensory brand experience can be created with a positive impact on the brand, and assume that

H1.1: sensory brand experience has a positive effect on brand loyalty

#### *Affective brand experience*

The affective brand dimension includes moods and emotions evoked by the online experience. Positive emotions can be triggered by relevant and visually appealing content. In addition, the content can be enriched with appealing sensory stimuli (sight, sound and interactivity in videos, games etc.) to enhance its effect. Online campaigns that appeal to the consumers’ curiosity are also a means to enjoyment (Simon et al., 2013). Therefore, we assume that

H1.2: affective brand experience has a positive effect on brand loyalty

#### *Cognitive brand experience*

Customers encounter an online brand experience through incoming sensory data (such as text-based information, images and audio) which they can interpret in a sensorial or in a cognitive way (Rose et al., 2012). The latter includes conscious mental processes and engages customers into thinking about the brand. This can result in a creative mental state (imaginative/divergent) but also in an analytical

problem solving process (analytical/convergent (Gentile et al., 2007; Brakus et al., 2009). Therefore, we assume that

H1.3: cognitive brand experience has a positive effect on brand loyalty

#### *Behavioral brand experience*

The behavioral brand experience targets the customers' physical experiences by showing alternative behavior or alternative lifestyles. Behavioral changes can be triggered by rational approaches, but are usually most successful if they are "motivational, inspirational and emotional in nature" (Schmitt, 1999). Behavioral changes can be triggered online to the same extent as offline, since alternative manners or lifestyles can also be shown in the virtual world. Therefore, we assume that

H1.4: behavioral brand experience has a positive effect on brand loyalty

#### *Relational brand experience*

Online brand interaction that includes interactive elements can take place on two levels: either with the brand itself or with other customers. Regarding the first, the interaction of a customer online with a brand can be "viewed as an ongoing relationship where the experiences associated with the brand create emotional ties between the customer and the branded product" (Morgan-Thomas and Veloutsou, 2013). This can create a long lasting and sustainable bond between the brand and the customer. Regarding the latter, social interactions are taking place through sharing of information and opinions between customers online. This can create social identity with a group that shares similar interests and lifestyles (Lou et al., 2011) and provide customers a sense of belonging (Dholakia et al., 2004). Platforms such as virtual communities can enhance the sharing of information and foster this feeling. Social identity with a group or community can be part of a brand experience since it builds a sense of belonging. Therefore, we assume – both through brand interaction between brand and customer as well as customer and customer – that

H1.5: relational brand experience has a positive effect on brand loyalty

#### *Usability*

Usability relates to the usage and navigation of a website and to the fact how intuitive and easy to navigate it is to interact with it (Simon et al., 2013). Lin et al. (2008) argue that a positive brand experience is likely to arise if the website is well designed. The main components of usability for brand experience are (Preece, 2001) firstly navigation (e.g. easy and fast browsing), secondly information design (e.g. understandable information) and thirdly dialog and social interaction support (e.g. the ease to execute demands). Other usability factors such as site ordering/payment processes are rather E-Commerce-related than branding related, and therefore of less relevance (Constantinides, 2004). Therefore, we assume that

H1.6: usability elements have a positive effect on brand loyalty

## RESEARCH DESIGN

The Chinese travel website qyer.com (founded 2005) has been selected to conduct the empirical research. With more than 10 million users it is a widely known travel website in China. It is a user-generated platform and its main component is an online forum for users to share their own travel experiences, find travel partners and look for travel tips. It also contains a travel-related search engine, downloadable travel itineraries, as well as a hotel and ticket price comparison and booking system. All products and services of qyer.com are only offered online or through mobile apps. Therefore, the measurement of online brand experience is not affected by any offline brand experience. The initial pool of items to measure online brand experience and brand loyalty were developed by reference to preexisting scales: The items measuring the *sensory* dimension, the *affective* dimension, and the *cognitive* dimension were based on the work of Brakus et al. (2009) and Simon et al. (2013). These items are entirely applicable either in an online or an offline context. For example, the item “this brand makes a strong impression on my visual sense” captures the *sensory* dimension in offline and online settings respectively. The *relational* dimension represents the interactive nature of online brand experience. Since there was no pre-existing pool of items, the authors have developed these based on the theoretical foundations of Schmitt (2009) and Simon et al. (2013). The original pool of items for the *behavioral* dimension was adapted from the typology of Muntinga et al. (2011) who classify users’ website engagement in consuming, contributing and creating. The *usability* dimension contains elements regarding convenience, site navigation and information access based on Preece (2001) and Morgan-Thomas and Veloutsou (2013). *Brand loyalty* consists of attitudinal and behavior components (Dick and Basu, 1994; East et al., 2005; Bandyopadhyay and Martell, 2007). Items of both loyalty dimensions are included. Attitudinal loyalty is measured by “I like the website better among other similar websites” and also by the word-of-mouth dimension “recommend the website to my friends” (Reichheld, 1996). Behavioral loyalty is measured with “I visit the webpage or blog regularly” and “I will purchase the products or service of the brand again”.

All brand experience items and all brand loyalty items are rated on a 5-point Likert scale (1=strongly disagree; 5= strongly agree). A pretest was conducted before distributing the questionnaire. Ten users of qyer.com were asked to take the survey and comment on it. Some of the respondents were interviewed to explain the reasons for problems and misinterpretations, so that ambiguity questions could be modified. Respondents’ suggestions focused mainly on the topic around the understandability of questions. The question “the requirements to run online community software are clear” was dropped from the final survey, because several respondents commented that the statement is unclear.



Table 2 and Table 3 show the items of online brand experience and loyalty in the finally used questionnaire. Besides, the two socio-demographic variables gender and age were included into the questionnaire.

## DATA COLLECTION AND SAMPLING METHOD

Data collection is aimed at the qyer.com consumer target group. Therefore, the survey was posted in the online forum of qyer.com. In addition, we used the high affinity of the target group to online media with a non-probability random snowball sampling and collected data via an online survey. Links to the survey were placed on Weibo and WeChat, the two most popular Chinese social media platforms. According to qyer.com's marketing data, 20% of qyer.com users are Chinese people who study and work outside of mainland China. To reach these users, the survey was also posted on the Facebook groups of Chinese students in Germany and group members were asked to 'share' the link on their 'walls' for greater network effects. Respondents of the questionnaire were asked to 'repost' the survey link via social media platforms to reach their followers. The target population of interviewees includes only Chinese male and female individuals between the ages of 18 and 45 who have access to the Internet and use the online-presence of qyer.com. Data was collected during the dates May 26<sup>th</sup> through to June 15<sup>th</sup>, 2014. The net sample size of the interviewees included 81 participants, of whom 69 persons filled in the questionnaire completely (completion rate = 85%). Of these 69 persons, 55.9% were male and 44.1% were female. The biggest age group was 20 to 29 years covering 62% of the respondents followed by the 30 to 39 years age group covering 32 % respondents.

## RESULTS

The brand experience construct was created by means of a principal component analysis using the items listed in Table 2. According to the original theoretical model of brand experience, results are suggesting a clear factor structure of six factors: *Behavioral*, *Usability*, *Sensory*, *Affective*, *Cognitive*, and *Relational* (total variance explained: 76.3%). Since the value for Cronbach's Alpha is 0.926, the internal consistency of the scale is sufficiently proven. The Kaiser-Meyer-Olkin Measure of Sampling Adequacy is equal to 0.817, all item-based values for Measures of Sampling Adequacy (MSA) are above 0.759, and the p-value of Bartlett's Test of Sphericity is less than 0.0005. These results indicate a very good factor solution (see Table 2).

Brand Experience Dimensions/Items	MSA	Components					
		1	2	3	4	5	6
<b>Behavioral:</b>							
I make comments on the website or the blog	.837	.097	.259	.027	.817	.241	.082
I post my experience (pictures, travel tips) on the website	.839	.087	.193	.167	.783	.288	.144
I participate in the online activities	.824	.037	.160	.339	.796	.023	.233

<u>Usability:</u>							
The pages on the website usually load quickly	.828	.822	.100	.130	-.011	.090	.341
Navigation on the website is consistent and simply	.765	.872	.135	.194	.091	.185	.199
The online functions are easy to understand and use	.828	.878	.010	.213	.176	.207	.042
The web content is easy to read and understand	.792	.779	.056	.169	.029	.308	.117
<u>Sensory:</u>							
I find the website visually impressive	.838	.331	.375	.585	.273	.084	-.146
I like the design of the website (website layout, color ...)	.796	.097	.420	.750	.171	-.055	.015
The animations on the website are dynamic and pleasant	.759	.187	.336	.786	.120	-.091	.045
The pictures on the website are eye catching	.832	.064	.024	.644	-.104	.435	.332
No disturbing advertisement on the website	.766	.318	-.088	.686	.220	.134	.065
<u>Affective:</u>							
The page appeals to my emotions	.876	.132	.649	.197	.218	.331	-.075
I feel secure to purchase through the website	.841	.044	.646	.426	.223	.064	.231
The website evokes my curiosity	.736	-.095	.851	.117	.024	.059	.198
I feel the website inspiring	.745	.138	.795	-.011	.148	.337	.100
I feel the time pass quickly when I browse the website	.793	.162	.738	.260	.264	.086	.058
<u>Cognitive:</u>							
I find the website informative and educating	.871	.162	.100	.108	.273	.736	.223
I find the information valuable and stimulate thinking	.907	.305	.305	.171	.218	.645	.196
I have gained a better understanding about the offers	.819	.329	.229	-.083	.082	.693	.044
<u>Relational:</u>							
The users of the website (brand) share a similar lifestyle	.851	.345	.399	.122	.420	-.168	.477
The users of the website (brand) share a similar interest	.847	.248	.337	.025	.183	.433	.620
The users can get in contact with other users though the website	.838	.358	.156	.059	.157	.466	.583
The users can create groups or initiate activities though the website	.790	.361	.064	.120	.320	.229	.756
Kaiser-Meyer-Olkin Measure of Sampling Adequacy.	.817						
Bartlett's Test of Sphericity	Approx.	Chi-Square:df=276			Sig: .000		
	1164						

Note: Extraction Method: Principal Component Analysis. Rotation Method: Varimax with Kaiser Normalization. Rotation converged in 10 iterations.

Table 1. Table 2: Rotated Component Matrix for all online brand experience items

The principal component analysis was also conducted for all items of the *Loyalty* dimension. The analysis yields a single component with an eigenvalue greater than 1. The internal consistency of the scale is sufficiently proven (Cronbach's  $\alpha=0.826$ ). All item-based values for Measures of Sampling Adequacy (MSA) are ranging from 0.736 to 0.848. The Kaiser-Meyer-Olkin Measure of Sampling Adequacy (0.773) and the Bartlett's Test of Sphericity (p-value <0.0005) are indicating a very good factor solution (see Table 3).

	MSA	Component Coefficient Matrix	Score
Cronbach's Alpha	.826		
KMO	.773		
Bartlett's Test of Sphericity (Sig.)	.000		

Initial Eigenvalue	2.694	
% Variance initial eigenvalues	67.344%	
I like the website brand better among other similar websites	.782	.312
I recommend the website to my friends	.736	.334
I visit the website or blog regularly	.776	.329
I will purchase the products or service of the brand again	.848	.233

Note: Extraction Method: Principal Component Analysis.

Table 2. Table 3: Rotated Component Matrix for all loyalty items

In order to estimate the multivariate influence of the different online brand experience factors, age and gender on the brand loyalty of qyer.com, Ordinary Least Square Regressions were used. As limited web functionality is a key source for online dissatisfaction (Constantinides, 2004) we included in a first regression model – beside the six main online experience factors, gender and age – five additional cross-product terms: Each of the five brand experience factors were separately crossed with the *Usability* factor to capture the interaction between website usability and the different brand experience factors. However, none of the cross-products reveal a significant influence on the brand loyalty (see model (1) in Table 4). The same picture of insignificance emerges with the socio-demographic variables gender and age (see model (1) and model (2) in Table 4). Both variables do not exert any statistically proven influence on brand loyalty.

In the final regression analysis (see model (3) in Table 4), the authors included only the main effects of the six online brand experience factors – which are *Behavior*, *Affective*, *Usability*, *Sensory*, *Cognitive* and *Relational*: Around  $R^2=50.8\%$  of the variance of the brand loyalty can be explained by these six independent variables. All of them are statistically significant either on the one percent (*Behavior*, *Affective*, *Sensory*, *Cognitive*, and *Relational*) or the five percent (*Usability*) significance level. The biggest brand online experience factor in explaining the variance of brand loyalty is been covered by the brand experience factor *Affective* (26%). It is followed by *Behavior* (21%), *Sensory* (15%), *Cognitive* (14%), *Relational* (13%) and the hygiene factor *Usability* (11%). In summary it can be concluded that Hypothesis H1 and all Sub-Hypotheses (H1.1 to H1.6) are verified.

Dependent Variables	Type of variable	OLS-Regression: Dependent Variable: Loyalty		
		(1)	(2)	(3)
(Constant)		-0.232 (0.572)	-0.295 (0.521)	1.44E-16 (0.083)

Behavior	Continuous	0.371** (0.093)	0.362** (0.085)	0.363** (0.084)
Affective	Continuous	0.408** (0.101)	0.414** (0.089)	0.447** (0.084)
Usability	Continuous	0.187 (0.099)	0.211* (0.097)	0.190* (0.084)
Sensory	Continuous	0.253** (0.094)	0.265** (0.086)	0.252** (0.084)
Cognitive	Continuous	0.239* (0.093)	0.257** (0.085)	0.244** (0.084)
Relational	Continuous	0.255 (0.095)	0.256** (0.088)	0.228** (0.084)
Behavior x Usability	Continuous	-0.033 (0.117)		
Affective x Usability	Continuous	-0.025 (0.089)		
Sensory x Usability	Continuous	0.019 (0.103)		
Cognitive x Usability	Continuous	-0.021 (0.102)		
Relational x Usability	Continuous	0.061 (0.107)		
Age	Continuous	0.012 (0.020)	0.014 (0.019)	
Gender (female=1)	Dummy (0/1)	-0.206 (0.198)	-0.204 (0.189)	
Adjusted R2		0.467	0.504	0.508
R2		0.567	0.563	0.551
F		5.548**	9.652**	12.680**
VIF		<1.622	<1.242	=1.000
Obs.		69	69	69

Note: \*\* significance at the 1% level; \* significance at the 5% level.

Table 3. Table 4: Effects of different online brand experience dimensions on brand loyalty

## CONCLUSIONS

The empirical study has revealed a positive impact of online brand experience on brand loyalty. Overall, affective brand experience has the highest impact on brand loyalty (with the highest standardized regression coefficient), closely followed by behavioral brand experience. The impact of sensory, cognitive and relational brand experience is slightly lower. Usability shows the lowest but still significant impact. These results show that affective brand experience is most effective in creating

brand loyalty. Online experiences that appeal to customers' inner feelings, moods and emotions can create a strong bond with the brand. Qyer.com manages with its colorful pictures, travel tips and destination descriptions to inspire users and to create a special mood and feeling. Based on our results, behavioral brand experience shows the second largest impact on brand loyalty. Behavioral brand experience gives people ideas about alternative behavior or alternative lifestyles. The online presence of qyer.com succeeds in showing consumers an escape from their daily working routine by traveling to foreign destinations. Schmitt (1999) states that behavioral experiences can be triggered by rational approaches. However, they are usually most successful if they are "motivational, inspirational and emotional in nature" (Schmitt, 1999). Qyer.com's product is per se a very emotional product since people seek indulgence and physical experiences when traveling. Although the website has only an online presence and no physical attendance, the content with its colorful pictures, descriptions of sights and reports about travel experiences proves that it can create a similar experience in the virtual as in the real world. This is also enhanced by the possibility of users to make comments on the website and to post own experiences online. Besides the large impact of affective and behavioral brand experience on brand loyalty, sensory, relational and cognitive brand experiences impact brand loyalty as well, but to a lower extent. The fact that sensory brand experience is lower than affective and behavioral brand experience can be explained by the nature of the qyer.com website. The website uses mainly pictures as sensory stimuli. Videos, podcasts or games are not used on qyer.com at all. That might lower the experience and hence, the brand loyalty. However, it is rather surprising that the relational brand experience has a lower impact on brand loyalty, since the nature of the website is based on users getting in contact with each other and sharing similar interests. However, the results prove that the interactivity with other users plays a less significant role than moods and feelings as well as the prospect of travelling. These elements seem to be most important when it comes to create loyalty. Cognitive brand experience has a rather low impact on brand loyalty. Although the website features mostly emotional elements (pictures, postings), it also contains some cognitive elements, such as hotel booking options, downloadable travel guides or detailed travel itineraries. Users appreciate these more cognitive offerings, but it does not have the same impact on their brand loyalty as affective and behavioral elements. Qyer.com is aimed to create a rather emotional brand experience and transport feelings, rather than giving fact-based information about travel itineraries or prices. And this seems to be most effective in creating brand loyalty. The lowest but still significant impact on brand loyalty has usability. This was expected since usability is rather a hygiene factor which means that a certain level of usability is a 'must' and expected by the customer. But it does not have the same potential of creating brand loyalty like the brand experience elements. As a result, it can be concluded that an online travel

website like qyer.com has the largest potential to create loyalty by providing affective and behavioral experiences online.

## LIMITATIONS

This study analyzed the impact of online brand experience on brand loyalty for qyer.com in China. The first limitation to the validity of this research report is the applied sampling method. Firstly the survey was distributed over qyer.com's online forum. However, it was also circulated over a non-probability random snowball sampling. This may lead to the limitation that results are heavily influenced by the choice of initial seeds and by the first contacts within the sampling process. Results probably tend to be biased towards favoring more cooperative as opposed survey participants and to those that are part of larger personal networks (Magnani et al., 2005). The volunteer effect through the self-selection of participants cannot be ruled out and methods of inferential statistics may produce non-generalizable results.

Secondly, the study focused on the Chinese market and due to cultural differences the findings cannot be transferred easily to other countries. Future research should focus on possible cross-cultural differences to develop a deeper understanding of the influence of online brand experience on brand loyalty. A third limitation is that the findings are limited to qyer.com (and for other similar online travel sites), but cannot be generalized for travel or other service companies. Further research could therefore analyze other industries. At last, this research is conducted as a cross-sectional study which involves observation of a representative subset at a defined time. For further investigation, a longitudinal study that involves repeated observations of the same items over a longer period of time is suggested.

## REFERENCES

- Bandyopadhyay, S. and Martell, M. (2007), "Does attitudinal loyalty influence behavioral loyalty? A theoretical and empirical study", *Journal of Retailing and Consumer Services*, Vol. 14 No. 1, pp. 35-44.
- Brakus, J.J., Schmitt, B.H. and Zarantonello, L. (2009), "Brand experience: What is it? How is it measured? Does it affect loyalty?", *Journal of Marketing*, Vol. 73 No.3, pp. 52-68.
- Chu, G., Cleff, T. and Walter, N. (2013), "Brand experience's influence on customer satisfaction and loyalty: a mirage in marketing research?", *International Journal of Management Research and Business Strategy*, Vol. 2 No. 1, pp. 130-144.
- Cleff, T., Lin, I. and Walter, N. (2014), "Can you feel it? The effect of brand experience on brand equity", *IUP Journal of Brand Management*, Vol. 11 No. 2, pp. 7-27.
- Constantinides, E. (2004), "Influencing the online consumer's behavior: The Web experience", *Internet Research*, Vol. 14 No. 2, pp. 111-126.
- Csikszentmihalyi, M. (1990), "Flow: The Psychology of Optimal Experience", Harper and Row, New York, NY.
- Csikszentmihalyi, M. (1997), "Finding Flow: The Psychology of Engagement with Everyday Life", Basic Books, New York, NY.
- Day, G.S. (1969), "A two-dimensional concept of brand loyalty", *Journal of Advertising*, Vol. 9 No.3, pp. 29-35.

- Dholakia, U.M., Bagozzi, R.P. and Klein Pearo, L. (2004), "A social influence model of consumer participation in network- and small-group-based virtual communities", *International Journal of Research in Marketing*, Vol. 21 No. 3, pp. 241-263.
- Dick, A.S. and Basu, K. (1994), "Customer loyalty: towards an integrated framework", *Journal of the Academy of Marketing Science*, Vol. 22 No. 2, pp. 99-113.
- East, R., Gendall, P., Hammond, K. and Lomax, W. (2005), "Consumer loyalty: Singular, additive or interactive", *Australasian Marketing Journal*, Vol. 13 No. 2, pp. 10-26.
- Fransen, M. and Lodder, P. (2010), "The effects of experience-based Marketing communication on brand relations and hedonic brand attitudes: The moderating role of affective orientation", *Advances in Consumer Research*, Vol. 37, pp. 801-802.
- Gentile, C., Spiller, N. and Noci, G. (2007), "How to sustain the customer experience: An overview of experience components that co-create value with the customer", *European Management Journal*, Vol. 25 No. 5, pp. 395-410.
- Ha, H.Y. and Perks, H. (2005), "Effects of consumer perceptions of brand experience on the web: brand familiarity, satisfaction and brand trust", *Journal of Consumer Behavior*, Vol. 4 No. 6, pp. 438-452.
- Hirschman, E.C. and Holbrook, M.B. (1986), "Expanding the ontology and methodology of research on the consumption experience", in Brinberg, D. and Lutz, R.J. (Eds.), *Perspectives on Methodology in Consumer Research*, Springer, New York, NY, pp. 213-251.
- Hoffman, D.L. and Novak, T.P. (1996), "Marketing in hypermedia computer-mediated environments: conceptual foundations", *Journal of Marketing*, Vol. 60 No. 3, pp. 50-68.
- Holbrook, M.B. and Hirschman, E.C. (1982), "The experiential aspects of consumption: Consumer fantasy, feelings and fun", *Journal of Consumer Research*, Vol. 9 No. 2, pp. 132-140.
- Jin, B. and Park, J.Y. (2006), "The moderating effect of online purchase experience on the evaluation of online store attributes and the subsequent impact on market response outcomes", *Advances in Consumer Research*, Vol. 33 No. 1, pp. 203-211.
- Lin, A., Gregor, S. and Ewing, A. (2008), "Developing a scale to measure the enjoyment of web experience", *Journal of Interactive Marketing*, Vol. 22 No. 4, pp. 40-57.
- Lofman, B. (1991), "Elements of experiential consumption: An exploratory study", *Advances in Consumer Research*, Vol. 18 No. 1, pp. 729-735.
- Luo, M.M., Chen, J.-S., Ching, R.K.H. and Liu, C.-C. (2011), "An examination of the effects of virtual experiential Marketing on online customer intentions and loyalty", *The Service Industries Journal*, Vol. 31 No. 13, pp. 2163-2191.
- Magnani, R., Sabin, K., Saidel, T. and Heckathorn, D. (2005), "Review of sampling hard-to-reach and hidden populations for HIV surveillance", *AIDS*, Vol. 19 Suppl. 2, pp. 67-72.
- Mathwick, C. and Rigdon, E. (2004), "Play, flow, and the online search experience", *Journal of Consumer Research*, Vol. 31 No. 2, pp. 324-332.
- Morgan-Thomas, A. and Veloutsou, C. (2013), "Beyond technology acceptance: Brand relationships and online brand experience", *Journal of Business Research*, Vol. 66 No. 1, pp. 21-27.
- Morrison, S. and Crane, F.G. (2007), "Building the service brand by creating and managing an emotional brand experience", *Journal of Brand Management*, Vol. 14 No. 5, pp. 410-421.
- Mortimer, R. (2009), "Getting the right attention", *Brand Strategy*, December, p. 55.
- Muntinga, D.G., Moorman, M. and Smit, E.G. (2011), "Introducing COBRAs: Exploring motivations for brand-related social media use", *International Journal of Advertising*, Vol. 30 No. 1, pp. 13-46.
- Novak, T.P., Hoffman, D.L. and Yung, Y.-F. (2000), "Measuring the customer experience in online environments: a structural modelling approach", *Marketing Science*, Vol. 19 No. 1, pp. 22-42.
- Pine, B.J. and Gilmore, J.H. (1998), "Welcome to the experience economy", *Harvard Business Review*, Vol. 76 No. 4, pp. 97-105.
- Poulsson, S. and Kale, S. (2004), "The experience economy and commercial experiences", *The Marketing Review*, Vol. 4 No. 3, pp. 267-278.
- Prahalad, C.K. and Ramaswamy, V. (2004), "Co-creation experiences: The next practice in value creation", *Journal of Interactive Marketing*, Vol. 18 No. 3, pp. 5-14.
- Preece, J. (2001), "Sociability and usability: Twenty years of chatting online", *Behavior and Information Technology Journal*, Vol. 20 No. 5, pp. 347-356.
- Reichheld, F.F. (1996), "The Loyalty Effect", Harvard Business School Press, Boston, MA.
- Rose, S., Clark, M., Samouel, P. and Hair, N. (2012), "Online customer experience in e-retailing: An empirical model of antecedents and outcomes", *Journal of Retailing*, Vol. 88 No. 2, pp. 308-322.
- Sands, S., Oppewal, H. and Beverland, M. (2008), "The influence of in-store experiential events on shopping value perceptions and shopping behaviour", *Advances in Consumer Research*, Vol. 35, pp. 298-303.

- Schmitt, B.H. (1999), "Experiential marketing", *Journal of Marketing Management*, Vol. 15 No. 1-3, pp. 53-57.
- Simon, C., Brexendorf, T.O. and Fassnacht, M. (2013), "Creating online brand experience on facebook", *Marketing Review St. Gallen*, Vol. 30. No. 6, pp. 50-59.
- Tsaur, S.H., Chiu, Y.T. and Wang, C.H. (2006), "The visitors behavioral consequences of experiential marketing: An empirical study on Taipei Zoo", *Journal of Travel and Tourism Marketing*, Vol. 21 No. 1, pp. 47-64.
- van Noort, G., Voorveld, H. and van Reijmersdal, E.A. (2012), "Interactivity in brand web sites: Cognitive, affective, and behavioral responses explained by consumers' online flow experience", *Journal of Interactive Marketing*, Vol. 26 No. 4, pp. 223-234.
- Yoo, B. and Donthu, N. (2001), "Developing and validating a multidimensional consumer-based brand equity scale", *Journal of Business Research*, Vol. 52 No. 1, pp. 1-14.
- Zaltman, G. (2003), "How consumers think: Essential insights into the mind of the market", Harvard Business School Press, Boston, MA.



## HOW LEAN GLOBAL START-UPS SELECT THEIR PRICING STRATEGIES, PRACTICES AND MODELS

Cohen, Benjamin; Neubert, Michael

ISM International School of Management, Paris, France

### ABSTRACT

This article analyses the research problem of price-setting strategies for product innovations in the medtech industry. It is based on the conceptual framework of price-setting practices, strategies, and models. A multiple case study research is then performed on six medical technology companies, focusing on how they set their initial product price for a new technology solution to either existing medical conditions or technology limitations. The research results show that medtech companies opt for competition-informed price practices and buy pricing models. The pricing strategies vary between skimming and market-based pricing strategies. Price innovations are limited due to regulation and financial considerations.

*Keywords: Price-Setting, Pricing Practice, Pricing Strategy, Pricing Model, Medtech*

### INTRODUCTION

Price-setting for any new product is crucial in determining its future in the market. After years of research and development (R&D), product design, testing, market research and marketing, the first real interaction a product has with the customer is through its price. It is not the idea of how its utility will benefit the customer nor the vision and excitement given about how things will change. Those are unrealized expectations preserved until after the customer has ownership. The price is the real, hard currency promise of what this product will mean to the customer.

There is a great need for all companies to understand and optimize their pricing strategy. Price-setting determines a company's profit margin as well as market share; the ease in making sales or the difficulty in gaining adoption. It is perceived as a profit opportunity invitation to future competition and a territorial grab to existing competitors. Marn and Rosiello (1992) studied the economic parameters of 2,463 companies and found that a 1% improvement in price yielded an 11.1% improvement in operating profit, all else being equal. This compared dramatically high as compared to a 1% improvement in either the variable costs, sales volume, or fixed costs, which yielded operating profit gains of 7.8%, 3.3%, and 2.3%, respectively.

With the possibility of any product or industry to focus on, this paper has chosen the medical technology (medtech) industry. This focus has been chosen because of the amount of money spent on

R&D investment, the rapid advancements made in recent years, the growing worldwide demand in advanced medtech products, and the absence of existing research. Further, medtech products often consist of physical products, consumables, and services, the combination of which increases the pricing complexity.

Medtech companies are providing cutting-edge technologies to patients, hospitals, and care providers around the world. It would appear that as the world becomes more interconnected toward a single common marketplace, the faster the rate of technological development becomes. With an increasing rate of technological development at the same time as larger customer exposure, greater necessity is placed on a medtech company entering new markets with the correct marketing and pricing strategies.

The purpose of this study is to identify various international pricing strategies and models used in real world companies. From this selection, comparison can be made of their relative strengths and proper implementation. The problem in this research is that international pricing decisions are more complex than domestic, frequently incurring currency value swings, differing inflationary pressures and difficulty in having production facilities in different markets, which leads to frequent price reviews (Hollensen, 2014).

This study has been performed in part by the call for research from Ingenbleek, Frambach, and Verhallen (2013). In their paper they call for further research on existing pricing processes with the intent of applying them toward optimal application for new product development. Thereto, it is suggested to address this need through qualitative research methods such as multiple case study research.

## **LITERATURE REVIEW AND THEORETICAL FRAMEWORK**

Successful price-setting strategies and models can be derived from a large number of literature sources centered on either the conceptual derivation or empirical results. However, sources of failure risk are often more easily learned from case studies found in literature research. In short, the success and failure risk factors relevant to bringing a new product to market can be generalized as originating from either the product, company, competition, customer, international market complexity, or new sub-industry oriented focus. Evidence for each of these focuses is found in a selection of recently published literature.

Price-Setting Practice	Prices Based On ...
Value-informed pricing	Customers' perceptions of the benefits that the product offers and that they trade off against the price
Competition-informed pricing	Competitors' prices relative to their market positions
Cost-informed pricing	Variable, fixed, direct, and indirect costs for developing, producing, and marketing the new product or service
Price-Setting Strategy	Prices Based On ...
Skimming	The market segment with the highest reference price is targeted first, and the market is subsequently skimmed to capture segments with lower reference prices
Market pricing	Price influences market share
Penetration pricing	Set a low price in attempt to stimulate product adoption
Non- Price-Setting Strategy	Prices Based On ...
Selecting price models	Not all purchasing options available for customers
Price negotiation w/ customer	List price minus customer-specific discounts
Bundling	Discounted price when multiple products or services purchased
Upgrades / Trade-ins	Discounted price when an older model/version is exchanged
Captive finance companies	Purchasing price dependent on financing terms
Pricing Model	Revenue Based On ...
Buy	One-time payment
Lease / Rent	Recurring monthly/yearly payments
Lease back	Real estate: sale of asset, lease/rent back from buyer (takes the form of a loan)
Pay-per-use	Pay for each use, do not pay for on-site location or maintenance
Combination buy & use	<ul style="list-style-type: none"> <li>✓ Sale of product, plus recurring payments for service and non-reusable components</li> <li>✓ Recurring payments comprised of lease/rent, service, and non-reusable components</li> </ul>
Recurring	
Reimbursement	Government payer reimbursement of costs, smaller immediate patient copay
Auction	Highest bidder
Dynamic / Time-based	Price changes as a function of time and supply/availability
Remanufactured	Used goods refurbished or remanufactured and sold as new or lower quality
Second hand	Used goods resold on secondary market
Remarketed	Unsold goods being sold for a different purpose

Table A2: Definition of price-setting practices, strategies, and pricing models used (e.g. Hollensen, 2014; Ingenbleek, Frambach & Verhallen, 2013)

### *Product-Oriented*

Product expectation from customers of a new product's performance should be adequately met by appropriate price-setting strategies. Proper pricing leads to a balance between the product's usefulness and the expectations placed on it from consumers. Ingenbleek et al. (2013) find that inappropriate selection of price-setting practices can counter the positive advantages of new product development. By pricing a product high, customers will have high initial expectations for quality, durability, application, and ease of use, among others, which the product must fulfill. Customer opinion may begin to undervalue the benefit it brings by comparing it with the standards applied to other products at similar prices. Undervaluing a product decreases the consumer confidence in performance and durability, as well as pride of ownership. The consumer is only content when the balance between cost and benefit is met. This selection of a pricing strategy is therefore dependent on the relative level of product advantage, intensity of competition, and relative product costs. This multiple case study research uses the theoretical framework of Ingenbleek et al. (2013) to analyze the pricing strategies of medtech companies.

Specifically, for a new product entering an existing market or creating a new market, value-informed pricing strategy provides the greatest support for a product's pricing strategy. After this, competition-informed pricing adds substantially in situations where competitive intensity is low, whereas cost-informed pricing helps when competitive intensity is high. Likewise, managers pursuing a profit margin objective should express the advantage of their product, thus using value-informed pricing while avoiding cost-informed pricing. In total, Marn, Roegner, and Zawada (2003) estimate 80-90% of new products brought to market are priced too low, and consequently reach a smaller market size and level of profitability than is possible. This has significant negative effects on the company's revenue stream by decreasing short-term profit as well as long-term customer confidence and loyalty (Lowe and Alpert, 2010).

Lowe and Alpert (2010) identified a clear causal effect for the pioneer's price-setting decisions on product price and value perceptions, whereas a follower company's product price seemed to influence perceptions of the follower, not the pioneer. These findings imply that reference price is brand specific, and that the pioneer, due to its proto-typicality, has a stronger influence on reference price perceptions than the follower. However, these effects were stronger for the more innovative product categories being examined.

Online distribution channels greatly increase price transparency, which leads to reduced price differentials between countries and a global standardization of prices (Gorodnichenko and Talavera, 2016). Prices in online markets have been found to change faster than in traditional stores, including a higher pass-through of exchange rate fluctuations. These changes depend on the products and on market conditions such as level of competition.

Specifically, for medical devices, the clinical trial procedure is found to be the best way to estimate a product's cost effectiveness for future customers (Kirisits and Redekop, 2013). These trials are able to reach a broad and diverse range of potential customers with varying levels of severity of the condition being targeted by the new product. From these trials, the performance of the device and degree of benefit can be identified and weighed against its ease of use and any potential harms. The degree of rigor and completeness to these clinical trials is the best way to forecast its acceptance by the public.

#### *Company-Oriented*

When a firm develops a high-technology product filling a small market niche, its full potential needs to be quickly exploited in order to generate sufficient revenue needed to cover its R&D costs, to finance growth, and to offer competitive prices (Neubert, 2015; Trudgen and Freeman, 2014). Therefore, significant product growth is necessary, as well as creating and completing the product's distribution path to the public. Proper relationships with the company's supply chain as well as distributors,

import/exporters, and retailers is critical as the performance of one company will depend on the performance of the entire chain (Wei and Zhao, 2014).

Luostarinen and Gabrielsson (2006) studied 89 companies in Finland who became international within their first three years, and thusly named born global companies (Neubert, 2015). They found that these companies often bypassed cost-informed pricing (setting a product's price floor) by choosing below-cost pricing for their first international customer, and thereafter applying value-added pricing based on the benefits brought to its customers. This method was found to be hugely beneficial to the company creating the product in terms of creating the first international partnership, acquiring initial market share, and finding a more optimal partnership that conveyed confidence in customers not already familiar with the manufacturing company. This brings compounded returns in the form of additional business being brought-in more easily.

Even before focusing on the product and customers, the best qualities of successful lean start-up companies have been identified as controlling overhead costs and to automate as many of the company procedures as possible (Grohn et al, 2015). These actions are often indicative of proper cost-control efforts set by the management, and a focus on the bottom line. Examples of such efforts include the purchase of used equipment, or to negotiate with vendors and suppliers after a more thorough market research of asking prices.

#### *Competition-Oriented*

Knowledge of the pricing strategies, product development, and marketing practices of a company's competitors leads to greater positioning of a company within the overall market. Success of any product originates from one or more advantages that it has over other available product options. Kuznetsova and Roud (2014) performed an industry survey among Russian manufacturing firms to rate their relative company advantages as compared to their competitors. From the results, they found that the highest perceived advantage of the survey respondents' companies was product quality over their competitors, with 76% of respondents believing in their own company produced products at higher quality as compared to 17% of respondents believing in their competitor's product quality advantage. The next largest discrepancy in perspectives was of fast, on-time delivery, in that 43% believed their company had the advantage as compared to 9% giving advantage to their competitors. Roughly 6% of respondents believed that their company possessed no competitive advantages at all, whereas 30% believed that the competitors possessed no advantages. The survey results showed roughly even match between the respondents' company and its competitors in the categories of price, cutting-edge products, adaptation to consumer needs, and service.

Placement of one product helps the product and company succeed in the short-term. However, long-term planning and investment in product improvements and further technological advancement is

vital in assuring continual benefit from the product line. Copeland and Shapiro (2015) found that continual and significant innovation increases the competitive advantage of a product, thus leading to higher prices for the innovator. The constant reworking and renewal of a product's strengths, capacities, and features creates a moving barrier to entry for competitors. Likewise, slower rates of innovation make the retail market more competitive, leading to decreasing company markups and profits.

#### *Customer-Oriented*

No greater entity exists for the protection of customers' best interests than the multitude of government sponsored healthcare programs around the world, and assuring patient safety as well as cost control from healthcare providers are the top two priorities. Specifically relating to overall cost, Gobbi and Hsuan (2015) determined that nearly 65% of the public sector in the US medical industry used collaborative purchasing (CP) power in 1995 to reduce the price of complex medical equipment purchases. They found that purchase of said equipment equates to the largest portion of total expenditure in the realm of healthcare. Because the healthcare providers (predominantly hospitals) have strikingly similar requirements of the machines, equipment, and devices purchased, the potential for CP to decrease overall costs is high. Proper purpose and functionality for the customer must be addressed in order to gain customer adoption of a new technology, as more often than not the needs of customers create the product opportunities for companies. Specifically, for medtech companies, aging demographics and increasing availability to modern medicine for most of the world have created significant growth opportunities. For example, the leading healthcare demands within the United States include decreasing costs, patient safety, personalized care, and advanced cancer research (Deloitte, 2016). Compare that with the Gulf Cooperation Council (GCC) states where healthcare concerns stem from the region's increasing population, which include lifestyle diseases (including ischemic heart disease, stroke, type 2 diabetes and obesity), high incidence of road traffic accidents, and consanguinity (Howard, 2014).

Other countries have made medical tourism a primary focus for the growth of their economy. Such countries as Thailand, Singapore, India, Jordan, Turkey, and the United Arab Emirates have each incurred rapid growth in their healthcare infrastructure in order to satisfy their growing domestic markets as well as attract the international patients (Ebrahim and Ganguli, 2017). These countries aim to benefit from increased demand for the healthcare products and services beyond the level of domestic demand. This effectively causes the hospitals, retailers, and healthcare providers to increase their customer base without the need for export/import concerns and costs.

#### *Foreign Market Complexity Oriented*

International expansion of a company is a significant milestone in its global growth and capture of market share. Yet for many companies this step proves to be a substantial inhibitor to smooth progress. The benefits of an increase in potential customer base are offset by increased costs burdened by consumers, additional governmental regulation and safety controls, cultural or language difficulties, and increased competition. This market adaptation includes a revision of pricing decisions (Neubert, 2016b).

Therefore, entry into a foreign market is only possible after extensive analysis of the market factors and competition (Neubert, 2013). Pricing decisions require regular reviews and structured decision-making processes in order to prepare for and mitigate disturbances caused by changes in foreign competition, currency exchange fluctuation, and inflationary pressures (Snieskiene and Cibinskiene, 2015). Thereto, exporting companies have been found to experience greater rate of success depending on the relationship and partnerships formed with importers (Obadia and Stöttinger, 2015). Exporters can increase the performance of their importers through their pricing strategies, especially by allowing higher margins or other incentive schemes. In response, importers then invest in the products where they can expect the best results, predominantly based on the marketability and the price margin.

Creation of a new product market or niche comes with the significant advantage in that high-tech firms have a high price-setting power to set the reference price for their new product categories. New niche creation has historically come with roughly one to two years of market control before competitor companies can technologically catch up (Lowe and Alpert, 2010). This advantage is substantially decreased in foreign markets that don't enforce patent protection. Geng and Saggi (2015) analyzed pricing strategies of patented (e.g. pharmaceutical) products sold into markets without patent protection, and found that local competition was quickly generated. Such presence led to price competition for market share, meaning lower mark-ups and profitability.

## RESEARCH METHOD

A multiple case study research method shall be used in order to best compare and contrast existing pricing strategies used by medtech companies. This study uses a multiple case study research design to answer the explanatory (why and how) research questions (Yin, 2014). According to Hennart (2013), a qualitative comparative case study research would help to answer the research question. In contrast to an experimental design or a survey, a multiple case study has more flexibility (Stake, 1995), allows an in-depth analysis of a complex research problem within a highly contextualized environment (Rosenberg and Yates, 2007), and a comparison between different cases (Baxter and Jack, 2008; Eisenhardt and Graebner, 2007).

The medical industry in general is a very difficult but interesting industry to identify pricing strategies, particularly within the United States and other countries with large governmental healthcare payer systems. In most countries within the Organization for Economic Cooperation and Development (OECD) the majority of prices for medical services, equipment and prescription drugs are fixed, or set in reference to these government-established reference prices (Brandt, 2013). In the US, it is commonly known as the Centers for Medicare & Medicaid Services (CMS) billing rates. Therefore, the new medtech companies are principally targeting technology innovations not currently outlined in these governmental payer systems.

## **SAMPLING**

The choice of the sampling strategy is based on the purpose of this study. This study uses a purposive case selection strategy (Seawright and Gerring, 2008), because it produces a representative sample with typical (Gerring, 2006) and successful examples of the total population. According to Yin (2014), this sampling strategy produces a statistically representative sample, if at least six to ten cases are selected. This study uses a sample size of six case study firms to allow a better triangulation of data and to strengthen the results of the whole study.

The six case study firms, EnteroMedics, Alphatec Spine, Inogen, Skyline Medical, GE Healthcare, and Intuitive Surgical, are born-global firms using the global exporter business model (Neubert, 2016a). These companies are all publicly traded companies (5 on NASDAQ, GE on NYSE), with market capitalization ranging in size from \$8 million to \$260 billion. Five of the six companies specialize uniquely within the medical equipment and supplies industry, while GE is a multinational conglomerate with exposure in a broad range of industries. This sample was determined sufficient for the study due to the breadth of pricing strategies and models identified between them.

## **RESEARCH QUESTIONS**

The statement of the research problem has led to the following two research questions:

1. What pricing strategies and models are currently being implemented in the medtech industry?
2. Where are the observed differences and benefits between the pricing strategies and models?

## **RESEARCH FINDINGS**



Through researching dozens of companies, it was found that a company cannot state outright its pricing strategy. This is firstly because the terms and definitions of pricing strategies and models are in no way standardized, and secondly because in doing so a company may substantially weaken its market position and brand quality, inviting in new competitors. Therefore, inferences must be made as to why and how a company chose its pricing models. In order to make such inferences, enough detailed information must be revealed about a company's product line revenues and costs, thus leading the research to focus on publicly listed companies on US stock exchanges.

*Findings RQ 1: What pricing strategies and models are currently being implemented in the medtech industry?*

The companies of EnteroMedics, Alphatec Spine, and Inogen were researched, each belonging to a different specialty sector within the healthcare field. EnteroMedics manufactures its Maestro device that uses its neuroblocking technology known as vBloc Therapy to treat obesity, metabolic diseases, and other gastrointestinal disorders (EnteroMedics, 2016). Alphatec Spine manufactures a variety of products for the surgical treatment of spine disorders (Alphatec Spine, 2017). Inogen specializes in the design, manufacturing and marketing of portable oxygen concentrators for patients necessitating oxygen therapy (Inogen, 2017).

Table 2: Price-setting practices, strategies, and models for the case study companies

The first finding is that each case study company bases their product pricing in the US on the CMS billing rates (compare to table 2). By doing so, the prices are thus established by the US Medicaid reimbursement rates, meaning a competition-informed price-setting practice. Therefore, the price-setting strategy of all companies is that of market pricing. Each company additionally operates primarily under the buy only pricing model, with Inogen mentioning the service segment of their business generating significant revenue.

Skyline Medical is a company specializing in the collection and disposal of infectious fluids that result from surgical procedures and post-operative care (Skyline Medical, 2017). Their principle focus is the Streamway System, with features such as automated measurement of volumes, prevention of cross-contamination, and a tissue trap that allows for tissue retrieval. Disclosed in their 2015 annual report, Skyline implies that their pricing strategy is one of penetration pricing, specifically singling-out their competitor Stryker Instrument's comparable system and citing notable differences (Skyline Medical, 2016). The significant differences mentioned are a 33% savings in device purchase price, an industry common installation process that can be performed by distributors, independent contractors, or customer in-house engineering, as well as underpricing the disposable kit needed for each patient operation by \$1. Therefore, the pricing practice detailed in the report is that of competition-informed, although undoubtedly an underlying degree of cost-informed practice evaluated to set their product

price floor. The company's pricing model is dominantly through the sale of the Streamway units, with the sale of non-reusable filters and cleaning solutions making up a smaller revenue component.

General Electric (GE) is a global conglomerate company with divisions in the aviation, power generation, electricity distribution, healthcare, oil and gas, transportation, household appliances, and financial industries (GE, 2016). In researching cutting-edge medtech technologies, the recent 3.0-tesla (3T) magnetic resonance imaging (MRI) machines developed at GE were identified as being cutting-edge technology in terms of their magnet strength, bore size, and quieter running status. However, pricing information was discovered only through distributors and then only from contact with sales associates. Consequently, a previous model, the 1.5-tesla (1.5T) LX MRI, was found with sufficient pricing information.

Not only had the 1.5T machines been sold initially at higher prices only to be lowered in time with increased competition from other companies and technologies, but sales were initially only available through GE authorized dealers, later opening up to affiliates and then third party vendors. From uncovering the historical change in pricing as well as sales practices, it is evident that GE uses value-informed price-setting practices to establish skimming price-setting strategies for its MRI products. GE does offer both the sale and lease of its MRI units, although not all vendors offer a leasing option. Undoubtedly, GE must have developed this pricing strategy through years of experience in the healthcare as well as other industries in order to maximize returns to the company.

The sixth and final case study included in this report is from Intuitive Surgical (Intuitive). They manufacture the da Vinci Surgical System used in robotic surgeries, along with related instruments and accessories (Intuitive, 2016). Being a young and ambitious medtech company listed publically, Intuitive has disclosed the largest amount of pricing information found for this research. In their annual report, Intuitive defines their business strategy priorities all in relation to value to its customers; patient, surgeon, and hospital. With the customer in mind, Intuitive has focused their product technology and further improvements on maximizing the value of the system for its customers, primarily through conversion of standard open surgeries to be compatible with the da Vinci system, to better train surgeons for a larger range of complex minimally invasive surgeries (MIS), and to develop procedures that could convert multiport laparoscopic surgeries into single port surgeries. In all, it is clear that Intuitive employs a value-informed price-setting practice.

Intuitive lists the revenue streams in 2015 from the sale of its surgical systems, sales-type and operating lease options, annual service plan, as well as the non-reusable or gradually degrading instruments and accessories. An impressive 492 robotic systems were sold in 2015, yielding 30% of their annual profits, with another 63 systems delivered to customers under lease terms, yielding less than 1% of profits. On top of that were a combined total of 3,597 systems in use and covered under annual service contracts,

bringing in 19% of 2015 profits, but most substantially was the sale of non-reusable or replacement instrument and accessories, equaling over 50% of the annual profits. From this information it is clear that Intuitive primarily employs a buy and use pricing model, with a much smaller percent of clients choosing the leasing option of a recurring pricing model.

Also in the annual report are the ranges of prices charged to its customers for the da Vinci Surgery System, the annual service agreements, and the non-reusable or gradually degrading instruments and accessories. The range values are not necessarily important, but the magnitude of the discounts given to some customers is substantial. Sale of the da Vinci Surgery System ranges from \$0.6 to \$2.5 million each, meaning some customers may receive up to a 76% discount. The annual service agreements range in price from \$80 to \$170 thousand per year (up to 53% discount), and the instruments and accessories, on a per-use basis, equate to a \$700 to \$3,200 per surgery cost (up to 78% discount). Calculating the average cost for these three categories from the total number of sales, operational units, and procedures in 2015 shows indication that the average price paid is roughly halfway between the maximum and zero discount range. They describes their customer base as being primarily US-based (71% of revenue) as well as being larger governmental hospital chains who the purchase the system in bulk, which explains why significant discounts are being offered.

Intuitive also describes their competition in the industry as being the traditional MIS, open surgery, interventional or pharmaceutical options. They describe their robotic option for surgery as an advanced technology albeit with higher costs, that results in increased and quicker success rates. In all, due to the high cost of the system and limited necessity for the limited specialized surgeries currently with guidelines written for execution using the system, Intuitive is implementing a skimming price-setting strategy with substantial price negotiation (discounting) with the customers.

*Findings RQ 2: Where are the observed differences and benefits between the pricing strategies and models?*

As seen in the six case study companies, the price-setting practices of competition-informed and value-informed are the dominant ones implemented. Where they differ is when the new technologies are applied to more patient-centered medical conditions (as is the case for EnteroMedics, Alphatec, Inogen, and Skyline) or towards the hospital-centered medical devices (GE and Intuitive).

The first three medtech products are addressing new higher technology solutions to existing patient conditions, and therefore have pricing restricted by the US Medicare CMS reimbursement price listing, or more generally a market pricing strategy. Bottom line profit for these companies is therefore most strongly determined by total cost reduction to the customers plus decreasing their own operating costs and expenses. Skyline's product is not patient specific, and because of the company's ambition towards significant market share they have chosen to underprice the product, following a penetration pricing strategy. Bottom line profit for them will come from effective marketing, product performance, and

market share growth. Both GE and Intuitive's products are providing higher technology solutions to hospital equipment limitations or competition amongst hospitals for patients needing specialized procedures and tests, thus necessitating skimming price-setting strategies. Bottom line profit for them will come in terms of relative advances their equipment technology has over competitors plus value appeal to the surgeons and patients.

Within this case study selection, the first five companies primarily utilize the buy only pricing model as a result of them all manufacturing machinery or equipment that generate the majority of their revenue, with little to no additional instruments or accessories needed. The sixth company utilizes the buy and use pricing model, thereby having significant revenue coming from both its surgery system and the non-reusable components.

## CONCLUSIONS

Through this six-company case study several advantages and disadvantages to the price-setting practices, strategies, and models were found. In short, the price-setting practice will be determined based on the customer being either single-use patients or large customer throughput hospitals, with the focus being on finding the greatest value for the targeted customers. The price-setting strategy is largely related to the price-setting practice, with modifications based on the relative newness of the technology, level of competition, and trade-off between growth in market share or higher profit margins. The pricing model is primarily dependent on the product delivery method and/or operation by the customer, but with modifications possible based on product customization, relationship with the customer, and specialized financing options.

Advantages in competition-informed price-setting practices plus market price-setting strategy include assurance of a fair price along with associated market share, but the disadvantages include significant competition and lower profit margins in order to grow market share. Advantages in value-informed practices as well as the skimming price-setting strategy include higher profit margins leading to quicker profitability while not growing your customer base faster than supply lines and infrastructure needs, but with the disadvantage of lower market share with higher R&D and marketing costs. Advantages of cost-informed practices and the penetration price-setting strategy include setting a price floor and gaining market share, whereas the disadvantages include lower profitability and potentially setting a low reference price from which your customers will continue to demand low prices.

Advantages to the buy pricing model include the largest customer payments at the earliest time to product delivery, which decreases the OEM's financing requirements. The disadvantages to the buy pricing model are that it is more financially intensive for customers, and if the technology advances quick enough will leave customers feeling left behind or disappointed. The lease pricing model is a

favorable step for the customer, allowing additional payment options and thus an increased customer base. Disadvantages for the OEM include delayed revenue streams and increased staff to track the various accounts. Pay-per-use pricing models are not applicable for all healthcare device companies, but when they are they bring additional revenue for the OEMs as well as a fairer pricing model between customers who use the product more or less than others. Disadvantages include continual inventory monitoring for both OEMs and customers.

No particular ranking of the price-setting practices, strategies and models can be made generically. A specific product and target customer are to first be identified, working next to the price-setting. However, it is noted that in general the larger and more successful companies have product lines with price-setting practices and strategies that evolve with the product and industry age, and that contain diverse pricing models to draw in the largest possible customer base.

Future study must include a larger amount of case study companies within the medtech industry, expansion into other new technology industry segments, and could also incorporate the change in price through a particular product's life cycle.

## REFERENCES

- Alphatec Spine. (2017). Alphatec Spine: Improving lives by delivering advancements in spinal fusion technology. Alphatec Spine, Inc. Retrieved January 22, 2017, from <http://alphatecspine.com>.
- Bassett, M. (2014, May 19). The fight for the right to repair: To ensure adequate access to the equipment they are charged to maintain, Biomedics across the nation are looking for ways to take action. *24x7 Magazine*. Retrieved January 27, 2017, from <http://www.24x7mag.com/2014/05/fight-right-repair>.
- Baxter, P., Jack, S. (2008). Qualitative case study methodology: Study design and implementation for novice researchers. *The Qualitative Report*, 13(4), 544-559.
- Brandt, L. (2013). Price tagging the priceless: International reference pricing for medicines in theory and practice. European Centre for International Political Economy (ECIPE), Policy Briefs #4/2013.
- Copeland, A., Shapiro, A.H. (2015). Price setting and rapid technology adoption: The case of the PC industry. *Review of Economics and Statistics*, 98(3), 601-616.
- Deloitte. (2016). 2016 Global health care outlook: Battling costs while improving care. Deloitte Touche Tohmatsu Limited. Retrieved February 06, 2017, from <https://www2.deloitte.com/content/dam/Deloitte/global/Documents/Life-Sciences-Health-Care/gx-lshc-2016-health-care-outlook.pdf>.
- Ebrahim, A.H., Ganguli, S. (2017). Strategic priorities for exploiting Bahrain's medical tourism potential. *Journal of Place Management and Development*, 10(1). doi: 10.1108/JPM-03-2016-0011.
- Eisenhardt, K.M., Graebner, M.E. (2007). Theory building from cases: Opportunities and challenges. *Academy of Management Journal*, 50(1), 25-32.
- EnteroMedics. (2016). EnteroMedics: About Us. EnteroMedics Inc. Retrieved January 22, 2017, from <http://www.enteromedics.com>.
- Gabrielsson, P., Gabrielsson, M., Gabrielsson, H. (2008). International advertising campaigns in fast-moving consumer goods companies originating from a SMOPEC country. *International Business Review*, 17(6), 714-728. doi:10.1016/j.ibusrev.2008.09.008.
- General Electric (2016, February 26). Digital industrial: GE 2015 annual report. General Electric Company. Retrieved January 11, 2017, from [http://www.ge.com/ar2015/assets/pdf/GE\\_AR15.pdf](http://www.ge.com/ar2015/assets/pdf/GE_AR15.pdf).
- Geng, D., Saggi, K. (2015). External reference pricing policies, price controls, and international patent protection. Vanderbilt University.
- Gerring, J. (2006). *Case study research: Principles and practices*. New York, NY: Cambridge University Press.

- Gobbi, C., Hsuan, J. (2015). Collaborative purchasing of complex technologies in healthcare: Implications for alignment strategies. *International Journal of Operations & Production Management*, 35(3). doi: 10.1108/IJOPM-08-2013-0362.
- Gorodnichenko, Y., Talavera, O. (2016). Price setting in online markets: Basic facts, international comparisons, and cross-border integration. National Bureau of Economic Research (NBER), Working paper #20406. doi: 10.3386/w20406.
- Grohn, K., Moody, K., Wortel, D., LeClair, N., Traina, A., Zluhan, E., Feuer, G. (2015). Lean start-up: A case study in the establishment of affordable laboratory infrastructure and emerging biotechnology business models. *Journal of Commercial Biotechnology*, 21(2), 60–68. doi: 10.5912/jcb698.
- Hennart, J.F. (2013). The accidental internationalists: A theory of born globals. *Entrepreneurship Theory and Practice*, 38(1), 117-135.
- Hollensen, S. (2014). *Global Marketing* (6th ed.). Harlow, England: Financial Times Prentice Hall.
- Howard, J. (2014, November 20). Medical devices and the Middle East: Market, regulation, and reimbursement in Gulf Cooperation Council states. *Medical Devices: Evidence and Research*, 7, 385-395. doi: 10.2147/MDER.S73079.
- Ingenbleek, P.T.M., Frambach, R.T., Verhallen, T.M.M. (2013). Best practices for new product pricing: Impact on market performance and price level under different conditions. *Journal of Product Innovation Management*, 30(3), 560-573. doi:10.1111/jpim.12008.
- Inogen. (2017). Inogen: Oxygen. Anytime. Anywhere. Inogen Inc. Retrieved January 22, 2017, from <http://www.inogen.com>.
- Intuitive Surgical. (2016). 2015 annual report. Intuitive Surgical, Inc. Retrieved January 11, 2017, from <http://phx.corporate-ir.net/phoenix.zhtml?c=122359&p=irol-IRHome>.
- Kirisits, A., Redekop, W.K. (2013). The economic evaluation of medical devices: Challenges ahead. *Applied Health Economics and Health Policy*, 11, 15-26. doi: 10.1007/s40258-012-0006-9.
- Kuznetsova, T., Roud, V. (2014). Competition, innovation, and strategy: Empirical evidence from russian enterprises. *Problems of Economic Transition*, 57(2), 3-36. doi: 10.2753/PET1061-1991570201.
- Lowe, B., Alpert, F. (2010). Pricing strategy and the formation and evolution of reference price perceptions in new product categories. *Psychology & Marketing*, 27(9), 846-73.
- Luostarinen, R., Gabrielsson, M. (2006, November). Globalization and marketing strategies of born globals in SMOPECs. *Thunderbird International Business Review*, 48(6), 773-801. doi: 10.1002/tie.20122.
- Marn, M. V., Roegner, E. V., Zawada, C. C. (2003, August). Pricing new products. *McKinsey Quarterly*, 40-49.
- Marn, M. V., Rosiello, R. L. (1992, September-October). Managing price, gaining profit. *Harvard Business Review*.
- Neubert, M. (2013). *Global market strategies: How to turn your company into a successful international enterprise*. Frankfurt am Main: Campus-Verlag.
- Neubert, M. (2015). Early internationalisation of high-tech firms: Past accomplishments and future directions. *International Journal of Teaching and Case Studies*, 6(4), 353-369.
- Neubert, M. (2016a). Significance of the speed of internationalisation for born global firms – A multiple case study approach. *International Journal of Teaching and Case Studies*, 7(1), 66-81.
- Neubert, M. (2016b). How and why born global firms differ in their speed of internationalization – A multiple case study approach. *International Journal of Teaching and Case Studies*, 7(2), 118-134.
- Obadia, C., Stöttinger, B. (2015). Pricing to manage export channel relationships. *International Business Review*, 24(2), 311-318.
- OECD. (2015). *Health at a glance 2015: OECD indicators*. Paris: OECD Publishing. doi: 10.1787/health\_glance-2015-en.
- R&D Magazine. (2016, March 11). 2016 global R&D funding forecast. Retrieved January 27, 2017, from [https://www.iriweb.org/sites/default/files/2016GlobalR%26DFundingForecast\\_2.pdf](https://www.iriweb.org/sites/default/files/2016GlobalR%26DFundingForecast_2.pdf).
- Rosenberg, J., Yates, P. (2007). Schematic representation of case study research designs. *Journal of Advanced Nursing*, 60(4), 447-452.
- Seawright, J., Gerring, J. (2008). Case selection techniques in case study research a menu of qualitative and quantitative options. *Political Research Quarterly*, 61(2), 294-308.
- Skyline Medical. (2016). Form 10-K (annual report). Skyline Medical, Inc. Retrieved January 11, 2017, from <http://files.shareholder.com/downloads/AMDA-1XMKYQ/3775285216x0xS1171843-16-8621/1446159/filing.pdf>.
- Skyline Medical. (2017). *Streamway: The new standard in waste fluid management*. Skyline Medical, Inc. Retrieved January 11, 2017, from <http://www.skylinemedical.com>.
- Snieskiene, G., Cibinskiene, A. (2015). Export price: How to make it more competitive. *Procedia-Social and Behavioral Sciences*, 213, 92-98.
- Stake, R.E. (1995). *The Art of Case Research*. Thousand Oaks, CA: Sage Publications.

Trudgen, R., Freeman, S. (2014). Measuring the performance of gone-global firms throughout their development process: The roles of initial market selection and internationalisation speed. *Management International Review*, 54(4), 551-579.

Wei, J., Zhao, J. (2014). Pricing and remanufacturing decisions in two competing supply chains. *International Journal of Production Research*, 53(1), 258-278. doi:10.1080/00207543.2014.951088.

# PRICE-SETTING STRATEGIES FOR PRODUCT INNOVATIONS IN THE MEDTECH INDUSTRY

Cohen, Benjamin; Neubert, Michael

ISM International School of Management, Paris, France

## ABSTRACT

This article analyses the research problem of price-setting strategies for product innovations in the medtech industry. It is based on the conceptual framework of price-setting practices, strategies, and models. A multiple case study research is then performed on six medical technology companies, focusing on how they set their initial product price for a new technology solution to either existing medical conditions or technology limitations. The research results show that medtech companies opt for competition-informed price practices and buy pricing models. The pricing strategies vary between skimming and market-based pricing strategies. Price innovations are limited due to regulation and financial considerations.

*Keywords: Price-Setting, Pricing Practice, Pricing Strategy, Pricing Model, Medtech*

## INTRODUCTION

Price-setting for any new product is crucial in determining its future in the market. After years of research and development (R&D), product design, testing, market research and marketing, the first real interaction a product has with the customer is through its price. It is not the idea of how its utility will benefit the customer nor the vision and excitement given about how things will change. Those are unrealized expectations preserved until after the customer has ownership. The price is the real, hard currency promise of what this product will mean to the customer.

There is a great need for all companies to understand and optimize their pricing strategy. Price-setting determines a company's profit margin as well as market share; the ease in making sales or the difficulty in gaining adoption. It is perceived as a profit opportunity invitation to future competition and a territorial grab to existing competitors. Marn and Rosiello (1992) studied the economic parameters of 2,463 companies and found that a 1% improvement in price yielded an 11.1% improvement in operating profit, all else being equal. This compared dramatically high as compared to a 1% improvement in either the variable costs, sales volume, or fixed costs, which yielded operating profit gains of 7.8%, 3.3%, and 2.3%, respectively.

With the possibility of any product or industry to focus on, this paper has chosen the medical technology (medtech) industry. This focus has been chosen because of the amount of money spent on



R&D investment, the rapid advancements made in recent years, the growing worldwide demand in advanced medtech products, and the absence of existing research. Further, medtech products often consist of physical products, consumables, and services, the combination of which increases the pricing complexity.

Medtech companies are providing cutting-edge technologies to patients, hospitals, and care providers around the world. It would appear that as the world becomes more interconnected toward a single common marketplace, the faster the rate of technological development becomes. With an increasing rate of technological development at the same time as larger customer exposure, greater necessity is placed on a medtech company entering new markets with the correct marketing and pricing strategies.

The purpose of this study is to identify various international pricing strategies and models used in real world companies. From this selection, comparison can be made of their relative strengths and proper implementation. The problem in this research is that international pricing decisions are more complex than domestic, frequently incurring currency value swings, differing inflationary pressures and difficulty in having production facilities in different markets, which leads to frequent price reviews (Hollensen, 2014).

This study has been performed in part by the call for research from Ingenbleek, Frambach, and Verhallen (2013). In their paper they call for further research on existing pricing processes with the intent of applying them toward optimal application for new product development. Thereto, it is suggested to address this need through qualitative research methods such as multiple case study research.

## **LITERATURE REVIEW AND THEORETICAL FRAMEWORK**

Successful price-setting strategies and models can be derived from a large number of literature sources centered on either the conceptual derivation or empirical results. However, sources of failure risk are often more easily learned from case studies found in literature research. In short, the success and failure risk factors relevant to bringing a new product to market can be generalized as originating from either the product, company, competition, customer, international market complexity, or new sub-industry oriented focus. Evidence for each of these focuses is found in a selection of recently published literature.

Price-Setting Practice	Prices Based On ...
Value-informed pricing	Customers' perceptions of the benefits that the product offers and that they trade off against the price
Competition-informed pricing	Competitors' prices relative to their market positions
Cost-informed pricing	Variable, fixed, direct, and indirect costs for developing, producing, and marketing the new product or service
Price-Setting Strategy	Prices Based On ...
Skimming	The market segment with the highest reference price is targeted first, and the market is subsequently skimmed to capture segments with lower reference prices
Market pricing	Price influences market share
Penetration pricing	Set a low price in attempt to stimulate product adoption
Non- Price-Setting Strategy	Prices Based On ...
Selecting price models	Not all purchasing options available for customers
Price negotiation w/ customer	List price minus customer-specific discounts
Bundling	Discounted price when multiple products or services purchased
Upgrades / Trade-ins	Discounted price when an older model/version is exchanged
Captive finance companies	Purchasing price dependent on financing terms
Pricing Model	Revenue Based On ...
Buy	One-time payment
Lease / Rent	Recurring monthly/yearly payments
Lease back	Real estate: sale of asset, lease/rent back from buyer (takes the form of a loan)
Pay-per-use	Pay for each use, do not pay for on-site location or maintenance
Combination buy & use	<ul style="list-style-type: none"> <li>• Sale of product, plus recurring payments for service and non-reusable components</li> <li>• Recurring payments comprised of lease/rent, service, and non-reusable components</li> </ul>
Recurring	
Reimbursement	Government payer reimbursement of costs, smaller immediate patient copay
Auction	Highest bidder
Dynamic / Time-based	Price changes as a function of time and supply/availability
Remanufactured	Used goods refurbished or remanufactured and sold as new or lower quality
Second hand	Used goods resold on secondary market
Remarketed	Unsold goods being sold for a different purpose

Table A2: Definition of price-setting practices, strategies, and pricing models used (e.g. Hollensen, 2014; Ingenbleek, Frambach & Verhallen, 2013)

### *Product-Oriented*

Product expectation from customers of a new product's performance should be adequately met by appropriate price-setting strategies. Proper pricing leads to a balance between the product's usefulness and the expectations placed on it from consumers. Ingenbleek et al. (2013) find that inappropriate selection of price-setting practices can counter the positive advantages of new product development. By pricing a product high, customers will have high initial expectations for quality, durability, application, and ease of use, among others, which the product must fulfill. Customer opinion may begin to undervalue the benefit it brings by comparing it with the standards applied to other products at similar prices. Undervaluing a product decreases the consumer confidence in performance and durability, as well as pride of ownership. The consumer is only content when the balance between cost and benefit is met. This selection of a pricing strategy is therefore dependent on the relative level of product advantage, intensity of competition, and relative product costs. This multiple case study research uses the theoretical framework of Ingenbleek et al. (2013) to analyze the pricing strategies of medtech companies.

Specifically, for a new product entering an existing market or creating a new market, value-informed pricing strategy provides the greatest support for a product's pricing strategy. After this, competition-informed pricing adds substantially in situations where competitive intensity is low, whereas cost-informed pricing helps when competitive intensity is high. Likewise, managers pursuing a profit margin objective should express the advantage of their product, thus using value-informed pricing while avoiding cost-informed pricing. In total, Marn, Roegner, and Zawada (2003) estimate 80-90% of new products brought to market are priced too low, and consequently reach a smaller market size and level of profitability than is possible. This has significant negative effects on the company's revenue stream by decreasing short-term profit as well as long-term customer confidence and loyalty (Lowe and Alpert, 2010).

Lowe and Alpert (2010) identified a clear causal effect for the pioneer's price-setting decisions on product price and value perceptions, whereas a follower company's product price seemed to influence perceptions of the follower, not the pioneer. These findings imply that reference price is brand specific, and that the pioneer, due to its proto-typicality, has a stronger influence on reference price perceptions than the follower. However, these effects were stronger for the more innovative product categories being examined.

Online distribution channels greatly increase price transparency, which leads to reduced price differentials between countries and a global standardization of prices (Gorodnichenko and Talavera, 2016). Prices in online markets have been found to change faster than in traditional stores, including a higher pass-through of exchange rate fluctuations. These changes depend on the products and on market conditions such as level of competition.

Specifically, for medical devices, the clinical trial procedure is found to be the best way to estimate a product's cost effectiveness for future customers (Kirisits and Redekop, 2013). These trials are able to reach a broad and diverse range of potential customers with varying levels of severity of the condition being targeted by the new product. From these trials, the performance of the device and degree of benefit can be identified and weighed against its ease of use and any potential harms. The degree of rigor and completeness to these clinical trials is the best way to forecast its acceptance by the public.

#### *Company-Oriented*

When a firm develops a high-technology product filling a small market niche, its full potential needs to be quickly exploited in order to generate sufficient revenue needed to cover its R&D costs, to finance growth, and to offer competitive prices (Neubert, 2015; Trudgen and Freeman, 2014). Therefore, significant product growth is necessary, as well as creating and completing the product's distribution path to the public. Proper relationships with the company's supply chain as well as distributors,

import/exporters, and retailers is critical as the performance of one company will depend on the performance of the entire chain (Wei and Zhao, 2014).

Luostarinen and Gabrielsson (2006) studied 89 companies in Finland who became international within their first three years, and thusly named born global companies (Neubert, 2015). They found that these companies often bypassed cost-informed pricing (setting a product's price floor) by choosing below-cost pricing for their first international customer, and thereafter applying value-added pricing based on the benefits brought to its customers. This method was found to be hugely beneficial to the company creating the product in terms of creating the first international partnership, acquiring initial market share, and finding a more optimal partnership that conveyed confidence in customers not already familiar with the manufacturing company. This brings compounded returns in the form of additional business being brought-in more easily.

Even before focusing on the product and customers, the best qualities of successful lean start-up companies have been identified as controlling overhead costs and to automate as many of the company procedures as possible (Grohn et al, 2015). These actions are often indicative of proper cost-control efforts set by the management, and a focus on the bottom line. Examples of such efforts include the purchase of used equipment, or to negotiate with vendors and suppliers after a more thorough market research of asking prices.

#### *Competition-Oriented*

Knowledge of the pricing strategies, product development, and marketing practices of a company's competitors leads to greater positioning of a company within the overall market. Success of any product originates from one or more advantages that it has over other available product options. Kuznetsova and Roud (2014) performed an industry survey among Russian manufacturing firms to rate their relative company advantages as compared to their competitors. From the results, they found that the highest perceived advantage of the survey respondents' companies was product quality over their competitors, with 76% of respondents believing in their own company produced products at higher quality as compared to 17% of respondents believing in their competitor's product quality advantage. The next largest discrepancy in perspectives was of fast, on-time delivery, in that 43% believed their company had the advantage as compared to 9% giving advantage to their competitors. Roughly 6% of respondents believed that their company possessed no competitive advantages at all, whereas 30% believed that the competitors possessed no advantages. The survey results showed roughly even match between the respondents' company and its competitors in the categories of price, cutting-edge products, adaptation to consumer needs, and service.

Placement of one product helps the product and company succeed in the short-term. However, long-term planning and investment in product improvements and further technological advancement is

vital in assuring continual benefit from the product line. Copeland and Shapiro (2015) found that continual and significant innovation increases the competitive advantage of a product, thus leading to higher prices for the innovator. The constant reworking and renewal of a product's strengths, capacities, and features creates a moving barrier to entry for competitors. Likewise, slower rates of innovation make the retail market more competitive, leading to decreasing company markups and profits.

#### *Customer-Oriented*

No greater entity exists for the protection of customers' best interests than the multitude of government sponsored healthcare programs around the world, and assuring patient safety as well as cost control from healthcare providers are the top two priorities. Specifically relating to overall cost, Gobbi and Hsuan (2015) determined that nearly 65% of the public sector in the US medical industry used collaborative purchasing (CP) power in 1995 to reduce the price of complex medical equipment purchases. They found that purchase of said equipment equates to the largest portion of total expenditure in the realm of healthcare. Because the healthcare providers (predominantly hospitals) have strikingly similar requirements of the machines, equipment, and devices purchased, the potential for CP to decrease overall costs is high. Proper purpose and functionality for the customer must be addressed in order to gain customer adoption of a new technology, as more often than not the needs of customers create the product opportunities for companies. Specifically, for medtech companies, aging demographics and increasing availability to modern medicine for most of the world have created significant growth opportunities. For example, the leading healthcare demands within the United States include decreasing costs, patient safety, personalized care, and advanced cancer research (Deloitte, 2016). Compare that with the Gulf Cooperation Council (GCC) states where healthcare concerns stem from the region's increasing population, which include lifestyle diseases (including ischemic heart disease, stroke, type 2 diabetes and obesity), high incidence of road traffic accidents, and consanguinity (Howard, 2014).

Other countries have made medical tourism a primary focus for the growth of their economy. Such countries as Thailand, Singapore, India, Jordan, Turkey, and the United Arab Emirates have each incurred rapid growth in their healthcare infrastructure in order to satisfy their growing domestic markets as well as attract the international patients (Ebrahim and Ganguli, 2017). These countries aim to benefit from increased demand for the healthcare products and services beyond the level of domestic demand. This effectively causes the hospitals, retailers, and healthcare providers to increase their customer base without the need for export/import concerns and costs.

#### *Foreign Market Complexity Oriented*

International expansion of a company is a significant milestone in its global growth and capture of market share. Yet for many companies this step proves to be a substantial inhibitor to smooth progress. The benefits of an increase in potential customer base are offset by increased costs burdened by consumers, additional governmental regulation and safety controls, cultural or language difficulties, and increased competition. This market adaptation includes a revision of pricing decisions (Neubert, 2016b).

Therefore, entry into a foreign market is only possible after extensive analysis of the market factors and competition (Neubert, 2013). Pricing decisions require regular reviews and structured decision-making processes in order to prepare for and mitigate disturbances caused by changes in foreign competition, currency exchange fluctuation, and inflationary pressures (Snieskiene and Cibinskiene, 2015). Thereto, exporting companies have been found to experience greater rate of success depending on the relationship and partnerships formed with importers (Obadia and Stöttinger, 2015). Exporters can increase the performance of their importers through their pricing strategies, especially by allowing higher margins or other incentive schemes. In response, importers then invest in the products where they can expect the best results, predominantly based on the marketability and the price margin.

Creation of a new product market or niche comes with the significant advantage in that high-tech firms have a high price-setting power to set the reference price for their new product categories. New niche creation has historically come with roughly one to two years of market control before competitor companies can technologically catch up (Lowe and Alpert, 2010). This advantage is substantially decreased in foreign markets that don't enforce patent protection. Geng and Saggi (2015) analyzed pricing strategies of patented (e.g. pharmaceutical) products sold into markets without patent protection, and found that local competition was quickly generated. Such presence led to price competition for market share, meaning lower mark-ups and profitability.

## RESEARCH METHOD

A multiple case study research method shall be used in order to best compare and contrast existing pricing strategies used by medtech companies. This study uses a multiple case study research design to answer the explanatory (why and how) research questions (Yin, 2014). According to Hennart (2013), a qualitative comparative case study research would help to answer the research question. In contrast to an experimental design or a survey, a multiple case study has more flexibility (Stake, 1995), allows an in-depth analysis of a complex research problem within a highly contextualized environment (Rosenberg and Yates, 2007), and a comparison between different cases (Baxter and Jack, 2008; Eisenhardt and Graebner, 2007).

The medical industry in general is a very difficult but interesting industry to identify pricing strategies, particularly within the United States and other countries with large governmental healthcare payer systems. In most countries within the Organization for Economic Cooperation and Development (OECD) the majority of prices for medical services, equipment and prescription drugs are fixed, or set in reference to these government-established reference prices (Brandt, 2013). In the US, it is commonly known as the Centers for Medicare & Medicaid Services (CMS) billing rates. Therefore, the new medtech companies are principally targeting technology innovations not currently outlined in these governmental payer systems.

## **SAMPLING**

The choice of the sampling strategy is based on the purpose of this study. This study uses a purposive case selection strategy (Seawright and Gerring, 2008), because it produces a representative sample with typical (Gerring, 2006) and successful examples of the total population. According to Yin (2014), this sampling strategy produces a statistically representative sample, if at least six to ten cases are selected. This study uses a sample size of six case study firms to allow a better triangulation of data and to strengthen the results of the whole study.

The six case study firms, EnteroMedics, Alphatec Spine, Inogen, Skyline Medical, GE Healthcare, and Intuitive Surgical, are born-global firms using the global exporter business model (Neubert, 2016a). These companies are all publicly traded companies (5 on NASDAQ, GE on NYSE), with market capitalization ranging in size from \$8 million to \$260 billion. Five of the six companies specialize uniquely within the medical equipment and supplies industry, while GE is a multinational conglomerate with exposure in a broad range of industries. This sample was determined sufficient for the study due to the breadth of pricing strategies and models identified between them.

## **RESEARCH QUESTIONS**

The statement of the research problem has led to the following two research questions:

3. What pricing strategies and models are currently being implemented in the medtech industry?
4. Where are the observed differences and benefits between the pricing strategies and models?

## **RESEARCH FINDINGS**

Through researching dozens of companies, it was found that a company cannot state outright its pricing strategy. This is firstly because the terms and definitions of pricing strategies and models are in no way standardized, and secondly because in doing so a company may substantially weaken its market position and brand quality, inviting in new competitors. Therefore, inferences must be made as to why and how a company chose its pricing models. In order to make such inferences, enough detailed information must be revealed about a company's product line revenues and costs, thus leading the research to focus on publicly listed companies on US stock exchanges.

*Findings RQ 1: What pricing strategies and models are currently being implemented in the medtech industry?*

The companies of EnteroMedics, Alphatec Spine, and Inogen were researched, each belonging to a different specialty sector within the healthcare field. EnteroMedics manufactures its Maestro device that uses its neuroblocking technology known as vBloc Therapy to treat obesity, metabolic diseases, and other gastrointestinal disorders (EnteroMedics, 2016). Alphatec Spine manufactures a variety of products for the surgical treatment of spine disorders (Alphatec Spine, 2017). Inogen specializes in the design, manufacturing and marketing of portable oxygen concentrators for patients necessitating oxygen therapy (Inogen, 2017).

Company	Product Line(s)	Description	Price-Setting Practices	Price-Setting Strategy	Pricing Model	
			(Specifically)	(Additional Strategies)	Primary	Secondary
Intuitive Surgical	da Vinci Surgery	robotic surgery	Value-informed	Skimming (Price negotiation)	Buy & Use	Recurring
GE Healthcare	1.5-tesla LX MRI	MRI scan	Value-informed	Skimming (Upgrades / Trade-ins)	Buy	Lease
Skyline Medical Inc	Streamway FMS	fluid disposal	Competition-informed	Penetration pricing (Price negotiation)	Buy	Pay-per-use
EnteroMedics	Maestro (vBloc Therapy)	neuroblocking v obesity	Competition-informed (US Medicare CMS)	Market pricing -	Buy	-
Alphatec Spine	- multiple -	spine surgery	Competition-informed (US Medicare CMS)	Market pricing -	Buy	-
Inogen	Inogen One	portable oxygen	Competition-informed (US Medicare CMS)	Market pricing -	Buy	Service

Table 2: Price-setting practices, strategies, and models for the case study companies

The first finding is that each case study company bases their product pricing in the US on the CMS billing rates (compare to table 2). By doing so, the prices are thus established by the US Medicaid reimbursement rates, meaning a competition-informed price-setting practice. Therefore, the price-setting strategy of all companies is that of market pricing. Each company additionally operates primarily under the buy only pricing model, with Inogen mentioning the service segment of their business generating significant revenue.

Skyline Medical is a company specializing in the collection and disposal of infectious fluids that result from surgical procedures and post-operative care (Skyline Medical, 2017). Their principle focus is the Streamway System, with features such as automated measurement of volumes, prevention of cross-contamination, and a tissue trap that allows for tissue retrieval. Disclosed in their 2015 annual report, Skyline implies that their pricing strategy is one of penetration pricing, specifically singling-out their



competitor Stryker Instrument's comparable system and citing notable differences (Skyline Medical, 2016). The significant differences mentioned are a 33% savings in device purchase price, an industry common installation process that can be performed by distributors, independent contractors, or customer in-house engineering, as well as underpricing the disposable kit needed for each patient operation by \$1. Therefore, the pricing practice detailed in the report is that of competition-informed, although undoubtedly an underlying degree of cost-informed practice evaluated to set their product price floor. The company's pricing model is dominantly through the sale of the Streamway units, with the sale of non-reusable filters and cleaning solutions making up a smaller revenue component.

General Electric (GE) is a global conglomerate company with divisions in the aviation, power generation, electricity distribution, healthcare, oil and gas, transportation, household appliances, and financial industries (GE, 2016). In researching cutting-edge medtech technologies, the recent 3.0-tesla (3T) magnetic resonance imaging (MRI) machines developed at GE were identified as being cutting-edge technology in terms of their magnet strength, bore size, and quieter running status. However, pricing information was discovered only through distributors and then only from contact with sales associates. Consequently, a previous model, the 1.5-tesla (1.5T) LX MRI, was found with sufficient pricing information.

Not only had the 1.5T machines been sold initially at higher prices only to be lowered in time with increased competition from other companies and technologies, but sales were initially only available through GE authorized dealers, later opening up to affiliates and then third party vendors. From uncovering the historical change in pricing as well as sales practices, it is evident that GE uses value-informed price-setting practices to establish skimming price-setting strategies for its MRI products. GE does offer both the sale and lease of its MRI units, although not all vendors offer a leasing option. Undoubtedly, GE must have developed this pricing strategy through years of experience in the healthcare as well as other industries in order to maximize returns to the company.

The sixth and final case study included in this report is from Intuitive Surgical (Intuitive). They manufacture the da Vinci Surgical System used in robotic surgeries, along with related instruments and accessories (Intuitive, 2016). Being a young and ambitious medtech company listed publically, Intuitive has disclosed the largest amount of pricing information found for this research. In their annual report, Intuitive defines their business strategy priorities all in relation to value to its customers; patient, surgeon, and hospital. With the customer in mind, Intuitive has focused their product technology and further improvements on maximizing the value of the system for its customers, primarily through conversion of standard open surgeries to be compatible with the da Vinci system, to better train surgeons for a larger range of complex minimally invasive surgeries (MIS), and to develop procedures

that could convert multiport laparoscopic surgeries into single port surgeries. In all, it is clear that Intuitive employs a value-informed price-setting practice.

Intuitive lists the revenue streams in 2015 from the sale of its surgical systems, sales-type and operating lease options, annual service plan, as well as the non-reusable or gradually degrading instruments and accessories. An impressive 492 robotic systems were sold in 2015, yielding 30% of their annual profits, with another 63 systems delivered to customers under lease terms, yielding less than 1% of profits. On top of that were a combined total of 3,597 systems in use and covered under annual service contracts, bringing in 19% of 2015 profits, but most substantially was the sale of non-reusable or replacement instrument and accessories, equaling over 50% of the annual profits. From this information it is clear that Intuitive primarily employs a buy and use pricing model, with a much smaller percent of clients choosing the leasing option of a recurring pricing model.

Also in the annual report are the ranges of prices charged to its customers for the da Vinci Surgery System, the annual service agreements, and the non-reusable or gradually degrading instruments and accessories. The range values are not necessarily important, but the magnitude of the discounts given to some customers is substantial. Sale of the da Vinci Surgery System ranges from \$0.6 to \$2.5 million each, meaning some customers may receive up to a 76% discount. The annual service agreements range in price from \$80 to \$170 thousand per year (up to 53% discount), and the instruments and accessories, on a per-use basis, equate to a \$700 to \$3,200 per surgery cost (up to 78% discount). Calculating the average cost for these three categories from the total number of sales, operational units, and procedures in 2015 shows indication that the average price paid is roughly halfway between the maximum and zero discount range. They describes their customer base as being primarily US-based (71% of revenue) as well as being larger governmental hospital chains who the purchase the system in bulk, which explains why significant discounts are being offered.

Intuitive also describes their competition in the industry as being the traditional MIS, open surgery, interventional or pharmaceutical options. They describe their robotic option for surgery as an advanced technology albeit with higher costs, that results in increased and quicker success rates. In all, due to the high cost of the system and limited necessity for the limited specialized surgeries currently with guidelines written for execution using the system, Intuitive is implementing a skimming price-setting strategy with substantial price negotiation (discounting) with the customers.

*Findings RQ 2: Where are the observed differences and benefits between the pricing strategies and models?*

As seen in the six case study companies, the price-setting practices of competition-informed and value-informed are the dominant ones implemented. Where they differ is when the new technologies are applied to more patient-centered medical conditions (as is the case for EnteroMedics, Alphatec, Inogen, and Skyline) or towards the hospital-centered medical devices (GE and Intuitive).

The first three medtech products are addressing new higher technology solutions to existing patient conditions, and therefore have pricing restricted by the US Medicare CMS reimbursement price listing, or more generally a market pricing strategy. Bottom line profit for these companies is therefore most strongly determined by total cost reduction to the customers plus decreasing their own operating costs and expenses. Skyline's product is not patient specific, and because of the company's ambition towards significant market share they have chosen to underprice the product, following a penetration pricing strategy. Bottom line profit for them will come from effective marketing, product performance, and market share growth. Both GE and Intuitive's products are providing higher technology solutions to hospital equipment limitations or competition amongst hospitals for patients needing specialized procedures and tests, thus necessitating skimming price-setting strategies. Bottom line profit for them will come in terms of relative advances their equipment technology has over competitors plus value appeal to the surgeons and patients.

Within this case study selection, the first five companies primarily utilize the buy only pricing model as a result of them all manufacturing machinery or equipment that generate the majority of their revenue, with little to no additional instruments or accessories needed. The sixth company utilizes the buy and use pricing model, thereby having significant revenue coming from both its surgery system and the non-reusable components.

## CONCLUSIONS

Through this six-company case study several advantages and disadvantages to the price-setting practices, strategies, and models were found. In short, the price-setting practice will be determined based on the customer being either single-use patients or large customer throughput hospitals, with the focus being on finding the greatest value for the targeted customers. The price-setting strategy is largely related to the price-setting practice, with modifications based on the relative newness of the technology, level of competition, and trade-off between growth in market share or higher profit margins. The pricing model is primarily dependent on the product delivery method and/or operation by the customer, but with modifications possible based on product customization, relationship with the customer, and specialized financing options.

Advantages in competition-informed price-setting practices plus market price-setting strategy include assurance of a fair price along with associated market share, but the disadvantages include significant competition and lower profit margins in order to grow market share. Advantages in value-informed practices as well as the skimming price-setting strategy include higher profit margins leading to quicker profitability while not growing your customer base faster than supply lines and infrastructure needs, but with the disadvantage of lower market share with higher R&D and marketing costs.

Advantages of cost-informed practices and the penetration price-setting strategy include setting a price floor and gaining market share, whereas the disadvantages include lower profitability and potentially setting a low reference price from which your customers will continue to demand low prices.

Advantages to the buy pricing model include the largest customer payments at the earliest time to product delivery, which decreases the OEM's financing requirements. The disadvantages to the buy pricing model are that it is more financially intensive for customers, and if the technology advances quick enough will leave customers feeling left behind or disappointed. The lease pricing model is a favorable step for the customer, allowing additional payment options and thus an increased customer base. Disadvantages for the OEM include delayed revenue streams and increased staff to track the various accounts. Pay-per-use pricing models are not applicable for all healthcare device companies, but when they are they bring additional revenue for the OEMs as well as a fairer pricing model between customers who use the product more or less than others. Disadvantages include continual inventory monitoring for both OEMs and customers.

No particular ranking of the price-setting practices, strategies and models can be made generically. A specific product and target customer are to first be identified, working next to the price-setting. However, it is noted that in general the larger and more successful companies have product lines with price-setting practices and strategies that evolve with the product and industry age, and that contain diverse pricing models to draw in the largest possible customer base.

Future study must include a larger amount of case study companies within the medtech industry, expansion into other new technology industry segments, and could also incorporate the change in price through a particular product's life cycle.

## REFERENCES

- Alphatec Spine. (2017). Alphatec Spine: Improving lives by delivering advancements in spinal fusion technology. Alphatec Spine, Inc. Retrieved January 22, 2017, from <http://alphatecspine.com>.
- Bassett, M. (2014, May 19). The fight for the right to repair: To ensure adequate access to the equipment they are charged to maintain, Biomedics across the nation are looking for ways to take action. 24x7 Magazine. Retrieved January 27, 2017, from <http://www.24x7mag.com/2014/05/fight-right-repair>.
- Baxter, P., Jack, S. (2008). Qualitative case study methodology: Study design and implementation for novice researchers. *The Qualitative Report*, 13(4), 544-559.
- Brandt, L. (2013). Price tagging the priceless: International reference pricing for medicines in theory and practice. European Centre for International Political Economy (ECIPE), Policy Briefs #4/2013.
- Copeland, A., Shapiro, A.H. (2015). Price setting and rapid technology adoption: The case of the PC industry. *Review of Economics and Statistics*, 98(3), 601-616.
- Deloitte. (2016). 2016 Global health care outlook: Battling costs while improving care. Deloitte Touche Tohmatsu Limited. Retrieved February 06, 2017, from <https://www2.deloitte.com/content/dam/Deloitte/global/Documents/Life-Sciences-Health-Care/gx-lshc-2016-health-care-outlook.pdf>.
- Ebrahim, A.H., Ganguli, S. (2017). Strategic priorities for exploiting Bahrain's medical tourism potential. *Journal of Place Management and Development*, 10(1). doi: 10.1108/JPMD-03-2016-0011.

- Eisenhardt, K.M., Graebner, M.E. (2007). Theory building from cases: Opportunities and challenges. *Academy of Management Journal*, 50(1), 25-32.
- EnteroMedics. (2016). EnteroMedics: About Us. EnteroMedics Inc. Retrieved January 22, 2017, from <http://www.enteromedics.com>.
- Gabrielsson, P., Gabrielsson, M., Gabrielsson, H. (2008). International advertising campaigns in fast-moving consumer goods companies originating from a SMOPEC country. *International Business Review*, 17(6), 714-728. doi:10.1016/j.ibusrev.2008.09.008.
- General Electric (2016, February 26). Digital industrial: GE 2015 annual report. General Electric Company. Retrieved January 11, 2017, from [http://www.ge.com/ar2015/assets/pdf/GE\\_AR15.pdf](http://www.ge.com/ar2015/assets/pdf/GE_AR15.pdf).
- Geng, D., Saggi, K. (2015). External reference pricing policies, price controls, and international patent protection. Vanderbilt University.
- Gerring, J. (2006). *Case study research: Principles and practices*. New York, NY: Cambridge University Press.
- Gobbi, C., Hsuan, J. (2015). Collaborative purchasing of complex technologies in healthcare: Implications for alignment strategies. *International Journal of Operations & Production Management*, 35(3). doi: 10.1108/IJOPM-08-2013-0362.
- Gorodnichenko, Y., Talavera, O. (2016). Price setting in online markets: Basic facts, international comparisons, and cross-border integration. National Bureau of Economic Research (NBER), Working paper #20406. doi: 10.3386/w20406.
- Grohn, K., Moody, K., Wortel, D., LeClair, N., Traina, A., Zluhan, E., Feuer, G. (2015). Lean start-up: A case study in the establishment of affordable laboratory infrastructure and emerging biotechnology business models. *Journal of Commercial Biotechnology*, 21(2), 60–68. doi: 10.5912/jcb698.
- Hennart, J.F. (2013). The accidental internationalists: A theory of born globals. *Entrepreneurship Theory and Practice*, 38(1), 117-135.
- Hollensen, S. (2014). *Global Marketing* (6th ed.). Harlow, England: Financial Times Prentice Hall.
- Howard, J. (2014, November 20). Medical devices and the Middle East: Market, regulation, and reimbursement in Gulf Cooperation Council states. *Medical Devices: Evidence and Research*, 7, 385-395. doi: 10.2147/MDER.S73079.
- Ingenbleek, P.T.M., Frambach, R.T., Verhallen, T.M.M. (2013). Best practices for new product pricing: Impact on market performance and price level under different conditions. *Journal of Product Innovation Management*, 30(3), 560-573. doi:10.1111/jpim.12008.
- Inogen. (2017). Inogen: Oxygen. Anytime. Anywhere. Inogen Inc. Retrieved January 22, 2017, from <http://www.inogen.com>.
- Intuitive Surgical. (2016). 2015 annual report. Intuitive Surgical, Inc. Retrieved January 11, 2017, from <http://phx.corporate-ir.net/phoenix.zhtml?c=122359&p=irol-IRHome>.
- Kirisits, A., Redekop, W.K. (2013). The economic evaluation of medical devices: Challenges ahead. *Applied Health Economics and Health Policy*, 11, 15-26. doi: 10.1007/s40258-012-0006-9.
- Kuznetsova, T., Roud, V. (2014). Competition, innovation, and strategy: Empirical evidence from russian enterprises. *Problems of Economic Transition*, 57(2), 3-36. doi: 10.2753/PET1061-1991570201.
- Lowe, B., Alpert, F. (2010). Pricing strategy and the formation and evolution of reference price perceptions in new product categories. *Psychology & Marketing*, 27(9), 846-73.
- Luostarinen, R., Gabrielsson, M. (2006, November). Globalization and marketing strategies of born globals in SMOPECs. *Thunderbird International Business Review*, 48(6), 773-801. doi: 10.1002/tie.20122.
- Marn, M. V., Roegner, E. V., Zawada, C. C. (2003, August). Pricing new products. *McKinsey Quarterly*, 40-49.
- Marn, M. V., Rosiello, R. L. (1992, September-October). Managing price, gaining profit. *Harvard Business Review*.
- Neubert, M. (2013). *Global market strategies: How to turn your company into a successful international enterprise*. Frankfurt am Main: Campus-Verlag.
- Neubert, M. (2015). Early internationalisation of high-tech firms: Past accomplishments and future directions. *International Journal of Teaching and Case Studies*, 6(4), 353-369.
- Neubert, M. (2016a). Significance of the speed of internationalisation for born global firms – A multiple case study approach. *International Journal of Teaching and Case Studies*, 7(1), 66-81.
- Neubert, M. (2016b). How and why born global firms differ in their speed of internationalization – A multiple case study approach. *International Journal of Teaching and Case Studies*, 7(2), 118-134.
- Obadia, C., Stöttinger, B. (2015). Pricing to manage export channel relationships. *International Business Review*, 24(2), 311-318.
- OECD. (2015). *Health at a glance 2015: OECD indicators*. Paris: OECD Publishing. doi: 10.1787/health\_glance-2015-en.
- R&D Magazine. (2016, March 11). 2016 global R&D funding forecast. Retrieved January 27, 2017, from [https://www.iriweb.org/sites/default/files/2016GlobalR%26DFundingForecast\\_2.pdf](https://www.iriweb.org/sites/default/files/2016GlobalR%26DFundingForecast_2.pdf).

- Rosenberg, J., Yates, P. (2007). Schematic representation of case study research designs. *Journal of Advanced Nursing*, 60(4), 447-452.
- Seawright, J., Gerring, J. (2008). Case selection techniques in case study research a menu of qualitative and quantitative options. *Political Research Quarterly*, 61(2), 294-308.
- Skyline Medical. (2016). Form 10-K (annual report). Skyline Medical, Inc. Retrieved January 11, 2017, from <http://files.shareholder.com/downloads/AMDA-1XMKYQ/3775285216x0xS1171843-16-8621/1446159/filing.pdf>.
- Skyline Medical. (2017). Streamway: The new standard in waste fluid management. Skyline Medical, Inc. Retrieved January 11, 2017, from <http://www.skylinemedical.com>.
- Snieskiene, G., Cibinskiene, A. (2015). Export price: How to make it more competitive. *Procedia-Social and Behavioral Sciences*, 213, 92-98.
- Stake, R.E. (1995). *The Art of Case Research*. Thousand Oaks, CA: Sage Publications.
- Trudgen, R., Freeman, S. (2014). Measuring the performance of gone-global firms throughout their development process: The roles of initial market selection and internationalisation speed. *Management International Review*, 54(4), 551-579.
- Wei, J., Zhao, J. (2014). Pricing and remanufacturing decisions in two competing supply chains. *International Journal of Production Research*, 53(1), 258-278. doi:10.1080/00207543.2014.951088.

## **SOCIAL MEDIA TECHNOLOGY USE AND MANAGERS PERCEPTION.**

### **A PRELIMINARY STUDY IN THE ITALIAN WINE INDUSTRY**

**Crescimanno, Maria; Galati, Antonino; Tulone, Antonio; Tinervia, Salvatore**

Department of Agricultural, Food and Forest Sciences, University of Palermo, Palermo, Italy

#### **ABSTRACT**

This preliminary study contributes to enrich the empirical evidences on the role and impact of SM technology adoption in the Italian wine sector. In particular, the aims are to (i) understand the reasons that guide entrepreneurs to adopt SMs, (ii) identify the usefulness of SMs in the various business activities and (iii) examine the perception that the implementation of these tools has on the company's economic and organizational performance. In order to collect these information an electronic survey has been conducted among Sicilian wineries. Our findings show that the main reasons driving entrepreneurs to adopt SMs technology are the need to promote corporate image and to exploit a new communication channel. These tools are used to monitoring comments in order to understand both the attitudes towards purchasing and buying preferences and how messages are perceived by customers. Results confirm a positive effect of SM adoption in terms of corporate image and customer relationship management. This research has some theoretical and practical implications. If appropriately used our results can support the entrepreneurial choices taking into consideration that these tools allow to improve the customer relationship management and in particular the corporate image of the firm into the market.

*Keywords: Social Media marketing, Business performance, Wine sector, .*

#### **INTRODUCTION**

The firm's need to survive to the global competition has led to a restatement of the business models. This was facilitated by the spread of Internet and digital technologies and particularly Social Media (SM) (Galati et al., 2016). According to Whelan et al. (2013), SM are able to provide to the users, interactive, fast, and inexpensive contents. Interactivity, speed, and cost-effectiveness are, in fact, the three factors that have favoured the success and diffusion of these new marketing tools at the firm level. Through interaction, users can participate in online communities by providing their judgments on products or companies (Zheng et al., 2015), can dialogue and discuss among them, can sharing ideas, thoughts and images (Utz, 2015) and disseminate information in the network through word-of-mouth and blogging (Van Doorn et al., 2010). Reviews and comments provided by users are also

considered by consumers as more reliable and truthful than other forms of advertising proposed by firms (Dar et al., 2014). In addition, the speed of these new communication channels allows to a growing number of users to connect, resulting in a greater opportunity to disseminate information about a firm brand and to break down geographic boundaries by linking individuals who share the same interests in different areas (Sakas et al., 2015). Lastly, the low investment required (Broekemier et al., 2015; Michaelidou et al., 2011) and the contraction in operating costs (Charoensukmongkol and Sasatanun, 2017) determine the viability of these new tools.

According to the Eurostat data, 45% of EU-28 firms, with at least 10 employees, declared for the year 2016 to use at least one SM in conducting their business activities (Eurostat, 2017). In the EU context, Italian data is below to the UE average data. In fact, only 39% of firms integrate SM into their communication plans. Among SM, social networks represent the most widespread category (Eurostat, 2017). As suggested by Genç and Öksüz (2015) Social networks represent real opportunities in business processes, becoming an integral part in business strategies and practices (Peters et al., 2013) and offering the opportunity to intercept the widest range of potential end users (Meredith, 2012). In EU-28, 42% of firms adopt Social Networks (SNs), while in Italy this percentage goes down to 37% (Eurostat, 2017). Facebook is judged by 66% of the Italian entrepreneurs as an effective or very effective tool for achieving business activities (Casaleggio Associati, 2016).

The diffusion of SMs among companies has fuelled a growing interest in the scientific community, focusing on the analysis of the impact of SM on consumer buying choices and Customer Relationship Management (CRM) and the relationship between SM and Business performance (Galati et al., in press; Kim and Drumwright, 2016; Trainor et al., 2014). On the contrary very few studies have investigated the role of SMs in the business process, the reasons that encourage entrepreneurs to invest in these new tools, the possible uses of business management and the level of gratification resulting from their use (Charoensukmongkol and Sasatanun, 2017; Mack et al., 2017; Dahnil et al., 2014).

With this in mind , the following research questions are proposed:

RQ1. To what extent SMs are used in business activities?

RQ2. What are the reasons for companies to be present in the SMs?

RQ3. What is the level of satisfaction resulting from the SMs use in relation to business performance?

To answer these questions, the present study aims to analyze the adoption and the role of SMs in Sicilian wineries and in particular (i) understand the motivations that guide entrepreneurs to adopt SMs, (ii) identify the usefulness of SM in the various business activities and (iii) examine the



perception that the implementation of these tools has on the company's economic and organizational performance.

Sicily was chosen because, in recent years, numerous wineries have implemented modernization processes paying increased attention to improving product quality, packaging and marketing in particular (Giacomarra et al., 2016; Galati et al., 2015). With specific reference to the marketing and communication strategies, Galati et al. (2016) found that a prevalence of Sicilian wineries adopt internet in their own website as a means of communication to promote their image, increase their visibility and bringing down communication costs. This is in line with the growing recognition of the relevant role of digital marketing as valuable and appropriate tool to reach consumers (Viana, 2016).

The paper is organized as follows. A literature review on the relationship between SM adoption and business performance and the manager's perceptions is presented in the second section. The third section summarizes the methodological approach used. Results are presented and discussed in the fourth section. The last section contains final considerations and some concluding remarks.

## LITERATURE REVIEW

The advent of Web 2.0 technologies and the growing diffusion of SM have transformed the ways in which firms can enact their business and their marketing and communication strategies. In recent years, an increasing number of firms have incorporated SM strategies in an integrated communication and media plan by intensifying their marketing efforts and changing the way of doing business (Dahnil et al., 2014; Kaplan and Haenlein, 2010). As noted by Berthon et al. (2005) SM can be used by firms in three different ways, as traditional marketing channels, in which economic return on investment (ROI) is the firm's main objective, in a traditional-experimental way, where purely economic aspects are associated with social interactions (social-ROI), and, as experimental approach in which the firm integrates a human voice into the social-media platform. Many studies show that firms' adoption of marketing strategies based on SM have a positive impact mainly on the direct interaction with consumers, indeed, as asserted by Kietzmann et al. (2011), business become a network member in a system of interactions among customers and between customers and company. It is widely recognized that some firms use SM for customer relationship management (CRM), because communication in SM can be made in real-time, thereby allowing companies to interact with and respond to customers instantly (Charoensukmongkol and Sasatanum, 2017). SM technology although not be sufficient to gain immediately a competitive advantage have the potential to create capabilities that could translate into useful resources that allow firms to better meet the needs of customers and which can turn result in competitive advantages and higher performance (Trainor et al., 2014; Lau, 2011; Leonidou et al., 2011).

Empirical researches have been largely focused on the Social Media marketing and in particular on the impact of SM and SNS in consumers' purchasing intention (Dehghani and Tumer, 2015; Gunawan and Huarng, 2015; Whan and Wei, 2012), on their effect on the brand awareness (Gao and Feng, 2016; Breslauer et al., 2009), to provide useful market research data and to generate electronic worth-of-mouth conversation (Erkan and Evans, 2016; Nunan and Yenicioglu, 2013; Trusov et al., 2009).

Very few studies in the economic literature have been carried out in order to understand the effectiveness of the investments of SM tools and the determinants of the adoption of SM at the firm level. In relation to the first point, some Authors emphasize the difficulty in determining the economic impact of SM investments in terms of Return on investment and Return on sales (Wu, 2016; Kim et al., 2015; Chung et al., 2014; Kumar and Mirchandai, 2012) in relation to the complexity of distinguish customers from online community members (Ang, 2011). As funded by Moorman (2015) only 15% of marketers have been able to prove the quantitative impact of SM on their business. However, as suggested by Charoensukmongkol and Sasatanum (2017) the entrepreneurs who used SM intensively for CRM tended to report higher satisfaction with their business performance and this evidence appeared to be significantly higher for the entrepreneurs who exhibited lower level of social competency in business.

With specific reference to the determinants with the most impact on the adoption of SM at the firm level, some Authors emphasize that firms incorporate SM in their promotional plans in order to reduce both internal communication and marketing costs, and transaction costs (information, negotiation, and monitoring costs), through an improvement of the efficiency of their communication process (Bughin et al., 2011). Compared to non-virtual media or traditional marketing channels, SM represent an inexpensive promotional options with relatively low cost (Broekemier et al., 2015; Dehghani and Tumer, 2015). Kirtis and Karahan (2011) found that the use of SM as a marketing tool is a marketing strategy that can save business costs as through the use of SM, millions of consumers can be reached in a short period of time and the information can be disseminated quickly.

Companies use SM platforms, such as Facebook, in order to increase brand awareness and enlist people's participation through online comments, posts, and other types of engagement (Wallace et al., 2014). This is especially true for products such as wine, in which the interaction between wine producers and consumers, or among consumers themselves, has a key role to orient consumer behaviour affecting the sales process. SM helps to advance wine sales due to SM platforms' ability to spread wine consumers' opinions to others, encouraging customers to try different wines (Quinton and Wilson, 2012; Leigon, 2011). Quinton and Wilson (2016) investigate business relationship management in the wine industry within a social media network, they found that participation in the social network can lead to enhance business performance. In particular, business performance is

enhanced through collaborative problem solving of technical or specific issue which will improve resource efficiencies, the creation of ideas which enhance the credibility of the business in the marketplace, and the establishment of new business contracts through the Social media networks which will increase revenue generation and profit.

The firms' adoption of modern digital technologies and of new and innovative tools, such as SM, is affected, as emphasized in many studies, by firms' managerial characteristics (Galati et al., 2016). Empirical evidences suggest that younger managers are more likely to adopt SM tools, and managers or owners with a higher level of education have the ability to create a favourable atmosphere for the adoption and implementation of innovative tools (Fosso and Carter, 2014; Vlachvei and Notta, 2014). The latter results has been confirmed also in the wine industry in the study of Galati et al. (in press) according to which wineries more engaged in SM were those run by managers with a high level of education, probably because such managers had increased awareness of the benefits associated with the integration of SM in their marketing plans. A different result was found by Mack et al. (2017); the Authors find not differences amongst entrepreneurs of different ages, races, and educational levels in their internet and social media use but highlighted that prior entrepreneurial experience is the most important explanatory factor in explaining the internet application and SM use. In addition, Alarcón-del-Amo et al. (2016) found that the introduction of SM tools in the business strategies is tied to managers' beliefs. Infact, managers' beliefs about the adequacy of social media capabilities for dealing with foreign customers generate a positive managerial attitude and a greater intention to use these applications.

## METHODOLOGICAL APPROACH

### *Sample and data collection*

Data were collected through an electronic survey conducted among Sicilian firms operating in the wine sector in 2017. The reference universe consisted of 245 wineries engaged in the production of wines from grape according to the classification of economic activities NACE 2007 (code 11.02). Of these, firms present in the social networks were 99 and comprised the target population surveyed. An electronic questionnaire has been sent to each of the wineries via e-mail to capture information on both the wineries and managers characteristics, and the main factors explaining the adoption of SM and the perception of firm entrepreneurs about the use and the effectiveness of social media strategies. A total of 37 questionnaires were obtained.

### *Measures*

The scale adopted to analyze the main reasons affecting the manager/owner of the wineries to be present on SM and SNS in particular, the business activities in which these tools are used and the

impact of the adoption of the SM on the economic and organizational performance, were developed based on the review of prior research and modified taking into account the specificity of the wine industry. In particular, for the question related to the reasons that guide manager/owner to incorporate SM strategies in their marketing and communication plan we adapted to the sector studied the items proposed in previous empirical researches (Garay et al., 2017; Trainor et al., 2014). All items were rated on a 5-point Likert scale ranging from 1 (not at all) to 5 (Extremely important). In order to measure the SM use in the business activity ten questions built, on the basis of the research of Andzulis et al. (2012) and Charoensukmongkol and Sasatanum (2017) and modified taking into consideration the specificity of the sector studied, have been proposed. For these questions a five-point Likert scale was used. Finally, managers/owners were asked to assess to what extent they were satisfied following the social media adoption with their firm performance. A five-point Likert scale ranging from 1 (very dissatisfied) to 5 (very satisfied) was used.

## RESULTS AND DISCUSSION

### *Sample description*

On average, wineries of the sample operate in the sector for more than 35 years and produce about 270,000 bottles a year, with a range varying between 1.3 million and 4 thousand bottles, highlighting a great heterogeneity of behavior. An interesting aspect that emerges from our survey is the high investment in advertising and promotion that reaches on average 1.9% of turnover and ranging between 0% and 15%. This high investment justifies the number of employees working in this area, which averages 1.4 units.

Concerning the manager characteristics, the sample studied presents a strong presence of young owner-managers under 40 years (51%). This is certainly in line with the spread of modernization and the introduction of innovation in the wine sector and confirms recent studies that young managers are inclined to adopt SM compared to older ones (Wamba and Carter, 2014). Furthermore, results show a high level of education among the firm entrepreneurs. In fact, more than 58% of respondents have a bachelor or master degree. As Mack et al. evidenced (2017), this is a resource for the entire industry because high levels of education are associated with greater ability to acquire information and reduce uncertainty (Damanpour and Schneider, 2009), as well as being able to recreate conditions to work in a more innovative atmosphere (Wamba and Carter, 2014) and be more capable of taking deciphering and solving problems (Damanpour and Schneider, 2009).

### *Factors affecting the adoption of SM technology*

The main reasons affecting the decision of Sicilian entrepreneurs operating in the wine industry to be present in the SMs and SNS in particular are ranked in Figure 1. The results show that the key factors

driving entrepreneurs or owners to implement SMs technology in their communication plan are the need to promote corporate image (4.43) and to exploit a new communication channel (4.34). Other important factors guiding firm owners to adopt SM strategies are to communicate with customers (4.06), to introduce the company to a larger audience (3.89) and to interact with customers (3.80). These findings are in line with the results of Wallace et al. (2014) who found that SM platform is used in order to increase brand awareness and involve user's participation in on-line comments and post. On the contrary, SMs and SNs in particular are less used as tools capable to acquire information on collaborators (2.24) and competitors (2.47) and to conduct market research (2.82). An interesting aspect that emerges from our survey is the low influence in the choice to adopt SNs of motivations linked to the opportunity to reduce advertising and communication costs, or to increase the competitive advantage. These findings contrasts with the results of some authors according to which SM are used in order to reduce transaction costs (Bughin et al., 2011) and to reduce business costs (Kirtis and Karaham, 2011; Broekemier et al., 2015; Dehghani and Tumer, 2015).

**Figure 1 - Raisons to be present in the SMs**

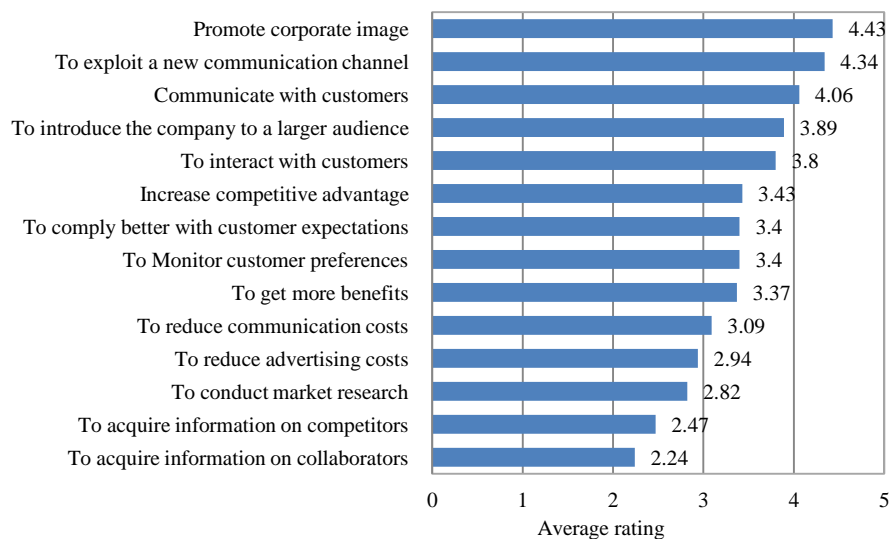

*Source:* Our elaboration on collected data

Findings show that Facebook and other SMs are used by firm owners to provide real time information about the product (3.94), to share and exchange information with customers about the products (3.71), to interact with, talk to, and share opinions with customers (3.62). As emphasized by Charoensukmongkol and Sasatanum, (2017) SM are used by firms mainly for customer relationship management, taking into account that these tools have a positive impact on the direct interaction with customers. Furthermore, the entrepreneurs interviewed use SNs to monitoring comments in order to understand attitudes towards purchasing and buying preferences and how messages are perceived (3.27 and 3.24, respectively). In contrast, Facebook and other SMs are less used by winery

entrepreneurs to acquire information on each customers in order to differentiate and classify customers and create a specific strategy for each group of customers.

Regarding the perceived impact due to the adoption of SM technologies, the findings suggest that the main positive effect is on the corporate image (4.26) and on the customer satisfactions (3.89). Additionally, some firm owners interviewed said that they gain a customer long term retention (3.69). Most of the entrepreneurs interviewed found no improvement in the profit and profit growth (3.06 respectively), and in the sale volume and sale growth (3.23 respectively). The latter results are probably due to the difficulty of entrepreneurs, showed by some authors (Wu, 2016; Kim et al., 2015) to determine the economic impact of SM investments in terms of profit and sales.

Table 3 – Use of Facebook and others SMs in the business activities

	Average rating
Compile data for each customer who visit the page	2.18
Differentiate and classify customers in terms of their gender, age, career, level of education, etc	2.41
Create a specific strategy for each group of customers to make it easy to respond to their specific demands	2.62
Create groups of customers who are interested in the same types of products or services offered (such as the creation of personal groups, which makes it easy to offer products to specific groups of customers)	2.71
Study the needs of individual customers and offer the products corresponding to their expectations	2.97
Monitoring comments to understand how message is perceived, or what other information is wanted	3.24
Monitoring comments to understand attitudes towards purchasing and buying preferences	3.27
Interact with, talk to, and share opinions with customers	3.62
Share and exchange information with customers about the products and services offered	3.71
Provide real time information about the product	3.94

Source: Our elaboration on collected data

## Figure 2 – Impact of the SMs use on the business performance

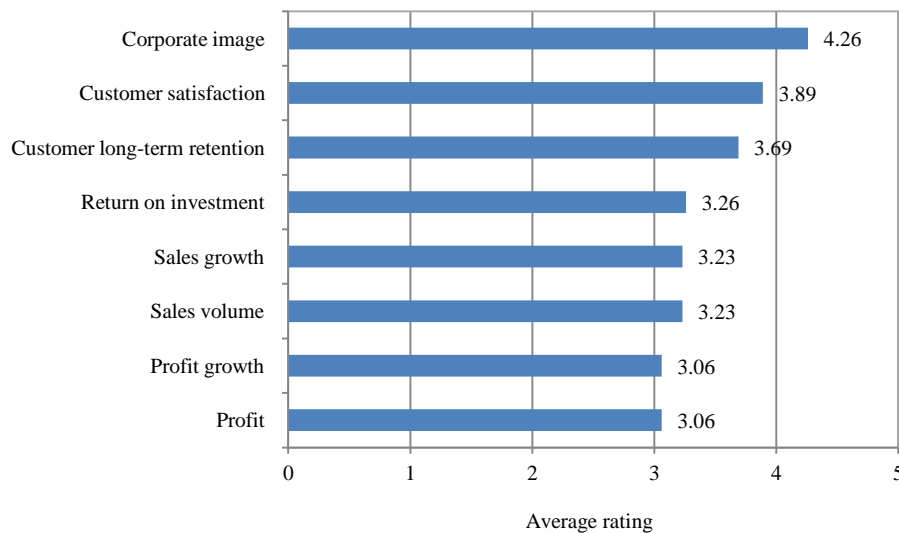

*Source:* Our elaboration on collected data

## CONCLUSIONS

This study contributes to the few research on the role and impact of social media technology adoption by firms operating in the Sicilian wine sector. In particular, our findings shows that the main raisons driving entrepreneurs or owners to invest in SMs technology are the need to promote corporate image and to exploit a new communication channel. Between SMs, the SNs are the virtual platform most used for business purposes. The entrepreneurs, in fact, use SNs to monitoring comments in order to understand both the attitudes towards purchasing and buying preferences and how messages are perceived by customers. Regarding the impact of SMs adoption on the business performance, our findings confirm the positive effect of SM adoption in terms of corporate image and customer relationship management.

This study has some theoretical and managerial implications. From a tehoretical point of view, our results contribute to enrich the empirical evidences on the role of SM technology and their impact on the business performance. From a managerial perspective, our results if appropriately used can support the entrepreneurial choices taking into consideration that these tools allow to improve the customer relationship management and in particular the corporate image of the firm into the market. As a results, SMs contribute to increase the business performance and to improve their competitive advantage in the wine market.

That being said, it is important to point out some limitations of this work. First, the results are based on a single region (Sicily). For this reason, future works should focus on several territories in different areas of the globe to overcome this limitation. Second, the analysis is based on a limited number of

wineries, which greatly limits the veracity and the applicability of the results on a large scale. In the future, it would be advisable to extend the sample to verify the reliability of the results obtained.

The originality of this study lies in being a preliminary study in the Italian wine sector, focusing on SMS technology use and on the managerial perceptions.

## REFERENCES

- Alarcón-del-Amo, M.C., Rialp, A., Rialp, J. (2016), "Social media adoption by exporters: The export-dependence moderating role", *Spanish Journal of Marketing – ESIC*, Vol. 20, pp. 81-92.
- Andzulis, J.M., Panagopoulos, N.G. and Rapp, A. (2012), "A Review of Social Media and Implications for the Sales Process", *Journal of Personal Selling & Sales Management*, Vol. 32, No. 3, pp. 305-316.
- Ang, L. (2011), "Community relationship management and social media", *Database Marketing and Customer Strategy Management*, Vol. 18, No. 1, pp. 31-38.
- Berthon, P.R., Pitt, L.F., Plangger, K. and Shapiro, D. (2012), "Marketing meets Web 2.0, social media, and creative consumers: Implications for international marketing strategy", *Business Horizons*, Vol. 55, No. 3, pp. 261-271.
- Breslauer, B., Ruoss, S. and Smith, T. (2009), *Social media trends around the world! The global web index (GWI)*, Online Research, Chicago.
- Broekemier, G., Chau, N.N. and Seshadri, S. (2015), "Social media practices among small business-to-business enterprises", *Small Business Institute Journal*, Vol. 11, No. 1, pp. 37-48.
- Bughin, J., Byers, A. and Chui, M. (2011), "How social technologies are extending the organization", *McKinsey Quarterly*, Vol. 20, No. 1, pp. 1-10.
- Casaleggio Associati (2016), *L'e-commerce in Italia 2016*, Casaleggio Associati Strategie di rete, Milano, Italy.
- Charoensukmongkol, P. and Sasatanun, P. (2017), "Social media use for CRM and business performance satisfaction: The moderating roles of social skills and social media sales intensity", *Asia Pacific Management Review*.
- Chung, S., Animesh, A., Han, K. and Pinsonneault, A. (2014), "Firm's social media efforts, consumer behaviour, and firm performance", in *Information Systems proceedings of the 35th International Conference in Auckland*, New Zealand. doi:10.2139/ssrn.2448510.
- Dahnil, M.I., Marzuki, K.M., Langgat, J. and Fabeil, N.F. (2014), "Factors Influencing SMEs Adoption of Social Media Marketing", *Procedia - Social and Behavioral Sciences*, Vol. 148 pp. 119 – 126.
- Damanpour, F. and Schneider, M. (2009), "Characteristics of innovation and innovation adoption in public organizations: Assessing the role of managers", *Journal of Public Administration Research and Theory*, Vol. 19, No. 3, pp. 495-522.
- Dar, N.A., Ahmed, M.A., Muzaffar, M.H., Nawaz, K. and Zahid, Z. (2014), "Facebook verses Television : Advertising Value Perception among Students", *International Journal of Business and Management Invention*, Vol. 3, No. 9, pp. 61-70.
- Dehghani, M., and Tumer, M., (2015), "A research on effectiveness of Facebook advertising on enhancing purchase intention of consumers", *Computers in Human Behavior*, Vol. 49, No. 1, pp. 597-600.
- Erkan, I. and Evans, C. (2016), "The influence of eWOM in social media on consumers' purchase intentions: An extended approach to information adoption", *Computers in Human Behavior*, Vol. 61, pp. 47-55.
- Eurostat (2017), "Database", available at: <http://ec.europa.eu/eurostat/data/database> (accessed 26 April 2017).
- Fosso, W.S. and Carter, L. (2014), "Social Media Tools Adoption and Use by Smes: An Empirical Study", *Journal of End User and Organizational Computing*, Vol. 26, No. 1, pp. 1-16.
- Galati, A., Borsellino, V., Crescimanno, M., Pisano, G. and Schimmenti, E. (2015), "Implementation of green harvesting in the Sicilian wine industry: effects on the cooperative system", *Wine Economics and Policy*, Vol. 4, No. 1, pp. 45-52.
- Galati, A., Crescimanno, M., Siggia, D. and Tinervia, S. (2016), "Website quality and internal business factors: An empirical investigation in the Italian wine industry", *International Journal of Wine Business Research*, Vol. 28, No. 4, pp. 308-326.
- Galati, A., Crescimanno, M., Tinervia, S. and Fagnani, F., (in press), "Social media as a strategic marketing tool in the Sicilian wine industry: Evidence from Facebook", *Wine Economics and Policy*, <http://doi.org/10.1016/j.wep.2017.03.003>.



- Gao, Q. and Feng, C. (2016). "Branding with social media: User gratifications, usage patterns, and brand message content strategies". *Computers in Human Behavior*, Vol. 63, pp. 868-890.
- Garay, L., Font, X. and Pereira-Moliner, J. (2017), "Understanding sustainability behaviour: The relationship between information acquisition, proactivity and performance", *Tourism Management*, Vol. 60, pp. 418-429.
- Genç, M. and Öksüz, B. (2015), "A Fact or an Illusion: Effective Social Media usage of Female Entrepreneurs", *Procedia - Social and Behavioral Sciences*, Vol. 195, pp. 293-300.
- Giacomarra, M., Galati, A., Crescimanno, M. and Tinervia, S. (2016), "The integration of quality and safety concern in the wine industry: the role of third party voluntary certifications", *Journal of Cleaner Production*, Vol. 112, No. 1, pp. 267-274.
- Gunawan, D.D. and Huarng, K.H. (2015), "Viral effects of social network and media on consumers' purchase intention", *Journal of Business Research*, Vol. 68, No. 11, pp. 2237-2241.
- Kaplan, A. M., and Haenlein, M. (2010), "Users of the world, unite! The challenges and opportunities of Social Media", *Business Horizons*, Vol. 53, No. 1, pp. 59-68.
- Kietzmann, J.H., Hermkens, K., McCarthy, I.P. and Silvestre, B.S. (2011), "Social Media? Get serious! Understanding the functional building blocks of social media", *Business Horizons*, Vol. 54, No. 3, pp. 241-251.
- Kim, E. and Drumwright, M. (2016), "Engaging consumers and building relationships in social media: How social relatedness influences intrinsic vs. extrinsic consumer motivation", *Computers in Human Behavior*, Vol. 63, pp. 970-979.
- Kim, S., Koh, Y., Cha, J. and Lee, S. (2015), "Effects of social media on firm value for U.S. restaurant companies" *International Journal of Hospitality Management*, Vol. 49, No. 1, pp. 40-46.
- Kirtis, A.K. and Karahan, F. (2011), "To be or not to be in Social Media arena as the most cost-efficient marketing strategy after the global recession", in *Proceeding of Social and Behavioral Sciences*, 7th International Strategic Management Conference, pp. 260-268.
- Kumar, V. and Mirchandani, R. (2012), "Increasing the ROI of social media marketing", *Sloan Management Review*, Vol. 54, No. 1, pp. 55-61.
- Lau, C. M. (2011), "Team and organizational resources, strategic orientations, and firm performance in a transitional economy", *Journal of Business Research*, Vol. 64, No. 12, pp. 1344-1351.
- Leonidou, L.C., Palihawadana, D. and Theodosiou, M. (2011), "National export- promotion programs as drivers of organizational resources and capabilities: effects on strategy, competitive advantage, and performance", *Journal of International Marketing*, Vol. 19, No. 2, pp. 1-29.
- Mack, E.A., Marie-Pierre, L. and Redican, K. (2017), "Entrepreneurs' use of internet and social media applications", *Telecommunications Policy*, Vol. 41, pp. 120-139.
- Meredith, M.J. (2012), "Strategic Communication and Social Media: An MBA Course From a Business Communication Perspective", *Business Communication Quarterly*, Vol. 75, No. 1, pp. 89-95.
- Michaelidou, N., Siamagka, N.T. and Christodoulides, G. (2011), "Usage, barriers and measurement of social media marketing: An exploratory investigation of small and medium B2B brands", *Industrial Marketing Management*, Vol. 40, No. 7, pp. 1153-1159.
- Moorman, C. (2015), "Measuring the impact of social media on your business", *Forbes*, 18 January 2015, available at: <http://www.forbes.com/sites/christinemoorman/2015/01/18/measuring-the-impact-of-social-media-on-your-business/#25bdb4f46e5> (accessed 28 April 2017).
- Nunan, D., and Yenicioğlu, B. (2013), "Informed, uninformed and participative consent in social media research" *International Journal of Market Research*, Vol. 55, No. 6, pp. 791-808.
- Peters, K., Chenc, Y., Kapland, A.M., Ognibenie, B. and Pauwelsf, K. (2013), "Social media metrics - A framework and guidelines for managing social media", *Journal of Interactive Marketing*, Vol. 27, No. 4, pp. 281-298.
- Quinton, S. and Wilson, D. (2016), "Tensions and ties in social media networks: Towards a model of understanding business relationship development and business performance enhancement through the use of LinkedIn", *Industrial Marketing Management*, Vol. 54, pp. 15-24.
- Sakas, D.P., Dimitrios, N.K. and Kavoura, A. (2015), "The Development of Facebook's Competitive Advantage for Brand Awareness", *Procedia Economics and Finance*, pp. 589-597.
- Statistics Explained (2017), available at: [http://ec.europa.eu/eurostat/statistics-explained/index.php/Main\\_Page](http://ec.europa.eu/eurostat/statistics-explained/index.php/Main_Page) (accessed 26 april 2017).
- Trainor, K.J., Andsulis, J., Rapp, A. and Agnihotri, R. (2014), "Social media technology usage and customer relationship performance: A capabilities-based examination of social CRM", *Journal of Business Research*, Vol. 67, pp. 1201-1208.
- Trusov, M., Bucklin, R. and Pauwels, K. (2009), "Effects of Word-of-Mouth versus traditional marketing: findings from an Internet Social Networking Site", *Journal of Marketing*, Vol. 73, No. 5, pp. 90-102.

- Utz, S. (2015), "The function of self-disclosure on social network sites: Not only intimate, but also positive and entertaining self-disclosures increase the feeling of connection". *Computers in Human Behavior*, Vol. 45, pp.1–10.
- Van Doorn, J., Lemon, K.N., Mittal, V., Nass, S. and Pick, D. (2010), "Customer Engagement Behavior: Theoretical Foundations and Research Directions", *Journal of Service Research*, Vol. 13, No. 3, pp. 253–266.
- Viana, N.A. (2016), "Digital wine marketing: Social media marketing for the wine industry", paper presented at 39th World Congress of Vine and Wine 2016, 24 - 28 October 2016, Bento Goncalves, Brazil, available at: <http://toc.proceedings.com/32248webtoc.pdf> (accessed 26 April 2017).
- Vlachvei, A. and Notta, O. (2014), "Social Media adoption and managers' perceptions", *International Journal on Strategic Innovative Marketing*, Vol. 1, No. 1, pp. 61-73.
- Wallace, E., Buil, I. and de Chernatony, L. (2014), "Consumer engagement with self-expressive brands: brand love and WOM outcomes", *Journal of Product and Brand Management*, Vol. 23, No. 1, pp. 33-42.
- Wamba, S.F. and Carter, L. (2014), "Social media tools adoption and use by SMES: An empirical study", *Journal of Organizational and End User Computing*, Vol. 26, No. 2, pp. 1–17.
- Wang, X., Yu, C. and Wei, Y. (2012), "Social media peer communication and impacts on purchase intentions: a consumer socialization framework", *Journal of Interactive Marketing*, Vol. 26, No. 4, pp. 198–208.
- Whelan, G., Moon, J. and Grant, B. (2013), "Corporations and Citizenship Arenas in the Age of Social Media", *Journal of Business Ethics*, Vol. 118, No. 4, pp. 777–790.
- Wu, C.W. (2016), "The performance impact of social media in the chain store industry", *Journal of Business Research*. doi.org/10.1016/j.jbusres.2016.04.130.
- Zheng, X., Cheung, C.M.K., Lee, M.K.O., and Liang, L. (2015), "Building brand loyalty through user engagement in online brand communities in social networkig sites", *Information Technology & People*, Vol. 28, No. 1, pp. 90–106.

## SUCCESSFUL ORGANISATIONAL MODELS IN THE GREEK WINE INDUSTRY

**Crescimanno, Maria<sup>1</sup>; Galati, Antonino<sup>1</sup>; Tinervia, Salvatore<sup>1</sup>; Iliopoulos, Constantine<sup>2</sup>;  
Theodorakopoulou, Irini<sup>2</sup>; Tulone, Antonio<sup>1</sup>**

<sup>1</sup>Department of Agricultural and Forest Sciences, SAF, Università degli Studi di Palermo, Palermo, Italy

<sup>2</sup>Agricultural Economics Research Institute & Agricultural University of Athens, Greece

### ABSTRACT

The objective of this paper is dual. The first is to identify the key factors that characterize the most successful organizational models of firms operating in the Greek wine industry. The second is to verify if the adoption of third party certifications influences the firms performance. In particular, paying attention on the internal resources of firms, the Resource based view approach is proposed as theoretical framework. Through a cluster analysis has been possible gather the wineries observed on the basis of a similar organisational model, while a non parametric test has been used in order to verify the influence of voluntary certifications on firm performance. Findings show that the most successful wineries are those the most modern, with a higher orientation toward adoption of voluntary certification and managed by expert managers or owners, with a good educational level. The results could provide useful information in order to improve own performances, especially for firms characterized by a limited availability of economic and physical resources.

*Keywords: RBV Approach, Wine industry, Organisational Models, Greece, Quality Certification, Environmental Certification.*

### INTRODUCTION

Despite the globalization phenomenon is not a new in the wine industry, in the last decades its contribution to the complex evolution of world's wine market, has been increasingly decisive. Evidences of this change are the growth of international wine trade, the reconfiguration of the productive scenario, and the changes in the wine consumptions (more oriented toward higher quality products) (Crescimanno and Galati, 2014; Mariani et al., 2012; Rossi et al., 2012; Vrontis et al., 2011). In particular, if in one hand, the effects have been positive for stakeholders in the new producers countries (such as China, New Zealand, South Africa and Chile), in the other hand, this has presented a serious challenge to old producers countries like Italy, Spain and France (Anderson et al., 2003). As results of the increased competitiveness in the international wine trade there is a stronger export orientation by

firms operating in the largest producing countries, which, in order to preserve own competitive advantage in the market, have to adopt new strategies and organizational models more efficient (Mariani et al., 2012; Rastoin et al., 2006).

Now more than ever, the study on the key factors of a successful business model is a fundamental interest of researchers and practitioners. Whereas the success of organizations may be attained through different ways, that is, taking advantage of own internal capabilities, the external position or both (Aghazadeh, 2015), not few authors have examined the different sources of competitive advantage of firms. How emerges from the economic literature, indeed, in addition to the two fundamental perspectives suggested for the comprehension of competitive advantage, based on marketing perspective (Porter, 1985), and internal resources (Wernerfelt, 1984; Barney, 1991), a third perspective has been suggested, that considers the interaction of these two sources for the achievement of competitive advantage (Day, 1994). Not few studies, according to Resource-Based View, have put in light the influence of internal factors on the firms' business performance (Galbreath and Galvin, 2008), in particular on internationalization process, that is, for example, one of key requirements for Small and Medium Enterprises (SMEs) in order to remain on the market (Dutot et al., 2014).

Among the internal resources capable to influence the performance of firms, there are the organizational attributes, which include characteristics of communication flow, emphasis on human resources, decision-making practices, organization of work etc. (Hansen and Wernerfelt, 1989). Among these, over the last decades, the increasing spread of quality and environmental certifications, in the agri-food sector particularly, have drove researchers to analyse the impacts generated by these certifications, both at the market and firm level.

Economic literature is full of studies about the impacts of the adoption of voluntary certifications and the important role that they play for the companies oriented to improve own economic performance and beyond (i.e. Gómez-Conde et al., 2013; Chen et al., 2015; Macheke et al., 2013; Henson et al., 2011; Suburvie and Vagneron, 2013). However, few studies have assessed the impact of the adoption of a voluntary certification on economic, financial and organizational performance of firms operating in the wine industry (i.e. Aggelogiannopoulos et al., 2007; Giacomarra et al., 2016).

In view of the above, in this paper we employed, as theoretical lens, the Resource-Based View of the firm in order to identify the key factors for a successful organizational models, in terms of superior export and economic performance, and verify a relationship between adoption of third party certifications and firms performance.

An empirical survey has been carried out in Greece, in particular, we focused in Attica and Peloponnese, two of the most important Greek wine regions both in terms of area under vines (over a quarter of the Greek area devoted to wine grape production, is in this two regions), and qualitatively

(considering that more than 25.0% of PDO wines is produced in these two regions) (New wines of Greece, 2016), both characterized by a significant presence of Small and Medium Enterprises (SMEs) and micro enterprises.

Our paper is structured as follows. After this introduction, we first introduce the theoretical framework. The following sections describe the research approach and the results. Finally, we end the paper with concluding remarks in last section.

## **THEORETICAL FRAMEWORK**

Since decades, studies on strategic management of enterprises enhance the role of company's internal resources, as potential sources of competitive advantage, adopting a different approach in relation to that was used previously studies mainly focused on the influence of external factors and, according to which, the competitive advantage derives exclusively from the placement of firms in the market (Porter, 1985). The Resource-Based View (Wernerfelt, 1984) agrees and supports this point of view, but also suggests a number of empirical indicators by which to identify resources that can provide a competitive advantage (Barney, 1991). The RBV has its roots in the Theory of the Growth of the Firm formulated by Penrose (1959), the first economist to recognize the role of resources in the process of growth and development of enterprises, but the analysis of the performance of companies based on internal resources has spread only after that Barney (1991) has defined the characteristics and explained how these are to be used in order to gain a sustainable competitive advantage and durable. According to the Author, in fact, companies operating within the same industry differ in terms of internal resources, in other words, each company has a unique bundle of resources that distinguishes it from its competitors. Furthermore, these internal resources beyond to be characterised by a marked heterogeneity, they have to be also Valuable, Rare, Inimitable and Non-substitutable, in order to generate a sustainable and durable competitive advantage.

Barney (1991) has also classified the resources in three different categories: (i) tangible resources, including the technology used, the facilities, equipment, geographic location and access to raw materials; (ii) intangible resources, which include human capital, such as the level of training, experience and knowledge of employers and employees, as well as their relationships that determine the quality of the work environment of an enterprise; (iii) and, organizational capital, or communication skills (within the enterprise and between enterprises), planning, control and coordination. Makadok (2001), instead, makes a distinction between a firm's resources and capabilities. The former can be observable but not necessarily tangible asset that can be independently valued and traded. The second are unobservable and hence necessarily intangible, cannot be independently valued, and changes hands only as part of its entire unit.

Today the RBV is one of the most widely accepted theoretical perspectives in the strategic management field, probably because is focused on the role of internal resources which, not only can affect the performance of firms, but also influence the marketing strategy decisions.

In this study our attention is focused on the role played by tangibles and intangibles internal resources of firms, associated both to the firms and managers characteristics, and to the organizational resources, in the generation of successful business models.

Concerning the firms' characteristics, numerous studies reveal that larger size of firms in terms of number of employees or sales, that is, firms with a greater availability of resources and, are more likely to export activity than smaller ones (Erramilli and Rao, 1993; Suárez-Ortega and Álamo-Vera, 2005; Maurel, 2009). How suggested by some authors (Majocchi et al., 2005; Suárez-Ortega and Álamo-Vera, 2005) firms' age can be considered a potent explanatory variables of the export performance, since it could be considered synonym of maturity in the field of management, international transactions, and business partnerships. Other authors (Kotabe et al., 2002; Fernandez Olmos, 2011), instead, find that one of the main determinants that can contribute to increase the degree of firms' internationalization is the amount of investments in advertising and promotion activities.

As it is evident from the economic literature, managerial characteristics also have a relevant influence on the organizational model choice of firms. Age of managers and owners and their level of education are explanatory variables of the firms' export performance. Some evidences, suggest that younger entrepreneurs are more associated with policies of corporate growth than older managers and more risk-oriented (Suárez-Ortega and Álamo-Vera, 2005; Serra et al., 2012), as well as, managers with a higher degree of education are more able to use the opportunity of exploring new context (Tihanyi et al., 2000; Wieserma and Bantel, 1992).

Finally, we consider the implementation of quality or environmental certifications, like a organizational resource that can represent a key factor of the successful organizational models. How suggested by Sampaio et al. (2009), the effects generated by the adoption of voluntary certifications on economic and organizational performance of companies can be grouped into two categories, namely internal and external effects. In the first category they include the impacts that occur in the interior of firms, such as the improvement of the quality of products and of efficiency of production processes (Kafetzopoulos and Gotzamani, 2014; Karaman et al., 2012; Mensah and Julien, 2011). The second one, instead, contains the external effects related to sales, marketing and communication activities. How Has been found by several authors, the adoption of quality and environmental certifications, may represent a useful tool for improve the economic performance in terms of labour productivity (Gomez Conde et al., 2013), turnover and overseas market share (Macheka et al., 2013; Chen et al., 2015), increasing of selling price of products (Suburvie and Vagneron, 2013), and achieve higher income

levels than non-certified companies (Dora et al., 2013; Handschuch et al., 2013). In particular, in the wine sector, Aggelogiannopoulos et al. (2007), with reference to a small Greek wine cellar, have shown that the adoption of a voluntary certification can result in the improvement of the level of internal communication, the growth in market share and the opportunity to enter new foreign markets. Other advantages offered by adoption of voluntary certifications has been highlighted by Giacomarra et al. (2016). In the Italian wine industry, in fact, the implementation of a voluntary certification represent a factor able to improve performance of certified wineries in terms of efficiency of production processes.

## **METHODOLOGICAL APPROACH**

### The questionnaire

In order to identify the key factors affecting the most successful organizational models of Greek wineries an ad hoc questionnaire was constructed based on the RBV approach. The questionnaire consist of four parts, each of which aims to capturing the needed information in order to explain the influence of firms' and managers' characteristics on the economic and exportation performances of wineries. The first section is focused on the general information on wineries. In particular the questions concern the location and the legal form of firm, the starting year of activity and sales in foreign markets. In add, in order to establish the physical size of firms, we ask the production capacity (in terms of annual number of wine bottles produced), and the number of fix employees. The second part allows to define the entrepreneurs or managers profile. This section gathers information such as age, years of experience in the wine sector and the education level. In the third part we collect information about commercial aspects. More in detail, in order to establish the economic size of wineries we ask the average annual turnover, wine production, while in order to assess the export orientation of firms we ask the percentage of turnover generated by the sold in the foreign markets. In the same section, are included also the questions concerning the promotion, business and marketing activities, such as sales channels (Ho.Re.Ca., wine shops, wine bar, Large-Scale Retail trade, direct selling or through intermediaries), investments in advertising (in terms of percentage of annual turnover), participation to fairs (national and international). The last part of questionnaire is focused on the adoption of voluntary certifications by wineries. To each interviewed has been submitted a list of quality and environmental management systems the most widespread in the agri-food and wine industry (i.e. ISO family, BRC, IFS Food, GlobalG.A.P.), and we asked if the own winery adopts on or more of these.

### The samples

The target population is represented by the wineries operating in the Greek wine industry. In particular, the sample consist of 41 wineries, identified thanks to the lists provided by Greek Wine Federation and Central Union of Wine Producing Cooperative Organizations of Greece (KEOSOE) which include, 112 wineries, on the whole. The information was collected through the submission of the questionnaire by telephone, email or face-to-face. The samples reflect the distribution of wineries in the Attica and Peloponnese areas (with a higher number of wineries in East Attica and Corinthia).

The main characteristics of firms and managers, are synthesized in Tables 1 and 2. How emerges by data, there is a prevalence of individual firms that operate in the wine sector since 33 years on average and prefer sell through intermediaries. More than half adopts at least one voluntary certification.

Table 1 - Description of Greek wineries

Characteristics		n=41
Legal form (%)	Individual firms	68.3
	Companies and cooperatives	31.7
Physical and economic size (mean values)*	Number of employees	6 (1; 18)
	Number of wine bottle (thousand of bottles)	232.5 (1.9; 1,000)
	Turnover (thousand of euro)	709 (6.7; 4,700)
	Experience (mean values)*	Number of year
Certifications (%)	Firms adopting quality and/or environmental certifications	51.2
Fair participation (mean values)*	Number of annual participation	2.1 (0.0; 5.0)
Export experience (mean values)*	Number of year	15.6 (0.0; 56.0)
Direct selling (%)	Product sold directly	45.3 (0.0; 100.0)

\* In brackets minimum and maximum values.

Wineries observed are managed by old owners or managers with a high education level and a work experience of 26 years on average.

Table 2 - Description of Greek managers

Characteristics		n=41
Age (%)	Less than 40 years old	9.8
	Between 40 and 65 years old	78.0
	More than 65 years old	12.2
Educational level (%)	Primary education	0.0
	Lower secondary education	0.0
	Upper secondary education	12.2
	Bachelor level	87.8
Experience (mean value)*	Number of year	25.9 (4.0; 45.0)

\* In brackets minimum and maximum values.

## The method

With the aim of identify similar organizational models among the Greek wineries observed, and verify which of these are those with the most successful, on the basis of their internal resources, we performed a hierarchical cluster analysis using SPSS software version 21. The variables included in the model are expression both of the firms characteristics and managers, as well as, of the organizational



resources of firms. Among the firms characteristics, we considered the age of wineries in terms of number of activity years (Fernandez Olmos, 2011; Maurel, 2009), the export experience that is valued in terms of number of years of trade in the foreign markets of firms (Galati et al., 2014), the size of firms in terms of number of fixed employees (Maurel, 2009; Fernandez Olmos, 2011; Galati et al., 2014), the efforts in promotion and advertising in terms of annual number of participations to national and international wine fairs (Galati et al., 2014), and finally, the percentage of volume of product sold directly by firms how description of sale strategy. Regarding to the profile of managers, we have inserted in the cluster analysis the variable that is expression of their educational level (Suárez-Ortega and Álamo-Vera, 2005; Maurel, 2009; Fernandez Olmos, 2011; Galati et al., 2014), while, about the organizational resources of firms, we have included two variables (QC and EC), that are, the adoption of quality and environmental certifications (i.e. IFS Food, GlobalG.A.P., and ISO family's certifications) in light of their positive effects on the increase the international presence of firms (Lieberman et al., 2010). The Ward's method has been selected, among the other clustering criteria, in order both to minimize the intra-cluster distance and maximize inter-cluster distance, and to obtain a similar amount of observations in each cluster and that no outliers were present among the variables included in the model. The distance among clusters has been measured using the squared Euclidean distance. In order to identify the number of cluster components, in addition to the dendrogram examination, scree plot, and the VRC using the ANOVA procedure for each of three segment solutions, we did a two-steps cluster analysis, using the same variables and specifying the most probable solution in terms of number of cluster, and we have performed the analysis again changing the order of observation in the dataset.

In order to verify if the adoption of third party certifications influences the firms performance, we carried out the Mann-Whitney U test for the comparison of two independent samples. The two samples are composed by certified and non-certified firms, respectively, and the index adopted for the measure of firm performance were, the Labour Productivity (LP) and the Export Intensity (EI). The first index, previously used in other empirical researches in order to assess the economic performance of firms (Giacomarra et al., 2016; Ullah et al., 2014; Gómez Conde et al., 2013; Starke et al., 2012), is the ratio between the annual turnover and the number of fix employees. The second index, instead, explains the export performance of firms and it is obtained by the ratio between the value of turnover on foreign markets and the total turnover. The choice to apply a non-parametric test, derives from the fact that the values of these index are not normally distributed inside of the investigated samples (this information emerges from the test results of the normality of Shapiro-Wilk).

## RESULTS AND DISCUSSION

The results of cluster analysis and the average values for the variables studied are presented in the Table 3. Each cluster includes, respectively, 11, 7, 6 and 17 wineries.

Table 3 - Description of clusters

Cluster	No. of cases	Export exp.	No. of employees	Age of winery	Educational level of manager	Direct selling	Fair participation	QC	EC
1	11	14.36	6.09	21.54	3.90	61.27	2.09	.72	.27
2	7	5.00	4.57	21.71	3.57	98.57	2.00	.43	.00
3	6	32.83	7.33	92.00	4.00	34.17	1.83	.50	.17
4	17	14.70	6.59	23.76	3.94	17.06	2.17	.41	.17

Table 4 shows the analysis of variance between and within clusters, the result of the Fisher test (F) and the model significance. Results show that four clusters are statistically different and three variables are statistically significant at the 99% level, while one variable is significant at the 95%. In particular, the variable "Direct selling" is the most influential variable in the profile of clusters (F=68.411), while "Educational level of manager" is the less influential (F=2.857).

Table 4 - Analysis of variance (ANOVA) between and within clusters

	Cluster			Error			F	Sig.
	Mean square	between groups	df	Mean square	within groups	df		
Educational level of manager	.826		3	3.565		37	2.857	.050
No. of employees	28.950		3	962.074		37	.371	.774
Age of winery	24,669.224		3	5,731.215		37	53.087	.000
QC	.730		3	9.514		37	.947	.428
EC	.319		3	5.486		37	.718	.548
Fair participation	.567		3	46.213		37	.151	.928
Direct selling	36,973.549		3	6,665.671		37	68.411	.000
Export experience	2,598.848		3	5,110.908		37	6.271	.001

The results show that wineries with the lowest experience in the sector and the highest level of adoption of quality and environmental certifications (even if these variables are not statistical significant), are grouped in the first cluster, which could mean that firms more modern and more willing to adopt innovations (like voluntary certifications). Furthermore, the same wineries are characterized also by the highest economic performance (in terms of average turnover) and highest participation to international fairs. This result partially confirming that, the adoption of voluntary certifications helps to improve the firms performances (He et al., 2015; Kafel and Sikora, 2012).

Wineries grouped in the second cluster are those characterized by the lower physical and economical size, with the lower experience in the export activities and the lower diffusion of environmental certifications. In addition these wineries are conducted by managers or owners with the lower education level and the lower proficiency in foreign languages, among all people interviewed. These wineries are more oriented to the local market, in light of the highest participation to national fairs and the highest volume of product directly sold.

The third cluster, is composed by the oldest and the biggest wineries (in terms of number of employees and production of bottles), with the longer experience in the export activity, among all the

wineries observed, however, they show a low frequency of participation at oenological fairs or other exhibitions. Managers and owners of these wineries are the younger and they are characterized by the higher educational level and the best knowledge of foreign languages.

The last cluster includes wineries with a highest frequency of participation to wine fairs. They are characterized by the lowest spread of quality certifications and by the lowest volume of product directly sold. Furthermore, this group includes also the older managers/owners which compose our sample. These findings, considering that the same wineries are also the most market oriented (on the basis of percentage of product sold in the foreign markets), are contrasting with findings of Serra et al. (2012) and Suárez-Ortega and Álamo-Vera (2005), according to which younger managers (or entrepreneurs) are more risked-oriented and adopt market-oriented strategies. The same people show a good level of education, this confirms how asserted by Tihanyi et al. (2000) and by Wieserma and Bantel (1992), that is, managers with a good degree of education are more able to take advantage of the opportunity offered by new international markets. The high volume of product sold through intermediaries-exporters could explain the good export performance of these wineries. In line with the results obtained by other authors (Mohsenzadeh and Ahmadian, 2016; Al-Ali et al., 2013), this result underlines how a good competence in the management of marketing and sales (including the selection of distribution channels) can affect the export performance of firms. Regarding to the highest participation to wine fairs, a good promotion capability in global markets, including all marketing related activities, allows firms to adapt to foreign markets, to persuade global consumers to purchase their products (Murray et al., 2011) and increase export sales (Hultman, et al., 2011).

In the first part of our study, through a cluster analysis, we identified four different organisational models characterizing our sample, after that, our investigation continues with the verification of the existence of a relationship between adoption of voluntary certifications aside of wineries and their performances.

Table 5 shows the rank values (mean and sum) which show a substantial similarity between certified and not-certified wineries in terms of LP, while the same groups seem different in terms of EI.

Table 5 - Mann-Whitney U test (ranks)

	N	Mean Rank	Sum of Ranks
Labour Productivity			
Certified wineries	21	21.45	450.50
Not-certified wineries	20	20.53	410.50

Export Intensity

Certifies wineries	21	24.26	509.50
Not-certified wineries	20	17.58	351.50

How emerge by Table 6, the value of Monte Carlo significance (greater than 0.05) does not allow to reject the null hypothesis and essentially confirms the absence of differences in terms of LP and EI between certified and non-certified wineries. In other words, certified and non-certified wineries, originate from the same population. These results are conflicting with findings of Gómez Conde et al. (2013) which found that the adoption of voluntary certification positively affects both the level of internationalization of Spanish food companies (measured by an index based on the share of total sales generated by overseas sales), both their performance (expressed in terms of labor productivity). Conversely, these agree with results of Schuster e Maertens (2015) which reveal how the adoption of third party certification does not exercise any influence on the export performance of Peruvian firms.

Table 6 - Mann-Whitney U test (statistics)

		LP	EI
Mann-Whitney U		200.500	141.500
Z		-0.248	-1.791
Asymp. Sig. (2-tailed)		0.804	0.073
Monte Carlo Sig. (2-tailed)	Sig.	0.805	0.072
	99% Confidence Interval	Lower bound	0.795
		Upper bound	0.815
			0.079

## CONCLUDING REMARKS

The present study shows that Greek wineries included in our sample are characterized by similar organisational models, more or less successful. In particular, the most successful wineries are those the most modern, with a higher orientation toward adoption of voluntary certification and managed by expert managers and owners, with a good educational level. However, the results of test implemented do not provide any significantly statistically evidence that confirms a relationship between adoption of voluntary certifications and firm performance (both in terms of Labour Productivity, and Export Intensity).

From academic point of view, this is one of the few studies aimed to understand the role of internal resources and, at the same time, of important strategic tools like voluntary certifications, in the characterization of organizational models in the firms operating in the wine industry. Furthermore, we empirically verified the theoretical tenets of RBV approach, according to which, firms' resources can influence the organization and the performance of firms.

Beyond the theoretical implications, our paper provides a valuable support for firms' decision makers which operate in this industry, for the purpose of choose the most appropriate strategy in

order to improve their economic and organizational performance. Results obtained, suggest that, a greater promotional commitments and advertising investments, so as to have a greater visibility, (for example through a higher participation to national and international fairs), could help firms to improve their performance, while, has been seen also that a correct choice of sale strategy and sale channels, allows to take advantages of the opportunities offered by international markets.

For policymakers, findings suggest the need to develop policies aimed to help, in particular, the small-scale wineries in their internationalisation process, supporting them, for example, in the introduction of useful innovations, such as quality or environmental certifications required to sell in some sensible markets.

Obviously, this study shows some limitations. One of these is that study is focused in the wine industry exclusively, in addition, the area investigated, is limited to two (even though important) wine regions of Greece, and the sample analysed, is not representative for entire population, so, any effort to extend results to other industries, represents an error.

Finally, considering the obtained results and that not many studies have faced this issue in the wine industry, and in particular in the Greek wine industry, could be interesting, for future research, analyse the organizational models taking into consideration also external factors, through a multiple theoretical approach.

## REFERENCES

- Aggelogiannopoulos, D., Drosinos, E.H. and Athanasopoulos, P. (2007), "Implementation of a quality management system (QMS) according to the ISO 9000 family in a Greek small-sized winery: A case study", *Food control*, Vol. 18 No. 9, pp. 1077-1085.
- Aghazadeh, H. (2015), "Strategic Marketing Management: Achieving Superior Business Performance through Intelligent Marketing Strategy". *Procedia - Social and Behavioral Sciences*, Vol. 207, pp.125-134.
- Al-Aali, A., Lim, J.S., Khan, T. and Khurshid, M. (2013), "Marketing capability and export performance: the moderating effect of export performance", *South African Journal of Business Management*, Vol. 44 No. 3, pp. 59-70.
- Anderson, K. Norman, D. and Wittwer, G. (2003), "Globalisation of the World's Wine Markets", *The World Economy*, Vol. 26, No. 5, pp. 659-687.
- Barney, J. (1991), "Firm resources and sustained competitive advantage", *Journal of Management*, Vol. 17 No. 1, pp. 99-120.
- Chen, E., Flint, S., Perry, P., Perry, M. and Lau. R. (2015), "Implementation of non-regulatory food safety management schemes in New Zealand: A survey of the food and beverage industry". *Food Control*, Vol. 47 No. 1, pp. 569-576.
- Crescimanno, M. and Galati, A. (2014), "Competitiveness of Italian wines in the international market", *Bulgarian Journal of Agricultural Science*, Vol. 20, No. 1, pp. 12-22.
- Day, G.S. (1994). "The Capabilities of Market-Driven Organizations", *Journal of Marketing*, Vol. 58, No. 4, pp. 37-52.
- Dora, M., Kumar, M., Van Goubergen, D., Molnar, A. and Gellynck, X. (2013), "Food quality management system: Reviewing assessment strategies and a feasibility study for European food small and medium-sized enterprises", *Food Control*, Vol. 31 No. 2, pp. 607-616.
- Dutot V., Bergeron F. and Raymond, L. (2014), "Information management for the internationalization of SMEs: an exploratory study based on a strategic alignment perspective", *International Journal of Information Management*, Vol. 34 No. 5, pp. 672-681.

- Erramilli, M.K. and Rao, C.P. (1993), "Service firms' international entry-mode choice: a modified transaction-cost analysis approach", *Journal of Marketing*, Vol. 57, No. 7, pp. 19-38.
- Fernandez Olmos, M. (2011), "The determinants of internationalization: evidence from the wine industry", *Applied Economic Perspective and Policy*, Vol. 33, No. 3, pp. 384-401.
- Galati, A., Crescimanno, M., Rossi, M., Farruggia, D. and Tinervia, S. (2014), "The determinants affecting the internationalization of the Italian SMEs producing sparkling wines: an empirical study on the RBV of the firms", *International Journal of Globalisation and Small Business*, Vol. 6, No. 2, pp. 100-118.
- Galbreath, J. and Galvin, P. (2008), "Firm factors, industry structure and performance variation: New empirical evidence to a classic debate", *Journal of Business Research*, Vol. 61 No. 2, pp. 109-117.
- Giacomarra, M., Galati, A., Crescimanno, M. and Tinervia, S. (2016), "The integration of quality and safety concern in the wine industry: the role of third party voluntary certifications", *Journal of Cleaner Production*, Vol. 112, No. 1, pp. 267-274.
- Gómez Conde, J., Lopez-Valeiras Sampedro, E., Ripoll Fliu, V. and Gonzalez Sanchez, M.B. (2013), "Management control system and ISO certification as resources to enhance internationalization and their effect on organizational performance", *Agribusiness*, Vol. 29 No. 3, pp. 392-405.
- Handschuh, C., Wollni, M. and Villalobos, P. (2013), "Adoption of food safety and quality standards among Chilean raspberry producers e do smallholders benefit?", *Food Policy*, Vol. 40 No. 1, pp. 64-73.
- Hansen, G.S. and Wernerfelt, B. (1989), "Determinants of Firm Performance: The Relative Importance of Economic and Organizational Factors", *Strategic Management Journal*, Vol. 10, No. 5, pp. 399-411.
- He, W., Liu, C., Lu, J., and Cao, J. (2015), "Impacts of ISO 14001 adoption on firm performance: Evidence from China", *China Economic Review*, Vol. 32, pp. 43-56.
- Henson, S. Masakure, O. and Cranfield, J. (2011), "Do Fresh Produce Exporters in Sub-Saharan Africa Benefit from GlobalGAP Certification?", *World Development*, Vol. 39 No. 3, pp. 375-386.
- Hultman, M., Katsikeas, C.S. and Robson, M.J. (2011), "Export promotion strategy and performance: The role of international experience", *Journal of International Marketing*, Vol. 19 No. 4, pp. 17-39.
- Kafel, P. and Sikora, T. (2012). *Quality Management Systems benefits and their influence on financial performance*. 6th International Quality Conference June 08th 2012.
- Kafetzopoulos, D.P. and Gotzamani, K.D. (2014), "Critical factors, food quality management and organizational Performance", *Food Control*, Vol. 40 No. 1, pp. 1-11.
- Karaman, A.D., Cobanoglu, F., Tunalioglu, F. and Ova, F. (2012), "Barriers and benefits of the implementation of food safety management systems among the Turkish dairy industry: a case survey", *Food Control*, Vol. 25 No. 2, pp. 732-739.
- Kotabe, M., Srinivasan, S.S. and Aulakh, P.S. (2002), "Multinationality and firm performance. The moderating role of R&D and marketing capabilities", *Journal of International Business Studies*, Vol. 33, No. 1, pp. 79-97.
- Liberman, S., Baena, V. and Moreno, F. (2010), "International expansion of the Chilean wine industry: An empirical study concerning the factors and exportation levels", *Cuadernos de Gestion*, Vol. 10, No. 1, pp. 35-74.
- Macheka, L., Manditsera, F.A., Tambudzai Ngadze R., Mubaiwa, J. and Kuziwa Nyanga, L. (2013), "Barriers, benefits and motivation factors for the implementation of food safety management system in the food sector in Harare Province, Zimbabwe", *Food Control*, Vol. 34 No. 1, pp. 126-131.
- Majocchi, A., Bacchiocchi, E. and Mayrhofer, U. (2005), "Firm size, business experience and export intensity in SMEs: a longitudinal approach to complex relationships", *International Business Review*, Vol. 14, No. 6, pp. 719-738.
- Makadok, R. (2001), "Towards a synthesis of resource-based and dynamic capability view of rent creation", *Strategic Management Journal*, Vol. 22, pp. 387-402.
- Mariani, A., Pomarici, E. and Boatto, V. (2012), "The international wine trade: Recent trends and critical issues", *Wine Economics and Policy*, Vol. 1, No. 1, pp. 24-40.
- Maurel, C. (2009), "Determinants of export performance in French wine SMEs", *International Journal of Wine Business Research*, Vol. 21, No. 2, pp.118-142.
- Mensah, L.D. and Julien, D. (2011), "Implementation of food safety management systems in the UK", *Food Control*, Vol. 22 No. 8, pp. 1216-1225.
- Mohsenzadeh, M. and Ahmadian, S. (2016), "The Mediating Role of Competitive Strategies in the Effect of Firm Competencies and Export Performance", *Procedia Economics and Finance*, Vol. 36, pp. 456-466.
- Murray, J.Y., Gao, G.Y. and Kotabe, M. (2011), "Market orientation and performance of export ventures: The process through marketing capabilities and competitive advantages", *Journal of the Academy of Marketing Science*, Vol. 39 No. 2, pp. 252-269.
- New Wines of Greece (2016), <http://www.newwinesofgreece.com/home/> (accessed 12 February 2017).
- Penrose, E.T. (1959). *The theory of the growth of the firm*. New York, Wiley.

- Porter, M.E. (1985), *Competitive advantage: Creating and sustaining superior performance*. New York, NY, Free Press.
- Rastoin, J.L., Montaigne, E., and Coelho, A. (2006), "Globalisation du marché international du vin et restructuration de l'offre", *INRA Sciences Sociales*, N.º 5-6.
- Rossi, M., Vrontis, D. and Thrassou, A. (2012), "Wine business in a changing competitive environment – strategic and financial choices of Campania wine firms", *International Journal of Business and Globalisation*, Vol. 8, No. 1, pp. 112-130.
- Sampaio, P., Saraiva, P. and Guimarães Rodrigues, A. (2009), "ISO 9001 certification research: questions, answers and approaches", *International Journal of Quality & Reliability Management*, Vol. 26 No. 1, pp. 38-58.
- Schuster, M. and Maertens, M. (2015), "The Impact of Private Food Standards on Developing Countries' Export Performance: An Analysis of Asparagus Firms in Peru", *World Development*, Vol. 66 No.1, pp. 208-221.
- Serra, F., Pointon, J. and Abdou, H. (2012), "Factors influencing the propensity to export: a study of UK and Portuguese textile firms", *International Business Review*, Vol. 21, No. 2, pp. 210-214.
- Starke, F., Eunni, R.V., Fouto, N.M.M.D. and de Angelo, C.F. (2012), "Impact of ISO 9000 certification on firm performance: evidence from Brazil", *Management Research Review*, Vol. 35 No. 10, pp. 974-997.
- Suárez-Ortega, S.M. and Álamo-Vera, F.R. (2005), "SMES' internationalization: firms and managerial factors", *International Journal of Entrepreneurial Behaviour & Research*, Vol. 11, No. 4, pp. 258-279.
- Subervie, J. and Vagneron, I. (2013), "A drop of water in the Indian Ocean? the impact of GlobalGap certification on lychee farmers in Madagascar", *World Development*, Vol. 50, No. 1, pp. 57-73.
- Tihanyi, L., Ellstrand, A., Daily, C. and Dalton, D. (2000), "Composition of the top management team and firm international diversification", *Journal of Management*, Vol. 26, No. 6, pp. 1157-1167.
- Ullah, B., Wei, Z. and Xie, F. (2014), "ISO certification, financial constraints, and firm performance in Latin American and Caribbean countries", *Global Financial Journal*, Vol. 25, No. 3, pp. 203-228.
- Vrontis, D., Thrassou, A. and Rossi, M. (2011), "Italian wine firms: strategic branding and financial performance", *International Journal of Organizational Analysis*, Vol. 19, No. 4, pp. 288-304.
- Wernerfelt, B. (1984), "A resource-based view of the firm", *Strategic Management Journal*, Vol. 5 No. 2, pp. 171-180.
- Wieserma, M. and Bantel, K. (1992), "Top management team demography and corporate strategic change", *Academy of Management Journal*, Vol. 35, No. 1, pp. 91-121.

## NEW PERSPECTIVES IN MANAGING RISKS IN SMES

Crovini, Chiara

Department of Management, University of Turin, Turin, Italy, chiara.crovini@unito.it

### ABSTRACT

The present study concentrates on risk management in SMEs and provides the hypotheses and reasons behind the non-implementation of this process.

This research represents a theoretical contribution in the field of corporate and risk governance of SMEs. It differs from other studies because it does not follow incremental gap-spotting ideals but instead emphasizes assumption-challenging in the construction of research questions, which are formulated by problematizing some dominant assumptions in existing research. To do that, this paper follows the philosophical and epistemological concepts of abduction and pragmatism, elaborated by Charles Peirce.

The purpose of this paper is to understand from which point of view it is necessary to restart analysing the topic of risk management in SMEs and to suggest a new perspective that could lead managers and owners of small and medium enterprises to improve their risk attitude.

In particular, the research underlines the necessity to concentrate on the human being and his personality and to consider risk management as an integral part of decision-making.

*Keywords:* risk management, SMEs, theoretical paper, decision-making, new perspectives

### INTRODUCTION

Since 2008, the global crisis has revealed significant new problems in risk assessment and management, caused by the increasing uncertainty derived from a demanding environment. Risk management is a transversal process to each company and has a strategic importance because it helps managers set and possibly achieve the objectives of their companies. So why is there a lack of sensitivity in adopting a sound risk approach, especially in SMEs?

Why, despite all the literature regarding the importance of having an adequate internal control system, are there still cases of bankruptcy and scandals?

One of the most important reasons lies in the fact that the management of risks in some realities, especially in those very small, is seen as a burden and a final objective itself.

SMEs represent an important reality in the entire economic system. They are crucial in promoting economic growth at the international level and their vitality helps reduce the unemployment rate.



Therefore stability and prosperity of SMEs assume systemic value for all countries (World Trade Organisation, 2013).

In many countries, there is no regulatory or institutional code of risk management: SMEs do not usually adopt a formalised risk management process. But in some cases there is no need to formalise this process or to implement the ERM systems.

This research represents a theoretical contribution in the field of corporate and risk governance of SMEs. It differs from other studies because it does not follow incremental gap-spotting ideals but instead emphasizes assumption-challenging in the construction of research questions, which are formulated by problematizing some dominant assumptions in existing research (Davis, 1971). To do that, this paper follows the philosophical and epistemological concepts of abduction and pragmatism, elaborated by the American philosopher Peirce.

This paper has been motivated by the need to understand from which point of view it is necessary to restart analysing the topic of risk management in SMEs and to suggest a new perspective that could lead managers and owners of small and medium enterprises to improve their risk attitude. In particular, there will be the necessity to concentrate on the human being and his personality and to consider risk management as an integral part of decision-making.

The paper is organised as follows. The research design with details about the methodology and epistemological approach are stated in the second section. The theoretical background about the risk management process in SMEs is presented in the third paragraph. New perspectives on the theme and discussions about theory development instead are in the fourth section. The final paragraph instead deals with the conclusion.

## **RESEARCH DESIGN**

This research represents a theoretical contribution in the field of risk management in SMEs. It differs from other studies because it contradicts incremental gap-spotting ideals, by emphasizing assumption-challenging in the construction of research questions (Alvesson and Kärreman, 2007, 2011; Sandberg and Tsoukas, 2011).

There are several works following different methodologies concentrating on the management of risks in SMEs. They focus on specific kinds of risks or on procedures to be implemented in a small- and medium-sized company. They all underline the importance of developing a sound risk governance and an appropriate approach.

But why are still there corporate failures? Why is still there an immature approach in managing risks in SMEs? Why is risk management still regarded as a burden or a major cost?

It seems that academics should investigate more the real reasons behind this phenomenon.

This study follows a methodology that is less focused on gap-spotting and incremental contributions. The aim is to formulate research questions by problematizing some dominant assumptions in existing research (Davis, 1971). Formulating novel research questions through problematization involves not just using a particular preferred meta-theoretical standpoint in order to challenge the assumptions of others (as is often the case in the paradigm debates) or as in various applications of critical perspectives (Alvesson and Sandberg, 2011). 'Real' problematization also involves questioning the assumptions underlying one's own meta-theoretical position (Alvesson and Sandberg, 2013a). The ambition is to unpack one's own position sufficiently so that some of the ordinary held assumptions can be scrutinized and reconsidered in the process of constructing novel research questions.

The aim of the problematization methodology 'is to come up with novel research questions through a dialectical interrogation of one's own familiar position, other stances, and the domain of literature targeted for assumption challenging' (Alvesson and Sandberg, 2011, p. 252). This approach would support a more reflective-scholarly attitude (Abbott, 2004) and consider a different epistemological approach.

To do that, the following methodological principles are central (Alvesson and Sandberg, 2013b):

- (1) identify a domain of literature;
- (2) identify and articulate assumptions underlying this domain;
- (3) evaluate them;
- (4) develop an alternative assumption ground;
- (5) consider it in relation to its audience;
- (6) evaluate the alternative assumption ground.

Successful problematization is a matter of creativity, intuition, reading inspiring texts that offer critical insights (but without being accepted as a new fixed framework), talking to other people, having specific experiences, or making observations that may trigger new thinking (Alvesson and Sandberg, 2013a). This methodology also has the advantage of facilitating focus, working as a support for a research identity around being a problematizer and a path-up setter (and not a gap-spotter), and facilitating description of what one has done and accomplished (Alvesson and Sandberg, 2013b). The conventional notion of rigour, requesting to systematically vacuum clean existing literature to demonstrate how to make a contribution to the extant literature, should be combined with imagination (Cornelissen and Floyd, 2009; Donaldson et al., 2012; Weick, 1989). However, while conventional rigour in the sense of logical consistency and thoroughness requires to analyse the underlying assumptions of the existing literature, in this paper those assumptions are studied in order to conceptualize the subject matter in question: risk management in SMEs.

To do that, this paper follows the philosophical and epistemological concepts elaborated by the American philosopher Peirce: abduction and pragmatism.

Peirce abduction had its proper place in the context of discovery, the stage of inquiry in which we try to generate theories which may then later be assessed. In his opinion abduction is the process of forming explanatory hypotheses and it is the only logical operation which introduces any new idea. Deduction and induction, then, come into play at the later stage of theory assessment: deduction helps derive testable consequences from the explanatory hypotheses that abduction has helped the researchers conceive, and induction finally helps reach a verdict on the hypotheses, where the nature of the verdict is dependent on the number of testable consequences that have been verified.

Peirce's pragmatism has a sort of a constructivist approach because he admits the possibility to change one's own opinion, values and thought, and it represents another form of relativism in which objective and convincing critiques might change the reality and the assumptions of a researcher.

Constructivism considers knowledge and learning as the result of a collective dimension of interpretation of reality. The new knowledge is built not only on the basis of what has been gained in past experiences but also through sharing and negotiation of meanings expressed by a "community of interpreters." The "construction" is therefore based on cognitive maps that serve to individuals to orient themselves and build their own interpretations.

In this case, the study aims at creating hypotheses to solve the following research problems:

- *Research problem 1:* Why, despite several studies underlying the importance to implement control activities and procedures to manage risks, SMEs do not integrate risk management in their business?
- *Research problem 2:* In this context of profound change in the risk approach, how could researchers lead SMEs to reconsider risk management?
- *Research problem 3:* What are the theoretical bases academics should refer to in order to support the development of sound and effective corporate governance and internal control system?

## **THEORETICAL BACKGROUND.**

*Risk and uncertainty: the importance of managing risks.*

It is necessary to present the theoretical background about the topic of risk and uncertainty in order to show the central role that risk management has been acquired over the past few decades.

Starting from the topic of risk, Bernoulli in 1738 proposed to measure risk with the geometric mean and to minimize risk by spreading it across a set of independent events (Bernoulli, 1954).

The concept of risk has been the subject of careful and important studies in the general economic field since the beginning of the twentieth century (Willet, 1901; Fisher, 1919; Hardy, 1931).

Knight (1921) was one of the most important thinker and distinguished between risk and uncertainty with respect to the nature of decisions made in a company. He associated generating economic profit with making entrepreneurial decisions under uncertainties. This uncertainty is complex because it cannot be reliably hedged unless it is reducible to risk. In his opinion, the mathematics of probability that is used for risk calculations may lose relevance. Fast-and-frugal heuristics, on the other hand, provide robust strategies that can perform well under uncertainty. Therefore, risk and uncertainty are strictly linked to the topic of decision-making (Mousavi and Gigerenzer, 2014).

In the business administration field, the research of Oberparleiter (1955), Chapman and Cooper (1983) and Sassi (1940) was particularly important. The common element of all these studies is that risk can be the possibility of economic or financial losses or gains, as a consequence of the uncertainty associated with pursuing the course of an action. But more specifically risk is considered an *adverse eventuality*.

Risk has consequences in terms of economic performance and professional reputation, in addition to environmental and social considerations. Despite the underlying element of uncertainty, it is often possible to predict risks and to set in place systems and design actions to minimize their negative consequences and maximize the positive ones (Kaplan and Mikes, 2012). Those risks that arise from disorder can be controlled through better management and governance. This way, businesses that adopt a risk management strategy and adequate planning and programming are more likely to survive and grow (Amaduzzi, 1961; Brusa, 2012).

Therefore the concept of risk is not unique but depends on the situation in which the company operates, on the uncertainty every company might face and on the consequences of certain events. Furthermore risk is inherent to and part of the existence of every company (Bertini, 1987; Ferrero, 1987). Uncertainty and negative consequences were also discussed by Ferrero (1987). He stated that there are two kinds of uncertainties: objective and subjective. The former are linked to the unknown in an absolute sense and they depend on the knowledge and the environment that surround the company. Subjective uncertainties instead can be dominated by the management because they are linked to insufficient information and to the informative system of the company.

Risk management theories evolved in particular after the COSO Report (1992) and its updated version (2004), elaborated by Committee of Sponsoring Organizations of the Treadway Commission. The movement towards enterprise risk management (ERM) (COSO, 2004) has shifted the focus to a more holistic appreciation of risk. It highlights that appropriate risk-based controls need to be put in place to help ensure that organizational objectives are achieved (Soin and Collier, 2013).

Several researchers concentrated on the definition of the risk management (RM) process and on the Enterprise Risk Management (ERM), by analysing all phases and activities (Brustbauer, 2016;

Henschel, 2009). In particular, COSO Report underlines that the risk management process has eight components interrelated with the management process of the company. These components are the following: internal environment; objective setting and Risk Appetite Framework (RAF); event identification; risk assessment; risk response; control activities; information and communication; and monitoring.

Consequently, the risk management process can be seen in a strategic way, because it is functional to the development of the company strategy and control (D'Onza, 2008; Coso Report, 2004). Therefore it deals with planning, organising, directing and controlling resources to achieve given objectives when unexpectedly good or bad events can happen (Head, 2009) and it also provides a link between organizations and the external environment in which they operate. In addition, risk management is the key driver for value creation, competitiveness and profitability (D'Onza, 2008).

The research of Michael Power (2004; 2007; 2009) presents a different and critical approach towards risk management because he raises a number of issues, also concerning the role of management accountants, that are of particular interest for management accounting and control researchers. Two elements are particularly relevant: the side effects of risk management and the relationship between risk management and uncertainty. Power argues about the 'risks of risk management' and the emergence of 'secondary' or 'defensive' risk management.

He suggests that: "experts who are being made increasingly accountable for what they do are now becoming more preoccupied with managing their own risks"(Power, 2004).

Power states that this "culture of defensiveness" (p. 14) can be seen in the 'individualization' of risk by various professionals – whereby, experts are becoming pre-occupied with managing their own risk which necessitates reflexive behaviour (Beck, 1992; Giddens, 1990). Further side effects include blame avoidance (Hood, 2002), fear of sanctions, legalization and the re-drawing of (organizational) boundaries that arguably may lead to a re-enforcing of the 'box ticking' culture.

In terms of risk management and uncertainty there have been substantial developments in organizational practice that focus on risk management and issues of governance, but the impact of risk and uncertainty has not been fully explored. Managers have always faced uncertainty, which is a central feature of any organizational setting. Power (2007) underlines that when uncertainty is organised, it becomes a risk to be managed. The range of uncertainties deemed in need of management has significantly increased and includes threats such as operational risks, reputational risks and strategic risks. Therefore the new wave of risk management can be regarded as a defensive reaction to an increasingly demanding environment.

There emerge the need for an 'intelligent' risk management which is not control obsessed, but based on knowledge and on risk appetite framework, an impoverished concept that may lead to board failure and that should be redefined and enforced (2009).

*Risk management in SMEs: the state of the art.*

As regards SMEs, they have little guidance on how best to manage risk and where to turn to for advice. Over the past few years few Guidelines, representing conceptual frameworks, have been published. Some of them represent Corporate Governance Codes for Unlisted Companies (OECD, 2006; ecoDa, 2010; OECD, 2015) and in 2009 the International Organisation for Standardisation (ISO) elaborated ISO 31000:2009 about Risk Management and in 2016 ISO published a practical guide for SMEs about how to implement risk management.

The literature reveals that risk management in SMEs is still in an early phase of development and is rather fragmented (Verbano and Venturini, 2013; Marcelino-Sádaba et al., 2014). Despite that, several national and international studies highlight the immaturity with which companies and, in particular, SMEs face risks. This approach can derive on the one hand from the lack of familiarity, the fear of change and additional costs that the implementation of a risk management system could result and, on the other, from the actual lack of awareness of the benefits that an integrated risk management system might have, not only in terms of prevention, but also as regards the opportunities (Hiebl, 2013; Thun et al., 2011). Most unlisted enterprises are owned and controlled by single individuals or coalitions of company insiders (e.g. a family). In many cases, owners continue to play a significant direct role.

Good governance in this context is not a question of protecting the interests of absentee shareholders (*agency theory*: Jensen & Meckling, 1976). Rather, it is concerned with establishing a framework of company processes and attitudes that add value to the business and help ensure its long-term continuity and success, by satisfying the stakeholders' needs (*stakeholder theory*: Freeman, 1984).

Furthermore many SMEs face resource constraints (Jarillo, 1989). Consequently, existing resources need to be used with care as erroneous decisions will have more serious complications than they would in large businesses (Amelingmeyer and Amelingmeyer, 2005).

Therefore risk management would better cope with these resource constraints (Smit and Watkins, 2012) and deal with the issues of survivability and growth (Islam et al., 2008).

Vargas-Hernandez (2011) underlined that a further motivation to support the implementation of risk management in SMEs is to protect innovative projects, which are fundamental to gain competitive advantage and succeed in the market, but necessarily involve risky decisions and activities.

Many other studies focused on the role of risk management in SMEs and on the risk attitude of those companies (Gao et al., 2013; Mutezo, 2013; Gilmore et al., 2004; Hollman, 1984).

Some researchers instead concentrated on specific kinds of risk in SMEs and how they are managed (Poba-Nzaou, 2011; Sukumar et al., 2011).

Furthermore research on the most effective procedures of risk management in SMEs was conducted (Henschel, 2010), even if it is still at a very early stage (Rautenstrauch and Wurm, 2008). In particular, Henschel (2010) identified the missing integration of the identified risks into the business planning as the main problem. According to him, this integration is needed to determine the complex risk position of each company, which is also influenced by the firm size.

In other studies, Islam et al. (2008) and Islam and Tedford (2012) aimed at identifying potential risks existing within the SME infrastructure, by developing and testing a strategic RM framework. This model consists of five steps: identification of disturbances (undesirable events and setbacks), identification and classification of root causes, classification of origins of disturbance, risk assessment and risk handling and monitoring and control. The research findings suggest that SMEs encounter disturbances in the areas of production, safety and business operation. These studies also highlighted a lack of systematic RM strategies among the SMEs surveyed.

McCarthy (2000) explored how entrepreneurs think about risk and deal with it in the strategy formation process, demonstrated that risk-taking propensity is subject to change, depending on the business development. McCarthy and Block et al. (2015) underlined that entrepreneurs should be considered in their own uniqueness because with learning, organisational context and history, they influence the development of a sound risk approach.

As regards risk assessment, Herbane (2010) underlined that this task represents a daily activity but it has a tacit and implicit nature rather than being formalised in a planned risk analysis. Risk framing is a result of the owner's personal experience and knowledge derived from being part of informal networks.

## **NEW PERSPECTIVES IN MANAGING RISKS IN SMES.**

The theoretical background of the previous paragraphs helps answer the first research problem, because it underlines that the above-mentioned studies in the field of risk management in SMEs concentrated on specific kinds of risks, or on the strategic aspect of this process or on the importance to develop appropriate procedures and control activities in order to assess, manage and monitor risks. The research of Power, McCarty, Block et al. and Herbane instead centre the point and the real problem: many SMEs do not integrate the risk management process in their business because there is little knowledge about the potential benefits, there is a lack of a developed risk attitude and behaviour. It is a matter of mindset, managers' personality and history of the company. That

represents the answer to the first research problem and the first hypothesis, as explanation of the phenomenon.

Afterwards, to answer the second and third research problem, by trying to suggest an appropriate way of thinking to find a solution that might lead SMEs to consider risk management as fully integrated in the business, it is important to analyse what COSO Report (2004) states in the Executive Summary: *Limitations in managing risks can result from the fact that human judgment in decision making can be faulty. Decisions on how to respond to risk and establish controls need to consider the relative costs and benefits, breakdowns can occur because of human failure, such as simple errors or mistakes, controls can be circumvented by collusion of two or more people, and management has the ability to override ERM decisions. These limitations may prevent boards from achieving the entity's objectives.*

Consequently, there emerges that risk management activities are strictly related to strategic decision-making. The new perspective for the improvement of managers and owners' risk attitude and for the integration of the risk management process in the business of every SME is to start analysing the way decisions are made. Decision-making is the process of choosing the best alternative to achieve individual and organizational objectives (Guo, 2008). Therefore this process is inherent in all managerial functions and is closely related to the planning function. People responsible for setting and achieving certain objectives are also responsible for managing the related risks.

There are different models describing the decision-making process. In this case, the research refers to the model elaborated in 2008 by Kristina Guo for health care managers, called DECIDE, which is an acronym that stands for six different steps:

- D: define the problem;
- E: establish the criteria, being as specific and precise as possible in order to understand what should be achieved or avoided;
- C: consider all alternatives that could meet the criteria;
- I: identify the best alternative;
- D: develop and implement a plan of action;
- E: evaluate and monitor the solution and feedback when necessary.

The steps of this model are related and they are similar to those of the risk management process (Figure 1).



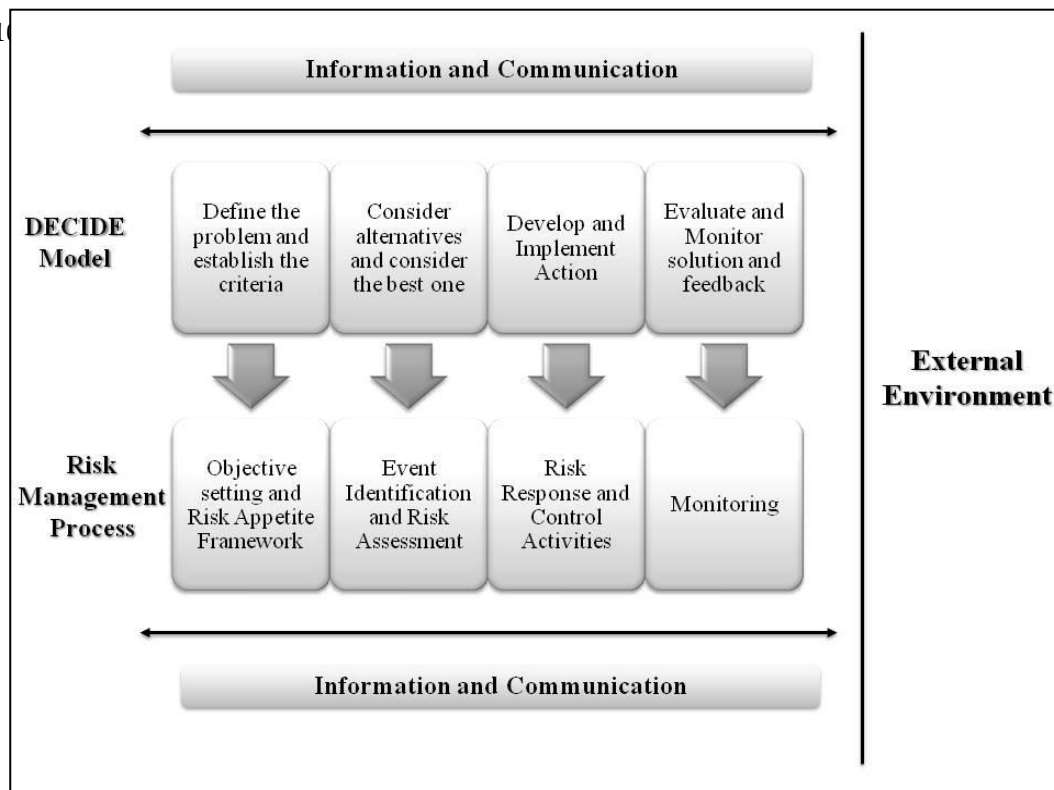

Figure 1. Risk management process and decision-making model: a comparison.

Defining the problem and setting the objectives are the first step in both processes. It is important to establish the risk appetite and the way decisions could be made. Afterwards, every manager should consider the possible choice to make and identify events that could generate risks. Thirdly, there emerges the need to make the choice and respond to the risk with appropriate actions. The final step of both processes consists of evaluating and monitoring the solution. It is not enough to just make a decision. It is crucial to evaluate the decision made and actions implemented and to investigate 'what could go wrong.' This step helps prevent, minimize and overcome all possible adverse consequences. Feedback is important because it provides information related to the decision or risk response. Feedback helps a manager find out whether the decision or control activities led to the intended results, even if unintended consequences may have occurred. Information and communication are always present during these processes.

In SMEs risk management, as entrepreneurs do not usually implement it formally, may become fully embedded when they make a decision, as they are both crucial in setting and achieving the objectives. Furthermore, improving knowledge, the risk appetite and the awareness of how decisions should be made means implicitly to start developing a risk consciousness, which can be translated into a sound risk approach. Moreover corporate culture, values and ethics play a fundamental role in each company because they represent the internal environment that can affect the business management.

## CONCLUSION

This research underlines and demonstrates that in the field of risk management in SMEs it is important to understand why in most of the cases risk procedures and control activities are not implemented. There is no need to further underline the importance and the role of the internal control system and of risk governance because other researchers did. The real problem is to understand from which point of view it is necessary to restart analysing again this subject matter and to suggest a new perspective that could lead managers and owners of small and medium enterprises to improve their risk attitude.

To solve this problem, the solution might be to start concentrating on the human being and on the way he makes decisions for his company. Furthermore it is fundamental to consider that a preliminary and, often unconscious, risk analysis is conducted while making the decision. Therefore by starting improving the awareness, responsibility and sensitivity to risks, managers and owners would improve their knowledge about their company and about the risk appetite framework. Only after passing this step, then we could talk about procedures and control activities to be implemented and about the formalisation of this dynamic and transversal process.

Risk management, as integral part of the organisational decision-making process, enables the small and medium-sized company to be resilient and agile in all its activities by dealing with consequences of unforeseen events.

Integrating risk management means adopting ways to enhance and improve the managerial processes that already exist. Therefore it is necessary to first understand how decisions are made and implemented and then determine how managing risks should be integrated into those decisions.

This theoretical analysis contributes to existing knowledge as it extends the platform for research on strategic decision-making in SMEs, by associating it to the risk management process in order to provide a new way of regarding it in SMEs.

One of the limits of this paper is that it is the first step of a far deeper analysis that should lead to further qualitative and empirical investigation for researchers in the field of corporate governance and risk governance of SMEs and it might be useful for managerial practice.

Additional empirical research, regarding in particular the implementation and control of risk management in SMEs, is needed in order to shed more light on the difficulties small and medium enterprises face and to identify practical strategies to help these companies.

Multiple-case studies in particular would better fit into this framework because it is fundamental to validate and test theories and concepts analysed in this study.

For owners and managers of SMEs, a better understanding of the decision-making process and the potential benefits of having a risk-oriented mindset provides the basis for improving the risk appetite framework and therefore enhancing the setting of organisational objectives.

For practitioners and professional accountants, this study could be useful in providing the evidence that they play a key role for managers and owners of SMEs, because they are consultants with the aim of being collaborative in the decision-making process and helping them achieve the objectives, satisfy the stakeholders and create value over the long period.

## REFERENCES

- Abbott, A. (2004). *Methods of Discovery: Heuristics for the Social Sciences*. New York: W. W. Norton.
- Alvesson, M. and Kärreman, D. (2007). Constructing mystery: empirical matters in theory development. *Academy of Management Review*, 32, 1265–81.
- Alvesson, M. and Kärreman, D. (2011). *Qualitative Research and Theory Development. Mystery as Method*. London: Sage.
- Alvesson, M. and Sandberg, J. (2011). Generating research questions through problematization. *Academy of Management Review*, 36, 247–71.
- Alvesson, M. and Sandberg, J. (2013a). *Constructing Research Questions: Doing Interesting Research*. London: Sage.
- Alvesson, M. and Sandberg, J. (2013b). Has Management Studies Lost Its Way? Ideas for More Imaginative and Innovative Research, *Journal of Management Studies*, 50(1), 128-152
- Amaduzzi, A. (1961). *La pianificazione nell'economia dell'azienda industriale*. Giappichelli, Torino
- Amelingmeyer, J. and Amelingmeyer, G. (2005). Wissensmanagement beim Führungswechsel in KMU, in Meyer, J-A. (Ed.): *Wissens- und Informationsmanagement in kleinen und mittleren Unternehmen*, pp.479-488, Josef Eul Verlag, Lohmar, Cologne.
- Beck, U. (1992). *Risk Society: Towards a New Modernity*. Sage, London
- Bernoulli, D. (1954). Exposition of a new theory on the measurement of risk. *Econometrica*, 22(1), 23-36.
- Bertini, U. (1987). *Introduzione allo studio dei rischi nell'economia aziendale*. Giuffrè, Milano
- Block, J., Sandner, P. and Spiegel, F. (2015). How do risk attitudes differ within the group of entrepreneurs? The role of motivation and procedural utility, *Journal of Small Business Management*, 53(1), 183-206.
- Brusa, L. (2012). *Sistemi manageriali di programmazione e controllo*, Giuffrè, Milano
- Brustbauer, J. (2016). Enterprise risk management in SMEs: Towards a structural model., *International Small Business Journal*, 34(1), 70-85
- Chapman, C.B., & Cooper, D.F. (1983). Risk engineering: Basic controlled interval and memory models. *Journal of the Operational Research Society*, 34(1), 51-60.
- Committee of Sponsoring Organizations of the Treadway Commission (COSO), (1992). *Internal Control-Integrated Framework*, <http://www.coso.org/guidance.htm> [Last accessed: June 18, 2016]
- Committee of Sponsoring Organizations of the Treadway Commission (COSO), (2004). *Enterprise Risk Management-Integrated Framework*, <http://www.coso.org/erm-integratedframework.htm> [Last accessed June 18, 2016]
- Cornelissen, J. and Floyd, S. W. (2009). The future ahead: imagination, rigour and the advancement of management studies. *Journal of Management Studies*, 46, 11–5.
- Davis, M. S. (1971). That's interesting! Towards a phenomenology of sociology and a sociology of phenomenology. *Philosophy of Social Sciences*, 1, 309–44.
- Donaldson, L., Qiu, J. and Luo, B. N. (2012). For rigour in organizational management theory research. *Journal of Management Studies*, 50, 153–72.
- D'Onza, G. (2008). *Il sistema di controllo interno nella prospettiva del risk management*. Giuffrè, Milano
- ecoDa. (2010). *Corporate Governance Guidance and Principles for Unlisted Companies in Europe*, ecoDa publishing, Brussels, [www.ecoda.org](http://www.ecoda.org) [Last accessed June 18, 2016]
- Ferrero, G. (1987). *Impresa e Management*. Giuffrè, Milano
- Fisher, I. (1919). *Nature of capital and income*. MacMillan, New York

- Freeman, R.E. (1984). *Strategic Management - A Stakeholder Approach*. Pitman Publishing, Boston
- Gao, S.S., Sung, M.C., and Zhang, J. (2013). Risk management capability building in SMEs: A social capital perspective, *International Small Business Journal*, 31(6), pp. 677-700.
- Giddens, A. (1990). *The Consequences of Modernity.*, Polity, Cambridge.
- Gilmore, A., Carson, D., and O'Donnell, A. (2004). Small business owner-managers and their attitude to risk., *Marketing Intelligence & Planning*, 22(3), pp. 349-360.
- Guo, K.L. (2008). DECIDE: a decision-making model for more effective decision making by health care managers. *The Health Care Manager*, 27 (2),118–127
- Hardy, C.O. (1931). *Risk and Risk-bearing.*, The University of Chicago Press, Chicago
- Head, L.G. (2009). *Risk Management – Why and How*. International Risk Management Institute, Dallas
- Henschel, T. (2009). *Implementing a Holistic Risk Management in Small and Medium Sized Enterprises (SMEs)*. Edinburgh Napier University School of Accounting, Economics & Statistics, UK. <http://sbaer.uca.edu/research/icsb/2009/paper173> [Last accessed June 18, 2016]
- Henschel, T. (2010). *Erfolgreiches Risikomanagement im Mittelstand*, Erich Schmidt, Berlin.
- Herbane, B. (2010) ‘Small business research: time for a crisis-based view’ , *International Small Business Journal*, 28(1), pp.43-64.
- Hiebl, M.R.W. (2013). Risk aversion in family firms: what do we really know?, *The Journal of Risk Finance*, 14(1), 49-70.
- Hollman, K. W., and Mohammad-Zadeh, S. (1984). Risk Management in Small Business, *Journal of Small Business Management*, 22(1), 7-55.
- Hood, C. (2002). The Risk Game and the Blame Game. *Government and Opposition*, 37(1), 15-37
- Islam, M.A., Tedford, J.D. and Haemmerle, E. (2008).Managing operational risks in small- and medium-sized enterprises (SMEs) engaged in manufacturing - an integrated approach, *International Journal of Technology, Policy and Management*, 8(4), 420-441.
- Islam, A. and Tedford, D. (2012). Risk determinants of small and medium-sized manufacturing enterprises (SMEs) - an exploratory study in New Zealand, *Journal of Industrial Engineering International*, 8(12), 1-13.
- ISO - International Organisation of Standardisation (2009). ISO 31000, Principles and generic guidelines on risk management. <http://www.iso.org> [Last accessed May 31, 2016]
- ISO - International Organisation of Standardisation (2016). ISO 31000: Risk management – A practical guide for SMEs. <http://www.iso.org> [Last accessed May 31, 2016]
- Jarillo, J.C. (1989). Entrepreneurship and growth: the strategic use of external resources, *Journal of Business Venturing*, 4(2), 133-147.
- Jensen, M.C., and Mackling, W.H. (1976). Theory of the Firm: Managerial Behaviour, agency costs and ownership structure, *Journal of Financial Economics*, 3(4), 305-360
- Kaplan, R.S.,and Mikes A. (2012). *Managing Risks: A New Framework.*, Harvard Business Review, 90(6), 16 pp.
- Knight, F.H. (1921), *Risk, Uncertainty and Profit.*, Hart, Schaffner & Marx; Houghton Mifflin Co., Boston
- Marcelino-Sádaba, S., Pérez-Ezcurdia, A., Echeverría Lazcano, A.M. and Villanueva, P. (2014). Project risk management methodology for small firms., *International Journal of Project Management*, 32(2), 327-340.
- McCarthy, B. (2000).The cult of risk taking and social learning: a study of entrepreneurs, *Management Decision*, 38(8), 563-574.
- Mousavi, S.,and Gigerenzer G. (2014). Risk, uncertainty and heuristics, *Journal of Business Research*, 67(2014), 1671-1678
- Mutezo, A. (2013). Credit rationing and risk management for SMEs: the way forward for South Africa., *Corporate Ownership & Control*, 10(2), 153-163.
- Oberparleiter, K. (1955). *Funktionen und Risiken des Warenhandels*, Spaeth & Linde, Wien
- OECD (2006), *Corporate Governance of Non-Listed Companies in Emerging Markets*, OECD Publishing, Paris
- OECD (2015), *G20/OECD Principles of Corporate Governance*, OECD Publishing, Paris.
- Poba-Nzaou, P., and Raymond, L. (2011). Managing ERP system risk in SMEs: A multiple case study., *Journal of Information Technology*, 26(3), 170-192.
- Power, M. (2004). *The risk management of everything : rethinking the politics of uncertainty*. Demos, London
- Power, M. (2007). *Organized uncertainty: designing a world of risk management*. Oxford; Oxford University Press, New York
- Power, M. (2009). The risk management of nothing. *Accounting, Organizations and Society*, 34, 849-855
- Rautenstrauch, T. and Wurm, C. (2008). Stand des Risikomanagements in deutschen KMU, *Zeitschrift für Krisen-, Sanierungs- und Insolvenzberatung*, Vol. 4, No. 3, pp.106-111.
- Sandberg, J. and Tsoukas, H. (2011). Grasping the logic of practice. *Theorizing through practical rationality*, *Academy of Management Review*, 36, 338–60.

- Sassi, S. (1940). *Il sistema dei rischi d'impresa.*, Vallardi, Milano
- Smit, Y. and Watkins, J.A. (2012) 'A literature review of small and medium enterprises (SME) risk management practices in South Africa', *African Journal of Business Management*, 6(21), 6324-6330.
- Soin, K. and Collier, P. (2013). Risk and risk management in management accounting and control, *Management Accounting Research*, 24(2), 82-87
- Sukumar, A., Edgar, D., and Grant, K. (2011). An investigation of e-business risks in UK SMEs., *World Review of Entrepreneurship, Management and Sustainable Development*, 7(4), 380-401.
- Thun, J.H., Drüke, M., and Hoenig, D. (2011). Managing uncertainty – an empirical analysis of supply chain risk management in small and medium-sized enterprises., *International Journal of Production Research*, 49(18), 5511-5525.
- Vargas-Hernandez, J.G. (2011). Modelling Risk and Innovation Management. *Advances in Competitiveness Research*, 19 (3-4), 45-57.
- Verbano, C., and Venturini, K. (2013). Managing risks in SMEs: A Literature Review and Research Agenda. *Journal of Technology Management & Innovation*, 8(3), 186-197
- Weick, K. E. (1989). Theory construction as disciplined imagination. *Academy of Management Review*, 14, 516-31.
- Willet, A.H. (1901). *The economic theory of risk and insurance*, in *Studies in History, Economics and Public Law.*, Vol. XIV, The Columbia University Press, New York
- World Trade Organisation (2013). *Global value chains in a changing world.* WTO Publications, Geneva

## UNDERSTANDING “CREATING SHARED VALUE”

Daood, Antonio; Menghwar, Prem Sagar

Department of Management, Sapienza University of Rome, Rome, Italy.

### ABSTRACT

Creating Shared Value (CSV) has been presented as the saviour of capitalism, a way to vanquish the perception that business profit at the expense of society. The concept of solving societal issues by gaining economic benefits has caught the attention of companies and prominent researchers. Yet, CSV has been referred to as nothing more than a buzzword and criticized because of similarities with existing models and lack of empirical evidences. In this paper, we offer new perspectives on CSV analysing it from the points of view of related concepts, such as stakeholder theory, sustainability, social entrepreneurship, Bottom of the Pyramid, Blended Value and CSR. Examples and discussion outline fundamental differences among similar concepts, thereby shedding light on CSV and both strengths and limitation thereof. Conclusions pave the way to a clear understanding of CSV concept, the *locus* of which include, but is not limited to, CSR, while giving directions for further research and theoretical development.

*Keywords: Corporate Social Responsibility, Creating Shared Value, Business, Society, societal value, economic value.*

### INTRODUCTION

The debate about CSV revolves around different paradigms according to which business can gain economic returns and create value for society. Stakeholder theory, social entrepreneurship, sustainability, Bottom of the Pyramid (henceforth, BoP), Blended value, CSR and CSV are clearly intermixed (Dembek et al., 2015) because they produce the same outcome (i.e. creating societal value), although different from each other in many ways. The objective of this article is to develop some propositions on CSV in order to facilitate a clear understanding thereof. This paper is structured as follows: we first provide an overview on CSV; we then discuss each one of the concepts overlapping with CSV in a step by step fashion, analysing both literature and practice to highlight differences and similarities with CSV, thereby contributing diverse perspectives on its theoretical stance; we finally present conclusions and indicate direction for CSV theoretical development.

*Creating Shared Value*

Business and society coexist and thrive alongside one another, with the former having a value creating role towards the latter (Moran and Goshal, 1996). This is the portrait of the economic and social development, or at least it used to be before the heightened public awareness of the dangers of human activities for the environment unveiled that business may also exert detrimental actions on society. Unresolved steady social problems and the urgency of global challenges such as climate change, the consequences of which appear to be every day closer, have led to an increasingly large number of individuals paying greater attention to these issues. Clamorous cases of improper business conduct and natural catastrophes associated with poor risk management practice have certainly contributed to spread the perception that business profits at the expense of society. Given the situation, Porter and Kramer (2011) came up with the concept of Creating Shared Value, according to which companies can solve societal problems in profitable ways. Strategic decisions about how to allocate corporate resources are carrying higher level of complexity because nowadays companies are also assessed on how they met social expectations (Waddock and Graves, 1997). The idea behind CSV is to integrate social issues into the capitalistic economic mechanism in order to enlarge benefits for both business and society, thereby enabling the reconciliation of the two separated realms. Porter and Kramer, (2011; 2012) identified three ways by which companies can create shared value, namely a) reconceiving products and markets, b) rethinking productivity in the value chain, and c) local cluster development. Since its inception, CSV reached the ears of many corporate leaders providing them with lens to see social problems as growth opportunities (Pfitzer et al., 2013). Scholars researched insights on how CSV initiatives might enlarge the total value created for business itself, society and the environment (e.g. Bowe and van der Horst, 2015; Schmitt and Renken, 2012; Spitzack and Chapman, 2012; Vaidyanathan and Scott, 2012; Esposito et al., 2012), while others extended the concept (e.g. Moon et al., 2011). Therefore, there is no doubt about CSV being an appealing and useful concept, although it has been referred to as *"a bit undercooked"* (Schumpeter, 2011). Porter and Kramer (2011) have certainly not been particularly rigorous in the development of CSV, neither in grounding the concept with due theoretical background (Crane et al., 2014; Beschorner, 2014). In particular, the claim that CSV supersedes CSR has been legitimately criticized in the literature (Crane et al., 2014; Beschorner, 2014), giving rise to several issues concerning the originality of the concept. Because our goal is to provide a clear understanding of CSV as a theoretical concept, we analyse it through the points of view offered by stakeholder theory, social entrepreneurship, sustainability, Blended Value, BoP, and CSR, thereby *"cooking"* CSV a little bit more.

## PROPOSITIONS: TOWARDS AN UNDERSTANDING OF CREATING SHARED VALUE

### *Stakeholder theory*

Stakeholder theory challenged the conventional conception of the firm as a closed entity which operates solely in the interest of shareholders (Freeman, 1984; Freeman et al., 2007). According to stakeholder theory, firms have to take into account the needs and interest of the actors who either influence or are influenced by them (Freeman, 1984; Freeman et al., 2007). For this very reason, by not considering the firm in a vacuum, stakeholder theory naturally embraces sustainability and corporate social responsibility because it is in the interest of customers, governments, employees and shareholders that companies conduct sustainable and responsible businesses (Jeurissen, 2004; Freeman et al., 2007; Tricker, 2012). Stakeholder management *“has become commonplace in the management literature, both academic and professional”* (Donaldson and Preston, 1992: 65) primarily because business continuity strongly depends upon them. With regards to stakeholder management as source of value creation, CSV actions has been referred to as strategically effective because they simultaneously create value for different stakeholder groups (e.g. shareholders and society) and does not reduce the value of other stakeholders (Tantalo and Priem, 2014). CSV has been referred to as a stakeholder management approach (Crane et al., 2014; Beshcorner, 2013). It is clear how the process by which a firm shifts to a *“greener”* production process, thereby contributing to pollution abatement, can be seen as a stakeholder management practice. Especially when a firm has hard-hitting negative externalities on the environment, we believe the whole population of the Earth might be considered as a stakeholder group. Therefore, CSV is certainly included in stakeholder management, but it is not limited to it. For example, at time  $t$  a company may invest a significant amount of money in a foreign underdeveloped country to create the conditions wherein the demand for its product naturally blossoms at time  $t_1$  because of societal development. At time  $t_0$ , when the decision was taken, the customers were not possibly included among the stakeholders of the firm. Therefore, we propose that CSV opportunities are not bound to the extant groups of stakeholders considered at a given time.

*P<sub>1</sub>: CSV is a stakeholder management practice, although opportunities to create shared value are not bound by the stakeholders considered as such by the firm.*

The stakeholder approach to strategic management offers an important perspective on CSV, which also relates to the call made by Beschorner (2014: 110) for *“normative corporate philosophy”* to answer the questions *“what does our company stand for? What is our contribution to society? What are our fundamental values and what business strategies emerge out of them?”* (Beschorner, 2014: 110). These questions have been addressed through the *“enterprise level strategy”* by Freeman (1984: 101). Freeman (1984) suggests a firm should pursue a stockholder strategy if managers believe the externalities of the firm are mainly of



economic nature, prioritize the obligation to shareholders, and perceive economic growth as the main social issue. On the other hand, a firm should pursue a utilitarian strategy if managers perceive the firm to have diverse effect on stakeholders, prioritize the maximization of social benefit, and identify many social issues affecting the firm (Freeman, 1984). If we were to follow this line of thought, we would say that CSV as strategy represent a compromise between stockholder and utilitarian strategy, through the pursuit of which managers can attend their fiduciary obligation to shareholders while creating social benefit, not necessarily provoking misfit across the different stakeholder interests, corporate values, and societal issues as intended by the two strategies. Therefore, we propose the following:

*P<sub>2</sub>: Through the pursuit of CSV as strategy, managers can attend their fiduciary obligation to shareholders while creating societal value, not necessarily provoking misfit across the various stakeholder interests, corporate values, and societal issues perceived as important by the firm.*

#### *Sustainability*

Due to the heightened interconnectedness of economic, environmental and social issues of our century, firms are expected to have a major role in sustainable development (Buller and McEvoy, 2016), since “the responsibility for ensuring a sustainable world falls largely on the shoulders of the world’s enterprises” (Hart, 1997: 76). In both their 2006 and 2011 articles, Porter and Kramer use the very same example of a firm creating economic value (i.e. cost reduction) by reducing its negative externalities (i.e. waste reduction). On the one hand, they give evidence of sustainability practice with McDonald’s reducing its waste changing wrapping materials (Porter and Kramer, 2006), on the other hand they point out the capability of Wal-Mart to address both business and societal needs by reducing its packaging (Porter and Kramer, 2011). However, CSV initiatives are not *per se* environmentally sustainable. For instance, a firm can create shared value by training and employing thousands of young teenagers as brand ambassadors in a region characterized by high illiteracy rate which result in increased brand awareness and sales. If the product sold consist of a drink bottled in non-recyclable bottles, besides profits for the firm and better living condition for a part of the local community, this operation results also in more pollution, which is to be considered as social cost. It might be the case that the social benefits are greater than social costs, that is social value creation, but it can certainly not be defined as an environmentally sustainable practice.

*P<sub>3</sub>: CSV is not per se sustainable.*

#### *Social entrepreneurship*

Social entrepreneurship can be seen either as addressing societal problems using business-like approaches (Pomerantz, 2003), wherein the social dimension is the core objective, or as addressing societal problems to generate economic returns, wherein the social dimension is central because

recognized as source of opportunities to be exploited. With regards to the latter, social entrepreneurs are more prone to find business opportunities in social challenges because they are not bound by narrow thinking induced by traditional business mental models (Porter and Kramer, 2011; Elkington and Hartigan, 2008). Social entrepreneurship as intended by Mort et al. (2003) consist of balancing the interests of multiple stakeholders while maintaining the social mission. Boundaries of the social entrepreneurship concept are blurred as well. Some enclose social entrepreneurship within the non-profit sector (Dees et al., 2002) bearing in mind that non-profit does not necessarily mean non-income, with wealth being a means to achieve the social mission and income being the condition for self-sustainability. Others point out that social entrepreneurship is not to be confined within non-profit boundaries (Abu-Saifan, 2012). We tend to consider particularly valuable the contribution of Abu-Saifan (2012: 26-27) who conceives social entrepreneurship as limited to *"non-profit with revenue"* and *"for-profit with mission"*. In comparison with CSV, not all the revenue-generating activities necessarily generate income (i.e. economic value) and, most important, theoretically a for-profit does not have to have a social mission to create shared value. As a matter of fact, Maltz and Schein (2012: 63-65) distinguish between *"economics-first"* and *"mission driven"* perspectives on the basis of the emphasis managers who engage in shared value initiatives place on the economic or social dimension, respectively. Hence, we propose that CSV is not limited to for-profit organizations who have a social mission as their core objective.

*P4: To create shared value, a firm does not have to have a social mission as its core objective.*

The literature on social entrepreneurship offers another perspective on CSV. Starting from Dees' identification of social entrepreneurship as one species in the genus entrepreneurship (1998), Austin et al. (2006) differentiated *commercial* from *social entrepreneurship*, with the former being the identification and seizure of opportunities resulting in profits, while the latter being the identification and seizure of opportunities resulting in social value creation. CSV can be seen as the marriage between two types of entrepreneurship, being the identification and seizure of opportunities resulting in both profit and social value creation.

*P5: CSV occurs within the continuum between commercial and social entrepreneurship.*

#### *Blended Value*

Economic and social value are interconnected and indivisible, as highlighted by Freeman (1984: 40). Building on this line of thinking, the concept of blended value was introduced by Emerson (2003a; 2003b) who challenged the conventional view that economic value is separate from social value since it ignores the dynamic interplay between the two. According to him, the trade-off between social and economic value which leads to a zero-sum game is a misconception, because these values are integrated with each other, or blended (Emerson, 2003a; 2003b). Traditionally economic value and social value

were considered as separate from each other and task of different types of organizations. According to blended value, every organization generates value that comprises of economic, social, and environmental components, since each of its activities simultaneously generate all three forms of value, regardless its for-profit or non-for-profit orientation (Emerson, 2003a; 2003b). Blended value highlights the fact that economic and social value are indivisible, thereby calling for new metrics to perform better investment decisions which lead to multiple returns, including social and environmental returns rather than solely financial ones. Given that, a company creating shared value can only help investors in their pursuit of a “unified investment strategy” whereby “true value is not just a function of financial success” (Emerson, 2003b). CSV and Blended Value are complementary concepts, the one focusing upon corporate practice, while the other has a broader vision and implications for how we understand the nature and returns of capital. Hence, we propose Blended Value is inclusive of, although not limited to, CSV corporate practice.

*P<sub>6</sub>: CSV is integral to blended value, the latter being a broader concept focusing on the blended (i.e. financial, economic and social) returns and nature of capital.*

By carefully analysing CSV and blended value, it could be noticed how they both pave the way to overcome the misconception that organizations can meaningfully manage only one goal (Pirson, 2012) since it is not possible to pursue the maximization of more than one dimension at the same time (Jensen, 2001). Here is where blended value and shared value intersect, since they both allow for total value maximization, whereas total value consists of economic, social and environmental value. Therefore, we propose CSV is integral to blended value conception of total value maximization.

*P<sub>7</sub>: CSV is integral to total value maximization, whereas total value consists of economic, social, and environmental value (i.e. blended value).*

#### *Bottom of the Pyramid*

The fundamental proposition of Bottom of the Pyramid (henceforth, BoP) is that multinational companies (MNCs) can make huge profits and grow very fast by serving low income markets (Prahalad and Hammond, 2002). Prahalad and Hammond, (2002) believe that MNCs can enhance their prosperity by launching operations on untapped markets in poor regions, thereby improving the life of the local population. Therefore, BoP highlights that companies have the opportunity to alleviate poverty while creating economic value for themselves, which is the core essence of CSV. As a matter of fact, Michelini (2012) explored new business models to create shared value at the bottom of the pyramid. However, BoP concept limits its radius to the bottom of the economic pyramid while CSV considers a wider spectrum of markets.

*P<sub>8</sub>: CSV is an extension of BoP, the latter focusing on the bottom of the economic pyramid while the former targeting whole economic pyramid.*

*Corporate Social Responsibility*

There is no agreed definition about CSR primarily because it is not easy to clarify what the social responsibility of business consists of (Dahlsrud, 2008). For instance, some believe companies should be responsible to society as much as the people constituting them (Ludescher et al., 2012), while others argue that CSR is not always meaningful since lots of corporate social initiatives are just symbolic (Hess and Warren, 2008). CSR is an ill-defined concept primarily because in the literature it has been extensively discussed about the motivation underlying CSR practice. For instance, Baron (2001) intends an action as socially responsible, hence labelled as CSR, if it is taken with the *ratio* to serve society at the cost of profit. Further, Baron (2001) states that strategic CSR (henceforth, SCSR) is a profit-maximizing strategy which is privately, not socially, responsible. Therefore, following Baron's line of thought SCSR cannot be labelled as CSR. This clearly explains why most of CSR practice consists of firms engaging in socially oriented activities completely detached from their core business in order them to be perceived as authentic and true (Jamali, 2007; Di Bella and Al-Fayoumi, 2016). McWilliams and Siegel (2011: 1481) wisely connect an activity to SCSR if it *"allows a firm to achieve SCA [sustainable competitive advantage], regardless of motive"*. Taking motivation out of the discussion was quite a good step for CSR theoretical development, which is exactly what Porter and Kramer (2011) did with CSV. Porter and Kramer (2011) left aside any discussion concerning motives to create shared value, basically because irrelevant. Motives take second place because the bottom line of a CSV initiative consists in better social condition and enlarged profits, thereby both business and society are better-off. When there is room for Pareto improvements (i.e. actions that harms no one while improving the conditions of at least one in the economy) motives have no relevance.

*P<sub>9</sub>: The motives whereby firms engage in CSV initiatives, which by definition result in the creation of both economic value for them and societal value, will not be relevant if the conditions for Pareto improvements hold.*

Investigating the business case for CSR, Carroll and Shabana (2010: 102) argued that, since CSR not always positively relates with financial performance, *"firms should understand the circumstances of the different CSR activities and pursue those activities that demonstrate a convergence between the firm's economic objectives and the social objectives of society"*. This is at the core of CSV theoretical stance, which consists of the identification of business opportunities in societal challenges and their seizure to create shared value. Therefore, we propose CSV resolves the debate in the literature about CSR being positively or negative related to financial returns:

*P<sub>10</sub>: CSV opportunities are those opportunities wherein CSR is certainly positively related to financial returns.*

Therefore:

*P<sub>11</sub>: From the economic point of view, CSV is an economically efficient way for firms to put CSR into practice.*

As previously discussed, one of the most criticized aspect of CSV consists of how it intends to supersede CSR. Although it has been clearly stated in the literature that the rationale to engage in SCSR practice is profit maximization (Baron, 2001; Andrew Caulfield, 2013), Porter and Kramer (2011) reports that CSR is separate from the pursuit of profit maximization when highlighting the difference between CSV and CSR. Porter and Kramer (2011) have clearly had a partial understanding of CSR practices when they explained how CSV differs from CSR (Wilburn and Wilburn, 2014; Beschorner, 2014). However, considering the significant contribution of Porter and Kramer (2006) to SCSR development, this partial understanding might be voluntary. They were probably referring to CSR as intended in practice, given that many firms use to engage in CSR activities which are altruistic in nature and quite distant from strategic objectives (e.g. Jamali, 2007). The confusion around CSR concept should be considered when evaluating the attempt to detach CSV from CSR. Perhaps, a brand-new concept that breaks up with confusion was needed to direct business practice. For instance, Bruyaka et al. (2013) analysed 100 companies operating in the orphan drugs market and they found that although about a half of those companies were involved in CSR, less than a third included the development of orphan drugs in their CSR. These results give strong evidence of SCSR not being particularly clear to firms. We believe it is worthwhile taking a moment to look at this result through the lens of CSV: All of those companies operate in the orphan drugs market, thereby alleviating the burden of rare diseases on people (i.e. mitigating a quite big societal challenge). If those 100 biopharmaceutical companies were asked if they were solving a societal problem generating profits (i.e. CSV), only the firms who were experiencing losses could have answered they were not. Almost three decades earlier the CSV inception, Peter Drucker (1984: 55) argued that *“only if business ... learns that to do well it has to do good can we hope to tackle the major social challenges facing developed societies today”*. Such a powerful statement has not received the due attention because submerged in the confusing waters of CSR. Perhaps it was necessary to untie the concept from social responsibility. As anticipated by Drucker (1984: 62) *“the proper “social responsibility” of business is ... to turn a social problem into economic opportunity and economic benefit, into productive capacity, into human competence, into well-paid jobs, and into wealth”*, that is to create shared value. The reverberation of CSV could be primarily ascribed to the marketability of the concept rather than its literary foundations. The art of giving a name should not be disregarded when evaluating the diffusion of CSV, indeed. For some companies, *“social responsibility”* may evoke a sense of blame for the impact they exert on society which is their duty to deal with, accompanied by the misconception that this duty always comes at a cost. On the other hand, *“creating shared value”* is associated to profits to the company, prosperity to society, and happiness to everyone. Therefore, we

propose the reason why CSV has captured the attention of corporate leaders is in part to be ascribed to its disentanglement from the confusion gravitating around social responsibility.

*P<sub>12</sub>: The success of CSV could be partially ascribed to its “detachment” from social responsibility.*

We believe that CSV contribution is vital to the development of CSR practice, whereby we intend CSR as *“the responsibility of enterprises for their impacts on society”* (EC, 2011: 6). The simplest definition ever, yet comprehensive and clear. Boundaries are set by firm activities, the impacts of which represent what the firms must pay attention to. The European Commission has also given direction to business practice: *“To fully meet their corporate social responsibility, enterprises should have in place a process to integrate social, environmental, ethical, human rights and consumer concerns into their business operations and core strategy in close collaboration with their stakeholders, with the aim of: [1] maximising the creation of shared value for their owners/shareholders and for their other stakeholders and society at large; [2] identifying, preventing and mitigating their possible adverse impacts”* (EC, 2011:6).

The European Commission included CSV as a driver to meet the social responsibility of business, which we think is the real power of CSV. Since CSV scope is limited to societal issues through the mitigation of which companies create economic value (Dembek et al., 2015; Crane et al., 2014), the European Commission included the identification, prevention and mitigation of negative externalities (EC, 2011), as a separate point from shared value creation, thereby addressing also the cases wherein *“business value and social value do not go hand in hand”* (Beschorner, 2014: 109). Indeed, CSV cannot possibly substitute CSR since the responsibility of firms toward society cannot be limited to shared value creation opportunities. This is mainly due to the fact that, as explained earlier, CSV is not *per se* sustainable. Bruyaka et al. (2013: 51-52) indirectly explain the relation between CSR and CSV by saying *“where CSR is successfully used in a strategic manner the firm will create shared value for itself and for various of its stakeholders or society as a whole”*. To put it simple, even though the reconciliation between economic value and societal value has been extensively discussed within the corporate social responsibility framework (Snider et al., 2003), with CSV it becomes integral part of it. Hence, we propose CSV does not supersede CSR, but it is rather part of CSR and, therefore, it significantly contributes to CSR practice:

*P<sub>13</sub>: CSV does not supersede CSR, whereas the latter is inclusive of, but not limited to, the former.*

However, this last proposition should not be misconceived. It might be the case that CSV lies outside the scope of CSR. Think about a mobile network operator who exploited its core competencies in telecommunication and ICT to develop a e-health platform for remote monitoring of patients, which, once adopted by the medical centres of the region, permits to increase their capacity of hospitalization

without expanding their facilities, thereby meeting the needs of an increasingly large numbers of elder individuals with chronic diseases. In this case, even if the product that allows for shared value creation helps medical centres to meet their corporate social responsibility, it lies out the scope of the corporate social responsibility of the ICT firm who developed the CSV initiative. In other words, the shared value initiative portrayed in the aforementioned example does not finds its root within the CSR of the firm initiating it. In fact, quite the opposite may be true, as new social responsibilities may emerge from this CSV initiative (e.g. privacy concerns of personal sensible data transmissions). Hence, we propose that a CSV initiative which falls outside the scope of the CSR of the firm initiating it may give rise to new social responsibilities for that firm.

*P<sub>14</sub>: Extra-CSR initiatives which create shared value may give rise to new social responsibilities for the firm initiating them.*

This extra-CSR nature of CSV is to be ascribed to the fact that CSV is, *de facto*, part of value creation, whereby shared value is not limitedly intended as value shared by business and society (Porter and Kramer, 2011), but rather as value shared by the firm and a multitude of different stakeholders (e.g. Adner and Kapoor, 2010), a broader topic that falls outside the scope of the present work.

## CONCLUSIONS

In this paper, we analysed CSV from different perspectives offered by stakeholder theory, sustainability, social entrepreneurship, Blended Value, BoP and CSR. This analysis triggered several propositions which altogether may be useful to achieve a better understanding of CSV. These propositions intended to settle the debate around the validity of CSV and the theoretical stance thereof by conceiving CSV as a useful, yet not sufficient, approach for companies to meet their Corporate Social Responsibility, which need to be complemented by negative externalities-minimization criteria and mechanisms. However, we pointed out that CSV initiatives could lie outside the scope of a firm's CSR, giving rise to new corporate social responsibilities for it.

Even though a more complete profile of the CSV concept emerges from this paper, it remains an open question whether CSV can really help businesses in gaining legitimacy from society. With respect to CSR communication, we believe the operationalization of CSV may offer great opportunities to provide the large public with tangible proofs about the interiorization of CSR into the organization. We expect companies who create shared value better transmitting their "CSR Identity" (Crane and Glozer, 2016: 1242) to external stakeholders, who can perceive social responsibility as part of the corporate identity through direct observation of the social outcomes. Researching the legitimization effect of CSV would certainly contribute valuable insights for both CSR literature and practice. Another topic of interest related to social legitimization could be the ability of CSV to break with the controversial argument

about historic corporate social responsibility of companies (Schrempf-Stirling et al. 2015), i.e. companies held accountable on the basis of their past harm-doing. More specifically, the pursuit of a CSV strategy may reveal itself as an effective way for companies to “right their wrongs” by emphasizing their present well-doing to the eyes of society rather than their past harmful behaviour. Furthermore, we proposed that a firm can pursue a CSV strategy without having a social mission as core objective, whereby managers can attend their fiduciary obligation to shareholders while creating societal value, not necessarily provoking misfit across the various stakeholder interests, corporate values, and societal issues perceived as important by the firm. If so, we expect CSV to spread across those enterprises who have not been particularly oriented towards social issues as well. The alignment between self-serving purposes and public-serving ones patently taking place in CSV initiatives offers organizations the opportunity to “... conceive CSR as a meaningful part of their business strategy” (Jamali, 2007: 23). It may be interesting to explore whether CSV has the power to direct capitalism towards societal problem resolution, regardless if motives fall within opportunism, altruism, or points in between.

## REFERENCES

- Abu-Saifan, S. (2012), "Social entrepreneurship: definition and boundaries", *Technology Innovation Management Review*, Vol. 2, pp. 22-27.
- Adner, R. and Kapoor, R. (2010), "Value creation in innovation ecosystems: How the structure of technological interdependence affects firm performance in new technology generations", *Strategic management journal*, Vol. 31 No. 3, pp. 306-333.
- Andrew Caulfield, P. (2013), "The evolution of strategic corporate social responsibility", *EuroMed Journal of Business*, Vol. 8 No. 3, pp. 220-242.
- Austin, J., Stevenson, H. and Wei-Skillern, J. (2006), "Social and commercial entrepreneurship: same, different, or both?", *Entrepreneurship theory and practice*, Vol. 30 No. 1, pp. 1-22.
- Beschorner, T. (2014), "Creating shared value: The one-trick pony approach". *Business Ethics Journal Review*, Vol. 1 No.17, pp. 106-112.
- Bowe, C. and van der Horst, D. (2015), "Positive externalities, knowledge exchange and corporate farm extension services; a case study on creating shared value in a water scarce area", *Ecosystem Services*, Vol. 15, pp. 1-10.
- Bruyaka, O., Zeitzmann, H. K., Chalamon, I., Wokutch, R. E. and Thakur, P. (2013), "Strategic corporate social responsibility and orphan drug development: insights from the US and the EU biopharmaceutical industry", *Journal of business ethics*, Vol. 117 No. 1, pp. 45-65.
- Buller, P. F. and McEvoy, G. M. (2016), "A Model for Implementing a Sustainability Strategy through HRM Practices", *Business and Society Review*, Vol. 121 No. 4, pp. 465-495.
- Crane, A. and Glozer, S. (2016), "Researching corporate social responsibility communication: themes, opportunities and challenges", *Journal of Management Studies*, Vol. 57 No. 3, pp. 1223-1252.
- Crane, A., Palazzo, G., Spence, L. J. and Matten, D. (2014), "Contesting the value of "creating shared value"", *California management review*, Vol. 56 No. 2, pp. 130-153.
- Dahlsrud, A. (2008), "How corporate social responsibility is defined: an analysis of 37 definitions", *Corporate social responsibility and environmental management*, Vol. 15 No. 1, pp. 1-13.
- Dembek, K., Singh, P. and Bhakoo, V. (2015), "Literature Review of Shared Value: A Theoretical Concept or a Management Buzzword?", *Journal of Business Ethics*, Vol. 137, pp. 1-37.
- Di Bella, V., and Al-Fayoumi, N. (2016), "Perception of stakeholders on corporate social responsibility of Islamic Banks in Jordan", *EuroMed Journal of Business*, Vol. 11, pp. 30-56.
- Drucker, P.F. (1984), "Converting social problems into business opportunities: The new meaning of corporate social responsibility", *California management review*, Vol. 26 No. 2, pp. 53-63.



- Elkington, J. and Hartigan, P. (2008), *The Power of Unreasonable People: How Social Entrepreneurs Create Markets that Change the World*, Harvard Business Press, Boston, MA.
- Emerson, J. (2003a), "The blended value proposition: Integrating social and financial returns", *California management review*, Vol. 45 No. 4, pp. 35-51.
- Emerson, J. (2003b), "Where money meets mission", *Stanford Social Innovation Review*, Vol. 1 No. 2, pp. 38-47.
- EC, The. (2011), *Communication from the Commission to the European Parliament, the Council, the European Economic and Social Committee and the Committee of the Regions: A renewed EU strategy 2011-14 for CSR*. COM(2011) 681 final, EC, 25 October 2011, Brussels.
- Esposito, M., Kapoor, A. and Goyal, S. (2012), "Enabling healthcare services for the rural and semi-urban segments in India: when shared value meets the bottom of the pyramid", *Corporate Governance: The international journal of business in society*, Vol. 12 No. 4, pp. 514-533.
- Freeman, R. (1984), *Strategic Management: A Stakeholder's Approach*, Pitman, Boston, MA.
- Freeman, R. E., Harrison, J. S. and Wicks, A. C. (2007), *Managing for stakeholders: Survival, reputation, and success*, Yale University Press, New Haven, CT.
- Hart, S. L. (1997), "Beyond greening: strategies for a sustainable world", *Harvard business review*, Vol. 75 No. 1, pp. 66-76.
- Hess, D. and Warren, D. E. (2008), "The meaning and meaningfulness of corporate social initiatives", *Business and Society Review*, Vol. 113 No. 2, pp. 163-197.
- Jamali, D. (2007), "The case for strategic corporate social responsibility in developing countries", *Business and Society Review*, Vol. 112 No. 1, pp. 1-27.
- Jensen, M. C. (2001), "Value maximization, stakeholder theory, and the corporate objective function", *Journal of applied corporate finance*, Vol. 14 No. 3, pp. 8-21.
- Ludescher, J. C., Mahsud, R. and Prussia, G. E. (2012), "We are the corporation: Dispersive CSR", *Business and Society Review*, Vol. 117 No. 1, pp. 55-88.
- McWilliams, A., and Siegel, D. (2001), "Corporate social responsibility: A theory of the firm perspective", *Academy of management review*, Vol. 26 No. 1, pp. 117-127.
- Michelini, L. (2012), *Social innovation and new business models: Creating shared value in low-income markets*, Springer (E-book), Heidelberg, New York, Dordrecht, London.
- Maltz, E. and Schein, S. (2012), "Cultivating shared value initiatives: a three Cs approach", *The Journal of Corporate Citizenship*, Vol. 47, pp. 55-75.
- Moon, H.C., Pare, J., Yim, S.H. and Park, N. (2011), "An extension of Porter and Kramer's creating shared value (CSV): Reorienting strategies and seeking international cooperation", *Journal of International and Area Studies*, Vol. 18, pp. 49-64.
- Moran, P. and Ghoshal, S. (1996), "Value creation by firms", *Academy of Management Proceedings*, Vol. 1, pp. 41-45.
- Mort, G.S., Weerawardena, J. and Carnegie, K. (2003), "Social entrepreneurship: Towards conceptualization", *International journal of nonprofit and voluntary sector marketing*, Vol. 8 No. 1, pp. 76-88.
- Pirson, M. (2012), "Social entrepreneurs as the paragons of shared value creation? A critical perspective", *Social Enterprise Journal*, Vol. 8 No. 1, pp. 31-48.
- Porter, M. E. and Kramer, M. R. (2011), "Creating shared value", *Harvard business review*, Vol. 89, pp. 62-77.
- Prahalad, C. K. and Hammond, A. (2002), "Serving the world's poor, profitably", *Harvard business review*, Vol. 80 No. 9, pp. 48-59.
- Schrempf-Stirling, J., Palazzo, G. and Phillips, R. (2015), "Historic corporate social responsibility", *Academy of Management Review*, Vol. 41 No. 4, pp. 700-719.
- Schmitt, J. and Renken, U. (2012), "How to Earn Money by Doing Good!", *Journal of Corporate Citizenship*, Vol. 45, pp. 79-103.
- Schumpeter, R. (2011), "Oh, Mr Porter-The new big idea from business's greatest living guru seems a bit undercooked", *The Economist*, available at: <http://www.economist.com/node/18330445> (accessed 26 April 2017).
- Snider, J., Hill, R. P. and Martin, D. (2003), "Corporate social responsibility in the 21st century: A view from the world's most successful firms", *Journal of Business ethics*, Vol. 48 No. 2, pp. 175-187.
- Spitzeck, H. and Chapman, S. (2012), "Creating shared value as a differentiation strategy-the example of BASF in Brazil", *Corporate Governance: The international journal of business in society*, Vol. 12 No. 4, pp. 499-513.
- Tantalo, C. and Priem, R. L. (2014), "Value creation through stakeholder synergy", *Strategic Management Journal*, Vol. 37, pp. 314-329.
- Vaidyanathan, L. and Scott, M. (2012), "Creating shared value in India: The future for inclusive growth", *Corporate Social Responsibility: Practice, Theory, and Challenges*, Vol. 37 No. 2, pp. 108-113.

- Waddock, S. A. and Graves, S. B. (1997), "The corporate social performance-financial performance link", *Strategic Management Journal*, Vol. 18, pp. 303-319.
- Wilburn, K. and Wilburn, R. (2014), "Demonstrating a commitment to corporate social responsibility not simply shared value", *Business and Professional Ethics Journal*, Vol. 33 No. 1, pp. 1-15.

## ANALYSING THE TRUMP AND BREXIT VOTERS

Dos-Santos, Maria José Palma Lampreia dos Santos<sup>1</sup>; Candeias, Teresa<sup>2</sup>; Diz, Henrique<sup>3</sup>

<sup>1</sup>Department of Economics, ISCTE-IUL-DINÂMIA'CET, Institute University of Lisbon, ESCS-IPL, Lisbon, Portugal

<sup>2</sup>Department of Management, Universidade Lusófona do Porto, ULP, Porto, Portugal

<sup>3</sup>Department of Economics and Management, Universidade de Aveiro, UA, Aveiro, Portugal

### ABSTRACT

This paper refers to two recent political phenomena: the Brexit, separation of the United Kingdom from the European Union, and the election of Donald Trump as President of the United States. It is important to note that the results on both occasions did not meet the expectations based on opinion polls, on one hand, and, on the other, seemed to be influenced by the adoption of populist attitudes by some of the people and parties involved. It is therefore necessary to deepen the knowledge about the two situations, their fundamentals and their outcomes. That is the objective of this paper. To gather published information and try to use it for the understanding of the results based on existing theories and thoughts.

*Keywords: Brexit; Trump; elections; socio-economic; populism*

### INTRODUCTION

The political geography seems to be changing (Buhaug, *et al.*, 2016) with the Brexit, that will lead to the separation between the United Kingdom and the European Union, as well as with Donald Trump's victory in the American presidential elections at the end of 2016. Disruptive phenomena are normally associated with economic stagnation or depression in the past. These create conditions for strong expansionist programs, where redistribution is the key word, as stated in the initial work of Dornbush and Edwards (1990). But that was not the case in the two situations mentioned, even though both the UK and the United States have suffered the effects of both the sub-prime crisis initiated in the USA in 2007 and had been hit by the progressive globalization and commercial openness, with social consequences that are being evaluated. Traditionally, international commerce has been described by economic theories as a source of progress and increase in efficiency among countries (Gilpin, 2016; Broadberry, *et al.*, 2016; Clarke *et al.*, 2017). However, the experiences of Brexit and, even more strongly, the election of Donald Trump in the United States, should drive our attention to the sensation of many citizens that feel being excluded by the system that may not have protected them as they were expecting. As a matter of fact, negativity towards the institutions of formal politics is currently a concern across much of the democratic world (Clarke and Ricketts, 2017).

Europe and the United States have benefited from half a century of prosperity and growth practically since the end of the Second World War until the sub-prime crisis. The increased liberalization of the world trade and the globalization of the economy resulted in strong gains for the economies of these two countries, only momentarily interrupted by the oil crisis that occurred in between. And both the USA and the UK recovered quickly from the sub-prime crisis, as the improvement in economic indicators shows. Thus, the general economic situation of both countries when the referendum on Brexit and the election of Donald Trump occurred were good. Those weren't, in fact, periods of economic recession or accelerated unemployment. Other factors emerged, namely populism, with long time prospects that should be studied. In fact, the current surge of populism in Europe and the US is a significant challenge not only for mainstream political parties but, more importantly, for the prosperity and political stability of advanced economies across the world (Andersen *et al.*, 2017). Since 2016 and 2017, there is a proficient literature about the Brexit phenomenon and the Donald Trump election on USA from various field of science, but none of these deals with the social-economic fundamentals and the citizen's attitudes that are in the basis of Brexit and Trump's election.

The problem of this paper is how to prevent "new" populist movements and what causes / theories are at their origin. Do the current theories explain these phenomena or not?

The objective of this study is then to contribute to the identification of the causes that originated these social attitudes in such different social and political contexts as were lived in the UK and the USA at the time and find the theories that may explain the observed changes.

## **FROM THE LATIN AMERICAN POPULISM TO THE PROTEST VOTE IN THE UK AND THE TRUMP'S ELECTION**

The pioneering work from Dornbusch and Edwards, (1990) about macroeconomic populism analysed the two populist economic programs, in Chile, during Allende's Unidad Popular (1970-1973) government, and Peru, under Alan Garcia's rule. According to these authors, the initial condition for the implementation of both programs was the dissatisfaction of citizens with the country's growth performance. Most typically, though not always, the countries had experienced moderate growth, stagnation or outright depression as a result of previous stabilization attempts. Once the debate was initiated, a number of studies were developed, mainly in Latin America, with the aim of determining the main causes and the consequences of populist policies. Damill, *et al.* (2015) analysed macroeconomic policy in Argentina in the period starting in 2002. The results, based on panel time-series data and analysis, confirm the prediction that recently elected governments coming into power after periods of political dictatorship, and which are faced with demand for redistribution, end up

engaging in populist (or redistributive) policies, which tend to lead to high inflation and overall poor macroeconomic performance. Fonseca (2011) confirmed these results for Brazil in the time of Vargas' economic populism. According to this author, the Second Vargas Administration in Brazil (1951-1954) is commonly associated with the phenomenon of populism. The author concludes that "besides, based on this historic experience, it is advocated that there is no incompatibility between developmentalism and the adoption of macroeconomic stability-oriented measures". With the recent economic crisis, conditional lending and mandatory structural reforms arrived in the European Union. On the opposite way in European countries "with the recent economic crisis, conditional lending and mandatory structural reforms arrived in the European Union. Greece and a number of other crisis countries were subjected to a rigorous process of economic adjustment in exchange for emergency credits from the troika (European Commission, European Central Bank, and International Monetary Fund)" (Hermann, 2016). With the recent economic crisis, conditional lending and mandatory structural reforms arrived in the European Union. (Hermann, 2016).

Populism is conceived of as a political style essentially displaying proximity of the people, while at the same time taking an anti-establishment stance and stressing the (ideal) homogeneity of the people by excluding specific population segments. Second, it is pointed out that defining populism as a style enables one to turn it into a useful concept that has too often remained vague and blurred. (Jagers, and Walgrave, 2007; Abts and Rummens, 2007). Although these phenomena were initially associated with economic recession or depression, instability, and inflation in Latin America, their political geography changed to North America and Europe, the most recent examples being Brexit, Trump's elections, but also the growth of populist parties in The Netherlands, France, Austria, Italy, Germany, Hungary and so on, despite the fact that macroeconomic and social conditions are substantially different from the ones that were in the basis of the populist movements in South America. Scholars of contemporary Europe's Mediterranean strategy note that efforts by Europe to link with its southern neighbors do more than simply establish norms for external relations. They are also used to define what (and where) Europe is (Steinberg, 2016). However, in recent times, the warlike conflicts in the Mediterranean countries and the growing wave of migrants have somehow conditioned the policies in Europe and had effects in Trump voters. According to Steinberg (2016), Notwithstanding this dream of free and peaceful commerce across a tamed inland sea, whenever there is interaction there is also the potential for hostility. As such, just as the designation of the Arctic as a Polar Mediterranean is used to promote a vision of Europe (and North America) peacefully extending its frontiers, it is also used to suggest a vision of the inland sea as an arena of conflict. In the last three years, the number of deaths from war has once again risen, mainly due to the bloody civil war in Syria (Gleditsch, Nordås, 2014). This war has had profound impacts at the European and American political level, which is difficult to predict at

the level of the voters' sense of voting. States had engaged in a variety of border enforcement practices to reassert control over migration and territory in spite of international human rights obligations. State responses to asylum seeking are illustrative of the subsequent movement and proliferation of borders far from the territorial borderline (Gorman, 2017).

## METHODOLOGY AND DATA

The methodology includes a qualitative and quantitative analysis. At the quantitative level analysis, a study was carried out of all scientific papers published in the *SCOPUS* indexed database and the *Social Science Citation Index* and *Web of Science*, which included 116 papers in the different scientific areas published between 2016 and 2017. After were selected all those scientific papers included in the Social Sciences / Economic / Econometric / Miscellaneous / and Management scopes. All these works are duly analysed and referenced in this work. At the level of the quantitative analysis, two types of analysis were performed: a univariate analysis and an econometric analysis with the ARIMA model (in progress). Univariate analysis includes two distinct procedures. First, the macroeconomic indicators were analysed on the basis of OECD databases; The World Bank and the European Commission, referring to the years 2009 and 2016. Secondly, the data concerning the Ipsos Public Affairs Inquiry for the database on the economic situation in UK and USA were analyzed. The ARIMA Econometric model was based on data referring to the years 2009 to 2016 regarding the socio-economic and political conditions that foster these populist movements. The variables include a formed panel data based on quantitative indicators for 32 European countries and the United States as a comparative term. The variables include economic indicators relating to educational levels (EDU) of citizens; Indicators for economic growth (GDP) (GDP growth rate); Employment scientific (SE). At the level of investment of GDP in R&D, as well as social data such as average annual average income and by category (YA). In addition, we created a dummy variable that evoked the existence of extreme phenomena in 2016 (EX), as well as a trend variable @TREND. The econometric model was based on Choi and Varian (2009) made use of simple autoregressive models augmented by the index taking the following form: AR-1 model  $y_t = b_1 y_{t-1} + b_9 y_{t-9} + e_u$  for the period 2009 a 2016.

$$\ln y_t = \alpha_0 + \alpha_1 \ln y_{t-1} + \alpha_{12} \ln y_{t-12} + \beta x_t + u_t \quad (1)$$

Where  $y_t$  is the value of the series under investigation year  $t$ ;  $y_{t-1}$  is the value of that series in the previous year  $y_{t-9}$  is the value of the serie of 9 years earlier and  $x_t$  is the value of the series of 9 years earlier and  $x_t$  value of the dummy trends query for the terms associated with the series.

Because simple fixed annual dummies may offer an alternative approach to the modelling of the populism movements in the studied countries, for each data term we began with a general unrestricted

model (2) according Choi and Varian (2009) that included a secular time trend (TREND) and fixed annuals dummies ( $S_j$ ) as well as the 1-period and 9-period lags of the dependent variable (POPU) and the value of the relevant value of populism searched.

$$\ln y_t = \alpha_0 + \alpha_1 \ln y_{t-1} + \alpha_{12} \ln y_{t-12} + \beta x_t + \gamma \text{TREND} + \sum_{j=0}^{10} \partial_j S_j + u_t \quad (2)$$

## RESULTS AND DISCUSSION

### *Socio-Economic conditions in the UK and the USA*

Table 1 presents the main economic indicators in USA and UK in 2009 and 2016, during and after the subprime crisis. Recession in the USA reached -8% of GDP, -2.3% in the United Kingdom. Results started to improve in 2010, though, and it could be said that there is now a moderate economic growth. Unemployment among young people was strongly affected, reaching 16 and 20%, respectively, in the United States and the UK, in 2009. And it decreased to 11 and 13% after 2010. Despite the improvement, the rate of young people that cannot find a job is still 6 to 8 points higher than general unemployment in those countries. On the other hand, trade balance was always negative, increasing 50% in the USA from 2009 to 2016. The UK performed better, with a decrease of around 10% along the same period.

Economic data	USA		UK	
	2009	2016	2009	2016
GDP grow rate (%)	-8	2	-2,3	1,5
Balance of trade (millions of \$ (USA) or (GBP in UK)	-30000	-45000	-5800	-5200
Unemployment rate (%)	5,3	5,0	6,1	5,1
Inflation Rate (%)	-2	3	2	0,2
Debt to GDP (%)	95,2	104,7	65,7	89,2
Youth Unemployment Rate (%)	16	11	20	13
Productivity (Index Points)	98	106	98,5	108,5
Private Debt to GDP (%)	212,28	197,2	237,8	229,5

Table 4. *Economic outlook of USA and UK Source: OECD, 2016.*

### *Socio-Economics Characteristics of the Brexit voters*

As for the socio-economic characteristics of the voters favouring Brexit, it is possible, according to Brooks *et al.*, 2016 and O'Reilly *et al.*, (2016), to distinguish them by socio-professional characteristics, such as the profession associated with educational level, level of wealth (heritage) and religious factors. Nearly two thirds of manual workers (64%) voted "Leave", and their voice was augmented by approximately half of the middle classes with the same behaviour. The majority of the professionals and managerial classes (57%) voted "Remain". An observation of the housing characteristics of "Leave" voters illustrates this unusual 'contradictory coalition'. Most of those who owned their own home,

without a mortgage (most likely older voters and the very rich), and two thirds of council and housing association tenants voted "Leave". Homeowners with a mortgage voted "Remain".

Gender divisions did not prove evident, but ethnic divisions were; and they were also fractured. White voters were slightly more likely to vote "Leave" (53%) than to vote "Remain" (47%). Two thirds (67%) of those describing themselves as Asian voted to remain, as did three quarters (73%) of black voters. Nearly 6 in 10 (58%) of those describing themselves as Christians voted to leave, while 7 in 10 Muslims voted "Remain". However, some migrants from the Commonwealth voted "Leave" only because they wanted a fairer system of migration that did not give preferential treatment to East Europeans over people from their own countries (Parveen, 2016; O'Reilly et al., 2016). The economic crisis, the refugee crisis, pressures on the Euro and immigration, combine to stress the shortcomings of the EU. Brexit is also one kind of expression of democracy. Inglehart and Norris (2016) analyses whether populist support is associated with economic or cultural variables. Their results confirm that cultural values are consistent predictors of support for populist parties strengthened by anti-immigrant attitudes, mistrust of global and national governance, support for authoritarian values, and left-right ideological self-placement. According to Andersen et al. (2016), economic indicators are not reliable predictors. It thus seems likely that economic policies have not directly led to a populist backlash, but have indirectly reinforced it, by creating a world of greater labour mobility, and growing prominence of supranational government. The current surge of populism in Europe and the US is a significant challenge, not only for mainstream political parties but, more importantly, for the prosperity and political stability of advanced economies across the world.

The main factor that explains the Brexit was the lower educational level of the population and lack of investment in education (Streeck, 2014). In fact, UK, together with Greece, has the lowest share of secondary education students learning two or more languages, below 10% and decreasing since 2009. (EUROSTAT, 2016; Streeck, 2014). Meanwhile, good reasons existed for some section of the population to vote for Brexit. If the EU and the elites do not protect citizens from the crisis and economic difficulties, why bother? The Brexit vote most importantly underlines income and territorial inequalities, a growing cleavage between globalization winners and losers and a profound Brexistential crisis about the future of the Union European (Le Galès, 2016).

#### *Socio-economics characteristics and attitudes of the Trump voters*

As for the socio-economic characteristics and attitudes of the voters of Trump election (Table 2 and Table 3), it is possible to distinguish them by socio-professional characteristics, such as gender, race, age, education, geographical location of the voters, religion, the profession associated with educational level, and attitudes about the situation and the future of the country, immigration and openness to international trade and mistrust towards mainstream politicians: voters have serious mistrust about the



qualities of the politician in which they vote and political ideology is mainly conservative in Trump voters. Trump voters are mainly politically conservative, male (52%), 45-64 years old (53%) and 65 and over years (53%), less educated (51% of people having high school or lower degrees, and 52% of those some college/associate degree), 50% of voters with average income in the \$50,000 - \$99,999 bracket. The low-income voters, receiving under \$30,000 or between 30,000 - \$49,999\$ voted mainly for Clinton. One other characteristics of Trump was place of residence - the majority lives in suburbs (50%) and small city or rural areas (62%) - religion - Protestant or other Christian (58%) or Catholic (52%), while Clinton attracted 62% of voters with no religion and 69% of those with other religious belief. As far as attitudes and values, 69% of the Trump voters consider that the direction of the country is seriously off track, they are mainly concerned with the emigration (64%) and worried about the economic situation of the country (42%). When asked about the family financial situation, they consider that it is worse today (78%) and expect for the next generation of Americans to have a worse life than today (63%). About 65% consider that the effect of trade openness with other countries on U.S. jobs takes jobs away from American workers, 86% agree with the construction of the wall along the entire U.S. border with Mexico and 84% strongly agree with the deportation of illegal immigrants working in the U.S.A. For 84% of Trump voters the most important candidate quality is that he can bring needed change. These results seem to indicate that Trump voters correspond, on one hand, to those excluded from globalization and the system, and, on the other, probably to the revolt of the elites towards the political system. They are thus willing to take more risk and vote for a candidate with no political experience and outside the political mainstream.

#### Voter's Socio-economic characteristics

Gender	Male	Female	Gay, lesbian, bisexual or transgender			
Trump (%)	53	42	14			
Clinton (%)	41	54	78			
Race	White	Black	Hispanic/Latin	Asian		
Trump (%)	58	8	29	37		
Clinton (%)	37	88	65	56		
Age	18-29	30-34	45-64	65 and over		
Trump (%)	37	42	53	53		
Clinton (%)	55	50	44	45		
Education	W	Some college/ associate degree	College graduate	Postgraduate study		
Trump (%)	51	52	45	37		
Clinton (%)	45	43	49	58		
Income (\$/year)	Under \$30,000	\$30,000 - \$49,999	\$50,000 - \$99,999	\$100,000 - \$199,999	\$200,000 - \$249,999	\$250,000 or more
Trump (%)	41	42	50	48	49	48

Clinton (%)	53	51	46	47	48	46
Residence	City over 50,000		Suburbs		Small city or rural	
Trump (%)	35		50		62	
Clinton (%)	59		45		34	
Religion	Protestant Christian	or other	Catholic	Jewish	Something else	None
Trump (%)	58		52	24	29	26
Clinton (%)	39		45	71	62	69

Table 5. *Socio-economic characteristics of the Trump and Hilary Clinton Voters. Source: from Fuchs, C. (2017) and Huang, J., Jacoby, S., Lai, R., and Strickland, M., (2016).*

Voter's attitudes		Trump (%)	Clinton (%)
Direction of country	Generally right direction	8	90
	Seriously off track	69	25
Most important issue	Foreign policy	34	60
	Immigration	64	32
	The economy	42	42
	Terrorism	57	39
Condition of the nation's economy	Excellent	16	83
	Good	19	76
	Fair	55	39
	Poor	79	15
Family financial situation	Better today	24	72
	Worse today	78	19
	About the same	46	46
What do you expect for the next generation of Americans?	Better than life today	38	59
	Worse than life today	63	31
Condition of the nation's economy	Excellent	16	83
	Good	19	76
	Fair	55	39
	Poor	79	15
Effect of trade openness with other countries on U.S. jobs	Takes away jobs	65	31
What should happen to most illegal immigrants working in the U.S.?	Deport	84	14
Building a wall along the entire U.S. border with Mexico	Support	86	10
Best description of vote	I like my candidate but with reservations	49	48
Most important candidate quality	Can bring needed change	83	14
Political ideology	Conservative	81	15
	Liberal	84	10

Table 6. *Attitudes of the Trump and Hilary Clinton Voters. Source: from Fuchs, C. (2017) and Huang, J., Jacoby, S., Lai, R., and Strickland, M., (2016).*

*Results about the attitudes and perceptions of the citizens from UK and USA about the economic situation of the country*

Data are taken from Ipsos Public Affairs (2017). Citizens in the UK, USA and other 23 countries assessed the current state of their country's economy. The first question was: "Now, thinking about our economic situation, how would you describe the current economic situation in? Is it...". The answers should be given in a modified Likert scale, with four possible results: Very good; Somewhat good; Somewhat bad and Very bad. The number of answers was a thousand in each of the countries involved. In Figure 1 one can see the results for the UK. Globally, the results show that 49% of the respondents consider the economic situation somewhat bad. The social-economic characterization of these respondents shows that there is a difference according to gender. More than 52% of women and only about 46% of man gave that answer. Other characteristics include 54% of people in the 50-64 years age bracket, 44% of those under 35 years old and 50% of respondents aged between 35-49. Also, 51% of the persons who answered somewhat bad were unemployed; 52% of the people with high salaries and 44% of those with medium and low incomes gave this answer; 52% were married, from whom 52% did not have a chief income earner; 52% did not occupy a senior executive place. It should be noted that only 37% of people in high hierarchical position were in this group of respondents. For 39% of the people inquired, the economic situation in the UK is somewhat good. 41% of these respondents were male, 37% female. This answer is equal for the highest age groups, with 37%, but only 34% of people under 35 years old voted this way, probably as a result of high unemployment in this age group; 39% belonged to a low income household, 44% to a high income. Votes were independent of marital status. Citizens sharing this opinion had mainly, 44%, low education levels. Only 34% of medium and 39% of highly educated people agreed with this answer; finally, 41% of chief income earners shared the same opinion, against 37% of not chief income earners and business owners. The economic situation is very bad only for a total of 8% of the respondents. There is no evidence for a gender discrepancy. But, on the other hand, it seems that it is within the bracket age under 35 and lower education levels that this answer is mostly chosen. The contrasting choice, the economy is very good, is chosen by only 4% of the persons, mainly among men with lower education but high income households, including business owners and chief income earners.

In conclusion: the majority of the sample, 57%, in the United Kingdom considers that the economic situation of the country is bad or very bad. It is mainly among women, with medium educational level or unstable employment and lower hierarchical positions, low income, part-time jobs and risk of unemployment, within the age bracket 35-49, that this opinion prevails. These results confirm the findings of O'Reilly et al. (2016) that two thirds of the voters in favour of the Brexit were manual

workers and that their voice was reinforced by approximately half of the middle class (Stewart et al., 2016).

The same question was asked in the United States to a sample of 1000 inhabitants according to Ipsos Public Affairs (2017) methodology. The results, shown in Figure 3, confirm significant differences in the perception of American citizens when compared to their British counterparts. As a matter of fact, 52% of the people submitted to the questionnaire considers that the economic situation in the USA is good or very good. It mainly is among males (59%), aged under 35 (63%) – in contrast to the 48% of those between 35 and 49, or 43% older than 49 – married (52%), living within high income households, and with a Chief Income Earner (77%), Business Owners or Senior Executives (78%), with higher education (67%) that this opinion prevails. As far as geography is concerned, these results are favorable especially in the US Midwest Region (54%), US South Region (53%) and US West Region (53%), being smaller in the US Northeast Region (48%).

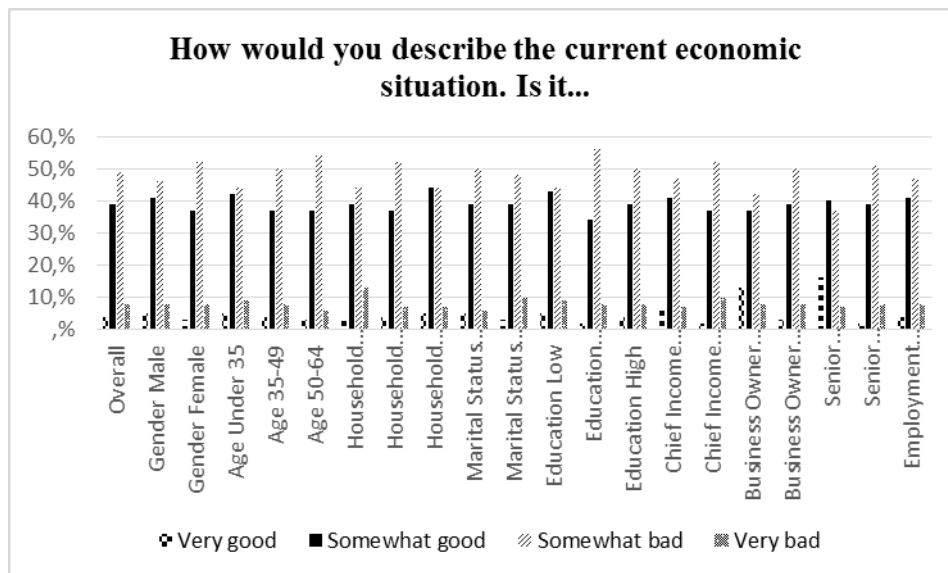

Figure 1. Economic situation in UK, 2017 (Source: Ipsos Public Affairs (2017)).

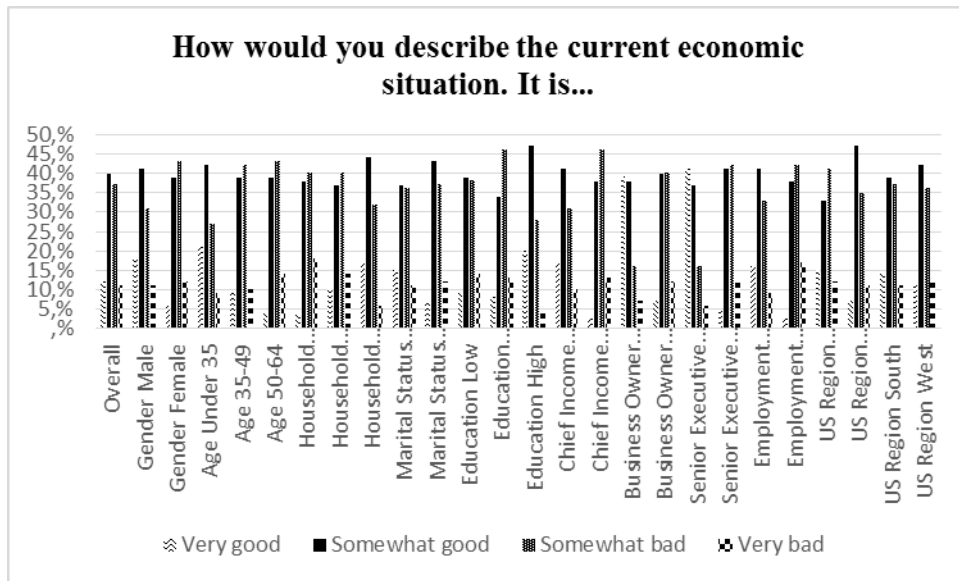

Figure 2. Economic situation in USA, 2017 (Source: Ipsos Public Affairs (2017)).

Possible explanations of the results

Several authors tried to forward explanations for the results of the elections: Clarke, and Ricketts, (2016) through the return of the Jacksonian tradition; (Newmann, 1957; Neumann et al., 2013).) using the critical theory. Clarke and Ricketts (2016) concluded that in many respects, the 2016 presidential race witnessed the return of Jacksonian sentiment to center stage in American politics to challenge the post-Cold War consensus on foreign policy. Although these results refer to the UK, their conjugation with the factors based on the Jacksonian theory, may partly explain Trump’s election, which cannot be based on the economic factors, since, as previously stated, most the respondents to the Ipsos Public Affairs inquiry (2017) considers them to be good or very good. It may be added that they also express that the economy is not their main source of worries, since the negative effects of the subprime crisis seem to be surpassed. On the contrary, in the UK, the inquiry shows that the majority (57%) of the respondents consider the economic situation in the country bad or very bad. On the other hand, economic indicators show that the subprime crisis negatively affected the economy. Young people were among the most affected, despite their academic qualifications and thus the Prospect Theory was not confirmed. However, older less educated persons opted to vote for Brexit, as their American counterparts voted for Trump. It may be concluded that the Jacksonian Theory may be applied in both situations, with people expressing negative feelings towards formal political institutions, be them national, in the case of the USA and UK, or supranational, in the case of the UK. At economic level the Prospect Theory proposed by

Kahneman, and Tversky, (1979) could explain these electoral or referendum phenomena. Choices among risky prospects exhibit several pervasive effects that are inconsistent with the basic tenets of utility theory. In particular, people underweight outcomes are merely probable in comparison with

outcomes that are obtained with certainty. This tendency, called the certainty effect, contributes to risk aversion in choices involving sure gains and to risk seeking in choices involving sure losses. The application of the Prospect Theory to the results of the Presidential Elections in the United States and the Brexit referendum in the United Kingdom would justify that voters who faced negative experiences in the past are more receptive to vote in a riskier proposal (whose consequences they do not entirely know), but that offers them higher potential of additional gains, instead of choosing a safer alternative with smaller potential advantages. Fuchs, (2017) based on Neumann, (1957) and Neumann et al., (2013) explain the Trump election on the basis of the Critical Theory, namely, in such situations, the “fear of social degradation [...] creates for itself ‘a target for the discharge of the resentments arising from damaged self-esteem’”. persecutory anxiety can lead to ego-surrender in the mass through affective identification with a leader.

#### *Consequences of the Brexit and Trump's Election*

The analysis of the Brexit referendum reveals that the regions that voted strongly for Leave tended also to be those with the greatest levels of dependency on European Union markets for their local economic development (Galbraith, 2017). Donald Trump's victory showed how market reaction to populism is hard to predict. Globally, populist policies are focused more on immigration, trade, and governance, which are typically market negative. As such, populist electoral victories would imply modest downward revisions to baseline growth forecasts and risk greater instability. It has not been the case so far. Populist electoral victories in Europe would result in unsettling brinkmanship and provide an existential threat to the EU, though compromise is the most likely outcome since subsequent risks are two-sided.

## **CONCLUSION**

The election of Donald Trump as President of the United States and the Brexit, separation of the United Kingdom from the European Union must be seen as the result of a complex situation involving social, political and economic aspects. Firstly, it is evident that there is a growing mistrust of a large part of the citizens on traditional institutions, political parties and long term politicians, be them national, in the case of the United States, or national and supranational, in the case of the United Kingdom. Secondly, citizens tend to feel that, in some way, they have been abandoned by the state to the effects of globalization and immigration without any effort being made to protect them. This in turn justifies the support for policies based on isolation and the growing believe that, on their own, with restrictive trade and immigration policies, both the United States and the United Kingdom would perform better. Finally, it is also evident from the study that the groups that favored Trump's election and the Brexit

are those who think have more to lose with the current policies and are, therefore, open to try other ways, even if they may doubt the outcome.

## REFERENCES

- Abts, K., and Rummens, S. (2007), "Populism versus democracy", *Political Studies*, 55(2), 405-424.
- Abdelkader, E. (2016), "When Islamophobia turns violent: The 2016 U.S. Presidential Elections, The bridge initiative: A Georgetown University research project", available at: <http://bridge.georgetown.edu/when-islamophobia-turnsviolent-the-2016-u-s-presidential-elections/>
- Andersen, T. M., Bertola, G., Driffill, J., Fuest, C., James, H., Sturm, J. E., and Urošević, B. (2017), "Economic Policy and the Rise of Populism—It's Not So Simple", *EEAG Report on the European Economy*, 50-66.
- Broadberry, S., Ghosal, S., and Proto, E. (2016), "Anonymity, efficiency wages and technological progress", *Journal of Development Economics*, In Press.
- Buhaug, H., McConnell, F., Sharp, J., Sidaway, J. D., and Steinberg, P. E. (2016), "Changes at Political Geography", *Political Geography*, 50, A1-A2.
- Brooks, C., Manza, J., and Cohen, E. D. (2016), "Political Ideology and Immigrant Acceptance", *Socius*, 2, 1-12.
- Buhaug, H., McConnell, F., Sharp, J., Sidaway, J. D., and Steinberg, P. E. (2016), "Changes at Political Geography", *Political Geography*, 50, A1-A2.
- Clarke, N., Jennings, W., Moss, J., and Stoker, G. (2017), "Changing spaces of political encounter and the rise of anti-politics: Evidence from Mass Observation's General Election diaries", *Political Geography*, 56, 13-23.
- Clarke, M., and Rickett, A. (2017), "Understanding the Return of the Jacksonian Tradition", *Orbis*, 61(1), 13-26.
- Choi, H., & Varian, H. (2012), "Predicting the present with Google Trends". *Economic Record*, 88(s1), 2-9.
- Dornbusch, R., and Edwards, S. (1990), "Macroeconomic populism", *Journal of Development Economics*, 32(2), 247-277.
- Damill, M., Frenkel, R., and Rapetti, M. (2015), "Macroeconomic Policy in Argentina During 2002-2013", *Comparative Economic Studies*, 57(3), 369-400.
- Duchesne, S., Frazer, E., Haegel, F., Van Ingelgom, V., and Van Ingelgom, V. (Eds.) (2013), *Citizens' reactions to European integration compared: Overlooking Europe*. Springer.
- EUROSTAT (2016), *Foreign language learning statistics - Statistics Explained - European*, available at: [http://ec.europa.eu/eurostat/statistics-explained/index.php/Foreign\\_language\\_learning\\_statistics](http://ec.europa.eu/eurostat/statistics-explained/index.php/Foreign_language_learning_statistics)
- Fonseca, P. C. D. (2011), "O mito do populismo econômico de Vargas", *Revista de Economia Política*, 31(1), 56-76.
- Fuchs, C. (2017), "Donald Trump: A Critical Theory-Perspective on Authoritarian Capitalism", *tripleC: Communication, Capitalism & Critique*, 15(1), 1-72.
- Galbraith, J. (2017), "Europe and the World after Brexit", *Globalizations*, 14(1), 164-167.
- Gilpin, R. (2016), *The political economy of international relations*, Princeton University Press.
- Gleditsch, N. P., and Nordås, R. (2014), "Conflicting messages? The IPCC on conflict and human security", *Political Geography*, 43, 82-90.
- Gorman, C. S. (2017), "Redefining refugees: Interpretive control and the bordering work of legal categorization in US asylum law", *Political Geography*, 58, 36-45.
- Hermann, C. (2016), "Another 'Lost Decade'? Crisis and Structural Adjustment in Europe and Latin America", *Globalizations*, 1-16.
- Home Office Statistical Bulletin (2016), *Hate Crime, England and Wales, 2015 to 2016*, 30.
- Huang, J., Jacoby, S., Lai, R., and Strickland, M., (2016), "Election 2016: Exit polls", *New York Times*, 8th November, available at: <http://www.nytimes.com/interactive/2016/11/08/us/politics/election-exit-polls.html>.
- Inglehart, R. F., and Norris, P. (2016), *Trump, Brexit, and the Rise of Populism: Economic Have-Nots and Cultural Backlash*, Harvard University, John F. Kennedy School of Government.
- Ipsos Public Affairs Inquiry (2017), *Database not published*, available at: [https://www.ipsos.com/en/solution/social-research-corporate-reputation-ipsos-public-affairs?language\\_content\\_entity=en](https://www.ipsos.com/en/solution/social-research-corporate-reputation-ipsos-public-affairs?language_content_entity=en)
- Jagers, J., and Walgrave, S. (2007), "Populism as political communication style: An empirical study of political parties' discourse in Belgium", *European Journal of Political Research*, 46(3), 319-345.
- Le Galès, P. (2016), "Brexit: UK as an exception or the banal avant garde of the disintegration of the EU?", in: O'Reilly, J., Froud, J., Johal, S., Williams, K., Warhurst, C., Morgan, G., ... and Frerichs, S. (2016), "Brexit: understanding the socio-economic origins and consequences", *Socio-Economic Review*, 14(4), 807-854.

- Kahneman, D., and Tversky, A. (1979), "Prospect theory: An analysis of decision under risk", *Econometrica: Journal of the econometric society*, 263-291.
- Neumann, F. L. (1957), *The democratic and the authoritarian state: essays in political and legal theory*, H. Marcuse (Ed.), Glencoe, IL: Free Press.
- Neumann, F., Marcuse, H., and Kirchheimer, O. (2013), *Secret reports on Nazi Germany: The Frankfurt School contribution to the war effort*, Princeton University Press.
- O'Reilly, J., Lain, D., Sheehan, M., Smale, B., and Stuart, M. (2011), "Managing uncertainty: the crisis, its consequences and the global workforce", *Work, employment and society*, 25(4), 581-595.
- O'Reilly, J., Froud, J., Johal, S., Williams, K., Warhurst, C., Morgan, G., and Frerichs, S. (2016), "Brexit: understanding the socio-economic origins and consequences", *Socio-Economic Review*, 14(4), 807-854.
- OECD, (2016) "Trade Economics" available at: <http://www.tradingeconomics.com/united-kingdom/private-debt-to-gdp>
- Parveen, N. (2016), "Why Do Some Ethnic Minority Voters Want to Leave the EU?" *The Guardian*, available at: <http://www.theguardian.com/politics/2016/jun/01/british-asians-viewseu-referendum-figures-brexit> on August 7, 2016.
- Streeck, W. (2014), "The politics of public debt: Neoliberalism, capitalist development and the restructuring of the state", *German Economic Review*, 15(1), 143-165.
- Steinberg, P. E. (2016), "Europe's 'Others' in the Polar Mediterranean", *Tijdschrift voor economische en sociale geografie*, 107(2), 177-188.
- Stewart, K., Dubow, T., Hofman, J., and van Stolk, C. (2016), "Social change and public engagement with policy and evidence", available at [http://www.nuffieldfoundation.org/sites/default/files/files/RAND\\_RR1750.pdf](http://www.nuffieldfoundation.org/sites/default/files/files/RAND_RR1750.pdf)
- Szczerbiak, A., and Taggart, P. (2008), *Opposing Europe?: The Comparative Party Politics of Euroscepticism: Volume 2: Comparative and Theoretical Perspectives (Vol. 2)*, Oxford University Press.



## PRICING STRATEGIES IN THE LEBANESE PHARMACEUTICAL INDUSTRY

El Nemar, Sam; Mallat, Amani

School of Business, Department of Marketing, Lebanese International University, Lebanon,

### ABSTRACT

The pharmaceutical market is considered one of the important players in the global healthcare system. Nowadays, the pharmaceutical industry is growing fast due to the increasing demand for healthcare medications. This demand is due to the appearance of new diseases that have not been seen before due to many reasons that might include air pollution, extra usage of chemicals on vegetables and so on. Despite of the growth in the pharmaceutical industry, Lebanon's pharmaceutical sector is facing lots of challenges.

In this research, we will study the effect of a new pricing strategy adopted by the Lebanese minister of health on the sales of pharmaceutical companies and the type of measures they have taken to overcome this situation. To achieve this, a structural interview was conducted with a manager at a brand generic pharmaceutical company, followed by a survey done on a small population of hundred patients. After analysis, it was shown that price reduction of branded medicines will decrease the purchase of generic medicines and will encourage low income earners to purchase branded medicines. Quality is a great concern for patients and has a great impact on their purchase decision. Price reduction, income and quality are three tested factors that affect the purchase decision. The price reduction is not the only reason for preferring brands over generic medicines; the little awareness of and loyalty to generics empowered the purchase of brands. Thus, pharmaceutical companies especially generic ones have to ensure the quality of their medicines and to build loyal customers.

*Keywords: pricing strategies, brand-name medicines, generic medicines, pharmaceutical industry, patency, bio-equivalency, healthcare expenditure, medicine substitution, consumer buying behavior, income, price reduction, safety, quality.*

### INTRODUCTION

The pharmaceutical market is considered one of the important players in the global healthcare system. Nowadays, the pharmaceutical industry is growing fast due to the increasing demand for healthcare medications. This field is developed because of the great research to prevent illnesses and

the great emphasis on healthcare standards. Moreover, the economics around the globe counts on the pharmaceutical industry as a source of employment and earnings.

Despite of the growth in the pharmaceutical industry, Lebanon's pharmaceutical sector is facing lots of challenges; the high cost of pharmaceuticals along with the registration of fake medicines represent the major issues.

Lebanon's per capita pharmaceutical spending is the top in the Middle East region. Pharmaceuticals represent an important share of the Lebanese market translated in the form of sales volume exceeding 900 million USD in 2007. The annual spending on drugs was at 100 USD per capita in 2005, as estimated by Households.

Since 1990, the spending for prescriptions drugs has rapidly grown to the extent that it becomes the most active components of health care expenditures. In approximately 9 years (between 1990 and 1999), 12.2 % of growth in prescription medicine expenditure has been recorded (Kreling et al., 2001). Such growth can be slowing down through encouraging the use of generics that are less expensive than branded medicine. Thus, the amount spent on branded medicine should be reduced and that spent on generics increased to benefit from low cost.

The high spending is due to private pharmacies that have a fixed mark-up scheme on drugs by prescribing and selling pharmaceutical products that lead to high returns. Moreover, the Lebanese pharmaceutical market consists of more than 50 pharmaceutical companies, which reduces the economics of scale profits. It is noteworthy to mention that a great percentage of the Lebanese population does not have any type of drug insurance, thus, the high expenditure is a problem that should be followed by controlling the pharmaceutical market.

The local pharmaceutical production is limited due to the very high cost of production, lack of trust in the authenticity, small local market and limitations in the production efficiency. This local production can cover around 5% of the total local demand and 95% of the total sold products that are imported (Bankmed, analysis of Lebanon's pharmaceutical market-December 2014).

Three questions come into consideration:

RQ1) Should countries use price control measures to manage medicine prices?

RQ2) Should countries adopt measures to control add-on costs in the supply chain?

RQ3) Should countries promote the use of quality assured generic medicines as a strategy to manage medicine prices?

## LITERATURE REVIEW

### **What are brand name medicines?**

Brand name medicines are the original products that have been discovered by a company and have a patency allowing companies to ensure their survival and maximize their economic gain as a result of producing a particular medicine for a specific disease. Such companies spend lots of money on research and development; thus, the first recovery for their expenditures is obtained through sales. Despite the fact that many industrialized countries encourage the use of generic medicines, there is still a big need for brand name medicines as they respond to challenges faced by the healthcare delivery system. Indeed, innovative brand name medicines always improve the frontiers of good healthcare delivery system (King and Kanavos, 2002). Promoting the brand name costs a lot since pharmaceutical companies have to detail it to professionals, doctors and pharmacists through giving free samples and advertising it in healthcare journals. This is a part of their corporate image.

### **What are generic medicines?**

Generic medicines are pharmaceutical drugs that are equivalent to brand name drugs in dosage, strength, route of administration, quality, performance, and intended use. A generic medicine is identical to a brand name if they are bioequivalent. This means that, once taken, the active materials are absorbed into the blood as the absorption profile of the branded medicine. Generics cannot be produced unless the brand name patency is elapsed. Once expired, manufacturing companies are allowed to submit their files. Generic drugs may be marketed under the non-propriety name or as a branded generic (King and Kanavos, 2002). Despite the identity between generic and brand name medicines, they are sold at reduced price because there are no expenditures on Research and Development that brand name medicines have. Some generic medicines are sold at 40 to 50 % of the brand name while others at 20%, which create against the branded medicines which are more expensive (Lewin,1987).

### **Consumer buying behavior**

The mental, physical and emotional activities that people engage in when choosing, buying, and using products and services that satisfy their needs and desires are known as consumer behavior (Wilkie, 1994). These activities are included in the decision process, which helps people choose a particular product instead of another. The buying behavior of final consumers, individuals and households forms the consumer buyer behavior. It refers to the goods and services bought by final consumers and individuals, and used for personal consumption. So, the consumer market is a combination of these final consumers (Kotler and Armstrong, 2006). Normally, people relate their decision to purchase a product to its performance: their prediction of its performance is the contributor to their purchase decision. The processes of decision-making are characterized by multiple improvements in the brands

evaluated (Roberts, 1989). The more the amount of product-related experience is, the more the consumer's self-assessed knowledge is (Park et al., 1994). With medicines, consumers are not totally aware of generics. That's why their attitude towards them can be manipulated. They are not sure if the generics are as good as brand medicines and don't have the tool to know it. For this reason, consumers cannot make the right choice to select the best generic if they decide not to buy the branded medicine. Latest studies on consumer knowledge showed that consumers think that they usually know more than they actually do (Alba and Hutchinson, 2000). When purchasing a product, it is important to note that most customers are educated and informed enough to look through alternatives and make their better choice (Urban, 2004). This is applicable in the case of medicines since people might recall a medicine they used many years ago. More importance should be thrown on the customers' comments and responses, like one patient found generics were not as effective as branded medicine and another comment stating that one patient had a positive experience with generics and recommended them.

#### **The income's influence on the use of generic and branded medicines**

Generic medicines are cheaper than brand name medicines (Brooke 1975). Moreover, their prices have not increased as that of brand name medicines (Prescription Drug Trend, 2001). From an economic point of view, consumer surplus is known as the difference between the amount consumers are willing to pay and what they receive, showing the highest amount that can be paid (Mohr and Fourie, 2004). When customers buy generic medicines, they are economizing from the budget dedicated to their year supply of medicines, which makes them feel satisfied. Hence, it is logical for them to keep buying generic medicines, giving that they are as effective as branded medicines. However, when the only medicine available for patients is the branded medicine either because its patency has not elapsed or there is no generic version, the manufacturer will supply the product at price lower than its market price (Mohr and Fourie, 2004). If only branded medicines are available, consumers will be forced to use their surplus for the premium price that pharmaceutical company will put. This will lead to a deadweight loss to the society and some patients will be out of consumer surplus.

As confirmed by the U. S. Congressional Budget Office, generic medicines will help consumers save around \$8 to \$10 billion a year at retail pharmacies. More save can be generated if the use of generics applies on hospitals (US FDA, 2002). If consumers keep on buying generic medicines, they will be able to save some of their consumer surplus. Thus, it is obvious for low income earners to buy more generics whenever they have the chance to avoid branded medicines. Meanwhile, it is expected that better or high income earners will prefer branded medicines over generic medicines.

#### **Quality and the use of generic and branded medicines**

Generic drugs are known as alternatives for brand name medicines and are believed to have their same efficacy and effectiveness (Nightingale, 1998). Some generics have met the standards of the FDA

and have been approved for the following criteria: they have the same active materials of the originator, they have the same route of administration with the same dosage form, they are bioequivalent and are used in the same indications of the originator, and they are produced on the same standards required from the originator (US FDA, 2007). Some people refuse to believe that generics are as effective as the brands but argue that generics will fail or result in undesirable effects. However, as the generics are approved as the branded medicines, so their failure is almost minimal. Usually, generics are controlled by pharmaceutical companies and regulatory bodies. Moreover, post-marketing surveys are carried out periodically to ensure their activity and withdraw any incompatible medicine.

Although approved by the FDA, a case of medicine market withdraw has been recorded with the cox-2 inhibitor called "Vioxx" manufactured by Merck's pharmaceutical. After being marketed as a non-steroidal anti-inflammatory drug (NSAID), mainly for arthritis, the post-marketing monitoring revealed that it increases the risk of heart attack (O'Rourke IV, 2006), which resulted in its withdrawal. This has happened with a branded medicine but may not occur with a generic one because it is manufactured from the molecule of brands: such case can be recorded periodically during the post registration of medicines. Thus, the regular follow-up of regulatory bodies will ensure the withdrawal of branded medicines that are found to be dangerous.

## **PRICING STRATEGIES OF PHARMACEUTICAL PRODUCTS**

In the pharmaceutical industry, price is the most important part of the business. The ministry of health, through regulatory bodies, is mainly responsible for setting a particular price. The objective behind is to ensure the safety of patients and provide good quality healthcare. This is in addition to allowing companies to generate the necessary profit for continuous production of medicines needed. The pricing strategy for pharmaceutical products is similar to any other products, but the difference lies in the application as regulatory bodies are responsible for allowing a price (Filmore et al., 2004). There are many types of pricing that can be used: Price Negotiation, Average Pricing and Free Pricing.

## **COST STRUCTURE IN PHARMACEUTICAL PRODUCTS**

In the pharmaceutical industry, there are four types of costs: cost of active ingredients, cost of other ingredients, cost of packaging material, and cost of manufacturing.

### **A- Cost of Active Ingredient**

The active ingredient cost is the highest cost component. It represents about 30% of the total cost of product.

### **B- Cost of Other Ingredients**

Other ingredients defined as minor elements represent 3% or less of the total costs.

### **C- Cost of Packaging Material**

The cost of packaging material differs based on the type of packages whether a pack, a bottle or tube. In absolute terms, it ranges between Rs. 5-10 per pack of 10 tablets/capsules, per 60 ml bottle of liquid, per 5 ml injection & per 50 grams' tube of ointments (Ahmed et al., 2014).

### **D- Cost of Manufacturing**

The cost of manufacturing refers to the amount of products being manufactured in a factory. An additional cost of R&D should be taking into consideration when applied over time. In pharmaceutical industry, an average of 60% and above gross margin sounds good. It may go up to 500-1000% in case of new research molecule (Gehlbach et al., 1984).

## **SPECIAL TOPICS IN PHARMACEUTICAL PRICING**

### *Transfer Pricing Strategy*

Pharmaceutical companies, differently than other consumer products, are not allowed to advertise their products or even use any type of media that allows them to keep the advertising expenses that other industries are using to diminish their profit to avoid taxes and to pay dividends to the shareholders. Besides this, pharmaceutical companies should sign a code of ethics that prevents them from spending or promoting their products (Landau et al., 1999; Lexchin, 1992; Wolfe, 2002). Within this context, pharmaceutical companies have the actual cost of product, the only available source of manipulation. They look to increase the cost as much as they can through buying raw materials at their inflated costs from their own parent companies. This reflects the transfer pricing phenomenon. Unlike shopper items, administrations and customer durables, pharmaceutical organizations are not permitted to utilize the broad communications for publicizing their items. This shuts a vital cost place for them, which is customarily utilized by all different enterprises to lessen their benefits and demonstrate a higher cost keeping in mind the end goal to avoid imposes and paying profits to the shareholders. Other than this, there is a strict code of ethics pertinent which abstains them from spending past a specific point of confinement on advancing their items (Landau et al., 1999; Lexchin, 1992; Wolfe, 2002).

In this circumstance, the main territory accessible for control of cost is the actual cost of product. Organizations expect to make the cost show up as high as could reasonably be expected by purchasing the crude material at an inflated cost, in the greater part of the cases from their own parent organizations. This marvel is named as transfer pricing (Kotler and Armstrong, 2002; Lundin, 2000).

## **SPECIFIC CHALLENGES IN THE PHARMACEUTICAL INDUSTRY**

Every industry has main stress points for their products and services. The main stress points that are commonly known are schedule, cost, and quality. One or more of these stress points have an influence on the benefit of the industry, which results in classifying such points as critical to the accomplishment of the product and the organization conveying it. Thus, there must be a better consideration of these stress points to better create a product. Nowadays, this period is the hardest in medication improvement for pharmaceutical business. Lately, the political, administrative, social and financial weights are making the pharmaceutical industry more serious. Every year, one medication at least is revised due to claims from clients of competitors. The most critical stress point in the pharmaceutical business is quality because it reflects the health of patients. Low quality medicines result in ending someone's life. Achieving the first ranking in providing a new medicine is basic, however, the course of medication improvement is unusual. In pharmaceutical industry, quality control measures are critical. Responding to the needs, the quality is the most critical factor to be considered so as to reduce the dangers in the industry. Another present test for pharmaceutical organizations is the pressure they undergo to expand their efficiency, as the quantity of new products achieving the market has been expanding. This profitability decrease comes up with the fact that the business needs a better approach in its administration of clinical research, sedate schedule, and product delivery.

Moreover, the pharmaceutical industry may face other challenges since the price is affected by many factors. New member states may enter the market, which leads to more complicated pricing system and continuous production of generics. Also, some fake drugs may enter the market and favor low prices. This is in addition to the fact that some new resources for parallel imports may appear, and that, more importantly, the healthcare competencies may be transferred to regional levels, which makes the relationship between pharmaceutical companies and national healthcare system more difficult.

## **STATEMENT OF THE PROBLEM**

The increasing number of newly appeared diseases that have not been diagnosed earlier has encouraged pharmaceutical companies to produce new drugs. These drugs have been priced highly to an extent that exceeds the normal ranges. The over prescription of brand drugs becomes a serious problem because of the increased cost that easily exceeds one thousand dollars for a month treatment. These costs could not be afforded by all patients (Norris et al., 2005). Moreover, the health expenditure cost per capita is the greatest in the Middle East region. Pharmaceuticals represent an essential impart of the Lebanese market to a business volume surpassing 900 million USD in 2007. Family units yearly

OOP spending on medications was assessed at 100 USD per capita in 2005 (BankMed special report, 2014).

For this reason, adjusting the prices of drugs was considered as the first action done. On the other hand, it is essential to note that with a vast segment of Lebanon's population not secured by medication protection, the high per capita pharmaceutical use is viewed as a weight and should henceforth be handled through controlling the pharmaceutical market prices.

As a first step, the Ministry of Public Health (MOPH) prevails with regards to forcing solely high quality generic medications in Primary Healthcare (PHC) offices and making essential medicines broadly accessible in wellbeing focuses and dispensaries. This couldn't achieve a better situation but keeping the predominant one since years. However, the total spending on pharmaceuticals stayed high as the Ministry of Health couldn't influence the prescription habits of physicians who are the main contributors. It also couldn't find a way or a mechanism to expand the generics market share.

The permission for switching branded medicines with generic medicines wasn't pleasantly met by different stakeholders and individuals who have to deal with medicines as a service provider or as an end user (Government Gazette, Vol. 432, 2001). This opportunity has opened new doors toward medium sized companies to incorporate into the pharmaceutical business. The approval of the use of generic medicines without limits allows some specialized firms in the production of generic medicines to produce any medicines whose patent is completed. For companies whose business relies on branded medicines, this news comes as not pleasant. Some of their market shares might be lost because of the intense competition with generic companies. Their revenues won't last longer after their patency elapses because there are cheaper generic substitutes in the market.

The reduction in the cost of medicines will lead to a decrease in the total cost of healthcare delivery. Most of the studies done on pharmaceutical market have shown that the cost of prescription medicines is one of the main providers to any government expenditure on healthcare delivery (Kreling et al., 2001; Henry J. Kaiser Family Foundation, 2003). Generic medicines are as effective as branded medicines. Their heavy supply will ensure savings without compromising safety (Nightingale SL, 1998). Based on most studies, generic medicines are cheaper than branded medicines, and prices for generics have increased less than the prices of branded medicines.

The introduction of generic medicines to the healthcare system was assumed to provide cheaper and affordable healthcare services for government and individuals. This will allow government to cover a large population of the society with good healthcare services. However, such assumptions haven't been studied or reported.

Switching branded medicines with generic medicines poses always the issue of safety and quality. For this reason, the U.S. Food and Drug Administration (FDA) and the European Medicinal Agency



(EMA) examine generic compositions and match them with brand names drugs and approve them as bioequivalent in terms of safety, strength, and quality (Nightingale SL, 1998). Though, it is important to check out how people perceive the quality and safety and why some insist on buying branded medicines regardless of the cost and the trouble to get them.

Because consumer purchases are affected by many factors, such as cultural, social, personal, and psychological characteristics, this research covered the factor that perceptions influence consumer buying behavior while purchasing medicines.

Beside this, the MOPH has created a National Drug Formulary demonstrating generic choices for every brand. This was to a great extent conveyed and distributed on the MOPH site. This would help doctors who will try searching for less expensive medication options for their patients. It would, without a doubt, be most helpful for drug specialists once the legislation permitting them for substitution of endorsed medications is passed. While the Lebanese Ministry of Health is empowering the use of high quality generic medicine (FDA or EMA approved), the originator's organization, rather than contending by lessening the value, surges doctors with free specimens and offers generous bonuses to drug specialists (pharmacists) achieving once in a while 100%. This practice is against fair competition. It likewise supports huge drug stores, equipped for buying greater amounts with higher rewards to the inconvenience of little ones.

The trend in all European countries is toward the generic market to reduce the pharmaceutical spending. In addition, the reimbursement agents reimburse based on the generic price regardless of the drug purchased. Hence, the Lebanese minister of health found that adopting such strategy in Lebanon would cut the pharmaceutical market expenses and reduce the cash back money given by the reimbursement agents, which results in a better pharmaceutical industry. In order to reverse incentives, two ministerial decisions have been issued to control the drug prices. The primary decision (Government legislation # 301/1) forces change of prices in light of a value correlation with Jordan and KSA. Among 1102 medications normal with KSA and 1006 with Jordan, 872 medications were valued in Lebanon in view of an ex-industrial facility cost higher than the other two nations. Re-pricing prompted to variable abatements going after a few medications 40%.

The second decision (Government legislation # 306/1) accommodates another estimating structure that brings down the mark-ups set in 1983 regressively (net revenues diminish as ex-production line costs increment). Thus, the price decreases by the new ministerial decision and the law that forces generic companies to price their products 30% less than the originator. Also, pharmaceutical generic companies faces limited profits: they should have competitive prices to be able to compete with other generic companies. These two factors have resulted in many new challenges that pharmaceutical companies will face.

## OBJECTIVES OF THE CASE STUDY

The objectives of this study are:

RO1) To identify the consumer's perceptions on generic medicines versus branded medicines

RO2) To determine the impact of income, price reduction, and quality of medicines on the use of generic or branded medicines.

RO3) To identify the effects of price reduction on company sales levels.

## HYPOTHESIS TESTING

H1: Price reduction of branded medicines decreases the purchase of generic medicines.

H2: The decrease of medicine pricing encourages low income earners to stop avoiding buying branded medicines.

H3: There is significant difference between quality and the use of medicines (either generics or branded).

## RESEARCH METHODOLOGY

Since the problem is to check the challenges faced by pharmaceutical companies due to the new pricing strategies, it is suitable to conduct the two main research strategies; the quantitative and qualitative. The qualitative part is an initial open interview, conducted to gain a basic understanding of the market. It is a direction for quantitative data collection to gain insight on patient behaviors. The author has conducted a one to one interview with a manager at a brand generic pharmaceutical company, questioning him about the reasons behind the new pricing strategy, how it affected the company and what measures have been considered. Some of the open ended questions were:

Q: What are the main reasons behind this new pricing strategies?

He answered: *"Pharmaceuticals spending is viewed as a weight and Lebanon has the highest healthcare expenditure per capita, it is the top among the middle east which counts \$100 per person. In addition, the European and USA countries are using generic medications at 90% level, thus switching to low cost medicines is a must"*.

Q: What type of challenges faced you as a manager of this company?

He answered: *"In fact, adjusting the prices of medicines wouldn't bother us, however, it will lead to a better pharmaceutical market. But we, as a branded generic pharmaceutical company, our products are EMA approved products and we import from European suppliers, adjusting prices without considering the resulted effect hurts. Decreasing prices by 40% approximatively came as a shock. A product after price decrease becomes 3000 L.L*

*which is below its landed cost but we can't stop its marketing because it is the first step treatment for children and then it will be followed by other doses of it".*

Q: What did you do to overcome this situation?

He answered: *"At first, we were selling at the cost of some products. Then, we focused our promotion on products that generate more profits or at least cover the cost. Also, we cut expenses of marketing department where its most expenses come from sales. The low prices generated more units sold. For me, moving to free pricing products was my vision. I moved to working on products that generate profits and are not influenced by price reductions, which are multivitamins. Moreover, I enriched the equip of medical sales representatives with more employees and I reduced their areas for better focus".*

Q: What type of measures have you adopted?

He answered: *"For some products, I took the agreement from the supplier to import the raw material but do the package in Lebanon. Lebanese packaged products can be priced higher than their original prices. I also introduced a better version of products for preparing patients to colonoscopy. I enrolled in the Lebanese societies of cardiology and neurology to better position our products in the mind of doctors for more prescriptions. From my belief in the quality of our products, I sponsored a study at HDF comparing our main product in neurology line vs its brand that resulted in a better position of the product because of the similarity in efficacy and efficiency".*

Q: In your opinion, how did the new branded medicine prices affect the purchase of generic medicines?

Her answer was: *"The main purpose for this new pricing was to shift the Lebanese pharmaceutical market to a generic market since a vast segment of the Lebanese population is not covered. However, there were double the units sold for some brands. Changing the habits of the main prescribers were our mission. In our case, promoting and assuring the quality of our products have led to an increased number of units sold and sometimes the double. Not all the populations can buy branded products. Some patients have stopped their chronic treatments because of the prices. On the other hand, the reduction of brands prices encouraged some patients to prefer the brands over generics, while others are satisfied with the generic if it offers the same quality which reflects our case. To our benefit, our main products are categorized under the chronic treatment where the patients have to take the treatment for life. Thus, the cost of treatment matters, which encourages them to go for generic medicines".*

### **Research Design**

This study was carried out using a questionnaire to be able to collect data from patients who are under treatment. The questionnaire was distributed to patients in private clinics. Patients enrolled in this study were helped by the researcher to fill the questions without influencing their choices. For ethical issues, the questionnaires do not include the name of respondents. The data collected were analyzed quantitatively using SPSS statistical software. The dependent variable was the current

purchase of brand or generic medicine and the independent variables were the income, price reduction and safety of medicines.

### Sampling method

The sample size consists of hundred thirty patients of which one hundred were accepted after being fully completed. It was randomly selected using non-probabilistic sampling technique. The questions were simple, targeting the brand generic medicines and brand medicines for a better understanding of the habit used in pharmaceutical market. Through this questionnaire, the author tries to understand how the new pricing strategy, more precisely, the price reduction has affected the patients' purchase of medicines, how this purchase has affected the pharmaceutical profit, and whether there exists a relation between the reduced prices and medicines purchase habit (brand or brand generic). Through different variables correlation in the questionnaire, we get a better understanding of the effect of new pharmaceutical pricing over the medicines habit purchase and the profit generated.

The questionnaire is divided into two major sections:

**Demographics:** Age, gender, income, marital status and general questionnaire that includes questions about patients purchase habit, and price reduction effect on brand and generic medicines.

## ANALYSIS AND RESULTS

The descriptive analysis showed that 20% of patients are between 20 and 30, 35% of patients are between 30 and 50 and 45% of patients are between 50 and 70. More precisely, 40% of patients are male and 60% of patients are female. As for their marital status, 10% of patients are widowed, 20% of patients are single and 70% of patients are married. 15% of patients earn between \$1500- \$2000, 25% of patients earn between \$500- \$1000 and 60% of patients earn between \$1000- \$1500.

### Hypothesis Testing

**H1:** Price reduction of branded medicines decreases the purchase of generic medicines.

The conducted survey revealed the following:

Table 1: Chi-Square Tests for price reduction and purchase habit

	Value	df	Asymp. Sig. (2-sided)
Pearson Chi-Square	21.217a	4	.000
Likelihood Ratio	22.534	4	.000
Linear-by-Linear Association	1.745	1	.186
N of Valid Cases	100		

a. 3 cells (30.0%) have expected count less than 5. The minimum expected count is .87.

Table 1 describes the Chi-square test for the impact of price reduction of branded medicines on generic medicines purchase. Results revealed the Pearson-Chi square value is 21.217 where  $p$  is

0.000<0.05, this means that there is strong evidence of relationship between brands price reduction and generic medicine. This ensures that although generic medicines are believed to be cheaper and as effective as branded medicine, there are still some patients who will stay on branded medicines and a price reduction regardless of its value is not promising to switch or to keep them on generics, however it will boost brand medicine purchase and decrease generics purchase.

**H2: The decrease of medicine pricing encourages low income earners to stop avoiding buying branded medicines.**

Table 2: Chi-Square Tests for Income and Branded Medicine Purchase

	Value	df	Asymp. Sig. (2-sided)
Pearson Chi-Square	28.924a	8	.000
Likelihood Ratio	31.354	8	.000
Linear-by-Linear Association	.679	1	.410
N of Valid Cases	100		

a. 7 cells (46.7%) have expected count less than 5. The minimum expected count is .69.

Table 2 shows that there is also a strong evidence of relationship between income and branded medicine purchase (Chi-square=28.924;  $p=0.000<0.05$ ). Income is a contributing factor to the purchase habit. The more their income, the less likely people will buy generics and the low their income, the more likely they will buy generics. It is also applicable that the higher their income, the more they will buy branded medicine and the lower their income the less likely they will buy branded medicine. As found in the literature, low income earners will purchase generics. Moreover, the price reduction of medicine encouraged them to go for branded medicines and this price is no more a concern since it is almost at the generic level.

**H3: There is a significant difference between quality and the use of medicines (either generics or branded).**

Table 3: Chi-Square Tests for Quality and the Use of Medicine

	Value	df	Asymp. Sig. (2-sided)
Pearson Chi-Square	28.101a	4	.000
Likelihood Ratio	36.063	4	.000
Linear-by-Linear Association	8.434	1	.004
N of Valid Cases	100		

3 cells (30.0%) have expected count less than 5. The minimum expected count is .87.

Table 3 describes the Chi-square test for quality and the use of medicine. Results revealed the Pearson-Chi square value is 28.101 where  $p$  is  $0.000 < 0.05$ , this means that there is strong evidence of relationship between quality and the use of medicine. Patients who prefer quality in the use of medicine will not buy generics, they will go for branded medicines. Quality is a big concern as it

shows the efficacy of the medicines and ensures that it is regularly followed up by regulatory bodies. This assures the fact that pharmaceutical companies have to work more on educating their patients on generics and have to confirm the consistency of their medicines.

## CONCLUSIONS

This study investigates the challenges faced by Lebanese Pharmaceutical companies after the new pricing strategy adopted by the Ministry of Health. To be able to recognize and identify the issues behind the problem and its effect on patients, a one to one interview was conducted with the general manager of a Lebanese brand generic company and a survey was distributed to 100 patients. The open interview not only revealed the effect of pricing on one of the pharmaceutical industry but also served as a guide for searching the factors that might favor the generics over brands and the measures to take accordingly. This study confirmed that price reduction of branded medicine is a matter for generic companies since, as revealed, even low income earners who usually prefer generic medicines will purchase branded medicines at their reduced prices. The H3 showed that the quality of medicine is a contributing factor to patients. Thus, patients should be reassured on the quality and safety of generic medicines: they are up to the standards and provide them with cost benefit. The price reduction is not the only reason for preferring brands over generics; the little awareness of and loyalty to generics empowered the purchase of brands. Pharmaceutical companies especially generic ones have to differentiate themselves from other generic companies by branding themselves to ensure that patients ask about the products by the name of company. They can build a corporate image for them through branding over the counter.

## RECOMMENDATIONS

- 1-A better knowledge of the market and customer perceptions is necessary. This allows the company to better perceive and position their brands in the market.
- 2- It is of high importance to find out how doctors and healthcare professionals perceive generic medicines as they are the main influence to end users of medicines.
- 3- It is important to educate patients and build a brand awareness of generic medicines to ensure customers' loyalty and, in some cases, to correct wrong perceptions.
- 4- It is crucial to find out other factors that have an impact on consumers' purchase decision and can have good contribution to generic companies.

## REFERENCES

- Ahmed, R.R., Sattar, I., Khoso, I. and Parmar, V., 2014. New product development: strategy & implementation mechanism based on primary & secondary data research in pharmaceutical industry. *International Journal of Management, IT and Engineering*, 4(5), p.152.
- Alba, J.W. and Hutchinson, J.W., 2000. Knowledge calibration: What consumers know and what they think they know. *Journal of consumer research*, 27(2), pp.123-156.
- Bankmed, analysis of Lebanon's pharmaceutical market-December 2014.
- Brooke, P., 1975. Why Do We Pay So Much for Prescription Drugs? *Business and Society Review*, (13), pp.25-7.
- Filmore, D., Thayer, A.M. and Willis, R.C., 2004. Pipeline Challenges. *Modern Drug Discovery*, 7, pp.28-34.
- Gehlbach, S.H., Wilkinson, W.E., Hammond, W.E., Clapp, N.E., Finn, A.L., Taylor, W.J. and Rodell, M., 1984. Improving drug prescribing in a primary care practice. *Medical care*, pp.193-201.
- King, D.R. and Kanavos, P., 2002. Encouraging the use of generic medicines: implications for transition economies. *Croatian medical journal*, 43(4), pp.462-469.
- Kotler P. and Gary Armstrong., 2002. *Principles of marketing*. Prentice-Hall International, New Jersey
- Kotler, P. and Armstrong, G., 2006. *Principles of marketing*. Pearson Australia.
- Kreling, D., Mott, D., Wiederholt, J., Lundy, J. and Levitt, L., 2001. Prescription drug trends: a chartbook update. Menlo Park, CA: Kaiser Family Foundation.
- Landau, R., Achilladelis, B. and Scriabine, A. eds., 1999. *Pharmaceutical innovation: revolutionizing human health (Vol. 2)*. Chemical Heritage Foundation.
- Lexchin, J., 1992. Pharmaceutical promotion in the third world. *Journal of Drug Issues*, 22(2), pp.417-453.
- Lewin, T., 1987. DRUG MAKERS FIGHTING BACK AGAINST ADVANCE OF GENERICS (REPRINTED FROM NEW-YORK-TIMES, JULY 28, 1987).
- Lundin, D., 2000. Moral hazard in physician prescription behavior. *Journal of health economics*, 19(5), pp.639-662.
- Mohr, P. and Fourie, L., 2004. Economics for South African Students. Van Schaik.
- Nightingale, S.L. (1998) From the Food and Drug Administration. *JAMA*, 279:645. (PMID: 9496968).
- Park, C.W. and Lessig, V. (1981) Familiarity and its impact on consumer biases and heuristics. *Journal of Consumer Research*. Vol. 8, 223-280
- O'Rourke IV, J.S., 2006. Merck & Co. Inc.: communication lessons from the withdrawal of Vioxx. *Journal of Business Strategy*, Vol. 27 NO. 4, 11-22.
- Roberts, J., 1989. A grounded model of consideration set size and composition. *Advances in Consumer Research*. Vol. 16, 749-757.
- Urban, G.L., 2004. The Emerging Era of Consumer Advocacy, *MIT Sloan Management Review*, 77-82;
- US Food and Drug Administration, 2002. Center for Drug Evaluation and Research. What are generic drugs? Available from: <http://www.fda.gov/cder/ogd/index.htm#introduction>. Accessed, 26 August, 2007.
- Wilkes, R.E. and Humberto, V., 1985. Branding and Taste Perceptions, *Journal of Business research*, 10, 385-96
- Wolfe SM. Direct-to-consumer advertising– Education or emotion promotion? *New England Journal of Medicine* 2002; 346(7):524-526.

## **CORPORATE SOCIAL RESPONSIBILITY AND CORPORATE GOVERNANCE FOR NON-PROFIT ORGANIZATIONS AN EITHER / OR CHOICE?**

**Eller, Helene**

ZHAW School of Management and Law, Winterthur, Switzerland

### **ABSTRACT**

Non-profit organizations provide services and goods for its clientele, with profit being a minor objective. With this definition in mind it is obvious that the goal of non-profit organizations is to serve several bottom lines and not only the financial one. This approach is underpinned by the no-distribution constraint. Single shareholders who might have an interest in such an organization would be unable to benefit from its prosperity personally. Good governance is mandatory in order to support the aims of non-profit organizations. Looking for a measure for good governance the principals of corporate governance gain attention. Corporate Governance (CG) reaches this goal by focusing on supervision and control. Today, there exists an enhanced measure for this aim: Corporate Social Responsibility (CSR). The focus of this concept is on a so-called triple bottom line, which means to consider economical, social and also ecological concerns when making profits. The purpose of this paper is three-fold: Firstly, it is to find out if Corporate Governance and Corporate Social Responsibility are intertwined concepts based on their theoretical background. Secondly, both phenomena are discussed within the non-profit area. Finally, it is to ascertain, whether non-profit organizations should adapt also Corporate Social Responsibility to reach their goal of good governance. It is alleged that these organizations with their distinctive features are already unconsciously applying elements of Corporate Social Responsibility in their Corporate Governance and for this reason good governance is assured by the application of an enhanced Corporate Governance.

*Keywords: corporate social responsibility, corporate governance, profit-organizations, non-profit organisations, shareholder wealth, stakeholders, sustainable profits*



## INTRODUCTION

Corporate Governance<sup>2</sup> and Corporate Social Responsibility have already been widely discussed in science. Both concepts received attention in the scientific world through several incidents. The breakthrough for the attention of Corporate Governance was many worldwide crashes of corporations due to a lack of guidance and supervision. Corporate Social Responsibility received its attention in science due to a changing world. It is no longer enough to know how profits are used but above all how profits have been made. At a first glance, it might appear that there is no interconnection between both concepts.

This discussion paper starts with an overview of the theoretical background of both concepts. Afterwards, the question whether Corporate Governance and Corporate Social Responsibility should be applied as an “either/or choice” is elaborated. Furthermore, both concepts are transferred to non-profit organizations and an interconnection of both concepts shows up, as well. Finally, the proposition that non-profit-organizations are already applying an enhanced Corporate Governance with elements of Corporate Social Responsibility is evaluated.

## CORPORATE GOVERNANCE AND CORPORATE SOCIAL RESPONSIBILITY – LITERATURE REVIEW

### *Corporate Governance*

Corporate Governance got its attention in science because of many worldwide crashes of corporations due to a lack of guidance and supervision. The confidence in “good governance” was lost. The true and fair view of balance sheets has been questioned. Sir Adrian Cadbury put a landmark with his definition of Corporate Governance in 1992 as “...the system by which companies are directed and controlled” (Cadbury, 2000) to start an intense scientific discussion. The visible result of this discussion is the development of several Corporate Governance codes. Today, there exist Corporate Governance Codes in each of the current EU member states with compulsory character as well as the US. Over the past ten years the EU has put effort on harmonizing all these country-specific codes (Walsh and Lowry, ©2011). Due to the worldwide importance of the topic, even the OECD has published principles of Corporate Governance. According to OECD “Corporate Governance involves a set of relationships between a company’s management, its board, its shareholders and other stakeholders” (OECD, 2015). Research and thorough discussion about Corporate Governance which started in 1992 has its result in various definitions in the extension of a wider or narrower focus: Sir Cadbury focuses his

---

<sup>2</sup> The author has already undertaken thorough investigations into the field of Corporate Governance for non-profit organizations in the context of a doctoral study programme.

viewpoint about Corporate Governance on the system, i.e. the structure of a company whereas the OECD-definition explicitly mentions the various relationships and involves even stakeholders.

*Corporate Governance – theoretical background*

The theoretical background of corporate governance is multi-layered. It depends on the focus, which will be put on this concept. There is no doubt that agency theory is the predominant theory to explain the mechanism of Corporate Governance. In the centre of attention is the relationship between a principal and an agent where the principal delegates the execution of an action including decision making to an agent (Jensen and Meckling, 1976). The focus has to be on the principal as he is the bearer of the residual loss. The problem is that the agent may not act in the best interest of the principal. Different goal-orientations, risk preferences, information asymmetry are described as agency problems. Control will help to solve these agency problems (Fama and Jensen, 1983).

Agency theory is based on a special type of people. Between both parties, the principal and the agent, it is assumed that there is a trade-off between their goals. Both parties are assumed to be self-interested. In contrast, stewardship theory has been developed to draw attention to an opposite type of people acting in organizations, above all non-profit organizations. Stewardship theory's parties are the principal and the agent, too, but the agent – better defined as “steward” – maximizes the principal's interest by maximizing his personal goals at the same time (Davis *et al.*, 1997). The behaviour of a steward in stewardship theory is diametrically opposed to those of an agent in agency theory. This underlying assumption has far-reaching consequences: As already mentioned, the focus in agency theory is on control to cope with the divergent interests over the agent through more or less sophisticated incentive systems and governance structures. Control is also a matter of stewardship theory but with a completely different focus: Trust is an important prerequisite to install a control system, which presumes itself high identification with an organization. It gives the managers a high level of autonomy and working-conditions, which support trustful decision-making (Hernandez, 2008).

The attempt to understand Corporate Governance by using only one theory is hardly one-sided. A comprehensive picture of the basis of Corporate Governance is only possible by looking at further theories, too. The company or an organization's environment consists of a network of relationships with stakeholders. This focus is also emphasized by the Corporate Governance definition of the OECD. A company not only has shareholders but also a lot of stakeholders who might have a stake in an organization. Within for-profit organizations the shareholder is seen as the most important stakeholder, and therefore the focus is on it. Regardless this focus, stakeholders play an increasingly important role even in for-profit companies. Stakeholders are in the central focus of non-profit organizations as they represent the missing owner. The well-known definition of Freeman that *a*

*stakeholder is any group or individual who can affect or is affected by the achievement of the organization's objectives* (Freeman, 2010, 1984) is central to this paper as it belongs also to the concept of Corporate Social Responsibility, which will be discussed below. Stakeholder theory's actors are stakeholders. Stakeholder of a company or organization can be everybody who is of interest to a company or organization. The number of stakeholders depends on the size, mission and legal form. In theory, there have been developed several methods to reduce the number of stakeholders. The most important concept refers to that of Mitchell/Agle/Wood where power, legitimacy and urgency are attributes to reduce the number of stakeholders (Mitchell *et al.*, 1997).

The comprehensive picture of theories of Corporate Governance is not conceivable without business ethics. The purpose of a business is to create value for all groups and individuals who have a stake in the business (Freeman, 1993). This valuable purpose of business reflects two concepts which are business ethics and normative stakeholder theory. It becomes obvious that these concepts might be interconnected. But the assumption exists that ethics do not go together with attaining business goals such as maximizing profits. According to Elms *et al.* it is surprising that business ethics in the form of applied ethics have the same origin as strategic management. Unfortunately they grew apart as strategic management focused on profit making and business ethics on ethics itself. But by focusing the value creation process it becomes obvious that effective strategic management includes the considerations of ethics as well (Elms *et al.*, 2010).

### *Corporate Social Responsibility*

Corporate Social Responsibility gained attention in Europe in the years of 1990 although first ideas were released in the US in the late 1800s (Sitnikov, 2013). At this time, the concept was not attractive enough to be widely discussed in science. Obviously, the world had to change so that this concept perceived its value. The consequence of the various research activities in this field is that there does not exist a common definition, which states the unique understanding of the concept (Dahlsrud, 2006). Scholars claim the unclear situation regarding a unique meaning and try themselves to enrich the scientific discussion with their definitions or further explanations (This situation resembles those of the research field of Corporate Governance). It is still the responsibility of the author to choose an adequate understanding, which suits the discussed context. Carroll is the author who provides the most commonly accepted definition. He defines Corporate Social Responsibility as *"... the social responsibility of business as encompassing the economic, legal, ethical, and discretionary expectations that society has of organizations at a given point in time"* (Carroll, 1979).

The discussion about Corporate Social Responsibility has also attracted the European Union (EU) and the EU acknowledged the importance of this concept by providing a green paper. The understanding

of Corporate Social Responsibility in this paper is those that companies should integrate social and environmental concerns in their business operations and in their interaction with their stakeholders on a voluntary basis (Commission of the European Communities, 2001).

#### *Corporate Social Responsibility – theoretical background*

Today's meaning of Corporate Social Responsibility has been evolved over the years from previous theories and concepts like corporate social performance, corporate responsibility, business ethics just to mention a few examples. The concept is still far-reaching and offers a wide range of matters to focus on. Consequently, the underlying theories have to comprise all these matters, too. There exists hardly any more comprehensive overview of relating theories for this concept than those of Garriga/Melé (2004): The authors have classified the approaches and corresponding theories. The classification is done along underlying theories and has been clustered in four groups: The first group summarizes theories where the economic aspect of the interaction between business and society is focused. Social activity is welcomed only for the purpose of creating wealth to the corporation. These theories are called instrumental theories. Agency theory is represented within this group of theories. The second group of theories emphasizes the social power of the corporation with respect to its responsibility in the political area: political theories. The third group of theories looks at corporations in a way that they might have to integrate social demands in their business: integrative theories. Stakeholder theory, which is also used to explain Corporate Governance is an important theory within this group. The last group of theories deals with ethics: ethical theories. Business ethics has been mentioned above as well in the range of theories to explain Corporate Governance.

It is important to perceive that the theoretical concepts, which are used to explain Corporate Governance and Corporate Social Responsibility are partly congruent. In the next chapter it will be evaluated whether the discussed concepts are interconnected or have only the same starting point and then drift apart.

## **CORPORATE GOVERNANCE AND CORPORATE SOCIAL RESPONSIBILITY– AN EITHER/OR CHOICE**

The central idea of both phenomena is “good governance” but with various interpretations. Corporate Governance itself has been developed due to big worldwide crashes of companies. These crashes called for “good governance” with a growing meaning till today.

Good governance is ensured by focusing on defining roles, responsibilities and power among different parties, i.e. the board, the management and shareholders within an organization. Furthermore, at that time the focus of companies was on profit maximization only which means a

single focus on the financial bottom line. How profits are made was not in the primary interest even sustainable growth. Corporate Social Responsibility’s focus lies on *sustainable* profits and growth. The single focus on the pursuit of the financial bottom line with the unique purpose to satisfy shareholders has been enriched to a broader view: Profit organizations are forced to gain sustainable profits and not short-time profits. Shareholder wealth is still in the focus of interest but it should be achieved by *sustainable* growth, which includes also social and ecological aspects. Within Corporate Social Responsibility good governance is achieved by following a so-called triple bottom line.

The more embracing interconnection of both concepts will be discussed on the following overview of Schmidpeter (2013). In this overview (see fig. 1) several concepts are arranged hierarchically. The overriding is Corporate Social Responsibility. Corporate Governance is classified as part of Corporate Social Responsibility, but its meaning is narrowed only to compliance, anti-corruption and transparency or boni for the management. Compliance means to obey relevant rules, standards and laws for an organization. Compliance has to be understood as prerequisite for good governance. It can be called the “hard law” (Brändle and Noll, 2013). However, “good governance” comprises an extended set of rules, i.e. laws and firm-specific standards, upon an organization is governed. Corporate Governance Codes, for example of Austria and Germany, state in their preambles that the rules refer to international standards of “good governance” in a broader sense including not only the shareholders but also stakeholders (German Corporate Governance Code, 2015). Schmidpeter shows with his overview that Corporate citizenship and responsible lobbying are also part of the overwhelming concept of Corporate Social Responsibility. Corporate citizenship means activities like donations, corporate volunteering or investment in regions and responsible lobbying and industrial standards focus on the creation of framework conditions for companies (Schmidpeter, 2013).



Figure 1. Fields of Corporate Social Responsibility

To reinforce the discussion about the interconnection of Corporate Governance and Corporate Social Responsibility, it is to state that Corporate Social Responsibility with its triple bottom line has already inspired Corporate Governance Codes (Mullerat, ©2011). And depending on the applied focus or used definition, especially for Corporate Governance, there is hardly any difference between the concepts. The drawback of Corporate Social Responsibility is that its appliance is voluntarily and therefore these ideas might not have already reached the reality of profit-organizations. Shestack underpins the meaning that companies of the 21<sup>st</sup> century will have to balance their visions by taking into consideration multiple stakeholders. A profit-organizations is no longer only an economic organization with the focus on shareholder wealth, it is a human or social organization, too (Shestack, ©2011).

Corporate Governance and Corporate Social Responsibility are intertwined concepts. Their interconnection has shown up. There is no either/or choice. Today, the single focus on profit maximization is no longer defensible as shareholders have a growing interest in sustainable profits, too. Today, good governance has obtained an enriched meaning. The limited issues of Corporate Governance in the shown narrow meaning are not far-reaching enough. The awareness towards the consideration of multiple stakeholders and other additional dimensions is apparent.

## **CORPORATE GOVERNANCE AND CORPORATE SOCIAL RESPONSIBILITY FOR NON-PROFIT ORGANIZATIONS**

The discussion about Corporate Governance within the non-profit-area dates back to the very beginning of the 21<sup>st</sup> century. The outcome of the discussion within the non-profit area have been a few non-profit governance codes as well, for example in Germany (Diakonie, 2016), Switzerland (Zewo, 2016) and also Austria (Wirtschaftsuniversität Wien, 2013). The adoption of corporate governance to the non-profit area was put forward, because accountability and reliability of the board have become important topics also within this field. This refers above all to huge non-profit organizations as such organizations resemble more firms than typical non-profit organizations. The decision-making process in these huge organizations is mostly hierarchical. Corporate Governance structures have been implemented to increase reliability and accountability to the address of potential stakeholders (Bachert, 2006). Even smaller non-profit organizations have to prove their accountability towards their stakeholders above all if they gain their financial means through donations or membership fees. The formal implementation of this concept will be ensured by the several constitutions in its first step (Siebart und Reichard, 2004).

The thesis for this research is that Corporate Governance for non-profit organizations is not a mere concept of compliance but rather an enhanced one towards Corporate Social Responsibility. The

question is, if non-profit organizations have to put effort into adapting also Corporate Social Responsibility as a second concept or they enhance their existing governance concepts with valuable aspects of Corporate Social Responsibility. Arguments are discussed along the model of Schmidpeter which has been presented in the chapter above.

Non-profit organizations are an important social, political and cultural part of a civil society. The non-profit sector is huge and the inherent organizations are different regarding scope, mission, social and political importance and professionalism (Zimmer and Hallmann, 2005). The cornerstone to underpin the statement of an enriched Corporate Governance for non-profit organizations is the fact that non-profit organizations pursue special missions. Non-profit organizations have no owner but founders. Non-profit organizations are multiple stakeholder organizations, too. A narrow definition of Corporate Governance is concerned with the enhancement of shareholder value and protection of shareholder interest. The consideration of other stakeholders is not the primary interest. However, the daily business of non-profit organizations demands for consideration of complementary, conflicting or concurring stakeholder interests. The phenomena of Corporate Social Responsibility has the range of stakeholders in its central attention.

According to the model of Schmidpeter (2013) Corporate Governance is narrowed to anti-corruption, transparency, legal compliance and management-boni. Of course, transparency and legal compliance are topics which are also in the interest of non-profits but a narrow definition of Corporate Governance is not the Corporate Governance of non-profit organizations for the following reasons: Non-profit organizations in the legal framework of associations (Freise and Pajas, 2004) work with volunteers. Volunteer's interest is to give time freely to benefit for example an organization (Eller, 2013). Consequently, agency theory which is used to explain Corporate Governance in for-profit organizations is not adequate to explain this phenomena within associations. Stewardship theory is more relevant to understand such organizations with their special missions (Eller, 2015): The board of non-profit organizations as associations operates on a voluntary basis and furthermore, a lot of volunteers are necessary to provide services to the relevant stakeholders, above all members (Eller, 2013). Non-profit organizations face the challenge of multiple bottom lines (Schuhen, 2005): According to their characteristic as *not-for-profit-organizations* the financial and economic perspective is only the basis of their activity. The primary mission is to provide services and goods for charitable, religious, educational, etc purposes (Hay, 1990). Besides, the non-distribution constraint does not allow non-profit organizations to distribute their profits (Hansmann, 2010). Non-profit organizations have no primary interest in making profits due to their missions. Gaining of management-bon based on profits is consequently not relevant. Whereas profit-organizations can measure their performance via financial measures latter are of limited use for non-profit organizations. The total performance will be

assessed mainly on a range of qualitative measures and additionally by the multiple stakeholders. In this respect, Corporate Governance in non-profit organizations resembles more Corporate Social Responsibility.

Corporate Social Responsibility claims also to achieve ecological goals. Such goals can be a prerequisite of the activities of certain non-profit organizations. For example, the World Wildlife Fund (WWF), It acts worldwide and its mission is to strengthen people's awareness towards the protection of nature (WWF). Another example are Alpine Clubs: Such organizations located in merely all European countries have a statutory commitment to protect the Alpine environment (Austrian Alpine Club (UK)). However, an environmental interest as overall basis of the activities of non-profit organizations might have to be adopted consciously in statutes or further organizational rules. The consequence would be that an organization always should have an environmental focus in mind with all its activities, e.g. employees are motivated to travel by public transport not by car or they use environmentally friendly cars.

Cost pressure may force non-profit organizations to question their ecological and social consciousness regarding their human and natural resources they need to provide services for their stakeholders. Social standards for employees, i.e. working conditions have to be adhered like also profit-organizations have to. Regarding social standards, employees in non-profit organizations are more intrinsically motivated and may cope with minor working conditions better. Payment for example is not the primary source of motivation. Besides this, non-profit organizations have to consider which companies/organizations they hire for services or from which they buy raw materials or office equipment for themselves. To act in an ecologically and socially responsible manner includes also these areas.

The triple bottom line compels for the consideration of economic, social and ecological aspects in their operations. Non-profit organizations may apply a triple bottom line to a certain extend unconsciously. Corporate Social Responsibility could support them to integrate a triple bottom line consciously on a strategic level.

According to the overview of Schmidpeter, Corporate Citizenship and Responsible Lobbying also belong to the all-embracing concept of Corporate Social Responsibility. The question here is if these two concepts could also be transferred to non-profit organizations or these concepts are more applicable to profit-organizations. *Corporate citizenship* addresses topics where non-profit organizations are typically beneficiary, like donations or investments in regions or corporate volunteering. These social activities should support non-profit organizations to fulfil their mission. It is possible that a huge non-profit organization influences social life in its region for example as big employer. If such a non-profit organization also has an environmental focus in its mission, an



influence could also be possible regarding protection of the environment. Without going into much detail this part of Corporate Social Responsibility might only be partly adapted to non-profit organizations.

Non-profit organizations as associations have three functions, i.e. the service function for members and further stakeholders. Along this purpose, non-profits provide services according to their constitution, e.g. sports clubs provide education in sport. Community building as social function and integration of volunteers are vital functions of associations. With the representation of interests (advocacy), non-profit organizations' duty is to represent the interest of sometimes minor groups and influence politics if necessary and save availability of special collective goods (Leitner *et al.*, 2008). Responsible Lobbying is also important for non-profit organizations. To get worldwide attention and to achieve the power to influence in politics it is important to co-operate worldwide which huge non-profit organizations practice.

Corporate Social Responsibility is an important phenomena even for non-profit organizations. This chapter shows that non-profit organizations are likely to implement ideas of Corporate Social Responsibility as they already practice parts unconsciously. The overwhelming concept of Corporate Social Responsibility is not transferable to non-profit organizations without any adaptation. It is shown that some special issues within this conceptual frame to understand Corporate Social Responsibility might be of minor interest to these organizations.

## CONCLUSIONS AND FURTHER PROSPECT

Corporate Governance and Corporate Social Responsibility are two important concepts and their intertwining has shown up. Despite this fact, all efforts regarding Corporate Social Responsibility are of voluntary nature for profit organizations. Companies can still focus on the sole profit making goal. Unfortunately, it would need some legal pressure to convince profit organizations to apply consequently the triple bottom line-concept. Additional pressure could come also from knowledgeable consumers who preferably would like to buy products from companies who act in an economically and ecologically healthy manner. In contrast to Corporate Social Responsibility, the rules of Corporate Governance are of compulsory nature. Companies have to explain in the appendix of their annual reports why they do not follow certain Corporate Governance rules. The binding character of these rules have definitely supported its far-reaching implementation. Today, within the introduction of some Corporate Governance Codes ideas of Corporate Social Responsibility have been already adopted which might follow in a slight legal pressure to consider also these ideas. It is also Mullerat who understands Corporate Social Responsibility as the Corporate Governance of the 21<sup>st</sup> century (Mullerat and Brennan, ©2011).

With respect to non-profit organizations this research shows that non-profit organizations are in favour of applying Corporate Social Responsibility due to their mission and their distinctive features. Going through the areas of Corporate Social Responsibility there are a lot of proofs that non-profit organizations already apply elements of Corporate Social Responsibility. The Corporate Social Responsibility concept for non-profit-organizations could be characterized as an enhanced Corporate Governance and the advantage could be that these organizations do not have to adapt a further concept but just to enrich their already installed Corporate Governance. Of course, there is still enough room to elaborate a comprehensive concept of Corporate Social Responsibility for non-profit organizations.

This paper shows that for profit and as well as non-profit organizations the implementation of Corporate Governance and Corporate Social Responsibility is not an either/or-question, it is a question of the level of integration of both concepts.

The character of this scientific paper is a discussion paper. Its function is to open the path for deeper investigations in this field. A further step should be an empirical research to underpin that Corporate Social Responsibility could be a valuable concept for non-profit organizations even some elements might be already applied unconsciously. So far, Corporate Social Responsibility has got craven attention within the scientific research in the non-profit area. A deeper investigation might support the research in this field.

## REFERENCES

- Austrian Alpine Club (UK), "Constitution", available at: <https://aacuk.org.uk/> (accessed 31 December 2016).
- Bachert, R. (Ed.) (2006), *Corporate Governance in Nonprofit-Unternehmen*, WRS-Verlag, Planegg.
- Brändle, U. and Noll, J. (2013), "Sicherstellen von Compliance", in Zehetner, K. (Ed.), *Financial Leadership: Vom Experten zum CFO*, Linde international, Linde International, Wien, pp. 131–152.
- Cadbury, A. (2000), "The Corporate governance agenda", *Corporate Governance: An International Review*, Vol. 8 No. 1, pp. 7–15.
- Carroll, A. (1979), "A Three-Dimensional Conceptual Model of Corporate Performance", *Academy of Management Review*, Vol. 4 No. 4, pp. 497–505.
- Commission of the European Communities (2001), "Green Paper: Promoting a European framework for Corporate Social Responsibility", available at: [http://www.europarl.europa.eu/meetdocs/committees/deve/20020122/com\(2001\)366\\_en.pdf](http://www.europarl.europa.eu/meetdocs/committees/deve/20020122/com(2001)366_en.pdf) (accessed 29 December 2016).
- Dahlsrud, A. (2006), "How Corporate Social Responsibility is Defined. an Analysis of 37 Definitions", *Corporate Social Responsibility and Environmental Management*, Vol. 15, pp. 1–14.
- Davis, J.H., Schoorman, D.F. and Donaldson, L. (1997), "The distinctiveness of agency theory and stewardship theory", *Academy of Management Review*, Vol. 22 No. 3, pp. 611–613.
- Diakonie Deutschland (2016), available at: <https://info.diakonie.de/ueber-uns/transparenz-und-nachhaltigkeit/diakonie-corporate-governance-kodex> (accessed July 6 2017)
- Eller, H. (2013), "Volunteers within an Organizational Context - One Term is not Enough", *Journal of Business and Economics*, Vol. 4 No. 9, pp. 895–904.
- Eller, H. (2015), "Corporate Governance in Alpine Clubs in Europe", Doctoral Thesis, Riga
- Elms, H., Brammer, S., Harris, J.D. and Phillips, R.A. (2010), "New directions in strategic management and business ethics", *Business Ethics Quarterly*, Vol. 2 No. 3, pp. 401–425.

- Fama, E.F. and Jensen, M.C. (1983), "Separation of ownership and control", *Journal of Law & Economics*, Vol. 26 No. 2, pp. 301–326.
- Freeman, R.E. (1993), "Stakeholder theory of the modern corporation", available at: <http://academic.udayton.edu/lawrenceulrich/Stakeholder%20Theory.pdf> (accessed 29 December 2016).
- Freeman, R.E. (2010, 1984), *Strategic Management*, Cambridge University Press, Cambridge.
- Freise, M. and Pajas, P. (2004), "Organizational and legal forms of nonprofit organizations in central Europe", in Zimmer, A., Priller, E. and Freise, M. (Eds.), *Future of civil society: Making Central European nonprofit-organizations work*, 1st ed., VS Verlag für Sozialwissenschaften, Wiesbaden, pp. 129–146.
- Garriga, E. and Melé, D. (2004), "Corporate social responsibility theories: Mapping the territory", *Journal of Business Ethics*, Vol. 53 1-2, pp. 51-71.
- German Corporate Governance Code (2015), available at: [http://www.dcgk.de//files/dcgk/usercontent/en/download/code/2015-05-05\\_Corporate\\_Governance\\_Code\\_EN.pdf](http://www.dcgk.de//files/dcgk/usercontent/en/download/code/2015-05-05_Corporate_Governance_Code_EN.pdf) (accessed 31 December 2016).
- Hansmann, H. (2010), "The economics of nonprofit organizations", in Hopt, K.J. and Hippel, T. von (Eds.), *Comparative corporate governance of non-profit organizations*, Cambridge University Press, Cambridge [U.K.] ; New York, N.Y., pp. 60–72.
- Hay, R.D. (1990), *Strategic management in non-profit organizations: An administrator's handbook*, Quorum Books, New York.
- Hernandez, M. (2008), "Promoting stewardship behavior in organizations: A leadership model", *Journal of Business Ethics*, Vol. 80 No. 1, pp. 121–128.
- Jensen, M.C. and Meckling, W.H. (1976), "Theory of the firm: Managerial behavior, agency costs and ownership structure", *Journal of Financial Economics*, Vol. 3 No. 4, pp. 305–360.
- Leitner, J., Maier, F., Meyer, M. and Millner, R. (2008), "Managerialismus in Nonprofit Organisationen: Zur Untersuchung von Wirkungen und unerwünschten Nebenwirkungen", in Schauer, R., Helmig, B.P.R. and Witt, D. (Eds.), *Steuerung und Kontrolle in Nonprofit-Organisationen: 8. Colloquium der NPO-Forscher im deutschsprachigen Raum*, Johannes Kepler Universität Linz, 17.-18. April 2008, Schriftenreihe Public- & Nonprofit-Management, Trauner, Linz, pp. 89–111.
- Mitchell, R.K., Agle, B.R. and Wood, D.J. (1997), "Toward a theory of stakeholder identification and salience: Defining the principle of who and what really counts", *Academy of Management Review*, Vol. 22 No. 4, pp. 853–886.
- Mullerat, R. (©2011), "The Global Responsibility of Business", in Mullerat, R. and Brennan, D. (Eds.), *Corporate social responsibility: The corporate governance of the 21st century*, International Bar Association series, 2nd ed., Kluwer Law International; Sold and distributed in North, Central and South America by Aspen Publishers, Alphen aan den Rijn, Frederick, MD, pp. 3–32.
- Mullerat, R. and Brennan, D. (Eds.) (©2011), *Corporate social responsibility: The corporate governance of the 21st century*, International Bar Association series, 2nd ed., Kluwer Law International; Sold and distributed in North, Central and South America by Aspen Publishers, Alphen aan den Rijn, Frederick, MD.
- OECD (2015), "G20/OECD Principles of Corporate Governance", available at: <http://dx.doi.org/10.1787/9789264236882-en> (accessed 29 December 2016).
- Phillips, R.A., Berman, S.L., Elms, H. and Johnson-Cramer, M.E. (2010), "Strategy, stakeholders and managerial discretion", *Strategic Organization*, Vol. 8 No. 2, pp. 176–183.
- Roselle, J. (©2011), "The Triple Bottom Line: Building Shareholder Value", in Mullerat, R. and Brennan, D. (Eds.), *Corporate social responsibility: The corporate governance of the 21st century*, International Bar Association series, 2nd ed., Kluwer Law International; Sold and distributed in North, Central and South America by Aspen Publishers, Alphen aan den Rijn, Frederick, MD, pp. 129–156.
- Siebart, P. and Reichard, C. (2004). „Corporate Governance of Nonprofit Organizations“. In A. Zimmer, E. Priller, & M. Freise (Eds.), *Future of civil society. Making Central European nonprofit-organizations work* (1st ed., pp. 271–296). Wiesbaden: VS Verlag für Sozialwissenschaften.
- Schmidpeter, R. (2013), "Corporate Social Responsibility: A New Management Paradigm?", in Okpara, J.O. and Idowu, S.O. (Eds.), *Corporate social responsibility: Challenges, opportunities and strategies for 21st Century leaders*, Springer Berlin Heidelberg; Imprint: Springer, Berlin, Heidelberg, pp. 171–180.
- Schuhen, A. (2005), "Kontrollprobleme in Nonprofit-Organisationen und Lösungsansätze - Überlegungen auf Basis der Theorie und Praxis der Nonprofit Governance", in Hopt, K.J., Hippel, T. von and Walz, W.R. (Eds.), *Nonprofit-Organisationen in Recht, Wirtschaft und Gesellschaft: Theorien, Analysen, Corporate Governance*, Mohr Siebeck, Tübingen, pp. 221–241.
- Shestack, J. (©2011), "Corporate Social Responsibility in a Changing Corporate World", in Mullerat, R. and Brennan, D. (Eds.), *Corporate social responsibility: The corporate governance of the 21st century*, International

- Bar Association series, 2nd ed., Kluwer Law International; Sold and distributed in North, Central and South America by Aspen Publishers, Alphen aan den Rijn, Frederick, MD, pp. 113–126.
- Sitnikov, C. (2013), “CSR Life-Cycle Exploration”, in Okpara, J.O. and Idowu, S.O. (Eds.), *Corporate social responsibility: Challenges, opportunities and strategies for 21st Century leaders*, Springer Berlin Heidelberg; Imprint: Springer, Berlin, Heidelberg, pp. 111–125.
- Walsh, M. and Lowry, J. (©2011), “CSR and Corporate Governance”, in Mullerat, R. and Brennan, D. (Eds.), *Corporate social responsibility: The corporate governance of the 21st century*, International Bar Association series, 2nd ed., Kluwer Law International; Sold and distributed in North, Central and South America by Aspen Publishers, Alphen aan den Rijn, Frederick, MD, pp. 43–75.
- Wirtschaftsuniversität Wien (2013), “Österreichischer NPO-Governance Kodex”, available at: [https://www.wu.ac.at/fileadmin/wu/d/cc/npocompetence/downloads/npo-governance-kodex\\_ohne\\_erlauterungen\\_stand\\_oktober\\_2013.pdf](https://www.wu.ac.at/fileadmin/wu/d/cc/npocompetence/downloads/npo-governance-kodex_ohne_erlauterungen_stand_oktober_2013.pdf) (accessed 31 December 2016).
- WWF, “Governance”, available at: <http://www.worldwildlife.org/pages/governance> (accessed 16 February 2017).
- Zewo (2016), *Reglement zum Zewo Gütesiegel*, available at: <https://www.zewo.ch/Dokumente/21-Standards-mit-Reglement-2016/Reglement-Zewo-Guetesiegel-2016.pdf> (accessed July 6 2017)
- Zimmer, A. and Hallmann, T. (2005), “Nonprofit-Sektor, Zivilgesellschaft und Sozialkapital”, in Hopt, K.J., Hippel, T. von and Walz, W.R. (Eds.), *Nonprofit-Organisationen in Recht, Wirtschaft und Gesellschaft: Theorien, Analysen, Corporate Governance*, Mohr Siebeck, Tübingen, pp. 103–126.

# THE URBAN FREE ZONES (ZFU). BETWEEN DISAPPROVAL, MISUNDERSTANDING AND RECOGNITION. AS A SPECIAL DEVELOPMENT TOOL FOR LOCAL FINANCE

**Esposito, Paolo; Ricci, Paolo; Iovino, Felicetta**

Department of Law, Economics, Management and Quantitative Methods, University of Sannio, Benevento, Italy

## ABSTRACT

Semantic confusions and ambiguities on the notions of special economic zones do not find an explanatory and profound look on the part of economic business literature, but they find a strong reflection in reality and a fervent attention from the specialized international daily press, in the frequent emergence Of illegal, special economic, administrative and political areas ranging from Scampia to the Zen district of Palermo where the absence of the state and the presence of various (illegal) forms of economic systems cause abnormal life and development balances. This article, after reconstructing, identifying and reclassifying the concept of the Special Economic Zone (SEZ), tries to code some key variables of ZES and the Urban Zones (UFZ) in particular, to outline its critical success factors from the early Results obtained in the context of local Italian finance.

*Keywords: Urban Free Zones (ZFU), Special Economic Zones (ZES). Advantage Taxation, LEAP Zones*

## INTRODUCTION

There are numerous confusions generated by semantic ambiguities on special economic zones, which are not, however, a robust explanation of business economics. There are also many international definitions and acronyms of the Special Economic Zone, more than three thousand according to some scholars (Klugmann, 2013), which may vary from country to country; ZED to Cuba, ZEDE in Ecuador, SEZ in China, India, Africa (ICE, 2010), Australia; Free Zone in the United Arab Emirates, LEAP or EZ Zones in the US (Hodge, Komarek, 2016). However, they respond to reduced tax incentives or zero or bureaucracy or developed according to models of great operational simplification. The most frequent and recurring concept is the Special Economic Zones (SEZ), or Special Economic Zone (ZES), in Italian, which corresponds however to an area within a country where specific financial and economic laws are built With the aim of attracting foreign investors who might be interested in doing business in an area where they receive favorable tax, financial and financial benefits. A Special Economic Zone

(ZES) is an area, area, portion or geographical region with its own tax legislation (Mises, 1998, Romer, 2009; Esposito, 2012, 2014, 2015) and different (Lavoie, 1982: 177,178; McLauren, 2017) To the legislation in force in the country of origin and belonging (Moburg, 2013: 5, 16) as a taxation instrument for the benefit of free entrepreneurial initiatives (Ricci, 2011), policy or reform or fiscal reform (Ricci, 2010) and Even for ecological purposes (Monaghan, Nort, Southern, 2016; IGBC, 2015). Special economic zones are usually created to attract more foreign investment (Mises, 1998; Bauer, 2000; Moberg, 2013; Boettke and Moberg, 2013). Some of the larger ZESs are located in China, where the government has started creating such areas since 1980 (Zhao, Kuo, Wang, 2016) but there are examples in Europe (Madeira, Latvia) and Africa (ILO, 2012) although many free trade zones actually have similar characteristics to ZES. Within the ZES area, taxes are reduced and can be completely cleared, companies pay lower rates. The idea behind a special economic zone is that it can be able to stimulate rapid economic growth. By attracting foreign investors, nations can draw on wealth from other countries to improve their economies and living conditions. These areas can develop very quickly, attracting workers from all over the reference area. Many nations have experienced an economic boom due to special economic zones. Recently, Greece also faced the economic crisis, expressing its interest in the establishment of ZES as an exceptional instrument for the development of depressed areas but with strong potential, linked to the presence of harbors such as Piraeus.

## **SPECIAL ECONOMIC ZONES: A BRIEF COMPARATIVE EXCURSUS**

Special economic zones have been created in several countries including: People's Republic of China, India, Jordan, Poland, Kazakhstan, the Philippines, North Korea and Russia.

Among the various forms of "taxation of advantage", built from the earliest times to provide certain places - a neighborhood, a port, a productive area - of those tax and regulatory advantages that create real conditions of commercial and productive advantage, The Franche Urbane Zones (first identified in France in 1996) represent a valuable tool for local development. These instruments are more oriented towards solidarity than economic goals.

There are, for example, Urban Free Zones (ZFU) whose main objective is to "promote the economic and social development of neighborhoods and urban areas characterized by social, economic and employment disadvantage, with potential for development with potential for unexpressed development" through facilitations Tax, contributions and social security benefits.

The experience of the ZFU, however, is not new, and already other countries have adopted this tool to promote their business fabric. Just think of, for example, the United Kingdom that has set up Enterprise Zones (24 only in England) (Ward, 2016; Wetherell, 2016), focusing on a sector that can offer various tax incentives for startups in the first 5 Years of life; Then promoting registration in the

country of patents and intellectual property produced by industrial research and introducing a tax credit on R & D in order to make the country attractive even during times of economic crisis and possible tax losses for companies.

Here, replicate such experiences, strengthen existing legal instruments and propose the widespread establishment of UFZ throughout the country, differentiating depending on the peculiarities of the settlement area the productive sector of incentive production, could create (or re-create) ) Of the major manufacturing districts in our country, enabling businesses to network and thereby attract high-quality foreign investment. This could contribute to the Italian economic recovery, now that public debt and budget commitments have limited our spending capacity.

*SEZ in the People's Republic of China*

The term "special" in the Popular Republic of China mostly refers to special policies and flexible measures to manage the economic system. Among these measures and policies are: - special tax incentives for foreign investment in EES; - greater independence for the management of activities related to international trade; The principles governing the economy of Chinese special economic zones are: - structures primarily designed to attract and use foreign capital; - organization of economic activities through joint ventures between Chinese companies and foreign companies and through companies with exclusively foreign capital; - products made mainly for export to foreign markets; - economic activities mainly regulated by the market system. The special economic zones of the Popular Republic of China are indicated separately in national planning and financial planning. The economic administration is in charge of provincial authority. The legislative authority is exercised by the Congress and the local government.

*Box 1 - Special Economic Zones of the Popular Republic of China*

*Guangdong Province: Shenzhen, Zhuhai and Shantou*

*Fujian Province: Xiamen*

*Province of Hainan*

SEZs are a model for growth and modernization throughout China, a combination of innovation and productive best practices that compete with the most advanced industrial districts in the world's major economies. Their name is synonymous with progress, development, investment, GDP growth and employment (Mack, 2017). But also of pollution, degradation of local ecosystems and environmental devastation. These are the SEz, the Special Economic Zones, which were built at the end of the Seventies and have since become the main engine of the Chinese locomotive. Thanks to the special tax regimes they enjoy and ad hoc rules governing the activities that focus on them, specially designed to attract foreign firms and investments, these regions have been one of the most important growth tools used by China in recent years decades.

From an environmental point of view, however, the problems associated with this hypertrophic growth are remarkable. The plant, animal and ecological heritage that the Sez hosts is in fact exposed to serious risks and a constant damage linked to the high production rates achieved within them and to the increasing amount of waste and harmful emissions generated by them.

#### *The SEZs in India*

The Indian central government announced the creation of special economic zones in April 2000 with the intention of considering it as a foreign country for commercial, fiscal and customs purposes. The model adopted for special economic zones reproduces the Chinese model, and the Indian government wants to increase foreign investment, boost exports from the country, and create conditions to make Indian businesses competitive in the global market. The Indian Government also provided for the possibility of converting "Export Processing Zones" into special economic zones (Soundarapandran, 2012).

#### *Box 2: Special Economic Zones of India*

*Kandla of Surat (Gujarat)*

*Cochin (Kerala)*

*Santa Cruz (Mumbai-Maharashtra)*

*Falta (Western Bengal)*

*Chennai (Tamil Nadu)*

*Visakhapatnam (Andhra Pradesh)*

*Noida (Uttar Pradesh)*

## **THE URBAN FREE ZONES (ZFU) BETWEEN DISCOURAGEMENT, MISUNDERSTANDING AND RECOGNITION AS A DEVELOPMENT TOOL FOR LOCAL FINANCE**

The Urban Free Zone (ZFU) is an extremely topical issue of particular interest to the national territory. In fact, the Italian Ministry of Economic Development - Department for Development and Economic Cohesion has identified 22 throughout the country (MEF, 2009).

The tax leverage, a feature of the UFZ, undoubtedly represents one of the most effective tools to promote development goals and investment attractiveness.

#### *Disclaimer*

Well, among the various forms of "taxation of advantage", built from the earliest times to provide certain places - a neighborhood, a port, a production area - of those tax and regulatory advantages that create real commercial and Productive, the Urban Free Zone (first identified in France in 1996) (Di



Risio, 2011) is a valuable tool for local development. These tools are more oriented towards solidarity than economic goals (Scrofani, Leone, 2016).

### *Misunderstanding*

Italy, the UFZ was initially provided for by the 2007 Finance Act, then amended by the 2008 Finance Law, in those urban areas and districts characterized by particular economic and social disadvantages measured by the socio-economic disadvantage index obtained by the combination Of four indicators of socio - economic exclusion calculated for the areas concerned: unemployment rate, employment rate, youth concentration rate, schooling rate (Luchena, 2016).

The "benefit tax" introduced by the UFZ is embodied in a number of tax and social benefits for small and micro enterprises that start new activities in the area and in particular (MISE, 2015):

- total tax exemption from corporation tax and physical persons (IRES and IRPEF) for the first five years of tax;
- exemption from the regional tax on production activities (IRAP);
- exemption from municipal tax on real estate;
- waiving the payment of social security contributions on employee wages (Barabino, 2017).

These exemptions continue to diminish gradually over the next nine years (60% from sixth to tenth, 40% for eleventh and twelfth, 20% for two consecutive years).

The exact identification can be found in the Interministerial Decree 10/04/2013 as well as in further measures (Legislative Decree 179/2012; Inter Ministerial Decree 21/01/2014; Decree No. 78/2015; Decree No. 244 / 2016; circular MISE 10/03/2016; DI 50/2017).

Through these benefits (tax and social security), UFZ's main objective is to stimulate, promote and stabilize entrepreneurial activity locally in areas with particular social and economic disadvantages through the implementation of socio-assistance interventions aimed at reducing Uncomfortable conditions of the resident population and dynamism in the area to counteract the phenomenon of delinquency, unemployment and undeclared work.

The experience of the UFZ, however, is not new, and already other countries have adopted this tool to promote their business fabric. Just think of, for example, the United Kingdom that has established Enterprise Zones (24 in England only) focused on a sector that can offer various tax incentives for startups in the first five years of life; Then promoting registration in the country of patents and intellectual property produced by industrial research and introducing a tax credit on R & D in order to make the country attractive even during times of economic crisis and possible tax losses for companies.

Here, replicate such experiences, strengthen existing legal instruments and propose the widespread establishment of UFZ throughout the country, differentiating depending on the peculiarities of the

settlement area the productive sector of incentive production, could create (or re-create) ) Of the major manufacturing districts in our country, enabling businesses to network and thereby attract high-quality foreign investment. This could contribute to the Italian economic recovery, now that public debt and budget commitments have limited our spending capacity.

#### *Recognition*

##### *The regulatory and administrative procedure on the UFZ*

In its definitive design on the UFZ, the approved device extends the eligibility for benefits to urban areas, characterized by significant social disadvantages, located in 22 cities distributed throughout the country.

The DPS coordinated the inter-institutional process of presenting and evaluating project proposals. Objective indicators have been used to identify the areas based on the 2001 infra-municipal data of the 2001 Census.

Having obtained the favorable opinion of the United Nations Conference on 25 March 2009, the technical proposal drafted by the DPS was approved by the CIPE at the session of 8 May 2009. These provisions come together in a "Disclosure and Allocation Resolution To 22 Urban Free Zones for tax and social benefits in favor of new productive settlements. "

CIPE's approval has been a key step towards implementing the device. On 11 June 2009, the DPS initiated the procedure for notification of the aid scheme, registered in N346 / 2009, at the competent services of the European Commission's Competition DG. The achievement of the Community authorization has allowed the effective entry into force of the benefits provided for in the operating rules by the Ministry of the Economy and Finance.

##### *UFZ experiences and policy*

The areas identified by CIPE in 2009 for the first experimentation of the UFZ device are located in 22 Italian cities (Chart 1).

The first 22 Urban Free zones were provided in the areas of:

*Andria, Cagliari, Campobasso, Catania, Crotone, Erce, Gela, Iglesias, Massa-Carrara, Lamezia Terme, Lecce, Matera, Mondragone, Naples, Pescara, Quartu Sant'Elena, Rossano, Sora, Taranto, Torre Annunziata, Velletri, Ventimiglia*

Over time, the number of UFUs has grown considerably so as to induce the Government with the 2016 Stability Law on the one hand to circumscribe its territory to that identified by CIPE resolution no. 14 of 8/05/2009 (Law 208/2015, Luchena, Rinaldi, 2016, Chamber of Deputies, 2017), on the other to establish new areas in Lombardy and later with D.L. n. 50/2017 also in the communes of the Reatina affected by the earthquake.

##### *The process of identifying UFZs*

Municipal administrations have been at the center of the Urban Free Zone detection device. It was the task of the Municipalities to identify the areas, to elaborate the design proposals, to define the management methods and to plan any additional investments to be activated on the same territory to maximize the overall effects of the interventions.

As specified by the DPS Circular of June 26, 2008, the project proposals were submitted to the responsible structure of their Region within the terms set out in CIPE Resolution no. 5 of January 30, 2008, published in the Official Journal of June 6, 2008.

Municipalities have drawn up their own design proposals through the preparation of a specific document, which described in detail:

- the existence of eligibility requirements for municipal territory;
- the existence of eligibility requirements for identified UFZs and the modalities of the perimeter;
- the calculation of the socio-economic disadvantage index (IDS);
- the reasons underlying the proposed UFZ;
- how to manage the project;
- any further programs and projects for the upgrading and upgrading of identified areas.

In order to facilitate the technical investigation of the involved administrations, DPS has attached to its circular an index-type that articulated the information content necessary for the correct drafting of the design proposals. The entry into operation of the UFZ also provides an opportunity for growth and development; Especially if the measures are all the more effective if they are "systemized" with other measures taken by the Government to help small and medium-sized Italian companies (ie the so-called "innovative startup"). Indeed, most of these measures can be cumulated by creating a positive ecosystem capable of attracting investment and supporting the Italian economy by opening up new businesses and production facilities, reorganizing existing businesses and their financial capitalization and, consequently, the creation of jobs and the emergence of a knowledge economy.

#### *Free Zones in MENA countries: some cases*

The MENA countries (Dassel, Eckermann, 2013) have realized over the past 30 years both franchise areas that mainly deal with trade free zones and special economic zones (Del Federico, 2009). Connotation is therefore of a predominantly economic nature. Born mainly as Free port zones, as simple storage areas and without customs duties, they have evolved into export processing zones for re-export and special economic zones with regulations that are often different from those of the host country. The FEZs of MENA's countries differ from country to country, as well as its investment environment. However, it is possible to identify common elements. In fact, FEZs are based on strong regulatory incentives, with significant administrative simplifications of the procedures for businesses located in the areas. There are authorities in the one-stop shops that issue all necessary licenses and

permissions and check the regularity of the rules. Another prevailing incentive is the exemption from the limits of private property provided in the host country. Other facilities provided by many FEZs in the Mena countries are always differentiating from national legislation, allowing land to be sold to foreigners or renting it for long periods, even with state aid. Countries that have foreign trade restrictions also allow companies operating in the FEZ to market outside this regime. Almost everywhere the areas are near ports and airports and with physical infrastructures far superior to those of the rest of Pease. FEZs are therefore created in these countries by replacing investment attractiveness strategies with state interventionist policies in order to achieve economic and industrial development (Christiansen, Bohmer, OECD, 2004). SEEs in the MENA countries, as well as in the rest of the world, have multiplied, as shown in the following graph (Figure 1).



Economist.com

Source: Economist (2015)

The results achieved by SEZ countries in the MENA countries, as well as worldwide, are positive compared to the main indicators. As shown in the figure below (Figure 2), the extent of trade, customers and workers in two Free zones in the UAEs not only have a growing trend over time as to assume higher values not only globally but also in same state.

**Figure 2: Jebel Ali Free Zone Performance in Context**  
Jebel Ali Free Zone has experienced success across a number of economic dimensions

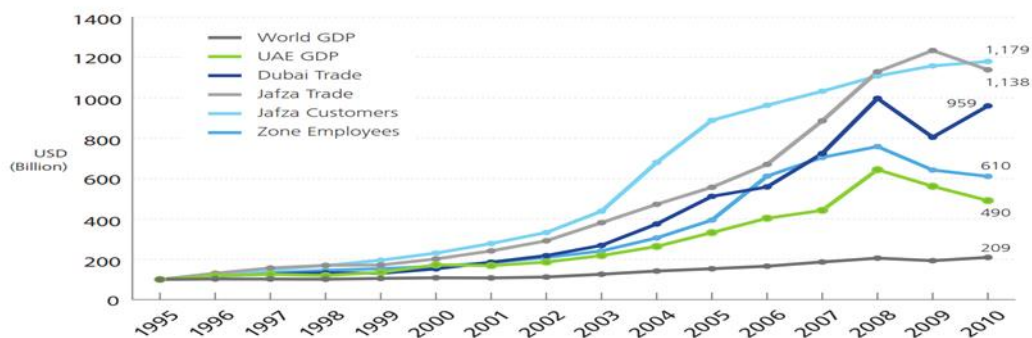

Source: World GDP: IMF, World Economic Outlook Database, Mar 2011. UAE GDP: IMF, World Economic Outlook Database, Mar 2011. Dubai Trade & Jafza trade: Statistics Department, Dubai World. Jafza Customers, zone employees: FreeComs, EZW

Fig. 2: source: Dassel, K., Eckermann, (2013)

In TangerMed there are also 60,000 jobs created, more than 2.6 billion euros per exported euro, more than 50 km of high-speed railways connecting those areas to the rest of Morocco (SRM, 2016). 46.3% of UAE imports are re-exported and the percentage rises to 70% in Free zones (Srm, 2015). World exports made in free zones as mentioned earlier, as shown in the following figure (Figure 3) are remarkable and direct employment is about 65-70 million, the weight of exports is 40-80% of the total of the country (Srm, 2016).

Figure 1 A comparison of SEZs' exports and level of employment creation by region

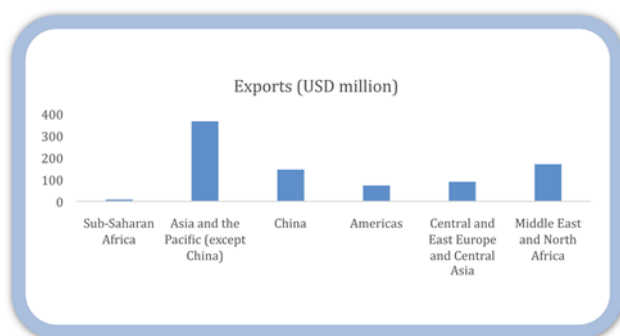

Fig. 3 – source: Tao, Y., Yuan, Y., Lee, M., 2016

The key factors of successful MENA Free zones are different and some may be useful to improve the Italian experience. Below we show the main discernible differences (Figure 4):

Differences	MENA's countries	Italy
Government Goal	Diversification Economy and Free Market Opening	Development and recovery of local communities
Primary recipients	Foreign Investments (FDI)	Italian Investments
Types of firm	Large and Small Businesses	Small and Micro Businesses
Nature Action	Commercial	Economic-Social
Types of zones	Exporting processing / trade zone Industrial zone	Urban free zone Rural Development Areas

Fig. 4 - ns processing

Below we will look at the main features of the free zones of some countries in the MENA area.

#### *The free zones in Morocco*

Even the Free Zones in Morocco have a predominantly economic feature and are aimed at attracting foreign investors. Nevertheless, the establishment of Free zones by Law 19-94 (Dahir No. 1-95 - dated January 26, 1995) has resulted in a strong urban development of high speed railways, highways, electricity and water infrastructure, contributing considerably to improve the quality of life of the areas.

The free zones in Morocco are 4:

- Tanger Med Ksar el Majaz Melloussa 1 and 2
- Dakhla,
- Laayoune (MCE Morocco, 2016).

Free zones enjoy special benefits:

- exemption from the registration charges for constitution and capital increase,
- register of the registration charges for land acquisition for the construction of a ten-year-long-term investment project,
- exemption from professional tax for 15 years,
- exemption from urban taxes for 15 years,
- total corporation tax exemption for the first 5 years of activity and application of a rate of 8.75% for the next 20 years beyond 20 years applying a reduced rate of 17.5%
- total exemption from income tax for the first 5 years of activity and 80% reduction for the next 20 years,
- profits on shares, social parties and similar assets are exempt from taxes and held for non-resident residents, a 7.5% downloadable rate applies to residents,
- exemption from VAT for goods and services rendered in a free zone,
- exemption from all customs duties for import.

Also, foreign companies may benefit from subsidies from the Moroccan government, which grants financial assistance for the acquisition of land and / or construction of production units (The report - Morocco, 2013).

#### *Free zones in the UAE*

The UAE has realized most of the Free Zones of the Mena Countries, about 1/3. The objective is to promote the economy, but also the growth of the region.

Each Free Zone is designed around one or more business category and only offers licenses to companies within those categories. An independent Free Zone Authority (FZA) governs each free zone, and is the agency responsible for issuing FTZ operating licenses and assisting companies with establishing their business in the FTZ.

The Free Zones are located in the various Emirates:

- Dubai Free Zones,
- Abu Dhabi Free Zones,
- Sharjah Free Zones,
- Rak Free Zones,
- Fujairah Free Zones (Commitbiz, 2017).

The advantages offered by the Free Areas of the UAE are different, but there are, unlike the two cases discussed above, also limitations. In addition to the possibility of carrying out, as mentioned above, only the activities specifically provided for further limitations are:

- the free zone company is not allowed to trade directly with the UAE market. The free zone companies can undertake business activity in the local Arab markets only through locally appointed distributors,

- 5% customs duty is applicable to local business (infogalactic, 2016).

The recognized advantages are:

- 100% foreign ownership,
- 100% repatriation of capital and profits,
- 100% exemptions from corporate, personal, or income taxes,
- 100% free transfer of funds, and no foreign exchange controls,
- exemption from all import and export duties,
- efficient communication procedures and single window administration,
- timely and streamlined immigration process,
- sponsorship and visas for affordable skilled work-force,
- flexibility to operate 24/7,
- Freeholds available on sale or lease,
- ready-made offices, factories and warehouses,
- easy start-up and licensing procedures,
- 3 years Uae residence visa,
- no restrictions on hiring expatriates.

## **RESULTS SO FAR PRODUCED IN ITALY**

The context of the economic and financial crisis that has hit the industrialized countries over recent years has led Governments to move in the direction of embarking on integrated programs where economic competitiveness, social cohesion and territorial vocation constitute the "pillars" of the measures taken. In this context, the introduction of UFZs in Italy has been established. Significant progress has been made in granting benefits in January 2015 to the first experience of Eagle, due to the switch to digital procedures (De Angelis, Pagliarini, 2016).

However, MISE (2015) data indicate that at 31/01/2015 the average national benefit rate of the benefits is only 31%. In this way, the objective of economic and social development of the territories concerned is not realized, if not modestly, concretely.

In addition, among the companies excluded from the reliefs, "firms in difficulty", those companies that in the previous year lost  $\frac{1}{4}$  of their subscribed capital or those companies involved in an insolvency proceedings. Among these companies, many of the s.r.l. With a share capital of 1 euro, born precisely with the aim of promoting economic and social development (Esposito, P., 2015).

It should be borne in mind that from the initial 22 UFZ it has reached 46, plus another 10 outside the convergence objective called II generation UFZ. The latter were born to cope with emerging events, such as earthquakes and floods, which distorted the essence of social and urban recovery of the affected areas (Scrofani, Leone, 2016; MISE, 2015). Additionally, an " encircling effect " is added that can bring more difficulty than advantage. Initially, there were maximum 2 free zones per region, but long overdue this limit is losing the sense of the interventions. Faced with empty legislation and politics has often acted without adequate tools to interpret and tackle the risk by confusing it with opportunistic political bets "(Ricci, 2015). So the excessive spread of free zones has generated far-reaching rays of activity that are likely to create excessive inequalities between areas outside the area where the tax evasion process and free zones are benefiting from tax incentives without becoming a factor Development for those who are not free. The tax advantage for some areas is therefore likely to result in disadvantageous taxation for contiguous territories excluded from free zones (Esposito, Ricci, 2015). Thus, urban free zones, besides being a development flyer, also have unavoidable risks, including the relocation of operating sites, the development constraint in one area, the abandonment of neighboring communities by families and businesses, and the the risk of not respecting the identity and vocation of a given territory (Esposito, Ricci, 2015) beyond the possibility of clientelism. Critical is also the temporary nature of interventions, especially for natural emergency areas (Buccico, 2008). Indeed, if the prevailing time appears reasonable, the lack of funds prevents the intervention from being lasting and effective (MISE, 2015; Luchena, Rinaldi, 2016; Scrofani, Leone, 2016; De Blasio, Accetturo, 2007) Even in terms of perception (De Leo, 2011).

It is therefore desirable, first of all, to increase the funds available for such interventions. In addition, greater coordination between Municipalities and Central Government, as well as greater accountability of the former in the identification of UFZ (Svimez, 2016), will surely make the instrument more effective by bringing it back to the original design. Greater control over the benefits of measuring the real impact on the area of business settlement can contribute to a more careful selection of ZFU than the companies to be funded.

The MES country analysis also allows us to identify key success factors: ease of access to areas, multiple activities, incentive attractiveness with respect to the national tax system, government intervention to provide incentives and guarantees investors with unified legislation, an independent authority that defines mission and goals, and a good infrastructure that is always provided by the government or in any case guaranteed to private developers (Bohmer, 2011). Some of these, such as unitary legislation, ease of access to areas and the creation of an independent authority, are aspects to be imitated in order to improve the performance of the Italian SEZs. Finally, in addition to the above,



it is added that the performance of Can be isolated from other economic forces, most of those areas may be deemed to fail.

## REFERENCES

- Bohmer, (2011), "Key lessons from selected economic zones in MENA region, First meeting of the working group on investment zones in Iraq", Amman, 29-30 March 2011, available from: <http://www.oecd.org/mena/competitiveness/47549084.pdf>, (access 30/04/2017).
- Bohmer, A., Christinsen, H., (2004), "Incentives and free zones in MENA region: a preliminary stocktaking", OECD, available from: <https://www.oecd.org/mena/competitiveness/36086747.pdf>, (access 29/04/2017).
- Buccico, C., (2008), "Il fondamento giuridico delle zone franche urbane e l'equivoco con le zone franche di diritto doganale", *Diritto e pratica tributaria*, vol. 79, issue 1.
- Camera dei Deputati, (2017), "Le zone franche urbane", available from: [http://www.camera.it/leg17/561?appro=le\\_attuali\\_zone\\_franche\\_urbane\\_zfu\\_Le\\_attuali\\_Zone\\_Franche\\_Urbane\\_\(ZFU\)](http://www.camera.it/leg17/561?appro=le_attuali_zone_franche_urbane_zfu_Le_attuali_Zone_Franche_Urbane_(ZFU)), (access 29/04/2017).
- Commitbiz, (2017), "Business formation in UAE free zone", available from: <https://www.commitbiz.com/free-zone/uae-free-zones.php>, (access 30/04/2017).
- Dassel, K., Eckermann, (2013), "Using special economic zones to drive job creation in Mena", Deloitte, available from: [https://www2.deloitte.com/content/dam/Deloitte/tr/Documents/public-sector/EN\\_Economic%20Security%20and%20Competitiveness\\_16072014.pdf](https://www2.deloitte.com/content/dam/Deloitte/tr/Documents/public-sector/EN_Economic%20Security%20and%20Competitiveness_16072014.pdf), (access 29/04/2017).
- De Angelis, A., Pagliarini, F., (2016), "Zone franche urbane, un caso da 600 milioni di euro: facciamo il punto", Forum PA, available from: <http://www.forumpa.it/pa-digitale/infrastrutture-invalita-gestione-automatizzata-dei-processi-amministrativi-il-caso-delle-zone-franche-urbane>, (access 30/04/2017).
- De Blasio, G., Accetturo, A., (2007), "E la periferia diventa zona franca", *la voce.info*, 22/11/2007, available from: <http://www.lavoce.info/archives/24600/e-la-periferia-diventa-zona-franca/>, (access 30/04/2017).
- De Leo, D., (2011), "ZFU: prove di innovazione per i quartieri deboli", *Urbanistica Informazioni*, issue 227/228.
- Di Paolo, B., (2017), *Le zone franche urbane nel diritto tributario*, Edizione Streetlib.
- Di Risio, A.P., (2011), *Marsiglia e la zona franca urbana*, 5/04/2011, *Urbanistica Informazioni*, pp. 65-68.
- Economist, (2015), "Political priority, economic gamble", *Apr 4th 2015*, available from: <http://www.economist.com/news/finance-and-economics/21647630-free-trade-zones-are-more-popular-ever-with-politicians-if-not>, (access 30/04/2017).
- Esposito P., (2012), *Integrity distortions and public policies in the local P.A.s. Theoretical lines, emerging practices, contradictions: a first path of conceptualization*. Rirea, 7/8.
- Esposito P., Ricci P., (2014), *Public (dis)Value: A case study*, in *Public Value Management, Measurement and Reporting* (in J. Guthrie, G. Marcon, S. Russo, F. Farneti), Emerald Group Publishing.
- Esposito P., Ricci P., (2015). "How to transform the Public (dis)Value in Public Value?. Evidence from Italy", *Public Money & Management*, Routledge – Taylor & Francis Group, UK
- Hodge, T., Komarek, T., (2016), "Capitalizing on Neighborhood Enterprise Zones: Are Detroit residents paying for the NEZ Homestead exemption?", *Regional sciences and urban economics*, Vol. 61, pp. 18-25 [sachers-association/2017-atta-conference-papers](https://www.sciencedirect.com/journal/Regional-sciences-and-urban-economics/issue/S092664601630001) (access 28/05/2017).
- IGBC, (2015), *Green SEZ Rating System (Pilot Version)*, available from: <https://igbc.in/igbc/redirectHtml.htm?redVal=showGreenSEZnospn> (accessed 29.04.17).
- ILO, (2012), *Zone francaes, droits des travailleurs et stratégies syndicales*, IBIT, Genève, Suisse.
- Infogalactic, (2016), "List of free zones in the UAE", available from: [https://infogalactic.com/info/List\\_of\\_Free\\_Trade\\_Zones\\_in\\_the\\_United\\_Arab\\_Emirates](https://infogalactic.com/info/List_of_Free_Trade_Zones_in_the_United_Arab_Emirates), (access 30/04/2017).
- Informazioni*, issue 227/228.
- Klugmann, M., (2013), "Leap zones: faster growth with less conflict," 12 July 2013, available at: <http://www.caymanfinancialreview.com/2013/07/12/leap-zones-faster-growth-with-less-conflict/>, (access 30/04/2017).
- Luchena, G., Rinaldi, A., (2016), "Le zone franche urbane nella legge di stabilità 2016. Annotazioni per uno studio interdisciplinare", *Rivista giuridica del mezzogiorno*, No. 1, pp. 323-340.
- Mack, I., (2017) "Special economic zones in China. The reforms that made China's economy what it is today", 19/02/2017, available at: <https://www.thoughtco.com/chinas-special-economic-zones-sez-687417>, (accessed 29/04/2017).

- MCE Morocco, (2017), "Free zones", available from: <http://www.invest.gov.ma/index.php?Id=89&lang=en>, (access 9/04/2017).
- McLauren, J., (2017), "The economic development of Northern Australia: a critical review of the taxation benefits and incentives both past and present and the potential taxation options for the future", paper presented at ATTA conference, 18-20 January 2017, UNSW Business School UNSW Sydney NSW 2052 Australia, available at: <https://www.business.unsw.edu.au/about/schools/taxation-business-law/australasian-tax-te>.
- MISE –ANCI-INVITALIA, (2015), Le agevolazioni di natura fiscale e contributiva in favore delle micro e piccole imprese localizzate nelle zone franche urbane. Primo rapporto, available at: [ww.mise.it](http://www.mise.it) (access 28/05/2017).
- Mises, L., (1998), Human Action: A Treatise on Economics, originally published in Auburn, A.L., Ludwig von Mises Institute.
- Moberg, L., (2013), "The political economy of special economic zones", Journal of institutional economics, Vol 11(1).
- Monaghan, P., Nort, P., Southern, P., (2016), "Ecological empowerment and Enterprise Zones: pain free transitions to sustainable production in cities or fool's gold?", Journal of cleaner production, Vol. 134, Part A, pp. 395-405.
- Oxford business group, (2013), The report- Morocco 2013, available from: <https://www.oxfordbusinessgroup.com/morocco-2013/country-profile>, (access 30/04/2017).
- Ricci, P., (2010), Il soggetto economico nell'azienda pubblica. Un'introduzione su chi comanda davvero nell'azienda pubblica e perché, RIREA.
- Ricci, P., (2015), Intervento al workshop , "Dalla Zona Franca Urbana alla nuova Imposta Unica Comunale IUC. Opportunità e minacce", Serino, 20/06/2015.
- Scrofani, L., Massimo Leone, M., (2016), "Le zone franche urbane in Francia e in Italia. L'applicazione flessibile di uno strumento di riqualificazione urbana in Sicilia", Semestrale di Studi e Ricerche di Geografia, N° 2.
- Soundarapandian M., (2012), Development of Special economic zones in India. Policies and issues, Concept publishing company, New Dheli, India.
- SRM, (2015), Outlook. Il business italiano negli Emirati Arabi, available from: <http://www.srm-med.com/business-project/>, (access 29/04/2017).
- SRM, (2016), Le relazioni economiche tra l'Italia e il Mediterraneo, 6° Rapporto annuale, Napoli.
- Svimez, (2016), Rapporto 2016 sull'economia del Mezzogiorno, Napoli.
- Tao, Y., Yuan, Y., Lee, M., (2016), "Chines special economic zones: lessons for Africa", AEB, Vol. 7, Issue 6.
- Ward, M., (2016), Enterprises zones, Brief paper, n. 5942, House of Commons Library, available at: [www.parliament.uk](http://www.parliament.uk) (access 30/04/2017).
- Wetherell, S., (2016), "Duncan Tanner Essay Prize 2015: Freedom Planned: Enterprise Zones and Urban Non-Planning in Post-War Britain", 20 Century British History, Vol. 27, Issue (2), pp. 266-289.
- Zhao, D.T., Kuo, S.H., Wang, T.C., (2016), Constructing the best supply chain process model of logistics for Free Trade Port Zone, Edited by: Shi, S.; Wu, M., Proceedings of the 2016 3rd international conference on management, education technology and sports science, Guilin, CHINA, SEP 24-25, 2016 Book Series: AEBMR-Advances in Economics Business and Management Research, Vol. 25, pp. 473-477.

## SWOT ANALYS: FROM BUSINESS ANALYSIS TO SOCIAL DIAGNOSIS

Ferreira, Maria Emília<sup>1</sup>; Candeias, Teresa<sup>2</sup>

<sup>1</sup>Department of Social Service, Universidade Lusófona do Porto, ULP, Porto, Portugal

<sup>2</sup>Department of Management, Universidade Lusófona do Porto, ULP, Porto, Portugal

### ABSTRACT

This paper aims to be a first approach to the SWOT (strengths, weaknesses, opportunities and threats) matrix, as an analysis tool for knowledge and business planning, in its application to the context of diagnosis for social intervention. It is an instrument that based on a survey of the strengths and weaknesses of an organization can approach planning with greater objectivity in order to face weaknesses and threats. In the same perspective, it can be used in other areas where planning is key of success. The hypothesis presented in this paper is that SWOT analysis in the social field can be a valid instrument in the diagnostic phase, both in an institutional and community analysis or in the study of geographical-administrative spaces, as in situations of family diagnosis

*Keywords: SWOT; Social service; strategy; social diagnosis; social intervention*

### INTRODUCTION

The text presented is a first approach to the SWOT (strengths, weaknesses, opportunities and threats) matrix, as an analysis tool for knowledge and business planning, in its application to the context of diagnosis for social intervention. It is an instrument that based on a survey of the strengths and weaknesses of an organization can approach planning with greater objectivity in order to face weaknesses and threats. In the same perspective, it can be used in other areas where planning is key of success. The hypothesis presented in this paper is that SWOT analysis in the social field can be a valid instrument in the diagnostic phase, both in an institutional and community analysis or in the study of geographical-administrative spaces, as in situations of family diagnosis. In the former there are experiences that point to the use of this practice (see municipal social diagnoses based on administrative and territorial), but it still appears timidly in the analysis of individual and / or family situations. The health area was one of the first to consider its worth in the family approach to the disease. In the social field, it is considered that, in conjunction with other techniques, the SWOT analysis can be a valuable aid in planning actions aimed at the welfare and development of the family in both economic aspects and personal development, and inter-family relations in the analysis phase of situation and diagnosis, with implications in planning and definition of strategies of action, as well as

in the more fragmented analysis of daily life in the advances and constraints of the families and subjects of the action. But it is worth submitting the SWOT analysis in the social field to the verdict of the method itself.

What strengths weaknesses opportunities and threats does the SWOT analysis present if applied to the social domain? Its strength is the ability to introduce reflection on positive elements presenting the two faces that any situation involves. However, it is the possibility of participation of the subjects in the elaboration of their own diagnosis, even from the collective point of view, which makes it a tool of extraordinary reach in the participation of the populations.

Therefore, it is not only an instrument for diagnosis and planning, but it is also part of the strategies of action in the development and empowerment of the participants. Opportunities are revealed from an operative point of view since the matrix allows an immediate reading and its exchange between different entities and technicians involved in the process. The lack of scientific rigor is often referred to as constraints or threats. This constraint can, however, be minimized or even exceeded in the technical methodological choices and instruments to be applied in its formulation, that is, in context analyzes, and in collection of data and information.

In addition, it can be minimized through the theoretical configuration that feeds them, considering that any diagnosis is captive to the theoretical and ideological options of the professional. In fact, it is the success of the theoretical and empirical dimensions that Guerra (2000) values in the perspective of social diagnosis.

## **SWOT ANALYSIS**

### *Technique or instrument - the complex differentiation*

The discussion of the instruments and techniques present and essential to the professional exercise lacks the previous discussion of the concept of instrumentality as a field of mediation in which rationality patterns and instrumental actions are processed (Guerra, 2011). Such a conception implies thinking about the theoretical-methodological dimension, ethical-political dimension and technical-operative dimension, as constituents and constitutive of social service. They are, as a whole that allow the interlocution between normative and strategic teleological parameters of professional practice, questioning why, what and how actions can be developed. We will not dwell on the first two dimensions, because according Guerra (2011), it is the instrumental dimension (technical-operative) that has greater visibility in the service of the profession, to the complexity and diversity achieved by the professional intervention as operationalization of the response to the set of demands and requisitions of society.

The discussion of the operationalization leads to the question of technique and instruments, considering the first as the set of procedures deduced from scientific knowledge, which allow apply it (Durozoi, Roussel, 2000). Faleiros (1993) considering the methodology of social work considers that the isolated technical science, theory is just a repetitive practice, isolated, technocratic. On the other hand, the instrument is what serves to perform some work or make some observation, so it is the tool that allows you to apply it in concrete situation. We base the option of this work that, without ignoring the theoretical imperatives underlying any strategic choice, is dedicated to the study to the study of the possibilities of applying this instrument to the professional intervention of the social service, both at the micro level in the intervention with individuals family nuclei And communities, or at a macro level in collective social diagnoses of wide scope.

### *SWOT Matrix*

In the field of organizations, the formulation of the strategy implies an understanding of the internal and external environment in which the organizations are inserted, as well as the definition of the future environment in which the organization wishes to be. For Porter (2008) strategy means to consciously opt for the development of a set of activities in order to obtain a certain position in the market. Thus, the strategy is to create a unique, differentiating and valuable position that results from a set of activities carried out by the organization. According to Kotler (2000) well-managed companies are aware of what is happening in their internal as well as external environment.

The strategic planning process is defined between two extremes within the organization, strengths and weaknesses, as well as the opportunities and threats to which they are prone as well as the choice of a strategy in this context (Ansoff, 2007). Thus, the development of a good strategy will depend on the knowledge of the internal and external environment of the organization and its strengths and weaknesses. Only through its analysis an assertive strategy can be outlined.

According to Thompson et al. (2008) the strategy must take into account the strengths, weaknesses and competitive capacities of the company. The SWOT analysis stems from the understanding that the development of a good strategy depends on the knowledge and understanding of the business and the internal and external environments in which the organization is inserted. Thus, the SWOT matrix, also known as the Harvard model, emerged between 1950 and 1960 and allows the analysis of the intrinsic characteristics of the organization, strengths and weaknesses, and extrinsic characteristics, opportunities and threats of the environment in which the organization is implanted. That is, the SWOT analysis collects a set of information about factors internal and external to the organization that, are related to its area of activity and have an impact on it (Pickton and Wright, 1998). The main objective of this analysis is to make the resources and competencies of the internal environment (strengths and weaknesses) in the value of the organization (Coman and Ronen, 2008) and to identify

phenomena and events in the external environment, taking advantage of those that may have Positive effect (opportunities) and mitigating those of negative effect (threats) to the organization (Johnson et al., 2008).

SWOT analysis has become a simple analytical tool given its ability to demonstrate to managers the position of the organization allowing a better analysis of the business diagnosis. In relation to the internal environment, the strengths and weaknesses of the organization must be identified. Strength represents what the organization has as a strong point to face the market, competitors, difficulties, among others, but that is as distinctive as possible to competitors. Strength is controlled by the organization and can also be used to influence the external environment. Generally, a force can be understood as an internal condition, current or potential, capable of substantially aiding the organization's performance for a long time. With regard to weakness, it corresponds to the identification of obstacles that weaken the organization's performance, and may refer to an internal question with the possibility of being reversed or attenuated, since it can be controlled by the organization. In short, a weakness can be seen as an internal condition, actual or potential, with the ability to substantially hamper organizational performance.

As far as the external environment is concerned, the environment in which the organizations are inserted, an environment that is not an organization or a group of organizations, but of all the organizations that are in the business. In this environment lies the market that undergoes mutations according to the intentions of the clients and the evolution of the society. Both threats and opportunities reach all organizations alike, but they have different impacts, which can be diametrically opposed according to the level of preparation of each. Opportunities apply equally to all organizations in the market, but those that are better prepared can benefit better and faster from them. The analytical tool then allows the organization to perceive the imminence of a change in the market and to have a high probability of obtaining advantages from it, preparing for it.

Opportunity lies outside the control of the organization and is what the external environment offers, that is, it is an external situation, current or potential, which, if used, can contribute, to a high degree and for a long time, to the achieve the objectives or to improve the performance of the organization. Regarding the threat, it is also beyond the control of the organization and can cause serious damage if it stands in the way chosen and has the potential to undermine the organization's performance if it is not removed. The threat corresponds to a current or potential situation present in the external environment, which, if not properly removed or maintained at a distance, can significantly harm the achievement of objectives or the organization's performance for a long time.

In order for the SWOT analysis to produce the desired effects it is necessary that the factors to be included in the matrix represent the reality observed in the most reliable way possible, since it is from

these that an analysis is made on the internal and external environment of the organization. The conclusions should highlight which issues are most relevant to the future development of the organization. This is a practice that requires the discipline necessary to establish a commitment to the development of a robust and fundamental strategy for the organization's performance. There are several ways and methods of applying this analysis tool. Johnson et al. (2008) propose assigning a score of +5 to -5 that aims to make the relationship between the environment and the organization's strengths and weaknesses. Johnson et al. (2008) report that positive values indicate in the case of a force that it will help the company to overcome a problem resulting from an atypical environmental change or that a weakness can be compensated for by this change. On the other hand, negative values indicate that strength is reduced, or that weakness may prevent the company from overcoming the problems associated with that change.

SWOT analysis being performed correctly can be a powerful catalyst for the planning process, but if done incorrectly it will be a great waste of time for the company as well as other important resources (Ferrel and Hartline, 2005). However, SWOT analysis and its application also present problems and disadvantages, including lack of objectivity, dispersion propensity and lack of precision in the classification of strengths, weaknesses, opportunities and threats. In addition, the SWOT analysis also has the propensity to be too direct, and there is sometimes no consistent result in terms of explanatory content (Johnson et al., 2008). Another limitation arises from the difficulty in creating and implementing the concrete measures resulting from the analysis, as well as the inexistence of cause and effect relationship between the variables of analysis, making this model with few evaluation methods in the changes introduced in the medium and long term, either Strengths and weaknesses (Coman and Ronen, 2008).

In conclusion, the SWOT analysis is a tool for strategic decision making, which presents several alternatives and solutions for decision making, as well as detailed diagnoses on factors related to the operational activity, being used based on the resources available in the attempt to maximize, empower and reap the greatest competitive advantage (Hamidi and Delbahari, 2011).

## **THINKING ABOUT DIAGNOSIS IN SOCIAL INTERVENTION**

The centrality of social diagnosis and the reference to its global character was expressed from the beginning of the profession. Considered by one of the founders of the profession as accurate as possible knowledge of the social situation and personality of a certain needy (Richmond, 1917, 1950), social diagnosis is the concern of assessing social realities aiming at them to intervene is their objective.

This requires knowledge of all the elements that, although may seem insignificant or dispensable, looking at themselves, can, when taken together, shed light on the case, in particular, with respect to

social work, satisfying the question of how to proceed to place a needy person in his or her rightful position in society (Richmond, 1917, 1950). It is this perspective also found by Vaisbich (1978) in the systematization of the thinking of several authors on the social diagnosis. Thus, Hamilton (1940) defines diagnosis as thought directed to the nature of the problem and its causes. Holis (1965) states that in the diagnosis the technician seek to assess the client's ability to use the various types of treatment in Social Work Case to overcome their difficulty (Vaisbich, 1978). On the other hand Greenwood (1955) points out the urgency of establishing diagnostic typologies that allow that, based on certain factors observed in the problem situation, it is correctly placed within an already established typology.

Despite the attempt of a certain standardization, Greenwood points out the need to consider the unique character, or in what differs from others of its type (Vaisbich, 1978). The weight of some of the concepts used by the authors referenced, little cited in current time, shows its wear and tear on the evolution that the social service profession has set in motion from its origin to nowadays. However, the approach to diagnosis is constant and significant as something that requires the knowledge of the situation in question considering causes and effects that leads to an action directed to the problem and the characteristics of the subjects. The dynamic character of social diagnosis, by the dynamic force of reality, is already visible in the origins and remains to this day. According to Richmond, there is no doubt that a diagnosis can and should be reviewed at all times (Richmond, 1917, 1950) and Helen Perlman (1965) considers that the social worker needs to know the dynamic and multifaceted nature of the problem presented by the customer. In a very pragmatic way, it is essential to identify the various types of problem that exist within the same situation, so that the social worker's action is planned and not only based on mere impulses and attempts, gathering, analyzing and organizing all the facts concerning the person, the problem and the situation (Vaisbich, 1978). More recently, Idáñez and Ander-Egg (1995) also address the dynamic nature of diagnosis that must be open to incorporate new data and information, new adjustments derived from new relationships and interdependencies that are established from available data or from new data that are being obtained. As a new category, Faleiros (1993) shows the complexity of the process and its political dimension, referring that what is called diagnosis is not an isolated task of pure data collection, but of elaboration and placement of strategies for a change in the relation of forces facing the problem. In conclusion, Guerra (2000) sums up more modern thinking by stating that what is at stake, when we speak of diagnosis, is the scientific knowledge of social phenomena, is the ability to define interventions that reach the causes of phenomena and not their apparent expressions. Referring to the diagnosis in its more comprehensive version of the analysis of wider territorial contexts, the author says that a good diagnosis ensures the adequacy of responses to local needs and is fundamental to guarantee the effectiveness of any



intervention project (Guerra, 2000). Synthesizing, in all cases of individual diagnosis, collective family in general, this presupposes the interaction between needs / vulnerabilities and potential / resources, opportunities and threats. Thus, the SWOT matrix, whose usefulness we intend to refer to in this article, appears in this author.

#### *The diagnosis in Social Work*

The intervention's fundamental phase varies according to different authors. For example Ader-Egg (1995) considers in the diagnosis:

- The nature of the problem or need - analyze the different dimensions to answer the question - What is it? What is the problem?
- The magnitude of the problem or need - degree or extent of the problem, persons affected, frequency and distribution.
- The seriousness of the problem or necessity - the danger of them.

Guerra (2000) states that since diagnosis are the first step in planning the intervention, it includes three operations that may be of different intensity: pre-diagnosis, diagnosis and prioritization. Pre-diagnosis is the first contact with the situation and / or subjects involved. De Robertis and Pascal (2007) systematize the diagnosis in three initial moments of the intervention as follows:

- 1) Placement of the problem or demand, starting point of any diagnosis to answer the question of what is and by what route reaches the professional?
- 2) Analysis of the situation is the moment of collection and systematization of the information regarding the elements necessary to understand the problem. It involves equating social relations in that context; the knowledge of the medium institutions services and other alternatives directed to the problem; and the identification of public policies (social and other) that may come into play in addressing the issues identified.
- 3) Preliminary and operative or diagnostic evaluation. The first can be born immediately when the problem is set, or require a longer time of exploitation, arising in the sequence and development of the situation analysis. The operative or diagnostic evaluation is the most advanced result and is already aimed at defining the intervention project, setting priorities and other context variables. Based on the interpretation of Guerra and De Robertis, a non-contradictory but rather complementary perspective, it is argued that it is in these phases that the use of the SWOT matrix will be useful as a way of systematizing the varied information and data collected and its analysis in a reflective perspective with theoretical foundation.

## THE SWOT MATRIX AS SYSTEMATIZATION AND CENTRAL AXIS OF MICRO ANALYZES OF SOCIAL INTERVENTION

Taking the family reality as the basis of the exercise, the SWOT matrix can work in similar ways to those applied in business and / or institutional analyzes. In this process, therefore, it is essential not only to introduce the daily life of the nuclear family, such as the close context of the extended family, the work of society and the state, which can represent weaknesses, strengths, threats or opportunities. The state of relations between family members may be the support in adversity, as it may set a new threat.

The fact that the family establishes bridges with the surrounding environment, that is, being more open or closed to the outside, can mean more or less opportunities for social and institutional relations work. But also the outside environment can pose potential threats or opportunities. In social intervention the main objective of the SWOT matrix is to lead the technician / researcher to discover the positive side of the situation and the subjects involved, without neglecting the potentially perverse effects for a prevention or correction perspective.

But as we said earlier, when referring to virtues, in a process of social intervention the SWOT analysis can become not only an instrument of analysis but also itself, in its dynamics, a factor of transformation and awareness and therefore extremely efficient to achieve strategic objectives. Particularly in collective processes, Montero (2004) considers that participatory diagnosis is an organized, collective, free and inclusive process, where there are several actors, activities and levels of commitment, which is guided by shared values and objectives, whose implementation allows Collective and individual transformations. Although very wide, also in the individual or family diagnosis, such dynamics can happen and constitute a process of awareness, which enables it to enter into the historical process as a subject, avoiding fanaticism and inscribes it in the search for its affirmation (Freire, 1987). However, the main objective is undoubtedly the possibility of considering as forces the existing variables that represent the positive aspects that can come either from the image, from the competence or the lived experiences, or from the ambition, namely:

- Personal social and professional skills developed throughout life, both in terms of training and experience
- Existence of cohesive family group
- The own resources (economic of personal and familiar relations and others)
- Motivation and ambitions
- The age factor
- Health (the good state)

- The good image
- Education and / or vocational training
- Insertion into belonging groups

The verification of these conditions, in whole or in part, will allow the foundations of anchoring of new projects or the recovery of others, with the certainty that the best positioned will be important in the decisions and choices that have to be made.

With regard to weaknesses, some are the antonym of forces, but when well considered and assumed by the self, they can be reversed in the intervention process. It is necessary to identify the one that is easier and immediate to solve, for example to improve the visual aspect (positive stimulus are also important in the intervention), as well as the one that proves to be a determinant of all others, but that reveals to be a more time-consuming solution (Academic qualification or vocational training). Examples are:

- Sickness or existence of some type of disability
- Shyness and other personality traits that prove to be hindering positive socialization
- Low education level
- Low self-esteem, lack of interest and lack of investment in oneself
- Existence of violent environments, both individual and in broader spaces
- Carelessness in personal image

Opportunities are external forces that can influence positively, may be narrow or broader. For instance:

- Reopening of a relationship in a situation of rupture
- An unexpected placement or possibility of entrepreneurship
- The assignment of a house, new or more adequate to the needs of the family
- Inclusion in a support group
- The existence of services that guarantee needs (health, education, cultural, etc.)
- Proximity to other groups and services
- Good relationship with services
- The announcement of new measures of social policies that promote future benefits

Threats are external forces capable of overturning or hindering good intentions and positive conditions. They may be national, regional or local. They correspond, at the outset, to the negative direction of the opportunities, but may have other compositions such as:

- Social and/or political instability
- Changes in social policies
- Lack of services of support and/or social responses

These should be identified and monitored during the intervention in order to minimize the risks and hazards affecting the subjects.

#### *How to formulate SWOT analysis*

The first step is to use other techniques and / or instruments with different functions to obtain information and / or collect data: questionnaires, interview or focus group, reports, home visits, consultation of official and / or credible statistics. These are important elements in view of the more individual or collective dimension in which the intervention will take place. It will be useful to technically master the tree of problems and objectives and the analysis of social networks (Fialho et al., 2015). At this stage of the process it is also appropriate to use the genogram and the ecomap to better clarify and visualize the relations between the family elements and the exterior. In a second phase it is necessary to choose one of several models available for SWOT analysis and start to fill the fields not randomly but according to intentionalities. Fialho et al. (2015) advise for social intervention the priority filling in weaknesses or weaknesses. Considering the centrality of the problem in a social intervention, this is the more pragmatic perspective, but we must not forget that the forces that are the starting point for intervention.

## **CONCLUSION**

In the process of analysis and synthesis, it is essential to be able to read the reality and the interpretation of the phenomena in question and the relations between them, either on the part of the responsible technician or the team in the case of a more comprehensive diagnosis.

Because of its origins in management and business planning, the SWOT analysis seems to be more focused in the social field for the domain of entities and organizations that provide services and social responses to a given population, but it has proved to be appropriate in the social study of geographic-administrative spaces.

The present proposal puts the SWOT analysis in the axis of individual and / or community diagnoses, where, due to its characteristics and requirements of procedures, it can prove to be an important instrument for planning and action. It is essentially based on the daily experience of professionals, rather than on the study of the rules and results of their application, they justify bringing it to the fore.

## REFERENCES

- Abts, K., and Rummens, S. (2007), "Populism versus democracy", *Political Studies*, 55(2), 405-424.
- Gilpin, R. (2016), *The political economy of international relations*, Princeton University Press.
- Ander-Egg, Ezequiel (1995), *Introdução ao trabalho social*, Petrópolis, Vozes.
- Ansoff, Henry (2007), *Strategic management*. Springer.
- Coman, A. and Ronen, B. (2008), "Focused SWOT: Diagnosing Critical Strengths and Weaknesses", *International Journal of Production Research*, 47 (20), 5677-5689.
- De Robertis, C., & Pascal, H. (2007), *La intervención colectiva en trabajo social: la acción con grupos y comunidades*, Lumen-Hvmanitas.
- Durozoi, Roussel; G. A. (2000), *Dicionário de Filosofia*, Porto: Porto Editora.
- Faleiros, Vicente Paula (1993), *Metodologia e Ideologia do Trabalho Social*, São Paulo, Cortez.
- Ferrel, O.C and Hartline, M.D. (2005), *Estratégia de marketing*, São Paulo: Cengage Learning.
- Fialho, Silva, Saragoça; Joaquim, Carlos, José (2015), *Diagnóstico Social, Teoria, Metodologia e Casos Práticos*, Lisboa, Sílabo.
- Freire, Paulo (1987), *Pedagogia do Oprimido*, São Paulo, Paz e Terra.
- Greenwood, E. (1955), "Social science and social work: A theory of their relationship", *Social Service Review*, 29(1), 20-33.
- Guerra, Isabel (2000), *Fundamentos e processos de uma sociologia de acção*, Cascais, Principia.
- Guerra, Yolanda (2011), *A Instrumentalidade do Serviço Social*, São Paulo, Cortez.
- Hamidi, K. and Delbahari, V. (2011), "Formulating a Strategy for a University Using SWOT Technique: A Case Study", *Australian Journal of Basic and Applied Sciences*, 5 (12), 264-276.
- Hamilton, G. (1940), *Theory and practice of social casework*, New York: Columbia University Press.
- Perlman, H. H. (1965), "Self-determination: reality or illusion?", *Social Service Review*, 39(4), 410-421.
- Hollis, J. H. (1965), "The effects of social and nonsocial stimuli on the behavior of profoundly retarded children: I", *American Journal of Mental Deficiency*.
- Idáñez, Ander-Egg, María José, Ezequiel (1995), *Diagnóstico social, conceptos y metodologia*, Buenos Aires, Lumen.
- Johnson, G., Scholes, K. and Whittington, R. (2008), *Exploring Corporate Strategy*, 8th edition, England, Pearson Education Limited.
- Kotler, Philip (2000), *Administração de marketing*, São Paulo: Prentice Hall.
- Montero, Maritza (2004), *Introducción a la Psicología Comunitaria, Desarrollo, conceptos y procesos*, Buenos Aires, Paidós.
- Pickton, D. W. and Wright, S. (1998), "What's Swot in Strategic Analysis", *Strategic Change*, 7 (2), 101-109.
- Porter, M. (2008), *On Competition, Updated and Expanded Edition*, Boston, Harvard Business Press.
- Richmond, M. (1917), *Social diagnosis*, New York: Sage.
- Richmond, M. (1950), *Diagnóstico social*, Lisboa: Instituto Superior de Higiene Dr. Ricardo jorge.
- Thompson Jr, A. A., Strickland II, A. J., and Gamble, J. E. (2008), *Administração estratégica*, AMGH Editora.
- Vaisbich, Stella B. (1978), *Serviço Social, Tipologia de Diagnóstico, Subsídios*, São Paulo, Cortez & Moraes.

# RESTORING LEGITIMACY IN THE AFTERMATH OF CORPORATE SCANDALS: A MULTIPLE CASE-STUDY ANALYSIS ON CSR INITIATIVES

Florio, Cristina; Sproviero, Alice F.

Department of Business Administration, University of Verona, Verona, Italy

## ABSTRACT

Corporate scandals undermine integrity and reputation, in that generating a legitimacy gap. Through a multiple-case study analysis, this paper provides qualitative evidence on the CSR initiatives undertaken by Multinational Enterprises (MNEs) in response to CSR-related scandals, in order to restore their legitimacy to operate. We consider four scandals in the apparel industry that “hit the headlines”, namely Walmart, Moncler, Nike, and H&M. We classify CSR initiatives according to the dimensions of corporate behaviour framed by Sethi (1975) and interpret them through the lens of the legitimacy theory. Our findings show that all MNEs undertook several CSR initiatives, primarily acting on ethical norms, operating strategies and social accountability. They tended to issue or revise code of conducts, develop new relational approaches with the suppliers, and publish the CSR report, while neglected or made limited reference to the external assurance of CSR reports. Some MNEs also accepted investigations by Non-Governmental Organizations (NGOs) on their initiatives. Besides such common behaviours, some differences arise, especially with respect to the MNEs attitude towards the refusal or admission of their responsibility in the scandals. Our study confirms previous arguments suggested by CSR literature by providing evidence that MNEs shape both the internal and external environment to make it more favourable to ethical behaviours, and rely on social and environmental accountability to pursue legitimacy, even in a peculiar situation like a corporate scandal. The study contributes to the scant but growing literature on CSR in the aftermath of corporate scandals.

*Keywords: Corporate Social Responsibility (CSR), corporate scandals, CSR initiatives, ethical norms, CSR report, assurance, multiple case-study, apparel industry.*

## INTRODUCTION AND RESEARCH OBJECTIVES

Corporate Social Responsibility (CSR) as the integration of social and environmental concerns in business operations as well as in the interactions with stakeholders on a voluntary basis (CEC, 2001)

has gained increasing importance in the economy and the society. This matter of fact concerns especially Multinational Enterprises (MNEs), as business entities which conduct business operations in various countries through their subsidiaries and affiliates (OECD, 2011). Indeed, MNEs are constantly overseen and evaluated by shareholder, consumers, suppliers, governments, Non-Governmental Organization (NGOs) and other stakeholders (Andersen and Skojett-Larsen, 2009). Ultimately, stakeholders legitimise companies to operate, eventually assuring economic survival to the most sustainable, correct and transparent ones (Adams, 2004; Deegan, 2002). As legitimating strategies, CSR initiatives undertaken by MNEs may be pursued by assuming a defensive, reactive or proactive attitude. Such attitudes shape the corporate behaviour toward different dimensions, such as ethical norms, operating strategy, and social accountability (Sethi, 1975).

The occurrence of a corporate scandal, i.e. any situation (legal dispute, accident, or an ethical scandal that could be attributed to a company) that mines the integrity or reputation of a company (Sims, 2009), generates a legitimacy gap. Corporate scandals are usually brought on by adverse or negative media attention, generate public scrutiny of organizational, managerial and communication practices, invoke discourses about systemic change, and problematize firms' legitimacy (Kuhn, 2003). In such situations, MNEs need to restore their credibility as economic players and may activate new CSR initiatives to recover their legitimization to operate. Corporate scandals may therefore stimulate reactive CSR policies and renew the company approach towards one or more dimensions of behaviour.

Consistently with such premise, this paper provides qualitative evidence on the CSR initiatives undertaken by MNEs belonging to the apparel industry in response to corporate scandals that "hit the headlines", like those of Walmart, Moncler, Nike, and H&M. More specifically, we investigate whether the selected MNEs enhanced their CSR after the scandal and which specific dimensions of behaviour they strengthened. The study is grounded on the legitimacy theory (Deegan, 2002) and makes reference to the framework by Sethi (1975) to define the dimensions of behaviour. Through a multiple-case analysis, it aims at contributing to the scant but growing literature on CSR in the aftermath of corporate scandals (Fombrun and Foss, 2004; Sims, 2009; Lungu *et al.*, 2009).

The paper is structured as follows: next paragraph offers a theoretical background about CSR initiatives and their legitimization power, especially following corporate scandals. The further paragraphs present the research design and discuss the findings from the case-studies analysed. Finally, main findings are discussed under the lens of the legitimacy theory and some concluding remarks are drawn.

## THEORETICAL BACKGROUND

### *Legitimization power of CSR*

Enhancing CSR strategies has become an unavoidable and undeniable part of MNEs activity, being those strategies highly required and evaluated by the stakeholders which, ultimately, have the power to legitimize company survival (Sethi, 1975). According to the *legitimacy theory*, there is an “unspoken social agreement” between the society at large and the firm that legitimise the latter to operate. Several business case arguments for CSR practices are presented in the literature. They are linked to the benefits arising from the improved ability of the company to attract consumers, investors and employees. Cause marketing, corporate philanthropy, and disclose of information are some reported examples of CSR activities aimed to enhance corporate legitimacy and reputation (Carroll and Shabana, 2010).

Companies’ attitude toward legitimization, and CSR is no exception, may be defensive, reactive or proactive (Sethi, 1975). van Staden and Hooks (2007) underline that many studies on corporate environment reporting find evidence of the reactive approach, meaning that companies publish environmental information in reaction to some event or crisis facing either the company or the industry. According to Sethi (1975, p. 60), “*legitimization involves not only the type of corporate activities, but also the process of internal decision making; the perception of external environment; the manipulation of external environment—physical, social, and political—to make it more receptive to corporate activities; and the nature of accountability to other social institutions in the system*”. In the search of legitimization, companies may therefore act on the side of ethical norms, operating strategy, social accountability, reduction of social and governmental pressures, and philanthropy (*dimensions of behaviour* according to Sethi, 1975). This study aims at investigating the corporate behaviour to retrieve legitimacy in response to a situation of corporate scandal. The focus will be on different CSR initiatives pertaining to the dimensions of behaviour above listed.

### *CSR initiatives: an overview*

Despite its increasing relevance, CSR maintain a voluntary nature. Each MNE may therefore freely shape CSR strategies accordingly to the needs and expectations of its stakeholders, while managing the specific social and environmental risks implicit in its core business (Bartlett and Ghoshal, 1989). CSR initiatives are therefore differentiated in their nature and scope. We briefly summarize below some relevant initiatives for our study.

Lungu *et al.* (2009) underline that MNEs are involved in complex business-integrity issues and shall respond to multiple requests from shareholders and other stakeholders in different markets with different regulations and governance systems. Mackenzie (2007) emphasises the role of boards of directors in ensuring that companies maintain/improve their reputation for high standards of business



conduct and attention to the impact of business operations on the community and the environment. He shows that in large UK companies boards define policies and standards, monitor compliance with them, and create *ad-hoc* committees which review CSR issues and reporting, identify non-financial risks, monitor risk management, and oversee philanthropic activity. Referring to the apparel industry and the “sweatshop” concerns along the supply chain, Emmelhainz and Adams (1999) underline the need to develop specific standards of employee welfare to which suppliers must adhere (i.e. code of conduct). Moreover, they suggest that supplier compliance with standards be monitored, e.g. through on-site visits and plant inspections, and call for enforcement policies to secure effective responses in cases suppliers violate the code of conduct.

Kolk (2008) stresses the role of CSR reporting in reducing information asymmetry between economic actors and their stakeholders, as well as in adding credibility and reliability to the social and environmental initiatives undertaken. According to CorporateRegister (2013), honesty and transparency in communicating the social and environmental impact of business operations, including sharing bad news and detailed data, help building a solid reputation as responsible firm and generate a series of benefits closely related to the firm image, such as attract investors and workforce, obtain consumers’ loyalty and influences their consumption decisions. Clarkson *et al.* (2015) argue that companies that are more responsible and upstanding have greater interest in disclosing and communicating their strategies and results to the public.

Finally, external assurance on CSR reports is recognized as a mean to strengthen their reliability and increase confidence that the communication strategies are transparent. Peters and Romi (2013) and Alon and Vidovic (2015) maintain that, through external assurance of CSR reports, companies with upstanding CSR initiatives and a valid internal CSR department aim at gaining better reliability and strengthen their reputation of responsible enterprises. Among others, Manetti and Becatti (2008) argue that the main benefit of external assurance is to strengthen the positive effect of CSR reporting and filling the *credibility gap* between the firm and its stakeholders, by reducing the information asymmetry and agency costs. In such regard, Perego and Kolk (2012) suggest that stakeholders tend to award responsible firms with higher trust, as long as the assurance is provided by professional and independent assurers. Finally, Cho *et al.* (2010) and Clarkson *et al.* (2015) suggest that investors may be willing to pay a premium for the companies obtaining external assurance, especially when the latter relies on precise sustainability indicators or when remuneration policies are linked to CSR performance.

#### *CSR and corporate scandals*

In the aftermath of the well-known corporate scandals of early 2000s (e.g. Enron, Arthur Andersen, Worldcom), Fombrun and Foss (2004) find three principal responses that emerged from boardroom

discussions to corporate ethics questions: the infusion of ethical principles and values into corporate cultures, the appointment of chief ethics officers, and the adoption of stricter ethical guidelines and codes of conduct. The authors show that big companies increasingly base ethics initiatives on a values-based approach, so that the stated principles may be readily applied and shared with suppliers and other stakeholders. The importance of improved compliance procedures and board oversight is also underlined.

Sims (2009) explores the issue of rebuilding corporate reputation following ethical scandals and maintain that, if managed properly, the damage to the organization's reputation can be minimized, without leading to sustained reductions in market capitalization and earnings. This view portrays media as a social-control agent, whose role gains relevance in the social construction of wrongdoing in case of a scandal (Clemente and Gabbioneta, 2017). Indeed, the corporate scandal *per se* is defined as a highly mediated event that causes public disapproval (Thompson, 2000), is originated from a challenge to existing norms and needs a remedy (Entman, 2012). With respect to the latter point, van Wensen *et al.* (2011, p. 72) argue that a suitable corporate reporting is a crucial element to obtain "*a social 'license to operate' and the mitigation of criticism from external stakeholders and NGOs*". Moreover, they regard the scandals in accounting, environmental performance and human rights as one possible motivation at the basis of the increase in ethical considerations (*reactive attitude*), which produce a strong impact on the image of businesses among the stakeholders. Consistently, Arvidsson (2010, p. 340) argues that corporate scandals provide "*a perfect hot-bed for CSR*", regarded by managers "*as a means to decrease mistrust and restore stakeholders' confident in management teams*". Her findings suggest that the increase in CSR communication started as a reactive approach to the corporate scandals aimed at restoring the stakeholders' damaged confidence and trust.

As emerging from the above review, existing literature on CSR in the aftermath of corporate scandals is mainly focus on CSR reporting, while other initiatives are almost neglected. Our study contributes to the understanding of a broader range of CSR initiatives through the research design described below.

Dimensions of behavior	Multinational Enterprises			
	Walmart Stores	Moncler	Nike	H&M

Dimensions of		Multinational Enterprises		
Scandal (year/period)	Mistreatment of child labor in Bangladesh (2005)	Illegal and violent plucking methods (2014)	Mistreatment of labor (1990-2001)	Mistreatment of labor and lack of security in production facilities (2007-2013)
Ethical norms (year)		Creation of a Sustainability Unit (2015) Appointment of a Control, Risk and Sustainability Committee (2015)	Supplier Code of Conduct Fair Labour Association (2005)	Code of Conduct for Suppliers (2012) Clean Clothes Campaign (2013) Commitment to "provide for fashion conscious customers" and "be ethical" (2013) Roadmap to a Fair Living Wage (2013)
Operating strategy (year)	Broken up of commercial relations with Bangladesh vendors After investigations on site, no more trading with 141 suppliers Definition of sustainability objectives Support investments in innovation, technology and CSR	DIST protocol for supplier certification (2016) External audit on suppliers (2016)	New relational approach with suppliers Wide range of monitoring activities Collaborations with NGOs, specialized agencies, stakeholder groups Attention to the environmental impact of the products	Incentives for the most responsible suppliers (2012) Conscious Collection (2013) Agreement on workplace safety in Bangladesh (2013)
Social accountability for corporate actions (year)	Report on Ethical Sourcing (since 2006) CSR reports according to GRI standards	Sustainability Report (since 2015) CSR reports according to GRI standards External limited assurance on CSR reports (since 2015)	List of suppliers and audit results published (since 2005) Preliminary CSR report (2000-2001) CSR report according to GRI and UN Global Compact standards (since 2004)	Sustainability Report (since 2002) List of suppliers published (2012) SR reports according to GRI standards External limited assurance on CSR reports (since 2012, gradually expanding) Reports on the state of progress about Bangladesh Accord (2015)
Philanthropy (year)			Donation to the Fair Labor Association (2003)	H&M Foundation (2013)
Other CSR activities (year)	Walmart Sustainability Index (since 2009), in cooperation with NGOs		Active campaigns to increase minimum wage, improve hygiene and safety of plants	Accepted NGO evaluation on the progress of the Bangladesh agreement (2015)

Table 1, CSR initiatives to restore legitimacy in the aftermath of corporate scandals

## RESEARCH DESIGN

With the aim of providing qualitative evidence on the CSR initiatives undertaken by MNEs in response to corporate scandals we adopt a multiple case-study approach. The focus on MNEs is motivated by the fact that they are socially more observable and more exposed to public scrutiny (Arvidsson, 2010), therefore they may experience greater pressure to act—and react—in a desirable way after a scandal. We select four MNEs operating in the apparel sector which were involved in scandals of social and/or environmental impact in the last two decades. In the selection process, we consider both the media attention to the scandal and the relevance of its damage in reputational terms by referring to press articles and television reportages. As a result, the MNEs under analysis are Walmart, Moncler, Nike, and H&M.

Relying on secondary sources like corporate websites, newspapers and news releases, annual and CSR reports we identify the CSR initiatives developed by MNEs in order to restore their legitimacy. As a framework of reference, we classify CSR initiatives according to the dimensions of behaviour described by Sethi (1975), slightly revised as listed in Table 1. To interpret our findings, we adopt the legitimacy theory argument, according to which a company achieves legitimacy by operating within the norms and expectations of the society (the so called “social contract”). Legitimacy theory allows to motivate how companies behave and engage in voluntary activities in order to achieve (or restore, in case of scandal) legitimacy (van Staden and Hooks, 2007).

## FINDINGS

In this section, we briefly describe each scandal and the CSR initiatives developed by each MNE as a reaction to the scandal itself. Table 1 provides a summary of the findings, by classifying CSR-related initiatives according to the dimensions of behaviour framed by Sethi (1975), properly adjusted to our purpose.

### *Walmart and child labor*

Walmart Stores Inc. was established in the US in 1962 and exponentially grew till becoming the largest supermarkets chain in the world, even in 2016. In 2005, Walmart was accused of child mistreatment in two factories in Bangladesh where children earned wages for less than 50 dollars per month. After the news release, under the pressure of NGOs, workers and consumers’ protests, Walmart began a deep renewal in terms of business sustainability. In accordance to existing business policies, Walmart broke up commercial relations with Bangladesh vendors responsible for the mistreatment. In 2006, the company issued the first CSR document (called Report on Ethical Sourcing) with reference to the year of the scandal. In the report, Walmart claimed it ceased trading with 141 suppliers as they employed

child labor and listed in detail the results of the audits carried out directly on the suppliers' sites, the kind of violation and the geographical area where it was found. In addition, the company renewed its commitment to implement further monitoring and verification measures for its suppliers. Walmart develop operating strategies aimed at increasing the use of renewable resources and minimizing production and packaging waste. Huge investments in innovation, technology and CSR are declared. In 2009, in collaboration with the NGO The Sustainability Consortium, Walmart launched the Walmart Sustainability Index that helps retailers and suppliers to improve products quality and sustainability, integrate sustainability into the business of buying and selling merchandise and the whole supply chain, and reduce costs. Walmart prepares CSR reports according to the Global Reporting Initiative (GRI) guidelines, but it does not submit them to external assurance. Walmart transparency and social responsibility is appreciated by US consumers, who, in 2016, have chosen it as the most reliable mass merchandiser retail store (Business Wire, 2016).

#### *Moncler and the plumage*

Founded in France in 1952 and established in Italy in 1992, Moncler S.p.A. is a luxury brand specialised in the winter clothing production. On November 2, 2014, the Italian TV program Report aired a special investigation on some of Moncler plumage suppliers in Hungary and Moldova, blaming them to implement procedures not compliant with the European legislation. In particular, the program showed how plucking was done live (illegal practice) and through methods that cause animals injuring. Moncler was therefore accused of using poor quality and low price plumage, obtained through brutal methods, and not labelling the supply chain, as other brands already did. Immediately, the company denied any involvement, stating that all feathers used by the company came from suppliers contractually obligated to ensure compliance with the principles of animal protection, as reported by the Moncler Code of Ethics. Meanwhile, the press and animalist associations (including the Italian Antivivisectionist League) condemned Moncler, also supporting their allegations with the fact that the Italian apparel company did not release a CSR report. A few months after the scandal, Moncler's general manager and two board members resigned. However, the company denied any link between this change and the scandal. In 2015 Moncler created a Sustainability Unit and appointed the Control, Risk and Sustainability Committee. As for the operating strategies, the company established a Down Integrity System and Traceability (DIST) protocol for supplier certification, to be completed by 2016. Moncler also relies on external audits for about a quarter of its suppliers. Moncler reaffirms its responsibility for the information contained in the labels of its products and its commitment to pay careful attention to the origin of fur and plumage. However, up to date the reference to the geographic location of its suppliers remains vague and

identified only at the continent level. In 2015, the MNE released its first CSR report, of which several pages are dedicated to the feather production line and the standards it must adhere to. Curiously, the scandal is even not mentioned. Since the beginning, Moncler submits its sustainability report to external assurance, although in a limited form.

#### *Nike and the "sweatshops"*

Nike Inc. was founded in 1962 in the US and owns one of the best-known sport brands in the world. Since the 1990s several "sweatshop" charges were imputed to Nike, especially in Asian countries. Among them: in 1992, the denounce of miserable wages paid to Indonesian workers; in 1996, child mistreatment in Pakistan for the production of balls and very low workers' wages in China, Vietnam and Indonesia; in 1997, abuses of women workers in Vietnam; in 2001, punishments and mass layoffs of Mexican workers who were protesting for unacceptable working conditions. In August 1998, the CEO called a press conference to present the initiatives aimed at addressing the exploitation of labour in Asian countries, also through collaborations with NGOs for educational and humanitarian issues, and at implementing new and more reliable ways of monitoring and inspection within supplier factories. Again, three years later the human rights NGO Global Exchange published a report titled *"Still waiting for Nike to do it"*, denouncing the inertia and false promises by top management. Eventually, Nike began developing a new approach to its productive chain, by reinforcing the Supplier Code of Conduct and cultivating new relationships with its suppliers, based on mutual collaboration, open communication and joint problem solving. It established a wide range of monitoring forms of its socio-environmental impact, including collaborations with NGOs and specialized agencies, dialog with stakeholder groups, and assignments to external auditors. CSR initiatives in the field of operations were active campaigns to increase the minimum wage in the host countries, improve the hygiene and safety of its plants, and increase the quality and sustainability of its products paying attention to the environmental impact. In terms of accountability, Nike began to openly and transparently report the issues it faced, especially with reference to its suppliers. Since 2005 it publishes a report containing a list of all suppliers, inclusive of registered conditions (including abuses, poor hygiene and security systems, and remuneration policies) and the results of the on-site controls carried out. The company realised the first two CSR reports in 2000 and 2001, then stopped for some years. Only since 2004 CSR reports are issued on an annual basis, provide extended explanations of the reported data (even when negative), and are drafted according to GRI guidelines and the principles of the UN Global Compact. Nike does not submit its report to a comprehensive external assurance, but the management seem willing to obtain external assurance in the next years. Finally, in 2003 Nike donated \$ 1.5 million to the Fair Labor Association (FLA), an active group in

controlling production processes and protecting human rights, which is composed by NGOs, universities and other stakeholder groups.

*H&M, child labor and factory security*

Hennes & Mauritz AB, known as H&M, was founded in 1947 in Sweden and is one of the largest clothing multinationals, borne under the idea to produce fashion at affordable prices. This strategy is the engine of H&M success, but it has caused the MNE involvement in numerous scandals related to the use of low-cost labour in the Asian regions. Among the numerous allegations addressed to H&M, the followings had the greatest media coverage: in 2007, the company was accused of collaborating with a cotton producer in Uzbekistan exploiting child labour in plantations; in 2011, in a Cambodian factory producing for H&M around 300 workers fainted in the workplace, in a week, due to chemical fumes, poor sanitation and malnutrition; in 2013 a couple of factories collapsed in Cambodia and Bangladesh, with more than 1,000 victims (BBC News, 2013); again in Bangladesh, over the past decade inhumane working conditions, low wages, and the lack of security in production plants were reported. H&M seems to invest in CSR initiatives in response to this series of scandals. In 2012 H&M developed a Code of Conduct for suppliers. The following year was a turning point, since the company took a number of strategic initiatives in social and environmental issues, including “*provide for fashion conscious customers*” and “*be ethical*” among the major corporate commitments. In the same year it also published its *Roadmap to a Fair Living Wage* on the efforts of the *Clean Clothes Campaign*, a global alliance dedicated to improving working conditions and empowering workers in the global garment and sportswear industries. In 2012 H&M introduced incentive measures for the most responsible suppliers and H&M launched its *Conscious Collection* within a heavy ethical and eco-sustainable campaign to offer high-end environmentally friendly pieces, with the aim of obtaining all cotton from sustainable sources by 2020. In May 2013, the company signed an agreement on the risks of fire and health in Bangladesh, promising to perform renewals in order to secure the H&M apparel manufacturing factories. Another declared commitment is to implement initiatives to achieve minimum wages by 2018, however to date no agreements or negotiations have been promoted with host countries. As for social accountability of corporate actions, H&M publishes the list of suppliers on its website since 2012. The company published its first Sustainability Report in 2002, i.e. before the occurrence of the scandals. Looking to the reports realised since 2012, positive and praiseworthy tones are adopted, although not supported by equally positive data. Explicit references to the scandals about working conditions in the textile production are almost absent. Since 2012, H&M submit its CSR reports to external, limited assurance. While in 2012 the indicators under external control were limited to the supply chains, materials used, and energy consumption, the scope of control has gradually

expanded afterwards, including assurance on materiality, stakeholder engagement, emissions, the use of renewable energies, the reuse and recycling of materials, and, ultimately, the risks of fraud or corruption. Overall, CSR initiatives undertaken by H&M were highly appreciated and the latter is now included in the Dow Jones Sustainability Index and the FTSE4Good Index. CSR report of 2013 was ranked first in the section "Openness and Honesty" of the CR Reporting Awards assigned by Corporate Register, a global online directory of corporate responsibility. Finally, following the agreement on workplace safety in Bangladesh, H&M has allowed some NGOs to evaluate the state of progress of the project and to issue specific reports on the point. In September 2015 and January 2016, the reports underlying the company being in lag. Also, the *Clean Clothes Campaign* initiative acknowledged that some steps have been taken, but require more effort. In 2013 H&M gave rise to a philanthropic initiative through the creation of the H&M Foundation.

## DISCUSSION AND CONCLUSIONS

The findings about the four case-studies highlight that, to restore legitimacy after the scandals they incurred into, all MNEs undertake CSR initiatives by acting on multiple dimensions of behaviour at the same time or in a short time period. Some similarities and recurring tendencies may be underlined with reference to specific initiatives.

Most MNEs tried to regulate better the relationships and the behaviour of their suppliers, which were often the real protagonists of the scandal. Indeed, MNEs face high business risk due to their engagements with independent suppliers and vendors, which can hardly be controlled. To favour ethical behaviour, most MNEs formulated or revised the code of conducts, especially for the suppliers-related norms. They also adjusted operating strategies by broking up or changing the approach to trading relations, by requiring supplier certifications according to suitable protocols, by investigations on site, and/or by providing incentives to the most responsible suppliers. These initiatives are aligned with the suggestions made by previous literature on the "sweatshops" concerns along the supply chain in the apparel industry (Emmelhainz and Adams, 1999; Mackenzie, 2007). Monitoring the supply chain through a number of governance and managerial mechanisms is regarded by MNEs as an effective reaction to restore their legitimacy after heavy scandals. More attention was also dedicated to CSR investments and collaborations with NGOs at different levels, and in some cases philanthropic initiatives and commitment to build better work conditions on the host countries.

A second common element is that all MNEs become more accountable of their corporate actions in terms of CSR. Some companies published the list of their suppliers of the website. Most of them started issuing the CSR report in the year after the scandal, as only one MNE already prepared it. All MNEs adhere to qualified guidelines for their CSR reports and progressively extend the CSR content.



It could be the case that, as a communication tool, CSR reports are perceived as an effective initiative to respond quickly to the needs of a wide range of stakeholders. This is consistent with the role assigned to CSR reporting by existing literature (Kolk, 2008; van Wensen *et al.*, 2011). However, only two MNEs submit the CSR report to external assurance, choosing a limited form only. Despite the potential assigned to such CSR initiative by professional associations and previous literature (a.o., Manetti and Becatti, 2008), this mechanism is not yet widespread and regarded by corporations as an effective tool to restore legitimacy in case of scandals. This perception may be due to the technical nature of the assurance process in situations in which more “visible actions” may be preferred. However, the lack of external assurance on CSR report might give rise to the suspect of impression management or greenwashing strategies implying the information power of CSR reports.

A third common aspect is that all MNEs undertook several actions on the side of regulation, governance system and operating strategy. Besides being the advocates of such actions, some MNEs also looked for a cooperation with NGOs and accepted different forms of investigations by NGOs on their operating strategies. The approach to accountability tends to be different, however, as MNEs prefer to exert an active role, avoiding external assurance or accepting it only in a limited form.

Some differences may also be noticed from the findings of the multiple case-studies analysed, especially with respect to the attitude assumed by MNEs towards the refusal or admission of their responsibility in the scandals. The first attitude is adopted by those companies that were accused of more than one scandal in the analysed period. Indeed, Nike and H&M make many justifications for getting rid of their responsibilities in their CSR reports. Conversely, when the scandal is directly and uniquely linked to a specific irresponsible corporate behaviour, either geographically or temporally (Walmart and Moncler), there is a prompt admission of guilt, followed by the implementation of new CSR initiatives according to the expected reactive attitude.

Overall, we found evidence that besides selecting to strengthen some types of CSR activities instead of others, MNEs shape both the internal and external environment to make it more favourable to ethical behaviours, and rely on social and environmental accountability. In such regard, our findings confirm the arguments put forwards by Sethi (1975) on legitimization, even in more recent times and in a peculiar situation like a corporate scandal.

To conclude, this paper highlights that MNEs assume a resilient attitude in response to CSR-related scandals. The relevance of CSR activities to restore the legitimacy to operate, when the latter is compromised by adverse events, is clearly demonstrated in the multiple initiatives undertaken in most of the dimensions of behaviour, and especially ethical norms, operating strategies, and social accountability. Only the aspect of external assurance of CSR report is results to be neglected. Further studies might investigate the perceived value of the assurance statement by the various users of the

CSR report, so as to clarify whether MNEs attitude towards this tool is due to its recent introduction and evolving nature and/or to a lack of business culture able to gain its potential benefits. Moreover, further studies may explore the reasons behind the gap between CSR initiatives declared but delayed, as well as the reactions of stakeholders in such cases.

## REFERENCES

- Adams, C.A. (2004), "The Ethical, social and environmental reporting – performance portrayal gap", *Accounting, Auditing & Accountability Journal*, Vol. 17 No. 5, pp. 731-757.
- Alon, A. and Vidovic, M. (2015), "Sustainability performance and assurance: Influence on reputation", *Corporate Reputation Review*, Vol. 18 No. 4, pp. 337-352.
- Andersen, M. and Skjoett-Larsen, T. (2009), "Corporate social responsibility in global supply chains", *Supply Chain Management: An International Journal*, Vol. 14 No. 2, pp. 75-86.
- Arvidsson, S. (2010), "Communication of Corporate Social Responsibility: A Study of the Views of Management Teams in Large Companies", *Journal of Business Ethics*, Vol. 96 No. 3, pp. 339-354.
- Bartlett, C.A. and Ghoshal, S. (1989), *Managing Across Borders: The Transnational Solution*, Harvard Business School Press, Boston, MA.
- Carroll, A.B. and Shabana, K.M. (2010), "The Business Case for Corporate Social Responsibility: A Review of Concepts", *International Journal of Management Reviews*, Vol. 12 No. 1, pp.85-105.
- Cho, C.H., Roberts, R.W. and Patten, D.M. (2010) "The language of US corporate environmental disclosure", *Accounting, Organizations and Society*, Vol. 35 No. 4, pp. 431-443.
- Clarkson, P. M., Li, Y., Richardson, G. and Tsang, A. (2015), "Voluntary External Assurance of Corporate Social Responsibility Reports and the Dow Jones Sustainability Index Membership: International Evidence", available at: <http://cear.gsu.edu/files/2015/09/Session-6-Richardson-Paper.pdf> (accessed 10 April 2017).
- Clemente, M. and Gabbioneta, C. (2017), "How Does the Media Frame Corporate Scandals? The Case of German Newspapers and the Volkswagen Diesel Scandal", *Journal of Management Inquiry*, February-01-2017.
- Commission of the European Communities (2001), "GREEN PAPER: Promoting a European framework for Corporate Social Responsibility", available at: [http://europa.eu/rapid/press-release\\_DOC-01-9\\_en.pdf](http://europa.eu/rapid/press-release_DOC-01-9_en.pdf) (accessed 1 April 2017).
- CorporateRegister.com (2013), "CR Perspectives 2013. Global CR Reporting Trends and Stakeholder Views", available at: <http://www.corporateregister.com/> (accessed 12 January 2017).
- Entman, R.M. (2012), *Scandal and silence*, Polity Press, Cambridge, UK.
- Deegan, C. (2002), "The legitimising effect of social and environmental disclosures – a theoretical foundation", *Accounting, Auditing & Accountability Journal*, Vol. 15 No. 3, pp. 282-311.
- Emmelhainz, M.A. and Adams, R.J. (1999), "The Apparel Industry Response to "Sweatshop" Concerns: A Review and Analysis of Codes of Conduct", *The Journal of Supply Chain Management*, Vol. 35 No. 2, pp. 51-57.
- Fombrun, C. and Foss, C. (2004), "Business Ethics: Corporate Responses to Scandal", *Corporate Reputation Review*, Vol. 7 No. 3, pp. 284-288.
- Kolk, A. (2008), "Sustainability, Accountability and Corporate Governance: Exploring Multinationals' Reporting Practices", *Business Strategy and the Environment*, Vol. 17 No. 1, pp. 1-15.
- Lungu, C.I., Caraiani, C., Dascalu, C., Guse, R. and Sahlian, D. (2009), "Corporate Social and Environmental Reporting: Another Dimension for Accounting Information", available at: [https://papers.ssrn.com/sol3/papers.cfm?abstract\\_id=1447247](https://papers.ssrn.com/sol3/papers.cfm?abstract_id=1447247) (accessed 10 March 2017).
- Mackenzie, C. (2007), "Boards, Incentives and Corporate Social Responsibility: the case for a change of emphasis", *Corporate governance*, Vol. 15 No. 5, pp. 935-943.
- Manetti, G. and Becatti, L. (2008), "Assurance Services for Sustainability Reports: Standards and Empirical Evidence" *Journal of Business Ethics*, Vol. 87, Supplement 1, pp. 289-298.
- OECD (2011), "OECD Guidelines for Multinational Enterprises", available at: <https://www.oecd.org/corporate/mne/48004323.pdf> (accessed 31 March 2017).
- Perego, P. and Kolk, A. (2012), "Multinationals' Accountability on Sustainability: The Evolution of Third-Party Assurance of Sustainability Reports", *Journal of Business Ethics*, Vol. 110 No. 2, pp. 173-190.

- Peters, G.F. and Romi, A.M. (2013), "The Association between Sustainability Governance Characteristics and the Assurance of Corporate Sustainability Reports", *Auditing: A Journal of Practice & Theory*, Vol. 34 No. 1, pp. 163-198.
- Sethi, S.P. (1975), "Dimensions of corporate social performance: an analytical framework", *California Management Review*, Vol.17 No. 3, pp. 58-64.
- Sims, R. (2009), "Toward a Better Understanding of Organizational Efforts to Rebuild Reputation following an Ethical Scandal", *Journal of Business Ethics*, Vol. 90 No. 4, pp. 453-472.
- Thompson, J.B. (2000), *Political scandal*, Polity Press, Cambridge, UK.
- Van Staden, C.J. and Hooks, J. (2007), "A comprehensive comparison of corporate environmental reporting and responsiveness", *The British Accounting Review*, Vol. 39 No. 3, pp. 197-210.
- Van Wensen, K., Broer, W., Klein, J. and Knopf, J. (2011), "The State of Play in Sustainability Reporting in the European Union", available at:  
<http://ec.europa.eu/social/main.jsp?langId=it&catId=331&newsId=1013&furtherNews=yes> (accessed 12 February 2017).

## SUSTAINABLE BUSINESS MODEL INNOVATION: AN OPPORTUNITY FOR THE FOOD INDUSTRY

Franceschelli, Maria Vittoria<sup>1</sup>; Santoro, Gabriele<sup>2</sup>

<sup>1</sup>University of Milano Bicocca, Milan, Italy

<sup>2</sup>University of Turin, Turin, Italy

### ABSTRACT

This paper investigates the way in which a food firm can develop business model innovations taking into account the importance of social and environmental issues. To answer to our research question “how food firms can develop a sustainable business model innovation?” we have studied an Italian pizzeria implementing the single case study methodology. We contribute to extant research introducing the concept of sustainable innovations within the business model’s literature. We conclude that within the food industry, the development of sustainable business model innovations is particularly important because the industry is itself linked with nature and human respect.

*Keywords: business model innovation; sustainability; food.*

### INTRODUCTION

The business model is essential for a firm given that it concerns the way in which a product or a technology is commercialized and how it creates value (Chesbrough and Rosenbloom, 2002). Studies suggest that firms should reconfigure the business model in one of more elements in order to compete and re-shape the value proposition (Chesbrough, 2010). In fact, business model innovation guarantees higher returns compared with product or process innovation (Massa and Tucci, 2013).

In the same way, environmental-friendly activities have been integrated within the strategic management (Aragon-Correa and Sharma, 2003; Sharma and Vredenburg, 1998) because also sustainability is considered a key factor to reach the competitive success (Ameer and Othman, 2012; Mass et al., 2014). Therefore, it seems logical that environmental thinking should be included in the business model, and in particular, should be the object of business model innovations.

Especially, the food industry is particularly competitive and many business model innovations have been developed so far (Amit and Zott, 2010) taking into account environmental and social aspects.

For “sustainable business model innovation”, we mean the Osterwalder’s business model configuration that focuses its attention on environmental and social aspects.

Despite this, academic literature does not seem so abundant in this regard (McCarthy et al., 2016).

This paper intends to fill this gap by answering the following research question: “how food firms can develop a sustainable business model innovation?”. To reach this goal, this work applies the case study methodology, by studying a small firms producing pizza through a sustainable and innovative business model, according to Osterwalder’s business model configuration.

## **THEORY DEVELOPMENT**

### *Business model and business model innovation*

The business model of a firm is important as it regards the way in which a product or a technology is commercialized and create value (Chesbrough, 2010). In fact, a product or a technology itself does not create value without an effective and valuable business model (Chesbrough, 2010).

More specifically, a business model is the way in which the value proposition is articulated, the target market is identified, the revenues mechanisms are defined, as well as the structure of the whole value chain (Chesbrough and Rosenbloom, 2002). Similarly, a business model can be defined as the logic according to which a firm operates and creates value for stakeholders (Casadesus-Masanell and Ricart, 2010).

The business model configuration of Osterwalder (2004) considers other two main elements, namely the cost structure, generated by key resources, partner network and key activities, and the revenue flows, generated by client segments, client relationships and distribution channels. All the elements within this business model configuration hinges on the value proposition which is the core of the firms’ activities.

This and other business model configurations provide managers with a strong tool to develop alternative business models to cope with the increasing competition.

In fact, business model can be also considered a tool used in contexts of uncertainty in order to compete and re-shaped the offering (Tell et al., 2016). In this case, a business model innovation is achieved. Thus, it is an improvement of one or more elements of the business model (Osterwalder and Pigneur, 2010). It allows managers to connect innovative products and services to a valuable proposition; in turn, the business model may be also a source of innovation itself (Massa and Tucci, 1999). In detail, business model innovation refers to the activity of designing (creating, implementing, validating) a new business model (Massa and Tucci, 1999). Moreover, a business model innovation can be achieved by new formed firms or by incumbent firms by a business model reconfiguration (Massa and Tucci, 1999). In this regard, a business model innovation is especially valuable in times of

crisis and high competition because it provides firms with a way to avoid direct competition and discover Blue Ocean (Kim and Mauborgne, 2014).

#### *Business model innovation in food industry*

The food industry is considered mature and slow growing by some studies on literature (Sandven and Smith, 1993; Costa and Jongen, 2006; Rama, 2008; Hou and Mohnen, 2013). Other studies suggest that the food industry is an important part of the European economy (Costa et al., 2016; Tell et al., 2016).

Some changes from a socio-economic point of view are posing challenges to food firms, calling for new innovative and creative business models. In fact, customers can easily access information about products and require both more product variety with specific dietary and customized facets (Costa et al., 2007) and more healthy food that does not affect the natural environment and human health. These factors have increased the pressure on food firms to be more innovative.

For these reasons, more and more firms operating in the food industry are experimenting innovative business models to compete in the market (Jolink and Niesten, 2015), especially the smaller firms who traditionally do not have the resources and capabilities to growth. Despite this, most of the studies on innovation in the food industry have tackled the issue concerning how improve product innovation and therefore business model innovation is neglected (Ulvenblad et al., 2014). Conducting a systematic literature review on innovation in food industry, Tell et al. (2015) found that food industry articles are primarily qualitative, empirical studies that focus on one or a few companies (i.e. case studies), and the specific focus on business model is lacking, especially for smaller firms.

#### *Sustainable business model innovation in food industry*

There has been an increasing interest in sustainable business model. This concept is used in reference to environmental and social aspects as corporate social responsibility, business sustainability, sustainable agriculture, food security and safety, and eco-system services. In fact, firms increase their consideration of the aforementioned aspects in their business models (Birkin et al., 2009) showing the strong interconnection between them.

For example, McCarthy et al. (2016) found that Chinese consumers are turning towards certified food for health reasons and are sceptical about genetic modification (GM) food.

Previous research shows the positive effects of green practices and a sustainable business model, but in particular how innovation is the means by which firms improve a sustainable development performance (Hart and Milstein, 1999; Hart and Sharma, 2004; Porter and van der Linde, 1995a, 1995b,

Senge and Carstedt, 2001). Innovation is regarded as a *panacea for sustainable development* (Hall and Wagener, 2012: 183).

Despite the lacking of studies on business model innovation in food industry, Bossle et al. (2016) indicate that food firms engage in eco-business model innovation for internal and external factors. The most important internal factors are the human resources followed by environmental managerial concern and environmental capability. In turn, collaboration is the most important external factor followed by normative pressures and environmental regulations. Moreover, the authors suggest that government support is a deficient in adopting an eco-business model innovation.

## METHOD

To answer to the research question “how food firms can develop a sustainable business model innovation?” we have applied the case study methodology. In fact, it seems particularly suitable to answer to the “How” and “Why” questions (Yin, 1994) and to study innovation in food firms (Tell et al., 2015).

In order to achieve our aim, we have structured the research methodology in three phases (Stake, 1995). During the explorative phase, we have collected secondary sources as news from social media or television or newspaper, database and web site. The main scope of the explorative phase is to collect the most important data for the development of this work. In particular, we have first studied the topic, making a review of the existing literature on the three main topics: business model innovation, food industry and sustainability applied to business. In fact, according to the previous studies, the literature review has the ability to accomplish the same aim of the real-life context (George and Bennett, 2005; McKeown, 2004; Yin, 1994).

Studying newspaper, website and other secondary sources information, we have identified few target firms. Among others, we have chosen Pizza (Pseudonym for privacy reasons) as the main representative firm in the food industry regarding a sustainable business model innovation.

During the second phase we have collected primary data. To do so, we have first sent a questionnaire composed by thirteen structured questions based on level of measurement (5 point Likert scale) and asking the availability to be interviewed. The primary data source was the semi-structured interviews with the founder, now also CEO, of the firm. He invited us to visit the restaurant personally. Therefore, our data collection consisted of several primary and secondary data sources: phone call, face-to-face meeting, email, questionnaire, internet and media coverage of the firm. The triangulation of data helped us to improve the completeness of information (Eisenhardt, 1989) and the degree of correctness of our findings (Jick, 1979). The analysis of the collected data was the last phase.

It seems mandatory to describe the activity and the features of Pizza.

Pizza was founded to provide a quality delivery-pizza. In fact, as the founder explained, every Wednesday he and his friends used to have pizza. However, every time they were disappointed by the taste, ingredients and quality. Therefore, they have decided to create a new business based on the production of digestible and light pizza made by only semi-wholemeal organic flour. The selection of ingredients is particularly important. In fact, they use only fresh, seasonal and Italian products. Furthermore, they have implemented primary and secondary activities based on the respect of the nature and the importance of healthcare. For example, they use only biodegradable products (as cutlery, glasses and napkins) and sustainable facilities to not produce CO<sub>2</sub> (as a electric oven and electric delivery-bikes).

We believe that, thanks for its characteristics, Pizza is a unique, representative, leading case (Yin, 2003).

## **GREEN BUSINESS MODEL INNOVATION IN THE PIZZA CASE**

Pizza is a very new firm, which started its activity in April 2016. This aspect is particularly relevant for two reasons. First, because the founder had the chance to develop the business model from scratch. In fact, the founder (which is also the CEO) is an engineer that had previously worked as project manager. Second because the business model innovation was done during a time of crisis (Kim and Mauborgne, 2014). Therefore, implementing the food activity, the founder has paid particular attention to the business-economic aspect: *certainly, the economic part cannot be set aside, it is crucial* – Pizza CEO.

In line with this, analyzing the business model of Pizza, we have found sustainable/innovative aspects for each of the business model points (Osterwalder, 2004). Therefore, the discussion of the case study stresses the innovative and/or sustainable aspects of each of the 9 element of the business model.

The innovative business of Pizza is focus on a specific client segment. This identification was made a priori. In fact, focusing on the particular kind of food, not a “normal pizza” but a healthy, light and a kilometer zero pizza, the CEO decided to focus on 25 to 50-year-olds and families (in particular mothers with young sons), so people who pay attention on the food quality *seen not only as the taste but as a selection of ingredients. This for them is the predominant element* – CEO Pizza. Several are the reasons behind this choice. First, he decided to focus on who are health-conscious because they are willing to pay more for a high quality product. For this reason, he decided to not to include very young clients, as high school or college student that are not prepared to pay higher price. Because you can pay only



by card, he said that he decided to exclude *low-cultural or not digitalize person* that do not have credit card.

Linked to the segment, is the relationship that the firm can have with its clients. In fact, we have already said that these types of clients are digitalized, that means that are supposed to use technologies and social media. Thanks to their propensity to use high-tech, Pizza can have reliable and affordable feedback on its activity. People can express their opinion on social media as Trip Advisor, Facebook, Twitter, Instagram and so on. In fact, “network involvement” is considered one of the main determinants of greenness of innovation (Triguero et al., 2014). Therefore, Pizza can establish a relationship with clients, and can use the customer's comments as opportunities to get closer to their preferences and improve their business. Social media has evidenced that initially clients come because of the “Idea of a different pizzeria”, not because of the product but for the idea for the pizza to zero impact, and for the project “one pizza for one tree”. In short, due to the fact that it is conceptually more similar to a company that to a simple restaurant. Later, what clients stress is the quality and taste of the product.

Pizza has two main distribution channels: takeaway delivery and eat-in restaurant. Both of them are characterized by sustainable innovation. The takeaway channel is made by bicycle or electric scooter, which is coherent with the “sustainable activity and ideology” and you can pay only online using credit card. This innovative choice was made to avoid that the delivery man has to waste time waiting for cash and the change: *he must open his jacket to take the wallet and he probably will not have the exact change, and if it rains all things will get wet, with the result that waste time and other pizzas get wet*- Pizza CEO. The takeaway delivery channel is both innovative and sustainable. Obviously it is linked with the client segments, that we have discussed above.

The second distribution channel is the eat-in. Pizza has a small restaurant in which you can have a pizza. All the cutlery, glasses and napkins are biodegradable. Walls are covered with “sustainable quotes” to get the attention of customers on the importance of zero impact activities and the importance of implementing sustainable innovations. These aspects are examples of environmental orientation of Pizza in Eco-innovativeness (Triguero et al., 2014).

In line with the previous elements, Pizza revenues flows are lower than a “classic pizzeria”, because it does not cover part of the potential clients: *we do not have the revenue of a normal pizzeria because we have half of their clients (because of age and cultural level) and, of course, our market is already smaller* –Pizza CEO. Revenue flows exclusively came from credit card or online payment that made all of them traceable.

Now we can discuss of the costs structure of Pizza. Some costs structure are higher than those of competitors are, but they are necessary to ensure the sustainability of the business model. In fact, some

ingredients and resources, that are seasonal or biological or zero kilometre, have higher cost but are necessary for the business model of the firm and for the quality of the products. Nevertheless, the fact that most of the ingredients are “zero kilometre” or national means that on the one hand the environmental impact is reduced, on the other hand the ingredients cost is higher. Another element of cost is that all the machineries used are “at zero impact”. This is a very innovative element in a food company, especially in an “Italian high quality pizzeria” where it is usually use traditional wood oven. Obviously, the technology and the innovativeness of an electric appliances and machineries lead the increasing of cost structure.

Summarizing, high cost structure is necessary to validate the sustainable business model innovation.

Linked with the cost structure, there are the key resources. In fact, resources selection is fundamental in the whole business model of Pizza. In particular, the firm uses only national, seasonal and DOP ingredients (guarantee by Italian regulation), such as semi-wholemeal organic flour. This guarantees the quality of the products. As we already said, most of the ingredients are local. This aspect has two main implications: first Italian local ingredients are considered good and high quality, second it is a sustainable strategy because it avoids emissions due to large distance transportations.

Moreover, in line with the sustainable view of Pizza, all the machineries are electric in order to avoid CO2 emissions, and the energy used comes from renewable sources.

But there is more: within the restaurant are used biodegradable cutlery, glasses and napkins for both the customers and the cooks in order to decrease the environmental impact of the production and offering processes. This is a particularly sustainable innovation. In fact, as the Pizza’s CEO said, most of the restaurants that follow sustainable strategy use only few biodegradable object. Instead, all the tools, as glassed, napkins, cutlery, tablecloths and so on used in the restaurant are environmentally friendly. *Obviously, having all these organic products is more expensive, but if you do not mean that you are implementing eco-innovations as a marketing activity, not as a real part of your mission and your business –* Pizza CEO said.

*Partnerships are becoming a cornerstone of many business models* (Osterwald and Pigneur, 2010: 38). In line with this concept, partnerships are seen as essential in the Pizza business model. In particular, the firm collaborates with Eden Reforestation Projects in order to devolve part of the revenues in favour of the reforestation. For each pizza sold, one tree is planted. This creates a great impact on the social responsibility of the firm, and creates an engagement with a customer who is therefore indirectly responsible for the reforestation of the world.

Furthermore, several partnerships are conducted in the online distribution channels. Pizza has three key partners in this regard, one of which is very strategic. On the online platform of this partner is

possible to order a customized pizza, increasingly widespread phenomenon among consumers. The delivery service, made by Pizza's partners, is provided by electric transports such as electric scooters and bikes.

To produce a healthy-light-innovative-sustainable pizza, Pizza implements few key activities. For example, the dough is very slow in order to make the pizza light and savoury. The recipes are developed based on seasonal ingredients in order to ensure the freshness of the products. These activities are crucial for the success of the product. The innovation of these activities lie in the total coherence with the sustainable values of each activity.

## IMPLICATIONS AND CONCLUSIONS

Given the increasing competition in the food industry, the business model as a strategic tool is essential, although has been little used in food literature, especially in food services and pizzerias and in simple configurations such as the one presented by Osterwaler.

The food industry, especially restaurants, is very fierce and often it is difficult to expand or grow internationally. However, famous cases (such as Starbucks, McDonald) demonstrate that restaurant players, who have succeeded a national or international level, are the ones who have implemented a completely new business model. Our case has developed a business model that has focused on sustainable innovation, and is a unique example in Italy.

This research adds to the literature on the food industry, analysing the possible development of sustainable business model innovations. In fact, little attention was paid on this aspect that is particularly important in a business that is constantly changing as the food industry.

In fact, we are considering essential goods. Consumers are questioning every day on their consumption choices, and increasingly want to be updated on product quality and on firm's business model choices. In a world that is pointing more and more to sustainable development, we believe that sustainable innovation is a winning strategy to reach the business success, especially in the food industry that is closely linked to sustainability from nature and human health point of view. Therefore, we can conclude that within the food industry, the development of sustainable business model innovations is particularly important because the industry is itself linked with nature and human respect. In fact, environmental and social respect is fundamental to reach the business success, and it is strongly linked with innovation: *companies will have to develop innovative solutions. That will happen only when executives recognize a simple truth: Sustainability = Innovation* (Nidumolu et al., 2009: 12).

To do so a very precise business model is needed. This is another important contribution of this study: many previous works on business models do not use specific patterns to describe the business model of the analyzed cases. We have analyzed every single element of the business model configuration of Osterwalder (2004). We believe that this methodology can give a better and more precise overview of the business model.

## REFERENCES

- Ameer, R., & Othman, R. (2012). Sustainability practices and corporate financial performance: A study based on the top global corporations. *Journal of Business Ethics*, 108(1), 61-79.
- Amit, R., & Zott, C. (2010). Business model innovation: Creating value in times of change.
- Aragon-Correa, J.A., & Sharma, S. (2003). A contingent resource based view of proactive corporate environmental strategy. *Academy of Management Review*, 28(1): 71-88.
- Birkin, F., Polesie, T. & Lewis L. (2009). A New Business Model for Sustainable Development: an Exploratory Study Using the Theory of Constraints in Nordic Organizations. *Business Strategy and the Environment*, 18, 277–290.
- Bossle, M.B., De Barcellos, M.D. & Vieira, L.M. (2016) 'Why food companies go green? The determinant factors to adopt eco-innovations', *British Food Journal*, 118(6), 1317–1333. doi: 10.1108/bfj-10-2015-0388.
- Casadesus-Masanell, R., & Ricart, J. E. (2010). From strategy to business models and onto tactics. *Long range planning*, 43(2), 195-215.
- Chesbrough, H. (2010). Business model innovation: opportunities and barriers. *Long range planning*, 43(2), 354-363.
- Chesbrough, H., & Rosenbloom, R. S. (2002). The role of the business model in capturing value from innovation: evidence from Xerox Corporation's technology spin-off companies. *Industrial and corporate change*, 11(3), 529-555.
- Costa, A. I. A., Greco, M., Grimaldi, M., Cricelli, L., & Corvello, V. (2016). Inter-organisational innovation processes in the European food and drink industry. *International Journal of Management and Enterprise Development*, 15(2-3), 191-208.
- Costa, A. I. A., Schoolmeester, D., Dekker, M., & Jongen, W. M. F. (2007), "To cook or not to cook: a means-end study of the motivations behind meal choice", *Food Quality and Preference*, 18, 77-88.
- Costa, A. I., & Jongen, W. M. F. (2006). New insights into consumer-led food product development. *Trends in Food Science & Technology*, 17(8), 457-465.
- Eisenhardt, K. M. (1989). Building theories from case study research. *Academy of management review*, 14(4), 532-550.
- George, A. & Bennett, A. (2005). *Case Studies and Theory Development in the Social Sciences*, MIT Press, Cambridge.
- Hall, J. & Wagner, M. (2012). Integrating sustainability into firms' processes: Performance effects and the moderating role of business models and innovation. *Business Strategy and the Environment*, 21(3), 183-196.
- Hart, S. & Milstein, M. (1999). Global sustainability and the creative destruction of industries. *MIT Sloan Management Review*, 41(1), 23–33.
- Hart, S. & Sharma, S. (2004). Engaging fringe stakeholders for competitive imagination. *Academy of Management Executive*, 18(1): 7–18.
- Hou, J., & Mohnen, P. (2013). Complementarity between in-house R&D and technology purchasing: evidence from Chinese manufacturing firms. *Oxford Development Studies*, 41(3), 343-371.
- Jick, T. D. (1979). Mixing qualitative and quantitative methods: Triangulation in action. *Administrative Science Quarterly*, 24, 602-611.
- Jolink, A., & Niesten, E. (2015). Sustainable development and business models of entrepreneurs in the organic food industry. *Business Strategy and the Environment*, 24(6), 386-401.
- Kim, W. C., & Mauborgne, R. (2014). *Blue ocean strategy, expanded edition: How to create uncontested market space and make the competition irrelevant*. Harvard business review Press.
- Mass, S., Schuster, T., & Hartmann, E. (2014). Pollution prevention and service Stewardship strategies in the Third-part logistics industry: effects on firm differentiation and moderating role of environmental communication. *Business Strategy and the Environment*, 23, 38-55.

- Massa, L., & Tucci, C. L. (2013). Business model innovation. *The Oxford Handbook of Innovation Management*, 420-441.
- McCarthy, B., Liu, H. B., & Chen, T. (2016). Innovations in the agro-food system: adoption of certified organic food and green food by Chinese consumers. *British Food Journal*, 118(6), 1334-1349.
- McKeown, T. J. (2004). Case studies and the limits of the quantitative worldview. *Rethinking social inquiry: Diverse tools, shared standards*, 139-167.
- Nidumolu, R., Prahalad, C. K., & Rangaswami, M. R. (2009). Why sustainability is now the key driver of innovation. *Harvard business review*, 87(9), 56-64.
- Osterwalder, A. (2004). *The Business Model Ontology-a proposition in a design science approach*. Unpublished dissertation, University of Lausanne.
- Osterwalder, A., & Pigneur, Y. (2010). *Business model generation: a handbook for visionaries, game changers, and challengers*. John Wiley & Sons.
- Porter, M.E. & van der Linde, C. (1995a). Green and Competitive - Ending the Stalemate. *Harvard Business Review*, Sept.-Oct., 120-134.
- Porter, M.E. & van der Linde, C. (1995b). Toward a New Conception of the Environment-Competitiveness Relationship. *Journal of Economic Perspectives*, 9(4), 97-118.
- Rama, R. (2008). *Handbook of innovation in the food and drink industry*. CRC Press.
- Sandven, T. & K. Smith (1993). *Innovation activities and industrial structure: Industry and R&D in a comparative context*. European Innovation Monitoring System, EIMS Publication, 1. Luxembourg: European Commission, Directorate General XIII.
- Senge, P.M. & Carstedt, G. (2001). Innovating our way to the next industrial revolution. *MIT Sloan Management Review*, 42(2), 24-38.
- Sharma, S., & Vredenburg, H. (1998). Proactive corporate environmental strategy and the development of competitively valuable organizational capabilities. *Strategic Management Journal*, 19(8): 729-753.
- Tell, J., Hoveskog, M., Ulvenblad, P., Ulvenblad, P. O., Barth, H., & Ståhl, J. (2016). Business model innovation in the agri-food sector: a literature review. *British Food Journal*, 118(6), 1462-1476.
- Triguero, A., Moreno-Mondéjar, L., & Davia, M. A. (2014). Leaders and laggards in environmental innovation: an empirical analysis of SMEs in Europe. *Business Strategy and the Environment*.
- Ulvenblad, P., Hoveskog, M., Tell, J., Ulvenblad, P. O., Ståhl, J., & Barth, H. (2014). Agricultural business model innovation in Swedish food production: The influence of self-leadership and lean innovation. In *DRUID Society Conference 2014 on Entrepreneurship-Organization-Innovation*, Copenhagen Business School (CBS), Copenhagen, June 16-18, 2014.
- Yin, R. K. (1994). *Case study research: Design and methods*. Sage publications.
- Yin, R.K. (2003), *Case Study Research: Design and Methods*, 3rd Ed., Sage Publication, Beverly Hills, CA.
- Yin, R.K. (2009), *Case Study Research: Design and Methods*, 4th Ed., Sage Publications, Thousand Oak, CA.

## ASSESSMENT OF THE INTERNATIONAL DEVELOPMENT LEVEL OF KAZAKHSTAN NATIONAL PHARMACEUTICAL COMPLEX

Frolova, Elena<sup>1</sup>; Andreeva, Elena<sup>2</sup>; Abdurahmanova, Zulparuza<sup>3</sup>

<sup>1</sup>International Economy Department, Graduate School of Economics and Management, Ural Federal University named by the first President of Russia B. N. Yeltsin (Yekaterinburg, Russia)

<sup>2</sup>World Economy Department, Ural State Economic University (Yekaterinburg, Russia)

<sup>3</sup>Researcher, Scientific-Research Institute of the New Economy and System Analysis (NIINESA), Economic university Kazpotrebsouz in Karaganda (Karaganda, Kazakhstan Republic)

### ABSTRACT

The article presents the results of the research of Kazakhstan national pharmaceutical complex (NPhC) development in the modern system of international relations. The best practices of the world development in the field of pharmaceutical industry on the example of China and India (countries with emerging markets) were investigated. Based on the statistical data and comparison with achievements of emerging markets we assume that existing model of NPhC of Kazakhstan (country with transition economy) is not adequate to new conditions. The purpose of this paper is to estimate the level of Kazakhstan NPhC international development on the base of authors' methodology and offer the strategy of its future development in order to be integrated into the global pharmaceutical market. The traditional methodology approach is focused on a quantitative analysis but it is not enough. Therefore, we propose the qualitative approach (on the base of interviews). Regression model lets us to study the main factors and trends of the future development. In the final part of this paper the main elements of the strategy of internationalization (recommendations for the road map) for the national pharmaceutical complex of the Republic of Kazakhstan were formulated.

*Keywords: pharmaceutical industry, global pharmaceutical market, emerging market, national industry complex, internationalized reproduction processes, GVCs, Republic of Kazakhstan*

### INTRODUCTION

The process of globalization brings to the forefront new problems of sustainable development of the national economy in the modern system of world economic relations. The Republic of Kazakhstan is one of the countries whose national economy is of particular interest for researchers. The country has already integrated into the world economy system and has achieved some success, including: 56th place in the ranking of the life level (among 142 countries), 79th place – according to the global

innovation index. However, the share of the natural resources export from Kazakhstan remains high (about 85% in 2015), 45th place in the global competitiveness index (in 2015).

At the same time we know that the global players in the world economy are not only countries, TNCs, integration groups, etc., but in the globalizing world, new players are emerging, i.e. clusters, industrial regions, technology parks, internationalized reproduction processes (global value chain), etc. Our hypothesis is as follows. A system of production, scientific-technical, investment and other entities (units) has created a national pharmaceutical complex (NPhC) in Kazakhstan. Despite the fact that Kazakhstan belongs to the countries with transition economies the level of the NPhC development under the conditions of the new architecture of the world is not low. The global pharmaceutical market is going through a change of leadership and Kazakhstan has the opportunity to be integrated into the global pharmaceutical reproduction process along with other emerging markets. The further development of the national pharmaceutical industry on the base of the new strategy will allow the country to overcome natural resources dependence, to improve the international competitiveness of the national industry in the field of pharmaceuticals.

The development of such strategy should be based on international best practices. In pharmaceutical industry it is especially demonstrated by the emerging markets – India, China. So, the experience of internationalization of pharmaceutical companies is presented in this paper. The aim of the paper is to evaluate the current level of the NPhC international development of the Republic of Kazakhstan in the system of modern world interactions (in the field of pharmaceuticals) and clarify the strategy (offer some recommendations) for its further economic development in accordance with the features of the globalizing world.

## **BRIEF LITERATURE REVIEW**

A lot of theories are devoted to the problem of the world and national economy development. The Kazakhstan scientist Husainov emphasizes that “the national economy acquires a new quality in the modern era, ... the country is simultaneously under the influence of two processes: autonomy (sovereignty), on the one hand, and integration (cooperation), on the other hand” (Husainov, 2012). A lot of scientific articles focus on the different aspects of the national industry activity. National industrial complex (NIC) as a set of the different enterprises, firms, companies is the subject of the world economy (along with TNCs, international organizations, etc). So, the NIC development is based both on the classical theories of the world economy and the alternative theories and a new concepts. Classical theories (the theory of the international trade, international business, internationalization) consider such aspects as the comparative advantages, international competitiveness, national security, openness of the economic system, etc.). For example, Porter investigates this problem through the

prism of the international competitiveness (Porter, 1998). It is a well-known theory. Let us investigate unknown concepts especially those which reflect the characteristics of developing countries, emerging markets. For example, the infant industry theory is especially important for the developing countries at early stages of industrialization, emerging markets. The infant industry argument is largely based on Frederick List's writings and focuses on the government support (Mehdi, 2000).

However we need a newest concepts because "national economies and their industrial complexes as a subjects of the world economy acquires a completely different quality in modern conditions (in a globalizing world)" (Rodionova, 2016). Traditional theories can't answer new questions and explain the contradictions. For example, inconsistency is present in the scientific judgments of the scientists: on the one hand, countries operate as independent elements of the world economic system, but on the other hand, there is the erosion (disappearance) of the boundaries between their economies. Alternative theories and new concepts give us such answers. Firstly, it is geoeconomics (geo-economics). As a new paradigm geoeconomics explains that we are talking about the elimination of "economic borders" but the "territorial boundaries" remain intact, reproduction processes come beyond the national boundaries (Jean & Savona, 1997). National economies and their structures under the circumstances of globalization have developed new orienting points to be included into the world economy sphere: one of the main new global players is internationalized reproduction processes which generate the borders of economic activity and within the framework of these processes the world income is formed (Frolova & Frolova, 2015). Geoeconomic approach lets us offer the complex of indicator in order to assess the level of the international development of the national industrial complex (the kind of goods form in export contract, the place in "technological pyramid", etc.).

But the production process in the modern world has become more fragmented and we have to explain the theory of production fragmentation. According to Kierzkowski, Chihelkova and some others "internationalization and globalization have also led to fragmentation of production and global activities... production process is divided into various activities which are placed in the different places in the world" (Chihelkova, 2014). So, now it will be better to study industrial development through the prism of the global production networks or global value chains (GVCs). The value chain approach has firstly been used in the field of industrial development as a process of structural transformation. For many countries, especially low-income countries, the ability to effectively insert themselves into GVCs is a vital condition for their development" (Gereffi, 2011). The global value chain comprises "the full range of activities that are required to bring a product from its conception, through its design, its sourced raw materials and intermediate inputs, its marketing, its distribution and its support to the final consumer". Global production networks or global value chains (GVCs)



constitute important opportunities for developing countries to become part of the global economy (Gereffi, 2011). A lot of scientists investigate the different aspects of the GVC. Among them are: Gereffi (management within a value chain), Porter (the structure of a GVC), Kierzkowski (“smile curve economics”), Wallerstein (commodity chain), Ferraris (management, services including logistic).

*There are some differences between internationalized reproduction processes and GVC and we must take them into account:*

- two types of the links in the structure of a GVCs: forward linkages in GVCs and backward linkages in GVCs;
- concept of a value chain has been used to analyze the international trade and contribution of each country (main indicator is add value);
- different groups of the risks and factors for involving into the internationalized reproduction processes or participation in the GVCs for the developing country firms (for example, developing countries could remain providers of a low-value primary materials, the risk of remaining in low value added positions within the chain .

Conclusions of the traditional and new theories are important for us. So, we have to combine the classic and new approaches. For example, we can offer such additional indicators as “the depth of the involvement into the GVC”, “the length of the GVC”, etc.

In accordance with these theories and concepts we can offer the new methodology for the assessment of the national industrial complex international development.

## METHODOLOGY

Assessment methodology of the international economic development for any object provides a large number of algorithms (options). Their advantage is to systematically evaluate the quantitative aspect of the industry or market development. But the industrial complex includes industrial and commercial enterprises, logistic and marketing firms, etc. Among the disadvantages of the methodology we highlight the neglect of the analysis (both quantitative and qualitative) of other chains of the investment-reproduction processes. We offer to assess the level of the international economic development of the national industrial complex (NIC; for the pharmaceutical industry case – NPhC) in accordance with the following steps. The result of this procedure will show us the depth of the NIC’ integration into the world economy system and the orientation for the further development.

*Stage 1. Quantitative general analysis of international activities of the NPhC.* For its implementation we use a set of traditional indicators, taking into account the indicators of the present stage of the world economy development.

*1.1 Assessment of the operation of the NPhC (foreign trade aspect): industry level.* For the assessment we use the traditional indicators that characterize the foreign economic activity (both in the context of the world economy system and integration unions): volume (changes in the volume) of production and sales of pharmaceutical products in the country; contribution of the pharmaceutical industry in the GDP; volume of import and the share of imported pharmaceutical products in the total consumption; volume of export of pharmaceutical products; index of the openness, etc.

*1.2 Calculation of the traditional indicators for NPhC: business unit level.* There are well known indexes such as the index of internationalization, index of transnationalization, index of network spread etc. We propose to calculate them for the NPhC' entities (units, companies). In other words, the NPhC' index of internationalization is equal to the sum of these indices for the enterprise units.

*1.3 Forming the base for the comparison and comparison of the national characteristics with the best foreign practices.* Firstly, the base of comparison is the performance of the global market and industry. Secondly, the benchmark for comparison is the emerging markets achievements. For the pharmaceutical market there are countries as India, China and Russia. Key indicators for comparison are: a share in pharmaceutical world production, a share in world exports of pharmaceutical products, the level of internationalization, etc.

*1.4 Identification of the main factors that affect the development of the national pharmaceutical complex (NPhC) using mathematical methods.* All factors of the regression model are divided into five groups:

- macroeconomic indicators ( $E_1$  – GDP, % to the previous year,  $E_2$  – the share of pharmaceutical industry in GDP ( %);
- market indicators ( $K_1$  – the share of domestic producers in the market (%);  $K_2$  – the number of people employed in the pharmaceutical industry);
- investment indicators ( $I_1$  – investments in the pharmaceutical industry (%);  $I_2$  – the share of foreign investments in the pharmaceutical industry( %);
- innovation indicators ( $T_1$  – the share of innovative enterprises in the pharmaceutical industry (%);  $T_2$  – the share of innovations in the pharmaceutical industry (%).

*Stage 2. Qualitative analysis (assessment) of the level of the international activities development of the NPhC at its constituent entities (primarily, enterprises).* Only quantitative analysis of the NPhC integration into the world economical system is not enough because of the lag of statistics which does not reflect the essence of the changes. Qualitative analysis allows us to eliminate this disadvantage. To do it, we recommend using a technique of the geo-integrity index ( $Igi$ ) (Frolova, 2011; Frolova and Frolova 2015) because the above mentioned geoeconomic concept (Jean and Savona, 1997) has shown that the traditional indicators for the analysis and assessment of the NPhC international development level need to be supplemented by individual specific indicators, which reflect the features of its spatial

development and operating in the global geoeconomic space. However, it was designed for the country level and this index calculates a rating for the country. So, firstly, it is necessary to adapt it to the conditions of the industry sector. The other words, the components of the formula must be adapted to the level of national industrial complex. Secondly, existing index reflects the peculiarities of the internationalized reproduction chains (geoeconomic chains). But as we noted above, there are distinctive features between the internationalized reproduction chains and GVCs. Thus, the existing index needs to be adapted to the conditions of the GVC. In this case the formula takes the following form:

$$Igi = (I_1 + I_2 + I_3) / 3,$$

- $I_1$  – this subindex reflects the model of international economic relations and includes such indicators as involvement into the international division labor; the depth of involvement into the internationalized reproduction pharmaceutical process (system) etc.;
- $I_2$  – it reflects the kind of the local system in the context of the national industry (pharmaceutical) complex and includes such indicators as location of «head-quarters» of the biggest pharmaceutical TNC in the country; the level of decision-making: participation in management of the world pharmaceutical industry; membership in the international pharmaceutical Committees, Founds, Allies; etc.;
- $I_3$  – it reflects the level of the technological development and includes such indicators as the kind of goods form in export pharmaceutical contract; the depth of raw materials pharmaceutical manufacturing, etc.

In order to estimate this index you have to interview experts. The information base for calculation of the index components responds to the survey questions (table 1). The table is filled by directors and top managers of NPhC' companies. Such an indicator as "the model of the country's participation in the profits of the company" allows answering the question: what part of dividends remains at the site of localization of the enterprise for the national economy (territory) development. Feature of the geoeconomic model of international economic relations is to sell products in countries not participating in the production process. So the indicator "the share of products allocated for implementation in the partner country (left in the country of origin) in the total volume of export" allows identifying the type of the model. The questionnaire is designed in order to reveal (clarify) the essence of the index components (for the future management decisions). For example, in order to make the value of the indicator "the participation of the NPhC in the global income" high, the company should to use two contracts in its activity (simultaneously): the commercial contract of delivery of the goods (operational level) and the agreement to receive dividends from the project (strategic effect).

Question	Answer
Is the company a member of national and international professional associations (enumerate)?	
How do you estimate the recognition of the national commodity brand in the world?	
What is the commodity form of your products?	
What percentage of the country's participation in the gross profits of the company?	
- share of national capital in the ownership capital;	
- share of profits for the payment of dividends;	
What is the ratio of domestic and foreign components (in average for all levels of the investment and reproduction chain)?	
What is the share of foreign equipment?	
.....	

*Table 1. The questionnaire (fragment)*

Next, the researchers define the value of the index (*Igi*) components on the basis of the following scale (Table 2).

Indicators	Estimation scale		
	1	0.5	0
The depth of involvement into IRC(process) - system	Collaboration with all links of the IRC chain	Collaboration with 2-3 links of the IRC chain	Interaction only in one trade link
The country (place) where commodity, product (finished product) is selling	Market of non- participants countries (the third member)	Both	Country where factory (manufacturing process) is situated
Location of «heard-quarters» of biggest TNC in the country	World level	National and regional level	Only regional level
...	...	...	...

*Table 2. The rule for experts (fragment)(Frolova, 2011)*

Also we offer such indicators as the “the depth of the involvement into the GVC”, “the length of the GVC”, “the participation in the world income redistribution”, “the level of the availability of brand-holder status”, etc.

## RESULTS AND DISCUSSION

According to this methodology we have estimated the level of the NPhC international development (the case of the Republic of Kazakhstan) in the modern world interactions system (in the field of pharmaceuticals).

*Stage 1.1.* The assessment of the operation of the NPhC on the base of the traditional indicators that characterize the foreign economic activity is presented in the table 3 (the data for this table are taken from the Committee on Statistics of the Republic of Kazakhstan).

Indicator	Volume (year)
Contribution of the pharmaceutical industry in GDP	0.08%
The volume of production, mln. \$	11,4 (2010) 24,0 (2015)
The volume of export, mln. \$	1,6 (2010) 2,0 (2015)
The volume of import, mln. \$	90,2 (2010) 98,0 (2015)
...	...

*Table 3. The current parameters of the pharmaceutical industry and market of the Republic of Kazakhstan (fragment)*

This table presents that contribution of the pharmaceutical industry in GDP is low (0.08 %; the share of the natural resources export from Kazakhstan is about 85% in 2015). These results support the conclusion that the country's economy is oil-dependent and needs to diversify; the increase of production of the pharmaceutical products in the country is 21.75 % per year (so we can conclude about the rapid development). The increase of import is 1.6 % per year but this situation is not good because the share of imported pharmaceutical products in the total consumption more than 60%.

*Stage 1.2.* For this stage we have selected large pharmaceutical enterprises with foreign investment (capital) of the Republic of Kazakhstan. There are five Kazakhstan pharmaceutical companies only. These companies and SME don't have foreign subsidiaries. So the indexes of internationalization, transnationalization, network spread are zero. At the same time these Kazakhstan pharmaceutical enterprises are the participants of the GVCs and according to the above mentioned GVC-theory we can identify national internationalized pharmaceutical networks as "backward linkages" in GVCs.

*Stage 1.3.* The pharmaceutical industry of India and China (countries with emerging markets) demonstrate best practices. In this paper we want to show the peculiarities of the internationalization of national companies. Firstly, some facts about Indian company. In 1984, the Indian scientist, entrepreneur and philanthropist Dr. K. Anji Reddy founded a pharmaceutical company Dr. Reddy's Laboratories, which later became a leading international company. It is the third Indian company in

the world for the production of pharmaceutical products. Subsidiaries of Dr. Reddy's were opened in 25 countries. The table below (table 4) shows some of them (Frolova and Abdurahmanova, 2016; Dr. Reddy's. Official site).

Name of subsidiaries and year of the foundation	The type of activity	Location (country)	Additional information
Technology Development Centre	Clinical studies and the development of a new generation of drugs	USA, Princeton	Chief Research Center
Chirotech Technology Limited (2008)	Develop routes to APIs (Active Pharma Ingredients)	UNITED KINGDOM, Cambridge	Develops and uses advanced chemistry skills, including world-leading bio- and chemocatalysis technology
Technology Development Centre Leiden Octopus N.V.(1995)	NCE (New Chemical Entities) research, delivery drug	NETHERLANDS, Leiden	The Company is developing novel formulations of currently marketed drugs to give more comfort to the patients
Dr. Reddy's Laboratories Ltd.(2000)	Developing new products	CHINA, Guanghua	Developing new products in the focus therapeutic areas of Central Nervous System (CNS) and so on.

Table 4. Subsidiaries of Dr. Reddy's and its specialization (fragment)

One of the leading pharmaceutical companies in China is Qilu Pharmaceutical. It focuses on developing, manufacturing and marketing of generic drugs and active pharmaceutical ingredients in the therapeutic areas of Oncology, etc. The brand value of **Qilu** has been built on the basis of high quality products and high standard services, ranging from research and development, manufacture of APIs and finished dosage forms, packaging and global commercialization. **Qilu Pharmaceutical** has eight manufacturing sites for chemical synthesis, genetic-engineering, fermentation, etc. with global presence in North America, Europe, Latin America, Asia, Africa and the Middle East (table 5) (Frolova and Abdurahmanova, 2016; Qilu Pharmaceutical. Official site).

Name of subsidiaries (Year of the foundation)	The type of activity	Location (country)	Specialization
Qilu Pharmaceutical (Hainan) Co., Ltd. (2006)	production	China	it specializes in the manufacture of lyophilized powder for injection of oncological products
Qilu Pharmaceutical (Neimenggu) Co., Ltd.	production	Mongolia	It is the biggest producer of avermectin in the world. It makes antibiotics on a large scale

(2009)

Qilu King-pharm production India It produces over 16,000 tons of antibiotic active  
Pharmaceutical Co., ingredients. It produces animal health products  
Ltd. (1987) and insecticides and over 60% of its products are  
exported

... ..

Table 5. Subsidiaries of Qilu Pharmaceutical and its specialization (fragment)

The full table 5 presents us the following results:

- the production process has a high degree of fragmentation;
- the pharmaceutical companies have a lot of foreign subsidiaries and high level of internationalization (60-80 %);
- the company focuses on all levels (links) of the production chain especially the one with the high level of add value (clinical studies, marketing, investment, etc.);
- the global production chain is stretched (extended), the length is equal to 12 according to our calculation);
- the areas of the subsidiaries localization are the national clusters.

Stage 1.4. Regression model lets us identify main factors that affect the development of the national pharmaceutical complex (NPhC). According to methodology all factors were divided into five groups. The data for all variables are taken from the Committee on Statistics of the Republic of Kazakhstan (table 6).

Year	The share of domestic producers in the market, % (K1)	Investments in the pharmaceutical industry, % (I1-)	The number of people employed in the pharmaceutical industry (K2)	The share of innovative enterprises in the pharmaceutical industry, % (T1)	The share of innovations in the pharmaceutical industry, % (T2).	The share of foreign investments in the pharmaceutical industry, % (I2)
2000	5	3	567,6	17,6	11,2	18,6
2001	6	6	587,1	18,8	13,1	20,4
2002	7	7	617,3	19,5	17	28,8
2003	8	8	636,8	23	20	33
2004	9	10	764,3	24	27	39,2
2005	10	13	891,8	27	31	41
2006	10	15	904,5	30	35,6	47,5
2007	12	12	906,6	32	45,5	52
2008	15	13	919,1	35	50	55
2009	20	14	921,9	36	53,5	56,7
2010	25	15	948,8	42	47	65
2011	30	17	960,3	45	63	79
2012	35	18	1020,3	47	77	75
2013	40	20	1115,4	50	82	85
2014	50	22	1250,7	51	87	90
2015	60	24	1378,2	52	85	95

Table 6. Data for the regression model (fragment)

As a result, we obtained some models. The regression equation can be presented as follows:

$$Y = -8,42 + 2,58K_1$$

This means that increasing of the share of domestic producers in the Kazakhstan pharmaceutical market on 1% can provide the increasing of the volume of production on 2,58 bln. national currency (tenge).

For the second group factors we have received the following regression model (index of correlation is 0,9):

$$Y = -116,94 + 0,422 I_1 + 2,03 I_2$$

The regression equation for innovation factors with index of correlation ( $r_{YT_2} = 0,93$ ) can be presented as follows:

$$Y = -26,12 + 1,57T_1$$

The above mentioned GVCs-theory and "smile curve economics"-concept show us that such links of the global value chain as investment, scientific, innovation provide the maximum of the add value. According to the regression model we can see that such factors as the share of foreign investments in the pharmaceutical industry ( $I_2$ ), the share of innovative enterprises in the pharmaceutical industry ( $T_1$ ) are the main factors that affect the development of the national pharmaceutical complex of the Republic of Kazakhstan.

*Stage 2.* For the *qualitative research* we have selected large pharmaceutical enterprises with foreign investment (capital) of the Republic of Kazakhstan. 72 top managers have completed the questionnaire. We have processed them in accordance with the scale of values and obtained the following parameters of the index and its components:

1.  $I_1= 0.05$ . Causes (explanation): raw materials is supplied by foreign investors, a foreign investor as the owner of the company receives the income after the sale of pharmaceutical products, finished products are sold (exported) to the "third" countries (non-participants of the reproduction process). They are the CIS countries: Kyrgyzstan, Turkmenistan, Uzbekistan, etc.
2.  $I_2=0.16$ . The highest value is the component "the strength of cooperative ties". We can explain it by the fact that Kazakhstan signed several Agreements in the field of medicine, healthcare, pharmaceuticals, including agreements between the countries of the Eurasian Economic Union (EAEU).
3.  $I_3=0.13$ . The reason is the production of generic drugs (80-85%) but not the original pharmaceuticals and the low level of the GDP per capita.

Thus,  $Igi = 0.11$  or 11% (maximum 0.1 or 100%). It means that the NPhC of the Republic of Kazakhstan as the object of the World Economic Cooperation is included in the system of international relations, but the level of such inclusion (the depth) is low – 11%. For comparison: for Italian industry  $Igi=0.56$



(Frolova and Frolova, 2015), for Czech Republic  $I_{gi}=0.40$  (Frolova, 2011), for Russian industry (on the example of Ural region)  $I_{gi}=0.30$ .

The results of the analysis let us offer the following main elements of the strategy for the future international development of the national pharmaceutical complex of the Republic of Kazakhstan (recommendations) in accordance with the best world practices (China, India etc) and geoeconomic concept:

- Creation of a national pharmaceutical cluster and increase the competitiveness of national pharmaceutical products;
- Increase of the national share in the share capital of pharmaceutical companies in the context of the requirements of the national economic security (national strategy "Kazakhstan 2030");
- Creation of a strategic national pharmaceutical company;
- Creation of the foreign branches in the CIS countries (sequentially, according to the links of the extended internationalized investment-reproduction process);
- Increase of the national participation degree in the links of the global value chain with maximum added value;
- In order to make the national model of the foreign economic relations (on the example of NPhC) adequate to the conditions of the current global environment, it is necessary for Kazakhstan to increase the values for all components of the calculation index (or links of the GVC); but on the other hand, it is necessary to limit the degree of the openness of the national economy in the context of the requirements of the national economic security and national strategy "Kazakhstan 2030".

## CONCLUSION

Our hypothesis is that the level of the NPhC international development under the conditions of the new architecture of the world (with new global players) is not low and Kazakhstan has the opportunity to integrate into the pharmaceutical products market along with other emerging markets. But based on the statistical data and comparison with achievements of emerging markets we assume that existing model of NPhC of Kazakhstan (country with transition economy) is not adequate to the new conditions. We can formulate the following theoretical and practical results of the Kazakhstan NPhC research:

- the Republic of Kazakhstan has already integrated into the world economy system but the level of this integration is low both in the system of traditional and modern indicators; at the same time the potential of the internationalization is good;

- qualitative analysis and comparison with the best practices let us clarify the strategy for the further economic development of the NPhC in accordance with the features of the globalizing world; the main recommendations are: creation of a national pharmaceutical cluster and a strategic national pharmaceutical company, increase of the national participation degree in the links of the global value chain with maximum added value, etc.;

- we have already adapted methodology to the conditions of the modern world economy and global players' demands and add such qualitative indicators as "the depth of involvement into the IRC(process) – system", "the participation in the world income redistribution", the level of the availability of brand-holder status", etc. But the world architecture is changing every day so in addition to the classic theory (international trade, international business, international competitiveness) new theoretical concepts appear. According to some of them, "the global economy is increasingly structured around global value chains (GVCs) (Gereffi, 2011). So, it is very important to calculate the degree of the national participation in the global value chain on the base of the newest methodology.

Because of the good potential of the Kazakhstan pharmaceutical industry the new strategy will allow the country to improve the international competitiveness of the national industry in the field of pharmaceuticals.

## REFERENCES

1. Chihelkova, E. and Frolova, E. (2014), "The Impact of regionalism On Regional Development Under the Conditions of a Globalized Economy", *Economy of Region*, Vol. 4, pp. 45-57.
2. Committee on Statistics. Ministry of national economy of the Republic of Kazakhstan [Online] Available at [www.stat.gov.kz](http://www.stat.gov.kz) [Accessed: 1 March 2017].
3. Dr-Reddy. Company Profile [Online] Available at <http://www.referenceforbusiness.com/history2/57/Dr-Reddy-s-Laboratories-Ltd.html> [Accessed: 11 October 2016].
4. Ferraris, A., Bresciani, S. and Giudice, M. (2016) "International diversification and firm performance: a four-stage model", *EuroMed Journal of Business*, Vol. 11, Issue: 3, pp.362-375. [Online] Available at <https://doi.org/10.1108/EMJB-10-2015-0048> [Accessed: 31 July 2017].
5. Frolova, E. (2011) "How to estimate Globalization: Geoeconomic approach" In. *Crucial problems of international relations through the Eyes of Young Scholars: A New Era in International relations*. International Conference of Young Scholars University of Economics in Prague 2011 Proceeding of the International Conference of Young Scholars University of Economics in Prague, Prague, Czech Republic, pp. 479-489.
6. Frolova, E. and Abdurahmanova, Z. (2016), "Internationalization Activity Models of Modern Pharmaceutical Companies Activity", *Journal of Economy and entrepreneurship*, Vol. 10 No. 12-1, pp. 1007-1012.
7. Frolova, E. and Frolova, A. (2015), "International relations analysis: geoeconomic approach", in: Balcerowicz-Szkutnik, M. (Ed) *Comparative analysis of the dependence of the capital markets and economic system of international relations*. Katowice publishing house, Katowice, pp.21-29.
8. Gereffi, G. and Fernandez-Stark, K. (2011) *Global Value Chain Analysis: A PRIMER*, CGGC Duke university, Durham (USA). [Online] Available at [www.cggc.duke.edu](http://www.cggc.duke.edu) [Accessed: 31 July 2017].
9. Husainov, B. (2012), *Globalizacija. Transnacionalizacija. Integracija* (Globalization. Transnationalisation. Integration), Edelvies, Almata.
10. Jean, C. and Savona, P. (1997) *Geoeconomia. Dominio dello spazio economic*, 2-a edizione, Agnelli, F., Ed., Milano.

11. Kazhstanskii farmacevticheskii vestnik (Kazakhstan pharmaceutical Herald). [Online] Available at <http://pharmnews.kz> [Accessed: 1 November 2016].
12. Mehdi, S. (2000) "What did frederick list actually say? Some Clarifications on the Infant Industry Argument", Discussion Papers, UNCTAD, No. 149.
12. Porter, M.E. (1998) *The Competitive Advantage of Nations: With a New Introduction*, The Free Press, N.Y.
13. Qilu Pharmaceutical Official website. [Online] Available at URL:<http://en.qilu-pharma.com/> [Accessed: 11 October 2016].
14. Rodionova, I. A. et al. (2016), *Metamorfozy v prostranstvennoi organizacii mirovoi yekonomiki v nachale XXI veka (Metamorphosis in the spatial organization of the world economy in the early XXI century)*, Universitetskaja kniga, Moscow.
15. Wallerstein, I. (1989) *The Modern World-System*, vol. 3, Academic Press, San Diego.

# BRAND HATE: A QUALITATIVE STUDY ON THE EXTREME NEGATIVE EMOTION TOWARD THE BRAND

Gharbi, Dorra ; Smaoui, Fatma

Marketing Department, Institut Supérieur de Gestion (ISG)- Tunis University- Tunisia-

## ABSTRACT

This paper aims to explore the concept of brand hate among consumers in an emerging country: Tunisia. Brand hate is the extreme negative emotion toward a brand which has an impact on both the consumer attitude and behavior. Researchers have recently begun to take an interest in this concept, as a manifestation of recent postmodern phenomenon such as anti-consumption and consumer resistance behaviors. A qualitative study is led based on in-depth interviews in an emerging country context. Main findings suggest that utilitarian factors, identity factors, cultural and ideological factors explain brand hate. Moreover, the seller behavior is pointed out as a relevant driver of brand hate. In terms of outcomes, our results suggest that brand hate can lead to behaviors like complaining, negative word of mouth, boycott and avoidance.

*Keywords: brand, brand hate, negative emotions, identity, cultural, seller, emerging countries.*

## INTRODUCTION

Emotions are one of the defining forces in our lives; their importance lies in their ability to direct our actions and reactions (Zeelenberg and Pieters 2006; Kähr et al., 2016). In marketing, researchers were interested in the influence of emotions on consumer behavior and on the consumer-brand relationship (Bagozzi et al., 1999, Fournier, 1998). An abundant literature has been devoted to the impact of positive emotions toward the brand: Brand attachment, brand love, brand affective engagement, etc. (Carroll and Ahuvia, 2006; Alba and Lutz, 2013, Smaoui and Tmessek Behi, 2011). Nonetheless, consumers can also express negative emotions toward brands such as disappointment, detachment, anger or sadness (Mai and Conti, 2007; Romani et al., 2012). In some cases, these negative emotions can turn into hate. Brand hate is an extreme negative emotion that can have substantial damaging consequences on the consumer-brand relationship (Zarantonello et al., 2016). Recently some researches started to shed light on this concept (Romani et al, 2012), but nonetheless so far, this concept has been underexplored despite its potential severe managerial consequences. Indeed, consumers who feel hate toward a brand may harm the brand reputation and image. Their behaviors may vary from passive actions such as avoidance to more active and hostile ones like negative word of mouth, brand boycott

(Klein et al., 2004) or even brand sabotage (Kähr et al., 2016). These forms of activities are more frequent and relevant in the era of digital economy and social networks as consumers' empowerment has developed through the Internet. We can find for example anti-brand web sites or Facebook pages, where hate for the brand is openly expressed and explained within a community gathered and bounded by the hate for a brand (Kucuk, 2007).

Current research on brand hate is conducted mainly in developed countries (Zarantonello et al., 2016; Romani et al., 2012, Dalli et al., 2006) where brands are meeting severe market competition conditions and high consumer requirements. Anti-globalization and anti-consumption movements are also growing in these countries as a result of a loss of confidence in the present world order and in the consumption society (Klein, 2000; Iyer and Muncy, 2009). Emerging countries experiment different market conditions and different consumer consciousness toward brands and consumption (Burgess and Steenkamp, 2006). In such a context, consumers are still asking for mass consumption products. Brands, particularly western ones, are considered as important social status markers (Batra et al., 2000; Touzani et al., 2015). It seems interesting then to explore brand hate phenomena in this specific context: Do consumers in emerging markets experience brand hate? How? What are the reasons behind such a negative emotion? What possible consequences can be induced by brand hate? The objective of the present paper is to gain a better understanding of brand hate, its specificities, antecedents and consequences in an emerging country context: Tunisia.

## LITERATURE REVIEW

### *Brand hate concept*

Although scholars are becoming more interested in this topic, literature on brand hate is still scarce. Ben-Ze'ev (2000) and Rempel and Burris (2005) view brand hate as a stable and intense negative emotion regarding a brand. In line with the previous definition, Bryson et al. (2013, p. 395) define brand hate as "an intense negative emotional affect towards the brand". According to Johnson et al (2011) brand hate is mainly represented as a strong opposition resulting in the need for revenge that can be explained by an anterior negative experience.

Salvatori (2007) found that brand hate can be caused by negative attitudes related to negative experience with the product, while Alba and Lutz (2013) found that brand hate occur when the consumer is a "hostage" of the brand, in other words when the consumer cannot switch from a brand to another either because the brand represent a monopoly or due to a high price of transfer. Grégoire et al. (2009) describe hate as a desire to revenge or to avoid the brand, which may lead to two different behaviors, in the first case the customer aims to punish the brand and to damage it and in the second case consumer feels the need to cut off any contact or interaction with the brand. Romani et al. (2012)

view brand hate as a negative emotion related to brand dislike, more specifically they view it as the extreme form of brand dislike. We will retain the most recent definition of brand hate (Zarantonello et al., 2016) whom describe it as the most intense and consequential negative emotion consumers may feel toward a brand.

### *Antecedents of brand hate*

Though the literature on brand hate is limited some antecedents have been pointed out. Grégoire et al (2009) find that consumer dissatisfaction with the brand represents an important antecedent of brand hate. Byrson et al (2013) suggest that consumer dissatisfaction with service, country of origin, and negative stereotypes are potential antecedents of brand hate within the luxury sector. Negative reference group, some moral factors like monopoly resistance and corporate irresponsibility are identified as antecedents of brand avoidance by Lee et al. (2009). White and Dahl (2006) focus on dissociative reference groups as a reason to avoid some products. Moreover, disidentification was found to be the foundation for deep and meaningful opposition to brands (Wolter et al.,2015). Kucuk (2008), on the other hand, identifies negative double jeopardy as an antecedent of brand hate; he suggests that brands that are very much loved by consumers are often the ones hated the most.

### *Outcomes of brand hate*

According to Hirschman (1970) the reaction of a consumer when a brand fails to attempt the level of his/her expectations, can be expressed through the “voice” (expressing the satisfaction through negative word-of-mouth) or the “exit” (cut up the relationship with the brand by stop purchasing it). Boycott is identified as another outcome of brand hate (Krishnamurth and Kucuk, 2009). Zarantonello et al. (2016) found that brand hate is an antecedent to four outcomes, complaining, negative word of mouth, protest and patronage reduction/cessation. Finally, brand hate or dislike can lead to an extreme reaction, brand sabotage, which is a “deliberate behavior by consumers or non-consumers who have the dominant objective of causing harm to brand” (Kähr et al., 2016).

## **METHODOLOGY**

The purpose of this study is to explore and to get a deep understanding of the brand hate phenomena in an emerging market context. We adopt a qualitative approach since it is the best suited to respond to our objective and to gain a better understanding of the nature of a cultural phenomenon (Stake, 2010). Semi-structured in- depth interviews were led among nineteen (19) respondents from different backgrounds, age (from 19 to 55 years), gender (11 women, 8 men), location and social status. We give the respondents the choice to choose one or multiple brands they hate, and then we asked them to discuss four themes: their relationship with brands in general, their negative brand experiences and

feelings, their description of brand hate, the factors explaining this brand hate and the consequences. Various brands were chosen relating to diverse sectors: fashion wear, cosmetics, telecommunication brands, cars, etc. Interviews lasted between 40 mn and two hours. They were entirely recorded and transcribed. Data was analyzed using the content analysis approach (Krippendorff, 2012).

Once the interview done and totally transcribed, the first step was to rapidly browse through the transcript and to then read one by one all the interviews transcribed to take notes to get to understand the interviews as a whole and to be introduced to the data collected.

The second step was coding. The first thing to do was to label the pieces seen as relevant to the topic, the ones explicitly stated by the participant as relevant or important or the one stated previously at the literature and cited by the interviewer. The third step was creating themes by first resembling codes that had the same signification, the codes were putted together in various sub themes, ensuring in this way a complete analysis of the information collected and the final step was to label each theme found.

## FINDINGS AND DISCUSSION

### *Ways of expressing brand hate*

Participants used multiple ways to express hate toward a brand: facial expressions, body language, tonality and words of anger, frustration and hate. Many interviewees first talked about brand avoidance before talking about brand hate, the transition from one state to another is accompanied by a noticeable change in facial expression. When speaking about hate, the participants become more focused and were more detail oriented. When describing their feelings toward the brand, interviewee's facial expression indicates sadness, anger and disgust, which are the basic primary emotions that describe hate. Their voice tonality changed all along, many did use a sarcastic and angry tone while basically for almost all the interviewees the tone became more firm. Their body language does change from time to time and they became more agitated using sometimes their two hands to deliver the information. The experience that lead them to brand hate still affect them when they talk about it; they become either emotional, angry or sad all of the sudden. It's interesting to note that two interviewees despite all mentioned that they don't feel hate toward any brand. They said that they don't bother with forming negative emotions; whenever a brand made them feel uncomfortable or unsatisfied they reject it all the way, not putting a lot of effort in hating it.

### *Love, hate dilemma*

Some interviewees were balanced between desire and hate and seemed to have an internal conflict with what they feel toward the brand, they wanted to boycott a brand but couldn't and were frustrated at the fact that they couldn't resist their attachment to it: *"I did boycott it for a while before*

consuming it again I don't know what they are putting in it that make it so damn addictive, I can't resist it."(male, 25 years, Coca Cola). This interviewee wanted to boycott Coca Cola, because according to him it is a symbol of the USA hegemony, but failed because he find it irresistible. Belk et al. (2003) explain that desire and disgust can sometimes be very close to one another. Furthermore, Grégoire and Fisher (2008) have already discussed brand love as an antecedent of brand hate. Some interviewees faced an internal dilemma between attachment to a brand and hate. They were loyal customer before hating the brand after being disappointed due to a bad experience.

*Antecedents of brand hate*

The different reasons cited as leading to brand hate can be grouped into four main factors: utilitarian factor, identity factor, ideological-cultural factor and seller behavior factor.

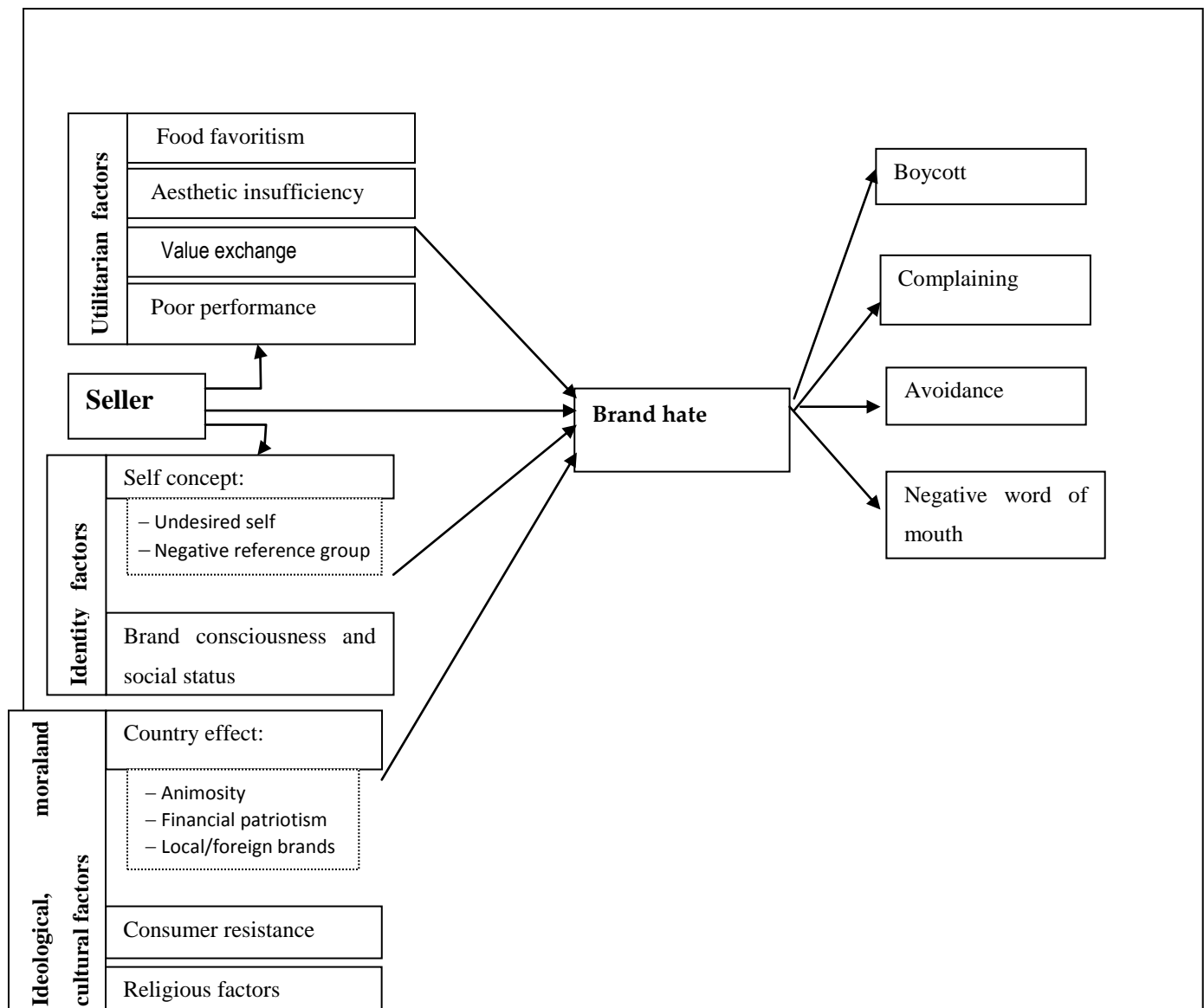

Figure1. BRAND HATE, ANTECEDENTS' AND OUTCOMES



*Utilitarian factors*

Utilitarian meaning refers to the different attributes of a product that concerns efficiency, convenience and value exchange (Dittmar and Pepper, 1992). Our results suggest that four antecedents of brand hate are utilitarian factors: poor performance, value exchange, aesthetic insufficiency and food favoritism. Poor performance was mentioned by some respondents they talked about poor quality, low durability and inability of the product/service to deliver its performance promises. Aesthetic insufficiency is related to the appearance of the brand; Lee et al. (2009) indicate that appearance can be an indicator of the brand functional efficiency. *"I hate the color and all, yellowish red, diarrhea green, blowfish purple, eukhhh it is just a big Nooo"* (female, 25 years, Hannibal TV, a local TV channel). Food favoritism (Lee et al., 2009) concerns a phenomenon where people reject food brands associated with value deficiency (contaminated and harmful, cheap brands, etc.). Some female interviewees in the mid thirties with children were very concerned with their kids' health and mentioned that they hate some brands because they represent a risk for their childrens' health. However they couldn't avoid those brands all the time because of their kids' preference. Value exchange deficit is another utilitarian factor leading to brand hate. Some respondents perceive certain brands as representing an unacceptable cost to benefit trade-off (Lee et al., 2009) *"I hate Zara! It is a scam; they are mocking us in every possible way: they sell mediocre clothes at a super expensive price. Zara in Europe is nothing but here (in Tunisia), they consider it as a great brand,"* (male, 37 years, Zara).

*Identity factors*

Individual's identity results from his interaction with himself, with other individuals, and with different groups within a society. The self and society are bonded and a person understands reality through his social interaction (Jenkins, 2014).

- *Self concept and the undesired self: As defined by Gardner et al. (2005) "The self is a relatively stable set of perceptions of who we are in relation to ourselves, to others and to social systems".* To that matter our findings suggest that two factors standing behind brand hate are related to the self concept: undesired self and dissociative reference group. Undesired self is defined as the emergence of negative emotions when the perception of the consumer of himself does not match the brand (Lee et al.,2009): An interviewee describes her feelings toward the fashion brand Zara as follows: *"I mean everything made me feel uncomfortable, the mannequins in the store and in the shop windows, how tall and skinny they were while I am here all chubby and short, I felt not in the norms I felt not fitting I felt so fat (.....), every time go to any "cool" store here all the cool kid and arrogant people buy I feel sick"* (female, 20 years, Zara). The participant above talked about how she felt not in the norms. Mainly her hate for the brand is the result of how she perceived herself in that context.

- *Self concept and the dissociative reference group:* dissociative reference group is a group with whom the individual does not want to be associated. Some people tend to avoid brands that are not congruent with their self concept (Grubb and Grathwohl, 1967; Sirgy, 1982). Dissociative reference group may, according to our findings, lead to brand hate *“I hate Bershka I think it is vulgar and I am sorry, people who wear from Bershka are of a vulgar kind and does not have the slightest taste,... it is impossible that I can be like that”*(female, 24 years, Bershka, fashion wear). Or *“I hate it, I consider it as degrading to the man image and I think it is actually for gays so, No I won't purchase anything from there”* (male, 25 years, Bershka)

- *Brand consciousness, social status and brand hate:* Throughout our analysis the second most cited word through the interviews beside hate (cited 182 times) is “people” (cited 148 times). Interviewees seem to be particularly sensitive to their social entourage and environment. In fact, social pressure may lead individuals to conform to social image and norms and to lung to a certain statute that may indicate success according to society codes. Brands are recognized to represent a kind of a social status marker or indicator that allows the individual to communicate his social status (Nelissen and Meijers, 2011). Brand consciousness refers to the tendency of individuals to buy well known brands which they believe are symbols of social status (Sproles and Kendall, 1986). Our findings reveal that some respondents are in continuous research of a certain social image and use brands as a symbol that communicate their social status. Even if they belong to a low social class, they have a tendency to buy well known and expensive brands. Nelissen and Meijers (2011) explain that in order to enhance their status, people from different social classes purchase luxury brands, associated with wealth and high status. The analysis of respondents discourse reveal that interviewees who are brand conscious may hate brands because they associate them with low social status *“I hate Palmarium, I think I didn't visited it since my 8 years old, I never purchase from there, take a look at people who go there, I don't' know them but I can recognize them in the street, they are what we call “jboura” (kitsch person), they are vulgare and belongs to certain social class. I purchase from three places: Zara store, Mango and may be Stradivarus store.”* (female, 24 years, Palmarium, a Tunisian shopping center). Though from a lower class, this participant purchased from “expensive”, occidental and well known brands, motivated by the desire to be seen as belonging to an upper social class

#### *Ideological, moral and cultural factors*

Country of origin, consumer resistance and religious background represent ideological, moral and cultural factors that explain brand hate.

- *Country of origin:* country animosity, financial patriotism and local/foreign brand are different faces of country of origin factors related to brand hate.

As suggested by Lee et al (2009) animosity occurs when dislike and hate for a country extend to the hate for brands originating from that country. Financial patriotism occurs when individuals develop negative feelings toward a brand because it represents a negative impact on their country. Some interviewees express animosity towards certain countries, mainly Gulf state countries and associate them to bad influence on Tunisia and Maghreb countries: *"I hate Ooredoo because it reminded me at least two things: that I hate the Gulf countries, they are becoming powerful and they dare and treat the Maghreb countries like s\*\*\*t, and that Ooredoo took the place of Tunisiana mobile operator brand name when Qatar bought Tunisiana"* (female, 32 years old, Ooredoo, mobile operator). The respondent has developed negative association with the brand, translated later into hate for the brand originating from this country. The rebranding of Tunisiana into Ooredoo, after Tunisiana was purchased by Qtel, the Qatar operator, was not accepted by many consumers who called for boycott of Ooredoo. Tunisiana was a beloved brand by a majority of consumers, and this love has turned into hate for some of them (Smaoui and Smiri, 2016).

Some interviewees talked about their love for foreign brand and their rejection for the local one *"I wish I never had to purchase Tunisian brands,(...) foreign brands are always better, it is impossible that we can have a Tunisian brand that could have the same quality as the foreign one"* (female, 37 years). This can be explained by the complex of the decolonized that, as was suggested by Touzani et al .(2015), is related to the preference of foreign western products in formerly colonized countries like Tunisia, it is a legacy of colonized period.

- *Consumer resistance:* Considering the context of this study, one concept that was surprisingly present as an antecedent of brand hate was consumer resistance. *"when going to Carrefour my mind is all about consuming, I buy things that are not useful , then once I am out ,I ask myself why did I bought so many things that I didn't need, I feel fooled !"*(female, 51 years, Carrefour). As can be seen in the previous quote brands can be hated when consumer feel powerless, when the brand become strong and dominant the consumers feel disempowered, they, become resistant to the brand by actively rejecting it (Cromie and Ewing, 2009; Lee et al.,2009). It also has to do with resistance to mass consumption: *"they are selling words they are selling what we call in Tunisian dialect "ri9" ! and people buy, buy and buy without even thinking about it"*(male,27 years, luxurious brands). This fits perfectly with the definition of Penalozza and Price (1993) as they describe consumer resistance as being engendered by counter culture attitude and behavior that put in doubt the current capitalist system and reduce consumption.

- *Religious factors:* Cultural factors along with religious factors appeared in multitude interviews as a valid factor for hating a brand. That was not a surprising finding as the context studied is a Muslim country. The following quotes came to clarify the concept. *"Elhiwar, I know a lot of people that are willing to boycott it (...) I look at their shows it contains a lot of dirty jokes, it is disgusting. Do you think it*

*is normal for us, Muslim people in a Muslim country to watch those television series, or this TV show in a sacred month like Ramadan ? What is hiding behind all this!!*" (male, 19 years, ElHiwar a Tunisian TV Channel). The interviewee talked about how the values represented by the TV channel (Elhiwar) did not match his Muslims' culture and values, and he rejected the brand.

#### ***Specific role of seller behaviour in brand hate***

Sales person behavior was the more cited reason leading to hate as expressed by the different respondents (mentioned twenty four times). At the first look, it is the poor performance of the seller that can explain brand hate (bad service, poor information and device), but when analyzing a little more profoundly through the interviewees' discourse we can find that the seller attitude is also linked to the consumer undesired self concept.

- *Seller impact on brand performance:* Seller is usually considered as a part of the company performance as it presents a service that is directly tied to the organization. Poor seller performance can sometimes be detrimental to the company's success. *"one of my colleague was very badly welcomed by the Tunisie Telecom company employee, first of all he cursed the telecom operator and swear that he will never fall for whatever they offer"* (male, 38 years, Tunisie Telecom). The participant described how the poor performance of the sales force is associated directly with the whole company's performance as sellers may sometimes be the only direct contact with the company.-
- *Seller impact on self image:* interacting with sellers has its impact on how the consumer perceives himself *"... and I could see from the seller's attitude that he was not pleased with that fifty years old man who, from his point of view won't understand anything. He didn't even explain me, I felt very uncomfortable, the seller looked at me like if I was not in my place, like if I am too old to learn anything about technology, I saw boredom in his eyes..I felt so down and sad(...).I hated Ooredoo from that day on!"* (male, 55 years, Ooredoo,). This quote illustrates how sales' person's bad service may impact, not only, the whole performance of the company, but may also impact the consumer self image.

#### ***Outcomes of brand hate***

When consumers feel dissatisfied by the brand, they can either exit the relationship with the brand or they can voice their dissatisfaction (Hirshman, 1970). Through our analysis, several consequences of brand hate are identified corresponding to different faces of "exit" or "voice"

##### ***Boycott***

Boycott is defined as "an attempt by one or more parties to achieve certain objectives by urging individual consumers to refrain from making selected purchases in the market place (Friedman 1985, p. 97). When boycotting a product the consumer backs off from purchasing a certain item because of an ideological discontent with the organization or country. (Friedman, 1985; Hirschman, 1970). The following quote illustrates this behavior *"Yes definitely, back to the days I decided to boycott it. I felt like*

*they have changed the name of "Tunisiana" to show us that they own us, might be nothing but I hated it really"*(women, 51years, Ooredoo). The interviewee talked about a boycott movement that took place when the telecommunication company switched the name of Tunisiana to Ooredoo.(Smaoui and Smiri, 2016).

#### *Brand avoidance*

Brand avoidance was the most common reaction to brand hate throughout this study. According to McCullough et al.(1998) brand avoidance is defined as individuals need to cut themselves from any relationship with that brand. Interestingly in most of the interviews brand avoidance came with holding grudge and for a long period *"... I didn't come back to the Ooredoo store indeed and I won't, I think I am avoiding it without even noticing. So for now, given that I am not a client anymore, I make sure that everyone knows how bad it is, and I don't miss an opportunity to let people know about how a scam it is and to advice them to go shop somewhere else"* (female, 51 years, Ooredoo). As could be seen in the quote, brand avoidance can be accompanied with negative word of mouth or with complaining.

#### *Negative word of mouth*

Negative word of mouth occur when consumers have a bad experience with a brand and share it with their circle of friends and family in order to devaluate the brand and to make others reevaluate their relationship with the brand (Grégoire and Fisher, 2008; Grégoire et al., 2009). Many respondents expressed their tendency to talk about their bad experience with the brand and recommended people not to buy this brand.

#### *Complaining*

Complaining is a usual behavior when a customer is dissatisfied with the brand. Our findings show that brand hate can lead to complaint behavior: *"So needless to say that I didn't kept silent and I went to his boss who forced him to apologize. I didn't miss the chance to talk badly about my experience in details"* (male, 55 years, Mouradi Hotel). Most of the complainers said that they used private complaining to voice their dissatisfaction, meaning that they did complain to the retailer or to the service provider. Nonetheless, complaining online is also evoked by certain interviewees, namely through the social media Facebook, which is very influential in Tunisia. One interviewee even regretted not having a Facebook account to complain about a brand she hated.

## **CONCLUSION**

Throughout this study we aimed to explore the brand hate in an emerging country context, its meaning, its manifestation, its antecedent and consequences. Results were quite interesting and some of them came as a backup of the literature. Findings suggest that brand hate is experienced and expressed by respondents. Hate may be expressed verbally or/and through body language which

furthermore illustrate the intensity of this emotion. Brand hate was found to be distinct and more powerful than other emotions and attitudes like brand dislike, brand avoidance (Lee et al., 2009), consumer resistance (Penaloza and Price, 1993) or anti-branding attitude (Kucuk, S. U., and Krishnamurthy, 2007). Brand love may turn into brand hate, as suggested by Grégoire et al. (2009), in fact extreme intense emotions toward brands can constitute the two sides of the same coin, loyal customers have high expectation of their loved brand, once those expectations are not met disappointment and hate may occur.

Brand hate can be the consequence of four main factors, utilitarian factors, identity factors, cultural and moral factors and the sellers' attitude and behavior. Utilitarian factors, in opposition to symbolic ones can lead to brand hate (poor performance, poor aesthetic and poor value exchange). More interesting findings concern cultural and moral factors. Some respondents expressed anti-consumption and consumer resistance attitudes leading to brand hate, while others evoke some cultural reasons like religious values, country of origin animosity or preference for non local western brands. Such symbolic factors are particularly interesting in the present context. Some of the findings are in line with emerging countries brand literature that suggests that country of origin has an important effect on consumer behavior, that consumers tend to prefer non local brands (Touzani et al., 2015 ; Batra et al., 2000) and that religiosity is an important antecedent to many of Muslims consumer behaviors (Amin et al, 2014). Some other findings are surprising, namely the anti-consumption factor. Indeed, mass consumption is seen as normal and even appreciated in emerging markets, as it is associated with western lifestyle. Some studies mention the desire of emerging countries' consumers to imitate western lifestyle through consumption and the desire to participate into the international community of consumption (Batra et al., 2000; Saffu and Walker, 2006). Our results show that anti consumption attitudes exist and may even lead to brand hate in this context. Identity factors related to the self concept and social status are identified also as important symbolic brand hate antecedents. Findings indicate that respondents tend to hate brands that are associated to negative self reference groups, or that is associated with an undesired self (Lee et al., 2009). Social status is particularly important in emerging countries (Ustuner and Holt, 2010) and brand represents a significant social marker. In his quest for social statute as was found in our results, consumers may reject and even hate brands that he sees as a threat to his desired social statute

Seller's attitude and behavior represent a surprising key factor behind brand hate as it was not mentioned before as a primordial reason behind brand hate in the emerging brand hate literature. It represents a significant contribution of this research. Finally, finding shows that four behaviors can be engendered by brand hate: complaining, boycott, negative word of mouth, avoidance and rejection,

.This came as a support to the marketing literature (Alba and Lutz, 2013; Bryson *et al.*, 2013; Gregoire *et al.*, 2009; Johnson *et al.*, 2011).

In terms of managerial implication it is interesting to understand why a consumer may feel such an intense and negative emotion toward the brand. Identifying the factors behind hate help managers build strategies and put tactics in order to help preventing the damages that can be caused to the company due to brand hate. The most important managerial implication that companies in the Tunisian context should pay attention to is sellers' behavior. Tunisian companies should focus on seller's training and motivation to deliver a professional and respectful behavior. In addition managers should pay close attention to the main group that their company is targeting in order to avoid any association with a negative reference group and to prevent any confusion with the targeted group.

## REFERENCES

- Alba, J. W., & Lutz, R. J. (2013), "Broadening (and narrowing) the scope of brand relationships," *Journal of Consumer Psychology*, 23(2), 65-68.
- Amin, H., Abdul-Rahman, A. R., & Abdul Razak, D. (2014). Theory of Islamic consumer behaviour: An empirical study of consumer behaviour of Islamic mortgage in Malaysia. *Journal of Islamic Marketing*, 5(2), 273-301.
- Bagozzi, R. P., Gopinath, M., & Nyer, P. U. (1999). The role of emotions in marketing. *Journal of the academy of marketing science*, 27(2), 184-206.
- Batra, R., Ramaswamy, V., Alden, D. L., Steenkamp, J. B. E., & Ramachander, S. (2000). Effects of brand local and nonlocal origin on consumer attitudes in developing countries. *Journal of consumer psychology*, 9(2), 83-95.
- Belk, R. W.; Ger, L.; Askegaard, S. (2003). The Fire of Desire: A Multisited Inquiry into Consumer Passion *Journal of Consumer Research*, 30(3), 326-351.
- Ben-Ze'ev A. (2000). *The subtlety of emotions*. Cambridge, MA, US: The MIT Press
- Bryson, D., Atwal, G. and Hulten, P. (2013). Towards the conceptualization of the antecedents of extreme negative affect towards luxury brands. *Qualitative Market Research: An International Journal*, 16(4), 393- 405.
- Burgess S.M., Steenkamp J. B. E. M., (2006). Marketing renaissance: How research in emerging markets advances marketing science and practice. *International Journal of Research in Marketing*, 23(4), 337-356.
- Carroll, B.A. & Ahuvia(2006). Some antecedents and outcomes of brand love. *Marketing Letter*, 17(2), 79-89.
- Chaudhuri, A. & Holbrook, M. B. (2001). The Chain of Effects from Brand Trust and Brand Affect to Brand Performance: The Role of Brand Loyalty. *Journal of Marketing*, 65(2), 81-93.
- Cromie, J. G., & Ewing, M. T. (2009). The rejection of brand hegemony. *Journal of Business Research*, 62(2), 218-230.
- Dalli, D., Romani, S. & Gistri, G. (2006). Brand Dislike: Representing the Negative Side of Consumer Preferences. *Advances in Consumer Research*, 33, 87-95.
- Dittmar, H., & Pepper, L. (1992). Materialistic values, relative wealth and person perception: Social psychological belief systems of adolescents from different socio-economic backgrounds. *SV-Meaning, Measure, and Morality of Materialism*.
- Escalas, J. E. & Bettman, J. R. (2013). Self-Constructual, Reference Groups, and Brand Meaning. *Journal of Consumer Research*, 32(3), 378-389.
- Fournier, S. (1998). Consumers and their brands: Developing relationship theory in consumer research. *Journal of consumer research*, 24(4), 343-373.
- Gardner, W. L., Avolio, B. J., Luthans, F., May, D. R., & Walumbwa, F. (2005). Can you see the real me? A self-based model of authentic leader and follower development. *The Leadership Quarterly*, 16(3), 343-372.
- Grégoire, Y., and Fisher, R. J. (2008). Customer betrayal and retaliation: when your best customers become your worst enemies. *Journal of the Academy of Marketing Science*, 36(2), 247-261.
- Grégoire, Y., Tripp, T. M. & Legoux, R. (2009). When Customer Love Turns into Lasting Hate: The Effects of Relationship Strength and Time on Customer Revenge and Avoidance. *Journal of Marketing*, 73(6), 18-32.

- Grubb, E. L. & Grathwohl, H. L. (1967). Consumer Self-Concept, Symbolism and Market Behavior: A Theoretical Approach. *Journal of Marketing*, 31, 22-27.
- Hirschman, A. O. (1970), *Exit, Voice, and Loyalty: Responses to Decline in Firms, Organizations, and States*, Cambridge, MA: Harvard University Press
- Iyer, R., & Muncy, J. A. (2009). Purpose and object of anti-consumption. *Journal of Business Research*, 62(2), 160–168.
- Jenkins, R. (2014). *Social identity*. Routledge.
- Johnson, A. R., Matear, M. & Thomson, M. (2011), A coal in the heart: self-relevance as a post-exit predictor of consumer anti-brand actions, *Journal of Consumer Research*, Vol.38(1), 108-125.
- Kähr, A., Nyffenegger, B., Krohmer, H. & Hoyer, W. D. (2016). When hostile consumers wreak havoc on your brand: The phenomenon of consumer brand sabotage. *Journal of Marketing*, 80(3), 25-41.
- Klein, J. G., Smith, N. C., & John, A. (2004). Why we boycott: Consumer motivations for boycott participation. *Journal of Marketing*, 68(3), 92-109.
- Klein, N. (2000). *No logo: Taking aim at the brand Bu fillies*. London: Flamingo.
- Krippendorff, K. (2012). *Content analysis: An introduction to its methodology*. Sage.
- Krishnamurthy, S. and Kucuk, S. U. (2009). Anti-branding on the internet. *Journal of Business Research*, 62 (11), 1119-1126.
- Kucuk, S. U. (2007). Negative double jeopardy: The role of anti-brand sites on the internet. *Journal of Brand Management*, 15(3), 209–222.
- Kucuk, S. U., & Krishnamurthy, S. (2007). An analysis of consumer power on the Internet. *Technovation*, 27(1), 47-56.
- Lee, M. S. W., Motion. & Conroy, D. (2009). Anti-consumption and brand avoidance. *Journal of Business Research*, 62(2), 169–180.
- Mai, L. W., & Conti, P. G. (2007). Dissolution of a person-brand relationship: an understanding of brand-detachment. *E-European Advances in Consumer Research*, Volume 8, eds. Stefania Borghini, Mary Ann McGrath, and Cele Otnes, Duluth, MN : Association for Consumer Research, Pages: 421-430.
- Penaloza, L., & Price, L. L. (1993). Consumer resistance: a conceptual overview. *NA-Advances in Consumer Research* Volume 20.
- Rempel, J. K., & Burris, C. T. (2005). Let me count the ways: An integrative theory of love and hate. *Personal Relationships*, 12(2), 297-313.
- Romani, S., Grappi, S. and Dalli, D. (2012). Emotions that drive consumers away from brands: Measuring negative emotions toward brands and their behavioral effects. *International Journal of Research in Marketing*, 29(1), 55–67.
- Saffu, K., & Walker, J. (2006). The Country-of-Origin Effect and Consumer Attitudes to “Buy Local” Campaign: The Ghanaian Case. *Journal of African business*, 7(1-2), 183-199.
- Sirgy, M. J. (1982). Self-concept in consumer behavior: A critical review. *Journal of consumer research*, 9(3), 287-300.
- Smaoui F. & Tmessek-Behi, A. (2011) « Brand-engagement versus brand attachment, which boundaries ?», *Micro & Macro Marketing*, 20(2), Augusto, 255-272.
- Smaoui F. & Smiri S. (2016), *Le boycott en réaction à la stratégie de rebranding: étude netnographique Le cas Tunisiana – Ooredoo*, Proceedings of the Marketing Spring Colloquy Unit of Research & Applications in Marketing (URAM) Volume: 7. May, 2016, 146-165.
- Sproles, G. & Kendall, E. (1986), “A methodology for profiling consumers’ decision making styles”, *Journal of Consumer Affairs*, 20 (2), 267-79.
- Stake, R. E. (2010). *Qualitative research: Studying how things work*. Guilford Press.
- Touzani, M., Smaoui, F. & Labidi, M. M. (2015). Country-of-origin and emerging countries: revisiting a complex relationship. *Qualitative Market Research: An International Journal*, 18(1), 48 – 68.
- Ustuner, T. and Holt, D.B. (2010), “Toward a theory of status consumption in less industrialized countries”, *Journal of Consumer Research*, 37(1), 37-56.
- White, K., & Dahl, D. W. (2006). To be or not be? The influence of dissociative reference groups on consumer preferences. *Journal of Consumer Psychology*, 16(4), 404-414.
- Wolter, S. J., Brach, S., Jr, J. C & Bonn, M. (2015). Symbolic drivers of consumer-brand identification and disidentification. *Journal of Business Research*, 69(2), 785-793.
- Zarantonello L., Romani S., Grappi S., & Bagozzi R. (2016). Brand hate. *Journal of Product & Brand Management*, 25(1), 11-25.



Zeelenberg, M., & Pieters, R. (2006), Feeling is for doing: A pragmatic approach to the study of emotions in economic behavior. In D. De Cremer, M. Zeelenberg & J. K. Murnighan (Eds.), *Social psychology and economics* (pp. 117–137).

## COST DEPLOYMENT IMPLEMENTATION: A CASE STUDY

Giovando, Guido; Crovini, Chiara; Venturini, Stefano

Department of Management, University of Turin, Turin, Italy

### ABSTRACT

The paper deals with modern managerial and accounting tools and specifically with cost deployment, a key pillar into the World Class Manufacturing programme designed by FCA. After presenting a Literature review on the topics of World Class Manufacturing, Managerial accounting and Cost Deployment, which addressed this study, the work sets methodological framework of research, underlining the gaps in the current Literature, which provides few evidences of the actual results and benefits of a cost deployment system.

The research was conducted through a case study presenting the implementation of a cost deployment system into a large manufacturing firm in the North-West of Italy, analysed through the steps suggested by FCA.

Data collection was carried out in collaboration with the operations controller of the plant. Several semi-structured interviews provided more evidences to support conclusions.

This company was chosen because the implementation of the cost deployment tool was on an early stage, this made possible to follow-up the entire process.

The present research helps understand the effectiveness of this tool, which supports manufacturing firms in reaching higher levels of quality, output and overall efficiency in their production systems.

In addition, the paper gives evidence of the benefits tracked by controlling thanks to the System even at an early stage of development and underlines the major differences with the theoretical framework set in previous studies.

*Keywords: Cost Deployment, World Class Manufacturing, Management Accounting, Cost Accounting, Case Study*

### INTRODUCTION

Historically manufacturing companies have striven in order to achieve a competitive advantage either reducing costs or having different products from competitors.

Ford's assembly line marked a crucial step toward a more efficient industry model from the British one of the late Nineteenth Century and helped America gaining a Manufacturing hegemony that lasted more than 60 years.

The USA lost their leadership during the Eighties though, due to lack of innovation in their production systems and to a more challenging economic scenario.

As a matter of fact, Japanese Manufacturing model gained popularity during the second half of the twentieth Century: many studies pointed out how Japanese producers had been able to reduce costs, increase efficiency of their equipment and have less quality defects at the same time.

As the secret of Japanese success was unveiled, western manufacturers began to adopt those production techniques that, by the end of the Eighties, were gathered together under the phrase “World Class Manufacturing”, meaning the achievement of a state-of-art level both in logistic and productive cycles.

Nowadays lots of different companies adopted and customized World Class production models introducing different tools, reporting standards and best practices: FCA introduced its own Production System in the early 2000s, comprehensive of a specific “Cost Deployment” practice.

This tool was developed alongside a Japanese guru on the matter and aims to link the plant efficiency and quality performances to transformation costs, identifying wastes and losses.

Moreover, Cost Deployment developed by FCA provides tools to set priorities in choosing the improvement projects into the plant, based on a benefit-loss analysis and on the economic return calculation.

Finance and controlling area become the engine of the improvement helping the management into its decision process.

The Company chosen for the case study is part of a large American conglomerate and produces brake pads in its Italian plant.

In 2014 the new Management decided to adopt the World Class Manufacturing Programme developed by FCA. In the following period the first activities related to the Improvement programme began and in late 2015 a first cost deployment edition was prepared as well.

The paper focuses on this company as the Cost Deployment method was at very early stage of development and it was possible to observe a proper implementation through all its steps.

Focusing on such an early stage helped the research understanding what the main implications of the tool are and how the organization responded to the new system.

At the same time this allowed to provide a judgement on the results brought by Cost Deployment pillar.

The research presents some limits: first of all, it represents a single case study and the generalisation of results should be further tested by comparing this case with other companies.

Furthermore, this first step might be useful to build a more complete theoretical framework on the topic.

The remainder of the study is organised as follows: in paragraph 1 a brief literature review is presented, in section 2 methodology and research design are described, paragraph 3 instead presents findings, while comments and discussion follow that section and finally the conclusions are presented.

## 1. LITERATURE REVIEW

“World Class Manufacturing” phrase was coined by several authors referring to the set of practices in operations management that could lead any manufacturer to an excellence level (Hayes and Wheelwright, 1984; Schonberger, 1982, 1986). Many of these practices were adopted from Japanese manufacturers who originally developed them.

Starting from those studies, others discussed the possibility to achieve simultaneously different competitive advantages through the adoption of World Class Manufacturing Flynn (1996; 1999).

On the other hand, Womack et al. (1990) depicted birth and rise of the Toyota Production System (TPS) and studied the reasons behind its success. Yamashina (1995; 1996) focused on a peculiar aspect of Japanese manufacturing strategies, total productive maintenance.

As FCA decided to develop its own World Class Manufacturing programme, many researchers studied it during the last decade: for example (De Felice et al. 2013) focused on a concrete case study in one of FCA’s plants; Chiarini and Vagnoni (2014) tried to make comparisons between the Fiat Auto Production System and TPS highlighting similarities and major differences. They underlined the innovation of fully developed set of managerial practices that allow to involve the entire organization.

Cipriani et al. (2014) investigated the impact of the introduction of a World Class Manufacturing programme in terms of cultural changes inside the company. At the same time, they carried out a survey involving the plant workforce.

Several researchers dealt with the topics of cost accounting and management accounting investigating the birth and the evolution of these matters (Scott, 1931; Littleton, 1933; Garner, 1954).

Armstrong and Hopper (1991) offer an interesting analysis concerning the role of labour cost in the development of management accounting systems.

Moving forward, Johnson (1981) underlined new emerging tools in cost and managerial accounting such as Activity Based Costing and Balanced Scorecard.

Chan (1993) provided evidences of Activity based Costing describing the implementation of an ABC system into a context other to manufacturing as a hospital.

Despite these new methods developed by companies and researchers, Johnson and Kaplan (1987) highlighted how managerial accounting lost its relevance and Cooper and Kaplan (1988) argued that cost accounting could potentially provide misleading results.

Kaplan (1984:1; 1984:2) argued that Managerial accounting systems should have gone towards a better understanding and representation of Manufacturing performance. In this sense, Jazayeri and Hopper (1999) provided a case study about the relationship of the Management Accounting system and a World Class Manufacturing programme.

Yamashina (2000) highlighted a rather similar concept and first introduced a new method named “Manufacturing Cost deployment” in order to achieve a better measurement of operations performance (Yamashina and Kubo, 1999; 2002).

Their method embraces the typically Japanese concept of continuous improvement; it does not only help managers to identify costs associated to losses and wastes but it also provides rational criteria to choose new investments in the plant. In this sense, also Vikram et al. (2015) underline the benefits that a lean strategy can bring to an organization.

Cost deployment became a breakthrough and several companies adopted it: FCA decided to customize its own system into a general World Class manufacturing framework (IlSole24Ore, 2010).

Silva et al., (2013) studied FCA’s cost deployment system; Garbe and Olausson (2014) provided a similar case study based on a plant of Volvo group.

Kirkham et al. (2014) investigated how companies assess and choose the improvement projects in relation to their size.

Recently, Postec  and Zapciu (2015) discussed a method implemented to reduce the potential losses of new products already during the development phase. Their method shares many similarities with cost deployment techniques.

Moreover, Carmignani (2017) showed an application Cost Deployment as part of a “Scrap Value Stream Mapping” process.

This research fits into this framework and, in particular, it focuses on providing tangible results of an early developed cost deployment system, which is also described in its implementation.

## 2. METHODOLOGY

### *Research design*

The case study describes the implementation of cost deployment inside a large manufacturing plant in the North-West of Italy. The plant is a part of the Italian branch of an American conglomerate since the eighties. The core business of the plant is the production of brake pads. Around 700 workers are involved in operations and the productions of brake pads.

The choice was made because one of the authors had the opportunity to spend several months in the plant alongside the controller: this represented the starting point of our analyses, this topic will be carried over comparing the findings of this paper to results of different companies, firms and plants.

In addition, the choice is motivated by the fact that cost deployment was on an early stage of development.

The case study was built analyzing different areas of the company and their involvement in implementing cost deployment pillar.

This was necessary as many areas take part in the cost deployment system although the controlling area had a preeminent role due the knowledge of financial items.

Given these premises, data were collected interviewing managers and directors from operations, maintenance, quality, technologies and logistic areas. In addition, a collaboration was established with the controlling manager of the plant who was in charge of the cost deployment pillar. This helped understanding and following up the entire process. By the end of the research period it was possible to observe the output of the system implemented.

#### *Data collection and procedure*

The case study was conducted over a period of nine months from June 2016 to February 2017. During this time, semi-structured interviews of an open-ended nature represented the main method of the research.

Many departments of the plant were involved in the research as they were collaborating with the industrial controller in order to implement a cost deployment edition.

At the same time the continuous collaboration with the plant controller made possible to carry over an in-depth analysis on the procedures and tools adopted by the method.

Main goals of the present case study are to understand how the cost deployment method is implemented and what are the main results over the period, assuming that differences from the model developed in the early 2000s may emerge.

Moreover, the study aims to formulate research questions by problematizing some dominant assumptions in existing research (Davis, 1971). In particular, the main research questions are the following:

- *Research question 1:* how is a cost deployment implemented in an actual plant and what are the main differences compared to the theoretical framework set by Yamashina (2002)?
- *Research question 2:* what are the main short-term results and the main critical aspects?

This approach would support a more reflective-scholarly attitude (Abbott, 2004) and consider a different epistemological approach.

In this case the epistemological approach is that of induction because it finally helps reach a verdict and elaborate a theory that derives from a number of testable consequences that have been verified.

The focus was set on this topic because few authors until now studied the results that a proper cost deployment system can bring even in short term. Silva et al. (2013), for example provided an example of the implementation process but they did not examine the actual benefits in terms of cost reduction.

### 3. FINDINGS

The interviews carried out through the entire organization and the continuous collaboration with the industrial controller helped understanding how the entire cost deployment process was implemented in the plant.

First, it is necessary to underline that cost deployment is part of a larger programme called “Fiat Auto Production System” which requires the adoption of a set of methodologies to reach a “World Class” level in manufacturing.

Twenty pillars compose the entire programme, divided into ten defined as technical and ten defined “managerial”.

The ten technical pillars are:

- Safety – which aims to enhance the safety and hygiene level in the plant in order to reduce work related injuries;
- Cost Deployment – a proper tool to understand the economic value of wastes and losses in the production process and to reduce them;
- Focused Improvement – which attacks wastes and losses starting from the analyses carried out by cost deployment pillar;
- Autonomous Activities (split into Workplace organization and Autonomous Maintenance) – which aim to reduce productive cycles through a more ergonomic workplace and reduce breakdowns thanks to activities carried out by operators;
- Professional Maintenance – its first goal is to prevent breakdowns and take them to level zero;
- Quality Control – which aims to reduce quality defects;
- Logistics and Customer service – a set of practices to reduce the working capital and optimize the logistic flow;
- Early equipment and Product Management – which aims to integrate the design of products, equipment and assembly lines inside the plant;
- People Development – its main goals are to allocate human resources and manage know-how inside the company;
- Environment.

The ten managerial pillar are: Management Commitment; Clarity of Objectives; Route Map to WCM; Allocation of Highly qualified people to Model Area; Commitment of the organization; Competence of

Organization towards improvement; Time and Budget; Level of detail; Level of Expansion and Motivation of operators.

These managerial pillars have a key role in involving the entire organizations, from the the top management to shop floor and clarifying the objectives that everyone in the plant has to achieve.

On the other hand, each technical pillar has peculiar tools and practices to accomplish its tasks. Moreover, seven phases of implementation – defined as steps – compose every pillar.

As figure 1 shows, the steps are divided into reactive, preventive and proactive: as more experience is acquired by the organization, more detailed actions can be undertaken to prevent wastes and losses.

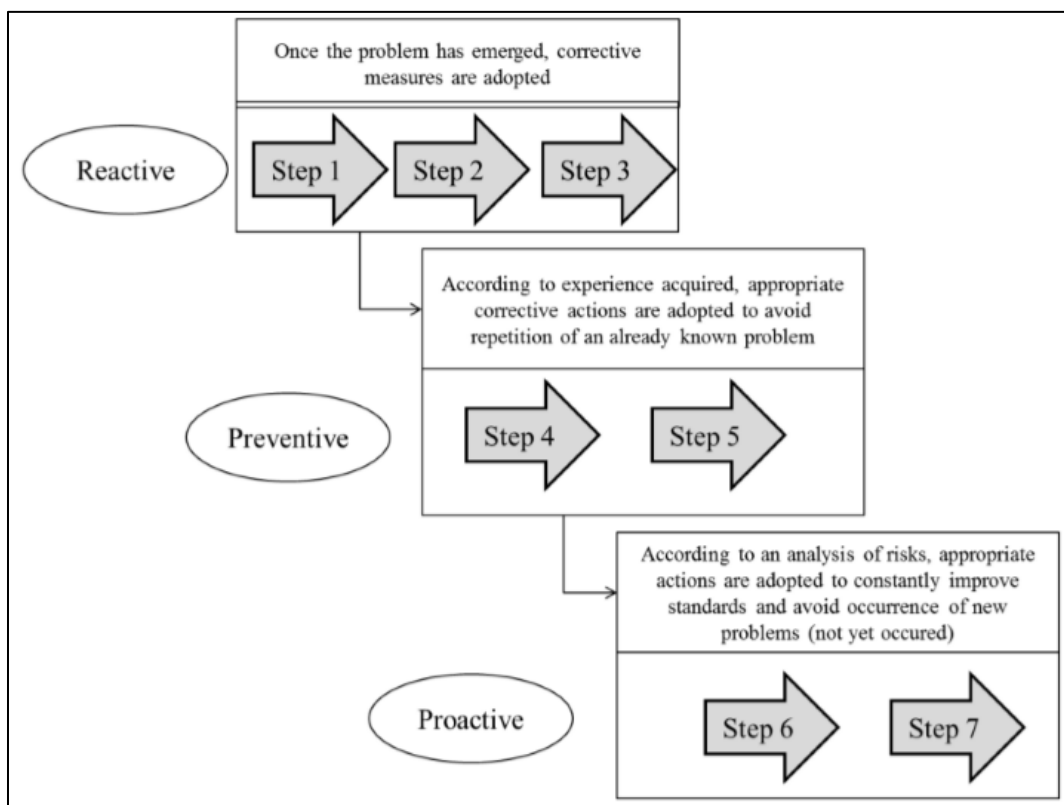

**Figure 1. The seven steps of the Technical Pillars. Source: De Felice et al. (2013)**

Cost Deployment – as formalised by FCA – makes no exception and follows the same path of implementation of the other pillars through those seven steps. A matrix is prepared as output of (almost) each step.

The FCA method presents many similarities with the method first implemented by Yamashina and Kubo (2002), and some new peculiar features.

Hereafter this section deals with implementation of the method undertaken to understand which part of the costs in the plant are associated to wastes and losses.



A key success factor for an accurate cost deployment is an exhaustive data collection that forms the data base for all the analyses. We had the opportunity to understand how data collection is carried out in the plant:

- Efficiency losses on machinery and equipment are collected in real time thanks to the information system linked to machineries and equipment;
- Scraps are registered automatically from the machines (presses, grinding machines...) but the causal attribution (i.e. the reason of the scrap) is done by operators at the end of each shift;
- Breakdowns are registered at the end of every shift, in addition to that Emergency Work Orders (so-called EWOs) are filled in describing all the breakdowns;
- Not added value activities are estimated by the technical department;
- Energy losses are measured on the model areas;
- Absenteeism and labour defections are register by Human resources department.

The first step of cost deployment requires the definition of the transformation cost, i.e. the costs associated to modifications of the product in the assembly line.

Consequently, the transformation cost includes direct labour, part of the indirect labour (e.g. maintenance engineers), some variable overheads (e.g. utilities), some fixed overheads.

On the other hand, other costs are excluded: for example, the cost of direct material, the administrative and general expenses.

Thanks to this first step, the cost deployment pillar is able to understand which part of the total costs in the plant contributed to the productive process and create added value: about 25% of the total costs in the plant was included into the WCM perimeter. The remainder (excluded) were mostly due to direct material and Administrative expenses.

As the transformation cost is defined the pillar can move on: the second step required the construction of the "A-matrix" and a first analysis on the losses inside the plant.

More in detail, the A-matrix represents the allocation and the severity of those losses in the plant.

In fact, the A-matrix is fulfilled twice: first of all it is given an assessment about the severity of the losses (so-called "A-matrix" quality), then it is calculated the occurrence of the same losses in the assembly line thanks to data collection (so-called "A-matrix" quantity).

After this step, the organization becomes aware of the places where most of the losses occurred and which were the worst: in particular breakdowns, quality defects and scraps revealed to occur more often.

So, it was possible to prepare the third step and the B-matrix which allows to study the relation between causal and resultant losses, i.e. how a loss can influence the rest of the production process and cause more losses in terms of production delays, scraps and so on.

At this stage, losses analyses are complete and it is possible to start the attribution of a cost element to each of these losses.

Therefore, the fourth step began and the C-matrix was prepared. Starting from the results of the previous steps it had been possible to link resultant losses to the respective causal losses.

After that, thanks to the elaboration of cost drivers and more in-depth analyses, it was possible to transform each loss into a cost.

The output of this step is a matrix that allows to understand how much of the transformation cost is lost or wasted. The amount individuated was about 45%.

Most of the losses inside the plant were due to breakdowns (27% of the total), not-value added activities (23%), quality defects (16%).

Thanks to a detailed data collection the C-Matrix reveals the allocation of the losses regarded as costs:

- On every single line;
- On every machine;
- divided by type.

This step represents the foundation of the following analyses and gives a first glance at the prioritization of measures and projects applicable to reduce losses and gain efficiency.

The fifth step requires to develop the so-called "D-Matrix". This tool utilizes the loss stratification as a starting point to define the projects and to set priority level.

Causal losses from C-Matrix are analyzed and related to the possible tools to eliminate them, to the KPIs that are going to improve thanks to the projects and to the easiness of each project.

These are then summarized by an ICE (Impact-Cost-Easiness) analysis. Every project received a score based on:

- the impact it potentially had in terms of loss reduction (cost savings);
- the cost – or the investment – of the project itself (e.g. an improvement project may need new tooling);
- the easiness of the implementation of the project itself.

This ICE analysis stands in line with what observed by Kirkham et al. (2014) about large manufacturing firms and the methods to set priorities of interventions.

When D-Matrix was completed, it identified enough projects to reduce by 9,4% the entire transformation cost through loss reductions.

As mentioned the plant had by that moment a proper priority level to undertake losses reduction actions in an economically sound logic.

Moving on to step six, E-Matrix is prepared. This matrix is filled in with the projects actually implemented in the plant during the period.

Project cards are prepared to keep track of the several projects started during the year. Every project is linked to its project card, which contained information about:

- the type of project and its progress (thanks to the PDCA cycle);
- the type of loss attacked and the related KPIs;
- the authorizations of the plant director and the plant controller.

The project card mechanism allows controlling area to keep all the projects under control and to prepare a first forecast of the yearly savings.

More than one hundred projects were carried on during the period and the (yearly) saving forecast was set at 8% of the transformation cost.

The remainder step concluded the cost deployment process. The last two matrices (F-matrix and G-matrix) compose step number seven.

F-matrix collected all the savings coming from the projects started and concluded: again, project cards flow revealed useful to estimate those savings.

The controller could check monthly the status of every project undertaken (Plan-Do-Check-Act) and certify the savings calculated from the KPIs associated.

In fact, once the savings were certified by controlling area, they were entered in the F-matrix.

By the end of the year, F-matrix covered 7,8% of the transformation cost.

The second matrix of step seven represents the budget for the forthcoming year. It collected different types of saving, specifically coming from:

- carryover of project that are meant to last over the year;
- expansions and extensions of on-going projects in different areas and replicable in others;
- new projects that aim to reduce losses not yet attacked.

The savings expected for the coming period were about 8,3% of the transformation cost.

The cost deployment process does not stop after the loop is completed, but starts again to investigate more in-depth costs trying to individuate on hidden wastes and losses.

This activity requires more detailed data collection, analyses and collaboration from every part of the organization.

Usually the cost deployment pillar re-starts from the fourth step, editing C-matrix and so on. Some of the matrices, e.g. E-matrix and F-matrix, are updated monthly.

#### **4. CRITICAL COMMENTS AND DISCUSSION**

As showed by Silva et al. (2013), the implementation took place through the seven steps: each step gave as output a quantitative analysis of the data collected and elaborated.

The process showed some peculiarities compared to the conceptual framework designed by Yamashina and Kubo (2002): the implementation of step 6 and step 7 allows to track actual savings and make forecasts for the periods to come.

In this sense, the method observed in the case study, showed some improvements compared to the one described by Garbe and Olausson (2014) too, as G-Matrix was implemented.

Cost deployment revealed to be a useful tool in the plant.

The main advantages of this method are:

- a more effective and conscious control of the cost items related to the productive process;
- an involvement of the controlling area which is forced to pay more attention to all the departments (and pillars) involved in World Class manufacturing programme;
- the economically driven choices of the projects through the cost-benefit analysis;
- a continuous control over the improvement projects carried out in the plant and a better calculation of the savings.

As showed in Findings, the benefits from projects implemented thanks to priorities given by cost deployment in an economic sound logic were consistent.

In addition to those cost benefits, Cost Deployment can make all operators more aware of the impact they have on the productive process. Giving cost values to losses registered magnifies every reduction in terms of breakdowns, scraps and so on, helping them to understand that they are giving a tangible contribution.

A key success factor is, therefore, the involvement of the organizations: the case study supports findings by Cipriani et al. (2014). WCM pillars are often underestimated by many figures in the organization at an initial stage of development.

This revealed to be one the most critical aspect of the implementation, as many workers did not understand the importance of the methodology.

## 5. CONCLUSIONS

The research involved an in-depth study of cost deployment implementation in a large manufacturing plant: the paper presented the characteristics of the World Class Manufacturing programme that includes it, described the process through its steps and observed the results.

Findings underline differences between the method adopted by the company observed – in line with the implementation described by Silva et al. (2013) –: the theoretical framework set by Yamashina (2002) had been updated and enriched with new tools to choose rationally the improvement projects and keep them under control.

The methodology can be adopted by manufacturing firms willing to improve their understanding of cost dynamics inside the plant and to identify more clearly waste and losses.

In recent years indeed cost deployment practices improved, allowing remarkable results in terms of cost benefits, as the paper proves.

This last element helps underline the limitations for the present study. First of all, it focuses only on one specific plant: further analyses will be conducted in the future, by comparing this case with other firms.

In addition, empirical results might help elaborate a new conceptual and theoretical framework that might have important practical implications for managers and entrepreneurs.

Researchers and academics may also find interesting elements to develop and further the study on the topic.

## REFERENCES

- Abbott, A. (2004). *Methods of Discovery: Heuristics for the Social Sciences*. New York: W.W. Norton
- Blackburn, R. and Kovalainen, A. (2009). Researching small firms and entrepreneurship: Past, present and future. *International Journal of Management Reviews*, 11(2), 127–148.
- Carmignani, G. (2017). Scrap Value Stream Mapping (S-VSM): a new approach to improve the supply scrap management process. *International Journal of Production Research*, 55 (12), <http://dx.doi.org/10.1080/00207543.2017.1308574>
- Chan, Y.-C. L., (1993). Improving Hospital Cost Accounting with Activity-Based Costing. *Health Care Management Review*, 18(1), 71-78.
- Chiarini, A. and Vagnoni, E. (2014). World Class Manufacturing by Fiat. Comparison with Toyota Production System from a Strategic Management, Management Accounting, Operations Management and Performance Measurement Dimension. *International Journal of Production Issues*, 37(4).
- Cipriani, A., Eirlicher, L., Neirotti, P., Pero, L., Campagna, L. (2014). L'Evoluzione dei Sistemi di Produzione e dell'Organizzazione del Lavoro nelle Fabbriche: l'Applicazione del World Class Manufacturing in FIAT, <http://www.mirafiori-accordielotte.org/wp-content/uploads/2015/02/15-rapporto-intermedio-Paper-AiIG-2014.pdf> (Last access 4th June 2017)
- Cooper, R. and Kaplan, R. H., (1988). How Cost Accounting Distorts Product Cost. *Management Accounting*, 69(10), 20-27.
- Davis, M. S. (1971). That's interesting! Towards a phenomenology of sociology and a sociology of phenomenology. *Philosophy of Social Sciences*, 1, 309–44.
- De Felice, F., Petrillo, A. and Monfreda, S., 2013. Improving Operations Performance with World Class Manufacturing Technique: a Case in Automotive Industry. *Operations Management InTech*, 1-28.
- Flynn, J. E. and Flynn, B. B. (1996). Achieving Simultaneous Cost and Differentiation Advantages Through Continuous Improvement: World Class Manufacturing as a Competitive Strategy. *Journal of Managerial Issues*, 8(3), 360-379.
- Flynn, B. B., Schroeder, R. G. and Flynn, J. E., (1999). World Class Manufacturing: an Investigation on Hayes and Wheelwright's Foundation. *Journal of Operations Management*, 17(3), 249-269.
- Garbe, M. & Olausson, R. (2014). *Evaluation of Manufacturing Cost Models – An Evaluation of Manufacturing Cost Model for an Assembly Line and an Evaluation of a Data Collection Method*. Lund: Lund University.
- Garner, S. P., 1954. *Evolution of Cost Accounting to 1925*. Alabama: University of Alabama Press.
- Hayes, R. and Wheelwright, S. (1984). *Restoring Our Competitive Edge: Competing Through Manufacturing*. New York: Wiley.
- IlSole24Ore, (2010). Dal Guru di Kyoto i Segreti del WCM. [Online] Available at: <http://www.ilsole24ore.com/art/notizie/2010-06-17/guru-kyoto-segreti-080200.shtml?uuid=AYPqjGzB> [Accessed 30th November 2016].

- Jazayeri, M. and Hopper, T. (1999). Management Accounting and World Class Manufacturing: a Case Study. *Management Accounting Research*, 10(3), 263-301.
- Johnson, T. H., (1981). Towards a New Understanding of Nineteenth-Century Cost Accounting. *The Accounting Review*, 56(3), 510-518.
- Johnson, T. H. & Kaplan, R. S. (1987). *Relevance Lost – Rise and Fall of Management Accounting*. Boston: Harvard Business School Press.
- Kaplan, R. S., (1984):1. Evolution of Management Accounting. *The Accounting Review*, 59(3), 390-417.
- Kaplan, R. S., (1984):2. Measuring Manufacturing Performance: a New Challenge for Managerial Accounting Research. *The Accounting Review*, 58(4), 686-705.
- Kaplan, R. S. (1994). Management Accounting (1984-1994): Development of New Practice and Theory. *Managerial Accounting Review*, 5(5), 247-260.
- Kirkham, L., Garza-Reyes, L. A., Kumar, V. & Antony, J. (2014). Prioritisation of Operations Improvement Projects in the European Manufacturing Industry. *International Journal of Production Research*, 52(18), 5323-5345.
- Littleton, A., (1933). *Accounting Evolution to 1900*. New York: American Institute Publishing Co.
- Posteucă, A, Zapciu, M. (2015). Beyond Target Costing: Manufacturing Cost Policy Deployment for New Products. *Applied Mechanics and Materials*, 809, 1480-1485.
- Schonberger, R. J., (1982). *Japanese Manufacturing Techniques: Nine Hidden Lessons in Simplicity*. New York: Free Press.
- Schonberger, R. J. (1986). *World Class Manufacturing – The Lesson of Simplicity Applied*. New York: Free Press.
- Scott, D. R., (1931). *The Cultural Significance of Accounts*. Henry Holt and Company.
- Silva, L. C. S., Kovaleski, J, Gaia, S., Garcia, M., De Andrade Junior, P. P., (2013). Cost Deployment Tool for Technological Innovation of World Class Manufacturing. *Journal of Transportation Technologies*, 3(3), 17-23.
- Vikram S., Amit R. D., Mohammad A. Q., (2015). Impact of lean practices on performance measures in context to Indian machine tool industry, *Journal of Manufacturing Technology Management*, 26 (8), 1218-1242, <https://doi.org/10.1108/JMTM-11-2014-0118>
- Womack, J., Jones, D., Roos, D. (1990). *The Machine that Changed the World*. New York: Free Press
- Yamashina, H., (1995). Japanese Manufacturing Strategy and the Role of Total Productive Maintenance. *Journal of Quality in Maintenance Engineering*, 1(1), 27-38.
- Yamashina, H., Kubo, T. and Okazaki, K. (1999). Manufacturing Cost Deployment. *Journal of the Japan Society for Precision Engineering*, 65(2), 260-266.
- Yamashina, H. (2000). Challenge to World-Class Manufacturing. *International Journal of Quality and Reliability Management*, 17(2), pp. 132-143.
- Yamashina, H. and Kubo, T. (2002). Manufacturing Cost Deployment. *International Journal of Production Research*, 40(16), 4077-4091.

## SUPPLY CHAIN CONNECTIONS AND THE TRIPLE BOTTOM LINE IN THE GLOBAL WINE INDUSTRY

Golicic, Susan L.<sup>1</sup>; Signori, Paola<sup>2</sup>; Flint, Daniel J.<sup>3</sup>

<sup>1</sup>Dept. of Management, Colorado State University, Fort Collins, CO, USA

<sup>2</sup>Dept. of Business Administration, University of Verona, Italy

<sup>3</sup>Dept. of Marketing & Supply Chain Management, Haslam College of Business, the University of Tennessee, Knoxville, TN, USA

### ABSTRACT

**Objectives.** This research examines relationships between supply chain connectedness and components of the triple bottom line (environmental, social and financial sustainability).

**Methodology.** The study is based on Stakeholder Resource Based View. The authors use a mix of qualitative methods. The context is the wine industry, and data are collected from 100 companies of six countries across the globe.

**Findings.** Results suggest that higher levels of supply chain connectedness is related to higher degrees of focus on sustainability dimensions (TBL).

**Research limits.** This study relied on practices discussed by respondents to categorize companies on high or low sustainability and high, medium or low supply chain connections; it is likely there are more than these levels and further exploration into this (quantitative) could tease out what those are.

**Implications.** Only a few wine businesses are truly sustainable from the TBL perspective; thus strong supply chain connections may be necessary for most to achieve the TBL. The supply chain and connections among the parties may provide a means to drive this further into the industry.

*Keywords: sustainability, triple bottom line, supply chain, stakeholder resource based view, global wine industry, grounded theory.*

### INTRODUCTION

Sustainability and practices to improve it are becoming increasingly important to global business. Sustainability is often defined at the macro level as meeting the needs of the present without compromising the ability of future generations to meet their own needs (UN Documents, 1987). It has developed into a critical topic for both supply chain scholars and industry due to the impact that supply chain practices can have on implementing the “triple bottom line” (TBL) perspective and

improving the environmental, social and financial longevity of organizations. Indeed, recent research has demonstrated that it contributes to organizational performance in many ways (e.g., Godfrey *et al.*, 2009; Golicic and Smith, 2013; Husgafvel *et al.*, 2015).

Given the opportunities available and the role supply chain management (SCM) plays in global business, an important unanswered research question (RQ) is: *what is the role of the direct supply chain (i.e., the connected companies) in the implementation of the TBL?* We chose the global wine industry as the context in which to answer this question, as the industry is an ideal example of the ever changing business world, and to understand if there are differences of approaches in different countries.

It is becoming increasingly competitive creating the need for stronger marketing and supply chain management practices (Flint *et al.*, 2016). Wine producers now understand they cannot be successful on their own. Additionally, sustainability is imperative in this industry. Using the stakeholder resource based view (SRBV) as a theoretical foundation and a grounded theory approach, this study begins to explore the role of the supply chain in pursuit of the TBL in the global wine industry.

## BACKGROUND

### *The Stakeholder Resource Based View (SRBV)*

The SRBV is based on the resource-based view, which suggest that the accumulation of valuable, rare, inimitable and non-substitutable resources is the basis of enterprise competitiveness (Barney, 1986; Newbert, 2007; Wernerfelt, 1984). It realizes the firm as a bundle of combined resources and capabilities that develop competencies. One of the areas of resources and capabilities most difficult to replicate is that associated with human and relationship capital (Hunt, 2000). The SRBV underlines the importance of managing stakeholders as valuable resources that in turn give the organization a strategic edge over rivals (Sodhi, 2015). It argues that all stakeholders, such as suppliers, employees, and customers, need to be managed in order to capitalize on their respective routines, resources, and capabilities as a means to achieve better performance (Gold *et al.*, 2009). This suggests that the parties in a supply chain may be positioned to drive major impact in highly competitive industries (Hult *et al.*, 2008).

### *Sustainability and Supply Chain Management in the Wine Industry*

All three dimensions of the TBL impact and are impacted by the wine industry - businesses in this industry are trying to profitably create and sell an agricultural product that is regulated. Thus, sustainability has been prevalent in food industry research over the past decade (Beske *et al.*, 2014); however, much of that has focused specifically on environmental sustainability (e.g., Flint and Golicic, 2009; Forbes *et al.*, 2009; Silverman *et al.*, 2005; Flint and Signori, 2014) or what the concept means (e.g., Carter and Rogers, 2009; Lahneman, 2015; Szolnoki, 2013). There have been a few studies exploring



sustainability comprehensively as the TBL within the wine industry (e.g., Pullman *et al.*, 2010; Santini *et al.*, 2013); however, these have neglected the role of the supply chain to date.

There is a growing body of work as it relates to sustainability and SCM (e.g., Ahi and Searcy, 2013; Ashby *et al.*, 2012; Blome *et al.*, 2014; Carter and Easton, 2011; Golicic and Smith, 2013; Sarkis, 2012; Seuring and Muller, 2008; Srivastava, 2007); however most of this focuses on a single dimension. There have been attempts to bring initiatives aimed at all aspects of sustainability into alignment (e.g., Carter and Rogers, 2008; Pagell and Shevchenko, 2014; Winter and Knemeyer, 2013), but again, these are largely conceptual. Recently, there has been some empirical work in the wine industry examining managerial philosophies with respect to sustainability and managing the supply chain (Signori *et al.*, 2015; Golicic *et al.*, 2017), but even these works pick apart the three dimensions of sustainability. Thus the current research attempts to fill the gap in the current research by empirically examining the role of the supply chain in the implementation of comprehensive view of sustainability – the TBL.

## METHODOLOGY

For this research, we adopted aspects of ethnography, grounded theory and phenomenology in data collection and interpretation and followed accepted procedures. The ethnographic aspects included observation, interviews and artifact collection within clusters of wine regions around the globe seeking norms of behavior, assumptions, roles played by actors, and meaning making (Arnould and Wallendorf, 1994). The grounded theory aspects involved the same data collection aspects along with coding processes that helped to explain social processes in which participants were engaged as they tried to solve problems in their everyday lives (Glaser, 1992; Mello and Flint, 2009; Randall and Mello, 2012). The phenomenological aspects focused on the interviews specifically where we sought what it meant to be a wine maker, winery marketer and so forth (Thompson *et al.*, 1989; Thompson, 1997).

This study sample examined 100 wine businesses of various age and size in fourteen regions of six countries, through interviews with owners or managers, marketing collateral, and photographs, and observations operations over a period of seven years. In particular, this research sample includes: 22 companies in Australia (Margaret River, Perth, South Australia, Swan Valley); 8 in France (Bordeaux); 11 in Germany (Pfalz, Rheingau); 22 in Italy (Tuscany, Veneto); 6 in New Zealand (Canterbury, Marlborough); 31 in USA California-Oregon-Washington (Carneros, Modesto, Napa, Sonoma; Willamette Valley; Columbia Valley, Walla Walla).

The convenience and theoretically driven sample was selected based on practices they described on their website (e.g., sustainability, innovation), through personal contacts, and emergent conceptualizations as data interpretation unfolded in order to ensure variability in the sample and refine interpretations. During open interviews practitioners discussed their sustainability practices and

their direct supply chains; respondents indirectly evaluated their companies on high or low sustainability and high, medium or low supply chain connections. As a consequence, one hundred direct supply chains have been studied through the lens of the business in focus. All documents were scanned for interpretation, and all interviews were audio-recorded and transcribed verbatim. Both phenomenology and grounded theory rely on open coding at the word, phrase and sentence meaning-unit level to build themes and categories from interview text. Several hundred open codes were collapsed into concepts that became themes (in phenomenology)/categories (in grounded theory) that were subsequently related to one another through axial coding. To address our specific research question, we also content analyzed the findings to quantitatively categorize each business on the three dimensions of sustainability and their level of supply chain connections (Harris, 2001).

Three researchers well-trained in qualitative research shared interviewing responsibilities, and all interpreted the data, coming together regularly to reconcile interpretations. Quality criteria followed accepted processes in the grounded theory tradition (Lincoln and Guba, 1985). We next present findings from our initial exploration into our research question.

## RESULTS AND DISCUSSION

### *The TBL in the Global Wine Industry*

Based on the data at the time in which they were collected, we categorized all of the businesses as either low or high on financial sustainability, environmental sustainability and social sustainability. These categorizations were determined based on information provided by those interviewed and their perceptions of these terms. For instance, if an interviewee spoke about a particular dimension and any company efforts aimed at pursuing it, then they were categorized as high. For example, this Oregon wine producer was categorized as high on social sustainability for explaining their philosophy. *“We feel like we have a responsibility for each of the people who are on the vineyard, and there’s a great organization out here that provides healthcare to Oregon’s vineyard workers and their families—and since we’ve opened the tasting room we’ve always given all of our tasting fees to that organization.”* If they did not mention sustainability or discussed it negatively, they were categorized as low. As an example, the following quote from a small Australian producer demonstrates how one was categorized as low on financial sustainability. *“And all of our work was associated with developing a premium wine. There was no desire to make money as a final objective; the objective was to create a lifestyle in the process of making premium wine.”*

Only seven percent (7%) of the companies interviewed were truly concerned about the comprehensive triple bottom line, with high evaluations on all three aspects. An Australian wine producer that had a sustainability manager was not surprisingly categorized as high on all three dimensions. Fifty-one percent were considered to practice two of the three dimensions (46% environmental and financial, 2%

environmental and social, 3% financial and social), and thirty-seven percent practiced one (30% financial, 6% environmental, 1% social). That left five percent that were evaluated at minimum levels of sustainability. In addition, we tested linear correlations between all variables, the three dimensions of sustainability. We found that none of the three sustainability dimension correlations has a significant correlation at the .05 level or better. So the three sustainability dimensions are independent.

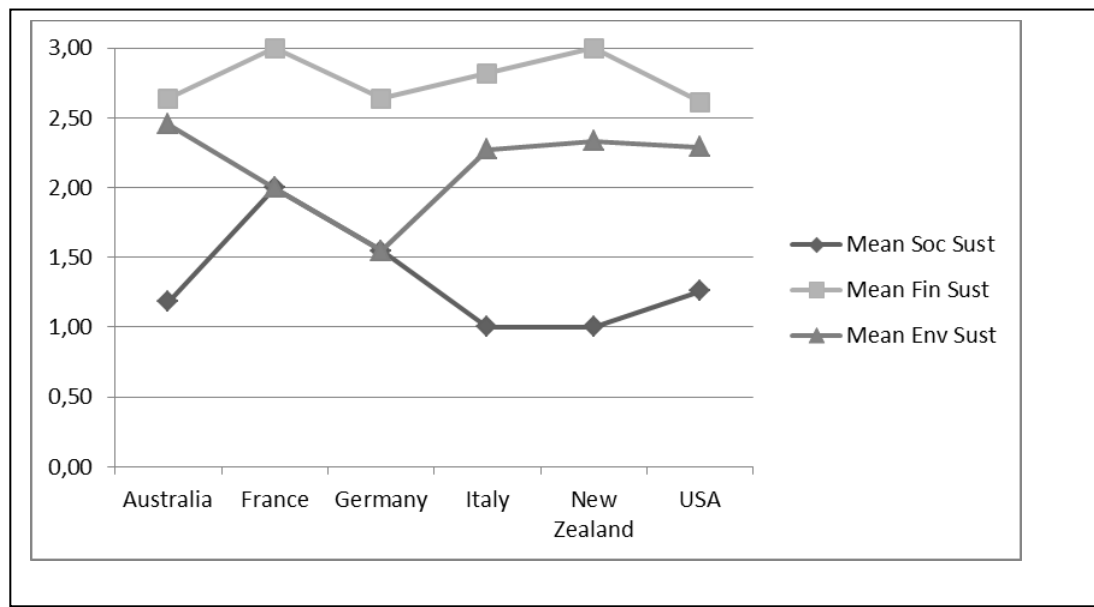

Figure 1. Triple Bottom Line Country means

Reading these results comparing countries' means (Fig. 1), financial sustainability has the highest scores in every country (mean  $\mu_{fin}= 2.72$  and standard deviation  $\sigma_{fin}= 0.69747$ ). Social sustainability ( $\mu_{soc}= 1.26$ ;  $\sigma_{soc}= 0.67600$ ) is lower in Italy, New Zealand, USA and Australia, with overall low scores. Environmental sustainability scores ( $\mu_{env}= 2.22$ ;  $\sigma_{env}= 0.98041$ ) are lower in Germany and France. The position comparison yielded interesting results from the suppliers (e.g., growers, contract winemakers) with respect to sustainability; they were all low on social and high on financial sustainability. Regional differences were detected for Italy (lower than the rest on social sustainability), Germany (lower than the rest on environmental sustainability, but with differences within two German wine regions, Pfalz and Rheingau), New Zealand (low on environmental dimensions, with a great difference in its two wine regions, Canterbury and Marlborough). In the American sample results show many differences between States and wine regions, in particular concerning the environmental dimension. About financial sustainability, it is interesting to highlight that in France and New Zealand all participants were evaluated highly positive.

*Supply Chain Connections and TBL in the Wine Industry*

Participants were asked about suppliers, customers and competitors in the industry. Based on their reference (or lack of) to other companies in their supply chain, we characterized each business as having either low, medium or high supply chain connections (direct, extended and horizontal). For example, many participants did not mention any other companies and largely talked about their practices with no reference to working with others. However, there were various reasons why some have numerous connections. A participant from Veneto, Italy, mentioned working with several other companies in the region in addition to distributors to enable her to access more markets outside of her region (extended supply chain). Several participants in Western Australia and California discussed connections they had made while studying wine making whether in school or working with established winemakers, and most maintained these horizontal relationships. One small owner in the Willamette Valley described, *"You name it, I mean [winery] being nearby sends a lot of people, but every winery here: [list of five wineries] sends many people, but they all do; everyone that I know, and I made it a point to get to know everybody."* Overall, 31% demonstrated high levels of supply chain connections, with 44% medium and 25% low connections.

The content analysis comparing the sustainability and supply chain connection categorizations demonstrated linkages between pursuing higher levels of the TBL and supply chain connections. Testing linear correlations between all variables, i.e. the three dimensions of sustainability as well as supply chain and TBL, we discovered that when a firm is supply chain focused it is likely to be social sustainability focused as well, no causality implied (Pearson correlation  $Q_{sc,soc}=.328$ ,  $p\text{-value}=.001$ ). Moreover, firms that are supply chain focused are likely to also be TBL focused, on all 3 dimensions ( $Q_{sc,tbl}=.240$ ,  $p\text{-value}=.016$ ). Thirty-eight percent of those companies that were high on two or all three sustainability dimensions had high supply chain connections with 79% at least medium (5 of the 7 pursuing the TBL had high connections).

A winemaker in New Zealand described stronger supply chain connections because they were working together to minimize their carbon footprint throughout the chain. In fact, many of the companies in this region and in Oregon pursuing environmental sustainability understood that they needed to work more closely with supply chain partners in order to be successful. A manager at a South Australia producer noted that the company executives participated in a consortium with other producers and that they worked on sustainability, *"...these guys, the owners, they're the people who meet. They're discussing topics they're not required to and I'm sure that sustainability is of equal interest to them."* One the other end of the spectrum, 31% that were low on two or all three sustainability dimensions had low supply chain connections with 79% no higher than medium.

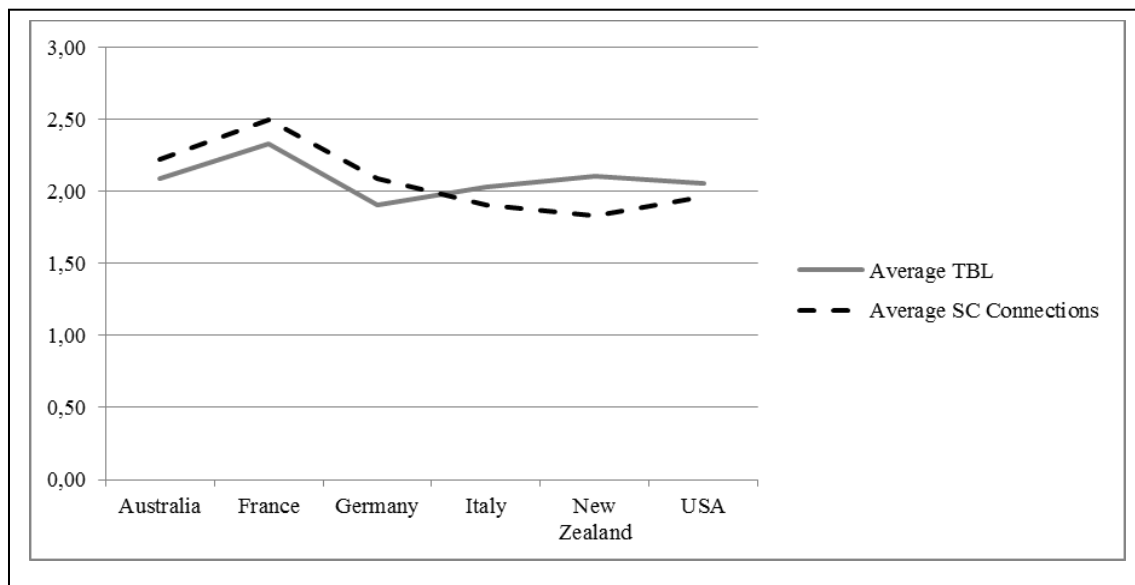

Figure 2. *Supply Chain Connections and TBL per Country*

Both categorizations were compared across countries (Fig. 2), position in the supply chain, the size of the organization, and the year in which the data were collected. Across time, the categorizations seem to be consistent with the exception of social sustainability. The interest in this particular area is growing, and our data supported this. Interestingly, most of the organizations with high levels of connections were smaller producers whereas many of those with low connections were larger companies. Geographically, in Australia nearly half of the participants had high levels of connections relative to the rest of the sample there.

## CONCLUSIONS AND IMPLICATIONS FOR THEORY AND PRACTICE

This research set out to explore the role of the supply chain in implementation of the TBL. The main research question (RQ) was: *what is the role of the direct supply chain (i.e., the connected companies) in the implementation of the TBL?* Our findings supported a link between higher levels of supply chain connections and pursuit of higher levels of sustainability. Though the comprehensive TBL was not prevalent in the wine industry, 58% of our sample pursued at least two of the three dimensions, and of these 38% had high connections and 79% at least medium level connections in their supply chains. Some of the participants described working with supply chain partners specifically to implement sustainability practices. Thus, strong supply chain connections may be necessary for most to achieve a solid TBL. This may not be a surprise; however, because there are not many companies that have truly

achieved a powerful TBL. This study does provide empirical evidence of a means through which to achieve it, particularly in the wine industry.

Per SRBV, stakeholders are valuable resources that can help a company achieve the performance they desire (Sodhi, 2015). Our research supports this theory as it demonstrates that higher levels of connection among supply chain parties (i.e., stakeholders) may contribute to the implementation of the TBL. This line of theory also argues that resources and capabilities can make a company more competitive (Barney, 1986), and since human and relational capital are resources that are among the most difficult to replicate (Hunt, 2000), these connections may not only provide the resources and capabilities to achieve the TBL for businesses in the wine industry, they may also provide a means of differentiation *vis-à-vis* competitors when so many are moving toward sustainable practices.

The data for this study were collected over seven years. It would be interesting to update the data to see if regions where data were collected earlier (e.g., New Zealand in 2009) had changed their sustainability philosophies and/or levels of supply chain connections. The study was exploratory and relied on qualitative data. We also content analyzed the findings to quantitatively categorize each business on the three dimensions of sustainability and their level of supply chain connections. We relied on practices discussed by respondents to categorize companies on high or low sustainability and high, medium or low connections; it is likely there are more than these levels and further exploration into this (quantitative) could tease out what those are. Ideas offered from the results should be formulated into hypotheses and tested to better determine the links among the concepts – for example, *do the connections drive a focus on a TBL or are they a result of pursuing the TBL?* The TBL is growing in importance in this ever-changing business world, and it has been receiving increasing attention in the wine industry. To date, only a few wine businesses are truly sustainable from the TBL perspective. However, the supply chain and connections among the parties may provide a means to drive this further into the industry.

## REFERENCES

- Ahi, P. and Searcy, C. (2013), "A comparative literature analysis of definitions for green and sustainable supply chain management", *Journal of Cleaner Production*, Vol. 52, pp. 329-341.
- Arnould, E. J. and Wallendorf, M. (1994), "Market-oriented ethnography: interpretation building and marketing strategy formulation", *Journal of marketing research*, pp. 484-504.
- Ashby, A., Leat, M. and Hudson-Smith, M. (2012), "Making connections: a review of supply chain management and sustainability literature", *Supply Chain Management: An International Journal*, Vol. 17 No. 5, pp. 497-516.
- Barney, J. B. (1986), "Organizational culture: can it be a source of sustained competitive advantage?", *Academy of management review*, Vol. 11 No. 3, pp. 656-665.
- Beske, P., Land, A. and Seuring, S. (2014), "Sustainable supply chain management practices and dynamic capabilities in the food industry: A critical analysis of the literature", *International Journal of Production Economics*, Vol. 152, pp. 131-143.
- Blome, C., Paulraj, A. and Schuetz, K. (2014), "Supply chain collaboration and sustainability: a profile deviation analysis", *International Journal of Operations & Production Management*, Vol. 34 No. 5, pp. 639-663.

- Carter, C. R. and Easton, P. L. (2011), "Sustainable supply chain management: evolution and future directions", *International Journal of Physical Distribution & Logistics Management*, Vol. 41 No. 1, pp. 46-62.
- Carter, C.R. and Rogers, D.S. (2008), "A framework of sustainable supply chain management: moving toward new theory", *International Journal of Physical Distribution and Logistics Management*, Vol. 38 No. 5, pp. 360-87.
- Flint, D. J., Signori, P. and Golicic, S. L. (2016), *Contemporary Wine Marketing and Supply Chain Management: A Global Perspective*, Springer, NY.
- Flint, D.J. and Golicic, S.L. (2009), "Searching for competitive advantage through sustainability: A qualitative study in the New Zealand wine industry", *International Journal of Physical Distribution and Logistics Management*, Vol. 39 No. 10, pp. 841-860.
- Flint, D.J. and Signori, P. (2014), "Environmental sustainability: Is collaboration necessary?", in Gammelgaard, B., Proekl, G., Kinra, A., Astrup, J., Andersen, P., Schrann, Hans-Joachim, Hsuan, J., Malouf, M. and Wieland, A. (Ed.), *26th Conference of the Nordic Logistics Research Network, NOFOMA 2014, Competitiveness through supply chain management and global logistics*, Copenhagen, DK, pp. 565-580.
- Forbes, S. L., Cohen, D. A., Cullen, R., Wratten, S. D. and Fountain, J. (2009), "Consumer attitudes regarding environmentally sustainable wine: an exploratory study of the New Zealand marketplace", *Journal of Cleaner Production*, Vol. 17 No. 13, pp. 1195-1199.
- Glaser, B.G. (1992), *Basics of grounded theory analysis*, Sociology Press, Mill Valley, CA.
- Godfrey, P. C., Merrill, C. B. and Hansen, J. M. (2009), "The relationship between corporate social responsibility and shareholder value: An empirical test of the risk management hypothesis", *Strategic management journal*, Vol. 30 No. 4, pp. 425-445.
- Gold, S., Seuring, S. and Beske, P. 2009. "Sustainable Supply Chain Management and Inter-organizational Resources: A Literature Review", *Corporate Social Responsibility and Environmental Management*, Vol. 17 No. 4, pp. 230-245.
- Golicic, S. L., Flint, D. J. and Signori, P. (2017). "Building business sustainability through resilience in the wine industry", *International Journal of Wine Business Research*, Vol. 29 No. 1.
- Golicic, S.L. and Smith, C.D. (2013), "A Meta-Analysis of Environmentally Sustainable Supply Chain Management Practices and Firm Performance", *Journal of Supply Chain Management*, Vol. 49 No. 2, pp. 78-95.
- Harris, R. J. (2001), *A primer of multivariate statistics*, Psychology Press Taylor and Francis Group, NY.
- Hult, T.M., Ketchen, D.J. and Adams, G.L. (2008), "Supply chain orientation and balanced scorecard performance", *Journal of Managerial Issues*, Vol. 20 No. 4, pp. 526-544.
- Hunt, S.D. 2000. *A General Theory of Competition*, Sage Publications, Thousand Oaks, CA.
- Husgafvel, R., Pajunen, N., Virtanen, K., Paavola, I. L., Päällysaho, M., Inkinen, V. and Ekroos, A. (2015), "Social sustainability performance indicators—experiences from process industry", *International Journal of Sustainable Engineering*, Vol. 8 No. 1, pp. 14-25.
- Lahneman, B. (2015), "In vino veritas: Understanding sustainability with environmental certified management standards", *Organization & Environment*, Vol. 28 No. 2, pp. 160-180.
- Lincoln, Y. and Guba, E.G. (1985), *Naturalistic Inquiry*, Sage, Beverley Hills, CA.
- Mello, J. and Flint, D.J. (2009), "A refined view of grounded theory and its application in logistics research", *Journal of Business Logistics*, Vol. 30 No. 1, pp. 107-25.
- Newbert, S. L. (2007), "Empirical research on the resource-based view of the firm: an assessment and suggestions for future research", *Strategic management journal*, Vol. 28 No. 2, pp. 121-146.
- Omar, A., Davis-Sramek, B., Fugate, B.S. and Mentzer, J.T (2012a), "A global analysis of orientation, coordination and flexibility in supply chains", *Journal of Business Logistics*, Vol. 33 No. 2, pp. 128-44.
- Pagell, M. and Shevchenko, A. (2014), "Why research in sustainable supply chain management should have no future", *Journal of Supply Chain Management*, Vol. 50 No.1, pp. 44-55.
- Pullman, M. E., Maloni, M. J. and Dillard, J. (2010), "Sustainability practices in food supply chains: how is wine different?", *Journal of Wine Research*, Vol. 21 No.1, pp. 35-56.
- Randall, W. S. and Mello, J. E. (2012), "Grounded theory: an inductive method for supply chain research", *International Journal of Physical Distribution & Logistics Management*, Vol. 42 No. 8/9, pp. 863-880.
- Santini, C., Cavicchi, A. and Casini, L. (2013), "Sustainability in the wine industry: key questions and research trends", *Agricultural and Food Economics*, Vol. 1, No. 1, pp. 1-9.
- Sarkis, J. (2012), "A boundaries and flows perspective of green supply chain management", *Supply Chain Management: An International Journal*, Vol. 17 No. 2, pp. 202-16.
- Seuring, S. and Muller, M. (2008), "From a literature review to a conceptual framework for sustainable supply chain management", *Journal of Cleaner Production*, Vol. 16 No. 15, pp. 1699-710.

- Signori, P., Flint, D. J. and Golobic, S. (2015), "Toward sustainable supply chain orientation (SSCO): mapping managerial perspectives", *International Journal of Physical Distribution & Logistics Management*, Vol. 45 No. 6, pp. 536-564.
- Silverman, M., Marshall, R. S. and Cordano, M. (2005), "The greening of the California wine industry: Implications for regulators and industry associations", *Journal of Wine Research*, Vol. 16 No. 2, pp. 151-169.
- Sodhi, M. S. (2015), "Conceptualizing Social Responsibility in Operations Via Stakeholder Resource-Based View", *Production and Operations Management*, Vol. 24 No. 9, pp. 1375-1389.
- Srivastava, S.K. (2007), "Green supply chain management: a state of the art literature review", *International Journal of Management Reviews*, Vol. 9 No. 1, pp. 53-80.
- Szolnoki, G. (2013), "A cross-national comparison of sustainability in the wine industry", *Journal of Cleaner Production*, Vol. 53, pp. 243-251.
- Thompson, C.J. (1997), "Interpreting consumers: a hermeneutical framework for deriving marketing insights from the texts of consumers' consumption stories", *Journal of Marketing Research*, Vol. 34 Nov, pp. 438-455.
- Thompson, C.J., Locander, W.B. and Pollio, H.R. (1989), "Putting consumer experience back into consumer research: the philosophy and method of existential phenomenology", *Journal of Consumer Research*, Vol. 16 Sep, pp. 133-146.
- UN Documents. 1987. "Report of the World Commission on Environment and Development: One Common Future", published as annex to General Assembly document A/42/427, available at: <http://www.un-documents.net/wced-ocf.htm> (accessed December 8, 2010).
- Wernerfelt, B. (1984), "A resource-based view of the firm", *Strategic Management Journal*, Vol. 5 No. 2, pp. 171-181.
- Winter, M. and Knemeyer, A.M. (2013), "Exploring the integration of sustainability and supply chain management: current state and opportunities for future research", *International Journal of Physical Distribution and Logistics Management*, Vol. 43 No. 1, pp. 18-38.



## DATA DRIVEN MARKETING FOR GROWTH AND PROFITABILITY

Grandhi, Balakrishna; Patwa, Nitin; Saleem, Kashaf

SP Jain School of Global Management

### ABSTRACT

**Purpose:** In the current business environment, more uncertain than ever before, understanding consumer behaviour is an integral part of an organization's strategic planning and execution process. It is the key driver for becoming a market leader. Therefore, it is important that all processes in business are customer centric. Capturing, categorizing, warehousing, mining, analysing and making sense of data is a real-time challenge for all marketers. Organizations embracing digitization are seeing Big Data getting bigger. Investments are being made in IT infrastructure, Internet of Things, machine learning and artificial intelligence in business decision-making. Marketers need to harness big data by engaging in Data Driven Marketing (DDM) to help organizations choose the 'right' customers, to 'keep' and 'grow' them and to sustain 'growth' and 'profitability'. This research examines DDM adoption practices and how companies can aim to enhance shareholder value by bringing about 'customer centricity' through better use of data.

**Design/Methodology/Approach:** An online survey conducted in 2016 received 180 responses from junior, middle and senior executives. Of the total responses 26% were from senior management, 39% from middle management and the remaining 35% from junior management. Industries represented in the survey included Retail, BFSI, Healthcare and Government, Automobile, Telecommunication, Transport & Logistics and IT. Other industries represented were Aviation, Marketing Research & Consulting, Hospitality, Advertising & Media and Human resource.

Among the respondents, 34% represented companies with less than \$30 million in annual revenues, 15% between \$30 - 50 million and \$50 - 100 million, 32% between \$100 - 500 million, and the remaining 19% with \$500 million and above in annual revenues. In terms of company size, 60% were companies with 1 - 500 employees, 13% with 500 - 1000 and 26% with 1000 and above employees. The survey was done in Dubai which represents a blend of several global economies and hence, can be generalised.

**Findings:** Success of DDM depends upon how well an organization embraces the practice. The first and foremost indicator of an organization's commitment is the extent of resources invested for data driven marketing. Respondents were divided into four categories;

Laggards, Dabblers, Contenders, and Leaders based on their 'current level of investments' and 'willingness to enhance investments' soon.

'Leaders' are from Retail, Banking & financial services, transportation & logistics and Telecommunication sectors. The major sources of information are point-of-sales data, social media and other published sources. They use data to understand what and why customers are buying, what their consumption patterns are and what makes them satisfied or dissatisfied. 'Dabblers' are players who have realized the importance of data and have just begun to incorporate it in their marketing in a limited way. 'Contenders' are far more regular in using data for measuring and taking marketing decisions. 'Laggards' are at the other extreme when it comes to using data for customer analysis.

**Practical implications:** The results of the study offer interesting implications for managing the growing sea of data. An iterative and incremental approach is the need of the hour, even if it has to start with baby steps, to invest in and reap the fruits of data driven marketing. The intention to use any system is always dependent on two primary belief factors: perceived usefulness and perceived ease of use, however attitudes and social factors are equally important. Investments in the right people, infrastructure and processes early on can result in better marketing due diligence and contribute to higher return on marketing investment, necessary to sustain an organization's growth and profitability.

**Originality/Value:** All organizations, irrespective of size and sector, need to engage in data driven marketing for customer centricity. In this era of digitalization, a marketer needs to wisely handle the volume, velocity, variety and veracity of data. Roger's diffusion of innovation theory identifies factors leading to the adoption of innovation by both individuals and organizations. The theory argues that willingness and ability to adopt depends on awareness, interest, evaluation, trial and adoption (Rogers, 2003). There is a dearth of knowledge with regards to who is and is not adopting DDM, and how best big data can be harnessed for enhancing effectiveness and efficiency of marketing budget. It is, therefore, imperative to build a knowledge base on DDM practices, challenges and opportunities. Better use of data can help companies enhance shareholder value by bringing about 'customer centricity'.

*Keywords: Data Driven Marketing, Customer Centric, Value Proposition, Digital Data, Marketing Metrics, Marketing Analytics, Marketing Audit, Marketing Dashboard, Digital Marketing and Marketing Investment, ROMI (Return On Marketing Investment) and Diffusion of Innovation.*

## INTRODUCTION

### **Customers' Growing Power:**

The fundamentals of marketing will always be the same, despite the changing forces that shape the future of marketing. Technology connects the world, but customers resist standardisation and prefer individualization. The modern-day consumers are sophisticated, knowledgeable, and powerful. The ever-changing consumer buying behaviour requires identifying the right audience and understanding their buying patterns (Kotler and Keller, 2012). Owing to technological advancements, digitalization and marketing analytics - especially data mining- have become invaluable tools and should be viewed as equal components of the marketing research toolkit (Hauser, 2007).

Consumers no longer pay attention to brand communications that are irrelevant. They now demand individualization i.e. messages directly tapping their latent needs. Various studies aim at constructing models on how customers think, feels and chooses one among the alternatives short-listed. They endeavour to learn and understand the customer's response to sales promotion techniques, social, political, cultural and psychological factors (Solomon 1995). It is of paramount importance for marketers to use the abundance of available data to engage customers contextually and consistently to enhance customer experience (Gordon, 2013). In present times managers will need a workforce with different skill sets than in the past - a workforce that is equipped enough to handle consumer analytics and other relevant analytical tools (Hofacker, Malthouse, & Sultan, 2016).

### **Marketers' Growing Challenge:**

User behaviour and marketing strategies are both going on separate tracks, and there is a dire need for alignment (Gresper.com, 2014). With the advent of digital media, the marketing function needs to understand its target audience better by examining their digital interactions. Rich data, if harnessed well, can provide unparalleled insights for sending the right message to the right consumer at the right time. Thus, data analysis by way of Data Driven Marketing (DDM) can result in firms gaining valuable insights on consumer behaviour (Bhandari, Singer & Van der Scheer, 2014).

One of the most comprehensive studies on the changing marketing environment conducted by IBM revealed technology as the driving factor of pervasive change. The study involved face-to-face interviews with more than 1700 CMOs worldwide, spanning 19 industries and 64 countries. The five biggest challenges identified by the CMOs were: data explosion, social media, the growth of channel and device choices, shifting consumer demographics and financial constraints (IBM, 2011). The study also revealed that more than 60% of the CMOs felt they were unprepared to tackle these challenges, indicating a desperate need to change the approach.

For a customer-centric approach, three main methods namely; connect, collaborate, and convert model are used (Marketingtechnews.net, 2014). This new wave of connecting contextually to build a lasting

and profitable relationship with customers is pushing marketers to keep pace with technological advancements. Marketers can engage in data driven decision-making and marketing to improve effectiveness and optimize their return on marketing investment (ROMI). A deeper understanding of classical and data Analytics helps businesses make better and more informed decisions (Agrawal, 2014).

## **2.0 LITERATURE REVIEW**

### **What is Data Driven Marketing?**

It is the process of collecting complex data through online and offline channels, analysing them to understand the psyche and purchasing patterns of a consumer, thus helping the marketing team develop a strategy that is highly personalized for connecting with the target audience. As companies trend towards utilizing data to strategize and anticipate customer needs, there is an unanimous assent and an important role that technology plays to build predictive models. These models can help organisations establish customer centric processes to bring customers on board. Data has the potential to help identify needs and influencing factors at each stage of the consumer decision-making process. Data driven marketing techniques focus on the analysis of internal and external data, and integration of this information to help the development of products and services. This process ensures richer contexts for consumers, assists in the acquisition of new customers and retention of current clients. Eventually, this approach can lead to cost avoidance or cost reduction, and an increase in the company's productivity and efficiency. The scope and ability of Data Driven Marketing (DDM) are such that it can change the entire paradigm of marketing.

Neuromarketing and predictive analysis are the upcoming trends in understanding the buying patterns of consumers (Salesbrain.com). Similarly, DDM strategies have extensive application in B2B sectors as well. Essentially, this can help in achieving the overall goals of any organization (Gresper.com, 2014). In the last decade, the use of neurophysiologic data to measure marketing ROI and brand equity has led to a paradigm shift in data driven marketing. Neuroscience data is being increasingly referred to as the new "scanner" data (Venkatraman et al., 2012). There has been an increasing trend in traditional market research firms entering this space, such as Nielsen Research investing in NeuroFocus, and in the number of neuromarketing companies offering proprietary neurophysiologic toolkits (Well, 2010).

### **What is driving DDM and what is inhibiting it?**

The winterberry group and Global DMA carried out an ambitious research project collaborating with marketing and advertising associates around the world to understand how data driven marketing is changing the industry. A whopping 92.2 % of panellists said that DDMA (Data Driven Marketing and

Advertising) had become a significantly important part of their marketing strategy (Braverman S., 2015). The major point highlighted by global panellists was the concept of customer centricity. Panelists across the spectrum mentioned that to advance DDMA, the flow of investment into the area needs to increase. On the other hand regulations on DDMA, for example on collecting consumer data, do not seem to have much of an impact on its growth. Only 24.8% of the associates mentioned it as a factor that inhibits the growth of data driven marketing (Kumar, V. et al., 2013).

Analytical tools help understand the next "would be" consumer buying pattern (Rooney & Jennifer, 2014). Insights derived from such analysis are then used to direct, optimize and automate the decision-making process. Data, text and web mining techniques are some of the key contributors to making advanced analytics possible and eventually achieving business goals (Bose, 2009). Social media has helped in giving marketing a new dimension. It has not only reduced costs, but is also far more effective than traditional marketing. There is a great volume of data coming through social media. However, this advantage comes with a few challenges.

One of the challenges is information chaos. Different forms of data from different sources need to be archived and analysed. With huge amounts of data, managers might not be able to differentiate between the potential customers and general audience (Schulze, C. et al., 2015). Another struggle is the issue of identifying the right metrics and keeping track of them. The improvement of technology has paved the way for inexpensive data storage. However, this poses a threat to data security. Companies are in the era where protecting consumer data is vital. Failure to do so results in loss of consumer confidence. Data driven marketing is accompanied by challenges which involve optimization, accurate use of data and ROI (Neil Davey, 2015). The challenges involving accurate use of data and working across various platforms need to be resolved in the future for the better use of DDM (Daniil Karp, 2015). There is a need to close the gap between mere collection of data and organizing that data for putting it to use.

According to a Forbes survey of 331 executives, including presidents and vice presidents of various fields, the greatest challenge is the training offered to employees in DDM skills (Forbes.com, 2015). There is a lack of professionals, skilled enough to synthesize and use such large amounts of data. To target customers in today's fast paced world, it is necessary for marketers to use digital media tools like online advertising through social media, extracting personal information of a customer through mobile, etc. (Rohm, A. et al., 2013).

Effective DDM is possible only by building a creative team of marketers with sufficient knowledge of digital advertising and new concepts such as real-time marketing. There is a need to hire the next generation of professionals with a blend of right brained and left brained skills. With the advancement

of technology, the future role of CMOs in organizations should also evolve (Fitzgerald, M., 2015). Chief Marketing Officers in the organization should be working along with IT and other departments to make effective use of Big Data. In fact, the age of digital disruption has given rise to a new concept of Chief Marketing Technologist (Scott & Laura, 2014). In many large corporations CMOs are being replaced by CMTs in response to the growing convergence of IT and marketing.

On the other hand, the benefits of DDM increase customer engagement thereby increasing sales revenue of the products. With the help of data, driven marketing companies can be customer focused (Deevi, S., 2015). In a survey conducted with 1506 executives in marketing and communication sectors, most of the respondents agreed that DDM helps in increasing customer acquisition and customer retention (Renilde De Wit., i-scoop.eu). This in turn increases the efficiency and the return on investment. DDM helps in creating a more personalized experience based on different parameters namely income, age, gender, location, purchases, etc. (Eleventygroup.com, 2012).

### **3.0 RESEARCH METHODOLOGY**

#### **Sample Size**

A survey was conducted in 2016 and received a total of 180 responses from junior, middle and senior executives. Industries in the survey included retail, BFSI, Healthcare and Government, Automobile, Telecommunications, Transport & Logistics, IT, Aviation, Marketing Research, Consulting, Hospitality, Advertising & Media and Human Resource. 34% of the respondents represented companies with less than 30 million in annual revenues, 15% from companies with 30 – 50 million and 50 – 100 million in annual revenues, 32% of the respondents from companies with 100 - 500 million in annual revenues, and the remaining 19% represented companies with 500 million and above.

With regards to size of the organizations, 60% of the respondents belonged to companies with 1– 500 employees, 13% belonged to companies with 500 – 1000 employees and 26% belonged to companies with 1000 and above employees. Of the total respondents 26% were from senior management, 39% from middle management and the remaining 35% from junior management.

#### **Research Design**

The survey was conducted with an online questionnaire. It was divided into three sections to capture the needed information. The first section focused on capturing demographic and organizational characteristics to profile the participants and the organisations they represent. Questions in the second section were adopted from the marketing metrics book “The Definitive Guide to Measuring Marketing Performance” (Farris et al., 2010). These questions focused on understanding use of data for marketing decisions, using a 10 point Likert scale. The final section comprised of questions to

measure the current and proposed level of expenditure on data collection and data analytics practices in the organizations. This information was then analyzed using Descriptive Analytics.

## 4.0 FINDINGS AND ANALYSIS

### 4.1 Survey Findings

For this study, four distinct categories were identified i.e. leaders, contenders, laggards and dabblers (Forbes Insights, 2015). Respondents were assigned to one of these categories based on their 'current' investment in DDM and their 'proposed' investment in DDM in the foreseeable future. Organizations currently employing data analytics for most or all of their marketing and hoping to continue in the future, i.e. their current and proposed investment is high, are defined as "Leaders" for this research. Organizations with low current investment but with aspirations of high investment are categorized as "Contenders". Organizations which have invested in DDM but are skeptical about continuing the same for the future are termed as "Dabblers". Organizations that are yet to initiate DDM are categorized as "Laggards".

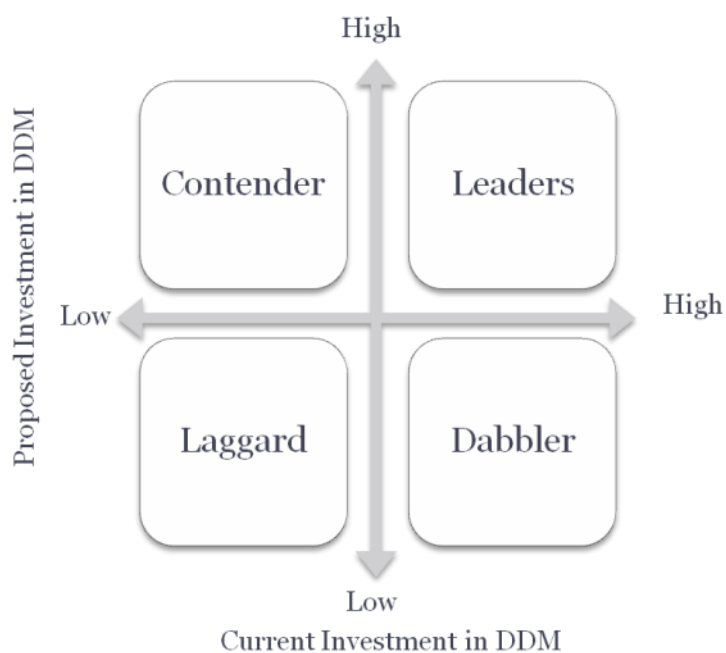

### The Data Driven Marketing Continuum

As digitization evolves and the sea of data gets larger, different organisations in different industries will get affected differently depending on whether they have 'leaders or laggards in senior marketing positions (Friedrich, R, 2011). Data driven marketing's success depends on the approach the marketer towards data. Every company can become a data-driven marketing success by investing resources in infrastructure, systems and expertise. Organizations that are "leaders" in data-driven marketing

possess far higher levels of customer engagement and market growth than their “laggard” counterparts (Jones, 2017).

Respondents in the ‘Leaders’ group were allocating more than 25% of their current marketing budget to DDM and intend to allocate greater than 25% of annual marketing budget in the future. ‘Contenders’ and ‘Dabblers’ are those with investments in the range of 5% to 25%, but with varying likelihood to increase in next three years. ‘Laggards’ have investments lower than 5% and show a low inclination for increasing it in the future. In the present research, the respondents were identified as follows: Leaders 23%, Contenders 6%, Dabblers 46% and Laggards 25%. The four categories are represented and profiled as follows:

■ Laggards ■ Leaders ■ Contenders ■ Dabblers

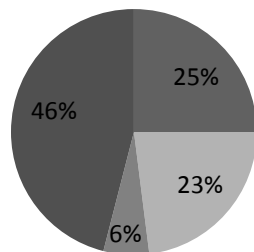

Figures 1: Shows the % of respondents in different categories

**Laggards** do not believe in data. They neither collect data nor plan to do so in the future. They are unaware of the importance of data driven marketing and are yet to understand its power and potential, resulting in problems of customer loyalty, customer engagement, and market growth. The companies falling in the Laggard category employ a manual marketing effort with employees acting on their own. Departments are in different silos with little connection or coordination. Projects initiated, if any, are outsourced resulting in questionable quality of data delivered. Everything is conducted on an informal basis without any direction, budget or funding.

**Dabblers** are players who have realized the importance of data and have just begun to incorporate it in their marketing in a limited way. However, they lack the skill or vision to see returns. They plan digital marketing perhaps at the sales level or within customer service departments. They neither integrate nor share data or processing capabilities with other channels. They use social media for data collection but do not examine it critically. They allocate limited funding or staff time for this cause. No formal budget is available.

**Contenders** are players who are far more regular in using data for measuring and taking marketing decisions. They invest in building digital marketing expertise across the team. The core aim is to bring customer-facing channels together with common data and applications. Proper training is provided to



the staff to manage these processes under the supervision of a Chief Marketing Technologist for a Digital Marketing Program. Marketers make use of various forms of engagement—such as mobile, web, social, video, and make their digital marketing more focused and responsive to market needs. A formal budget allocation and proper metrics are used to evaluate marketing activities initiated. **Leaders** are players who are inclined towards analytics and strive to take data-driven decisions. They are Digital savvy as all their marketing decisions are based on data. Data is shared across channels freely and consistently with real-time feedback making the campaigns highly effective. Marketing function engages in tailor made efforts to cater to customer needs. Formal metrics are used and constantly refreshed and realigned. Comprehensive training is provided to staff not only to engage in digital marketing and stir innovation but also to manage these processes. They build specialized teams focused on optimizing digital marketing efforts to enhance their impact on the business. A Chief Digital Officer is appointed to lead the effort while CEO, CFO or SVP of Marketing is brought on-board for initiating and running a Digital Marketing Program.

Leaders allocate adequate budget to this program. They use data to build more complete and contextually relevant customer profiles to effectively target their media. There is reliance on cloud-based technology that includes solutions across marketing goals. Leaders actively embrace personalization in mobile and display ads. Most of the companies leading in this practice have higher levels of customer engagement and market growth than their 'laggard' counterparts.

As shown in figure 2 below, Data Driven Marketing is widely used and has achieved results for customer analysis, customer satisfaction, product analysis, web analytics and sales force productivity. The other sources of information are the point of sales data, social media and published sources.

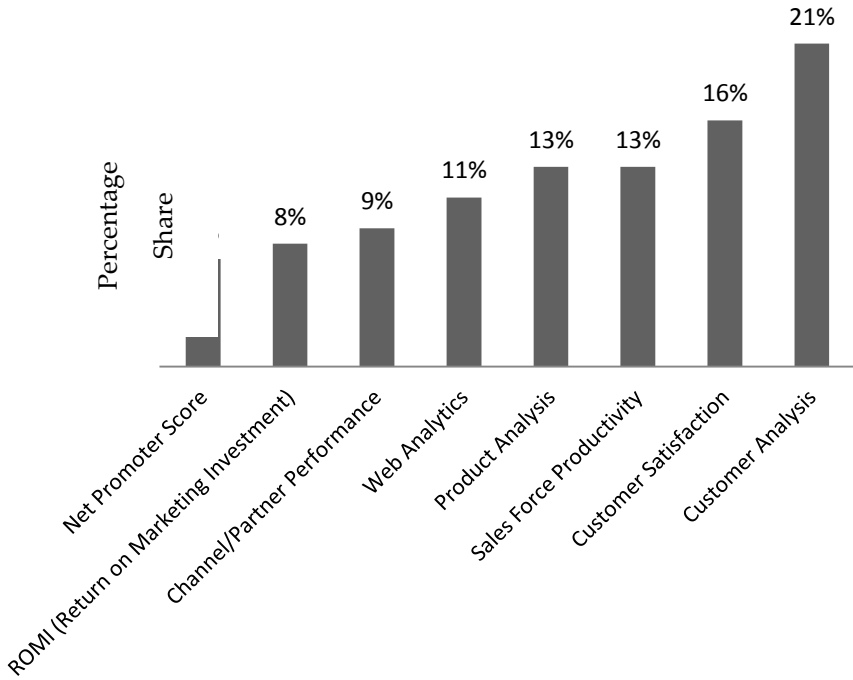

Figure 2: Extent of data-driven marketing decisions

Organizations belonging to the ‘Leaders’ category are primarily from retail, banking, transportation/logistics and telecom industries (Fig. 3). These are primarily customer-focused industries using data from different sources to understand and serve customers better.

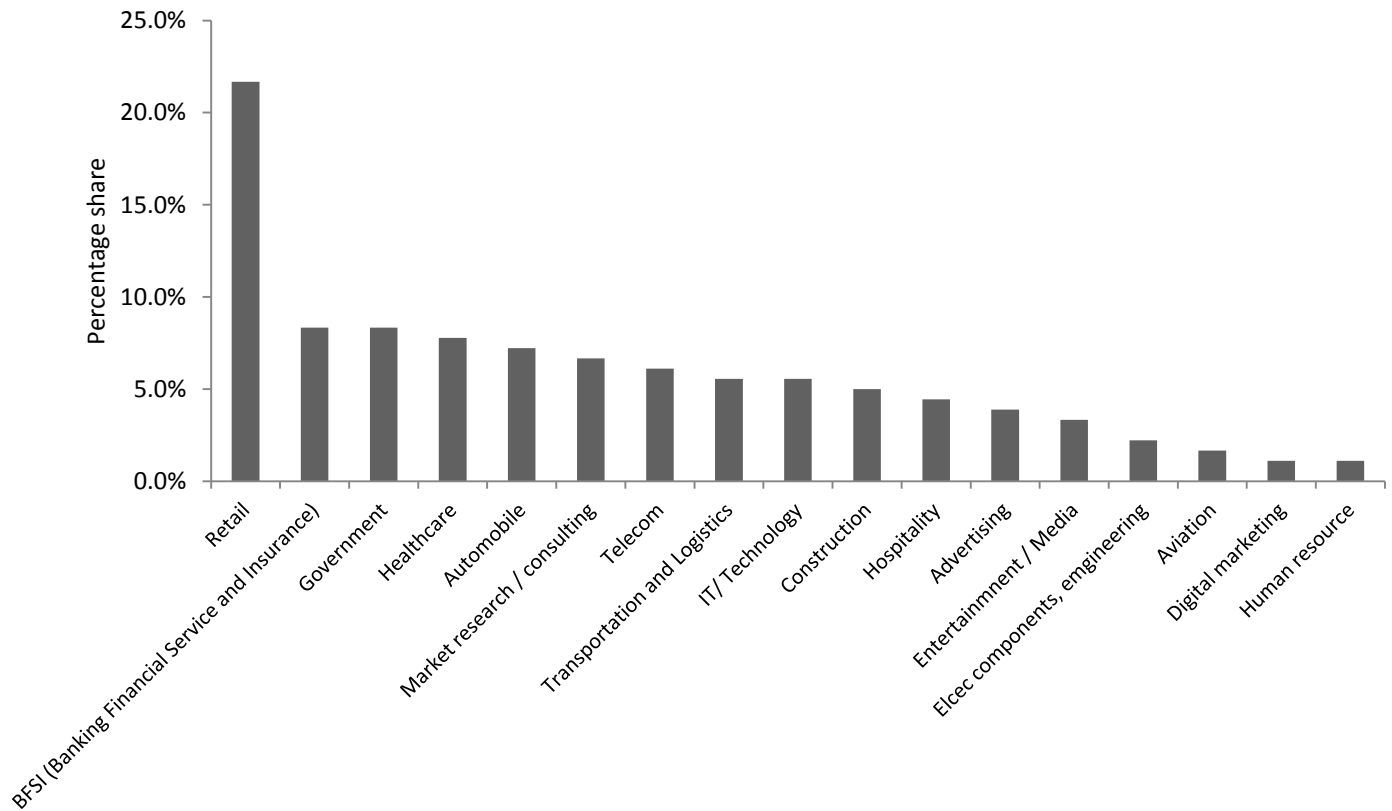

Figure 3: Representation by sector

(Note: they add up to more than 100% due presence in multiple sectors of some)

Leaders are the highest users of data for taking almost all-marketing decisions. Both big and small organizations need to understand their customers well, and data-driven marketing can help grow their customer base and satisfaction.

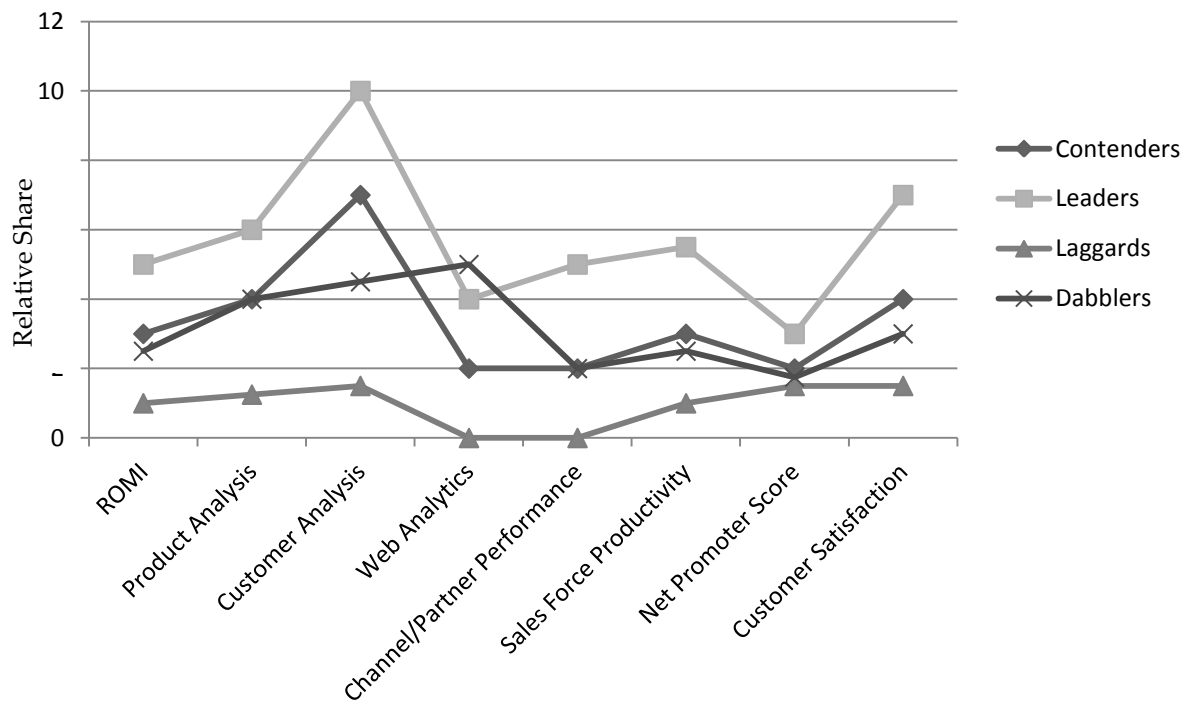

Figure 4: Extent of Data Driven Marketing decisions

#### 4.2 Data Analysis

##### Laggards

The companies that fall into the laggard's category employ manual marketing efforts involving employees acting on their own (62%). 26% of respondents do not use Big Data at all. According to the survey conducted, 48% of respondents who fall into the laggard category are from middle management, followed by senior management (38%) and then junior management (17%). 47% of the respondents falling in the laggards category represent organisations have an employee base of less than 50.

Majority of the laggards are from retail, government and automobile sectors. The major sources of data about customers are Social Media (19%), Point-of-sale data (18%) and Published data (17%). Laggards follow a very scattered pattern for data collection. Major challenges in using big data for marketing analytics in laggard's organization are: support for the cause of marketing analytics, availability of data for marketing analytics, a variety of data necessary for marketing analytics, the speed of availability of data, availability of hardware and software platforms and skill set/expertise for marketing analytics.

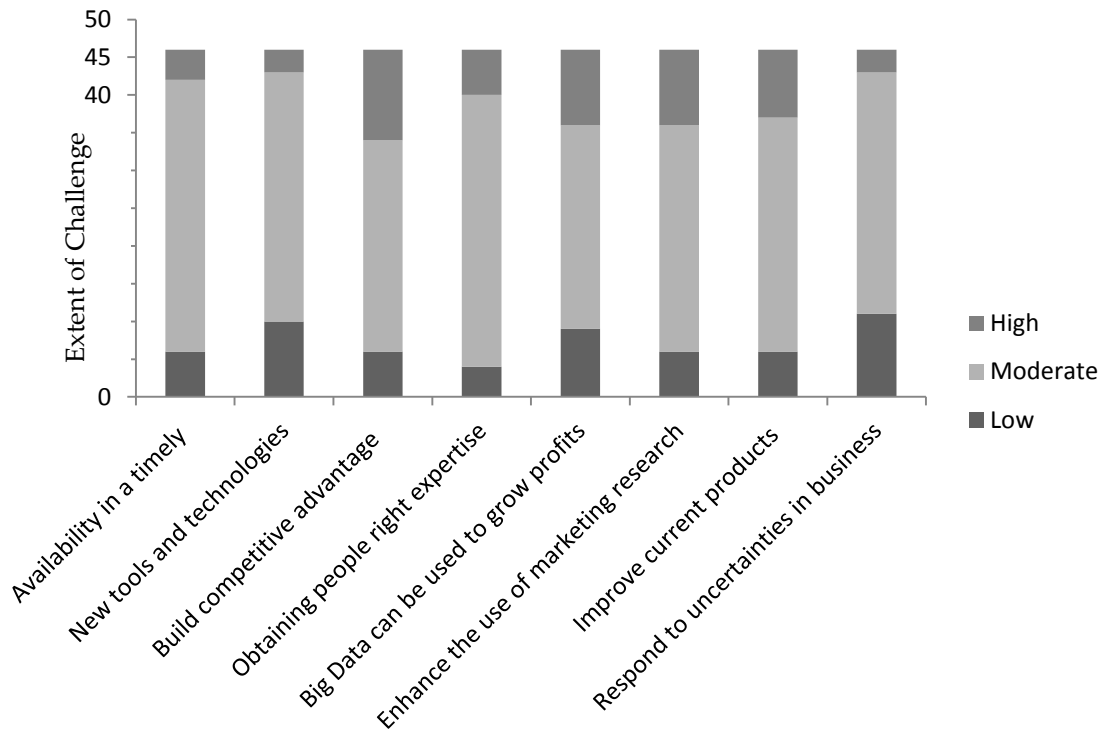

Figure 5: Challenges faced by Laggards for DDM

### Dabblers

According to the survey, 44% of respondents who fall into the dabblers category are from middle management, followed by senior management (33%) and then junior management (23%). 34% of the respondents falling in the dabbler category have an employee base between 100 – 500 employees and 27 % of the respondents falling in the laggard category have an employee base above 500. The majority of dabblers are from the retail sector. The major source of data about customers comes from Point-of-sale data (20%), Published data (19.6%) and Social Media (19.6%). They follow a very erratic pattern for data collection.

Major challenges in using big data for supporting marketing analytics in the Dabblers category of organizations is the availability of data for marketing analytics, variety of data necessary for marketing analytics, speed of availability of data for marketing analytics, availability of hardware and software platforms, funding for marketing and skill set/expertise for marketing analytics. A company in the Dabbler's category employs manual marketing efforts with employees acting on their own (59%). Projects are outsourced and the quality of data delivered is questionable.

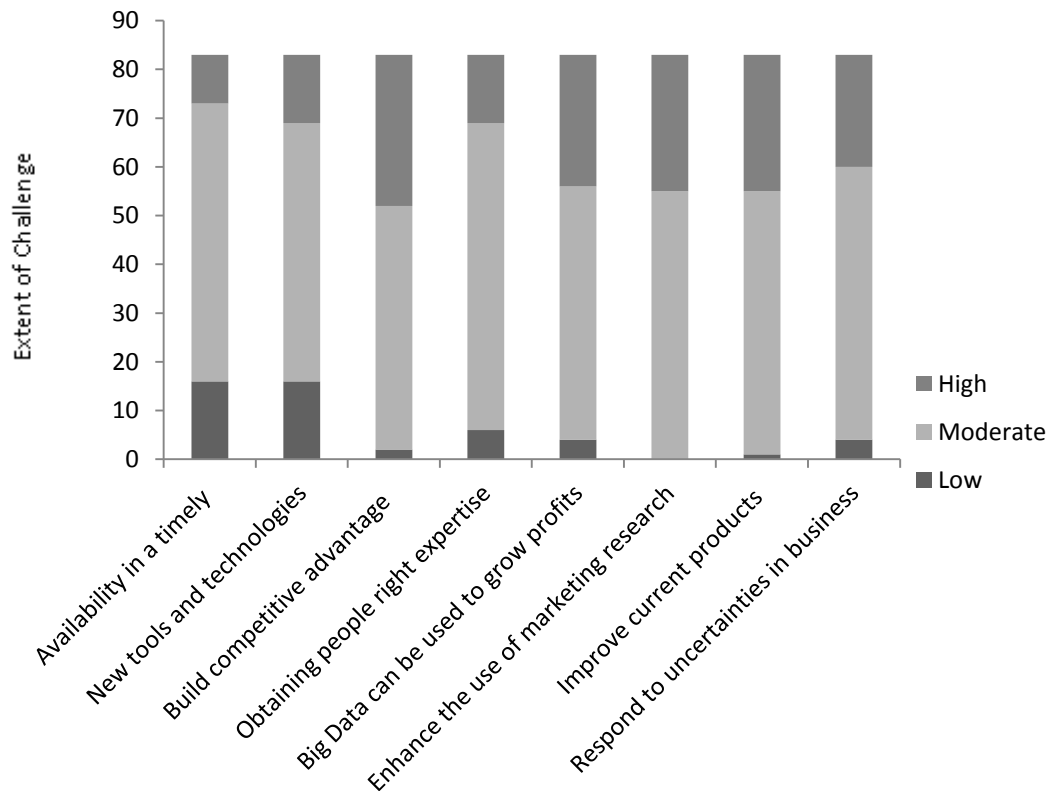

Figure 6: Challenges faced by Dabblers for DDM

## Contenders

According to the survey, 50% of respondents who fall into the Contenders category are from middle management, followed by senior management (30%) and then junior management (20%). 40% of the respondents in the contender's category have an employee base between 100 – 500 employees and 20% have an employee base above 500. The majority of Contenders are from Healthcare, Technology, Retail, and Government. The primary source of data about customers comes from Point-of-sale data (25%), Published data (30%) and Social Media (12%).

Contenders regularly use analytics for driving most aspects of the business. They act as change agents, positively disrupt the status-quo and are ready to invest in building digital marketing acumen across the team. In these organizations, efforts are under way to bring customer-facing channels together with common data and

applications. The staff is trained to manage these processes. Automation is promoted, and integration of various forms of engagement—such as mobile, web, social, video, etc. is implemented. Digital marketing campaigns are more focused and responsive to market needs. Metrics to measure and evaluate marketing activities are adopted to continuously optimize marketing programs.

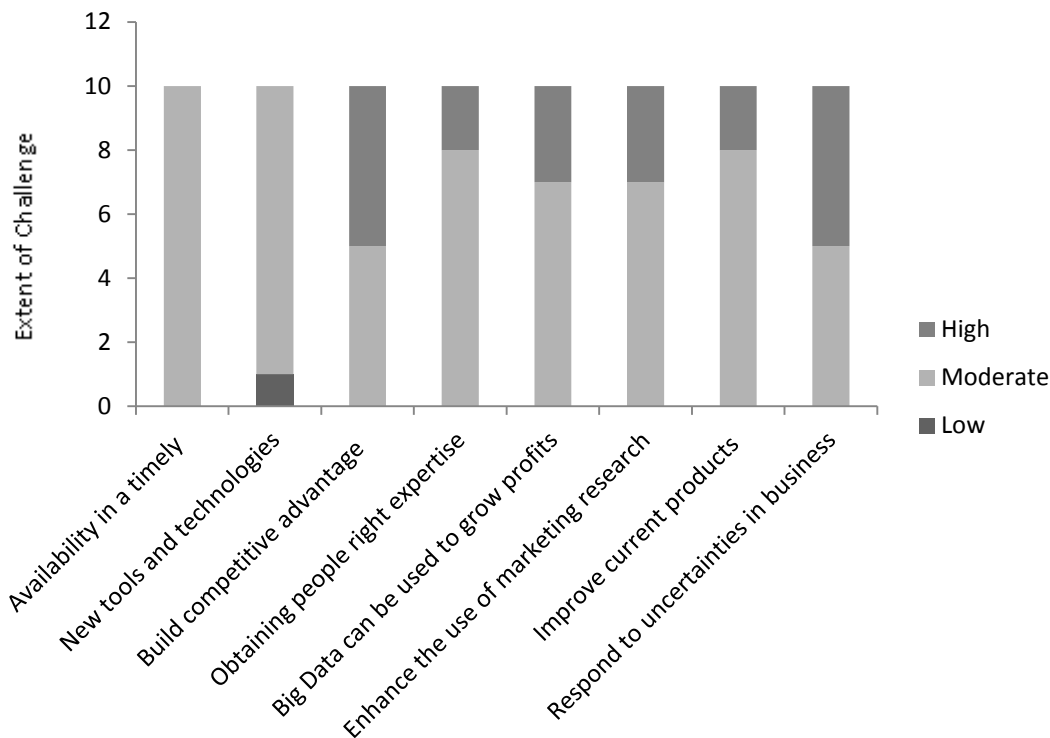

Figure 7: Challenges faced by Contenders for DDM

**Leaders**

Survey results indicate that 48% of the respondents in the leaders category are from middle management, followed by senior management (35%) and then junior management (17%). 48% of the respondents in the leaders category have an employee base of 500 -1000 or above. 22 % of the respondents within this category are medium to small players. Majority of leaders (59%) are from the retail, banking & insurance and transportation & logistics sectors. The major sources of data about

customers are Point-of-sale data (20%), Published data (19.6%) and then Social Media (19.6%).

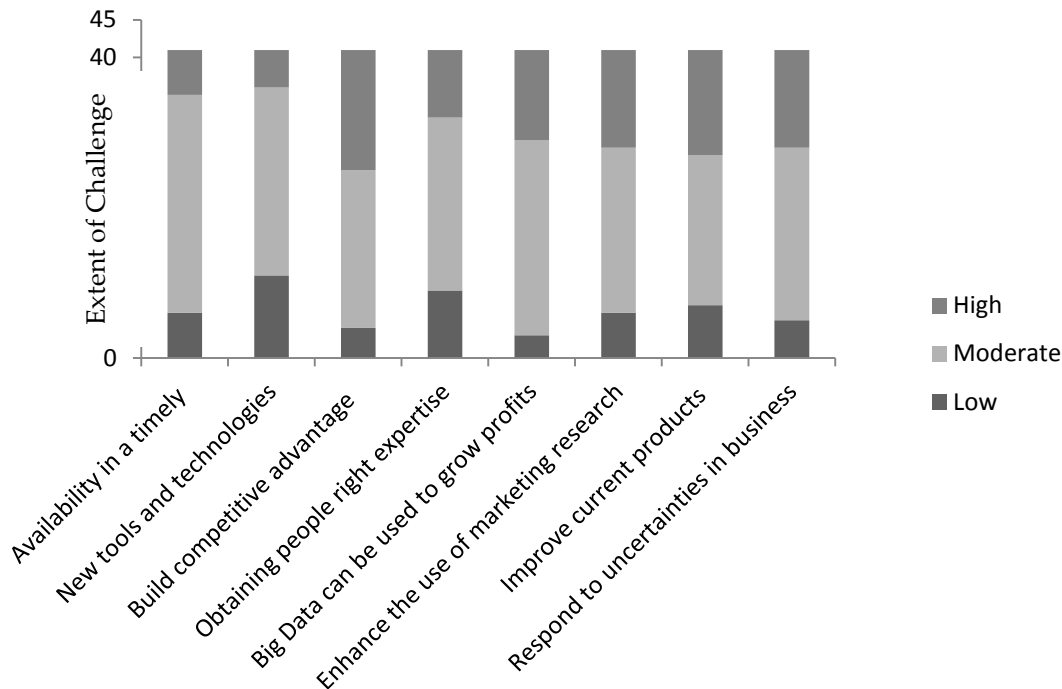

Figure 8: Challenges faced by Leaders for DDM

## STUDY IMPLICATIONS

Organizations need to work towards aligning their processes, capabilities, infrastructure and talent to realize the full potential of marketing analytics. Though data-driven marketing brings in a new perspective to businesses, a healthy balance between analytics and decision maker's intuition is the key to success. Leaders and Contenders who use data for being customer-centric marketing need to listen to the voice of the customer to gain insights which data alone cannot capture.

Contrary to the leaders and contenders, many companies are still dragging their feet i.e. Dabblers and Laggards. Such players need to build data-driven expertise and initiate pilot projects i.e. starting small and then rolling it out later. An iterative and incremental approach is the need of the hour, even if it has to start with baby steps, to invest and reap the fruits of data driven marketing.

Organizations need skill, expertise, funding, tools and technology as DDM is still at a nascent stage. Employees need to be trained and motivated to take part in data driven initiatives. It is essential to bring about a cultural shift in the organization. The biggest challenge is to bring all the scattered data



to a single platform so a complete picture of customers and their needs can be understood, to provide a seamless experience for growing customer equity and brand equity.

## LIMITATIONS AND CONCLUSIONS

### **Limitations:**

As a result of the storming digital age and the development of analytics, the process of decision-making has gained significant importance. Judgment and intuition too are critical to the process. Choosing an appropriate action cannot be done strictly on a rational basis. But the irony of the digital age is that instead of humans guiding and instructing the machines, the machines now advise humans in taking the decisions. Another challenge of explosion of data and related field of analytics has resulted in a dearth of data analysts. 74% of the companies are unable to recruit data scientists. The main reason for this imbalance is a scarcity of statisticians seeking analyst jobs. The corporate world is struggling to seek employees who can analyze and interpret big data simultaneously.

Security and Trust add a new challenge; the biggest concern is protecting the avalanche of data while also leveraging it for strategic decision making. Unfortunately, the information stored is highly vulnerable to cyber-attacks and breaching. Thus, there is a probability that any information provided to a third party could be leaked, resulting in distrust amongst customers or competitive disadvantage. Companies often do not have the appropriate platform to collect and manage data across the entire organization. This makes it difficult for the enterprise to work with huge volumes and high velocity of data for real-time analysis.

Another issue is the difficulty in seamlessly transferring data behind firewalls in a secure fashion for cloud computing. Accenture and Siemens have developed a Smart Grid Field to focus on services provided for data management and integration. Lastly, data collecting tools are imprecise at many times; this is a major concern for social media companies intending to gather valuable insights from the huge amount of big data.

### **Conclusion:**

A study published by the Darden foundation suggests that the road map for implementing marketing analytics requires companies to look at three things: Organizational structure, organizational change and the analytics process itself (Paul W. & Rajkumar V., 2014). Before any program is implemented, it is imperative that there is clarity on what DDM is expected to achieve. Once the organizational structure is deemed fit to support the program, it is equally essential to look at the culture of the organization. Additionally, efforts must be devoted towards combining data and heuristics.

The research results show that better-performing companies are characterized by a more sophisticated analytical planning process. Lower-performing firms should realize and acknowledge this competitive advantage and identify ways how to integrate business analytics into performance management of organization (Hauser, 2007). Educational institutes of higher learning can play a major role by internalizing analytics into their overall curriculum to meet the demands of world that's already immersing in digitization (Klatt, Schlaefke, & Moeller, 2011).

## REFERENCES

- 2015.<[http://viewer.media.bitpipe.com/1033409397\\_523/1268757993\\_85/IBMDDataDrivenMarketingAb erdeen.pdf](http://viewer.media.bitpipe.com/1033409397_523/1268757993_85/IBMDDataDrivenMarketingAb erdeen.pdf)>
- 4 Important Advantages of Data-Driven Marketing for Your Organization. (2012). Retrieved from <http://eleventygroup.com/site/2012/08/15/4-important-advantages-of-data-driven-marketing-for-your-organization/>
- Advertising, 23(7), 10. Retrieved from Braverman, S. (2015). Global review of data-driven marketing and advertising. *Journal of Direct, Data and Digital Marketing Practice*, 16(3), 181-183. doi:<http://dx.doi.org/10.1057/dddmp.2015.7>
- Agrawal, D. (2014). Analytics based decision making. *Journal of Indian Business Research*, 6(4), 332-340.
- Al-Darweesh, Shemmah. "5 Ways Data Is Making Marketing Scary Effective". Convirza. N.P., 2015. Web. 22 Feb. 2016.
- Bhandari, R., Singer, M., & Van der Scheer, H. (2014, June). Using marketing analytics to drive superior growth. McKinsey & Company.
- Blogs.teradata.com,. "Data-Driven Marketing Step Three: Untangle the Data Hairball | Teradata Applications". N.P., 2016. Web. 22 Feb. 2016.
- BludKai. 9th June, 2015. "Exploring Trends and Impact of Data-Driven Marketing." Interactive Advertising Bureau. June 2013. <http://www.iab.net/media/file/dataimpactsurveyjuly2013.pdf>
- Bose, R. (2009). Advanced analytics: opportunities and challenges. *Industrial Management & Data Systems*, 109(2), 155-172.
- Braverman, S. J. "The Global Review of Data-Driven Marketing and Advertising." Accenture. October 2014. GLOBAL DMA. THE WINTERBERRY GROUP. 9th June, 2015. <http://www.accenture.com/sitecollectiondocuments/pdf/accenture-gdma-winterberry-group-global-review-data-driven-marketing-advertising.pdf>
- Budden, R. (2013). Real-time marketing: Instant response requires cultural change by brand owners. FT.Com, Retrieved from <http://search.proquest.com/docview/1339023604?accountid=131193>
- Chaturvedi, A. (2015, Feb 25). Future group to build more data-driven, customer-centric processes in line with changing consumer mindsets & behaviour jobs].*The Economic Times (Online)* Retrieved from <http://search.proquest.com/docview/1657643270?accountid=131193>
- Chismar, W. G., & Wiley-Patton, S. (2003, January). Does the extended technology acceptance model apply to physicians? In *System Sciences, 2003. Proceedings of the 36th Annual Hawaii International Conference on (pp. 8-pp)*. IEEE.
- Consumer behavior is changing with internet penetration'. (2012, Nov 20).*Businessline* Retrieved from <http://search.proquest.com/docview/1323132943?accountid=131193>
- Devi, S. (2015). The big data-driven business: How to use big data to win customers, beat competitors and boost profits. *Research Technology Management*, 58(3), 66-67. Retrieved from <http://search.proquest.com/docview/1682657653?accountid=131193>
- Farris, P. W., Bendle, N., Pfeifer, P., & Reibstein, D. (2010). *Marketing metrics: The definitive guide to measuring marketing performance*. Pearson Education.
- Fitzgerald, M. (2015). How to hire data-driven leaders. *MIT Sloan Management Review*, 56(3), 0. Retrieved from <http://search.proquest.com/docview/1670982236?accountid=131193>
- Forbes.com,. " Data Driven And Digitally Savvy: The Rise Of The New marketing Organization" 2015
- Forbes.com,. "Forbes Welcome". N.P., 2016. Web. 22 Feb. 2016.

- Friedrich, R., Gröne, F., Koster, A., & Le Merle, M. (2011). Measuring industry digitization: Leaders and laggards in the digital economy. Booz & Co., December, 13.
- Ganesh, U. (2014, Nov 03). The changing consumer behavior in a digital economy. Financial Express Retrieved from <http://search.proquest.com/docview/1619242109?accountid=131193>
- Gordon, A. (2013, September 23). Analyzing customer behavior in retail. Business Standard. Retrieved March 17, 2016, from [http://www.business-standard.com/article/management/analysing-customer-behaviour-in-retail-113092200710\\_1.html](http://www.business-standard.com/article/management/analysing-customer-behaviour-in-retail-113092200710_1.html)
- Hauser, W. J. (2007). Marketing analytics: the evolution of marketing research in the twenty-first century. *Direct Marketing: An International Journal*, 1(1), 38-54.
- Hofacker, C. F., Malthouse, E. C., & Sultan, F. (2016). Big data and consumer behavior: Imminent opportunities. *Journal of Consumer Marketing*, 33(2), 89-97.
- Holden, R. J., & Karsh, B. T. (2010). The technology acceptance model: its past and its future in health care. *Journal of biomedical informatics*, 43(1), 159-172.
- IBM CMO Study, 2011. "From Stretched to Strengthened". Retrieved from [ibm.com/cmstudy2011](http://ibm.com/cmstudy2011)
- i-SCOOP, "Data-Driven Marketing: The State and Drivers of Data Marketing." N.P., 2015. Web. 22 Feb. 2016.
- Jones, K. (2017). Study: Data-Driven Marketing Drives Engagement and Market Growth | KoMarketing. [online] KoMarketing: B2B Search, Social, & Content Marketing. (Jones, 2017)
- Klatt, T., Schlaefke, M., & Moeller, K. (2011). Integrating business analytics into strategic planning for better performance. *Journal of business strategy*, 32(6), 30-39.
- Kumar, V., Chattaraman, V., Neghina, C., Skiera, B., Aksoy, L., Buoye, A., & Henseler, J. (2013). Data-driven services marketing in a connected world. *Journal of Service Management*, 24(3), 330-352. doi:<http://dx.doi.org/10.1108/09564231311327021>
- Lindsay, Kevin, and Follow @. "The Future Of Data-Driven Marketing | Adobe." Digital Marketing Blog by Adobe. N.p., 2015. Web. 22 Feb. 2016.
- Marshall, A., Mueck, S., & Shockley, R. (2015). How leading organizations use big data and analytics to innovate. *Strategy & Leadership*, 43(5), 32-39.
- McPherson, D. (2015). Data-driven marketing continues the steep ascent. Response: Multi - Channel Direct <http://search.proquest.com/docview/1675171568?accountid=131193>
- Michele, Ian. "Data Driven Marketing." October, 2014. Aberdeen Group. June 9th.
- Newman, Daniel. "10 Top Trends Driving the Future of Marketing", Forbes, March 2015, <http://www.forbes.com/sites/danielnewman/2015/04/14/10-top-trends-driving-the-future-of-marketing/>
- Paul W. & Rajkumar V. "Implementing Marketing Analytics". June 3, 2014. University of Virginia Darden School Foundation, Charlottesville, VA.
- Proquestbus.safaribooksonline.com,. "Customer Innovation > 01 Connect Using The First Lens > Immersive Customer Understanding - Pg. : Safari Books Online". N.p., 2016. Web. 22 Feb. 2016.
- Rani, L. S., & Baranidharan, K. (2013). CONSUMER PURCHASING DECISION-MAKING PROCESS W.R.T. FMCG. *International Journal of Retailing & Rural Business Perspectives*, 2(1), 309-313. Retrieved from <http://search.proquest.com/docview/1648682119?accountid=131193>
- Renilde De Wit. (n.d.). Data-driven marketing: state, benefits and drivers. Retrieved from <http://www.i-scoop.eu/data-driven-marketing-the-state-benefits-and-drivers-of-data-marketing/>
- Retrieved from <http://www.forbes.com/sites/forbespr/2015/01/08/new-report-shows-data-driven-marketing-drives-customer-engagement-market-growth/#6b3d7c2d3faa>
- Rogers, E. M. (2004). A prospective and retrospective look at the diffusion model. *Journal of health communication*, 9(S1), 13-19.
- Rohm, A., Kaltcheva, V. D., & Milne, G. R. (2013). A mixed-method approach to examining brand-consumer interactions driven by social media. *Journal of Research in Interactive Marketing*, 7(4), 295-311. doi:<http://dx.doi.org/10.1108/JRIM-01-2013-0009>
- Schulze, C., Schöler, L., & Skiera, B. (2015). Customizing social media marketing. *MIT Sloan Management Review*, 56(2), 8-10. Retrieved from <http://search.proquest.com/docview/1650910666?accountid=131193>
- Scott Brinker and Laura McLellan, 2014. "The rise of the Chief Marketing Technologist". Retrieved from <https://hbr.org/2014/07/the-rise-of-the-chief-marketing-technologist>
- Simons, R. H.; Thompson, B. M (1998). Strategic determinants: the context of managerial decision making. Retrieved from <http://search.proquest.com/buscoll/docview/215865620/5D73472ACF234CE6PQ/5?accountid=131193>
- Sundsøy, Pal. Bjelland, Johannes. "Big Data-Driven Marketing: How machine learning outperforms

marketers' gut-feeling". MIT MEDIA LAB. 2014. Telenor Research Norway. 9th June, 2015. <http://web.media.mit.edu/~yva/papers/sundsoy2014big.pdf>

Theirl, Dan. "White Paper: Data Driven Market Decisions in the Retail Industry". eTail West. May 2015. RubicLOUD, 9th June, 2015.< <http://rubikloud.com/wp-content/uploads/2015/05/Rubi-whitepaper-DataDriven-v10.pdf>>

Top 10 Benefits of Data-Driven Market Segmentation - Grips. (2014). Retrieved from <https://www.grepsr.com/top-10-benefits-data-driven-market-segmentation-2/>

Venkatesh, V. (2000). Determinants of perceived ease of use: Integrating control, intrinsic motivation, and emotion into the technology acceptance model. *Information systems research*, 11(4), 342-365.

## **BUILDING BRAND LOYALTY THROUGH SOCIAL MEDIA IN TIMES OF ECONOMIC CRISIS: A GENDER AND GEN Y PERSPECTIVE OF LUXURY FASHION CONSUMERS IN SOUTH EAST EUROPE**

**Gubatova, Zlatina<sup>1</sup>; Kapoulas, Alexandros<sup>2</sup>; Cheng, Ranis<sup>3</sup>**

<sup>1</sup>Management School, South East European Research Centre, an International faculty of the University of Sheffield, Thessaloniki, Greece

<sup>2</sup>Business Administration and Economics Department, City College: International faculty of the University of Sheffield, Thessaloniki, Greece

<sup>3</sup>Management School, The University of Sheffield, Sheffield, UK

### **ABSTRACT**

The research explores gender and social media role for building brand loyalty among Generation Y consumers. This is further augmented by studying the economic crisis impact on luxury consumption in Romania, Bulgaria and Greece. The research objectives are: 1) Explore gender differences in luxury fashion consumption among Generation Y consumers; 2) Explore gender differences among Generation Y in building brand loyalty towards luxury fashion brands through Social Media and 3) Unearth luxury consumer behaviour in SEE given the economic crisis. Qualitative interpretative methodology: focus groups, in-depth interviews and on-site questionnaire investigation, is considered appropriate for providing more vivid picture of luxury consumer behaviour in the selected countries.

Findings reveal that while the intrinsic product aspect is important, males emphasized on traditional in-store environment and females highlighted the positive purchase experience and brands' story. There is a shift from males' independent nature to feeling of belongingness and respect for luxury's dream factor. Analysis of economic crisis showed that generation Y consumers value the prestigious traits of luxury fashion brands, emphasizing on value for money. This contradicts the belief that the economic crisis urged them to turn to counterfeits. The present research surpasses prior studies by exploring males and females who belong to Generation Y. Specifically, advancement in academic knowledge stems from studying economic crisis and social media impact on building brand loyalty in South East European countries.

*Keywords: Social Media, gender, brand loyalty, luxury fashion, South East Europe, economic crisis, generation Y*

## INTRODUCTION

Brand loyalty has been extensively studied in marketing literature (Jacoby and Kyener, 1973; Aaker, 1991; Oliver, 1999; Gambetti *et al.* 2012; Harmeling *et al.* 2015) and later in SM (Hawkins and Vel, 2013; Arya and Srivastava, 2015). SM reshaped the manner brands communicate with customers (Deloitte, 2016). However, the question is: *what happens when luxury, defined by tradition and heritage, meets SM?* Even though luxury fashion brands have long resisted the adoption of SM, being afraid of diluting their exclusivity, change in consumer behaviour and impact of the economic crisis forced the notion that SM is indeed the seal necessary for enhancing customer-brand relations (Judson *et al.* 2012).

Further, despite the increased academic interest in gender differences, research is needed to grasp the impact of gender in consumer behaviour (Levy and Loken, 2015). These findings are yet to be explored with Gen Y online consumer (Nadeem *et al.* 2015). Henceforth, the main question of the study is: *What is the role of SM among Gen Y males and females in building brand loyalty towards luxury fashion brands in SEE economic crisis context?*

## THE CONCEPT OF LUXURY

Deriving from Latin etymology "*Luxus*" is considered the root of the term "*luxuria*". It refers to "*any intense desire or craving for self-gratification*" (Corbellini and Saviolo, 2009, p. 20). From this perspective luxury has two opposing meanings: *lux* or *luxus*, viewed as splendour or light and *luxuria* being associated with the negative concept of sin, wicked and excess (Cristini *et al.* 2017). A core characteristic that marks luxury from other product categories (necessities) is that consumers derive positive emotions from the luxury experience.

Globalization impact is evident in new consumer segments from various geographies (Liu *et al.* 2016), who are in pursuit of different values from the luxury experience (Sauer and Teichmann, 2013). As a result, luxury brands stumbled upon a realization that establishment of brand loyalty is of paramount importance for their long-term success (Kim and Ko, 2012).

## BRAND LOYALTY TOWARDS LUXURY BRANDS

Brand loyalty is defined as "[...] a measure of the attachment that a customer has to a brand" (Aaker, 1996, p. 39) and "[...] it occurs when favourable beliefs and attitudes for the brand are manifested in repeat buying behaviour" (Keller, 1993, p. 8). The key point is that a loyal customer and a satisfied customer are two different terms (Kabiraj and Shanmugan, 2011). Owning luxury brands implies significant financial investments. Luxury brands also offer status elevation to their owners. Hence, consumers ought to demonstrate higher brand loyalty towards these brands, as opposed to regularly purchased ones.

Since perceived quality and customer service are key brand building activities, consumers would likely develop strong brand loyalty towards luxury brands (Jung and Shen, 2011). Brand credibility, perceived value, and prestige are important facets of strong brands (Baek *et al.* 2010). Hence, because luxury brands encompass more symbolic meanings, consumers assign greater importance to the purchase of luxury and the effect of trust-loyalty link is augmented (Hur *et al.* 2014). Essentially, confidence in brands' image, thorough brand knowledge, trust, brand credibility and emotional attachment are strong predictors of brand loyalty. Although the discussion about brand loyalty is not exhaustive, it is also important to understand the paradox when heritage meets social.

## **THE PARADOX: SOCIAL MEDIA AND LUXURY BRANDS**

The distant approach that luxury brands exercise (Okonkwo, 2010) is on the opposite of the digital world nature, characterized by availability, easiness and accessibility (Kapferer and Bastein, 2012). A major crux of the debate, thus, is how an industry defined by heritage and conventional way of storytelling can transmit its *DNA* to succeed in today' reality of increasingly digital consumer (Wells, 2017). Then again, SM users are not always actual customers, because this channel does not allow for the same intimacy levels (Ang, 2011). However, through SM platforms consumers can share their product and service experiences, allowing fashion brands to apprehend consumer attitudes and boost customer-brand relationships (Nadeem *et al.*2015). Additionally, whilst brand excellence is a pivotal facet of luxury fashion, brands must undertake sustainable strategies to convey their old story in new ways (Cristini *et al.* 2017) to build brand loyalty.

### *Social media and brand loyalty towards luxury fashion brands*

Initially perceived as a 'gimmick', Instagram quickly proved useful platform for showcasing new collections, offering customers a lifestyle (Roderick, 2016). Another trend in SM usage is to gain inspiration for ideas (Deloitte, 2016). It is no wonder luxury fashion brands have acknowledged the potential of Pinterest as a digital stage for showcasing their products (Doran, 2012). Other constructs such as entertainment, interaction, customization and e-WOM also contribute for engaging consumers in honest and friendly dialog (Kim and Ko, 2012). Thereafter, online brand-customer interaction, customer-to-customer communication, brand recognition and constant brand exposure are core pillars of brand loyalty (Choi *et al.* 2016; Godey *et al.* 2016).

## **THE ROLE OF GENDER**

A core driver for males' luxury consumption is perceived brand exclusivity, an exquisite piece of art that helps the consumer to broadcast his status and stand out from the crowd (Roux *et al.* 2017). Conversely, women's nature to boost their body appearance through self-verification of the self-

concept triggers them to display luxury brands as a signalling system to other women (Wang and Griskevicious, 2013). Creating a personal style and public image are essential steps in the process of fashioning a social identity for women (Appleford, 2016). Nevertheless, growth in males' apparel market (Shabat, 2015) and males' increased demand in terms of customized clothing indicate increased fashion consciousness among male consumers (Lertwannawit and Mandhachitara, 2012). Existing literature also demonstrates gender differences in SM behaviour.

Endorsing to their interdependent nature (Melnyk *et al.* 2009), women seek interpersonal connectivity, self-discovery and maintaining their existing relationships in social networking sites (Haferkamp and Papadakis, 2012). Hence, females hold more favourable attitudes towards one-to-one communication, emotional and social-experiential aspects of the shopping experience. On the other side, male consumers are concerned with the functional product appeals (Levy and Loken, 2015). Hereafter, compared to males' pragmatic purchases, females use the Internet for social support, and place higher value on e-WOM (Folse *et al.* 2012). Apart from gender, age is also an important aspect in marketing studies, as both are concerned with understanding the consumer perspective (Lee and Workman, 2015).

## GENERATION Y LUXURY CONSUMERS

Focus of the study is placed on "*Peter Pan Generation*" (Bolton *et al.* 2013, p.16), born in the period 1981-1999, currently experiencing their 20s and 30s (Nadeem *et al.* 2015). Whilst not representative for the richest of the rich (Truong, 2010), with their growing purchase power and increased expenditure on luxury brands (Kradisching, 2015), this cohort will achieve the largest share of the consumer market (Yeoman and Beattie, 2006). Being greatly brand and fashion conscious, these consumers are regarded as "*the future of prestige*" (Galloway, 2010, p. 2). The effect of these factors makes the study of Generation Y consumers even more important in the context of the challenging economic environment (Giovannini *et al.* 2015).

## THE CASE OF SOUTH EAST EUROPE

Forecasts indicate that between 2017-2019 the sales of luxury goods in Bulgaria will grow with 2.4% (Conlumino, 2015). With respect to Romania, even though in 2017 GDP growth will be lower than 2016, +3, 76% (Statista, 2016), the luxury market has good prospects for bringing back its past days of glory. Further, *there is also society pressure for certain appearance and Gene Y perception of luxury as a sign of success, high standards, and expression of self-esteem* (Zaharia and Zaharia, 2015). *As of Greece, the luxury goods sector is expected to be the second largest in the group of specialist retailers, with 19,5% market share* (Conlumino, 2015). Moreover, whilst the economic crisis forced some consumers to turn to



counterfeits, there is still a consumer segment that stays truly loyal to their favourite luxury fashion brands (Priporas *et al.* 2015).

*In addition, what triggers the interest in this research is Generation Y purchase motives, besides their parents' motives (Shea, 2013), is that they represent a huge percentage of SM users in the region (Statista, 2016), as presented in table 1.*

Daily Internet usage (by age)

Bulgaria		Romania		Greece	
16-24	25-34	16-24	24-35	16-24	24-35
97%	92%	93%	84%	89%	93%

*Table 1. Daily Internet usage (by age)*

## RESEARCH METHODOLOGY

A limited number of studies in luxury consumption (Eng and Bogaert, 2010; Jiang and Cova, 2012; Radòn, 2012; Choi *et al.* 2016), SM and its impact on brand loyalty (Heinonen, 2011; Palmer and Huo, 2013; Alon *et al.* 2014) are performed using the inductive method. As academic literature lacks understanding regarding SEE luxury fashion consumption, it is essential to obtain profound understanding of people's experiences, perceptions, feelings and desires (Calder, 1977). The most outstanding avenue for future research, namely: *"To perform luxury research, it also is necessary to analyse consumers' own perceptions, rather than insights from managers of luxury companies or marketing gurus, especially if those sources tend to propose a single, personal view of luxury"* (Kapferer and Laurent, 2014, p. 19) captures the core purpose of the present study: uncover details about a phenomenon about which little yet is known and understand individual customer views.

### *Focus groups and triangulation*

The research exploited the advantages of focus groups for exploring wider range of perspectives to gain initial understanding on the research topic (Byers and Wilcox, 1991). The main study will rely on triangulation to reduce the risk of presenting findings with intrinsic biases (Joslin and Müller, 2016). Triangulation will be achieved through individual in-depth interviews, followed by exit (on-site) questionnaire investigation. Individual in-depth interviews will aid more profound understanding of participants' experiences and views, considered significant for the research (Hunt, 2011).

### *Sample*

Selection criteria for both studies are based on non-probability purposive sampling to secure sample cohesion for populations defined by rarity (Lucas, 2014). The researcher cannot opt for generalizable statements, as selected samples are not representative for the wider population segment (Orange, 2003). Purposive samples are useful in exploring certain phenomenon by grasping similarities and

differences between different groups' viewpoints (Brotherson and Goldstein, 1992). Pilot study took advantage of segmentation (Krueger, 2000), dividing participants in two focus groups per country: males and females. Each group consisted of 5 participants, making a total of 10 participants per country.

#### *Data collection and analysis*

Data collection was initiated by asking the Head of BAED for approval to visit classes of Undergraduate and Postgraduate students in each of the countries. Additional consent was asked from local Program Coordinators in Romania and Bulgaria. After reviewing questionnaires, students were approached via their university e-mail or personally during class breaks, inviting them to participate in focus groups. Analysis followed coding and thematic categorization, and deployed the long-table approach.

## FINDINGS

#### *Customer desires*

The materialistic characteristic of consumers triggers them to purchase luxury brands to achieve happiness (Sung *et al.* 2015). Likewise, young Greek females' desire is routed in the positive emotion from luxury fashion consumption (Diaconu, 2015) and perception of luxury as light (Kapferer, 1997). A prominent example is: *"It sparkles [...] It's that shine, they are shining. Yeah...that's it, it's the shine [...] I like more the feelings, it's joy to...shop"* (GS13, female, 19). One Romanian female's view surpasses current knowledge on luxury consumer behaviour (Okonkwo, 2010): *"[...] I buy more the philosophy of the brand than the brand itself [...] There are many good brands, luxury brands that make bags. But the point of difference is that you buy their story, the way they communicate, the way they act with you, they trick in the store and so on [...]"* (RS29, female, 28). This indicates admiration towards brands' history, tradition and philosophy (Corbellini and Saviolo, 2009; Thakur and Kaur, 2015). Contradictory to Cross and Madson (1997) and Levy and Loken (2015), Greek males endowed characteristic of the *"bewitched consumer"* (Dion and Arnould, 2011, p. 32). Some examples include: *"[...] makes you feel like you are part of something...you are part of their club...you are part of their consumer, the consumer experience [...]"* (GS8, male, 20) and *"...A part of their club, a part of their family [...]"* (GS7, male, 19).

#### *Gender differences in Social Media brand exposure*

Romanian males demonstrated sufficient respect for luxury brands' *"dream"* (Seringhaus, 2002, p. 5): *"I also think that excessive marketing can even bring down the status of such luxury brands because they are supposed to be something special [...] I mean a brand that is certainly luxury should have this oral, like you want to touch them [...]"* (RS24, male, 23). Another surprising comment came from Greek males, who emphasized on a core luxury trait: one-to-one communication. It contradicts the belief that females

place higher value on this aspect (Levy and Loken, 2015): *“Much more prefer the offline approach. I would appreciate it more because online is much more impersonal [...] I don't like that. If I go to the store, and if you help me much more appreciated, much more”* (GS8, male, 20).

Romanian female's statement challenges the belief that consumers can fall under the spell of luxury brands only after personally experiencing the brands' magic (Okonkwo, 2010). Precisely: *“[...]after seeing a movie...made by Lagerfeld, the one with Cara Delevingne and Pharrell for the new collections, the one inspired by Sissy story [...] for me that succeeded in transmitting more emotion and more customer experience than going into a shop and buying a perfume or a scarf from Chanel [...]”* (RS31, female, 24). It goes beyond association of luxury stores' association with temple (Dion and Arounld, 2011), to recognize SM as a valuable platform for conveying brands' story (Cristini *et al.* 2017) to achieve emotional brand attachment (Walz *et al.* 2012).

#### *Social media impact on brand loyalty*

In contrast to existing knowledge (Godey *et al.* 2016; Choi *et al.* 2016), Greek females' statements indicated SM is unlikely to affect their brand loyalty, as they already possess solid brand knowledge (Kradischung, 2015). For instance: *“You know the brand”* (GS11, female, 20; GS12, female, 20). Whereas Bulgarian females outlined e-WOM: *“I think that this type of activity like sharing your brand experience with others would affect their brand loyalty [...] when you share your opinion in Social Media you actually change the views of other people [...]”* (BS16, female, 18), Romanian females elaborated to include videos, WOM, brand evangelists and the value of trust (Aaker, 1991; Hur *et al.* 2014). One view that captures the group's discussion refers to: *“[...] Actually that's how brands should use Social Media: as a kind reminder for their loyal customers [...] it's important to address to your loyal customers and maybe I think your loyal customers will be ambassadors for your brand [...] But it's about trust, it's about testimonial recommendation, personal recommendation”* (RS29, female, 28).

SM can be employed for persisting the experiential element of in-store environment (McDonald, 2016). Instead, Greek males insisted on quality, personal service and personal interaction (Kim *et al.* 2016). Finally, unconventional for their independent nature (Cross and Madson, 1997), Bulgarian males outlined brand and community belongingness and brand consistency: *“And also what the brand stands for...what are its values, how it makes people feel being part of [...] It's part of like...if Kanye West wears the Gucci jacket and you buy the same Gucci jacket then you kind of get to be part of his...it's not a real group...but you get to be part...closer to his level, like you are buddies now [...]”* (BS19, male, 19).

## THEORETICAL CONTRIBUTIONS AND CONCLUSIONS

The first objective explored Gen Y gender differences in luxury fashion consumption. Existing literature looks at cross-cultural differences in Western Balkan countries with no specific focus on gender and young consumers (Mehmedovic and Agic, 2015), compares Generation Y consumers and Baby Boomers (Diaconu, 2015) or is conducted among Romanian female consumers (Raluca *et al.* 2012; Ciornea, 2014). Prior research reveals young consumers' interest in the product aspect (Kim and Brandon, 2010) and lower attention to purchase experience (Shukla *et al.* 2016). Findings contradict what seems to be current knowledge. While participants emphasized on the intrinsic aspects, male consumers acknowledged terms as family and club, increased fashion consciousness and joy. Females outlined shine, joy and brands' story.

The second objective explored Gen Y gender differences in building brand loyalty towards luxury fashion brands through SM. The research contributes for better comprehension of consumer beliefs (Kim and Lee, 2015) and SM brand relationships (Han *et al.* 2010) in three aspects. First, studies in SEE neglect SM impact on luxury fashion brands. However, it appears that luxury brands' participation in SM is a match made in heaven. This is evident in respondent's admiration for Chanel online videos. Second, while findings comply with existing literature on males' lower interest in SM and pragmatic online purchases (Folse *et al.* 2012) it sheds light on one interesting aspect. Findings reveal males' aspiration for the luxury dream factor as opposed to females' quest for increased brand availability. The third finding challenges established knowledge on males' independent nature (Cross and Madson, 1997; Levy and Loken, 2015). That is, men brand loyalty is dependent on sense of family and community belongingness.

Finally, the third objective was to unearth economic crisis impact on SEE luxury consumer behaviour. Two main implications emerge from pilot study findings. First, economic downturn boosted consumer desire to show-off, demonstrate prestige and success (Jones, 2016). However, prestigious traits of luxury brands were acknowledged, but the show-off aspect received a negative "feedback". Yet, the crisis' sociological impact among genders remains open to debate. Second, findings reveal that both male and female participants have concern about receiving value for money. This contradicts current knowledge regarding increased counterfeit purchases in Romania and Greece (Chiriac, 2013; Priporas *et al.* 2015). All these topics will be explored further in greater depth in subsequent investigation stages in this longitudinal study. This will depict significant customer insights about social media, gender and economic crisis impact on brand loyalty towards luxury fashion brands.

## REFERENCES

- Aaker, D. (1996), "Measuring brand equity across products and markets", *California Management Review*, Vol. 38 No.3, pp. 102-120.
- Alon, A. et al. (2014), "Word-of-mouth rhetorics in social media talk", *Journal of Marketing Communications*, Vol. 20 No. 1-2, pp. 42-64.
- Ang, L. (2011), "Community relationship management and social media", *Database Marketing & Customer Strategy Management*, Vol. 18 No. 1, pp. 31-38.
- Baek, T. et al (2010), "The differential roles of brand credibility and brand prestige in consumer brand choice", *Psychology & Marketing*, Vol. 27 No. 7, pp. 662-678.
- Belk, R. (1988), "Possessions and the Extended Self", *Journal of Consumer Research*, Vol. 15 No. 2, pp. 139-168.
- BOLTON, R. N. ... et al, 2013. Understanding Generation Y and their use of social media: a review and research agenda. *Journal of Service Management*, 24 (3), pp. 245- 267 (Citation as instructed)
- Brotherson, M. and Goldstein, B. (1992), "Quality design of focus groups in early childhood special education research", *Journal of Early Intervention*, Vol. 16 No. 4, pp. 334-342.
- Byers, P. and Wilcox, J. (1991), "Focus Groups: A Qualitative Opportunity for Researchers", *The Journal of Business Communication*, Vol. 28 No.1, pp. 63-78.
- Calder, B. (1977), "Focus groups and the nature of qualitative marketing research", *Journal of Marketing Research*, Vol.14 No.3, pp. 353-364.
- Ciornea, R. (2014), "Marketing of Luxury Products. Doctoral Thesis Summary", Doctoral School of Economics and Business Administration. "Babeş-Bolyai" University of Cluj- Napoca
- Choi, E., et al., Explaining and predicting purchase intentions following luxury-fashion brand value co-creation encounters, *Journal of Business Research* (2016) (Citation as instructed)
- Conlumino (2015), "Retail Sales through Clothing, Footwear, Accessories and luxury Goods Specialists in Greece: Market Snapshot to 2019", available at: <https://www.businessresearchstore.com/product/235793-clothing++footwear++accessories+and+luxury+goods+specialists.html> (accessed 8th March 2017)
- Conlumino (2015), "Retail Sales through Clothing, Footwear, Accessories and luxury Goods Specialists in Bulgaria: Market Snapshot to 2019", available at: <https://www.globaldata.com/store/report/rt021115ms--clothing-footwear-accessories-and-luxury-goods-specialists-in-bulgaria/> (accessed 15th February 2017)
- Corbellini, E. and Saviolo, S. (2009), *Managing Fashion and Luxury Companies*, Etas, Italy.
- Cristini, H. et al (2017), "Toward a general theory of luxury: Advancing from workbench definitions and theoretical transformations", *Journal of Business Research*, Vol. 70, pp. 101-107.
- Cross, S. and Madson, L. (1997), "Models of the self: self-construals and gender", *Psychological Bulletin*, Vol. 122 No.1, pp. 5-37.
- Deloitte (2016), "Global Powers of Luxury Goods 2015: Engaging the future luxury consumer", available at: <https://www2.deloitte.com/content/dam/Deloitte/global/Documents/Consumer-Business/gx-cb-global-power-of-luxury-web.pdf> (accessed 16th February 2017)
- Diaconu, I. (2015), "New trends in the motivation behind buying luxury textile products", *International Journal of Economic Practices and Theories*, Vol. 5 No. 5, pp. 455-461.
- Dion, D. and Arnould, E. (2011), "Retail luxury strategy: assembling charisma through art and magic", *Journal of Retailing*, Vol. 87 No. 4, pp. 502-520.
- Doran, S. (2012), "What Pinterest Means For Luxury Brands", available at: <http://luxurysociety.com/en/articles/2012/04/what-pinterest-means-for-luxury-brands/> (accessed 19th February 2017)
- Eng, T. and Bogaert, J. (2010), "Psychological and cultural insights into consumption of luxury Western brands in India", *Journal of Customer Behavior*, Vol. 9 No.1, pp. 55-75.
- Eun Young Kim & Lynn Brandon (2010) Modelling Brand Equity for Lifestyle Brand Extensions: A Strategic Approach into Generation Y vs. Baby Boomer, *Journal of Global Academy of Marketing Science*, (Citation as instructed)
- Folse, J. et al (2012), "Psychological ownership a social marketing advertising message appeal? Not for women", *International Journal of Advertising*, Vol. 31 No. 2, pp. 291-315.
- Galloway, S. (2010), "Gen Y Affluents: Media Survey", available at: [https://issuu.com/l2-thinktank/docs/gen\\_y\\_affluents\\_dec2010](https://issuu.com/l2-thinktank/docs/gen_y_affluents_dec2010) (accessed 18th February 2017)
- Godey, B., et al., Social media marketing efforts of luxury brands: Influence on brand equity and consumer behavior, *Journal of Business Research* (2016), (Citation as instructed)
- Haferkamp, N. and Papadakis, A. (2012), "Men are from Mars, women are from Venus? Examining gender differences in self-presentation on Social Networking Sites", *Cyberpsychology, Behavior, and Social Networking*, Vol. 15 No. 2, pp. 91-98.

- Heinonen, K. (2011), "Conceptualizing consumers' dynamic relationship engagement: the development of online community relationships", *Journal of Customer Behavior*, Vol. 10 No. 1, pp. 49-72.
- Hunt, B. (2011), "Publishing Qualitative Research in Counselling Journals", *Journal of Counselling & Development*, Vol. 89 No. 3, pp. 296-300.
- Hur, W. (2014), "The role of brand trust in male customers' relationship to luxury brands", *Psychological Reports: Employment Psychology & Marketing*, Vol. 114 No. 2, pp. 609- 624.
- Jiang, L. and Cova, V. (2012), "Love of luxury, preference for counterfeits – a qualitative study in counterfeit luxury consumption in China", *International Journal of Marketing Studies*, Vol. 4 No. 6, pp. 1-9.
- Jones, O. (2016), "Why we Buy Luxury Goods in Times of Crisis? BigThink", available at: <http://bigthink.com/ideafeed/why-we-buy-luxury-goods-in-times-of-crises> (accessed 19th February 2017)
- Joslin, R. and Müller, R. (2016), "Identifying interesting project phenomena using philosophical and methodological phenomena", *International Journal of Project Management*, Vol. 34 No. 6, pp. 1043-1056.
- Jung, J. and Shen, D. (2011), "Brand equity of luxury fashion brands among Chinese and U.S. young female consumers", *Journal of East-West Business*, Vol. 17 No. 1, pp. 48-69.
- Kabiraj, S. and Shanmugan, J. (2011), "Development of a conceptual framework for brand loyalty: a Euro-Mediterranean perspective", *Brand Management*, Vol. 18 No. 4-5, pp. 285- 299.
- Katherine Appleford (2016) Being seen in your pyjamas: the relationship between fashion, class, gender and space, *Gender, Place & Culture*, 23:2, 162-180, DOI: 10.1080/0966369X.2015.1013439 (Citation as instructed)
- Kapferer, J. and Bastien, V. (2012), *The Luxury Strategy: break the rules of marketing to build luxury brands*, Kogan Page Limited, Great Britain and the United States.
- Kapferer, K. and Laurent, G. (2014), "Where do consumers think luxury begins? A study of perceived minimum price for 21 luxury goods on 7 countries", 2014-61-02, INSEEC Business School, France, May 2014.
- Keller, K. (1993), "Conceptualizing, measuring, and managing customer-based brand equity", *Journal of Marketing*, Vol. 57 No.1, pp. 1-22.
- Kim, A. and Ko, E. (2012), "Do social media marketing activities enhance customer equity? An empirical study of luxury fashion brand", *Journal of Business Research*, Vol. 65 No.10, pp. 1480-1486.
- Kim, J. and Lee, H. (2015), "Impacts of U.S. affluent consumers' luxury goods consumption beliefs on repeat purchases of luxury goods: Generational and gender comparison analyses", *Journal of Global Fashion Marketing*, Vol. 6 No. 3, pp. 207- 221.
- Kim, S., et al., Customer emotions and their triggers in luxury retail: Understanding the effects of customer emotions before and after entering a luxury shop, *Journal of Business Research* (2016) (Citation as instructed)
- Kradisching, C. (2015) Getting Labeled: The Influence of Brand Prominence among Generation Y consumers. Master's Thesis within International Marketing. Jönköping International Business School
- Krueger, R. A. (2000), *Focus groups: a practical guide for applied research*, Sage Publications, United States of America.
- Lertwannawit, A. and Mandhachitara, R. (2012), "Interpersonal effects on fashion consciousness and status consumption moderated by materialism in metropolitan men", *Journal of Business Research*, Vol. 65 No. 10, pp. 1408-1416.
- Levy, J. and Loken, B. (2015), "Revisiting gender differences: What we know and what lies ahead?", *Journal of Consumer Psychology*, Vol. 25 No. 1, pp. 129-149.
- Lucas, S. (2014), "Beyond the existence proof: ontological conditions, epistemological implications, and in-depth interview research", *Quality and Quantity*, Vol.48 No.1, pp. 387-408.
- LuxHub (2015), "The Luxury Customer Journey: The Global Report", available at: <http://www.havasluxhub.com/the-global-luxury-customer-journey-2/> (accessed 27th August 2016)
- McDonald, C. (2016), "Luxury fashion retailer gets digital makeover", *Computerweekly*, p. 12-15.
- Mehmedovic, M. and Agic, E. (2015), "Regional approach to luxury market segmentation: the case of Western Balkans", *International Journal of Management Science and Business Administration*, Vol. 1No. 5, pp. 245-254.
- Melnyk, V. et al (2009), "Are women more loyal customers than men? Gender differences in loyalty to firms and individual service providers", *Journal of Marketing*, Vol. 73 No. 4, pp. 82-96.
- Nadeem, W. et al (2015), "Engaging consumers online through websites and social media: A gender study of Italian Generation Y clothing consumers", *Journal of Information Management*, Vol. 35 No.1, pp. 432-442.
- Okonkwo, U. (2010), *Luxury Online: Styles, Systems, Strategies*, Palgrave Macmillan, UK.
- Orrange, R. (2003), "Individualism, family values, and the professional middle class: in- depth interviews with advanced low and MBA students", *Sociological Quarterly*, Vol. 44 No. 3, pp.451-480.
- Palmer, A. and Huo, Q. (2013), "A study of trust over time within a social network mediated environment", *Journal of Marketing Management*, Vol. 29 No.15-16, pp. 1816-1833.

- Priporas, C. et al. (2015), "Counterfeit purchase typologies during an economic crisis", *European Business Reviews*, Vol. 27 No. 1, pp. 2-16.
- Radón, A. (2012), "Counterfeit luxury goods online: an investigation of consumer perceptions", *International Journal of Marketing Studies*, Vol. 4 No. 2, pp. 74-79.
- Raluca, C. et al. (2012), "How far would you go for luxury? An exploratory study among Romanian female students that consume luxury", *Economic Science Series*, Vol. 21 No. 1, pp. 1127- 1133.
- Roderick, L. (2016), "How fashion brands are taking Instagram from gimmick to strategic", available at: <https://www.marketingweek.com/2016/02/17/how-fashion-brands-are-taking-instagram-from-gimmick-to-strategic/> (accessed 20th February 2017)
- Roux, E. et al (2017), "Values associated with luxury brand and the role of gender", *Journal of Business Research*, Vol. 71, pp. 102-113.
- Thakur, A. and Kaur, R. (2016), "An Empirical Examination of the Relationship between Emotional Attachment and Attitudinal Brand Loyalty Towards Luxury Fashion Brands", *Business and Economics Review*, Vol. 16 No. 1, pp. 70-80.
- Truong, Y. (2010), "Personal aspirations and the consumption of luxury goods", *International Journal of Market Research*, Vol. 52 No. 5, pp. 653-671.
- Sarah Giovannini Yingjiao Xu Jane Thomas, (2015)," Luxury fashion consumption and Generation Y Consumers Self, brand consciousness, and consumption motivations ", *Journal of Fashion Marketing and Management*, Vol. 19 Iss 1 pp. 22 - 40 (Citation as instructed)
- Seringhaus, F. (2002), "Cross-cultural exploration of Global Brands and the Internet", in *Proceedings of the 2002 18th Annual IMP Conference*, Groupe ESC Dijon Bourgogne Dijon. France, pp. 2-29.
- Shabat, H. (2015), "The New Luxury Consumer? Think: Multiple Consumers", available at: <http://www.therobinreport.com/the-new-luxury-consumer-think-multiple-consumers/> (accessed 20th February 2017)
- Shea, E. (2013), "Entry-level products can attract future high-end luxury consumers", available at: <https://www.luxurydaily.com/entry-level-products-can-attract-future-high-end-luxury-consumers/> (accessed 18th February 2017)
- Shukla, P. et al (2016), "Customer commitment to luxury brands: Antecedents and consequences", *Journal of Business Research*, Vol. 69 No. 1, pp.323-331.
- Statista (2017), "Leading luxury brands ranked by number of Instagram followers of February 2017 (in millions)", available at: <https://www.statista.com/statistics/483753/leading-luxury-brands-instagram-followers/> (accessed 15th February 2017)
- Strauss, A. and Corbin, J. (1990), *Basics of Qualitative Research: Grounded Theory Procedures and Techniques*, Sage Publications, London.
- Sung, Y. et al (2015), "Dimensions of luxury brand personality: scale development and validation", *Psychology & Marketing*, Vol 32 No. 1, pp. 121-132.
- Walz, A. et al (2012), "I will have no other" – the role of communication and trust in driving exclusive behaviour", *Journal of Consumer Satisfaction, Dissatisfaction & Complaining Behavior*, Vol. 25, pp 80-95.
- Wang, Y. and Griskevicius, V. (2013), "Conspicuous consumption, relationships, and rivals: women's luxury products as signals to other women", *Journal of Consumer Research*, Vol. 40 No. 5, pp. 834-854.
- Wells, C. (2017), "Luxury Fashion Designers Struggle to Adapt to Digital Era", available at: <https://www.wsj.com/articles/luxury-fashion-designers-struggle-to-adapt-to-digital-era-1484535842> (accessed 3rd March 2017)
- Yeoman, I. and Beattie, U. (2006), "Luxury markets and premium pricing", *Journal of Revenue and Pricing Management*, Vol. 4 No. 4, pp. 319-328.
- Zaharia, R. and Zaharia, R. (2015), "Psychology of Luxury Goods Consumer", *International Conference on Marketing and Business Development Journal*, Vol. 1 No. 1, pp. 200-208.

## **EVOLUTION OF FUNDING AND FINANCING IN PUBLIC HIGHER EDUCATION: CHALLENGES FOR PORTUGAL AND OTHER EUROPEAN COUNTRIES**

**Guedes, Rui<sup>1</sup>; Marta-Costa, Ana<sup>2</sup>; Ribeiro, Humberto<sup>3</sup>; Alves, Sandra<sup>4</sup>; Veloso, Cláudia<sup>5</sup>**

<sup>1</sup>ESPROSER – Professional School, Sernancelhe, Portugal

<sup>2</sup>DESG, CETRAD, University of Trás-os-Montes e Alto Douro, Vila Real, Portugal

<sup>3</sup>GOVCOPP, Águeda School of Technology and Management, University of Aveiro, Aveiro, Portugal

<sup>4</sup>High School of Technology and Management, Polytechnic Institute of Leiria, Leiria, Portugal

<sup>5</sup>Águeda School of Technology and Management, University of Aveiro, Aveiro, Portugal

### **ABSTRACT**

Considering the expected increase in the participation in higher education costs by students and their families, this research aims to examine this phenomenon, taking into account the counterparts provided through governmental social aid, given to the neediest students, enabling universality of the access to higher education to the population (Trow, 1973, 2005).

Johnstone (2004) provides a meaningful contribution for the discussion on new forms of financing the Public Higher Education (PHE). He argues the need for fundraising, which should involve the patronage-philanthropy, the investigation and research at the request of the companies, and other solutions as well, such as the sale of products from higher education organizations sources and also the rental of spaces.

The main objective of this paper is to critically discuss the evolution of the financing of Portuguese higher education in public institutions (funding), within the European Union higher education framework, focusing on the most recent trends. More specific objectives include identifying existing sources of funding, together with the analysis of national and international trends in terms of cost sharing in higher education, through the distribution of impacts among different types of direct and indirect players of the higher education sector: government, taxpayers, students and families.

This paper resumes a set of issues that not only are being inadequately tackled, but, worst, are becoming a chronic going on concern, jeopardizing the future and potential of the PHE organizations and periling the accessibility of the population to higher education, therefore curtailing a very significant universal right that modern society considered to be safely granted.



*Keywords: Public higher education, higher education costs, funding, financing models, tuition fees, cost sharing.*

## INTRODUCTION

The choice of the research topic of this paper, related to the funding and financing of Portuguese higher education organizations, within the scope of the European Union framework, comes from the fact that the authors have been professionally connected to the field of education for over 10 years, and up to two decades even. One of the authors, being acting in the financial area of a professional high school, has never agreed to the financing model applied to the sector, favoring the function of mere budget payer to the detriment of rational management. In fact, the main objective of public management is 100% budgetary implementation, thus avoiding future budgetary reductions. Together with the remaining authors, active professors performing in both the university and in the polytechnic systems, not only at the public sector, but also, at times, in the private sector, the blend of expertise was made, allowing a comprehensive examination about the sector.

Another relevant point that justifies this paper is the gap that exists in literature, which is particularly blatant to Portugal and other European countries, as noted by several authors (e.g. Cerdeira, 2008; Cabrito, 2002), therefore adding attractiveness to deepen the discussion on the funding and financing of higher education organizations.

The current trend, since the introduction of tuition fees, has been cost-sharing among all actors involved in higher education financing (Cerdeira, 2008). A new trend in the diversification of higher education funding concerns new alternatives to funding (budget or funding), which will increase the role of academic research and research project, increasing competition among organizations for available funds, and therefore reducing dependence on public budgetary funding.

This is the main reason for the emergence of the Universities-Foundation phenomenon, as pointed out by Moreira (2011). This paradigm, well-known in several Anglo-Saxon countries, such as the United Kingdom with its charities, allows the higher education institutions to grow faster and in a more balanced manner, broadening its funding base, while introducing a new organizational model in the universities universe.

Concurrently, considering the expected increase in the participation in higher education costs by students and their families, this research aims to examine such costs, taking into account the counterparts provided through governmental social aid, given to the most needy students, enabling universality of the access to higher education to the population that really wants to benefit from it (Trow, 1973, 2005). In the paradigmatic case of Portugal, despite the frequency of higher education

remains below the European Union (EU) average, and even below the Organization for Economic Cooperation and Development (OECD) average, Cerdeira (2008), found it has gone from a mere rate of 6% in 1985/86, to a significant rate of 27.3% in 2003/2004. According to Trow's (1973, 2005) classification, the elite higher education frequency stage, with only less than 15%, was more recently overcome by the mass higher education stage, with 15% to 50% frequency. Nevertheless, Trow (1973, 2005) stresses that these levels are still far behind from the aimed universal access, which considers frequency levels over 50%, and are still to be met by most developed countries. One of the issues, referred by authors such as Cerdeira (2008), is that the main difficulty in increasing the participation rate in higher education is due to the high abandonment rate up to upper secondary level, which naturally prevents the progression of higher education.

The main objective of this paper is to critically discuss the evolution of the financing of Portuguese higher education in public institutions (funding), within the European Union higher education framework, focusing on the most recent trends. More specific objectives include to identify existing sources of funding, together with the analysis of national and international trends in terms of cost sharing in higher education, through the distribution of impacts among four different types of direct and indirect players of the higher education sector: government, taxpayers, students and families.

## **HIGHER EDUCATION: MASSIFICATION AND FINANCIAL ISSUES**

The pertinence of the issues related to the financing of the higher education system comes from the combination of several key national and international factors, such as:

- The significant increase in the frequency of higher education in recent decades;
- Significant increase in public funding to the Public Higher Education (PHE) as a result of the sharp increase in demand;
- Financial budgetary issues, such as the case of Portuguese State budget crisis and consequent IMF interventions in Portugal (1977, 1983 and 2011);
- Introduction of quotas, 'numerus clausus', on accessing the higher education in order to slow down the abrupt growth of candidates;
- Limitation of hiring of teaching and non-teaching personnel in the through plafonds and ceilings;
- Adoption of the cost-sharing model in the financing of higher education. In the Portuguese case, introduction of tuition fees in 1992, forcing the students and mostly often their families to participate in the financial sharing of their own academic education (cost sharing);
- Introduction of the Bologna Process (1999) across European Union countries. In the Portuguese case its implementation started in 2006. In addition to the objectives set out in the official implementation

document, such as the harmonization of academic degrees, or the creation of a system of credits (ECTS), it is also aimed to foster cooperation between institutions and researchers. Last but not least, a new division of the higher education model is casted, combined into two distinct phases: the first of the degree (typically 3 years) and a second degree of post-graduation (2nd and 3rd cycle);

- Diffusion of the UK model of enhancing private financing of the public higher education sector (Charities). In the Portuguese case, the main landmark was the creation of the Foundation Status for Portuguese Universities (2007), with the subsequent conversion of 3 institutions to the foundation status, the ISCTE (Institute of Labor and Enterprise Sciences), University of Porto and University of Aveiro. Other institutions would later follow, such as University of Minho.

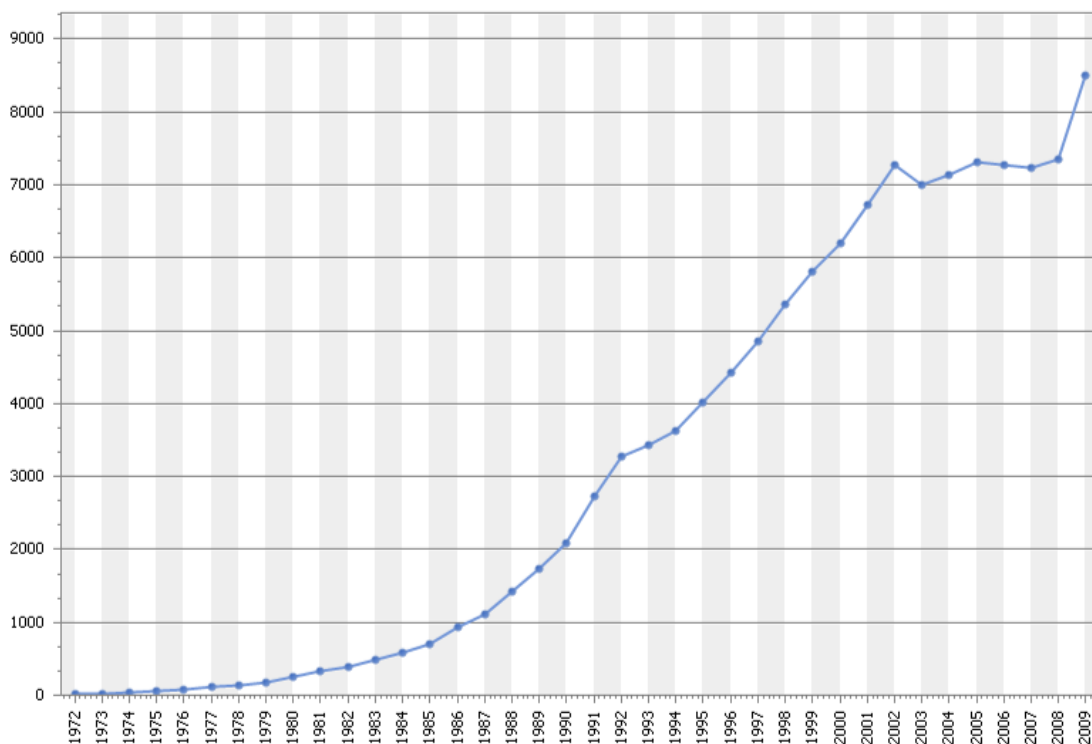

Figure 1. State expenditure on education in Portugal: budget implementation in million euros (DGO/MFAP, Pordata, 2011)

As shown in Figure 1, costs with education in Portugal became significantly higher since democracy was a reality with the III Republic. The entrance in the EU also certainly helped to increase this expenditure figures.

In Figure 2 below, one can observe the results of the massification of higher education frequency in Portugal, especially in the last 30 years (Alves et al., 2010). Coupled with the reduction in public participation, it has originated a greater requirement of financial management of both University and Polytechnic Institutions (Cerqueira, 2008). This situation is somehow magnified by imposing a vague

policy on access to the PHE as Figure 2 shows, consequence of the emergence and consolidation of Private Higher Education.

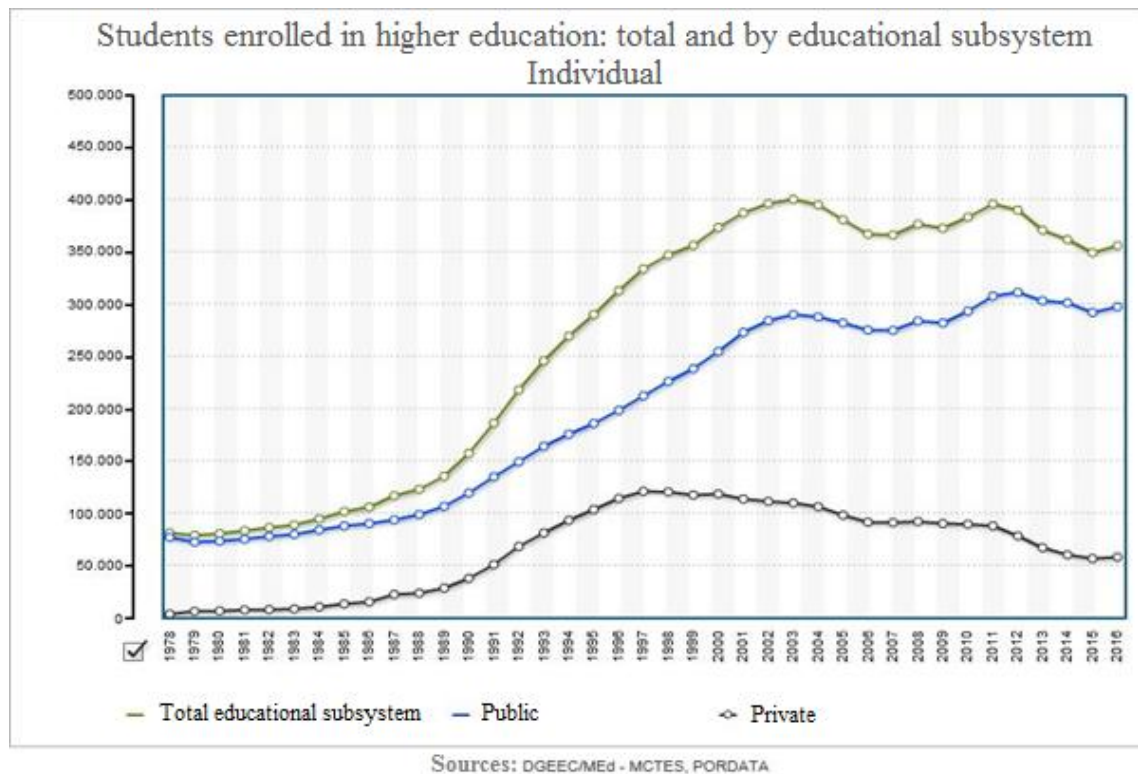

Figure 2. Students enrolled in higher education: total and by educational subsystem (DGEEC/MEC – DIMAS/RIDES, Pordata, 2017)

The growing demand of PHE, prompted the introduction by the Government, of new models of financing, more restrictive, to prevent, in some ways, the abrupt growth of signings of teaching and non-teaching staff. In 1992, were returned to the tuition fees, existing in a way since 1941 (Figure 3), but without updating, through which students and their families support a part of the costs of universities. With the reintroduction of tuition fees in Portugal, public institutions, home to what Johnstone (1986) means of cost sharing (cost-sharing) between the State, taxpayers, students and their families.

In 1993, arose a new funding formula, checking-in the year of 1996 a brief interruption of tuition fees (Cerdeira, 2008).

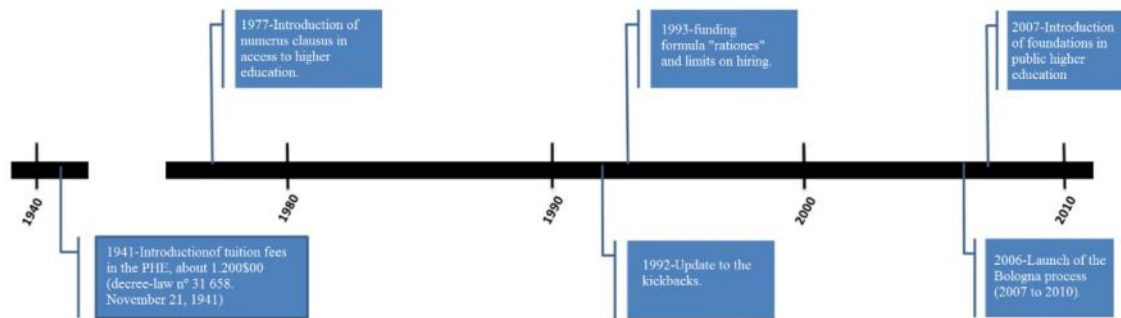

Figure 3. Milestones in PHE (Authors' compilation)

Recently, with the adoption of the Bologna process for Universities and National Institutes there has been a reduction of the financing, by the time reduction of the courses. Some authors consider an overlap of interests of Economy on education (Amaral et al., 2004). The first Cycles are shortened to 3 years allow the State to reduce public funding of PHE, while transferring a greater financial responsibility to students and families to the frequency of the second and third cycles.

The current trend of cost sharing (cost-sharing) originated from the need to diversify the financing of PHE, which allows to maintain or increase their activities, reducing the dependence on the State. This is the main reason, pointed by Moreira (2011), to the rise of the universities-Foundation, which allows the institution to grow, your amplification-based funding, while at the same time introduces a new Organizational Model in Universities.

In this work it is a critical analysis of international studies available on the subject, based on the documents of Johnstone (1986). Afterwards, will be analysed the supply of bills of PHE, followed by your comparison with existing State budgets for the periods under review.

## EVOLUTION OF THE FUNDING OF HIGHER EDUCATION IN PORTUGAL

In recent years there has been a decrease of public participation in the institutions of Public PHE (table 1), even when there is a slight increase in your frequency (Figure 2).

Table 1. Evolution of the expenditure effected in the operating budget – the State budget by type of institution between 2000 to 2012 (current prices and constant prices, base 2012) unit: Euro

	Current Prices				Converter constant prices 2012 (INE)	Constant prices (Base 2012)			
	State budget					State budget			
	Universities	Polytechnic Institutes	Other Establishmen ts /Student	Total		Universities	Polytechnic Institutes	Other Establishmen ts /Student	Total
2000	622.018.595	235.468.561	0	857.487.156	1,3517	840.782.535	318.282.854	0	1.159.065.389
2001	686.030.623	274.947.829	37.330.472	998.308.924	1,2946	888.135.245	355.947.459	48.328.029	1.292.410.733
2002	734.109.267	273.517.369	41.038.029	1.048.664.665	1,2503	917.856.817	341.978.766	51.309.848	1.311.145.431
2003	728.326.082	284.923.045	42.979.916	1.056.229.043	1,2117	882.512.714	345.241.254	52.078.764	1.279.832.731
2004	715.911.283	271.725.683	41.738.987	1.029.375.953	1,1842	847.782.141	321.777.554	49.427.308	1.218.987.004
2005	734.620.596	292.362.842	26.021.443	1.053.004.881	1,1584	850.984.498	338.673.116	30.143.240	1.219.800.854
2006	777.622.496	295.103.501	29.525.138	1.102.251.135	1,1235	873.658.874	331.548.783	33.171.493	1.238.379.150
2007	709.928.748	296.000.000	0	1.005.928.748	1,0969	778.720.844	324.682.400	0	1.103.403.244
2008	716.762.216	306.000.000	0	1.022.762.216	1,0696	766.648.866	327.297.600	0	1.093.946.466
2009	748.649.056	321.500.000	0	1.070.149.056	1,0805	808.915.305	347.380.750	0	1.156.296.055
2010	844.004.822	380.700.000	0	1.224.704.822	1,0659	899.624.740	405.788.130	0	1.305.412.870
2011	737.512.729	325.500.000	0	1.063.012.729	1,0275	757.794.329	334.451.250	0	1.092.245.579
2012	581.360.345	261.023.173	0	842.383.518	1,0000	581.360.345	261.023.173	0	842.383.518

Source: 2000 to 2006 – Cerdeira (2008). 2007 to 2012 – DGEEC-MEC; DPGPF-MEC; DGO (State budgets reports); CRUP (2013)

Analysing in detail the Table 1, a stagnation of funding of PHE in Portugal can be observed. Effectively we found that including the total value of the funding in 2012 is, at current prices, less than the amount transferred to the institutions in 2000.

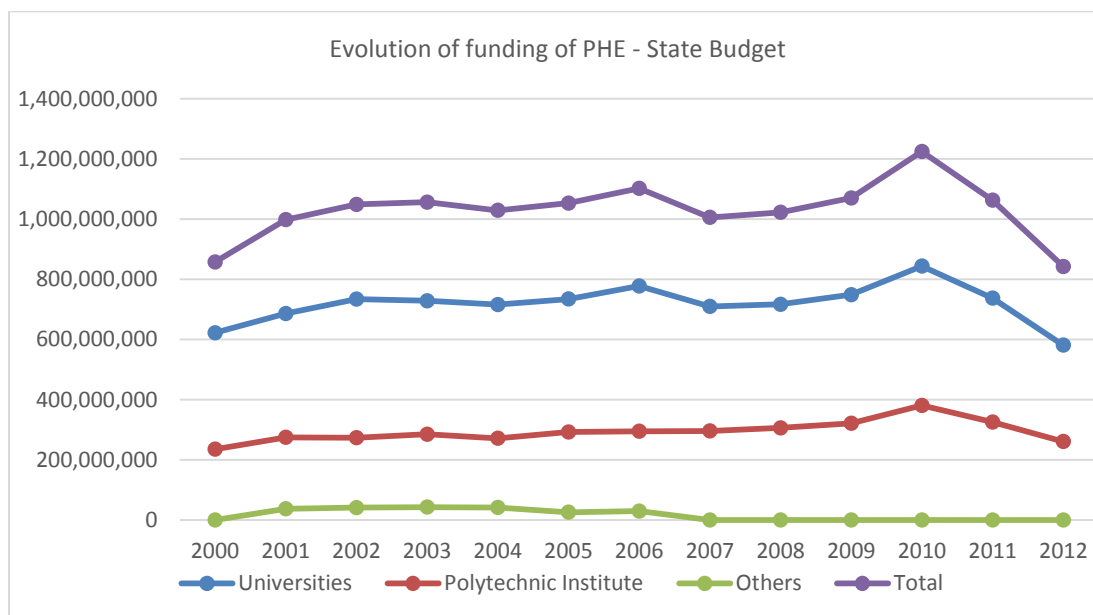

Figure 4. Evolution of higher education Funding, through the State budget (current prices). (Authors' compilation). Unit: Euros

This evolution can be seen in the figure 4, allowing us to assess development similar to the funding level, both with regard to what is available to universities, whether the one that is provided to Colleges and other institutions of PHE.

If we add to this analysis an index to correct the effect of inflation (table 1), we see a sharp decline in public funding of PHE in 2012 in comparison for 2000 by more than 27%.

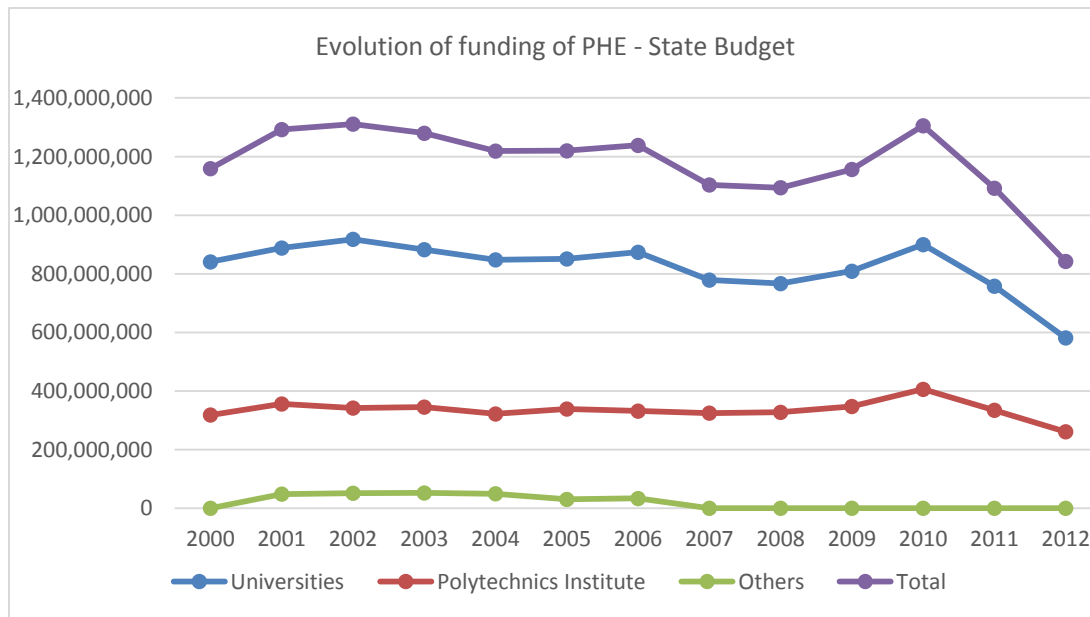

Figure 5. Evolution of higher education Funding, through the State budget (constant prices-2012 Base). (Authors' compilation). Unit: Euros

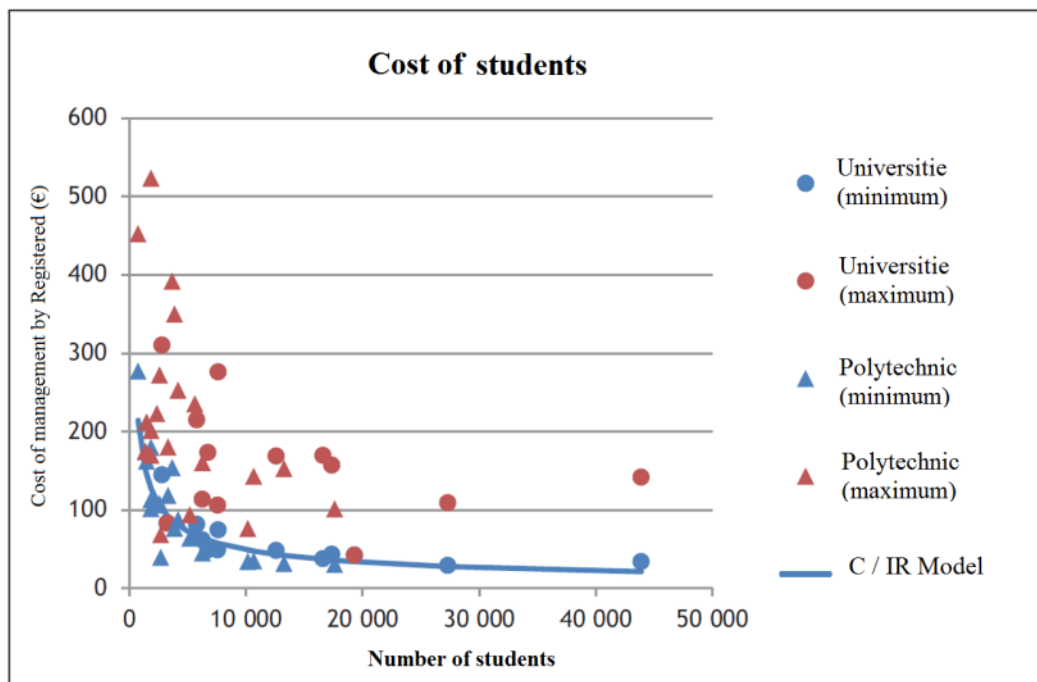

Figure 6. Management costs for registered maximum and minimum on the basis of the number of students enrolled (Ministry of education and science, 2015)

Regarding the figure 5, it is clear the significant reduction of the funding institutions. This led institutions to carry out expenditure higher than the initial budget (Cerqueira, 2008), in the years 1999, 2001, 2002, 2006 and 2007.

Figure 6, however, allows us to observe the management costs per student, depending on the number of students enrolled (MEC, 2015). The study was presented at the request of the Portuguese Ministry

of Education, in order to develop a new funding model of the PHE and introduces the public cost in terms of the average number of students enrolled. We stress the clear economies of scale of larger institutions, with more than 5,000 students and also the blue line that allows us to show the average cost that will serve as a basis for the new funding model of the PHE in Portugal.

## ACCESSIBILITY TO HIGHER EDUCATION

With the update of the value of the tuition fees in 1992 (Figure 2), a value that remained unchanged since 1941 (1,200 \$00), Cabrito (2002) and Cerdeira (2008) warn of the problem of accessibility and equity of students in PHE. Equity in access to higher education intends to put all students wishing to attend the same level regardless of financial standing of their own or their families (Cerdeira, 2012). As regards the accessibility to the PHE, we can consider two aspects, the generic capacity to attend the PHE and the financial capacity to pay the costs of your frequency (Cerdeira, 2012), by students.

Table 2. Comparison of total costs of students in higher education and median income – US Dollar PPS (\*)

	<b>Total Costs</b>	<b>Average Income</b>	<b>%</b>	<b>Ranking</b>
Germany	6.250	22.020	28,4%	1°
Norway	8.096	26.623	30,4%	2°
Netherlands	10.348	28.032	36,9%	3°
Finland	7.977	21.010	38,0%	4°
France	8.047	20.650	39,0%	5°
Denmark	9.443	22.929	41,2%	6°
Sweden	9.265	20.716	44,7%	7°
Latvia	6.223	13.646	45,6%	8°
Canada	13.007	26.623	48,9%	9°
New Zealand	10.670	19.265	55,4%	10°
England and Wales	14.844	24.652	60,2%	11°
<b>Portugal</b>	<b>8.778</b>	<b>11.145</b>	<b>78,8%</b>	<b>12°</b>
Australia	19.352	23.017	84,1%	13°
USA	23.615	26.990	87,5%	14°
Japan	24.802	22.790	108,8%	15°
Mexico	8.108	4.615	175,7%	16°

Source: Cerdeira (2012)

\* 1 € = 1,32515 dollar, according to OANDA Conversor, 31/12/2010

The notion of accessibility to the PHE can be complemented by the careful examination of table 2, where we note that Portugal offers a cost per student very high. But if we compare this cost with the median income Portuguese in 2010, we see a very big effort for students can study in these institutions, having only to Australia, USA, Japan and Mexico a higher relative weight. When we see that in 2010, a student who study in PHE supports costs represent nearly 80% of the median income in the country at the same time, we realize that access to accessibility can be concerned.



Table 3: Annual expenditure per student by purchasing power parity (PPS), in primary education (ISCED 1), 2nd and 3rd cycles and Secondary Education (ISCED 2-4), and higher education (ISCED 5-6), based on constant prices, for years 2000, 2007, 2008 e 2009.

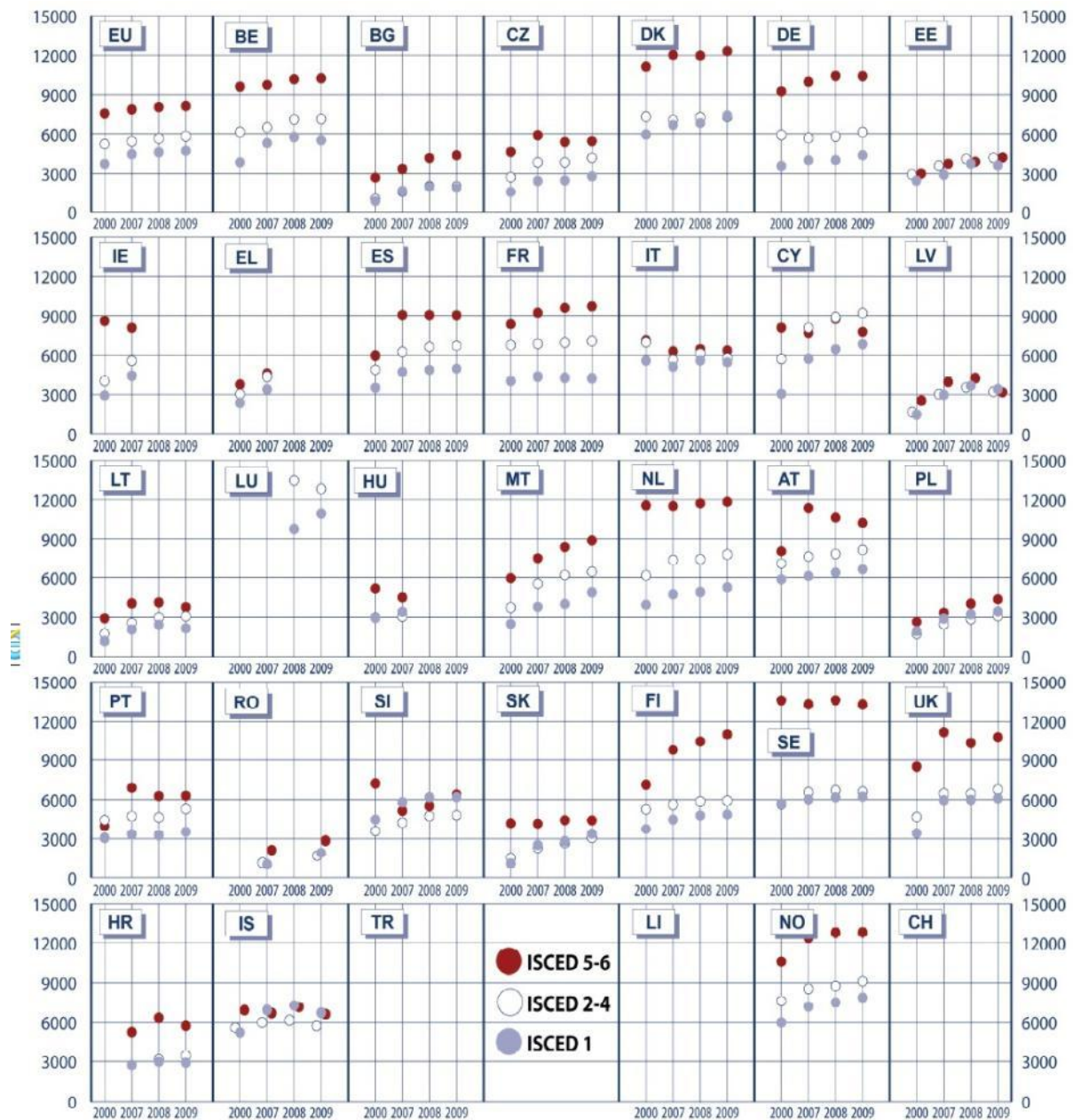

Source: European Commission (2013)

The table 3 presents the annual expenditure per pupil in public and private education institutions on measures as the central, regional and local Authorities, families and other private bodies (non-profit organizations and companies) spent per pupil/student. Annual expenses include personnel costs, current expenditure and capital expenditure. The indicator was calculated by dividing the total

amount of the annual budget by the number of full-time equivalent students at the level of education concerned.

The annual expenditure numbers were converted into purchasing power standard (PPS) to eliminate the differences in price between countries and deflated by GDP price index (base year 2000). The PPS is expressed in Euros. The GDP price index for main components, was used to calculate the expenditure at constant prices.

When we see that in 2010, a student who study in PHE supports costs represent nearly 80% of the median income in the country at the same time, we realize that access to accessibility can be concerned by the difficulties that this same student can feel, even with the support of the family, to bear the financial burden of is education.

## SOURCES OF FINANCING PUBLIC HIGHER EDUCATION

The funding of PHE in Portugal presents many challenges, some of them already explained, such as the decrease in public funding of public institutions, the problem of accessibility to the PHE for financial reasons, the slowdown in the number of students who access the PHE, and let's see now another problem which relates to the current financial crisis across Europe and with higher incidence in Portugal.

Analysing the report drawn up by the European Commission (2013), it is possible to check and compare the evolution of spending on education in the European Union. We can see a parallel between the countries most affected by the crisis (southern Europe), noting a reduction of investment in PHE, generally speaking.

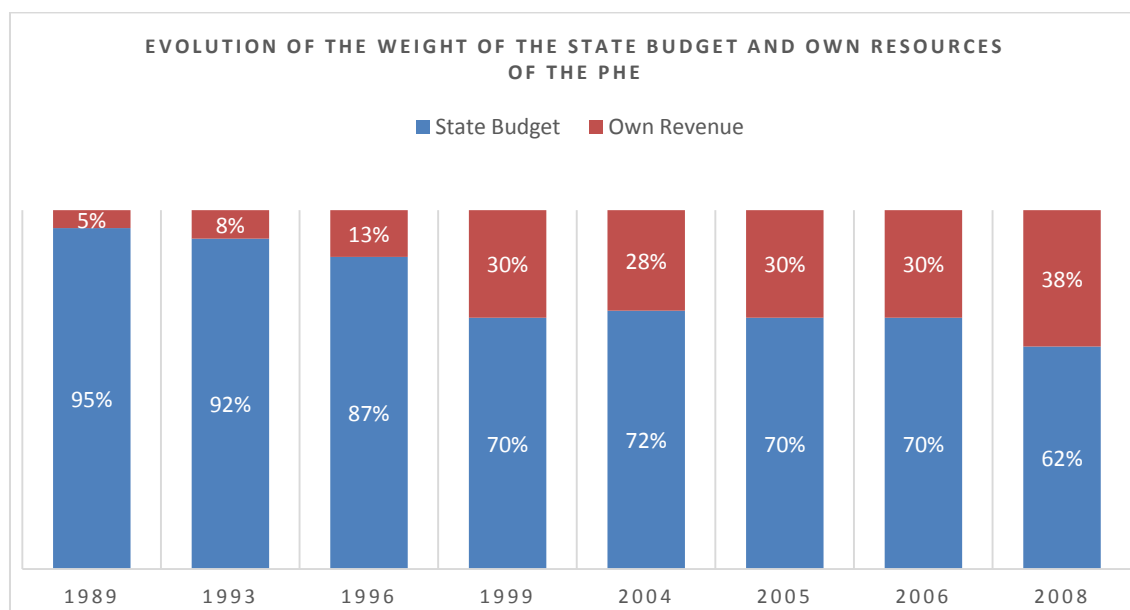

Figure 7. Evolution of the weight of the State budget and from own resources in public higher education institutions.

Source: Cerdeira (2008, 2012)

The reduction of public funding will not be unrelated to the current crisis in our country, but also the ideological liberal nature option, how would you rate Cerdeira (2012). Naturally this funding reduction, that from 2005 to 2012 reached 20.5%, forces universities to look for other sources of funding to allow bridging the public disinvestment. How can we check for Figure 7, the weight of the State budget revenues of public state, has declined a lot, going from 95% in 1989 to 62% in 2008.

Against this background, the ways of financing the organizations had to be rethought in a very short space of time, therefore encouraging, or forcing, the institutions to strengthen their own revenues with new forms of financing, often requiring creativity in doing so. In relation to tuition fees, the institutions have a legal limit of your maximum value (the maximum value for the 1st cycle is currently € 1,065.72) and have yet to meet the accessibility referred to previously, you can define the number of students who access the PHE.

## CONCLUSIONS

This paper discussed the evolution of public funding allocated to Universities and Polytechnics, as well as the challenges to bridge the necessary reduction of PHE from governmental financial support, which is critical for the survival and maintenance of PHE within reach of the whole population, ensuring the desirable accessibility. The study presented here is part of a broader study, an ongoing work, which aims to perform an in depth analysis, in addition to the situation depicted in this paper, of the costs incurred by students of this level of education and compare them with the situations in other countries.

With the research made, we could corroborate the need for identifying new ways of financing the PHE in the scope of the reduction of public participation in the financing of the institutions, by the means of patronage-philanthropy, investigation at the request of companies, or the sale of products and the rental of spaces (Johnstone, 2004).

This paper also corroborated the trends identifies by Trow (1973, 2007), namely in what is concerned with the universal higher education and subsequent massification tendency. The massification of higher education frequency in Portugal, especially in the last 30 years (Alves et al., 2010), and in particular the institutions of Public Higher Education, led to a greater financial need for the government to finance many more students. This financial pressure has been reduced with the

introduction of various measures that Johnstone (1986) baptized of cost-sharing or by calling students and families to increasingly share the financial burden, by helping to fund institutions, with measures such as the increase of tuition fees, or through the introduction of limits on the recruitment of human resources in the institutions of (PHE), or with the introduction of the Bologna process in 2006, which reduced the time students would take to obtain their degrees, by reducing the degrees curricula, and therefore reducing the resources needed. This significant decrease of public funding of public institutions forced (PHE) to seek other forms of financing and funding. If financing by the Portuguese State budget in 1989 had a coverage of 95% of PHE budgetary needs, such ratio would be significantly reduced to only 62% in 2008 (Cerdeira 2008, 2012). Furthermore, more recently, analysing the evolution of funding from 2000 to 2012, a reduction of public funding by more than 27% is observed (constant prices, 2012 base).

In relation to the financing available to PHE, the tuition fees continue to contribute importantly. Nevertheless its value remains conditional upon the political-governmental rule, which determines its maximum value, as it bears in mind the principle of accessibility. If accessibility is not ensured, that means a setback, going back to a public elite PHE status, which, on the other hand can generate a further reduction of tuition revenue, by the resulting lower number of students attending the higher education, and by an increase of students' abandonment due to financial reasons (Cerdeira, 2008).

We have identified also a unmovable growing concern with the implications of the strong reduction in the number of students, as well as increasing levels of abandonment, with consequent losses for the ability to collect due payments (MEC, 2015), which subsequently causes a significant reduction in revenue from tuition and other fees, which leads to a rise of underutilisation of resources and underutilization of material resources (sub-capacity of rooms and equipment).

In resume, the issues referred throughout in this paper are not only being inadequately tackled, but, worst, are becoming a chronic going on concern, jeopardizing the future and potential of the PHE organizations and periling the accessibility of the population to higher education, therefore curtailing a very significant universal right that modern society considered to be safely granted.

## **ACKNOWLEDGEMENTS**

*This work was financially supported by the research unit on Governance, Competitiveness and Public Policy (project POCI-01-0145-FEDER-006939), funded by FEDER funds through COMPETE2020 - Programa Operacional Competitividade e Internacionalização (POCI) – and by national funds through FCT - Fundação para a Ciência e a Tecnologia.*



## REFERENCES

- Alves, N., Centeno, M., & Novo, A. (2010). O Investimento em Educação em Portugal: Retornos e Heterogeneidade, *Boletim de Primavera do Banco de Portugal*. Retrieved from the internet in February 2016, available at [www.bportugal.pt/pt-PT/EstudosEconomicos/Publicacoes/Paginas/BdPPublicationsResearchDetail.aspx?PublicationId=435](http://www.bportugal.pt/pt-PT/EstudosEconomicos/Publicacoes/Paginas/BdPPublicationsResearchDetail.aspx?PublicationId=435).
- Amaral, A. e Magalhães, A. (2004). "Epidemiology and the Bologna Saga", *Higher Education*, 48, 79-100.
- Cabrito, B. (2002). *Financiamento do Ensino Superior: Condição Social e Despesas de Educação dos Estudantes Universitários em Portugal*, Lisboa: Faculdade de Psicologia e Ciências da Educação, Educa, 7 de Abril.
- Cerdeira, L. (2012). *Os Desafios da Acessibilidade no Ensino Superior: O Caso dos Estudantes Portugueses no Contexto Internacional*. 2ª Conferência: "Por um Ensino Superior de Qualidade nos países e regiões de língua portuguesa, 6, 7 e 8 de Novembro de 2012 – Instituto Politécnico de Macau.
- Cerdeira, L. (2008). "O Financiamento do Ensino Superior Português – A partilha de custos", (Tese de Doutoramento, Universidade de Lisboa, 2008). Retrieved from the internet in November 2015, available at [www.opest.ul.pt/pdf/TeseLuisaCerdeira2Abril2009.pdf](http://www.opest.ul.pt/pdf/TeseLuisaCerdeira2Abril2009.pdf)
- CRUP (2013). *Conselho de Reitores das Universidades Portuguesas. Fornecimento de dados financeiros relacionados com as Instituições de ES público, em Setembro de 2013*. Retrieved from the internet in September 2013, available at [www.crup.pt](http://www.crup.pt)
- European Comission (2013). *Funding of Education in Europe 2000-2012 – The Impact of the Economic Crisis*. Education, Audiovisual and Cultural Executive Agency – Eurydice and Policy Support, February 2013. Retrieved from the internet in September 2013, available at <http://eacea.ec.europa.eu/education/eurydice>
- Guedes, Rui; Costa, Ana; Ribeiro, Humberto (2013). "Financiamento do Ensino Superior Público: Dificuldades e Soluções", Trabalho apresentado em XV Seminário Luso-Espanhol de Economia Empresarial, In *O Papel das Organizações na Sustentabilidade das Economias em Crise*, Vila Real.
- Johnstone, B. (2004). *A political culture of giving and the philanthropic support of public higher education in international perspective*. In *Conference on Higher Education (ICHE) in Luxembourg*.
- Johnstone, D. B. (1986). *Sharing the Costs of Higher Education. Student Financial Assistance in the United Kingdom, The Federal Republic of Germany, France, Sweden and the United State*. New York: College Board Publications.
- Ministério da Educação e Ciência (2015). *Modelo de Financiamento do Ensino Superior: Fórmulas e Procedimentos*. Lisboa: MEC-SEES.
- Moreira, V. (2011). *Universidades-Fundação: natureza e regime jurídico*. Palestra organizada pela Universidade do Minho "Passagem da Universidade a Fundação", 21 de Janeiro de 2011.
- Pordata (2017). *Several surveys on website related to the evolution of the number of students enrolled in public and private higher education*. Retrieved from the internet in March 2017, available at [www.pordata.pt](http://www.pordata.pt)
- Trow, M. (1973). "Problems in the transition from elite to mass higher education", in *OECD, Policies for Higher Education: General Report on the Conference on Future Structures of Post-secondary Education*. Paris: OECD.
- Trow, M. (2007). "Reflections on the Transition from Elite to Mass to Universal Access: Forms and Phases of Higher Education in Modern Societies since WWII.", in *International Handbook of Higher Education*, James Forest and Philip Altbach ed., Vol. 18, Springer. 243-280.

# VALUATING RENEWABLE ENERGY INVESTMENTS WITHIN TRANSACTIONS: A COMPARATIVE REVIEW AMONG PRACTITIONERS

Hürlimann, Christian<sup>1</sup>; Bengoa, Dolores S.<sup>2</sup>

<sup>1</sup>The Business School, University of Gloucestershire, Cheltenham, UK

<sup>2</sup>University of Applied Management Studies, Mannheim, Germany

## ABSTRACT

The purpose of this mixed methods sequential explanatory study is to learn about the applied valuation processes for RE investments in context of transactions and its dynamics and to identify specific influencing factors and explore corresponding good and best practice approaches and/or improvements among investment professionals in Switzerland and Germany by obtaining quantitative results from a survey of 111 practitioners and then following up with 12 purposefully selected individuals to explore those results in more detail with qualitative data through in-depth interviews. The first quantitative phase identified the classic discount cash flow (DCF) methods, based on the flow to equity (FTE) approach with technology and country specific discount rates based on the WACC approaches and formal risk analysis, but less frequently on Capital Asset Pricing Model (CAPM), as preferred approaches. In the second phase, additional internal, firm specific themes, such as judgemental assessments, grade of comprehensibility and complexity of applied methods, and strategic considerations, as well as external themes, such transaction dynamics and market forces, are introduced to explain the quantitative results. The final discussion of both phases helps increase the understanding of this complex topic and provides valuable insights in this usually hidden procedures. Furthermore, the applied mixed method approach lets explore issues and possible improvements in valuation which would not be possible with a classic quantitative study. Implications and recommendation for further research and practitioners are provided.

*Keywords: capital budgeting, cost of capital, asset pricing, risk assessment, risk mitigation, none-traded assets, private equity, renewable energy, practitioners, transactions, Switzerland, Germany, exploratory sequential mixed methods approach*

## INTRODUCTION

The private equity market to which the considered renewable energy (RE) investments mainly belong is in terms of size, growth and volume of acquisitions at least as important as the public equity market (Ang and Kohers, 2001, Moskowitz and Vissing-Jørgensen, 2002, Initiative-Europe, 2005, Capron and Shen, 2007). However, information about the processes within transactions for such non-traded assets (NTA) are restricted due to confidentiality reasons and are challenging to access. For this reason, applied asset pricing techniques, valuation processes and dynamics within negotiation for NTA remain under-researched and poorly understood in contrast to the research on public traded companies (Petersen et al., 2006, Driessen et al., 2012, Ping et al., 2013). Having said that, green investments in RE production receives currently much attention by the investment community, mostly by utilities and institutional investors (Wassmann et al., 2016) due to the anticipated favourable risk-return profile (Warren, 2014) and the historically low interest rates in most developed countries which makes such investments economically more attractive (Monnin, 2015, Thakkar, 2015). Moreover, there are many investors which were forced to accept impairment losses in some of their RE investments (Shah, 2011). So the questions are “What are the optimal methodologies to come up with fair prices for seller and acquirer of RE investments?” and “What additional factors influence the valuation of RE investments?” While there are many theoretical publications about valuation (e.g. Brigham and Houston (2012) and several empirical studies about the application of methods (e.g. Graham and Harvey, 2001, Brounen et al., 2004), there is much less research about NTA compared to public traded companies (PTC) and about other mostly qualitative factors which influence valuations and transactions. Moreover, the applied valuation methodologies – developed by researching PTC (Damodaran, 2013) – do not appropriately consider all specific characteristics of NTA and RE. Other possible deficiencies include the lack of adequate input data (Petersen et al., 2006) and lack of recognition of sector specific characteristics (Brandt, 2002), unsystematic risks (Damodaran, 2012) and the correlation between project risk and within-firm and/or market risk (Ehrhardt and Brigham, 2016), and the subjectivity of many applied approaches (Cotner and Fletcher, 2000).

Knowledge and understanding of factors influencing traditional valuations and transaction dynamics and additional complementary and/or alternative valuation concepts may help investors in RE to better and more efficiently allocate their investment budgets while improving the quality of investment decisions and decreasing eventually the need to perform extraordinary depreciation of shares or assets. This article reports on the study conducted to better understand valuation process in RE investments and to suggest appropriate improvements to practitioners based on the available theoretical concepts. The purpose of this mixed methods (MM) sequential explanatory study is to learn about the applied valuation processes for RE investments in context of transaction dynamics and other influencing factors

and to identify corresponding best practice approaches and/or improvements among investment professionals in Switzerland and Germany by obtaining quantitative (QUAN) results from a survey of 111 practitioners and then following up with 12 purposefully selected individuals to explore those results in more detail with qualitative (QUAL) data through in-depth interviews to test and update the established, initial conceptual. In the first quantitative phase, survey data with an online questionnaire are collected from investment professionals in Switzerland and Germany to examine which concepts from finance theory are applied in relation to demographic data and/or other independent variables, as published in Hürlimann et al. (in press). The second qualitative phase is conducted as a follow-up to the quantitative results on a more detailed level with mainly face-to-face interviews to help explain the quantitative results and to explore issues and possible areas of improvements within valuation of RE investments on a global scale with selective German and Swiss investment professionals.

The research is expected to make a valuable contribution to the asset pricing research for NTA, specifically for RE investments. First of all, the research will demonstrate which theoretical concepts<sup>3</sup> are applied in RE investment practice in order that practitioners can learn how firms currently operate, assess risk and apply asset pricing techniques. The development of a conceptual model to estimate project specific return rates, as proposed by Finance Theory (Weston, 1973, Fuller and Kerr, 1981, Titman and Martin, 2008, Ehrhardt and Brigham, 2016) specifically for RE investments will be a second valuable contribution. It will contribute to the field of research and to managerial practice by suggesting improvements and complementary and alternative valuation methods to perform valuations in RE investments. Finally, the research will contribute to practice by offering valuable insights about the organisational and cultural differences in risk perception and risk behaviours of Swiss and German RE investors and other relevant factors influencing valuations and investment decision taking. In doing so, the research is able to delve even deeper into the subject, for example to evaluate how risk mitigation measures and “qualitative and strategic considerations” (Bierman, 1993:24), including the perspectives from the firm’s and investor’s level (Ehrhardt and Brigham, 2016), are taken into account in valuation.

*Having said that, the following research questions (RQ) are addresses:*

RQ: What methods and approaches are applied in valuation of RE investments, and what factors influence valuation and transaction processes? [QUAN]

RQ: Why are certain methods applied in practice, and why are certain methods proposed in financial theory not applied in RE valuation process and within transactions? [QUAL]

RQ: What deficiencies are encountered in valuation processes in practice? [QUAL]

---

<sup>3</sup> A detailed literature review is reported elsewhere (Hürlimann and Bengoa, in press).



RQ: What improvements in valuation can be introduced in practice in order to receive more adequate valuation results for RE transaction purposes? [MM]

### *Theoretical perspective*

Extensive literature review<sup>1</sup> reveals that the majority of the public theoretical approaches and empirical studies about valuation focuses mainly on quantitative methods and less on qualitative approaches, although the latter is at least as essential in valuation processes (Damodaran, 2012). An integrated framework combining quantitative and qualitative aspects of risk assessment in valuation is proposed by Ehrhardt and Brigham (2016). Focusing solely on quantitative approaches, the literature suggests the usage of projection of future cash flows for investment projects while discussing different forms of discounted cash flow (DCF) based methods and the definition of appropriate discount rates to appropriately consider the time value of money and the involved risk which is mostly derived from the still widely applied capital asset pricing method (CAPM).

**Figure 2: Conceptual framework about valuation and its possible influence factors (own illustration), based on literature review in Hürlimann and Bengoa (in press).**

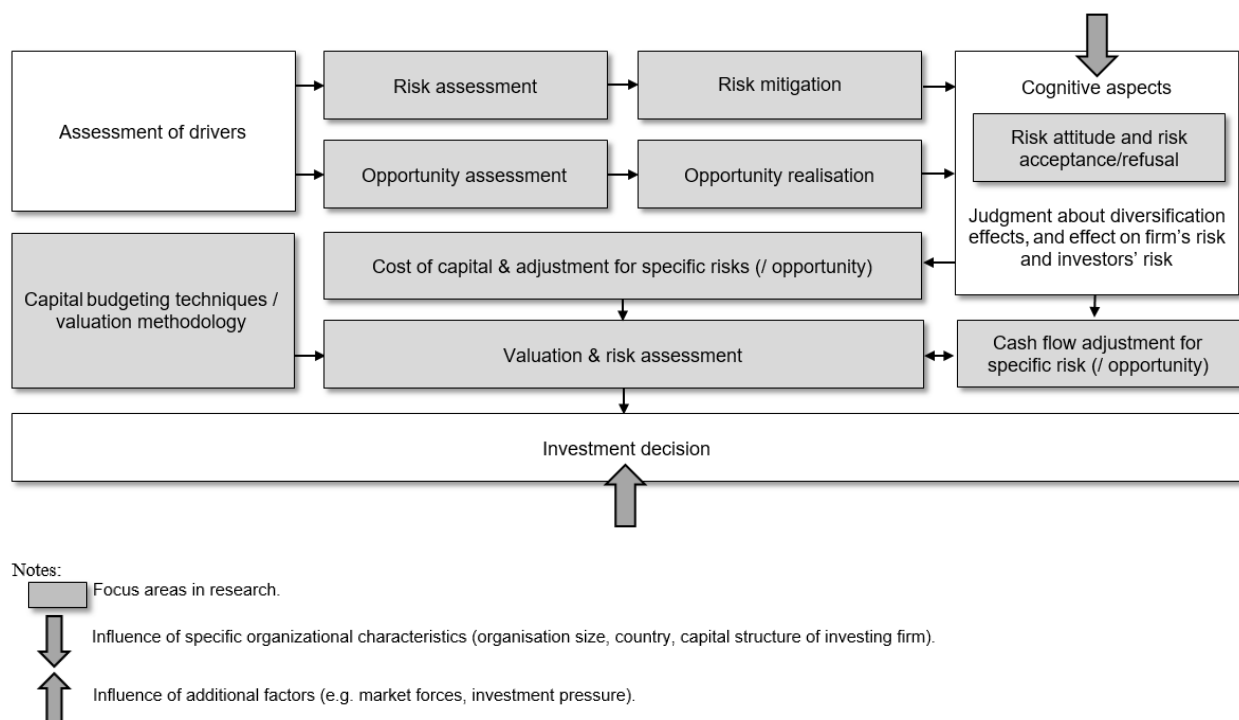

Based on the performed literature review, a conceptual framework (Figure 2) has been developed as basis for developing the online questionnaire and interview protocols, the subsequent quantitative and qualitative data collection and data analysis phase. This framework serves also as scheme to be tested in this research and to be subsequently adjusted, based on the found results.

## METHODOLOGY

### *Study design*

To answer the research questions, the researchers applied a mixed methods approach (Creswell et al., 2003, Teddlie and Tashakkori, 2009, Creswell and Plano Clark, 2011). According to Johnson et al. (2007), the “mixed methods research is an intellectual and practical synthesis based on qualitative and quantitative research; it is the third methodological or research paradigm (along with qualitative and quantitative research)”. It is an approach for collecting, analysing and mixing both quantitative and qualitative data and analysis results at some research stage within the same study (Creswell, 2005).

The rationale for applying mixing both types of data is that neither of both types are sufficient to capture the details of the studied phenomena, including the complexity and dynamics of valuation within transactions. The integration of data and analysis in mixed methods, including quantitative and qualitative approaches, includes the combination of elements in such a way not only to optimally answer the research questions, but also necessary to achieve the project goals, thus generating findings which are greater than the simple sum of its components (Bazeley, 2010) and providing a more complete picture of the research problem (Greene et al., 1989, Tashakkori and Teddlie, 1998, Johnson and Turner, 2003). The integration is not just a simple combination of qualitative and quantitative methods: “[...] they may indeed be more deeply intertwined” (Kane and Trochim, 2007:177). Furthermore, a mixed method approach (Saunders et al., 2009) is applied for an enhanced data collection procedure in order to gather data from a rich set of available source, including survey and subsequent interviews in this research. The use of follow-up interviews after responses to structured surveys is one of the most common data-gathering strategies applied within mixed method research (Bryman, 2006).

In this research, a sequential explanatory mixed method design is applied which consists of two distinct phases that follow each other. The study starts first with the quantitative data collection based on an online survey and subsequent quantitative data analysis with statistical methods conducted in the software SPSS, followed second by the qualitative data collection with interviews and qualitative data analysis within nVivo10 (QUAN → QUAL). As such, the quantitative data and analysis provide an overview of the applied valuation methods in RE investments and some influence factors, worked out from the literature while the qualitative data and its analysis provide the opportunity to dig deeper into the topic with thoroughly selected experts in the research field to explain the results from the previous part, to receive a more profound understanding of the topic and to discuss influence factors, deficiencies, issues and possible steps of improvements.

Each of those two phases have equal priority (QUAN and QUAL). The first time when the quantitative and qualitative phase are connected is at the point when the 12 interview partners are selected out of

the survey participants. The interference between the quantitative and qualitative results is performed at the stage of the discussion of the outcome of the complete study (Figure 3)

*Target population and sample*

The target population in this research are active participants in RE investment market in Switzerland and Germany, composed of equity investors in RE, such as utilities, independent power producers (IPP), project developers, fund managers, other financial investors, and financial advisors exclusively mandated by investors, as well as debt financing institutes, i.e. banks, to receive interesting insights and opportunities to compare with – even if questions of discount rate are difficult to be answered by banks. Those professionals hold a senior position within their organisations and are involved RE investment projects in the multimillion EUR scale. In Switzerland, there is no need to create a sample since the majority of the concerned population is known to the research team. In contrast, a study of the whole concerned German population would be impracticable, time consuming and overrun the research budget.

**Figure 3: A procedural diagram about the various research activities with the applied explanatory sequential mixed methods approach (adopted from Ivankova and Stick, 2007, Moubarac et al., 2012).**

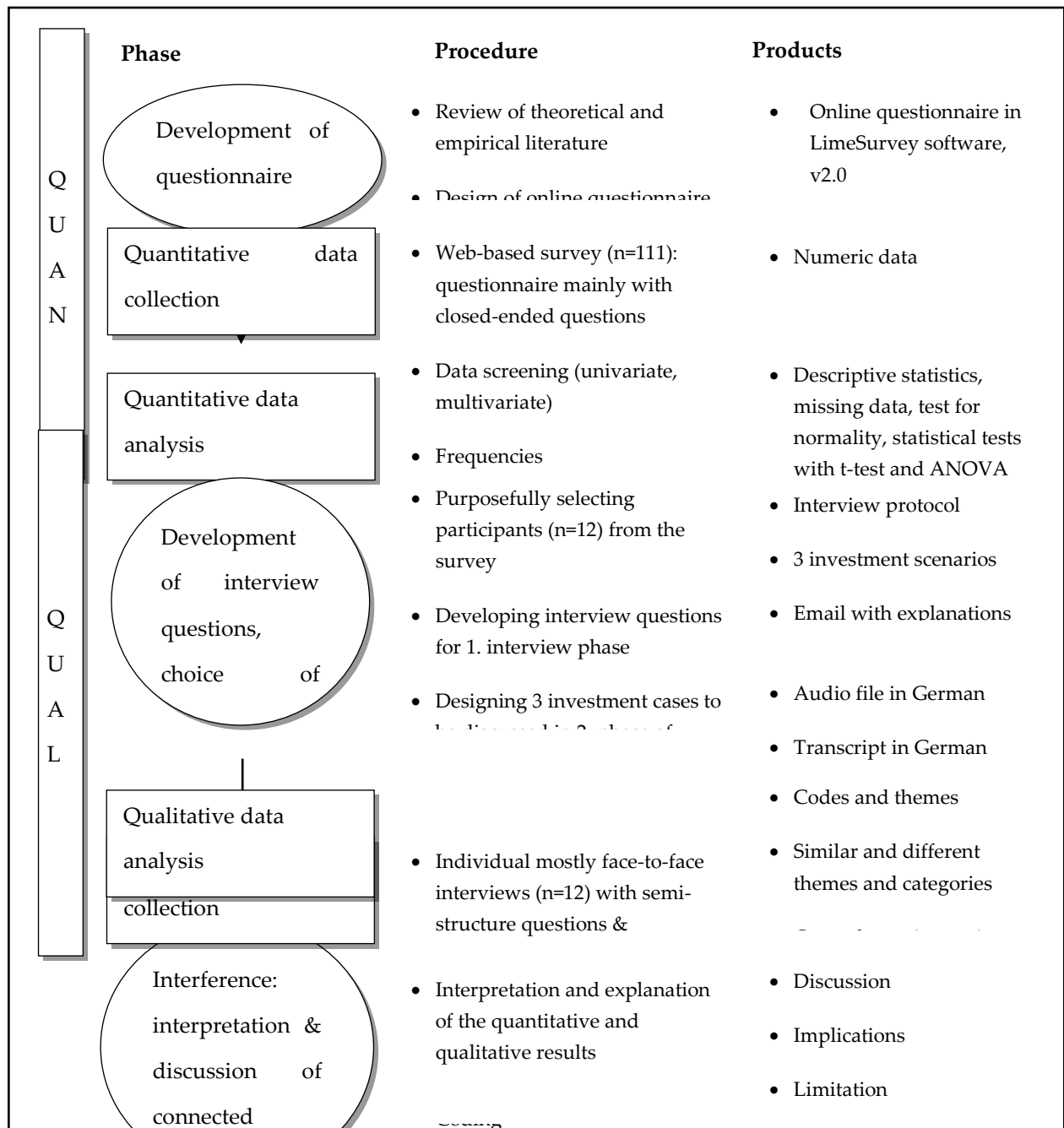

Since an accurate determination of the selected participants is not possible, “non-probability sampling” (Saunders et al., 2009:213) is applied for the quantitative phase. The sample is built by consulting participant lists of several major RE conferences in Germany and social media platforms, complemented with snowball techniques based on the survey participants’ network. For the qualitative phase, 12 participants a purposefully been selected from the participants of the survey. In line with the requirements of the selected typology *explanatory sequential mixed methods approach*, the participants for

the follow-up qualitative phase have been identified from the previous survey phase (Creswell and Plano Clark, 2011, Plano Clark and Ivankova, 2016) while ensuring at the same time ethical and data privacy requirements in case of matching participants and their data between the different phases (Bazeley, 2010).

### *Quantitative phase*

#### *Data collection*

An initial questionnaire has been created based on the extensive literature review (Hürlimann and Bengoa, in press) and findings identified in an exploratory interview phase, including questions asked in the famous studies of Graham and Harvey (2001) and Brounen et al. (2004) since their questions and applied answer scales have proved their validity. However, each of the posed questions have been adjusted and/or extended to match them to the research field. This survey was piloted with additional five experts in the research field and three scholars who provided valuable feedback and led to clarifications, simplification of questions and inclusion of additional brief explanations for certain questions.

The final questionnaire has been prepared in English to be sent to Germany and to all three language areas of Switzerland as online survey, running on the LimeSurvey software. The developed online survey is composed of five groups of mainly closed-ended questions. Firstly, general questions about RE investments were asked, including invested countries, technologies and entry phase in investment. Second group poses questions about risk, including the relevance of risk components in RE investments, materialisation and mitigation of risk. Thirdly, questions about how risk, return and its trade-off is understood within the organisations are asked. Finally, capital budgeting techniques are investigated, followed by questions about estimating cost of capital, before concluding the survey with demographic and control questions. The answer options for those questions are usually Likert type scales, except for questions about risk, return and its trade-off, risk mitigation and adjustment for risk with specific choices of answers. We sent 328 questionnaire to Swiss and German investors in RE projects, and obtained 111 responses. The overall response rate is 32.8%, considered as high, given the length and depth of our questionnaire, the required time to be able to seriously answer the stated in some cases rather complex questions and the restriction of some investment firms to participate due to confidentiality reasons.

The exploratory interviews and the survey piloting have been performed between April and September 2015, and the subsequent online survey between December, 2015 and March, 2016.

#### *Data analysis*

The collected survey data are quantitatively analysed with parametric statistical tests, such as univariate analysis of variance (ANOVA) and independent samples t-test, using IBM SPSS statistics.

The purpose of this analysis is to assess the significance of the empirical data about the applied valuation methodologies, risk factors and their priorities, and other dependent variables in relation to demographical factors and selected dependent variables. In addition, non-response bias and the robustness of the results are checked with additional statistical tests, including Pearson  $\chi^2$  test, Cronbach's alpha and Spearman's rank order correlation. The performed analysis shows acceptable to good internal reliability – in most cases.

### *Qualitative phase*

#### *Interview protocol development*

The content of the interview protocol is based on the quantitative results in the first study phase. The object of the qualitative phase is to explore and elaborate on the statistical results (Creswell et al., 2003) in order to better understand the influence of certain independent variables on the found results and discover additional influence factors relevant in valuation within transactions.

In order to reflect the main results of the quantitative phase with the interviewee, five open-ended questions explore additional features and potentially controversial topics in capital budgeting methods and cost of capital approaches. Three additional open-ended questions explore the influence of uncertainty/risk, risk assessment and risk mitigation and their integration in valuation and/or investment decision. A specific open-ended question aims for understanding the puzzling result from the quantitative phase about the risk components in relation to project stages. Additional open-ended questions investigate the effect of additional influence factors – beside of organisation type, size, leverage, stock exchange listing, project stages asked in the quantitative phase – such as an existing portfolios of the investment company, the integration of synergies and/or opportunities within valuation and/or investment decision taking. The last group of open-ended questions targets at finding encountered problems in valuation processes. Thereby, the issue of having the time value of money and the risk in one input variable, the discount rate, applied within valuation is presented and discussed while introducing the certainty equivalent (CE) approach as a possible theoretical solution for this issue.

#### *Investment scenarios*

In order to collect additional rich set of data and even deeper insights in the topic, three investment scenarios have been developed based on real investment cases. Prior to the interview, the interviewee received an email with a description about the investment scenarios to be prepared for the interview. The investment scenarios are based mainly on numerical key figures (descriptions and input data for the valuation) and numerical results of the performed valuation based on the various methodological approaches.

#### *Data collection*

The qualitative data collection has been performed by face-to-face interviews (expect two) to gather the richness of each dialog, including following stepwise procedure: (1) providing a written declaration about ensuring data protection and anonymity to each participant prior to starting the interview; (2) audio-taping each in-depth semi-structured interview which lasts about 50 to 70 minutes; (3) verbatim transcriptions by a professional bureau, involving the same transcripator for all interviews, literate in financial matters; (4) quality check of each transcription compared with audio material by main researcher; (5) uploading transcriptions to Qualitative Data Analysis (QDA) software as sources while enriching them with additional, collected demographic data, such as type of investor, highest education level, experience in transactions (amount and years).

#### *Qualitative analysis*

The applied qualitative data analysis goes a step further than just sorting text responses to particular question by a categorical variable with a spreadsheet and finding for example interesting quotes to be cited. Using specific QDA software, an optimal structural environment is provided to analysis complex responses in most flexible way, enabling detailed coding and even revised coding to additional categories while digging deeper into the responses (interview transcripts), letting emerge new and finer categories to be coded on and revealing new insights and concepts (Bazeley, 2010). QDA software enables “a richer and potentially more valid analysis [...]. Variations in responses can be better understood, and anomalies and alternative explanations examined” (Bazeley, 2010:438). The applied QDA software in this study is nVivo10. It is used for data storage, coding to both predefined and emerging categories and the developing of themes (Bazeley, 2010, David and Sutton, 2011).

## **RESULTS**

#### *Quantitative phase*

##### *Demographic information*

As a summary, descriptive statistics of the demography of the participants are provided. Most participants in the survey are from Switzerland (68%) compared to 32% from Germany. Utilities have the highest survey participant numbers (43%) and the financial advisors (8%) and banks (5%) the lowest survey participant numbers. In addition, the survey sample consist of more small organizations, defined as those organizations with less than 501 employees (58%), onshore wind is the main investment technology focus (41%), most companies have a low leverage (55%), defined as a debt ratio lower or equal than 40%, and are mostly not listed on stock exchanges (85%). About 95% of the participants have an academic degree while 21.4% have a MBA degree. Nearly half the participants are younger than 40 years (44%) while the majority of the participants are male (89%), and have performed more than ten transactions (58%).

**Table 5: Summary of the quantitative results of capital budgeting techniques, cost of capital approaches and risk assessment procedures (Hürlimann et al., in press).**

Techniques	% almost always (4) and always (5) <sup>1</sup>
<b>Capital budgeting techniques</b>	
Internal rate of return (IRR)	92.4
Net present value (NPV)	79.8
Estimate cost of equity capital of project (equity return rate)	65.0
Hurdle rate of return	63.9
Estimate total cost of capital of project (project return rate)	62.7
Payback period (PB)	44.4
<b>Basic approach to determine cost of capital or discount rate</b>	
Weighted Average Cost of Capital (WACC) of our company	67.0
Discount rates are at least as high as defined hurdle rates	59.0
Formal risk analysis	57.3
Benchmarking approaches with comparable companies or comparable investments	43.2
Capital Asset Pricing Model (CAPM, the beta approach)	35.3
<b>Specific approach to determine cost of capital or discount rate</b>	
A specific discount rate for the considered country (country discount rate)	65.9
A specific discount rate for the applied technology / concerned industry	60.0
A specific discount rate for the concerned project stage (e.g. planning/designing, financing, building, operating)	52.2
A risk-adjusted discount rate for this particular project (RADR concept)	44.4
<b>Risk assessment approaches</b>	
Scenario analysis (e.g. base case, worst case, best case)	79.4
Sensitivity analysis	75.7
Simulations (e.g. Monte Carlo simulations)	12.2
1 answer options: 1 = never; 2=Almost never; 3= Sometimes; 4= Almost always; 5=Always;	
<i>Applied valuation techniques</i>	

Table 5 provides a summary of the main quantitative findings<sup>4</sup> about capital budgeting techniques, basic and specific approaches to determine cost of capital or discount rate and risk assessment approaches.

In addition, risk mitigation measures – essential procedures during project valuation and investment transactions – are evaluated. They are performed by the majority of the respondents, for example by performing internal and external Due Diligences (83.0% / 75.0%), reducing operational risks with appropriated maintenance contracts (81.0%), arranging for machine failure insurances (69.0%) – in contrast to less frequently applied weather protection insurances (9.0%) – reducing market risks with feed-in tariffs or long-term power purchase agreements (68.0%) and with standardization of procedures (62.0%). Beside of avoiding and transferring risk during risk mitigation processes, the alternative option with risk adjustment in project valuations is done either within the applied discount rate for DCF based



methods and/or directly within the appropriate case flows, depending of the considered risk component (Hürlimann et al., in press).

### *Qualitative Phase*

#### *Themes and similarities between phases*

Various similar themes and sub-themes emerged in the analysis, as shown in Table 6, although they differ in terms of amount and similarity which is evaluated in more detail in the ongoing research.

Table 7 shows a first interference between the quantitative and qualitative analysis results in which confirmation, discrepancies, new insights and explanation are illustrated for some particularly interesting topics.

#### *Implementation of alternative valuation concepts*

Having discussed alternative concepts for valuation, such as the certainty equivalent (CE) method, within the investment scenario, some of the participants understand the need for improvements, but stress the fact that it could not be used as a sole concept in transactions since both the decision-making body and the seller would not be willing to implement or understand it (Table 6). It could however be a complementary concept, used internally, to compare different investments and built the basis for investment preferences when valuating several possible investment targets.

**Table 6: Themes and sub-themes, based on the coding of the transcripts.**

No.	Themes / Sub-themes / Categories	Participant no.											
		1	2	3	4	5	6	7	8	9	10	11	12
01	Capital budgeting techniques												
01.1	Quantitative approach:												
01.11	DCF:												
01.111	accepted method by most market participant	■		■	■	■	■	■	■	■	■	■	■
01.112	simple, straight-forward method		■			■		■					
01.13	Internal rate of return (IRR):												
01.131	better comparison between investments possible				■	■	■	■	■	■	■	■	■
01.132	output-IRR more appropriate than basic equity-IRR		■		■	■	■	■	■	■	■	■	■
01.14	Net present value (NPV)												
01.141	better comparison between investments possible												
01.142	NPV is less used than IRR in RE investment transactions	■		■	■	■	■	■	■	■	■	■	■
01.143	NPV more relevant for project developers		■										
01.15	Estimate cost of equity capital of project (equity return rate)	■	■	■	■	■	■	■	■	■	■	■	■
01.16	Estimate total cost of capital of project (project return rate)		■			■		■			■		
01.17	Payback period (PB) is applied	■											
01.18	Certainty equivalent (CE) method												

<sup>4</sup> The detailed results of the quantitative phase are published elsewhere (Hürlimann et al., in press).

01.181	CE is a viable alternative / to be evaluated for usage														
01.182	CE is not known / used by practitioners														
01.2	Qualitative approach:														
01.21	Service provider – assess counterpart risk														
01.22	Service provider – assess its ability														
01.23	Service provider – assess quality of contract														
01.24	Specific mitigation measurement														
01.25	Gut feeling + judgemental assessment														
01.26	What if discussion														
01.27	Appropriate figure illustrate qualitative characteristics of project														
02	Basic approach to determine cost of capital or discount rate														
02.1	Weighted Average Cost of Capital (WACC) of investing company														
02.2	Discount rates are at least as high as defined hurdle rates														
02.3	Capital Asset Pricing Model (CAPM) / Beta														
02.4	Information from similar previous/current transactions														
02.5	Exist strategy														
02.6	Set by investor														
02.7	Formal risk analysis														
03	Risk assessment approaches														
03.1	Scenario analysis (e.g. base case, worst case, best case)														
03.2	Sensitivity analysis														
03.3	Simulations (e.g. Monte Carlo simulations)														
03.4	PB particularly for risky countries														
03.5	Benchmarking														
03.6	Credit rating analysis														
03.7	Distribution profile (distribution IRR or figure)														
03.8	Table with risk points to add scores (scoring matrix)														

Table 2 (continued).

No.	Themes / Sub-themes / Categories	Participant no.													
		1	2	3	4	5	6	7	8	9	10	11	12		
04	Risk mitigation														
04.1	Formal risk mitigation approach (avoid, transfer, consider or accept/neglect)														
04.2	Due Diligence process														
04.3	Contractual agreements (O+M, insurances)														
04.4	Feed-in tariff														
05	Issues in valuation														
05.1	New theoretical concepts have problem to be accepted in the market and internal (particularly due to decision making body)														
05.2	Positive attitude to transaction+ Bias														
05.3	Rigid valuation methods not able to consider project specific circumstances														
05.4	Not considering volatility of resources from period to period														
05.5	Only deterministic approaches considered without any														

05.6	probabilistic approach								
05.6	Coupling of time value of money and risk in one single discount rate								
05.7	Inadequate consideration of balance sheet information and tax implications								
06	Improvements in valuation								
06.1	Taking banking approach / perspective								
06.2	Implement probabilistic approach								
06.3	Consideration of CE method								
06.4	Consideration of Beta from stock listed securities, solely investing in RE								
07	Investment decision								
07.1	Value vs. price								
07.2	Final risk assessment investment proposal								
07.3	Graphs could better illustrate qualitative, less non-numeric data, in addition to quantitative methods								
08	Additional factors influencing valuation beside of its input data								
08.1	Effect of existing portfolio								
08.2	Synergies between different investment projects								
08.3	Opportunities in investment projects								
08.4	Due diligence results								
08.5	Acting persons behind contracts								
08.6	Market forces								
08.7	The investing company's investment pressure								
08.8	Experience in RE investments/transactions								
08.9	Understanding the valuation by the decision making body								

**Table 7: Comparison of the quantitative (QUAN) and qualitative (QUAL) data analysis results.**

No.	Statement	QUAN	QUAL
01	Applied capital budgeting techniques/approaches for RE investments		
01.1	Quantitative approaches:		
01.11	DCF is the main method applied for RE investments, since it the accepted method in transaction by sellers and acquirers	+	+/expl.
01.12	Flow to equity (FTE) method is the preferred DCF method for RE investments	(+)	+
01.13	Within the FTE method, IRR is preferred compared to NPV	+	+
01.14	Virtual all-equity case is applied for testing project attractiveness		new
01.15	Both equity IRR and project IRR are relevant, but in variation of their priority	+	+
01.16	Multiples are applied for initial inv. screening and/or second opinion	(+)	new
01.17	Payback period method is only relevant for investment in risky countries		new
01.18	Certainty equivalent method is almost unknown / not used	+	+
01.19	Certainty equivalent method might be a complementary, valuable concept in valuation		new
01.2	Qualitative approaches:		
01.21	Judgemental assessments are widely applied in valuation of RE investments (in addition to numerical approaches)		new
01.22	Quality of partners, including their ability and credit rating particularly those with long terms, is a relevant qualitative factor in valuation	-	new

02	Cost of capital or discount rate		
02.1	Using CAPM with a pure-play Beta factor might become interesting in the future as soon as more RE portfolios (technology wise would be preferred) are traded on stock exchanges		new
02.2	Sellers often set discount rates depending previous transactions and/or information from a market sounding to maximise profit		new
02.3	Required discount rates are set in relation to exit strategies in case of investors with a defined investment period		new
03	Risk assessment, mitigation and adjustment		
03.1	Risk assessment of different risk components in relation to project stages	+	expl.
03.2	Risk mitigation and risk adjustments are widely applied	+	+ / new
04	Additional influencing factors		
04.1	Portfolio effects are not essentially considered in valuation		+
04.2	Possible synergies and opportunities of investment project are interesting to be known, but are not directly considered in valuation within transactions	+	+ / expl.
04.3	Market forces and internal investment pressure are key influencing factors in the transactions and correspondingly in valuation		New
04.4	The concept about calculating a value and setting the price has to be distinguished		New
	+ Agreement with statement; - no agreement with statement, new: new insight; expl.: explanation of quantitative results		

#### *Conclusion, implications and limitations*

The findings show that practitioners mainly apply the established concepts based on DCF methods since it is the accepted concept in transactions by both sellers and acquirers. Less agreement in the RE investment community exists how to set discount rates: various concepts exist from quite sophisticated to more pragmatic approaches. Newer theoretical valuation concepts are not adopted or even neglected, such as the risk adjusted discount rates (RADR) concept or the CE approach. This shows that there is still a considerable gap between theory and practice in RE investment valuation processes which corresponds to findings obtained in previous studies among practitioners on other areas (Gitman and Mercurio, 1982, Graham and Harvey, 2001, Brounen et al., 2004). After having presented quantitative and qualitative and some first integrated results, the research will concentrate on confirming and updating the presented conceptual framework and suggesting possible complementary steps to improve valuation process within transactions.

This quantitative research was limited to a relative small sample of German RE investors. Hence, it might be not representative and generalizable to the whole population. However, applying triangulations, the qualitative study could confirm the found results. As within similar studies (Graham and Harvey, 2001, Brounen et al., 2004), there is an essential reservation to be made. The research assumes that the participants act as agent of their companies, without verifying if their responses about views and opinions are translated into actions.

## REFERENCES

Ang, J. & Kohers, N. (2001) 'The take - over market for privately held companies: the US experience', Cambridge Journal of Economics, Vol. 25 No. 6, pp. 723-748.

- Bazeley, P. (2010) 'Computer-assisted integration of mixed methods data sources and analyses', In: Tashakkori, A. & Teddlie, C. (eds.) SAGE Handbook of mixed methods research for the social and behavioral sciences. Thousand Oaks, CA, SAGE, pp. 431-467.
- Bierman, H. (1993) 'Capital budgeting in 1992: a survey', *Financial Management*, Vol. 22 No. 3, pp. 24.
- Brandt, S. M. (2002) Die Berücksichtigung der Unsicherheit in der Planung bei der Bewertung von Pharma-Unternehmen [Translation: "The consideration of uncertainty in the planning for the evaluation of pharmaceutical companies"], PHD, Technische Universität Berlin.
- Brigham, E. F. & Houston, J. F. (2012) *Fundamentals of financial management*, Concise 7th ed. South-Western Cengage Learning, Mason, OH.
- Brounen, D., De Jong, A. & Koedijk, K. (2004) 'Corporate finance in Europe confronting theory with practice', EFA 2004 Maastricht Meetings Paper No. 2769, [online] <http://ssrn.com/abstract=559415> (Accessed 24 February 2015).
- Bryman, A. (2006) 'Integrating quantitative and qualitative research: how is it done?', *Qualitative research*, Vol. 6 No. 1, pp. 97-113.
- Capron, L. & Shen, J.-C. (2007) 'Acquisitions of private vs. public firms: private information, target selection, and acquirer returns', *Strategic Management Journal*, Vol. 28 No. 9, pp. 892-911.
- Cotner, J. S. & Fletcher, H. D. (2000) 'Computing the cost of capital for privately held firms', *American Business Review*, Vol. 18 No. 2, pp. 27-33.
- Creswell, J. W. (2005) *Educational research: Planning, conducting, and evaluating quantitative*, 2nd ed. Prentice Hall Upper Saddle River, NJ.
- Creswell, J. W. & Plano Clark, V. L. (2011) 'Choosing a mixed methods design', In: Creswell, J. W. & Plano Clark, V. L. (eds.) *Designing and Conducting Mixed Methods Research* Thousand Oaks, CA, Sage, pp.
- Creswell, J. W., Plano Clark, V. L., Gutmann, M. L. & Hanson, W. E. (2003) 'Advanced mixed methods research designs', In: Tashakkori, A. & Teddlie, C. (eds.) SAGE Handbook of mixed methods in social and behavioral research. Thousand Oaks, CA, SAGE, pp. 209-240.
- Damodaran, A. (2012) *Investment valuation: Tools and techniques for determining the value of any asset*, 3rd ed. John Wiley & Sons, Hoboken, NJ.
- Damodaran, A. (2013) 'Equity Risk Premiums (ERP): Determinants, Estimation and Implications - The 2013 Edition', Social Science Research Network, [online] <http://ssrn.com/abstract=2238064> (Accessed 20 September 2013).
- David, M. & Sutton, C. D. (2011) *Social research: An introduction*, 2nd ed. SAGE, London, UK.
- Driessen, J., Lin, T.-C. & Phalippou, L. (2012) 'A New Method to Estimate Risk and Return of Nontraded Assets from Cash Flows: The Case of Private Equity Funds', *Journal of Financial and Quantitative Analysis*, Vol. 47 No. 3, pp. 511-535.
- Ehrhardt, M. C. & Brigham, E. F. (2016) *Corporate finance: A focused approach*, Cengage Learning, Boston.
- Fuller, R. J. & Kerr, H. S. (1981) 'Estimating the Divisional Cost of Capital: An Analysis of the Pure-Play Technique', *Journal of Finance*, Vol. 36 No. 5, pp. 997-1009.
- Gitman, L. J. & Mercurio, V. A. (1982) 'Cost of capital techniques used by major US firms: survey and analysis of Fortune's 1000', *Financial Management*, Vol. 14 No. 4, pp. 21-29.
- Graham, J. R. & Harvey, C. R. (2001) 'The theory and practice of corporate finance: Evidence from the field', *Journal of Financial Economics*, Vol. 60 No. 2, pp. 187-243.
- Greene, J. C., Caracelli, V. J. & Graham, W. F. (1989) 'Toward a conceptual framework for mixed-method evaluation designs', *Educational evaluation and policy analysis*, Vol. 11 No. 3, pp. 255-274.
- Hürlimann, C. & Bengoa, S. D. (in press) 'Corporate Finance in Renewable Energy Investments - A Review about Theory and Practice', *Global Economics and Business Review*, Vol. 19.
- Hürlimann, C., Bengoa, S. D. & al-Ali, J. (in press) 'Theory and practice of valuation approaches in renewable energy investments: a survey among investment professionals', Vol.
- Initiative-Europe (2005) *European Buyouts 2004: Strong Volumes Provide Record Value*, Europe Buyout Review (Report).
- Ivankova, N. V. & Stick, S. L. (2007) 'Students' persistence in a distributed doctoral program in educational leadership in higher education: A mixed methods study', *Research in Higher Education*, Vol. 48 No. 1, pp. 93.
- Johnson, B. & Turner, L. A. (2003) 'Data collection strategies in mixed methods research', In: Tashakkori, A. & Teddlie, C. (eds.) *Handbook of mixed methods in social and behavioral research*. Thousand Oaks, CA, SAGE, pp. 297-319.
- Johnson, R. B., Onwuegbuzie, A. J. & Turner, L. A. (2007) 'Toward a definition of mixed methods research', *Journal of mixed methods research*, Vol. 1 No. 2, pp. 112-133.
- Kane, M. & Trochim, W. M. (2007) *Concept mapping for planning and evaluation*, SAGE Thousand Oaks, CA.

- Monnin, P. 2015. Low Interest Rates: An Opportunity for Renewables. Available from: <https://www.cepweb.org/low-interest-rates-an-opportunity-for-renewables/> (accessed February 27, 2017).
- Moskowitz, T. J. & Vissing-Jørgensen, A. (2002) 'The Returns to Entrepreneurial Investment: A Private Equity Premium Puzzle?', *American Economic Review*, Vol. 92 No. 4, pp. 745-778.
- Moubarac, J.-C., Cargo, M., Receveur, O. & Daniel, M. (2012) 'Describing the situational contexts of sweetened product consumption in a Middle Eastern Canadian community: application of a mixed method design', *PLoS one*, Vol. 7 No. 9, pp. e44738.
- Petersen, C., Plenborg, T. & Schøler, F. (2006) 'Issues in valuation of privately held firms', *The Journal of Private Equity*, Vol. 10 No. 1, pp. 33-48.
- Ping, C., Zhenguang, L. & Yingchun, L. (2013) 'Liquidity Risk of Private Assets: Evidence from Real Estate Markets', *Financial Review*, Vol. 48 No. 4, pp. 671-696.
- Plano Clark, V. L. & Ivankova, N. V. (2016) *Mixed Methods Research: A Guide to the Field*, Sage, Los Angeles, London.
- Saunders, M., Lewis, P. & Thornhill, A. (2009) *Research Methods for Business Students*, Pearson Education Limited, Essex, England.
- Shah, S. (2011) 'Spanish Government faces Lawsuits over Solar Feed in Tariff Cuts from ASIF'. *Green World Investor*, [Online]. 25 January. <http://www.greenworldinvestor.com/2011/01/25/spanish-government-faces-lawsuits-over-solar-feed-in-tariff-cuts-from-asif/> (Accessed 10 January 2015).
- Tashakkori, A. & Teddlie, C. (1998) *Mixed methodology: Combining qualitative and quantitative approaches*, Sage.
- Teddlie, C. & Tashakkori, A. (2009) *Foundations of mixed methods research: Integrating quantitative and qualitative approaches in the social and behavioral sciences*, Sage Publications Inc.
- Thakkar, R. (2015) Low interest rates and technology drive renewable energy, *livemint* [online] <http://www.livemint.com/Money/JHyIpkj4j0iT8zeFD8q1dO/Low-interest-rates-and-technology-drive-renewable-energy.html> (Accessed February 27, 2017).
- Titman, S. & Martin, J. D. (2008) *Valuation: the art and science of corporate investment decisions*, Pearson, Addison-Wesley.
- Warren, B. (2014) Chief Editor's Note, RECAI. [online]. EY, 40, February. [http://www.ey.com/Publication/vwLUAssets/RECAI\\_40\\_-\\_February\\_2014/\\$FILE/EY\\_RECAI%2040\\_Feb%202014.pdf](http://www.ey.com/Publication/vwLUAssets/RECAI_40_-_February_2014/$FILE/EY_RECAI%2040_Feb%202014.pdf) (Accessed 1 October 2015).
- Wassmann, A., Martin, F. & Ebner, M. (2016) Market study - Investments in Renewables Survey of Institutional Investors 2015, [online]. KGAL. [http://www.kgal-group.com/uploads/tx\\_newsdownloads/KGAL\\_markets\\_study\\_infrastructure\\_2015\\_01.pdf](http://www.kgal-group.com/uploads/tx_newsdownloads/KGAL_markets_study_infrastructure_2015_01.pdf) (Accessed 5 January 2016).
- Weston, J. F. (1973) 'Investment decisions using the capital asset pricing model', *Financial Management*, Vol. 2 No. 2, pp. 25-33.

## DOES EMPLOYEE ENGAGEMENT AFFECT CLIENT LOYALTY IN B2B SERVICES?: A QUALITATIVE STUDY IN THE ADVERTISING INDUSTRY IN SERBIA

Josic, Sinisa<sup>1</sup>, Petrosyan, Armine<sup>2</sup>; Dimitriadis, Nikolaos<sup>3</sup>

<sup>1</sup>Executive MBA, The University of Sheffield International Faculty- CITY College, Thessaloniki, Greece

<sup>2</sup>Business Administration and Economics Department, The University of Sheffield International Faculty- CITY College, Thessaloniki, Greece

<sup>3</sup>Executive Development Institute, The University of Sheffield International Faculty- CITY College, Thessaloniki, Greece

### ABSTRACT

The way by which companies retain their clients and the actions they need to undertake to achieve that, has become the focal point of both theory and practice in modern. In this direction, studies increasingly find that employee engagement has become a very important factor for improving client loyalty. However, most of studies focused on B2C markets; studies that in the B2B market, and especially in the marketing industry itself, are both very rare and, sometimes, with inconsistent findings.

The purpose of this study was to provide a deeper understanding of employee engagement and client loyalty, and of the interactions between these two concepts. The study tried to answer three key questions: *What is employee engagement and client loyalty in the B2B marketing services market? What are the main drivers that influence employee engagement and client loyalty? In which ways does employee engagement influence client loyalty?*

The study has used a qualitative research approach. Twenty respondents in total have been interviewed, top managers, employees and clients of a leading advertising agency in Serbia, member of a global advertising network.

Findings confirmed that employee engagement is very important for success, and that it has got a definite and positive impact on client loyalty. The study has discovered that, maybe surprisingly, client loyalty has a positive impact on employee engagement in return. The paper improves current theory on the links between employee engagement, client loyalty and business outcomes by revealing new aspects of those concepts in the B2B marketing services market.

*Keywords: employee engagement, drivers of engagement, client loyalty, drivers of loyalty, qualitative survey, B2B, marketing and advertising services*

## INTRODUCTION

*“Increasing customer retention rates by 5% increases profits by 25% to 95%”.* (Reichheld and Schefter, 2000).

This fact stresses the importance of the renewal of the relationship with existing clients and poses an important question: how can companies retain clients and what do they need to do to make it happen? The answer to this question is especially important in the B2B sector where one client lost could significantly cut revenue and profits. Loyalty is crucial since, according to many studies, client loyalty is one of the most important predictors of long-term profitability (Fairlie, 2011; Moisescu, 2014; Pugh et al, 2002). Even though many studies have examined client loyalty still there is no full consensus about the definition of this concept.

Regarding the drivers of client loyalty, studies usually emphasize the importance of different factors (Beverland et al, 2002; Rauyruen and Miller, 2007; Hesrket et al, 2008; Harste and Richter, 2009; Loury, 2015; Watson et al, 2015; Gerlach et al, 2016; Levin et al, 2016). In a recent study, Kumar and Pansari (2016) have found that influence of employee engagement on client loyalty is significant and have stated that this influence is moderated by employee’s empowerment. According to the same authors this effect is stronger in B2B segment and service companies. However, studies which examine this concept in B2B segment are still rare and findings are not consistent. Therefore, additional studies are urgently needed.

Employ engagement has become a major focal point in management research, and probably one of the hottest topics in contemporary business literature. However, most of the interest is from a human resources and internal corporate culture perspective and not equally enough from a marketing one. Many studies have confirmed that there are a lot of drivers which influence employee engagement. According to Markos and Sridevi (2010), the following drivers are presented in all studies: feeling valued by management, two-way communication between management and employees, management’s interest in employees’ well-being and their professional development. A lot of studies have confirmed that engaged employees significantly influence companies’ performance (Dale Carnegie Report, 2012; Kataria et al, 2012; Aon Hewitt Report, 2013; Gupta and Sharma, 2016) and thus putting employee engagement at the forefront of modern management and marketing.

The contribution of this study for academia is gained through its deeper understanding of two very important concepts that are still not fully defined: employee engagement and client loyalty. The fact that studies which examine B2B sector are rare additionally emphasizes contribution of this study to theory development. The importance of employee engagement and the fact that the key drivers of employee engagement are in essence in financial control of a company, stresses the relevance of these findings for companies and practitioners in the B2B service sector.



The purpose of this study was the deeper understanding of the influence of employee engagement on client loyalty in the B2B marketing service sector, through a qualitative research with a diverse sample at a leading advertising agency, member of a global network, in Serbia. This deeper understanding of the influence of employee engagement on client loyalty was through three main research questions:

- RO 1: *What is employee engagement and client loyalty in the chosen industry?*
- RO 2: *What are the main drivers that influence employee engagement and client loyalty?*
- RO 3: *In which ways does employee engagement influence client loyalty?*

## **CONCEPTS: EMPLOYEE ENGAGEMENT AND CLIENT LOYALTY**

Sinai (2013) agrees that there is no specific definition of employee engagement, but for better understanding of this concept she has suggested the following three elements:

- Employee engagement is about an emotional connection an employee has with his/her work.
- Employee engagement inspires the employee to put discretionary effort into his work.
- Employee engagement is directly correlated with organizational performance and business results.

In spite of the fact that many authors have given their own definition of employee engagement, until today there has been no accepted definition of this concept.

According to AON Hewitt Report (2013) there are three attributes (outcomes) of employee engagement:

- Say – speak positively about the organization to co-workers, potential employees and customers
- Stay – have an intense sense of belonging and desire to be a part of the organization
- Strive – be motivated and exert toward success in the job and for the company

In order to fully understand employee engagement and client loyalty concepts and their relations, articles also analyze topics such as: outcomes of employee engagement, drivers of employee engagement, drivers of client loyalty, and influence of employee engagement on client loyalty (Shuck et al., 2011; Kataria et al., 2012). In spite of the large number of studies that examine these concepts, almost all authors agree that still there are no consensus definitions of employee engagement and client loyalty (Schaufeli et al., 2006; Yalabik et al., 2013). On the other hand, all authors agree that there are many drivers that influence employee engagement and emphasize that these drivers are not the same for all employees and that they change during time (Biswas, 2013). Therefore, in theory there is no consensus about drivers of employee engagement as well. In literature review are also presented some practical models about employee engagement and how it

could be managed (Xanthooulour et al., 2009). Furthermore, here are presented models of client loyalty, as well as main drivers that influence client loyalty. Several studies have confirmed that employee engagement influences client loyalty (Salanova et al., 2005; Kataria et al., 2012). However, most of these studies are focused on B2C market; studies that have examined B2B market are very rare and some findings are not consistent.

In order to understand influence of employee engagement on organizational performance Kataria et al. (2012) analyze influence of employee engagement on organizational effectiveness. Concept "organizational effectiveness" is defined as "the degree to which an organization realizes its goals" (Salanova and Schaufeli, 2008; Kataria et al., 2012, p. 105). According to Schaufeli et al. (2006) organizational effectiveness has three key aspects: productivity, adaptability and flexibility. Kataria et al. (2012) have stated that there are at least two reasons which link employee engagement with organizational effectiveness. Firstly, employee engagement is critical element for business success. Secondly, engaged employees are more likely to do things which improve organizational effectiveness (Zeithaml, 2000).

Gupta and Sharma (2016) have stated that many studies have found that employee engagement is significantly correlated with organizational outcomes such as: retention, turnover, productivity, customer service, customer loyalty, growth in operating margins, increased profit margins and revenue growth rates. Influence of engaged employees on business results could be summarized in four groups: higher retention, better financial performance, higher customer loyalty and higher profitability (Saxena and Singh, 2015).

## METHODOLOGY

This study used a **qualitative research approach**. Qualitative research is considered as more subjective so one of the main questions is how to gain objectivity (Lawrence and Tar, 2013). Barnham (2015) argues that there are number of approaches which could improve validity of qualitative research, and **sample triangulation** has been applied here. Thus, three groups of interviewees have been included: top managers, employees and clients.

Regarding the sampling method, purposive sampling has been used. In total, 20 information-rich respondents have been interviewed. Interviewees included in the study are as follows: five top managers, 10 employees and five clients. Only employees who had the most experience and insights into the research topics were included, meaning employees who work in the client service department and have direct contacts with clients. Regarding clients, they were chosen based on the following: the have a continues contract with the agency, they have been directly involved in the decision making process for choosing marketing agencies and have continuous contact with the agency. Concerning top

managers, they were chosen based on their exposure to clients and to their structural influence in strategically engaging employees in the agency.

## FINDINGS AND IMPLICATIONS

Findings support Sinai (2013) description of employee engagement through three elements: brings passion to work, employees go beyond the duty, and directly influence organizational performance. Furthermore, the findings are in line with Fernandez (2007) who distinguishes employee engagement and job satisfaction. However, findings agree with Fernandez that one employee could be engaged even if he or she is not satisfied, but only in the short run. Similarly to Van Beek et al. (2012), findings clearly differentiate employee engagement from workaholism and burnout. Employee engagement is considered as healthy and positive motivational state, while workaholism is described as fully negative which leads employee into the burnout.

According to the findings, engaged employees are: loyal to the company and more willing to speak positively about company, have higher objectives to strive for, have more energy and give maximum to do their job the best as possible. All these findings support AON Hewitt Report (2013) in which is stated that there are three attributes of employee's engagement: say, stay and strive. However, findings have indicated some other characteristics (outcomes) of employee engagement as well. Moreover, engaged employees are also flexible, open and helpful (willing to help their colleagues).

Code	Employees	Top Managers	Clients
Ready to <b>give more</b>	agree	agree	agree
There is <b>higher purpose</b>	agree	agree	agree
<b>Must be satisfied</b>	partially agree	partially agree	partially agree
Different from <b>workaholics</b>	agree	agree	agree
Do not lead to <b>burnout</b>	disagree	disagree	disagree
Identify with <b>companies' objectives</b>	agree	agree	agree

Table 1. *Results on: What is employee engagement?*

Code	Employees	Top Managers	Clients
Have <b>higher objectives</b>	agree	agree	agree
<b>Flexible and open</b>	agree	agree	agree
<b>Identified with companies' objectives</b>	agree	agree	agree
<b>Have more energy</b>	agree	agree	agree
<b>Team oriented</b>	agree	agree	agree
<b>Supportive</b>	agree	agree	agree
<b>Responsible</b>	agree	agree	agree

Table 2. *Results on: Main characteristics of employee engagement*

Research findings fully support list of characteristics of engaged employees given by Biswass (2013): more productive, open, eager to learn, have better balance work-life, and have better relations with colleagues.

According to Gupta and Sharma (2016) employee engagement influences business results in four ways: higher retention, better financial performance, higher customer loyalty and higher profitability. Findings of the study have confirmed that employee engagement positively influences business results in all four ways.

Code	Employees	Top Managers	Clients
Quality of products/services	agree	agree	agree
Client's satisfaction	agree	agree	agree
Higher employees' retention	agree	agree	agree
Higher profit	agree	agree	agree
Higher efficiency	agree	agree	agree

Table 3. Results on: Main outcomes of employee engagement

Research findings agree with Dale Carnegie Training Report (2012) that there are three key drivers of employee engagement: relationship with immediate supervisor, belief in senior leadership, and pride in working for the company. However, research findings have discovered the importance of some other drivers as well: employee's personality and team. Findings have shown that personality of an employee is one of the most important drivers of employee engagement. Furthermore, this driver cannot be compensated with anything else.

According to Aon Hewitt Report (2013) there are many drivers of employee engagement. In the same report it is stated that these drivers could be grouped into six groups: work, people, opportunities, total rewards, company practice and quality of life. In spite of the fact that findings fully support this model, the importance of employee's personality as one of the key drivers of employee engagement is not mentioned in this model.

Code	Employees	Top Managers	Clients
Team	agree	agree	agree
Trust and open communication with manager	agree	agree	agree
Feedback and recognition by manager	agree	agree	agree
Support of manager	agree	agree	agree
Autonomy of employee	agree	agree	agree
Clear goals and objectives	agree	agree	agree
Manager - lead by example	agree	agree	agree
Award	agree	agree	agree
Financial compensation (salary)	partially agree	partially agree	partially agree
Type of work	agree	agree	agree
Mission of the company	agree	agree	agree
Working time	agree	agree	agree
Employee's personality	agree	agree	agree

Table 4. Results on: Main drivers of employee engagement

Findings agree with Development International Institute (DDI, 2005) that manager is important for employee engagement and that he or she needs to do five things in order to create engaged employees:

align efforts with company's vision and strategy, empower people and give them more autonomy, promote and encourage teamwork, help people to develop, and provide support and recognition.

Similarly, to the Aon Hewitt Report (2013), research findings have confirmed that drivers of employee engagement are not universal. Additionally, majority of findings support Bersin (2014) that pay (compensation) is "hygiene factor", not engagement driver. However, some of the findings have emphasized that financial factor is still important driver in Serbia. Additionally, findings have confirmed that drivers of employee engagement change during time.

Findings have described client loyalty as a mix of attitudes as well as behaviors that positively benefit the Agency and in that way supported Watson et al. (2015) definition (p.1) "a mix of attitudes and behaviors that benefit one firm relative to its competitors". According to the research findings, client is loyal if: continues contract with the Agency, trusts the Agency, considers Agency as a partner, and recommends the Agency to the other companies.

Code	Employees	Top Managers	Clients
Contract renewal	agree	agree	agree
Client's recommendation	disagree	agree	agree
Open relationship	agree	agree	agree
Long term relationship	agree	agree	agree

Table 5: Results: How interviewees define client loyalty

Research findings have confirmed what Beverland et al. (2002) have found that proactivity is important driver of client's satisfaction within Agency-Client relationship. Furthermore, findings have confirmed Watson et al. (2015) list of the most important drivers of client loyalty: commitment, trust and satisfaction. However, according to the findings loyalty incentives are not relevant driver for client loyalty in Agency-Client relationship. Additionally, study has confirmed Harste and Richter (2009) argument that non-economic factors such as satisfaction, trust, reputation and commercial friendship influence client loyalty.

Code	Employees	Top Managers	Clients
Corporate relationship	agree	agree	agree
Relationship (account-brand manager)	agree	agree	agree
Personal relationship	partially agree	agree	agree
Quality of communication	agree	agree	agree
Quality of products and services	agree	agree	agree
Agency understands client's business	agree	agree	agree
Agency's dedication	agree	agree	agree
Price of products/services	partially agree	partially agree	partially agree
Client's organization	agree	agree	agree

Table 6. Results on: Main drivers of client loyalty

Research findings support Kumar and Pansari (2016) finding that there is influence of employee engagement on client loyalty. Additionally, it agrees with Dale Carnegie & Associates white paper (2012) that engaged employees lead to engaged clients. Furthermore, research findings support Yalabik

et al. (2009) argument that employee engagement influences employee's performance and intention to quit. Moreover, research findings have indicated that employee engagement is very important for client loyalty because: employee engagement improves relationship with the client, improves communication with the client, Agency is more dedicated, and improves quality of products and services. Moreover, study has confirmed findings of Levin et al. (2016) that advertising agencies need to provide all elements related to inter-firm relationship and creativity in order to gain their loyalty.

Code	Employees	Top Managers	Clients
Improves relationship	agree	agree	agree
Improves quality of products and services	agree	agree	agree
Improves communication	agree	agree	agree
Improves Agency's dedication	agree	agree	agree
Agency better understands client's needs	agree	agree	agree

Table 7. *Results on: Influence of employee engagement on client loyalty*

In the end, research findings have discovered that client loyalty in return improves employee engagement as well. Employees consider client loyalty as a feedback for well done job and a kind of recognition.

Findings have shown that employees could be engaged even if they are not satisfied. However, this is possible only in the short run, in the long run employee will leave the company. Therefore, for any company it is very important to regularly measure employee satisfaction and to implement programs and initiatives that will keep employee satisfaction on high level. Special attention must be paid on the most valuable people in the company.

This study has shown that "personality" of employee is one of the most important drivers of employee engagement. Therefore, employee engagement cannot be separated from recruitment process. Companies need to develop recruitment procedures that will enable selection of employees who have tendency to be engaged and like certain type of work. Moreover, company should consider rotation of employees in order to find the most suitable position for every employee.

Engagement of one team member improves engagement of the other team members as well. In order to increase engagement of their teams, companies must ensure that in every team there are highly engaged employees. Trainings and education of managers, in order to develop their skills which would enable them to influence employee engagement in a positive way, are very important for employee engagement in the company. Through these trainings managers should become able to: align efforts with company's vision and strategy, empower people and give them more autonomy, promote and encourage teamwork, help people to develop, and provide support and recognition.

Top managers influence employee engagement through setting corporate culture, mission and vision of the company. Therefore, top managers need to constantly communicate mission, vision and values of the company and to ensure that all other efforts in the company are aligned with them.

Since drivers of employee engagement are not the same for every department in the company and for every employee, it is important that company clearly identifies the most important drivers in each department. After identification of key drivers in departments, company should develop programs that are tailored according to the specifics of each department. Additionally, research findings have shown that drivers of employee engagement change during time. Therefore, company needs to constantly measure importance of drivers and to implement insights of these changes into engagement programs, manager trainings etc.

Research findings indicate that client loyalty also improves employee engagement. Agencies should use this insight in order to develop joint initiatives with their clients which will improve engagement of teams responsible for these clients. Moreover, through development of joint initiatives agencies will show proactivity, dedication and commitment to the relationship with the client what will additionally boost the client's loyalty. Additionally, agencies should use positive clients' feedback in order to internally promote team's success and to give recognition to the team members responsible for this success.

## CONCLUSIONS

The findings of this study have confirmed that practitioners define employee engagement as the readiness of employees to go extra mile to reach company's objectives. Employee engagement is considered as completely positive concept, without negative consequences. In addition to this, findings have shown that employee engagement is clearly differentiated from negative concepts such as workaholism and burnout.

This study has indicated that there are many characteristics of employee engagement and all of them have positive influence on company's performance. It has confirmed that main characteristics of engaged employees are: they strive to gain company's objectives, have more energy, are team oriented and flexible. However, it has revealed some new characteristics as well: engaged employees have higher objectives, they are open, supportive and responsible.

Findings have confirmed that employee engagement has positive influence on all aspects of company's performance. Moreover, findings support Gupta and Sharma (2016) argument that employee engagement influences company's success in four ways: higher retention, better financial performance, higher customer loyalty and higher profitability.

There are many drivers that influence employee engagement and most of these drivers are in control of a company's management. Direct managers, salary, type of work and team are very important drivers of employee engagement. On the other hand, the study has revealed some other drivers as well: employee's personality and top management. Furthermore, the study has emphasized that direct manager influences employee engagement in different ways: trusts employees, has open communication with employees, gives feedback, gives recognition for good work, supports employees, gives autonomy to an employee, sets an example and sets clear goals. The study has also indicated that drivers are not universal for all employees and all departments and that they change over time. Regarding the importance of job satisfaction for employee engagement, study has found that in the long run employees must be satisfied with their job in order to be engaged.

The study has also indicated that there are many drivers of client loyalty and confirmed that quality of products and services, quality of relationship between account manager and brand manager, dedication of the Agency, and trust are some of the most important ones. Moreover, the study has revealed some other drivers as well: corporate relationship, client's organization, that Agency understands client and good communication between a client and Agency. Moreover, the findings support Watson et al. (2015) argument that the most important drivers of client loyalty are commitment, trust and satisfaction. However, study has not found that loyalty's incentives influence client loyalty in Agency-Client relationship.

Findings have indicated that employee engagement has positive influence on client loyalty. Accordingly, the study supports Kumar and Pansari (2016) argument that there is influence of employee engagement on client loyalty. Additionally, findings have shown that employee engagement influences client loyalty in several ways: improves relationship with a client, improves communication with a client, Agency is more dedicated, and improves quality of products and services. In the end, study has confirmed that client loyalty improves employee engagement. Hence, employees consider client loyalty as a feedback for well-done job and a kind of important recognition.

This study provides several opportunities for further researches. Importantly, this study should be followed with quantitative studies that could test the following conceptual framework and provide a wider generalization of these findings.



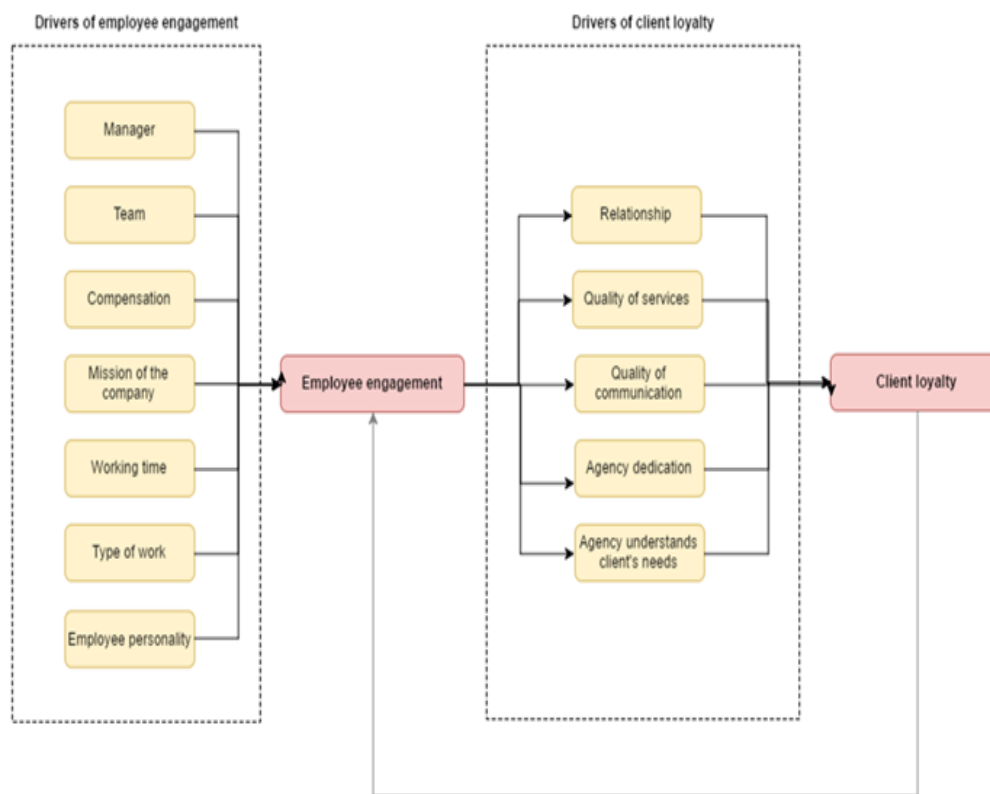

Figure 1. *Conceptual Framework: Influence of employee engagement on client loyalty based on this study*

## REFERENCES

- AON Hewit (2015), "Trends in Global Employee Engagement". Aon plc, pp. 1-48.
- Barnham, C. (2015), "Quantitative and qualitative research. Perceptual foundations". *International Journal of Market Research*, Vol. 57 No. 6, pp. 837-854.
- Bersin, J. (2014), "It's Time To Rethink The 'Employee Engagement' Issue", available at: <http://www.forbes.com/sites/joshbersin/2014/04/10/its-time-to-rethink-the-employee-engagement-issue/#4b1a0b601827> (accessed 18 February 2017).
- Beverland, M. et al. (2002), "Exploring the Dimensions of Proactivity Within Advertising Agency-Client Relationships". *Journal of Advertising*, Vol. 36 No. 4, pp. 49-60.
- Biswas, M. (2013), "Driving business results". *Human Capital*, Vol. 17 No. 1, pp. 46-51.
- Dale Carnegie & Associates (2012), "What Drives Employee Engagement And Why It Matters". White paper, p. 1-6.
- Fairlie, P. (2011), "Meaningful Work, Employee Engagement, and Other Key Employee Outcomes: Implications for Human Resource Development". *Advances In Developing Human Resources*, Vol. 13 No. 4, pp. 508-525.
- Fernandez C.P. (2007), "Employee Engagement". *Journal of Public Health Management & Practice*, Vol. 13 No. 5, pp. 524-526.
- Gerlach, G. I. et al. (2016), "Salespersons' empathy as a missing link in the customer orientation-loyalty chain: an investigation of drivers and age differences as a contingency". *Journal of Personal Selling & Sales Management*, Vol. 36 No. 3, 221-239.

- Gupta, N. and Sharma, V. (2016), "The Relationship Between Corporate Social Responsibility and Employee Engagement and Its Linkage to Organizational Performance: A Conceptual Model". *IUP Journal Of Organizational Behavior*, Vol. 15 No. 3, pp. 59-75.
- Harste, R. and Richter, A. (2009), "Determinants Of Client Loyalty For Consulting Services". In *Academy of Management Proceedings*, No. 1, pp. 1-6.
- Heskett, J. L. et al. (2008), "The ownership quotient: the service profit chain to work for unbeatable competitive advantage", Harvard Business Press.
- Moisescu, O. (2014), "Assessing Customer Loyalty: A Literature Review", in *Proceedings of the Multidisciplinary Academic Conference on Economics, Management and Marketing in Prague (MAC-EMM)*, p. 1-10.
- Kataria, A. et al. (2012), "Employee Engagement and Organizational Effectiveness: The Role of Organizational Citizenship Behavior". *International Journal Of Business Insights & Transformation*, Vol. 6 No. 1, pp. 102-113.
- Kumar, V. and Pansari, A. (2016), "Competitive Advantage Through Engagement. *Journal Of Marketing Research (JMR)*", Vol. 53 No. 4, pp. 497-514.
- Lawrence, J. and Tar, U. (2013), "The use of Grounded Theory Technique as a Practical Tool for Qualitative Data Collection and Analysis", *Electronic Journal of Business Research Methods*, Vol. 11 No. (1), pp. 29-40.
- Levin, E. et al. (2016), "Enhancing client loyalty of advertising agencies: the influence of creativity and inter-firm relationships". *Journal of Contemporary Issues in Business and Government*, Vol. 22 No. 1, pp. 6-22.
- Loury, K. (2015), "How to Deliver Empathetic Service and Gain Client Loyalty". *Journal Of Financial Planning*, Vol 28 No.10, pp. 40-41.
- Markos, S. and Sridevi, M. (2010), "Employee engagement: The key to improving performance". *International Journal of Business and Management*, Vol. 5 No. 12, pp. 89.
- Pugh, S. et al. (2002), "Driving Service Effectiveness through Employee-Customer Linkages". *The Academy of Management Executive*, Vol. 16 No. 4, 73-84.
- Rauyruen, P. and Miller, K. (2007), Relationship quality as a predictor of B2B customer loyalty", *Journal Of Business Research*, Vol. 60 No. 1, pp. 21-31.
- Reichheld, F. F. and Scheffer P. (2016), "The Economics of E-Loyalty", available at <http://hbswk.hbs.edu/archive/1590.html> (accessed 16 March 2017).
- Salanova M. et al. (2005), "Linking Organizational Resources and Work Engagement to Employee Performance and Customer Loyalty: The Mediation of Service Climate. In Yalabik, Z. et al. (Ed.) "Work engagement as a mediator between employee attitudes and outcomes". *International Journal Of Human Resource Management*, Vol. 24 No. 14, pp. 2799-2823.
- Salanova M. and Schaufeli, W. (2008) A Cross-National Study of Work Engagement as a Mediator Between Job Resources and Proactive Behaviour. In Yalabik, Z. et al. (Ed.) "Work engagement as a mediator between employee attitudes and outcomes". *International Journal Of Human Resource Management*, Vol. 24 No. 14, pp. 2799-2823.
- Saxena, M., & Singh, L. B. (2015), "Customer Loyalty Through Employee Engagement: A Conceptual Model". *International Journal of Research in Management & Technology*, Vol. 5 No. 4, p. 289-297.
- Schaufeli, W.B. et al. (2006) The Measurement of Work Engagement With a Short Questionnaire: a Cross-National Study. In Yalabik, Z. et al. (Ed.) "Work engagement as a mediator between employee attitudes and outcomes". *International Journal Of Human Resource Management*, Vol. 24 No. 14, pp. 2799-2823.
- Schaufeli, W.B. et al. (2008), "Workaholicism, burnout and engagement: Three of a kind or three different kinds of employees well-being?" *Applied Psychology: An International Review*, Vol. 57, 173-203.
- Shuck, B., Reio, T. & Rocco, T. (2011), "Employee engagement: an examination of antecedent and outcome variables". *Human Resource Development International*, Vol. 14 No. 4, pp. 427-445.
- Sinai, A. (2013), "Resolving engagement dilemmas". *Human Capital*, pp. (16-20).
- Van Beek, I., Hu, Q., Schaufeli, W., Taris, T. and Schreurs, B. (2012), "For Fun, Love, or Money: What Drives Workaholic, Engaged, and Burned-Out Employees at Work?". *Applied Psychology: An International Review*, Vol. (61) No. (1), pp. 30-55,
- Yalabik, Z. et al. (2013), "Work engagement as a mediator between employee attitudes and outcomes". *International Journal Of Human Resource Management*, Vol. 24 No. 14, pp. 2799-2823.
- Xanthopoulos, D. et al. (2009), "Work Engagement and Financial Returns: Diary Study on the Role of Job and Personal Resources". In Yalabik, Z. et al. (Ed.) *Work engagement as a mediator between employee attitudes and outcomes. International Journal Of Human Resource Management*, Vol 24 No.14, pp. 2799-2823.
- Watson IV, G. et al. (2015), "Building, measuring, and profiting from customer loyalty". *Journal of the Academy of Marketing Science*, Vol. 43 No. 6, pp. 790-825.

## ON THE ROAD TO MEANING: A THINKING JOURNEY TO SPIRITUALITY IN PROFESSIONAL LIFE

Kay, Avi

Jerusalem College of Technology (Lev Academic Center), Jerusalem, Israel

### ABSTRACT

Both research and anecdotal information suggest that there is an increasing interest in spiritual elements of professional activities. While individuals might more often seek out the spiritual via the search for meaning in those activities, they typically lack a clear understanding as to how to achieve that outcome. Thus, the surge in interest in and need for spirituality at work may have debilitating effects on the individual's very sense of spirituality at work. This paper presents a preliminary discussion regarding the possibility of applying a new learning technique, referred to as the "thinking journey," as a means to accomplish that goal. After introducing the technique and its underlying principles, the various characteristics of the technique are described. Following that, an example of a possible "thinking journey" is presented. Finally, possible directions for future applications and research of the "thinking journey" method for the area of spirituality at work are suggested.

*Keywords: spirituality at work, business ethics, pedagogy, management education, thinking journey*

### INTRODUCTION

Howard (2002) suggested that the "explosion" in interest in workplace spirituality was "probably the most significant trend in management since the 1950s" (p. 230). More recent research indicates that the idea of spirituality at the workplace and its individual and organizational benefits continues to surge (Houghton, Neck and Krishnakumar, 2016). One indication of this can be seen in a recent search undertaken by this author on Amazon of the term "spirituality at work" that generated nearly 35,000 results; while a Google Scholar search for the same yielded over 47,000 results - for work done just over the last five years

However, the rising interest in - and felt need for - spirituality at the workplace may be a mixed blessing. For, in lieu of the possession of tools allowing access to possible spiritual elements of one's professional endeavors, many individuals may only experience a *greater* sense of frustration in light of the apparent absence of any perceived spirituality in that endeavor. Indeed, noting both the growth in the desire for spirituality and its typical absence from the curriculum, Astin (2004) cogently

argues that Academia must expend greater efforts to help students develop tools to guide their search for spirituality.

This is not a new thought. For, sources as diverse as the Buddha to Aristotle to the Church Fathers to the conveyers of hadiths in Islam to the ancient Rabbis (or literally "teachers") of the Talmud were all cognizant of the importance of aiding individuals toward their pursuit of "the Good life" in their everyday, professional activities. For example, the Talmud suggests that upon arrival to the gates of Heaven the very *first* question that an individual will be asked will be whether they have conducted their business activities in an honest and forthright manner.

It is unlikely that the purpose of the above passage was to offer the individual time to "cram" and prepare an acceptable answer to that question. Rather, clearly, the idea was to lead the individual to examine their ongoing activities from the perspective of a "judgment day", and to conduct themselves in a manner that will allow them to arrive at their preferred destination. Regardless as to whether that day of reckoning occurs at the "pearly gates," or a random morning while glancing at the mirror while preparing for work, or looking out at the ocean waves, while contemplating a lifetime of activities and decisions; it will be a moment in which the individual will be taken out of the present to evaluate themselves from a different, and perhaps novel, perspective.

But, how can one best be prepared to assess their professional lives and themselves in a different and novel perspective? One educational approach gaining traction in recent years builds upon the idea that learners should be more active agents in constructing the knowledge they seek (Schur and Valnaides, 2005). This more active type of learning builds upon the classic work of Vygotsky who placed much emphasis on the part played by significant people in the learners' lives via the activities of those individuals, who enhance their learning by selecting and shaping, and thus mediating, the learning experiences of the individual (Turuk, 2008).

This method, which has become known as "mediated learning experience" (Feurstein and Feurstein, 1991, Seng, 2003) calls for the active involvement of an outside agent (i.e. teacher, mentor, coach) to actively mold the presentation of information relevant to a matter in question so as to create a new understanding of the dynamics and context of the matter at hand. Feurstein (1991) suggests that such learning allows "for the development of the very unique human conditions of modifiability, or the capacity to benefit from exposure to stimuli in a more generalized way than is usually the case" (Feurstein, 1991, p.26).

One way in which this mediated experience can take place is via a "thought experiment" (or "Gedankenexperiment"). The above is a cognitive tool designed to allow one to consider some hypothesis or principle in order to consider their possible consequences. It should be noted that there may not *necessarily* be any intention - or perhaps even possibility - to undertake actions associated

with the subject of the experiment. Two famous examples of Gedankenexperiments are Schrodinger' cat (in the area of physics) and the "trolley problem" (in the area of ethics).

The purpose of this paper is to suggest the use of utilizing a thought experiment approach in the context of spirituality at the workplace. Specifically, this paper will present and apply an approach called the "thinking journey" (Schur, 1999; Schur, Skuy, Zietsman and Fridjhon, 2002; Schur and Valanides, 2005), a new methodological tool currently gaining interest in science education, to spirituality at the workplace. The "thinking journey" allows the individual to look at their reality in new and novel ways. It is suggested here that the "thinking journey" can assist individuals to identify - if not actually experience - a variety of perspectives on their professional life that will aid them to identify possible elements of spirituality inherent in that endeavor.

## **THE THINKING JOURNEY: AN INTRODUCTION**

A prism can offer the individual the possibility to see the various hidden colors that comprise the colorless "white light" that surrounds us. It is suggested here that an individual would do well to seek out a prism through which it might become possible to perceive the various "colors" which make up everyday professional life. The "thinking journey" can serve as that prism.

Schur and Valanides (2005) note that the purpose of the "thinking journey" (heretofore referred to as "TJ") is to allow the learner to experience the learning process in an active and personally significant manner while gaining perspective(s) they did not previously have regarding the matter at hand. For example, the TJ allows individuals to overcome problems of egocentricity in science education (seeing things only from one - their own - perspective) via a mediated journey to faraway places where they have to orient themselves. Along the journey, the individual experiences and assumes multiple perspectives of the subject at hand and the context in which they operate. As such, they gain knowledge both with regard to their own nature and that of the context in which they operate.

Specifically, the TJ is comprised of a set of learning activities that lead the individual to undertake an imaginary journey in order to gain new, novel and sometimes surprising perspectives on both new and "known" phenomenon. In an educational context the instructor may serve as the "tour guide" for that journey, in an organizational setting someone from HR, a coach or mentor may fill that position. In all cases, the "tour guide" sets out an itinerary that necessitates the learner to challenge what is known and possible sources of that knowledge.

With that, individuals ultimately "own" the experience. For, it is the learner who decides what the journey means to them. They are encouraged to ask questions, make comments and build a personal representation of the places visited, as well as, perspectives achieved. In order to free

learners from their own personal perspective, each station on the itinerary is represented via visual representations such as drawings, photographs and video clips through which (and - often - in which) learners are encouraged to view themselves.

## THE THINKING JOURNEY: FEATURES AND FUNCTIONS

As noted, the TJ helps individuals overcome problems of egocentricity (seeing things only from their perspective) via a mediated journey to faraway places where they have to orient themselves. As such, it is built upon the premise that the ancient Greek maxim to "know thyself" can best occur if one knows one's world. Thus, the TJ is comprised of a number of features that combine together to provide a type of "out of body" experience which allows - or even necessitates - the individual to view themselves and their reality in a new manner. Following here is a short description of features of TJ pertinent to the area of spirituality at work.

The first feature of the TJ is the "**Dialogue**" - the communication that occurs at each point along the TJ between the guide and the traveler. That communication is comprised of a verbal and/or written exchange ideas and queries. The latter examining the nature of the place visited and the possible viewpoints, feelings and attitudes of those who inhabit a particular space in the constellation in which the individual operates. Via the process above the individual gradually constructs a new understanding of the place visited and the meaning of that place in their own life and endeavors.

The second feature of the TJ framework are "**Pictures**." TJ makes extensive use of visual representations as a means to allow the individual to experience and consider their world in a different manner. These representations allow the learner to view the, as of yet unknown viewpoint, that may be inaccessible or perhaps even invisible to them. It also allows for a consideration of phenomenon for which the learner may - as of yet- not possess the language to express.

The next feature of the TJ approach is "**Observation**." The interactions between guide and learner occur during the observation of visual images presented. Here, the communication is more directed and focused on non-verbal representations of the TJ. Along the TJ the traveler is asked "what do you see in the picture?" As such, it encourages the traveler to reflect upon, comment, question and even doubt their own reality. They may also be asked to consider changes to a visual representation, in order to align it with the other, and often new and personally significant perspectives. Throughout the TJ, the guide offers additional information and questions to further hone the travelers' ability to understand what is (and is not) being perceived.

"**Comparison**" is, yet, another important feature of the TJ. It is characterized by encouragement offered the traveler to compare what had been previously "known", with new information available. The above may challenge, complement and/or alter the "known." The guide

utilizes the comparison and contrast between previous knowledge about their endeavors and newly available information to encourage the traveler to offer possible new understandings of the former. Further, individuals are challenged to consider what their new understanding may say about the manner in which they view themselves, their world and their place and relationship with the world around them.

Finally, the last relevant aspect of TJ for the issue at hand is "**Returning Home.**" This matter refers to taking the individual back to their current reality. The traveler is asked to compare the features of the place in which "they live" with the variety of other places visited. As such, they gain a new understanding of the panorama afforded by their current reality and the relativity of that reality. The traveler is encouraged to review the stations visited, the view afforded by each and to again consider what they gained by visiting the various stations.

## **THE THINKING JOURNEY: A POSSIBLE APPLICATION IN SEARCH OF SPIRITUALITY AT WORK**

Following is an example of a TJ that can be undertaken with an individual searching for greater meaning in their professional life. The itinerary for this journey will be set by means of the guide questioning the traveler with regard to the nature of the individual's professional life. The "journey" will start from within, and will include engaging the individual with regard to how and why they arrived at their current endeavor, and how the above may have evolved over time. Following the above, the individual will be asked to describe the immediate outputs and consequences known to them that result from their current endeavor.

After the initial look at the position the individual holds, the focus is shifted toward the consideration of the constellation of actors with whom the individual may interact and/or affect via their endeavors. Here an important element in this process is understanding the various "stakeholders" (Freeman, 1994) affected by or otherwise important to the performance of the individual's professional responsibilities.

The "typical" stakeholders considered when speaking of professional activities (i.e. customers, employees, colleagues, community, competitors etc.), are supplemented by new and different "stakeholders" that is relevant - if not crucial - when searching for personal meaning. In such a context, these additional "stakeholders" can be a particular religious or ideological perspective to which the individual feels committed, the initial vision the individual may have had of their professional life and goals, the hopes and goals they hold with regard to their ultimate professional status and achievement and the legacy they might wish to leave behind (Wade-Benzoni, Sondak and Galinsky, 2010).

Within the context of this TJ, the traveler is sent both on a journey in space and in time. At each station, they are presented with written and/or visual representations that are meant to serve as stimuli evoking responses allowing insight into how their current professional life; activities, challenges, opportunities, decisions and "products" are viewed by variety of possible "stakeholders" in their lives.

## A POSSIBLE TJ

Following is a possible itinerary for the TJ above. It includes a number of possible stations along the way along with a possible script for those stations.

The first station on the journey would be to "visit" customers. Here the guide might present a picture of a group of individuals and say, "Look at the picture of these individuals. They are actually customers who use the product (or service) which you help produce."

- What do they want or expect from that product?
- What role does that product play in their lives?
- What role do you play in realizing the above?
- How do they speak of the product?
- How might you speak about it?
- Is there anything you would like to know about them? Is there anything you might want to ask them?
- Is there anything that you might want to tell them about the product, your part in it or your hopes for it?"

The guide might then ask the individual to suggest changes in the picture and/or supply other images to describe the possible meaning their endeavors have for others (including pictures they create via photography, photomontage, drawing or use of existing photographs, paintings or other images). Finally, the guide can ask the individual to write a postcard (or perhaps, in 2017 - an email) home to themselves about what their endeavor may look like from the customer's viewpoint.

Another station on the journey can be to the individual as a professional novice. Here the guide presents a picture of individual at different ages prior to and on the threshold of their entrance to the professional world, asking:

- "What does the individual in the picture expect of you and your professional being?"



- "What does that individual think of your current professional being? Why?"
- "Can you compare and contrast yourself today with the individual in the picture? What things related to your current professional being are unknown to that individual? Is there something that you might want to share with that individual?"
- How might you close any gap between the perceptions of that earlier self and yourself today?

Yet another stop on the journey would lead the individual to confront religious or ideological beliefs that they might hold. Here the guide might ask the traveler to create or source a drawing that represents some religious or ideological belief they hold, asking:

- Can you describe how the drawing relates to the relationship between your current professional being and the expectations of the religious or ideological "truth" to which you aspire?
- What items or elements appear in that drawing? Why?
- Where are you meeting the expectations of that "truth"? What must you do to move closer to that "truth"?
- What is literally or figuratively "missing from the picture" that might lead to a greater sense of meaning at work.

## CONCLUSION

At the outset of this paper the author noted the tremendous interest in and need felt by many for a greater sense of spirituality at the workplace. But, it seems logical (and evident) that spirituality just doesn't "happen." By that, it seems clear that one must most likely "seek out" spirituality. It is suggested here that a TJ can help the individual discover and/or facilitate possible elements of their current professional endeavors that may lead to a greater sense of meaning and spirituality at the workplace.

The TJ encourages the individual to be proactive in seeking out different ways to view their current reality. By "visiting" the stations along the TJ, the individual may gain new cognitive tools and another "language" through which they can understand themselves and their experiences. Salkin (1994) has suggested that one of the impediments faced by many individuals seeking spirituality in their professional lives is the lack of an appropriate lexicon by which to describe and compare their various personal, spiritual and professional activities and expectations.

Only a preliminary examination of the TJ and its possible role in augmenting spirituality at the workplace was presented here. With that, it seems that the TJ has the potential to help advance the understanding of - and training in - the area of workplace spirituality. Importantly, it offers a new and novel approach to understanding and enhancing spirituality at the workplace via the application of a tool that has been successful in science education to both broaden the individual's self-understanding and an understanding of the world in which they operate. Equally important, the proposed method calls upon the active engagement of the individual in a process. It, thus, may likely lead the individual to take ownership over their path to gaining a sense of meaning in their endeavors and the concomitant sense of spirituality at the workplace that might emerge in wake of the above.

## REFERENCES

- Astin, A. W. (2004), "Why spirituality deserves a central place in liberal education", *Liberal education*, 90 No.2, pp. 34-41.
- Feuerstein, R. (1991), "Cultural difference and cultural deprivation", In N. Bleichrodt and P. Drench (Eds.), *Contemporary issues in cross-cultural psychology* (pp.21-33). Swets and Zeitlinger, Amsterdam.
- Feuerstein, R. & Feuerstein, S. (1991), "Mediated learning experience: A theoretical review", in R. Feuerstein, P. S. Klein and A. J. Tannenbaum (Eds.), *Mediated learning experience: Theoretical, psychosocial and learning implications*, Freund. London.
- Freeman, R. (1994), "The politics of stakeholder theory: Some future directions", *Business Ethics Quarterly*, 4, pp. 409-422.
- Houghton, J. D., Neck, C. P., & Krishnakumar, S. (2016), "The what, why, and how of spirituality in the workplace revisited: a 14-year update and extension", *Journal of Management, Spirituality & Religion*, Vol. 13 No. 3, pp. 177-205
- Howard, S. (2002), A spiritual perspective on learning in the workplace. *Journal of Managerial Psychology*, Vol. 17 No. 3, pp. 230-242.
- Jones, K. (2013), *Diving for Pearls: A thinking journey with Hannah Arendt*, Thinking Women Books, New York. .
- Salkin, J. (1994), *Being God's partner: How to find the hidden link between spirituality and your work*. Jewish Lights Publishing, Woodstock, VT.
- Schur, Y. (1999). *Constructivism and mediated learning experience as a basis for a process of conceptual change in students' concept of earth*, Unpublished Ph.D. thesis, University of Witwatersrand, Johannesburg, South Africa.
- Schur, Y., Skuy, M., Fridjhon, P., and Zietsman, A. (2002), "A thinking journey based on constructivism and mediated learning experience as a vehicle for teaching science to low functioning students and enhancing their cognitive skills", *School Psychology International*, Vol. 23No. 1, pp. 36-67.
- Schur, Y. and Vlanides, N. (2005), "Dynamic learning and perceptual changes." in D. Koliopoulos and A. Vavourali (Eds.), *Science Education and the Crossroads: Meeting the Challenges of the 21st Century*, EDIFE, Athens, pp. 121-134.
- Seng, T.O. (2003), *Mediated learning and pedagogy: Applications of Feuerstein's theory in twenty-first century education*, National Institute of Education, Singapore.
- Turuk, M.C. (2008), "The Relevance and implications of Vygotsky's sociocultural theory in the second language classroom", *ARECLS VOL. 5*, pp. 244-262.
- Vygotsky, L. (1978), *Mind in society*. Harvard University Press, Cambridge, MA.
- Wade-Benzoni, K., Sondak, H. and Galinsky, A. (2010), "Leaving a legacy", *Business Ethics Quarterly*, Vol. 20, No. 1, pp. 7-34.

## POSITIVE AND NEGATIVE ASPECTS OF MANAGER POLITICAL BEHAVIOUR IN THE PUBLIC SECTOR ORGANIZATIONS

Kidron, Aviv<sup>1</sup>; Vinarski –Peretz, Hedva<sup>2</sup>

<sup>1</sup>Human Services Department, The Max Stern Yezreel Valley College, Israel

<sup>2</sup>Department of Political Science and Department of Health System Management, The Max Stern Yezreel Valley College, Israel

### ABSTRACT

*"In describing the processes of organizations as political acts, we are not making a moral judgment; we simply are making an observation about a process."*

*Bacharach and*

*Lawler, 1980, 2*

The study is aimed to advance further understanding of manager's political behavior which is the practical domain of power in action within the workplace, and to investigate the positive-beneficial dimensions of political behaviour, rather than its destructive aspects. Using qualitative research methodology we conduct individual in-depth interviews with 12 senior managers (6 women and 6 men) across 12 public sector organizations. The interviews were analysed using two key themes – (a) understanding the positive and negative view of organizational politics, and (b) manager's engagement in political behaviour in the workplace as part of their subjective social-professional experience. The findings have shown that managers adopt and implement the rules of the political game extensively. The roots of political behaviour consists personal ambition to enhance career and self-interest goals, as well as specific organizational goals. Managers engagement in positive political behaviors through the use of tactics and techniques of influence aimed at achieving vary of goals (i.e. accomplish their work, foster legitimate management actions, support their followers, cope with internal conflict and maintain social and professional interactions).

Practitioners and leaders can use our findings first, to understand the ambivalence of political behaviours spectrum ranging from worthwhile-desirable to unwanted-harmful outcomes. Particularly, to distinguish whether perceptions of positive – beneficial political behaviour have a benefit but the ethical behaviour is not doubtful. Second, recognize when to intervene, how or if at all. Managers reasoning, interests and motivations to engage in political behaviour discussed.

*Keywords: manager's political behaviours, perceptions of organizational politics, positive politics, public sector organization, qualitative research*

## INTRODUCTION

Politics in organization is simply a fact of organizational life (Ferris and Kacmer, 1992; Mintzberg, 1983) that remained inextricably intertwined construct for decades (Ferris and Treadway, 2012) and ubiquitous in organizational analysis. Despite repeated calls to eliminate or eradicate it, political behaviour remains an integral part of organization (Ellen, 2014). In this regard, political behaviour like other behaviours, can have dual effect – benefits and cost (Buchanan and Badham, 2008) and simultaneously have the coexistence of positive and negative-constructive outcomes toward the same individuals or organization (Hochwarter, 2012; Kapoutsis and Thanos, 2016). Building on recent studies that advocate positive benefits of political activity in the workplace and have offered more balanced view of that behavior (Buchanan and Badham, 2008; Fedor *et al.*, 2008; Gotsis and Kortezi, 2010; Hochwarter, 2012; Landells and Albrecht, 2015), our goal is to examine *the positive and negative roots of manager's* engagement in political behaviour within public sector organizations.

Although, scholars have discussed organizational politics for more than three decades (Ellen *et al.*, 1979; Ferris *et al.*, 2002; Hill *et al.*, 2016; Pfeffer 2010; Riley, 1983; Rosen and Hochwarter 2014; Drory and Vigoda-Gadot 2010) and its pervasiveness makes it an important area for organizational researchers (Riley, 1983), significantly, vast body of the study emphasize the negative aspects while focused on the undesirable causes and outcomes (i.e. Chang *et al.*, 2009; Ferris *et al.*, 2002). This tendency has led a prevailing negative conceptualization and measurement of organizational politics (Landells<sup>1</sup> and Albrecht, 2016). Hence, many times, the political category consist behaviour or activities that are illegitimate, harmful to the organization or its members or based in self-interest (Rosen *et al.*, 2009). In other words, politics within the walls of organization described as stepbrother and troublesome effect of others organizational phenomena.

Conceptually, in the literature "far more attention has been given to the self-serving effects of influential others' political behavior than to the effects political behavior has on other employees." (Ellen, 2014, 893). These self-serving effects has investigated as generator of low performance, low job satisfaction, loss of commitment, withdrawal (Buchanan and Badham, 2008) as well as employee turnover, absenteeism, and job stress (Chang *et al.*, 2009; Ferris *et al.*, 2002). Moreover this bias has led scholars and managers alike to avoid the debate on the potentially functional and positive aspects for that significance intangible – invisible phenomenon even when they all recognize its real existence as generic component the organizational social fabric.

A complementary approach researchers have suggested, more recently, attempt to consider the potentially functional and positive aspects of organizational politics but without neglecting its toxic effects (Drory and Vigoda-Gadot 2010; Fedor and Maslyn 2002; Gotsis and Kortezi 2010; Hochwarter 2012; Liu, *et al.*, 2010) and to gain more comprehensive glance into organizational politics and its behavioral derivatives (Ferris and Treadway, 2012; Thanos, *et al.*, 2016). For example, research discuss the meaning of political skills that employees need to possess in order to cope with the political environments (see Kapoutsis *et al.*, 2016; Chang *et al.*, 2012), examine various political behaviour individual display in the workplace such as impression management, voice and even helping behaviour, while attempt to secure favorable outcomes and thriving in the workplace (Kimura, 2015). Other have found that political behaviour related to higher productivity, career advancement, higher innovation, and decision making consensus (Fedor *et al.*, 2008; Gotsis and Kortezi, 2010; Hochwarter, 2012; Kurchner-Hawkins and Miller, 2006).

The premise for this study is that organization are cooperative systems of employees working together to achieve purposes as well as political arenas of individuals and group holding various interests (Brass, 2002). As Buchanan (2008, 57) noted: "most managers, if they want to succeed, have to play politics at least part of the time." Thus, based on previous studies investigated the positive-beneficial dimensions of political behaviour, rather than its destructive aspects, we ask to (a) understanding the positive and negative view of organizational politics, and (b) explain manager's engagement in political behaviour in the workplace as part of their subjective social-professional experience.

Considerin g the positive possibilities of leader  
political behavior

#### B. PARKER ELLEN III

Our research contributes to organizational politics literature in three principal ways. First, there is significant gap in the organizational politics literature since very little empirical research has explored how organizational members actually view organizational politics (Landells and Albrecht, 2015, 44). Examining pieces of manager's political nature and behaviors enrich that theoretical discussion. Respectively, Hochwarter (2012, 51) have suggested; "As a logical step in development, scholars may find value in looking beyond the *how* (i.e., tactics) and *what* of positive politics (i.e., outcomes) by committing greater attention to the *why* (i.e., motives, value, objectives)". Second, we respond to a contemporary organizational science scholar's call to develop a more balanced understanding of organizational politics and mainly to recognize the dual effect of political behavior regard its positive and negative effect at work (Kapoutsis and Thanos, 2016). Consistent to Ellen (2014) noted that "from a theoretical standpoint, more specification is needed. Construct

measurement and empirical testing of the concept will require additional description of the types of positive behaviour." (p. 895). Third, while qualitative research regarding organizational politics remains relatively rare (McFarland *et al.*, 2012) and commonly discuss the negative 'dark side' of organizational politics or dysfunctional aspects of political behaviour (Chang *et al.*, 2009; Ferris *et al.*, 2002; Rosen *et al.*, 2009), our research use qualitative research method suggests more in-depth and comprehensive understanding of manager's positive political behaviour. New qualitative work will contribute to the field (Ferris and Treadway 2012) provide greater contextual information, and "lead to new insights that may not be recognized in existing theoretical work" (McFarland *et al.*, 2012, p.116).

The paper is organized as follows: We present the theoretical literature on individual engagement in political behaviours. We describe the methodology and data collection used of the qualitative procedures. Finally, we analyze our findings and their practical implications.

important area for organizational researchers.

The reality

is that politics are "a principal component of a firm's social context" (Hochwarter, 2012, p. 31).

he reality

is that politics are "a principal component of a firm's social context" (Hochwarter, 2012, p. 31).

The reality

is that politics are "a principal component of a firm's social context" (Hochwarter, 2012, p. 31).

## **THEORETICAL BACKGROUND**

The two side of engagement in political behaviour

Drew on the Aristotle philosophical idea, we are by nature political animals. Participation in political behaviour is characteristic of one's DNA (Cheng *et al.*, 2010). Political behaviour in the organizational setting display both positive and negative implication to the observer, to recipients or victims (Buchanan and Badham, 2008). However, primarily, in the organizational politics literature, such political behaviour 'has been cast in a largely pejorative light, with research focusing on its pervasiveness' (Hochwarter, 2012, 27) and, as a results, neglect and scarcely support for investigating the positive side of politics is recognizes in science (Fedor *et al.*, 2008) and practice (Pfeffer 2010). Following, we discuss the two faces of political behaviour and review the recent support in the literature for the consideration of positive politics.

Forman's classical definition (1962) describes political behaviour in an organization as behaviour that is not required as part of an assigned task, but has an influencing role, or tries to gain an advantage. That implicitly of the bad-side of political behavior (Vredenburg and Shea-Van fossen,

2010) classify organizational politics perceptions as a hindrance stressor (Chang, *et al.*, 2009) and causing strain reactions (Rosen *et al.*, 2009). Respectively, another definition describe political behaviour, as a “‘self-serving’ behavior that is not sanctioned by the organization and that likely produces conflict and disharmony by pitting individuals and/or groups against one another or the organization” (Gilmore *et al.*, 1996, p. 482). Also, studies have investigated it as behaviors that should be avoided in the workplace and include assertive/aggressive self-serving tactics and self-promotion that can produce negative results (Ferris and Kacmar, 1992). In their book, Buchanan and Badham (2008) noted five defining features of political behaviour in organizations: influence, self-interest, damage, backstage, and conflict. Behaviour that demonstrates those five features is categorically political (Drory and Room, 1990; Ferris *et al.*, 2002) and namely viewed as manipulative and purely self serving. Influence refers to getting others to do or think in accordance with your intention and enhancing one's power to influence. Self-interest refers to the achievement of individuals' personal goals rather than organizational goals. Damage explains behaviours that are inconsistent with the organization's goals wherein individuals act in unfavorable ways and ignoring the organizational effectiveness. Backstage refers to unformal arrangement and deals that employees organized that excludes other people in the organization. Finally, conflict is controversy among employees regard resources allocation, decision making or strategies to achieve organizational goals (Buchanan and Badham, 2008, 12).

Alongside the undesirable aspects of political behaviour, objectively its refers to a wide range of practices that help the individual to get ahead or to exploit resources in the workplace (Dubrin, 2009) and display influence tactics used strategically to meet one's goals, and include informal activities aimed at promoting self-interest by influencing the thinking, perceptions, or behaviour of others (Hill *et al.*, 2016). Such behaviours are not exclusively destructive influences for all individuals. We argue that, practically, through political activities that connect people under collective idea, needs or goal for the benefit of the organization, individual may gain advantage regard their aims, but, its not necessarily be contrary to the organizational goals or the wishes of their colleagues.

More recently studies and multidisciplinary approach (Fedor *et al.*, 2008; Hochwarter, 2012; Kapoutsis and Thanos, 2016) have called to consider the dichotomous meaning of organizational politics without ignoring its negative effects. That classic definition has been expanded by researchers asking to investigate the positive individual subjective experiences during participation in organisational politics in the workplace (Dubrin, 2009; Fedor *et al.*, 2008; Gotsis and Kortezi, 2010). The idea that organizational politics creates 'dual effect' and can be both functional and dysfunctional in individual and organizational terms (Buchanan and Badham, 2008), has become an interest for researchers who attempt to explore, first, the destructive and positive elements that are potentially

constructive and, second, when and where it is a useful tool at the organizational level (Ferris *et al.*, 2007). This glance focuses on distinguish political activity and perceptions that favourably impact individual, group and organization (Buchanan, 2008; Dubrin, 2009). From that perspective, political behaviours definition encompasses both self-serving and benevolent motives in employees'/managers' attempts to achieve personal and/or organizational goals (Kapoutsis and Thanos, 2016). Political behaviour refers to "intentional acts from a broad repertoire that may include influence tactics, self-presentation, impression management, voice and helping behavior to manage (create, maintain, modify or abandon) the shared meanings of organizational situations so as to produce desired outcomes that would otherwise be unfeasible" (Kapoutsis, 2016, p. 41). Relatedly, studies have found a positive connection between political behaviours included ingratiation, upward appeals, blocking and sanctions, achieving employee outcomes (i.e. promotion, salary and performance appraisal) (Higgins, *et al.*, 2003) and attaining objective and subjective career success (Kapoutsis, Papalexandris *et al.*, 2012). Others have indicated that leader political behaviour favorably influences subordinate outcomes such as satisfaction, mood and citizenship (Ellen, 2014; Kane-Frieder, *et al.*, 2014). Recently, study conduct an exploratory interviews with organizational leaders have indicated "political behavior is crucial for leaders to provide followers with support... leaders recognize the political realities of their organizational environments and thus routinely participate in politics to provide their followers with performance-facilitating and career-enhancing opportunities" (Ellen, 2014, 894).

Consistent with previous research argue for considering political activity as a principle component of firm's social context (Hochwarter, 2012) and drew on scholars that have argued for the positive impact of organizational politics (Liu *et al.*, 2010), we argue that employees are engage in political environment and behaviours both to foster their career and to know how to socially act in the workplace. Individuals are motivated to engage in political behaviours only when they believe that doing so helps them achieve valued organizational experience (Liu *et al.*, 2010; Mintzberg, 1983; Treadway *et al.*, 2005). By learning the unwritten rules of the political game, employee recognize and understand the centrality of that phenomenon and how is crucial for them as well for the organization goals. Hence, in the organizational sphere, 'such purposive behaviors, which may range from active to passive engagement, create a context within which employees and managers operate to attain their goals' (Kapoutsis and Thanos, 2016, 310).

Consist with Ellen (2014) that have suggested "although some may argue that leaders' political behavior on behalf of followers simply is an extension of self-interest, it is possible, if not likely, that these self-interests and collective interests are not mutually exclusive" (P. 894), we argue that display techniques of influence of tactics in the organizational setting is not harmful constantly and managers can and do behave politically in efforts to foster organizational goals, benefits their followers as well



gain self advantage. Further, the main research question directed to understand - how managers in the Local Authorities explain the meaning of positive and negative political behaviour?

## **METHOD**

### **Sample**

We used theoretical sampling, which refers to a selection method of participants who are deemed to be “particularly suitable for illuminating and extending relationships and logic among constructs” (Eisenhardt and Graebner, 2007, p. 27). According to Creswell (2014), individuals from the initial quantitative sample should be selected for the qualitative follow-up sample. Hence, we conducted semi-structured, face-to-face interviews with 12 managers (6 women and 6 men) from the local and regional councils in Israel.

### **Data analysis**

All interviews were recorded and transcribed for clear identification of the codes. Coding the interviews was carried out according to Miles and Huberman’s (1994) procedure: We began by deriving themes extracted from the literature and applying them to the interviews, as relevant. We continued identifying and assigning more themes and subthemes to the interviews as they emerged while reading them. Second, we reorganized the data according to the codes in order to confirm that all the segments with the same code had the same meaning. Third, the codes were named and operationally defined so that their meanings would be clear and would correspond with the conceptual framework. Finally, we grouped the codes into more meaningful units of analysis, especially according to the model variables. We will present and interpret these findings in order to expand on the quantitative results (Creswell, 2014).

## **RESULTS**

Interviewees described the various aspects of organizational politics, and especially political behaviour. The interviews' analysis reveal three key themes: organizational goals, personal interests versus corporate interests, and organizational career that motivated the political behaviour. The descriptions of these themes moving the range of positive to the negative political behaviour.

### **Organizational goals:**

Agreement on the goals of the organization and a willingness to pursue these goals is a source of organizational politics. Those who agree with the goals of the municipality or the council will

cooperate and promote its achievement. Conversely, those who oppose the stated goals shall inaction or actively compete against achieving them. The following citations illustrate the two sides of the coin:

"Those who identify with the mayor and his party, trust in them is higher, and they will get more out of the system. If he asks for some social services project, they will do the maximum from political motives and commitment. It goes together. In addition, if the opposite occurs [if you do not identify with the mayor and his party], then you will be less involved. I saw that in the last election. Those that identified with the right (the mayor's from a rightist party), were more 'small minded.' There's a lack of trust on the opposition side" (9)

"My trust in my co-workers is very high, even when it comes to political internal rivals. Ultimately, if we look at everyone in the organization, we have a common goal. Although, everyone chooses a different way to achieve the goals" (4)

Personal interests versus corporate interests:

Political behavior can be used as leverage to promote interests. On the scales are personal interests on the one hand and organizational interests on the other hand. While promoting corporate interests perceived positively as an activity conducive public domain, promoting personal interests perceived negatively as an individual benefit at the expense of the organization as a whole. The following citations illustrate the two sides of the coin:

"My approach is that if the system works, even if there are structural defects, they are subject to change. Trust in the existing system allows me to act in directions that I want, or put pressure places where I can renew, change and do. Similarly, if I want to change politically, to intervene, to speak and to decide otherwise" (5)

"Some people pointing on political people, but they themselves are engaged in politics. If people are engaged in political activity extremely ... and take advantage of the time to promote personal political interests, it is perceived as negative and irresponsible in terms of filling the job at work" (12)

Organizational career:

One of ambitions of many managers is to advance to senior positions during their career. Political behavior is one of the main means to achieve this goal. As opportunities for advancement decreases as

one goes in the organizational hierarchy, the competition has grown. Different political behaviors are not perceived as legitimate by all. The following citation illustrates the two sides of the coin:

"I am always striving for more. I want to advance. I love roles with responsibility...Everyone in the municipality wants to advance. You can advance, if you have vitamin P. If you do not, you can go to million tenders and you will not get the job. Promoting competition will cause mistrust. If there are two candidates, one dirty up the second. There are who compete for a position and still remain friends" (7)

## DISCUSSION

The study is part of a new stream of qualitative studies on political behavior. Therefore, the qualitative research method enables to describe, analyze and interpret political behavior and expose the differences between positive to negative politics. Building on recent studies that advocate positive benefits of political activity in the workplace and have offered balanced view of that behavior (Buchanan and Badham, 2008; Fedor *et al.*, 2008; Gotsis and Kortezi, 2010; Hochwarter, 2012; Landells and Albrecht, 2015), the main concern of this study was to address the question - how managers in the Local Authorities explain the meaning of positive and negative political behaviour? The main themes we presented and analysed simultaneously reveal political behaviours, both positive and negative. These themes reinforce the assumption that political behaviours can alternately be perceived as contributing or harming the organization and its employees. The interviews reveal that employees' political perceptions are likely to play a key role in their attempt, effort and actions to promote both personal, team and organizational processes as well for maintain social foundations. These findings strengthen previous argument that perception of positive and negative politics would be separate dimensions of political behavior (Fedor *et al.*, 2008). One of the characteristics of political behaviour, whether positive or negative, is the attempt to gain any advantage. The interviewees examine that managers are motivated to engage in political behavior not only as part of self-service concern and they utilize their political resources, professional skills or status to empower and promote collective interests at the team or organizational level. Based on Ellen (2014), we conclude that these self-interests and collective interests are not mutually exclusive. In this respect, political behavior will be perceived as positive or negative according to the motives that leading this behavior. In general, if the behavior is intended to promote or support organizational interests, such as the organizational goals or decisions, it may be perceived as positive behavior. Behavior may deviate from the organizational norms but yield positive organizational results (Warren, 2003).

In sum, the findings of this study contradict the Mintzberg's approach that political behavior is dysfunctional (1983). From this perspective, what may make political behavior positive is the extent

to which those behaviors are seen as legitimate or consistent with the organizational goals or effectiveness (Fedor *et al.*, 2008). However, when the focal point is achieving personal goals or protecting personal interests that accompanied by unethical behavior, disproportionate and offensive strategies, the behavior will be perceived as negative.

## PRACTICAL IMPLICATION

*"Just because you do not take an interest in politics doesn't mean politics won't take an interest in you."*

*(Pericles)*

Our study has implications for organizational leaders and managers. Two major keys and important insights that can be applied are (a) that most useful intervention is not to try to eliminate organizational politics and (b) that mapping and studying its bilateral attributes (nice and the nasty) in the workgroup context, is inevitable. Broadly, the findings suggest that political behaviour is the practical domain of power and influence in action, becoming more sophisticated through the use of tactics, strategies or techniques of influence. The roots of political behaviour lie in personal ambitions, but there are likely to be differences among individual's engagement in such behaviour regard their intention, funs, needs and positions.

Through the complementary lens of organizational politics, we have recognized the ambivalence characteristics of political behaviour included both negative and positive aspects, thus, managers must have the ability to isolate harmful aspects while they are using political means. Leaders and managers could estimate the extent to which the political means implemented in their organizations are nourishing negative circuits and to eradicate it publicly, clarify and deter. Understanding the limits and types of politics accepted in their workplace is critical. To that end, they should have a clear view of themselves, promoting honest self-reflection and self regulation, must behave with consistency and high level of transparency as managerial example hold political power. Mainly, they must hold themselves to a high ethical standard. Practically, they should allow the use of politics in their workgroup, as part of a natural human behaviour that it can not be avoided, but not as a corrupting means. For example, their positive political behavior included tactics and strategies that can complement legitimate management actions or potentially can help them to embrace their followers in the workplace. Moreover, in order to reduce the dysfunctional possibilities of political behaviours they must have a solid vision of the culture they want to cultivate, the boundaries and reasonable of the use of politics in their workgroup.

From managerial perspective, most managers, if they want to remain, withstand, undamaged and mainly to succeed, have to play politics at least part of the time. Thus, there is a need to be able to exercise and implement personal influence or power rather than rely on professional status or the

authority of management position in the workplace. In intricate circumstances where conflicts and dispute are substantial part of the organizational reality, managers need to demonstrate other strategies, tactics and actions to remove such blockages rather than to act due to their official status or rank.

Finally, the puritan perspective on politics that employees should not get involved at any level since it include 'dirty tricks', unethical actions and is occur in the province of con artists, will be considered as mishandle. Attempting to work against it, or worse, to ignoring it, achieved the opposite outcome - strengthen the negative perception regard political behaviour as self serving value that has harmful and destructive at the organization level. As argued previously, organizations are cooperative systems of employees working together to achieve goals as well as political arenas of individuals holding various interests. One valuable insight is that while the political dynamics vary from one organization to another, from one skilful player to another, leaders and managers awareness and perspective is necessary to recognize when to intervene, how or if at all.

## **RESEARCH LIMITATION**

As with any empirical study, the current study has some limitations. First, the study is based on respondents only from local government. You cannot ignore the structural and organizational characteristics that distinguish these organizations, and may influence organizational politics. For example, by virtue of their function, various government organizations have an impact on local government, and we have to consider the link between the national and local level. Second, the sample includes only 12 respondents. Although qualitative studies usually are based on small samples, yet we must be careful in drawing conclusions. Finally, organizational politics is one of the sensitive issues researching. Although the interviews were comprehensive, we hope that the interviewees answered the questions honestly and that the research does not 'suffer' from social desirability.

## **FUTURE RESEARCH**

Following the strengths and weaknesses of this study, we will offer a number of recommendations for future studies. First, qualitative studies are needed to further expose other aspects of political behavior, both positive and negative. So far, studies have mainly focused on the reasons of political behavior. In order to assess the differences between positive and negative political behavior, it is advisable to examine whether there are different behaviors under each of the dimensions. Second, studies in various sectors, public or private, may expand the knowledge on political behavior and expose a wider range of behaviors specific to each sector. Finally, without a

doubt, qualitative studies may serve as a fertile ground for establishing valid and reliable research measurement for positive political behavior.

## REFERENCES

effects of that create division, we have failed to gain a comprehensive understanding of the phenomenon. Specifically, we have not considered how leaders engage in political behaviors to benefit followers. I hope the leader

political support construct can provide an avenue for this interesting and under-researched area.

Author biography

B. Parker Ellen III is a doctoral candidate at Florida State University. His research focuses on leadership and organizational politics and has been published in *The Leadership Quarterly*, *Career Development International*, and several research volumes. Prior to returning for his PhD, Parker was an executive in the consulting engineering industry.

References

- Allen, R., Madison, D., Porter, L., Renwick, P., & Mayes, B. (1979). Organizational politics: Tactics and characteristics of its actors. *California Management Review*, 22, 77–83.
- Allen, R.W., Madison, D.L., Porter, L.W., Renwick, P.A. and Mayes, B.T., 1979. Organizational politics: Tactics and characteristics of its actors. *California management review*, 22(1), p.77.
- Buchanan, D.A., 2008. You stab my back, I'll stab yours: Management experience and perceptions of organization political behaviour. *British Journal of Management*, 19(1), pp.49-64.
- Brass, D.J., 2002. Intraorganizational power and dependence. *The Blackwell companion to organizations*, 10, pp.138-157.
- Buchanan, D. and Badham, R., 2008. *Power, politics, and organizational change: Winning the turf game*. Sage.
- Chang, C.H., Rosen, C.C. and Levy, P.E., 2009. The relationship between perceptions of organizational politics and employee attitudes, strain, and behavior: A meta-analytic examination. *Academy of Management Journal*, 52(4), pp.779-801.
- Chang, C.H., Rosen, C.C., Siemieniec, G.M. and Johnson, R.E., 2012. Perceptions of organizational politics and employee citizenship behaviors: Conscientiousness and self-monitoring as moderators. *Journal of Business and Psychology*, 27(4), pp.395-406.
- Cheng, J.T., Tracy, J.L. and Henrich, J., 2010. Pride, personality, and the evolutionary foundations of human social status. *Evolution and Human Behavior*, 31(5), pp.334-347.
- Creswell, J.W., 2014. *A concise introduction to mixed methods research*. Sage Publications.
- Drory, A. and Romm, T., 1990. The definition of organizational politics: A review. *Human relations*, 43(11), pp.1133-1154.
- Drory, A. and Vigoda-Gadot, E., 2010. Organizational politics and human resource management: A typology and the Israeli experience. *Human Resource Management Review*, 20(3), pp.194-202.
- DuBrin, A.J., 2009. *Political behavior in organizations*. Sage.
- Ellen, B.P., 2014. Considering the positive possibilities of leader political behavior. *Journal of Organizational Behavior*, 35(6), pp.892-896.
- Eisenhardt, K.M. and Graebner, M.E., 2007. Theory building from cases: Opportunities and challenges. *Academy of management journal*, 50(1), pp.25-32.
- Fedor, D.B. and Maslyn, J.M., 2002. Politics and political behavior: where else do we go from here?. In *The many faces of multi-level issues* (pp. 271-285). Emerald Group Publishing Limited.
- Fedor, D., Maslyn, J., Farmer, S. and Bettenhausen, K., 2008. The contribution of positive politics to the prediction of employee reactions. *Journal of Applied Social Psychology*, 38(1), pp.76-96.
- Ferris, G.R. and Kacmar, K.M., 1992. Perceptions of organizational politics. *Journal of management*, 18(1), pp.93-116.
- Ferris, G.R., Adams, G., Kolodinsky, R.W., Hochwarter, W.A. and Ammeter, A.P., 2002. Perceptions of organizational politics: Theory and research directions. In *The many faces of multi-level issues* (pp. 179-254). Emerald Group Publishing Limited.
- Ferris, G.R. and Treadway, C.D. 2012. *Politics in organizations: Theory and research considerations*. Routledge.
- Froman, L.A., 1962. *People and Politics: An Analysis of the American Political System*. Prentice-Hall.

- Gilmore, D.C., Ferris, G.R., Dulebohn, J.H. and Harrell-Cook, G., 1996. Organizational politics and employee attendance. *Group & Organization Management*, 21(4), pp.481-494.
- Gotsis, G.N. and Kortezi, Z., 2010. Ethical considerations in organizational politics: Expanding the perspective. *Journal of Business Ethics*, 93(4), pp.497-517.
- Hill, S., Thomas, A. and Meriac, J., 2016. Political behaviors, politics perceptions and work outcomes: Moving to an experimental study. *Handbook of organizational politics: Looking back and to the future*, pp.369-400.
- Hochwarter, W.A., 2012. The positive side of organizational politics. *Politics in organizations: Theory and research considerations*, pp.27-65.
- Kane-Frieder, R.E., Hochwarter, W.A. and Ferris, G.R., 2014. Terms of engagement: Political boundaries of work engagement–work outcomes relationships. *human relations*, 67(3), pp.357-382.
- Kapoutsis, I. and Thanos, I., 2016. Politics in organizations: Positive and negative aspects of political behavior. *European Management Journal*, 34(31), p.0e312.
- Kimura, T., 2015. A review of political skill: Current research trend and directions for future research. *International Journal of Management Reviews*, 17(3), pp.312-332.
- Kurchner-Hawkins, R. and Miller, R., 2006. Organizational politics: Building positive political strategies in turbulent times. *Handbook of organizational politics*, 1, pp.328-351.
- Landells, E.M. and Albrecht, S.L., 2015. The positives and negatives of organizational politics: a qualitative study. *Journal of Business and Psychology*, pp.1-18.
- Liu, Y., Liu, J. and Wu, L., 2010. Are you willing and able? Roles of motivation, power, and politics in career growth. *Journal of Management*, 36(6), pp.1432-1460.
- McFarland, L.A., Van Iddekinge, C.H. and Ployhart, R.E., 2012. Measurement and methodology in organizational politics research. *Politics in organizations: Theory and research considerations*, pp.99-129.
- Miles, M.B. and Huberman, A.M., 1994. *Qualitative data analysis: An expanded sourcebook*. sage.
- Mintzberg, H., 1983. *Power in and around organizations* (Vol. 142). Englewood Cliffs, NJ: Prentice-Hall.
- Pfeffer, J., 2010. Power play. *Harvard Business Review*, 88(7/8), pp.84-92.
- Riley, P., 1983. A structurationist account of political culture. *Administrative Science Quarterly*, pp.414-437.
- Rosen, C.C., Harris, K.J. and Kacmar, K.M., 2009. The emotional implications of organizational politics: A process model. *Human Relations*, 62(1), pp.27-57.
- Rosen, C.C. and Hochwarter, W.A., 2014. Looking back and falling further behind: The moderating role of rumination on the relationship between organizational politics and employee attitudes, well-being, and performance. *Organizational Behavior and Human Decision Processes*, 124(2), pp.177-189.
- Shea-Van Fossen, R.J. and Vredenburg, D.J., 2014. Exploring Differences in Work's Meaning: An Investigation of Individual Attributes Associated with Work Orientations. *Journal of Behavioral and Applied Management*, 15(2), p.101.
- Thanos, I.C., Dimitratos, P. and Sapouna, P., 2016. The implications of international entrepreneurial orientation, politicization, and hostility upon SME international performance. *International Small Business Journal*, p.0266242616641749.
- Treadway, D.C., Hochwarter, W.A., Kacmar, C.J. and Ferris, G.R., 2005. Political will, political skill, and political behavior. *Journal of Organizational Behavior*, 26(3), pp.229-245.

**DETERMINANTS OF SPORT COMMITMENT AND PURCHASE  
INTENTION OF RUNNERS: AN EMPIRICAL EXAMINATION**

**Koronios, Konstantinos; Kriemadis, Athanasios; Gkatsis, Georgia; Manousaridou,  
Genovefa**

Department of Sport Management, University of Peloponnese, Sparti, Greece

**ABSTRACT**

Worldwide, activity levels and participation in sports among individuals, have had an increasing trend over the last few years, with leisure activities (i.e., running, climbing, trekking etc) being among the most prevalent types of sport participation. From the abovementioned types of sport, physical and leisure activities have had a tremendous increase in popularity and number of participants, whilst group sports participation percentages have elevated to a lower degree. The results indicate that there is a development of recreational sport participation which has drawn the attention of a growing number of new participants, along with the recruitment of individuals from other types of sport. The most well-known recreational sport activity with participants of all ages, is running.

The aim of this research is to examine the determining factors of runners' motivation to maintain involvement, utilizing an expanded version of Sport Commitment Model as a theoretical frame of reference, with the addition of the self-congruity variable, in order to explore sport-related consuming behavior of participants. A quantitative method was used for the purpose of this study and a total of 1326 questionnaires were successfully completed and analyzed by means of SPSS and AMOS. The Sport Commitment Model was validated and findings supported commitment to be a predictor of purchase intention and participation frequency of runners. Moreover, self- congruity was found to impact only on participation frequency.



*Keywords: commitment, motivation, self-congruence, involvement, constraints, participation, purchase intention*

## INTRODUCTION

Worldwide, activity levels and participation in sports among individuals, have had an increasing trend over the last few years, with the most prevalent types of sport participation being physical activity, group sports, and leisure activities (i.e., climbing, trekking etc.) From the abovementioned types of sport, physical and leisure activities have had a tremendous increase in popularity and number of participants, whilst group sports participation percentages have elevated to a lower degree (Casper et al., 2007). The results indicate that there is a development of recreational sport participation which has drawn the attention of a growing number of new participants, along with the recruitment of individuals from other types of sport. The most well-known recreational sport activity with participants of all ages, is running. Historically, running is one of the earliest types of sport, rooted in ancient Greece via marathon participation (Pate and O'Neill, 2007). The sport of running has consistently demonstrated stable participation rates and nowadays is experiencing a significant growth in total demand. More specifically, running is among the most attractive sports in Europe with an estimated 50 million individuals running systematically with their annual sport expenditures being approximately € 9.6 billion per year. According to this evidence, running can be characterized as one of the biggest and fastest developing sport markets in the world (Scheerder et al., 2015)

Taking into consideration the substantial financial effect of the sport of running, more thorough research is needed in order to single out the perceived significance level of factors correlated with commitment to running. Several studies in the era of sport management have suggested theoretical models pertaining to sport participation (Brooks, 1994; Milne and McDonald, 1999; Green, 2003; Hughes and Shank, 2005), with the majority of them being too complicated and inadequate to integrate core sport marketing concepts and strategies.

Based on the original (Scanlan et al., 1993), adjusted (Alexandris et al., 2002) and expanded (Casper et al., 2007) sport commitment model, the purpose of the current research is to further explore the above mentioned model, validating the factors that significantly affect commitment to running, as well as to explore its efficiency to affect individuals' sport consumption behavior. Intensifying runners' commitment is a crucial task of sport management, given that commitment indicates persistence in a specific activity and relates to circumstances where individuals either wish to, or ought to maintain their involvement. Commitment- relevant results are crucial for the policy makers involved with the sport industry, as they can be taken into consideration for the formulation and implementation of efficient retention strategies (Casper et al., 2007).

Previous studies have examined sport participant comportment by utilizing variables such as involvement (McGehee et al., 2003), loyalty (Kang, 2002), intention (Hagger et al., 2002) and motivation (Milne and McDonald, 1999). Although it is explicit that more devoted participants will have a greater degree of loyalty to the specific sport activity helping the organization achieve its strategic objectives, along with profitability improvement (Iwasaki and Havitz, 2004), the empirical exploration of antecedent factors influencing individuals' sport commitment is unclear.

## **THEORETICAL BACKGROUND**

Sport commitment can be delineated as a psychological variable depicting the devotion and determination to maintain sport participation (Scanlan et al., 1993). Social exchange theory provides the dominant theoretical basis for the development of the sport commitment model (Kelley and Thibaut, 1978), which was established owing to the sufficient indications that enjoyment is one of the main participation motives in divergent sport samples (Scanlan et al., 1993). In contrast to previous studies and models, the current model uses the variable of commitment of sport participants as it contributes to a thorough understanding and sport- consistent perspective of this behavior and its subjacent psychological status.

Psychological commitment has been proposed as one of the variables which illustrates the attitudinal element of loyalty and contemplates behavioral loyalty (Park and Kim, 2000; Alexandris et al., 2002). More specifically, sport commitment can be delineated as a psychological status illustrating the eagerness and determination to maintain exercising via a specific program, a specific sport, or via common athletic activities. Intensifying individuals' commitment is a crucial assignment for sport managers, as according to previous results approximately 50% of the individuals who begin participation in a sport activity withdraw from sport and physical activity in a short time period (Dishman, 2001). The indicated data recommend that studies on commitment related attitudes are crucial for sport practitioners, in order to implement efficient retention strategies (Alexandris et al., 2002).

The sport commitment model presupposes the existence of a variety of antecedent factors which can influence participation variations, such as sport enjoyment, involvement opportunities, social constraints and personal investments (Scanlan et al., 1993). Sport enjoyment can be delineated as an assertive emotional reaction to the experience of sport participation that mirrors generalized sentiments such as happiness, sympathy, and amusement. Researches on sport and leisure motivation evidently prove this variable. It's extensively supported that committed sport participants are mostly intrinsically motivated. Happiness, sympathy, and amusement have been found to be crucial motives for taking part in sport (Alexandris et al., 2002).

Personal investments can be characterized as all the personal assets devoted by individuals, involving time, exertion, intensity and money, which cannot be recovered in case of termination of sport participation (Casper et al., 2007). The significance of this variable is correlated with the type of the sport. For certain types of outdoor sport, namely marathon running and cycling, significant expenditure in time, exertion and money for individuals are demanded. On the contrary, other types of sport like basketball and soccer require lower monetary and time investment. Moreover, researches have indicated that time needed for sport is one of the most crucial among the important factors influencing participation (Alexandris et al., 2001).

Social constraints refer to the common anticipations and patterns of participants' society which generate the sense of commitment to maintain sport participation (Scanlan et al., 1993). According to the previous approach, the higher an individual's compulsion forced by society to maintain their participation in sport is. There is a similarity between the aforementioned variable and the anticipated social norm construct, which has been mentioned in the theory of reasoned action as well as in the planned behavior theory (Ajzen, 1987). Although social constraints appear to play a crucial role in younger individuals' participation, as family and companions generally affect their conduct, it is controvertible whether one's social surroundings affect commitment to sport, among adults. Previous studies, which tested the abovementioned theories in sport context displayed marginal contributions of the social norm of attitudes to the prognostication of sport participation (Alexandris et al., 2002).

Involvement opportunities can be described as appreciated opportunities the presence of which is directly correlated with the continuance of sport participation (Scanlan et al., 1993). More specifically, involvement opportunities can be characterized as all the perceived advantages that an individual obtains via continuing sport participation including companionship, socializing, sport expertise, and physical improvement (Casper et al., 2007). Furthermore, this variable is correlated with the collateral advantages of the continuance of sport participation (Alexandris et al., 2002). Individuals' expectations about physiological, psychological and social advantages from exercising have been proposed as potential paradigms.

Despite the strong reputation of running, which is one sport enjoyed by all ages, there is a scarcity of studies attempting to quantify the purchase behavior of runners. According to previous researches (Kang, 2002; Hee et al., 2009), one notion which could enlighten individuals' sport consumption behavior is self-congruity. The self-congruity theory (Sirgy, 1986), hypothesizes that individuals' decision making is contingent on the degree of congruency amidst their self-concept and the stereotyped image of the individuals considered to be found in a particular condition. In the framework of sport consumption, previous results (Brooks, 1998; Kang, 2002) support that self-congruity plays a crucial role in an individual's determination to become involved in sport or exercise participation.

However, the applicability of the theory remains understudied and more research is needed for the application of self- congruity in the sport consumption field (Kang, 2002). Although it is reasonable to suppose that an individual committed to sport activity would participate regularly and would be more prone to allocate a higher budget on equipment acquisition, to date, no significant correlation has been proven to be found among the self-congruity variable and sport consumption behavior.

The aim of this study is to develop an expanded version of the sport commitment model in runners' population, as well as to provide a more comprehensive understanding of the relations among the antecedent factors influencing runners' participation as well as their sport-related spending. Based on the literature, the suggested model (Figure 1) presents the proposed interactions. All the hypothesized variables are displayed in the above mentioned model. Commitment and Self – Congruence are expected to be positive associated to participation frequency and purchase behavior.

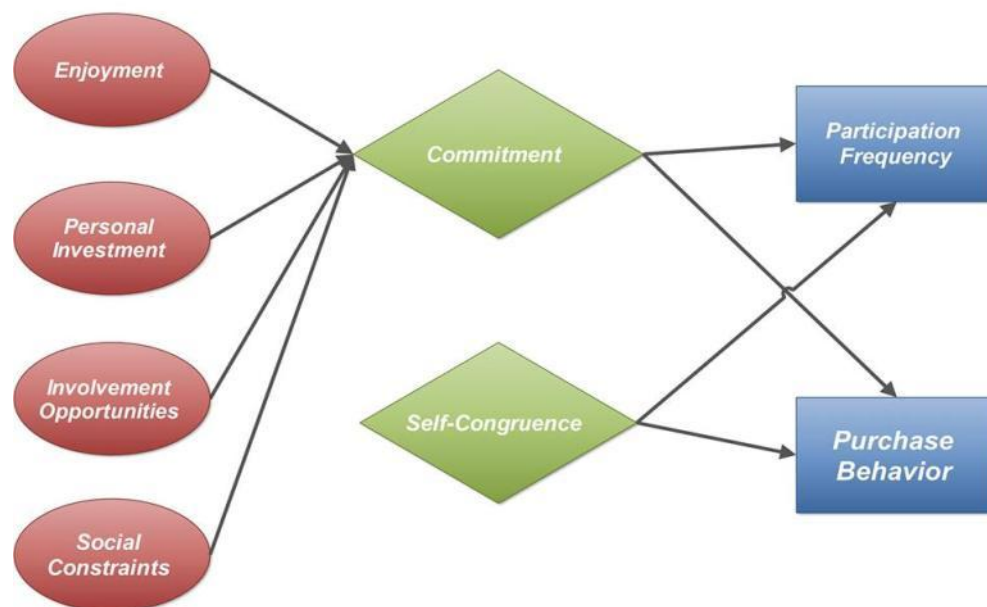

Figure 1. Sport Commitment, Self-Congruence and Behavioral Intentions Model

## METHODOLOGY

A quantitative method was used for the purposes of the study and questionnaires were collected from runners who had participated in an international running event (5km and 10km) in Greece. Individuals were enlisted to fill in a web-based survey with the help of the organizing committee of the event, which sent out an e-mail invitation to the participants. A total of 1326 questionnaires were successfully completed and analyzed.

## RESULTS

Of the 1326 respondents in our study, 834 (62.9%) were male and 492 (37.1%) were female. The participant's age varied from 13 to 69 with a mean age of 37.75 years (SD=10.25). The majority of the participants held a bachelor degree (45.5%) while 26.5% had completed post graduate studies. Professionally, half of them (57.4%) were employed in the public or private sector and 21.6% worked as freelancers. In terms of marital status, 51.9% were married or attached, 42.8% were single and 5.4% were divorced or widowed. The monthly revenue was under €1,000 for half of the respondents (57.5%) while 32.7% earned between €1,000 and €2,000; 9.8% earned more than that.

#### *Measures*

Sport Commitment Scale (SCS) was measured using Scanlan et al's (1993) model as it was modified by Alexandris et al. (2002). As a result, the five scales of SCS (commitment, enjoyment, investment, social constraints and involvement opportunities) were estimated by four items each, on a 5 point Likert scale. Moreover, self-congruity was assessed by eight items on a 5 point Likert scale based on Sirgy et al's (1997) work. Finally, participation frequency and purchase intention were measured with one straightforward question each.

#### *Data Analysis*

Using SPSS statistical package, data distribution, descriptive statistics and internal consistency analyses were conducted while data were eventually analyzed using AMOS 21. A confirmatory factor analysis (CFA) was carried out to investigate the validity of Sport Commitment Model (SCM) and Structural Equation Modelling (SEM) analysis was performed to study the effect of commitment and self-congruity on participation frequency and purchase intention of runners.

#### *CFA and SEM*

The data were analyzed for normality with skewness and kurtosis to be acceptable for the variables; a reliability analysis was also carried out with the following results: Commitment (4 items, alpha Cronbach's =0.78); Enjoyment (4 items, alpha Cronbach's=0.82); Social Constraints (4 items, alpha Cronbach's =0.66); Involvement Opportunities (4 items, alpha Cronbach's =0.65); Personal Investment (4 items, alpha Cronbach's=0.62) and Self-Congruity (8 items, alpha Cronbach's = 0.93). The initial results of confirmatory factor analysis revealed an improper fit. Modifying the model, an item from the sub-scale social constraints and another from the sub-scale involvement were removed as their loadings were poor (0.26 and 0.29). The analysis of the final model revealed an acceptable fit (CFI = 0.93; RMSEA=0.092) and the ratio  $\chi^2/df$  was lower than five that is within the acceptable limits (Santi et al., 2014; Byrne, 2010). Finally, correlations among the factors were calculated to support the different constructs.

Moving on to the central analysis, SEM was used to examine the effect of commitment and self-congruence upon purchase intention and participation frequency. Based on Casper's et al. (2007) extended model, SCM was used to study the relationship among sport commitment, participation frequency and consumption behavior. Moreover, self-congruity variable was included in the present model. The fit indices of the model were acceptable (CFI = 0.98; NNFI= 0.9, RMSEA=0.095) and the ratio  $\chi^2/df$  was lower than five. Personal investment, enjoyment, involvement opportunities and social constraints revealed to have an effect on commitment with involvement opportunities to be the most powerful predictor ( $\beta=0.69$ ). Moreover commitment was found to be a predictor for purchase intention ( $\beta=0.34$ ) as well as for participation frequency ( $\beta=0.39$ ). In terms of self-congruity, results indicate a significant effect only on participation frequency ( $\beta=-0.07$ ,  $p<0.05$ ).

## DISCUSSION, IMPLICATIONS AND FURTHER RESEARCH

The aim of this study was to examine the applicability of an expanded version of Sport Commitment Model, based on the modifications made by Alexandris et al. (2002) in runners as well as to study the influence of self-congruity and commitment on participation involvement and purchase intention. The first objective of present study was fulfilled by the model verification; the internal consistency reliabilities of the sub-scales and fit indices of confirmatory factor analysis were sufficient. However, attention should be paid to the two items of the proposed sub-scales that were removed due to poor loading in CFA. Previous studies have supported the SCM but also with some adjustments; especially in terms of social constraints sub-scale (Sousa et al., 2007) and investment sub-scale (Alexandris et al., 2002).

The second objective of the research was to predict runner's participation and consumption using sport participant commitment and self-congruity theory. The results revealed that commitment had a positive and significant impact on their consumption and participation frequency. This finding is consistent with previous research (Casper et al, 2007) that proposed committed players to spend more money on their equipment, associating monetary values to psychological state and also to play more frequently. However, self-congruity revealed to affect only participation frequency and not the monetary consumption. This finding may also be explained compared to the descriptive statistics of the survey; indeed it has been mentioned that the monthly revenue of our participants was under €1,000 for half of the respondents (57.5%) while 32.7% earned between €1,000 and €2,000 explaining a low income. Previous studies displayed a positive connection between self-congruity and consumer behavior (Sirgy et. al, 1997).

This paper revealed personal investment, enjoyment, involvement opportunities and social constraints to have a positive effect on runner's commitment. Additionally, runners' psychological commitment

has an impact on their consuming behaviors and participation frequency while self-congruity was found to be associated only to participation frequency.

The results of this study could provide useful insights to marketing managers as a way to increase consumption through sport commitment. Moreover the linkage between participation frequency and commitment could help managers to understand the reasons athletes choose to participate in particular running events. Increasing involvement opportunities and enjoyment could have a positive impact on athletes' purchase behaviors. Finally the validation of sport commitment model in runners could present a useful framework for all the parties involved in sports (e.g. coaches).

Nevertheless, the findings were based on a single event. Therefore, more research is proposed to empirically examine the consumers' behaviors among participants in events of various levels of difficulty. Another limitation of this research is the use of single item variables for purchase intention and participation frequency. Furthermore, more research is needed to shed light in differences in terms of lifestyle among participants, which could contribute significantly to their consumer behavior.

## REFERENCES

- Ajzen, I., (1987). "Attitudes, traits, and actions: Dispositional prediction of behavior in personality and social psychology". *Advances in experimental social psychology*, Vol.20, pp.1-63.
- Alexandris, K., Grouios, G., Tsorbatzoudis, H., and Bliatsou, A. (2001). "Relationship between perceived constraints and commitment to recreational sport participation of university students in Greece" *International Journal of Sport Management*, Vol. 2, No. 4, pp. 282-296.
- Alexandris, K., Zahariadis, P., Tsorbatzoudis, C., and Grouios, G. (2002). "Testing the sport commitment model in the context of exercise and fitness participation", *Journal of Sport Behavior*, Vol. 25, No. 3, pp. 217.
- Brooks, C. (1994). *Sports marketing: Competitive business strategies for sports*. Benjamin-Cummings Publishing Company.
- Byrne, B. M. (2010). *Structural equation modeling with AMOS (2nd ed.)*. NY: Routledge
- Casper, J. M., Gray, D. P., and Stellino, M. B. (2007). "A sport commitment model perspective on adult tennis players' participation frequency and purchase intention" *Sport Management Review*, Vol. 10, No. 3, pp. 253-278.
- Dishman, R. K. (2001). "The problem of exercise adherence: Fighting sloth in nations with market economies", *Quest*, Vol.53, No.3, pp. 279-294.
- Green, K., Smith, A., and Roberts, K. (2005). "Young people and lifelong participation in sport and physical activity: a sociological perspective on contemporary physical education programmes in England and Wales", *Leisure Studies*, Vol. 24, No. 1, pp. 27-43.
- Hagger, M. S., Chatzisarantis, N. L., and Biddle, S. J. (2002). "A meta-analytic review of the theories of reasoned action and planned behavior in physical activity: Predictive validity and the contribution of additional variables", *Journal of sport & exercise psychology*, Vol. 24, No. 1.
- Hee Kwak, D., and Kang, J. H. (2009). "Symbolic purchase in sport: the roles of self-image congruence and perceived quality", *Management Decision*, Vol. 47, No. 1, pp. 85-99.
- Hughes, S., and Shank, M. (2005). "Defining scandal in sports: Media and corporate sponsor perspectives", *Sport Marketing Quarterly*, Vol. 14, No.4, pp. 207.
- Iwasaki, Y., and Havitz, M. E. (2004). "Examining relationships between leisure involvement, psychological commitment and loyalty to a recreation agency", *Journal of Leisure Research*, Vol. 36, No. 1, p. 45.
- Kang, J. H. (2002). "A Structural Model of Image-Based and Utilitarian Decision-Making Processes for Participant Sport Consumption", *Journal of Sport Management*, Vol. 16, No. 3.
- Kelley, H. H., and Thibaut, J. W. (1978), *Interpersonal Relations: A Theory of Interdependence*.

- McGehee, N. G., Yoon, Y., and Cárdenas, D. (2003). "Involvement and travel for recreational runners in North Carolina", *Journal of Sport Management*, Vol. 17, No. 3, pp. 305-324.
- Milne, G. R., and McDonald, M. A. (1999). *Sport marketing: Managing the exchange process*. Jones & Bartlett Learning.
- Park, S. H., and Kim, Y. M. (2000). "Conceptualizing and measuring the attitudinal loyalty construct in recreational sport contexts", *Journal of sport management*, Vol. 14, No. 3.
- Pate, R. R., and O'Neill, J. R. (2007). "American women in the marathon", *Sports Medicine*, Vol. 37, No. 4-5, pp. 294-298.
- Santi, G., Bruton, A., Pietrantonio, L., and Mellalieu, S. (2014). "Sport commitment and participation in masters swimmers: The influence of coach and teammates", *European journal of sport science*, Vol. 14, No. 8, pp. 852-860.
- Scanlan, T. K., Simons, J. P., Carpenter, P. J., Schmidt, G. W., and Keeler, B. (1993). "The Sport Commitment Model: Measurement development for the youth-sport domain", *Journal of Sport & Exercise Psychology*, Vol. 15, No.1.
- Scheerder, J., Breedveld, K., and Danchev, A. (Eds.). (2015). *Running across Europe: the rise and size of one of the largest sport markets*. Springer.
- Sirgy, M. J. (1986). *Self-congruity: Toward a theory of personality and cybernetics*. Praeger Publishers/Greenwood Publishing Group.
- Sirgy, M. J., Grewal, D., Mangleburg, T. F., Park, J. O., Chon, K. S., Claiborne, C. B., Johar J.S. and Berkman, H. (1997). "Assessing the predictive validity of two methods of measuring self-image congruence", *Journal of the academy of marketing science*, Vol. 25, No. 3, pp. 229-241.
- Sousa, C., Torregrosa, M., Viladrich, C., Villamarín, F., and Cruz, J. (2007). "The commitment of young soccer players", *Psicothema*, Vol.19, No. 2, pp. 256-262.



## THE TRADE EFFECTS OF ECONOMIC INTEGRATION IN EMERGING MARKET OF THE EURASIAN ECONOMIC UNION

**Kovalev, Victor; Falchenko, Oksana; Vyazovskaya, Veronika; Maydanik, Vera**

Foreign Economic Activity Dept., Ural State University of Economics, USUE, Yekaterinburg, Russia

### ABSTRACT

The paper is devoted to the analysis of development prospects and problems of Eurasian Economic Union of Russia, Kazakhstan, Belarus, Armenia and Kyrgyzstan (EEU). It considers integration problems, effects and contradictions of economic integration inside EEU. The main purpose of the paper is to investigate trade effects of economic integration in emerging market of the Eurasian economic union and contradictions of the integration among the participants of this union. The paper shows that the major integration challenge inside EEU is the domination of the redistributive effects over the creative one.

*Keywords: economic integration, effects of economic integration, trade, emerging ma Eurasian Economic Union, EEU, creative effect, distributive effect.*

### INTRODUCTION

Today, the contours of global competition are defined mostly not by economic cooperation of individual states but interaction of various integration associations operating in the global economy. That's why the most important feature of any such project is a balance of trade effects, which eventually can determine its integration competitiveness in the world economy. It is the inner core of integration project, based on a combination and harmonization of the interests of states, which participate in this project.

Eurasian Economic Union – EEU (started functioning with January 1, 2015) is an international organization of regional economic integration. Previous to this date The Customs Union and The Common Economic Space functioned within the institutional structure of the Eurasian Economic Community (EurAsEC). Thus, the 23-year implementation of the Eurasian integration the project has gone through four stages: 1) Free Trade Area as CIS countries (1993-2010); 2) Customs Union (2010-2011).; 3) Common economical space (2012-2014); 4) Economic Union (2015 - Currently). The Eurasian Economic Union (EEU) comprises 5 member states (such emerging markets as Russia, Kazakhstan, Belarus, Armenia and Kyrgyzstan), which are party to the founding treaties of the union. It should be emphasized that the last three stages this integration project took five years, which certainly indicates the ultrahigh pace of integration processes. It is worth noting that not always in the

implementation of such initiatives speed ensures proper quality, as each successive stage of regional economic integration requires states more responsible approach to the coordination and harmonization of their individual interests in the framework of the integration associations, gradually transforming the approach to defending the collective interests of integration association in the system of international economic relations.

The main purpose of the paper is to investigate trade effects of economic integration in emerging market of the Eurasian economic union and contradictions of the integration effects received its participants.

## EFFECTS OF ECONOMIC INTEGRATION: LITERATURE REVIEW

Economic integration is defined as "the abolition of discrimination within an area" (Balassa, 1961). Economic integration theory "can be defined as that branch of tariff theory which deals with the effects of geographically discriminatory changes in trade barriers" among countries (Lipsey, 1960). According to Machlup (1977) integration is the process of combining separate economies into a larger economic region. Machlup (1977) further argue that integration is concerned with "the utilization of all opportunities of efficient division of labor".

Studies discussing trade effects from the economic integration and explaining the theoretical implications of preferential trade agreements are based on the study of Viner (1950).

In literature we can find two types of economic integration effects:

1. *static effects;*
2. *dynamic effects.*

Static effects can be divided into two effects: trade creation effect and trade diversion effect (Viner, 1950). *Trade creation effect* means the situation when the domestic production of a good in a member country is replaced by the imports of the same good from another member country within the customs union because of the lower cost production.

In its turn, *trade diversion effect* can occur when the imports from a non-member country are replaced by the imports of a member country because of the removal of tariffs between members and the application of common customs tariffs to non-member countries (Jošić and Jošić, 2013). A number of studies have claimed that trade diversion may actually be beneficial in the case of developing countries and markets (Bhambri, 1962; Sakamoto, 1969).

As apposed to static effects of economic trade integration the less known but much more important are *dynamic effects*. Balassa (1961) carried out the first systematic survey of economic integration' dynamic effects. According to him, dynamic effects of economic integration and customs union creation are:

1. *Effects on economies of scale.*

Corden (1972, p.465) firstly introduced the concept of economies of scale into the customs union theory. Economies of scale requires a larger market than is possible within a particular country. As the economic subjects are obliged to be optimal efficient, the economies of scale will depend on the growth of production. Balassa (1961) argued that small markets increase costs, limit the extent of product specialization, reduce competition, and lessen the incentives for technological improvements.

2. *Effects on terms of trade.*

Terms of trade of member countries may improve because they can now have greater bargaining power. Nowadays developing countries and emerging markets are now adopting trade liberalization and deregulation policies, as part of their overall stabilization and adjustment programs as agreed with international organizations. They are now looking at economic integration schemes as an instrument for a more competitive insertion into the global economy and international trade (Rueda-Junquera, 2006).

3. *Effects on competition.*

Access to the customs union and other higher forms of economic integration enlarges the market in comparison to protected trade and gives a producer access to new forms of competition. In other words, the increase in competition among enterprises forces the economic subjects to be more efficient in order to gain a new market share. An economic integration association may be welfare increasing if the partner countries are actually competitive but potentially complementary (Meade, 1955) .

4. *Effects on investment and capital formation.*

Some forms of integration (for instance, customs union and other higher forms of economic integration) could enhance the investment from outside investors and provide stimulus to economic growth. Investments are attracted to the most productive and competitive sectors which are able to survive on the market.

Some studies (Baldwin et al., 1995; Dunning and Robson, 1988; Dee and Gali, 2003) introduced the concepts of investment creation and diversion. When investment barriers are removed, investment creation is the case when production is moved from a high-cost source to a lower-cost source in the union (Dee and Gali 2003). Investment diversion occurs when production is moved from a low- cost non-member country to a higher-cost member country of the union (Dee and Gali 2003).

5. *Effects on technological advances (innovations).*

Economic integration can improve technological innovations and progress through R&D programs.

Knobel offered an approach to classification of economic integration' effects and motives on emerging markets (using the case of the EEU) (Knobel, 2015). He divided effects into two groups: *creative effects and redistributive effects*.

1. *Creative effects*. The presence of barriers to trade between the two countries produces inefficiency of resource use and reproduction (Egger and Larch, 2008; Pahre, 2008; Gruber, 2000; Manger, 2009; Baldwin and Jaimovich, 2012; Fugazza and Robert-Nicoud, 2010).

This is due to the fact that trade restrictions, as well as any economic barriers, generate irreversible loss of aggregate social welfare (Basevi, 1968; Baier and Bergstrand, 2004; Siriwardana, 2007).

In the absence of such barriers various sectors of the integrating countries could produce and sell to each other and to consume large quantities of products. Removing mutual trade barriers releases, and actually creates, the resources which are not made earlier and are distributed among the economic integration participants, thereby increasing their competitiveness (Baldwin and Wyplosz, 2003).

2. *The redistributive effects*. One or more economic integration members, which are interested in its expansion for whatever reasons (including, perhaps, and non-economic), are attracting new members through the partial transfer of their resources to the integration agreement partners.

In this case, the other participants are interested in the integration due to the reallocation of resources in their favor (Baier and Bergstrand, 2004).

Integrated associations benefiting from the effects of the second type (the redistributive effects) are capable to expand and engage new members faster than those based benefiting from the effects of the first type (the creative effects). In this case the distributive effects can offer the integration members the concrete financial benefits in the short term (Knobel, 2015). However, the overall competitiveness of this type agreements is growing much more slowly (or not growing) than the agreements of the first type (Baier and Bergstrand, 2007).

Creating an additional resource in the integration associations can be considered as an additional source of economic growth, which is especially important in the current conditions. Thus, the strong growth in the Asia-Pacific region in the last 15 years are largely associated with the development of integration processes (Calvo-Pardo et al., 2009).

On the other hand, there are some contradictions within the economic integration association. For example, the major integration challenge inside EEU is the domination of the redistributive effect over the creative one (Knobel, 2015). Knobel (2015) showed the need in redistribution mechanism inside EEU as a necessary condition for getting the potential positive economic effects of free trade with other countries.

## THE EEU INTEGRATION RESULTS: SUMMARY STATISTICS

The analysis of the EEU members' external trade indicators approves the idea that the creative and redistributive effects don't appear in this integration union in their pure sense. For example, in contradiction to the fact that some trade barriers are removed, the total export flows of the EEU members don't grow but even fall down (Figure 1).

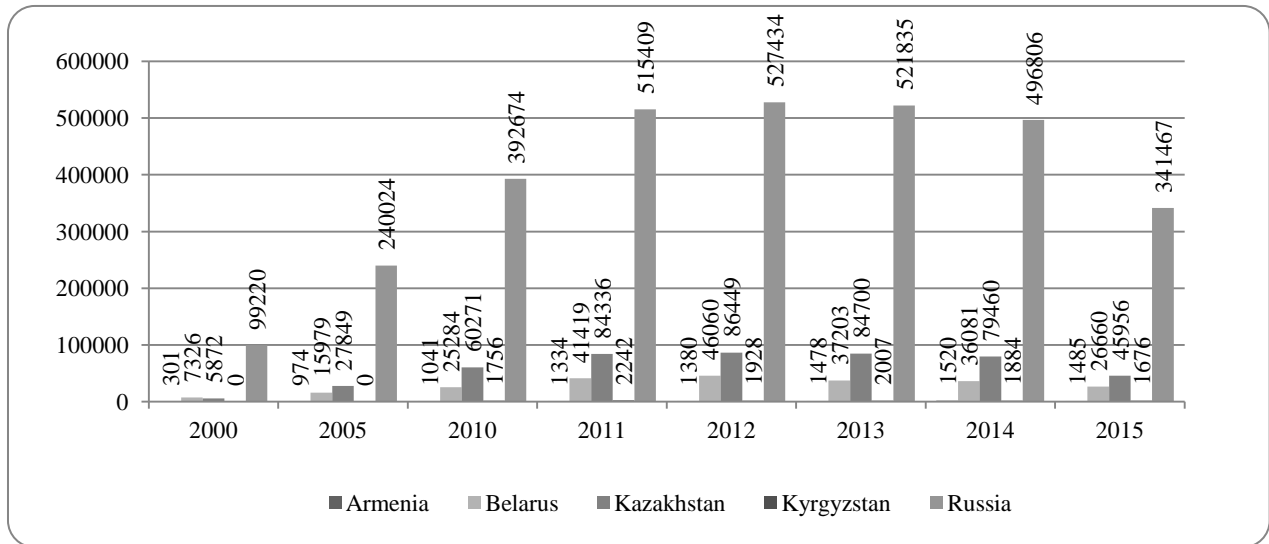

Source: authors' own calculations base on data of National Statistical Service of the Republic of Armenia, National Statistical Committee of the Republic of Belarus, the Committee on Statistics of the Republic of Kazakhstan, National Statistical Committee of the Kyrgyz Republic, The Central Bank of the Russian Federation.

Figure 1. Export in goods of the EEU members, mln US dollars

The reduction in the volume of trade between the EEU members in 2015, was less pronounced than the reduction in their total trade volume (Figure 2).

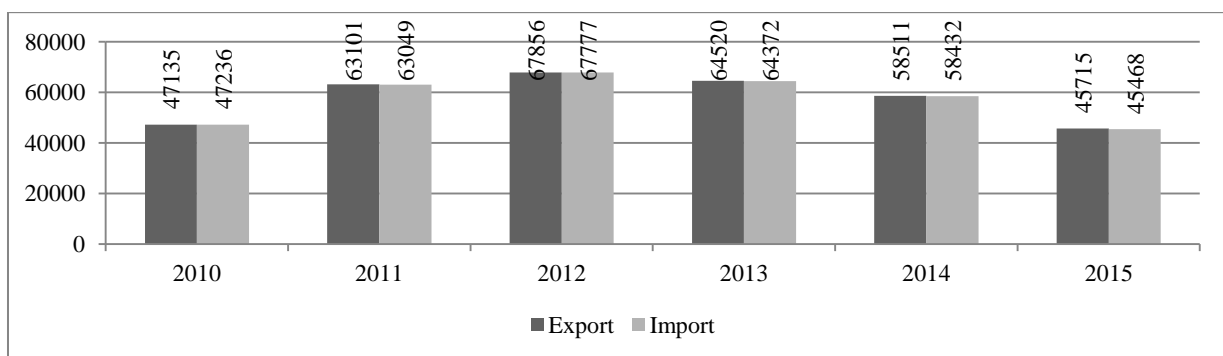

Source: authors' own calculations on the basis of Eurasian economic commission statistics.

Figure 2. Mutual trade of the EEU members, 2010-2015, mln US dollars

It is important to emphasize that Russia plays a leading role in a mutual trade with all EEU members. The entry of Armenia and Kyrgyzstan into the EEU in 2015 has affected insignificantly the structure of

mutual trade due to the small size of their economies. By the end of 2015, a large part of the mutual trade is realized by Russia with Belarus (57%) and Kazakhstan (33.5%). Also Russia interacts most than other partners in the trade with Kyrgyzstan (3.2%) and Armenia (2.8%). Other significant level of mutual trade was reached between Kazakhstan and Kyrgyzstan (1.9 %), and Kazakhstan and Belarus (1.3 %).

The trade with the EEU partners amounts to only 8% of the total Russia's exports volume, while for Belarus it reaches almost a half (41%) and for Kazakhstan the mutual trade contribution has grown up to 31% (Figure 3).

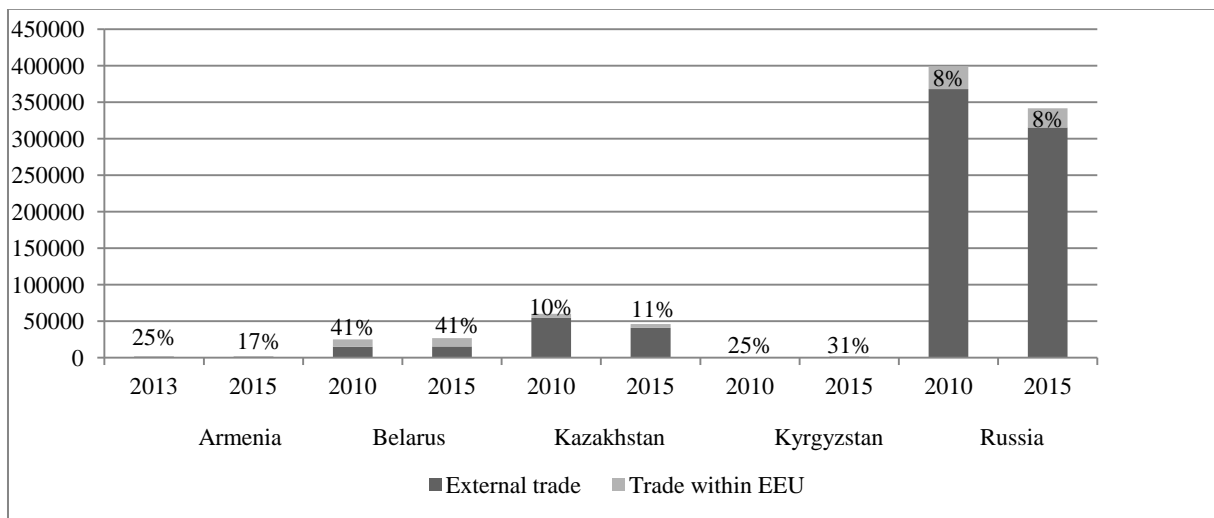

Source: authors' own calculations on the basis of Russian Integrated Foreign Economic Portal Data and Eurasian economic commission statistics.

Figure 3. Mutual trade of the EEU members, mln US dollars

The reduction of foreign trade volume became a major factor in the fall in EEU member's customs revenues (Figure 4). In total Belarus, Kazakhstan and Russia fell short of 45% import customs duties to their budgets in 2015.

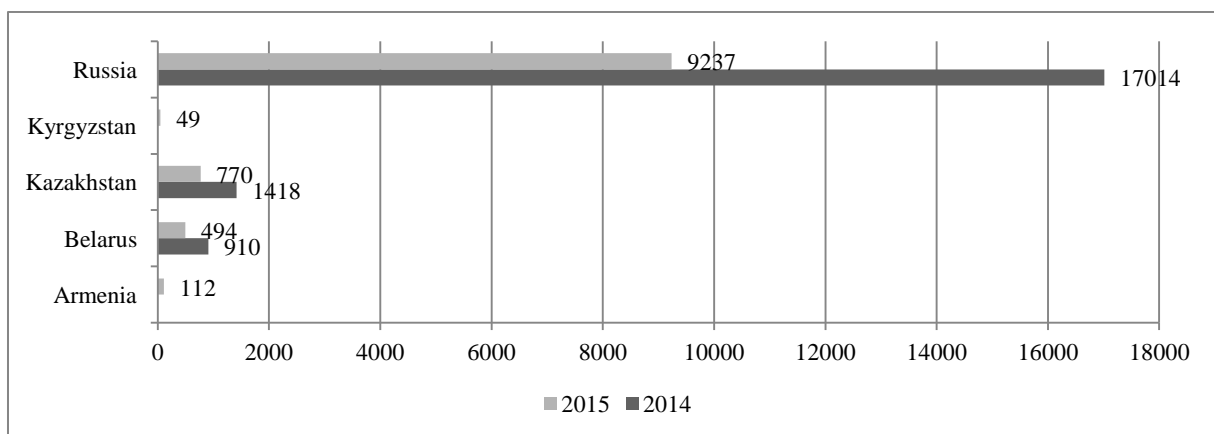

Source: authors' own calculations on the basis of Legislation System GARANT.

*Figure 4. Amount of import customs duties into the EEU members budgets, 2014-2015, mln US dollars*

It is obvious that the analyzed period of the EEU existence is not long enough for any conclusions and is aggravated by a range of politic and economic factors. However, it is possible to find out certain contradictions in the EEU members integration process.

## **ECONOMIC INTEGRATION CONTRADICTIONS IN EMERGING MARKETS: THE EEU EVIDENCE-BASED PRACTICE**

It must be emphasized that strengthening positive effects noted above is very difficult without a coordinated approach of the EEU members to implement trade, industrial and agricultural policy.

*«Combine harvester-threshers» case: The contradictory interests of the EEU countries in the implementation of non-tariff regulation tools in the conditions of application of common domestic market protection measures in relation to products from third countries*

Trade policy case becomes especially apparent after Russia's WTO accession in 2012. Russia's WTO obligations of binding customs duties became a reason of the question about the mechanisms of the EEU common external customs tariff under conditions of Russia's WTO participation, as the EEU countries to join the WTO independently and obligations made by these countries to the WTO may vary. On 19 October, 2011 the President of the Russian Federation signed the Federal Law № 282-FZ «On the ratification of the Treaty on the functioning of the Customs Union in the framework of the multilateral trading system». Treaty on the Functioning of the Customs Union in the framework of the multilateral trading system was signed on May 19, 2011 and demanded ratification. The treaty was made to promote proper functioning of the Customs Union in the event of the accession of one or more of its members to the World Trade Organization. From the date of accession by any country to the WTO provisions of the Agreement (Marrakesh Agreement Establishing the WTO) become a part of the legal system of EEU. The first to join the country shall inform the other countries and to coordinate actions with them about commitments as a condition of its accession, requiring changes to the legal system of the Customs Union. At the subsequent accession to the WTO of the other country its obligations (taken as a condition of joining the WTO) will also become a part of the legal system of the Customs Union. Commitment actions must be consistent with the rest countries of the Customs Union. Thus, the tariff commitments made by the Russian Federation to join the WTO and the schedule of binding rates also apply to Kazakhstan and Belarus, which were not WTO members in 2012 yet.

Such a situation has lead to certain conflicts of interest in the interaction of the EEU economies. The situation with the market of combine harvester-threshers is very indicative. With Russia's accession to

the WTO the common customs tariff was amended, reducing the size of import duty for HS code 8433 51 000 – «combine harvester-threshers» (the code of the Single Commodity Nomenclature for Foreign Economic Activities of the EEU) from 15% to 5%. Realizing that this situation may swipec at the domestic producers of agricultural equipment, in July 2012 at the initiative of Russian producers – «Rostselmash» (the largest market participant) and Krasnoyarsk Combine Plant (part of Concern «Tractor plants») was launched a safeguard investigation. In December 2012 a provisional safeguard measure (ad valorem duty) was imposed on combine harvesters modules and harvesters in the amount of 27.5%. Analysis of information obtained during the investigation conducted by the Eurasian Economic Commission led to the conclusion that there are grounds for the application of a safeguard measure - import surges and such imports threaten to cause serious injury to the importing member's domestic industry. The Eurasian Economic Commission decision of June 25, 2013 № 143 imposed a final safeguard duty on modules combine harvesters and harvesters for 3 years. This safeguard duty was imposed for a period of up to 7 March 2016 inclusive in size (percentage of the customs value) in 2013 - 26.7%, in 2014 - 26.2%, in 2015 - 25.7 %, in 2016 - 25.2%.

Following this decision, the events begin to develop promptly, as Kazakhstan has its own point of view on this issue and this view is different from the position of the Eurasian Economic Commission. In Kazakhstan, there are no major manufacturers of agricultural machinery, including harvesters, but Kazakhstan is ramping up production of grain, actively supplying wheat on the EEU single market. However, Kazakhstan does not want to limit itself to purchases of agricultural equipment, including harvesters, in Belarus and Russia, so it blocks the onset of action of the Eurasian Economic Commission decision № 143 of June 25, 2013 and in July-September 2013 there are intensive trade negotiations on finding a compromise solution between the participants of EurAsEC Customs Union.

In October 2013 the Eurasian Economic Commission replaces the duty with the quota to the displeasure of the Belarusian and Russian producers. Kazakhstan is very interested in supplying imported high-tech equipment and in the course of tough negotiations on the liberalization of the combine harvester-threshers single market, in fact, achieves the most favorable outcome. In 2014, Kazakhstan is to be able to import 300 combine harvesters from outside the Customs Union, Russia - 424 pieces of equipment. Fixing quotas is to be continued throughout 2015-2016 period. The following year, the Trade Ministry of Belarus on the same principle planned to divide the quota for 2015 - 52 combine harvesters and in 2016 on the territory of the country can be delivered 34 pieces of equipment. Kazakhstan, according to the decision of the Eurasian Economic Commission can import in 2015-2016, respectively, 309 and 204 foreign combine harvesters, Russia - 437 and 288 units of imported equipment.

*«Fruit and vegetables» case: The manifestation of the policy of sanctions at the national level under the conditions of implementation of the principles of unity of the customs territory of the Eurasian Economic Union*



For effective trade and economic cooperation of the EEU countries is very important manifestation of the policy of sanctions at the national level under the conditions of implementation of the principles of unity of the customs territory of the Eurasian integration project. Russian Federation Government Resolution dated August 7, 2014 N 778 "On measures to implement the Russian Federation Presidential Decree of August 6, 2014 N 560 "On the application of certain special economic measures in order to ensure the security of the Russian Federation". On the basis of this decision until 31 in December 2017 a full ban (embargo) on the import to Russia of agricultural products, raw materials and food, originating in the United States, European Union, Canada, Australia, UK, Norway, Ukraine, the Republic of Albania, Montenegro, the Republic of Iceland and Liechtenstein, on list according to the application (in the version of Russian Federation government decrees N 625 from 25.06.2015, N 842 from 13.08.2015, N 608 from 30.06.2016). In this annex to the Resolution contains a rather extensive list of goods HS groups 02, 03, 04, 07, 08, 16, 19, 21, 25 (the Single Commodity Nomenclature for Foreign Economic Activities of EEU) prohibited from being imported into the territory of Russia, if the country of origin of goods have the country identified in this article. At the same time crucial for the effectiveness of economic and trade cooperation EEU member states in addressing the agreed tasks (coordinated) agricultural policy played by the fact that the embargo is implemented only Russia in the common customs territory of EEU and the other member states did not support this Russian decision. In the absence of customs controls at the borders of the participating countries of the integration association, currently it becomes very critical and creates additional risks for effective trade and economic cooperation. Visually these risks demonstrates the statistics of Belarus exports to the EEU member states in 2015 (Table 1).

HS	Description	Unit	Quantity	in % to 2014
0710	Vegetables (uncooked or cooked by steaming or boiling in water), frozen	tn	49 220	310
	Kazakhstan	tn	104	82,4
	Russia	tn	49 116	310 (!)
0805	Citrus fruit, fresh or drie	tn	44 728	200
	Kazakhstan	tn	233	55,9
	Russia	tn	44 495	200 (!)
0808	Apples, pears and quinces, fresh	tn	769 472	188,3
	Kazakhstan	tn	93 809	133,0
	Russia	tn	675 663	200 (!)
0809	Apricots, cherries, peaches (including nectarines), plums and sloes, fresh	tn	213 601	270
	Kazakhstan	tn	7 260	64,5
	Russia	tn	206 341	300 (!)

0810	other fruit, fresh	tn	74 680	200
	Kazakhstan	tn	3 760	240
	Russia	tn	70 920	200 (!)

Source: authors' own calculations on the basis of Eurasian economic commission statistics.

Table 1. Statistics of Belarus exports to the EEU member states in 2015

Attention is drawn to the rapid growth of exports from Belarus to Russia in 2015 (08 HS group), and the 08 HS group is in the list of goods prohibited from being imported into the territory of Russia, if the goods the country of origin are the countries listed in the Government Decree Russian Federation dated August 7, 2014 N 778. Among these countries, for example, all EU countries, which prior to the embargo is a major supplier of HS 08 (Edible fruit and nuts; peel of citrus fruit or melons) to the Russian Federation. You can assume that Belarus on individual headings can replace European products on a group of 08, but a rapid growth (especially, for example, sub-0805 HS - citrus fruits, the production of which for Belarus is absolutely not typical) makes think seriously about the sources its occurrence. Risks of re-export prohibited for import of goods into the territory of Russia through Belarus remain significant and this fact must be considered when it comes to solving problems of the agreed (coordinated) agricultural policy in the EEU. This situation is of particular importance in the context of realization of import substitution policy in Russia, where domestic farmers, under the protection of the Russian Federation Government Resolution of August 7, 2014 N 778 must step up domestic production of fruits and vegetables. In terms of risk of re-export to neighboring countries that are the EEU members, in the absence of customs borders between the two countries within the Eurasian integration project, to carry out a policy of import substitution at the national level, it becomes more difficult and certainly requires some mutual responsibility of the partner countries.

*«Palm oil» case: The harmonization of different tariff commitments of member countries of the Eurasian Economic Union to the World Trade Organization*

By 2015, Kazakhstan de jure is not a member of the WTO, de facto this state is working on tariff obligations of Russia to the WTO, but the situation has changed. After joining the WTO in 2015 Kazakhstan within 5 years (the decision of the Eurasian Economic Commission on October 14, 2015 number 59 approved a list of goods - so far only 1347 names) will apply the rates of import customs lower fees as compared to the rate of duty laid down in the EEU Common customs tariff. How this situation will affect the solution of problems within the allocated areas of interstate cooperation, mentioned in this article, can be illustrated by the following example. Under the old rate (up to Russia's accession to the WTO in 2012), the import duty has been fixed, that is, it was not dependent on its value and amounted to EUR 0.4 / kg for palm oil (HS Code 1511109002 in EEU). Introduced at Russia's accession to the WTO was the ad valorem duty instead of specific and amounted to - 5%. The

implementation period for this tariff commitments to the WTO for Russia was two years and in 2014 the ad valorem rate charged to the palm oil imported in Russia, was reduced to 3%, and it is now operating in the single EEU customs tariff. Based on the analysis of the tariff commitments of Kazakhstan to the WTO and finding 1511109002 EEU HS code in the Decision of the Eurasian Economic Commission on October 14, 2015 number 59, we can conclude that the importation of palm oil into the territory of the Republic of Kazakhstan, the customs duty will be 0%, whereas Russian participants in foreign economic activity will continue to pay import duty of 3% for this raw material. With this in mind, and taking into account the fact that there are more than a low VAT rate in Kazakhstan - 12% (18% in Russia), which is charged with the duty and is part of the aggregate customs payment – price competitiveness of goods produced in Kazakhstan using palm oil as compared to Russian increases. At the same time, Kazakh food products using palm oil which is imported under the preferential tariff rates, the ability to retain the free circulation throughout the EEU customs territory. This situation with tariff obligations of Kazakhstan and Russia to the WTO is the removal of the work of the EEU single customs tariff. Tariff commitments of Kazakhstan to the WTO are more stringent (customs duty rate lower than the tariff obligations of Russia to the WTO), Russia does not want to reduce the tariffs and bring them to the Kazakhstan level, as it will lead to additional lost income of the Russian budget. However, the situation is very dissonant, because the unity of the customs tariff in the EEU for individual commodities are now in fact does not exist, that creates a conflict of national interests in EEU between Russia and Kazakhstan.

## CONCLUSION

In empirical research and scientific literature there are many different explanations of the economic integration and its impact on the associated countries. Using Knobel's approach to the economic integration effects classification (Knobel, 2015) we investigate trade effects of economic integration in emerging market of the EEU and the integration contradictions among the members of the union.

In our case, today the EEU union desperately needs a coordinated a coordinated approach of the EEU members to implement trade, industrial and agricultural policy. Without this approach it risks to become a single market of opposing countries, trying to implement their individual interests in the first place. EEU performs an important function in an attempt to recover broken cooperative relations and «dignify» the structure of foreign and mutual trade in all these states. However, these efforts should be collective and meaningful. Russia, Kazakhstan, Belarus, Armenia and Kyrgyzstan have succeeded in

creating the Union, but now that it is here, their major objective is to prove the necessity and viability of this integration to themselves and the entire world.

The investigation of trade effects of economic integration in emerging market of the EEU demonstrates, that there are much more redistributive effects in this project than creative effects. Thus, the analysis of the EEU evidence-based practice shows that competitive advantages for one country at the expense of another integration association member, which can be classified as the redistributive effect of the Eurasian economic integration, are being aimed at maintaining the non-economic objectives (political, geopolitical and others) of Eurasian integration project.

## REFERENCES

- Baier S. L., and Bergstrand J. H. (2004), "Economic determinants of free trade agreements", *Journal of International Economics*, Vol. 64 No. 1, pp. 29–63.
- Baier, S.L., and Bergstrand, J.H. (2007), "Do free trade agreements actually increase members' international trade?", *Journal of International Economics*, Vol. 71 No. 1, pp. 72–95.
- Balassa, B. (1961), *The Theory of Economic Integration*, R. D. Irwin, Inc., Homewood, , Illinois, available at: <http://www.jstor.org/discover/10.2307/2228684?uid=3738200&uid=2&uid=4&sid=21101488102823> (accessed 01 March 2017).
- Baldwin, R., Forslid, R., and Haaland, J. (1995), "Investment creation and investment diversion: Simulation analysis of the single market programme", NBER Working Paper no. 5364, National Bureau of Economic Research, Cambridge.
- Baldwin, R., and Jaimovich, D. (2012), "Are free trade agreements contagious?", *Journal of International Economics*, Vol. 88 No. 1, pp. 1–16.
- Baldwin, R., and Wyplosz, C. (2003), *The economics of European integration*, McGraw-Hill Education, Maidenhead.
- Basevi, G. (1968), "The restrictive effect of the U.S. tariff and its welfare value", *American Economic Review*, Vol. 58 No. 4, pp. 840–852.
- Bhambri, R. S. (1962), "Customs unions and underdeveloped countries", *Economia Internazionale*, XV, May 1962.
- Calvo-Pardo, H., Freund, C., and Ornelas, E. (2009), "The ASEAN free trade agreement: Impact on trade flows and external trade barriers", CEP Discussion Paper No 930, Centre for Economic Performance, London School of Economics and Political, London, Science May 2009, also available at: <http://cep.lse.ac.uk/pubs/download/dp0930.pdf> (accessed 01 March 2017).
- Corden, W. M. (1972), Economies of scale and customs union theory, *The Journal of Political Economy*, 80,(3), pp. 465-475.
- Dee, P., Gali, J. (2003), "The Trade and Investment Effects of Preferential Trading Arrangements", NBER Working Paper No. 10160, December, doi: 10.3386/w10160.
- Dunning, J. H., and Robson, P. (1988), "Multinational Corporate Integration and Regional Economic Integration", In Dunning, J. H., and Robson, P. (Eds.), *Multinationals and the European Community*, Basil Blackwell, Oxford, pp. 1-23.
- Egger, P., and Larch, M. (2008), "Interdependent preferential trade agreement memberships: An empirical analysis", *Journal of International Economics*, Vol. 76 No. 2, pp. 384–399.
- Fugazza, M., and Robert-Nicoud, F. (2010), "The emulator effect of the Uruguay round on US regionalism", Discussion Paper No. 7703, Centre for Economic Policy Research, London.
- Gruber, L. (2000), *Ruling the world: Power politics and the rise of supranational institutions*, Princeton University Press, Princeton, NJ.
- Jošić, H., and Jošić, M. (2013), "Static and dynamic effects of customs union creation", in *Economic integrations, competition and cooperation. Accession of the Western Balkan Countries to the European Union 2013 proceedings of the conference in Rijeka, Croatia, 2013*, University of Rijeka, Faculty of Economics, Rijeka, Croatia, pp. 53-65, also available at: [https://www.efri.uniri.hr/sites/efri.uniri.hr/files/cr-collections/2/euconf\\_2013.pdf](https://www.efri.uniri.hr/sites/efri.uniri.hr/files/cr-collections/2/euconf_2013.pdf) (accessed 01 March 2017).

- Knobel, A. (2015), Eurasian Economic Union: Prospects and Challenges for Development, *Voprosy Ekonomiki*, No. 3, pp. 87–108.
- Lipsey, R. G. (1960), The theory of customs unions: A general survey, *The Economic Journal*, 70 (279), pp. 496-513.
- Manger, M.S. (2009), *Investing in protection: The politics of preferential trade agreements between North and South*, Cambridge University Press, Cambridge.
- Meade, J. E. (1955), *The theory of customs unions*, North Holland, Amsterdam.
- Pahre, R. (2008), *Politics and trade cooperation in the nineteenth century*, Cambridge University Press, Cambridge.
- Rueda-Junquera, F. (2006), "European integration model: Lessons for the Central American common market", *Jean Monnet/Robert Shuman Paper Series 6 (4)*, University of Miami, Florida.
- Sakamoto, J. (1969), "Industrial development and integration of underdeveloped countries", *Journal of Common Market Studies*, No. 7 (4), pp. 283-304.
- Siriwardana, M. (2007), "The Australia – United States free trade agreement: An economic evaluation", *The North American Journal of Economics and Finance*, Vol. 18 No. 1, pp. 117–133.
- Viner, J. (1950), *The Customs Union Issue*, Carnegie Endowment for International Peace, New York, pp. 41-55.

## EFFECTIVENESS OF GOVERNMENTAL SUPPORT PROVIDED TO MONOTOWNS IN CIS COUNTRIES

**Kreidenko, Tatyana<sup>1</sup>; Sorokina, Svetlana<sup>2</sup>; Adashova, Tatyana<sup>1</sup>**

<sup>1</sup>Department of Regional Economics and Geography, Russian University of Peoples' Friendship, RUDN University, Moscow, Russia

<sup>2</sup>Department of Foreign Languages, National Research University Higher School of Economics, Moscow, Russia

*Keywords: CIS, monogorod (monotown, single-industry town), forming enterprises, strategic organization, governmental support*

The emergence and development of monotowns is typical of the process of industrialization in any country of the world. Monoprofile municipal establishments are created as high-performance economic centres. However, in case of economic changes on the market (for example, a decline in demand for products) such settlements face a high risk of social and economic tension. Without risk insurance provided by the state monotowns have to struggle against the emerging problems on their own, whereas the benefits of the production activity at their initial stages are used by the whole country.

The present research aims to identify the principles of assigning settlements to monotowns in CIS (using the cases of Kazakhstan, Russia and Belorussia), to reveal the evolution stages of monoprofile municipal establishments, to define the contemporary industrial and territorial structure of monotowns in Kazakhstan, Russia and Belorussia and their role in the countries' economy, as well as analyse the economic effectiveness of the governmental support to the development of monotown economy in the post-Soviet territory.

Currently, monotowns are the most vulnerable points in the economic development of independent states in the post-Soviet territory. It should be mentioned that having been designed in the 18<sup>th</sup>-19<sup>th</sup> centuries, the territorial structure of monotowns in the former USSR republics finally formed only in the second half of the 20<sup>th</sup> century with the help of state regulation.

In the historical context of the formation and development of monotowns in the post-Soviet space, several stages can be identified [5]. The first stage - the stage of mass emergence of mono-profile settlements is associated with the process of industrialization of the 18<sup>th</sup> and 19<sup>th</sup> centuries, and is characterized by the appearance of manufactories and ironworks, as well as the centres of rural crafts and light industry in the Russian Empire. The second stage is associated with the period of Soviet industrialization in the 1930s. XX century, when the emergence of single-industry towns was part of the development of the largest territorial production complexes of the USSR. The process was rather slow, first of all, because of the huge scale of individual projects implemented, as a rule, by the

forces of prisoners of the Gulag (who felled wood, mined coal, washed gold and also participated in the construction of many large industrial and transport facilities in the 1930s-1950s). The third stage is the years of the Great Patriotic War (1941-1945), when the emergence of mono-profile settlements (cities, settlements) occurred due to the evacuation of industrial enterprises from Central Russia to other regions, including the Union republics of the USSR. The fourth stage - in the 1950-1980s was associated with the active creation of mono-profile settlements due to the construction of city-forming enterprises in the medium- and high-tech branches of the machine-building complex, chemical production (including defense) and energy (first of all, the city at HPPs and NPPs). The emergence of a significant part of enterprises in this period is the result of the centrally planned economy of the USSR, when the main task was to unify the republics into a single economic mechanism, often without due regard for the economic efficiency of the location of production capacities [9]. As a result, many works and factories were divisions of large plants and factories located in other parts of the USSR. The collapse of the USSR automatically led to changes in the domestic and international markets, to a sharp decrease in demand for domestic products, which helped to close many city-forming enterprises. The fifth stage - from the early 90's.XX century to the present is characterized by a break in economic ties, the closure of most enterprises, and the search for forms of support for single-industry towns.

Thus, the structure of monotowns in the USSR, and then in Russia, has become a rather complex conglomerate of cities varied in size (from cities such as Togliatti, Sayanogorsk, Kostomuksha to regional towns and urban-type settlements), the complexity of production and qualification of residents (from Troitsk and Obninsk to Shumikha and the Island), in the possibilities of marketing products and the competitiveness of production, as well as in the socio-psychological characteristics of the population. The narrow specialization of most cities is, in some cases, the result of their youth. Part of the cities did not have an opportunity to develop other functions, in view of the collapse of the Soviet Union and the subsequent economic crisis.[1]

However, a unified approach to the definition and the criteria for identifying monotowns have not been developed so far. The approaches to the concept 'monotown' in the CIS countries vary, they are not legally adopted and do not consider the economic peculiarities of the recent decade. In the CIS republics the definitions of 'forming enterprise' are more or less legally adopted in Kazakhstan, Russia and Belorussia. As for the concept of 'monotown', it is only adopted in the regulatory legal acts in Kazakhstan and Russia.[3]

As is known, the mono-profile of settlements is defined through the concept of a city-forming enterprise. In the CIS republics, in Kazakhstan, Russia, Belarus and Ukraine, the definitions of the

"city-forming enterprise" have been legislatively fixed in one way or another (Table 1). In addition, the concept of "monotown" is prescribed in the normative legal acts of Kazakhstan and Russia.

Table 1. Legislation of the CIS countries by the status of city-forming enterprises [to: 3]

Country	Law	Status
Armenia	The Law of the Republic of Armenia "On Insolvency (Bankruptcy)" of 14.01.2004, 3P-17	Not registered
Azerbaijan	The Law of Azerbaijan Republic on Insolvency and Bankruptcy of 13 June 1997 No. 326-II	Not registered
Belarus	The Law of the Republic of Belarus of July 13, 2012 No. 415-Z "On economic insolvency (bankruptcy)"	City-forming organization is a legal entity whose number of employees is at least one-fourth of the employed population (workplaces) or whose economic (economic) activities serve as life support for this very settlement
Kazakhstan	The Law of the Republic of Kazakhstan dated March 7, 2014 No. 176-V ZRK "On Rehabilitation and Bankruptcy"	A legal entity, determined in accordance with the procedure established by the Government of the Republic of Kazakhstan
Kyrgyzstan	The Law of the Kyrgyz Republic on October 10, 1997 No. 74 "On Bankruptcy (Insolvency)"	Not registered
Moldova	The Law of the Republic of Moldova of 29 June 2012 No. 149 On insolvency	Not registered
Russia	The Law of the Russian Federation "On Insolvency (Bankruptcy)" of 26.10.2002 No. 127	Legal entities whose number of employees is at least twenty-five percent of the working population of the corresponding locality.
Tajikistan	The Law of the Republic of Tajikistan of December 8, 2003 No. 46 "On Insolvency (Bankruptcy)"	Not registered
Turkmenistan	The The Law of Turkmenistan of October 1, 1993 No. 861-XII "On bankruptcy"	Not registered
Uzbekistan	The Law of the Republic of Uzbekistan of May 5, 1994 No. 1054-XII "On bankruptcy"	Not registered
Ukraine	The Law "On Bankruptcy" of 14.05.1992 No. 2343-XII	Legal entities whose number of employees, taking into account their family members, is at least half of the population of the administrative-territorial unit where the legal entity is located.

*Note: The wording is given in the latest valid version of the law.*

As a result of the differences in approaches, the estimation of the number of mono-profile settlements, especially in Russia, differs significantly. [1] In the early 2000s, Russian economists referred to mono-profile cities 460 out of 1,097 cities in Russia and at least 1,200 of the 1,864 urban-type settlements in which 24% of the country's population live and up to 40% of Russia's GDP was produced before the financial and economic crisis. The official list of single-industry cities of Russia, approved by the Ministry of Regional Development (edition of July 2013) included 333 mono-profile territorial entities of 60 subjects of the Russian Federation. There are other approaches. So, according to the data of the scientists of the Expert Institute (Moscow), 467 cities and 332 townships of 76 cities of



the Russian Federation can be referred to monocities in Russia (in all subjects except the Altai, Tyva, Ingushetia, Chechnya, Nenets Autonomous District). According to the experts of the NMC "Cities of Russia" (a laboratory for regulating the socioeconomic development of cities and regions of the Institute for Macroeconomic Research), at least 500 out of 1,097 cities and 1,200 of 1,864 urban-type settlements are classified as monoprofile. The same group includes about 400 small monoprofile villages that do not have the status of urban settlements with the population of up to 3 thousand people. At the moment, the number of single-industry cities has significantly decreased in the Russian Federation, the list consists of 319 mono-profile entities. Thus, monoprofile municipalities account for 31.2% of the total number of settlements that have the status of a city, where about 11% of the country's population and almost 15% of the urban population live. Monocities in Russia account for almost 2% of the economically active population and up to 40% of the country's industrial production. [3]

In Belarus, 42 settlements with about 7% of the total population and about 9% of the urban population belong to monotowns. [8]

In 2012, a list of mono-profile settlements was compiled, which included 27 cities from 86 cities of this country. This is a very high indicator (almost a third of all existing cities in Kazakhstan are monoprofile). [3] In Kazakhstan, city-forming enterprises of single-industry towns employ more than 7% of the economically active population, while in the monocities themselves, about 10% of the country's population and about 17% of the urban population live.

Industrial and territorial structure of monotowns in CIS is extremely diversified. However, it is worth mentioning that the majority of multi-profile municipal establishments are small towns with the population of less than 50 thousand people and with the specialization in extracting and processing mineral resources.

Modern branch specialization of single-industry cities of Kazakhstan, one way or another, is connected with the mining industry. 24 settlements appeared as a result of the beginning of the development of oil, gas, ferrous and non-ferrous metal ores, asbestos and phosphorites. At present, the development of 21 monotowns in Kazakhstan is connected with the mining towns. In the branch structure of single-industry towns of Belarus, the number of settlements is dominated by woodworking, the production of building materials, the food industry, peat and peat briquetting industry. And in terms of the population employed in production, the leading industries are chemistry and petrochemistry, and machine building and metalworking. In Russia, mono-settlements dominate with town-forming enterprises of ferrous and non-ferrous metallurgy (36.1%), machine building (24.0%), and fuel and energy mineral resources (12.3%). [3]

In the early 1990s, most of the single-industry settlements of the CIS countries (like other cities) found themselves in a difficult situation due to the disruption of production chains created during the planned economy in the USSR, a significant decline in production, and increased non-competitiveness of products. A high share of non-core assets in the ownership of enterprises resulted in a decrease in the level of socio-economic development of single-industry towns and led to a deterioration in the quality of life of their population. The problems of single-industry towns became particularly acute due to the impact on the country's economy of the global financial and economic crisis of 2008. [10,11] Three categories of single-industry cities were singled out, depending on the risks of deteriorating their socio-economic situation. In the most difficult situation, 31% and 11% of Russia's and Kazakhstan's monocities are located, respectively. Almost 40% of Russia's monocities have risks of deteriorating the situation (while in Kazakhstan only 19%). In the most difficult social and economic situation, there were cities of raw specialization of the northeastern regions of Russia and the old industrial regions of the Urals and the South of Siberia, specializing in the basic branches of the economy - energy, ferrous and non-ferrous metallurgy, general and medium engineering.[10]

The state's participation in the development of single-industry towns in Russia is carried out in a variety of passive and active forms of supporting social and economic development.

From the point of view of the support mechanisms, the Russian government has completely abandoned the direct budget financing of mono-city support measures, used during the financial and economic crisis of 2008-2009. (Table 2)

Table 2. Measures to support mono-profile municipal entities of the Russian Federation (single-industry towns))

State structure that supports	Support mechanisms
Ministry of Economic Development of the Russian Federation	Creation of territories for advanced development Support of small and medium business Support investment projects on the basis of project financing
Non-commercial organization "Montowns City Development Fund"	Co-financing measures for the construction and (or) reconstruction of the infrastructure required for the implementation of new investment projects in single-industry towns Performance of the project office functions Formation of project management teams for single-industry towns
Ministry of Industry and Trade of the Russian Federation	Subsidizing producers
Ministry of Labour and Social Protection of	The implementation of additional measures in the field of

the Russian Federation	employment, aimed at reducing tension in the labor market of the subjects of the Russian Federation, including single-industry towns
Ministry of Agriculture of the Russian Federation	A subsidy from the federal budget to the budgets of the constituent entities of the Russian Federation to recover part of the costs of paying interest on loans received from Russian credit institutions and loans received from agricultural consumer credit cooperatives
Ministry for the Development of the Russian Far East	Support of measures on the balance of labor resources Support investment projects in the Far East
Ministry of North Caucasus Affairs	State guarantee of the Russian Federation
Fund for Assistance in Reforming Housing and Communal Services	Modernization of public infrastructure systems by providing financial support for interest rate subsidies
Ministry of Industry and Trade of the Russian Federation (industrial parks) и Ministry of Communications and Mass Media of the Russian Federation (Technoparks in the field of high technology)	Support of subjects of the Russian Federation implementing projects on the creation of industrial parks and technoparks
Industrial Development Fund	Target loans at 5% per annum
Ministry of Culture of the Russian Federation (Federal Agency for Tourism)	Creation and reconstruction of objects of cultural heritage and tourist infrastructure, carrying out various actions on the territories of single-profile municipal formations (single-industry towns)
Ministry of Sport of the Russian Federation	Subsidies from the federal budget
Joint Stock Company "Federal Corporation for the Development of Small and Medium-Sized Enterprises" (SME Corporation)	Guarantee support for SME entities registered in single-profile municipal entities of the Russian Federation (monotown) under the Rules for Interaction of Banks with SME Corporation JSC when selecting and providing independent guarantees.
Agency for Strategic Initiatives	The introduction successful practices aimed at introducing changes in all single-industry towns,
State Corporation "Bank for Development and Foreign Economic Affairs (Vnesheconombank)"	Implementation of investment projects aimed at developing single-profile municipal entities Placement of information on investment opportunities for single-industry towns on the Investment Portal of the Russian regions
Joint-Stock Company "Russian Bank for Small and Medium Enterprises Support")	Credit product "SME - Region" Insurance for export credits and investments

State Specialized Russian Export-Import Bank (Joint-stock company)	Finance support and guarantee for the Russian non-resource export (to meet exporters' varied needs of financing export transactions and supporting export activity)
--	---

The most effective is the activity of Vnesheconombank and the non-commercial organization "Fund for Development of Monotowns" established in October 2014. [2] In general, Vnesheconombank provided support in 48 mono-towns for the period from 2011 to 2015 and achieved the following results:

- Reduction in the average level of registered unemployment from 2.69% to 1.88%;
- Creation of 122 thousand additional permanent jobs;
- Attraction of extra-budgetary investments in the amount of 458.05 billion rubles.

The Mono-Grove Development Fund in 2015 received approvals regarding 25 monotowns located in 17 regions of Russia. The volume of the Fund's commitments to co-finance the expenditures of the constituent entities of the Russian Federation and the municipal entity amounted to about 5 billion rubles, and the volume of attracted investments in the single-industry town was supported by a subsidy of 8 billion rubles. [12]

Another new mechanism for supporting single-industry towns is the creation of territories for outpacing socio-economic development (TOP). This tool is focused on creating zones - the locomotives of growth and directly appeals to the Chinese experience of the revival of problem areas, based on an integrated combination of finance, investment, innovation and land policies.

It should be noted that the effectiveness of the application of reorganization and recovery procedures of bankruptcy in Russia has always been higher for strategic enterprises (these are federal state unitary enterprises and open joint-stock companies whose shares are in federal ownership and which produce goods (works, services), which are of strategic importance). Such enterprises, as a rule, are state-owned and produce products aimed at ensuring the security and defense capability of the country. [14]

In July 2016, the Council for Strategic Development and Priority Projects under the President of the Russian Federation singled out 11 national projects, the implementation of which has a strategic status for the state. One of these strategic areas is the modernization of single-industry towns. This will solve the problem of the lack of interconnections and coordination of policies to support single-industry towns and socio-economic policies of the country as a whole, both at the level of development of planning and program documents, and at the level of state strategy. In order to implement it fully, the main objectives of the project were formulated: diversify the economy of single-industry towns; create conditions for attracting investments and developing business; create new jobs; make monotowns comfortable for life.

The national project "Modernization of single-industry towns" covers 319 cities in 60 regions of the Russian Federation in all eight federal districts. A large-scale program should show the first results in the nearest future. Under the leadership of the Chairman of the Government of the Russian Federation DA Medvedev, specific target indicators of the program "Integrated Development of Monotowns" were defined. Until the end of 2018, the project should: create more than 200 thousand jobs, not associated with the city-forming enterprise; Attracted investments in fixed assets in the amount of 317 billion rubles; Significantly improved the quality of the urban environment.

In Kazakhstan, activities to organize the support of single-industry towns developed within a certain logical continuity. A serious deterioration of the economic situation, on the one hand, sharply reduced the state resources used for the recovery of single-industry towns, and on the other hand, increased the risks of deterioration of their economic situation. In these conditions, in 2015, a decision was made to integrate various programs into a single program that combined such programs as "Affordable Housing-2020", "Housing Utilities Modernization Program for 2011-2020", "AkBulak", "Program Development of single-industry towns for 2012-2020" and "Regional Development Program". Such a combination made it possible to exclude a number of overlapping issues (for example, the development of engineering communications). Microcredit, grants and other opportunities for state support of business are now included in the program "Business Roadmap-2020". [7]

The problems of monotowns are very serious. There is a need for a significant increase in the effectiveness of governmental support allowing for the real social and economic situation in the monoprofile municipal establishments.

The priority goal of the governmental support targeted at modernizing monotowns is diversification of monotowns' economy, creation of alternative jobs, attraction of investments. The main forms of support to the social and economic development of CIS towns are the method of targeted programme ('Programme of Monotowns Development for 2012-2020' in Kazakhstan) as well as the performance of development institutes such as State Corporation "Bank for Development and Foreign Economic Affairs (Vnesheconombank)", OAO Russian Venture Company - the Russian government's fund of funds and the development institute of the Russian Federation, OAO Rosinfocominvest - 'Russian investment fund for information-communication', RUSNANO Group, non-commercial organization 'Monotowns Development Fund'.

The analysis of specialized institutes' performance and the effectiveness of governmental programmes leads to a conclusion about the necessity of increasing the effectiveness of governmental support at all the stages from the development of legally adopted criteria for the status 'monotown', which are to take into account not only formal indicators but also the actual social and economic

situation in monoprofile municipal establishments, to determining the priority investment projects supported in monotowns.

Kazakhstan has a higher degree of continuity in the mechanisms of state policy. While in Russia there is a constant change in the criteria for the allocation of single-industry towns - the objects of state support, there is no clear administration of the activities of the state apparatus in this direction, there is a significant number of poorly coordinated operators and financing channels; the share of cities receiving specialized support in the total number of this type of settlements is extremely small.

The analysis of the work of specialized institutions and the effectiveness of government programs make it possible to conclude that there is a need to increase the effectiveness of state support measures, from developing legislatively fixed criteria for obtaining monotown status, taking into account not only formal signs, but also the real socioeconomic situation in single-profile municipalities and up to Determination of priority investment projects supported in single-industry towns.

The cities of both Russia and Kazakhstan act primarily as a passive object of state support. Thus, in Kazakhstan, the development of integrated plans for the development of single-industry towns is directly implemented by regional executive bodies with little involvement of municipalities. In Russia, local self-government bodies are more actively involved in the development of I& C, but in this case, the limited local resources and powers do not allow taking full responsibility for the development of the territory.

## REFERENCES

- Egorova O.A., 2012, Organizacionno – jekonomicheskie osnovy funkcionirovanija monoprofil'nyh gorodov v Rossijskoj Federacii [jelektronnyj resurs] // Regional'naja jekonomika i upravlenie: jelektronnyj nauchnyj zhurnal, 2012. - № 3 (31). - № gos. reg. stat'i 0421200035/. // URL:<http://region.mcnp.ru>
- Gosudarstvennaja podderzhka modernizacii jekonomiki monogorodov. [jelektronnyj resurs] // URL: <http://www.veb.ru/strategy/mono/supp/>
- Krejdenko T.F., Rodionova I.A. Monogoroda stran SNG: kriterii, struktura, rol' v sovremennoj jekonomike.// Transformacija social'no-jekonomicheskogo prostranstva Evrazii v postsovetskoe vremja [Tekst]: sbornik statej /otv.red. N.I.Bykov, D.A.Dirin. – Barnaul: Izd-vo Alt. Un-ta, 2014. – Tom 1. – S. 333-343
- Informacionno-pravovaya sistema «Zakonodatelstvo stran SNG» //Ofitsialnyy internet-sajt [Elektronnyy resurs]. – Rezhim dostupa: <http://www.spinform.ru/>
- Monogorod: upravlenie razvitiem [Tekst] / T.V. Uskova, L.G. Iogman, S.N. Tkachuk, A.N. Nesterov, N.Ju. Litvinova /Pod red. d.je.n. T.V. Uskovej. – Vologda: ISJeRT RAN, 2012. – 220 s.
- Monoprofil'nye goroda I gradoobrazujushhie predpriyatija [jelektronnyj resurs] // Sojuz investorov [sajt]. // URL: [http://www.unioninvest.ru/city\\_mong.html](http://www.unioninvest.ru/city_mong.html).
- Programma razvitiya monogorodov na 2012-2020 godyi //AO «Fond razvitiya predprinimatelstva «Damu»». Ofitsialnyy internet-sajt [Elektronnyy resurs]. – Rezhim dostupa: <http://www.damu.kz/>
- Rakova E., fon Bodelshving A., fon Kramon-Taubadel A. Osnovnyeproblemyiinaprvleniyarestrukturizatsiigradoobrazuyuschihpredpriyatij v Belarusi /Analiticheskaya zapiska Issledovatel'skogo tsentra IPM //Issledovatel'skiy tsentr IPM. Ofitsialnyy internet-sajt [Elektronnyyresurs]. – Rezhimdostupa: <http://www.research.by/>

Rodionova I.A., Kreydenko T.F. Monogoroda Rossii na sovremennom etape //Geografiya mirovogo hozyaystva: regionalizm v usloviyah globalizatsii: materialy IV Mezhdunarodnoy nauchno-prakticheskoy konferentsii: v 3 ch./otv. red. V.N.Holina, chast 2. - Moskva: Izd-vo RUDN, 2013. S. 255-261.

Roenko E.A. (Shibanova-Roenko E.A.), 2012, Krizisimono gorod: kto kogo? (polnotekstovyy variant) / Regiony Rossii: Strategii i mehanizmy modernizatsii, innovatsionnogo i tehnologicheskogo razvitiya. Tr. Vos'moj mezhdunar. nauchn.-prakt. konf. / RAN. INION. Otd. nauchnogo sotrudnichestva I mezhd. svyazey /Otv. red. Ju.S. Pivovarov. – M., 2012. – Ch. 2. – S.260-265. ISBN 978-5-248-00661-8

Social'nye problem monopofil'nogo goroda kak obekt gosudarstvennogo analiza: monografija/ N.V Gubina [i dr.]; obshh. red. N.V. Gubinoj. [Tekst]- Nizhnekamsk: Nizhnekamskij himiko-tehnologicheskij institut (filial) FGBOU VPO «KNITU», 2012. – 280 s.

The official website of the state corporation “Bank for Development and Foreign Economic Affairs (Vneshekonombank)”. // URL: <http://www.veb.ru>

Yashina G. Monogoroda: neobhodim individualnyiy podhodi innovatsionnoe reshenie //Federalnoe internet izdanie Kapitalstranyi. Ofitsialnyiy internet-sayt [Elektronnyiy resurs]. – Rezhim dostupa: <http://kapital-rus.ru/index.php/articles/article/176782>

Turgel I, Bozhko L., Xu Linshui. Government support of single-industry towns in Russia and // Bulletin of the Financial University, №2 (92), 2016 c. 22 – 32

## INTEGRATED REPORTING AND PREPARERS' ACCOUNTABILITY: A MATTER OF CONTEXT

Lai, Alessandro<sup>1</sup>; Melloni, Gaia<sup>2</sup>; Stacchezzini, Riccardo<sup>1</sup>

<sup>1</sup>Dept. of Business Administration, University of Verona, Verona, Italy

<sup>2</sup>Norwich Business School, University of East Anglia, Norwich, UK

### ABSTRACT

This research explores view(s) of corporate accountability that are implicit in integrated reporting (IR). The empirical setting features a global insurance company that pioneered IR in its 2012 annual financial report. Several in-depth interviews with the IR “preparers” from this firm depict how its IR has been built, as well as the contextual conditions underlying the decision to shift from financial reporting to IR. The results also reveal the predominance of investors’ (vs. stakeholders’) accountability, particularly in reference to addressees of corporate accountability in the IR. This paper offers new insights for literature dealing with corporate reporting and accountability in a novel, integrated reporting setting.

*Keywords: Integrated Reporting, Accountability, Investors, Reporting preparers.*

### AIM AND THEORETICAL FRAME

This paper seeks to respond to calls for case research on integrated reporting practices (de Villiers et al., 2014, de Villier et al., 2015, Perego et al., 2016) by empirically exploring the implementation of integrated reporting (IR)<sup>5</sup> by an Italian listed insurance company operating worldwide. The company, Assicurazioni Generali S.p.A. (hereafter, Generali or the Company), is a pioneer of IR, in accordance with the project established by the International Integrated Reporting Council (IIRC) in 2011. It joined the IIRC pilot programme in 2012, actively participates to two IIRC business networks (i.e. insurance network and national network of Italian IR adopters), and has already published three annual IRs (2013, 2014, and 2015) that adopt the international Integrated Reporting Framework (IIRF) principles issued by the IIRC (IIRC, 2013).

A number of studies offer in-depth assessments of IR practices (e.g. articles published in 2014 in the Accounting, Auditing and Accountability Journal special issue on integrated reporting), but to the best of our knowledge, no previous research has empirically investigated the view(s) of accountability that

---

<sup>5</sup> We use the acronym “IR” to refer both to integrated reporting, or the process of preparing an integrated report, and to the integrated report, which represents the “outcome” of this process. The context determines whether the acronym refers to integrated reporting or reports in each instance.



are embedded in the process of IR preparation. We therefore aim to analyse the discourses of IR preparers (i.e. persons responsible for and/or daily involved in the preparation of the IR) on the IR implementation.

According to the IIRC, IR should enhance accountability and stewardship for a broad base of capital (IIRC, 2013). With its focus on multiple “capitals” (e.g. human, natural, social) and other non-financial subjects, IR may offer accountability to a wide plethora of stakeholders. However, critics question the possibility that IR can cover stakeholder accountability (Brown and Dillard, 2014; Flower, 2015; Thomson, 2015). The primary focus of IR on capital providers’ information needs could mean that it does not necessarily address the decision-making and accountability needs of stakeholding publics (Brown and Dillard, 2014). Compared with the Global Reporting Initiative, the IIRC’s proposals are “remarkably regressive,” with a strong investor bias and possibilities only for “investor accountability,” and no attempt to discuss issues around corporate sustainability (Milne and Gray, p. 25). In other words, if IR is intended to discharge the duties of accountability for the responsibilities most closely connected to the investors, its potential to help stakeholders understand nonfinancial impacts and hold managers accountable for them may be constrained (de Villiers et al., 2014). We empirically address this issue and explore how IR preparers come to select corporate accountability content, by reasoning about the subjects disclosed in the IR (i.e. what), the language used (i.e. how), and the IR addressees (i.e. to whom).

In turn, we describe how the “production” process for the IR text (here, the process of determining what is said and not said and who will be addressed by the report) depends on the organizational context and, more broadly, the reporting context in which the text gets produced, acknowledging the “inseparable relationship between the text and context” of organizational reporting and communication (Tregidga et al., 2012, p. 226). The socio-linguistic approach depicted by the linguist Teun A. van Dijk led us to avoid interpreting the context as an “objective” social variable and instead suggested the consideration of subjective mental constructs that define and give relevance to such context (Van Dijk, 2006, 2008 and 2009). We take inspiration from this approach and focus our empirical analysis on understanding how the view(s) of accountability that are implicit in IR preparers’ discourses are influenced by their interpretations of the contexts in which the preparation of the IR text takes place.

## **METHODOLOGY**

For the discourse analysis underlying this research (Gill, 2000; Jørgensen and Phillips, 2002; Van Dijk, 2009), we rely on in-depth interviews with managers and employees of the Company. The interviews were developed to discern not only the motivations for the decision to adopt IR but also how IR

preparers ponder “what is said and what is not said” and “how it is said” (Tregidga et al, 2012, p. 226). The IR itself is a report that is largely informed by a principle-based framework and thus is flexible in terms of its specific content (IIRC, 2013).

The interviews took place in dedicated meetings with the authors or following IR presentations offered to various panels (e.g. public presentations, insurance group meetings, university presentations to students, televised debates). The interviewees received extensive information about the research purpose, and their privacy and anonymity was carefully respected, especially when citing the content of their speech to other interviewees and Company members. The authors obtained permission to record the interviews digitally and use these responses for research purposes. If interviewees requested that we delete selected portions of their delivered answers, we did so. The interviews also were manually transcribed in the language in which they took place (English or Italian).

Recognizing concerns about the methodological rigour and subjectivity of discourse analyses (Grant et al., 2001; Hardy, 2001; Phillips and Hardy, 2002), we took several steps to ensure subsequent traceability of the research method. The transcriptions of the interviews were coded according to a general coding framework underlying the research. The coding criteria captured three main accountability contents to be investigated (Ezzamel et al., 2007; Fowler and Cordery, 2015): the subjects inserted and explained in the IR (what), the language of the IR (how), and the intended addressees of (the messages contained in) the IR (to whom). We collected all sentences that referred to each of these three issues, independent of the interviewees, then relied on further distinctions that we developed to classify them into more specific, homogeneous topics. Some of the issues evident in the interviews appeared to be linked in intertwined messages, such that discourses about two or more issues were present together. We tried to disentangle the intertwined discourses related to multiple issues, to better detail each of the main issues associated with the accountability content.

Finally, we coded all the sentences referring to two themes (“text” and “context”) to clarify the preparers’ cognitive processes for constructing the text while also considering the social context in which it was produced (Van Dijk, 2009). In this phase, we investigated three types of additional sources: (a) the “text” in the form of IRs produced by the Company for the 2012 to 2015 financial years; (b) secondary sources pertaining to the “context” (information about the organizational structure and governance system of the Company, the insurance sector, and the IIRC); and (c) previous research on corporate reporting and accountability issues. This step improves comprehension of the views shared within the Company by the IR preparers.

## PRELIMINARY FINDINGS AND RESEARCH CONTRIBUTIONS

The analysis shows that the view of accountability embedded in the preparation of the IR is investors'. Specifically, the choice of subjects in the IR focuses primarily on financial and strategic issues rather than nonfinancial or sustainability questions. In addition, the discourses of IR preparers stress that the IR (i.e. text) reflects several contextual factors: complaints from investors and capital providers about the complexity of traditional annual reports; a lack of interest among shareholders in "soft" (narrative or nonmonetary) sustainability information; and the separation of financial and sustainability units within Generali. In this respect, the empirical analysis reveals the preparers' reasoning regarding accountability content and how this process depends on their interpretation of the context(s) in which the IR is "produced". Finally, empirical evidence sheds light on the dominance of investors' accountability, as the primary addressees of accountability in the IR.

With this empirical stance, this article responds to calls for more case research on IR implementation by highlighting the role of practitioners in informing the text. Previous research mostly describes the role of organizational and institutional factors in the IR adoption process (e.g. Frias-Aceituno et al., 2013a and 2013b; Lai et al., 2016; Vaz et al., 2016). The present study elucidates the need to pinpoint the mediating role of preparers in terms of how the report is prepared—particularly with reference to how these actors consider the organizational and reporting contexts while writing the text.

This paper also can contribute to the debate about the relationships between IR and accountability. Previous research has investigated how IR may allow companies to provide accountability for subjects that have not traditionally been addressed by financial reporting (e.g. value creation process, sustainability, capitals) and what classes of stakeholders may benefit from IR (e.g. investors, other stakeholders) (Adams, 2015; Flower, 2015; Milne and Gray, 2013). These prior studies have been more conceptual in nature, addressing relationships in terms of how the IIRF might inform the content of accountability provided by companies; the present study instead offers a field-based investigation.

Finally, this article contributes to the more general debate about the future of corporate reporting. Regulators, practitioners, and academics increasingly are involved in discussions of how to improve corporate reporting (e.g. KPMG, 2012; EY, 2013; Deloitte, 2015; PwC, 2015). The "meanings" and "means" of "better" reporting also continue to come under scrutiny (Sunder, 2016; Beattie, 2014). This contribution to the debate testifies to how practitioners, and preparers in particular, are working to improve corporate reporting and why they consider IR "better" than more traditional forms of external reporting (e.g. financial reports). In this respect, this study intercepts the academic discussion about the "narrative turn" in accounting practice and research (Beattie, 2014). More broadly, it addresses the call for more (interpretative) research on corporate reporting practices and practitioners (Hopwood, 2000; Young, 2006; Huikku et al., 2016).

## REFERENCES

- Adams, C. A. (2015): The international integrated reporting council: a call to action, *Critical Perspectives on Accounting*, Vol. 27, 23-28.
- Beattie, V. (2014): Accounting narratives and the narrative turn in accounting research: Issues, theory, methodology, methods and a research framework, *The British Accounting Review*, Vol. 46, No. 2, 111-134.
- Brown, J. & Dillard, J. (2014): Integrated reporting: On the need for broadening out and opening up, *Accounting, Auditing & Accountability Journal*, Vol. 27, No. 7, 1120-1156.
- de Villiers, C.; Rinaldi, L. & Unerman, J. (2014): Integrated Reporting: Insights, gaps and an agenda for future research, *Accounting, Auditing & Accountability Journal*, Vol. 27 No. 7, 1042-1067.
- de Villiers, C.; Rinaldi, L. & Unerman, J. (2015): Special issue on Case study insights from the implementation of Integrated Reporting, <http://www.emeraldgrouppublishing.com/authors/writing/calls.htm?id=6194>
- Deloitte (2015): Integrated Reporting as a driver for Integrated Thinking?, <https://www2.deloitte.com/content/dam/Deloitte/nl/Documents/risk/deloitte-nl-risk-integrated-reporting-a-driver-for-integrated-thinking.pdf>.
- Ezzamel, M., Robson, K., Stapleton, P., & McLean, C. (2007). Discourse and institutional change: 'giving accounts' and accountability. *Management Accounting Research*, Vol. 18, No. 2, 150-171.
- EY (2013): Integrated Reporting. Communicating Sustainable Value Creation. [http://www.ey.com/Publication/vwLUAssets/Integrated\\_reporting\\_-\\_Communicating\\_sustainable\\_value\\_creation/\\$FILE/EY-Integrated-Reporting.pdf](http://www.ey.com/Publication/vwLUAssets/Integrated_reporting_-_Communicating_sustainable_value_creation/$FILE/EY-Integrated-Reporting.pdf).
- Flower, J. (2015): The international integrated reporting council: a story of failure, *Critical Perspectives on Accounting*, Vol. 27, 1-17.
- Fowler, C. J., & Cordery, C. J. (2015). From community to public ownership: a tale of changing accountabilities. *Accounting, Auditing & Accountability Journal*, Vol. 28, No. 1, 128-153.
- Frías-Aceituno, J. V.; Rodríguez-Ariza, L. & García-Sánchez, I. M. (2013a): Is integrated reporting determined by a country's legal system? An exploratory study, *Journal of cleaner production*, Vol. 44, 45-55.
- Frias-Aceituno, J. V.; Rodriguez-Ariza, L. & Garcia-Sanchez, I. M. (2013b): The role of the board in the dissemination of integrated corporate social reporting, *Corporate Social Responsibility and Environmental Management*, Vol. 20, No. 4, 219-233.
- Gill, R. (2000): Discourse Analysis, in Bauer, M.W. & Gaskell, G. (eds.): *Qualitative Researching with Text, Image and Sound: A Practical Handbook*, London: Sage, 172-190.
- Grant, D.; Keenoy, T. & Oswick, C. (2001): Organizational discourse: Key contributions and challenges, *International Studies of Management and Organization*, Vol. 31, No. 3, 5-24.
- Hardy, C. (2001): Researching organizational discourse, *International Studies of Management and Organization*, Vol. 31, No. 3, 25-47.
- Hopwood, A. G. (2000): Understanding financial accounting practice, *Accounting, Organizations and Society*, Vol. 25, No. 8, 763-766.
- Huikku, J.; Mouritsen, J. & Silvola, H. (2016): Relative reliability and the recognisable firm: Calculating goodwill impairment value, *Accounting, Organizations and Society*, in press doi:10.1016/j.aos.2016.03.005
- International Integrated Reporting Framework (2013): The International <IR> Framework, <http://integratedreporting.org/wp-content/uploads/2013/12/13-12-08-THE-INTERNATIONAL-IR-FRAMEWORK-2-1.pdf>.
- Jensen, J. C. & Berg, N. (2012): Determinants of traditional sustainability reporting versus integrated reporting. An institutionalist approach, *Business Strategy and the Environment*, Vol. 21, No. 5, 299-316.
- Jørgensen, M. & Phillips, L. (2002): *Discourse analysis as theory and method*, London: Sage.
- KPMG (2012): Integrated Reporting Performance insight through Better Business Reporting, <https://www.kpmg.com/Global/en/IssuesAndInsights/ArticlesPublications/Documents/road-to-integrated-reporting.pdf>.
- Lai, A.; Melloni, G. & Stacchezzini, R. (2016): Corporate sustainable development: is "integrated reporting" a legitimization strategy?, *Business strategy and the environment*, Vol. 25, No. 3, 165-177.
- Milne, M. J. & Gray, R. (2013): W (h)ither ecology? The triple bottom line, the global reporting initiative, and corporate sustainability reporting, *Journal of business ethics*, Vol. 118, No. 1, 13-29.
- Perego, P.M.; Kennedy, S.P. & Whiteman, G.M. (2016): A lot of icing but little cake? Taking Integrated Reporting forward, *Journal of Cleaner Production*, doi:10.1016/j.jclepro.2016.01.106.
- Phillips, N. & Hardy, C. (2002): *Discourse Analysis: Investigating processes of social construction*, Thousand Oaks: Sage.

- PwC (2015): Implementing Integrated Reporting, <https://www.pwc.com/gx/en/audit-services/publications/assets/pwc-ir-practical-guide.pdf>.
- Sunder S. (2016), Better financial reporting: meanings and means, *Journal of Accounting and Public Policy*, Vol. 35, No. 3, 211-223.
- Thomson, I. (2015): 'But does sustainability need capitalism or an integrated report' a commentary on 'The International Integrated Reporting Council: A story of failure' by Flower, J., *Critical Perspectives on Accounting*, Vol. 27, 18-22.
- Tregidga, H.; Milne, M. & Lehman, G. (2012): Analyzing the quality, meaning and accountability of organizational reporting and communication: Directions for future research, *Accounting Forum*, Vol. 36(3), 223-230.
- Van Dijk, T. A. (2006): Discourse, context and cognition, *Discourse Studies*, Vol. 8, No. 1, 159-177.
- Van Dijk, T. A. (2008): *Discourse and context. A sociocognitive approach*, Cambridge: Cambridge University Press.
- Van Dijk, T. A. (2009): *Society and discourse. How Social Contexts Influence Text and Talk*, Cambridge: Cambridge University Press.
- Vaz, N.; Fernandez-Feijoo, B. & Ruiz, S. (2016): Integrated reporting: an international overview, *Business Ethics: A European Review*, <http://onlinelibrary.wiley.com/doi/10.1111/beer.12125/epdf>.
- Young, J. J. (2006): Making up users, *Accounting, Organizations and Society*, Vol. 31, No. 6, 579-600.

## HOW INTEGRATED REPORTING MEETS THE INVESTORS AND OTHER STAKEHOLDERS' INFORMATION NEEDS

Lai, Alessandro; Rossignoli, Francesca; Stacchezzini, Riccardo

Dept. of Business Administration, University of Verona, Verona, Italy

### ABSTRACT

The external corporate reporting is currently debated both in the professional and the academic contexts, given the misalignment between information provided by companies and real information needs from investors and other stakeholders. Such misalignment seems to be reducible by the integrated report, as proposed by the International Integrated Reporting Council (IIRC). Such report, that is already mandatory in some countries, is raising rich interest from scholars and practitioners: several companies around the world are already preparing their integrated report.

The research is aimed to verify whether and how such report can really contribute to the corporate reporting and to the relationships among the people belonging to the corporate environment. Along this way, the research is aimed to answer to the following research question: *how integrated report favours the alignment between corporate reporting and stakeholder's informative needs?*

In order to answer such research question, qualitative and quantitative approaches will be jointly used to analyse: *a) the investors and other stakeholders' information needs; b) the companies behaviour related to the integrated report preparation; c) the reactions of investors and other stakeholders to the first integrated report initiatives; d) the role of standard setters and regulators in encouraging the institutionalization of the integrated report and the gradual alignment of the integrated report to the stakeholders' needs.*

The most relevant scientific impact is related to the identification of the interaction processes and the reciprocal influence among actors involved in the regulation, preparation and use of the integrated report within the reporting environment.

*Keywords: Integrated Report; Investors; Corporate reporting environment; Sustainability reporting; Non-financial information*

### SCENARIO FOR INVESTIGATION

Global and national business theories and practice:  
bridging the past with the future

ISSN: 2547-8516  
ISBN: 978-9963-711-56-7

The corporate reporting is the main way through which companies communicate their performance to stakeholders.

Such tool is currently debated both in the professional and in the academic context. The “traditional” corporate reporting is unsuitable to provide information about company strategy, future perspectives and the social and environmental impact of the company activity. The social, environmental and sustainability report is often criticized to be just a window dressing, unsuitable to truly represent company’s efforts towards social responsibility.

The misalignment between information provided by companies and the real information needs from investors and other stakeholders is palpable, since the latter are more and more sensitive to complementary information that complete the financial ones. Standard setters and regulators are working to fill such gap. Some examples are: the International Accounting Standard Board (IASB) project related to the narrative disclosure within the financial statement, the Global Reporting Initiative (GRI) projects related to the sustainability disclosure, the United Europe Regulation about the non-financial disclosure, etc. All these initiatives taken together are laying the foundations to renew the boundaries between mandatory and voluntary disclosure and to make the financial disclosure converge toward the non-financial one (that is the sustainability one).

The project about the integrated reporting coordinated by the International Integrated Reporting Council (IIRC) seems to be suitable to enhance the convergence process and alignment between corporate reporting and information needs of investors and other stakeholders. Such project aimed to stimulate companies to communicate their value creation process joining information related to: governance, strategy, business model, different “capitals” (financial, human, productive, social and relational, etc.), performance, risks and future perspectives.

Several companies around the world are already voluntarily preparing the integrated report in addition to the firms that have to prepare it mandatorily (i.e. South-African public listed companies). For many companies the integrated report is already part of the institutional corporate communication and it is presented and discussed with investors and stakeholders.

## **EXTANT STUDIES**

Since the original initiatives of integrated report, the international literature and specifically the accounting one, put great interest in such report. Several aspects have been explored, at least conceptually, and there are many call for future researches (Busco et al., 2013; de Villiers et al., 2014).

A debated issue is related to the integrated report goals and, in particular, the sustainability contents. Critics argue that the IIRC has gradually changed the framework objectives following investors’ needs

and ignoring stakeholders needs (Flower, 2015) and that the integrated report has nothing to say about sustainability (Milne and Gray, 2013). Other scholars assert that, given the IIRC guidelines, the integrated report can anyway enrich the sustainability disclosure and the integration between internal and external disclosure (Busco et al., 2013; Adams, 2013 and 2015; Eccles and Krzus, 2010).

Some researchers have investigated determinants of the integrated reporting adoption, explaining it in relation to institutional factors (Jensen and Berg, 2012; Frías-Aceituno et al., 2013), industries features (Frías-Aceituno et al., 2014) and corporate governance characteristics (Frías-Aceituno et al., 2012). Furthermore the integrated report adoption has been linked to the needs of external legitimization towards the analysts (Lai et al., 2014a). A recent study (Reuter and Messner, 2015) has highlighted the lobbying activities forcing the IIRC initiatives.

Some scholars have analytically investigated the integrated reporting content of the companies participating to the IIRC project. Some analyses have stressed the alignment process of the reports towards the IIRC guidelines with specific focus on the: sustainability disclosure (Lai et al., 2014b), business model (Melloni et al., 2015; Lai et al., 2015), intellectual capital (Melloni, 2015) and risks (Melloni and Stacchezzini, 2013). Further analyses have examined the organizational implication of the report adoption (Busco et al., 2013; Stent and Dowler, 2015).

To the best of our knowledge no previous studies have explored how the integrated report contributes to satisfy the growing and different information needs of investors and stakeholders. In particular, the literature has not yet studied whether and how the integrated report can impact on the relationships among three categories of actors within the reporting environment: 1) companies and their managers; 2) investors and stakeholders (among them analysts); 3) regulators and standard setters. This work aims to fill such gap, highlighted by several special issues of outstanding international journal.

## **RESEARCH AIM**

The research analyses the integrated report role within the recent redefinition of the boundaries between mandatory and voluntary disclosure and of convergence between financial and sustainability disclosure.

The aim is to understand the impact of such report on the reciprocal interdependence relationships among the decisions of the main actors within the reporting environment. The objective is expressed in the following research question: *how the integrated report favours the convergence between corporate report and information needs of the stakeholders?*

## **METHODS**

Global and national business theories and practice:  
bridging the past with the future

ISSN: 2547-8516  
ISBN: 978-9963-711-56-7



The research embraces three levels of analysis. The first level is the “individual” one and consists in the analysis of the individual behaviours and perceptions of people constituent the corporate environment. The second level is the “relational” one and it analyses how the integrated report changes the relationships among different subjects. Such relationships are caught in case of meeting and debate among the different subjects and in the consequences of their behaviours. The third level of analysis is the “total” one: it provides a summary of the integrated report impact on the corporate environment.

Qualitative and quantitative approaches will be jointly used to analyse each level of analysis: the former will be used to investigate analytically the individual actors behaviours and the relationships among them; the latter will be used to analyse widely the behaviours of different subjects. In detail:

- a) Qualitative approaches aim to identify case study to be deeply investigated, through interviews to individual subject and focus group where different actors categories are jointly involved. We plan to interview the main subjects operating within the IIRC and top managers (CFO, CEO, etc.), managers and directors (administrative director, investor relator, etc.) of pioneer companies in the integrated report, partners and managers of consultant companies and external audit companies, etc. Empirical evidence on the field in addition at public and private documentation will support the case study development. The study will be carried out within proper critical and interpretative frameworks.
- b) Quantitative approaches will be used to collect data – trough survey, content analysis of public and private documents, database – and to elaborate them with proper statistic methods. The survey will be aimed to catch actors perception related to: *i)* the degree of misalignment between corporate reporting and stakeholders’ information needs; *ii)* the integrated report ability to reduce such misalignment; *iii)* the most relevant information categories in reducing such misalignment.

Qualitative approaches will be used in a contained setting: the research field is the Italian and UK corporate environment, such as to deeply study the integrated report of Italian and UK companies as well as the impact of them on the relations among the subjects belonging to such context. The case studies will be aimed to provide empirical evidence of the integrated reporting impact on the relationships between the preparers and their main stakeholders.

Quantitative approaches will be used on a wide setting, in order to collect information about the main disclosure profiles from the integrated reports currently available all over the world.

Quantitative approaches will be used in a smaller research field to provide an interpretation of the integrated report impact on the Italian and UK corporate environment. For example, we will code the information subsumed in the available integrated report and we will correlate such information to the

perceptions and/or evaluations of the analysts in order to identify eventual relations between the information provided in the integrated report and the analysts' perceptions.

The innovativeness of the research at the methodological level is related to: *i)* the joint use of qualitative and quantitative approaches and the application of them to analyse a corporate reporting tool that is still unexplored compared to the traditional and *ii)* the direct and joint involvement of different categories of subject pertaining the corporate environment. While the extant literature has given priority to analysis focused on single categories of subjects, this research will make different subject meet and debate during focus groups.

## EXPECTED FINDINGS AND RESEARCH IMPLICATIONS

The analysis is expected to highlight:

- The information needs of investors and stakeholders in terms of what are the information categories that are judged as to be the most relevant in expressing their own consensus (or dissent) referring to the companies activities and performance;
- The companies' behaviour referring to the integrated report preparation. The analysis will show: *a)* the reasons leading to choose to prepare the integrated report; *b)* the integrated report content, respect to the IIRC guidelines and to the information needs of investors and stakeholders; *c)* the organizational implications related to such adoption, verifying what are the company areas involved in the report preparation; what is the involvement and support degree of the top managers, what are the internal and external distribution channel for the report, what is the support provided by consultant and external auditors, and so on;
- The investors and other stakeholders' reaction to the first integrated reporting initiatives, with a focus on the way in which investors and other stakeholder, among them the analysts, perceive and evaluate the disclosure exposed in the integrated report, verifying the satisfaction degree towards the first attempts of integrated report. Such analysis allows to verify whether the integrated report currently available are suitable to satisfy the growing information needs of the stakeholders and what are the gaps still remaining;
- The role of standard setters and regulators in stimulating the institutionalization process of the integrated report and the gradually alignment between the integrated report and the information needs of the stakeholders. The analysis will show: *a)* what is the room that the integrated report is about to conquer within the reporting environment, even as an effect of the lobby activities; *b)* the IIRC initiatives in order to stimulate the dialog with and between companies and potential users of the integrated report.

The research results have relevant scientific implications for the international literature, in particular for the accounting one. It enriches the extant literature at least in the research fields analysing: *a)* the voluntary disclosure quality and the managerial choices based on such disclosure, even to verify the extant of impression management strategies and, generally, of external legitimacy; *b)* the relevance that investors and analysts assign to non-financial information; *c)* the organizational implications of social and environmental reporting; *d)* the impact of standard setters and regulators initiatives on corporate behaviour and on the consultant and external auditors activities; *e)* the lobbying activities related to the initiatives mentioned before.

The most relevant scientific impact is related to the goal to identify the processes of interaction and reciprocal influence among subjects that, within the corporate reporting environment, are involved in the regulation, preparation and use of the integrated report. We think that the assessment of such relations can provide a significant progress in the accounting studies and can stimulate further researches about the role of the corporate reporting in the organizational and socio-economic context.

The research has implications even for multiple subjects and for future practical developments. Such research allows standard setters and regulators to understand the companies' behaviour and the reaction of investors and other stakeholders with reference to the IIRC project. Furthermore, it can let managers and other company actors know what are the main initiatives related to the integrated reporting in addition to the competitors or benchmark companies behaviour. The research allows even to let the investors know what is the real value added that they can get from the integrated report reading.

## REFERENCES

- Adams, C.A. (2013), *Understanding integrated reporting: The concise guide to integrated thinking and the future of corporate reporting*, Doshorts, London.
- Adams, C.A. (2015), "The international integrated reporting council: a call to action", *Critical Perspectives on Accounting*, Vol. 27, pp. 23-28.
- Busco, C., Frigo, M.L., Riccaboni, A. and Quattrone, P. (2013), *Integrated Reporting. Concepts and Cases that Redefine Corporate Accountability*, Springer, Cham.
- de Villiers, C., Rinaldi, L. and Unerman, J. (2014), "Integrated Reporting: Insights, gaps and an agenda for future research", *Accounting, Auditing & Accountability Journal*, Vol. 27 No. 7, pp. 1042-1067.
- Eccles, R.G. and Krzus, M.P. (2010), *One report: Integrated reporting for a sustainable strategy*, John Wiley & Sons, New York.
- Flower, J. (2015), "The international integrated reporting council: a story of failure", *Critical Perspectives on Accounting*, Vol. 27, pp. 1-17.
- Frias-Aceituno, J.V., Rodríguez-Ariza, L. and García-Sánchez, I.M. (2012), "The role of the board in the dissemination of integrated corporate social reporting", *Corporate Social Responsibility and Environmental Management*, Vol. 20 No. 4, pp. 219-233.
- Frias-Aceituno, J.V., Rodríguez-Ariza, L. and García-Sánchez, I.M. (2013), "Is integrated reporting determined by a country's legal system? An exploratory study", *Journal of Cleaner Production*, Vol. 44, pp. 45-55.
- Frias-Aceituno, J.V., Rodríguez-Ariza, L. and García-Sánchez, I.M. (2014), "Explanatory factors of integrated sustainability and financial reporting", *Business strategy and the environment*, Vol. 23 No. 1, pp. 56-72.

- Jensen, J.C. and Berg, N. (2012), "Determinants of traditional sustainability reporting versus integrated reporting. An institutionalist approach", *Business Strategy and the Environment*, Vol. 21 No. 5, pp. 299-316.
- Lai, A., Melloni, G. and Stacchezzini, R. (2014a), "Corporate sustainable development: is "integrated reporting" a legitimation strategy?", *Business Strategy and the Environment*. <http://dx.doi.org/10.1002/bse.1863>.
- Lai A., Melloni, G. and Stacchezzini, R. (2014b), The role of Integrated Reporting in disclosing Sustainability Management, Conference Paper presented at the "17th EMAN Conference", Rotterdam, 27-28th March.
- Lai, A., Melloni, G. and Stacchezzini, R. (2015), "The quality of business model disclosure in the "Integrated Report" of european early adopters" in Di Cagno, N., Invernizzi, G., Mechelli, A. and Ugolini, M. (Ed.), *Il ruolo dell'azienda nell'economia. Esiste un modello aziendale orientato alla crescita?*, Il Mulino, Bologna.
- Melloni, G. (2015), "Intellectual capital disclosure in integrated reporting: an impression management analysis", *Journal of Intellectual Capital*, Vol. 16 No. 3, pp. 661-680.
- Melloni, G., Stacchezzini, R. (2013), "Integrated Reporting e risk disclosure: prime evidenze dal "progetto pilota" dell'IIRC", in Lai A. (Ed.), *Il contributo del sistema di prevenzione e gestione dei rischi alla generazione del valore d'impresa*, Franco Angeli, Milano.
- Melloni, G., Stacchezzini, R., and Lai, A. (2016), "The tone of business model disclosure: an impression management analysis of the integrated reports", *Journal of Management & Governance*, Vol. 20 No. 2, pp. 295-320. DOI: 10.1007/s10997-015-9319-z.
- Milne, M.J. and Gray, R. (2013), "W(h)ither ecology? The triple bottom line, the global reporting initiative, and corporate sustainability reporting", *Journal of business ethics*, Vol. 118 No. 1, pp. 13-29.
- Reuter, M. and Messner, M. (2015), "Lobbying on the integrated reporting framework: an analysis of comment letters to the 2011 discussion paper of the IIRC", *Accounting, Auditing & Accountability Journal*, Vol. 28 No. 3, pp. 365-402.
- Stent, W. and Dowler, T. (2015), "Early assessments of the gap between integrated reporting and current corporate reporting", *Meditari Accountancy Research*, Vol. 23 No. 1, pp. 92-117.

## PRICE AVAILABILITY OF CAR RENTAL AS AN ALTERNATIVE OF CAR OWNERSHIP

Leontyeva, Yulia; Mayburov, Igor

Ural Federal University named after the first President of Russia B.N. Yeltsin, Russia

### ABSTRACT

The article considers the issues of the availability of car rental in urban areas in different countries. An overview is done of scholarly work on the factors influencing people's decision whether to own and use a car. A conclusion is made that apart from the factor of cost the decision is shaped by the availability of alternative modes of transport. The authors prove that it is necessary to create an all-encompassing system of public transport that would provide alternative modes of transport, including taxis and car rental that target customers who are not prepared to give up personal cars. It is proven that the availability of car rental could serve as an alternative to car ownership for a certain part of people living in urban areas. The authors analyze types of car rental services and considers different levels of availability of the services to different categories of customers. The authors propose a method of conducting a comparative analysis of the availability of car rental services. The subject of the research is car rental services in three types of cities. The authors picked the cities with a high, medium and low intensity of private car use. The study assesses the cost of car rental in each city type under identical parameters of car brand and rental period and timing. A conclusion is made that there is a substantial difference in affordability and actual availability of car rental services. The authors substantiate an assumption that a wide range of car rental services and their affordability can be a significant alternative for city dwellers who do not use a car regularly. The article argues that car rental is not developed enough in Russian cities and analyzes factors that lead to the Russian cities lagging behind in adopting a systemic approach to the provision of such services. The aim of the research is to assess the availability of rental car and to establish the service availability factor as a crucial element of transport policy in urban areas that seeks to diversify modes of transport.

*Keywords: Car rental, affordability, car ownership, index of replacement*

### INTRODUCTION

Global and national business theories and practice:  
bridging the past with the future

ISSN: 2547-8516  
ISBN: 978-9963-711-56-7

Widespread car ownership has resulted in many urban agglomerations sliding into total dependence on cars in the 20th century. Such dependence brings about a constant increase in combined vehicular traffic on city roads. Automobile dependence makes it more difficult to fulfil economic, social and recreational functions of cities. In the long run, automobile dependence can be tackled by developing various modes of public transport. Most cities have already realized that it is necessary to switch from unimodal transport systems dominated by private cars to multimodal transit systems that successfully utilize multiple modes of transport.

The main task of long-term transport planning is building intermodal transport systems in cities. An intermodal transport system is a multimodal system in which the integration of various modes of transport leads to higher efficiency of each one of them and enables passengers to make intermodal transfers easily (Vuchic, 1981). Consequently, the main difference between an intermodal transport system and a multimodal one is the integration of multiple modes of transport with different functions.

The integration of various modes of transport is a very complicated, time-consuming and costly process. The process usually requires network coordination of the entire transport system. This includes the provision of transfer facilities, coordination of the schedules of main and feeder lines, construction of a single route network that covers the entire agglomeration, use of through fares and universal fare cards, utilization of a single information environment for all modes of transport, a unified website and image of the transport system.

When building an intermodal system it is extremely important to forge a common pricing policy for all participating modes of transport. The right prices should drive a shift in consumer preferences toward the use of the most efficient modes of public transport. At the same time, the price of an urban trip must get higher the more customized the service is. The approach implies that fares that are charged for using more efficient modes of transport with bigger sitting capacity must be lower than the price of travelling by less efficient modes of transport. This pricing regulation is implemented by means of an appropriately designed system of transport related charges.

Pricing regulation will make it possible to balance the urban transport system. Reaching a balance is important for intermodal systems that are composed of multiple modes of transport.

A well-balanced intermodal transport system is the one that has a balance between the demand for and supply of various modes of transport that provide for transporting a maximum number of passengers to all points and other activities per unit of time. In a well-balanced system all modes of transport are balanced and coordinated in such a way that different intermodal journeys inflict different monetary and temporal costs, yet every mode of transport must perform the role that it is best suited for technically and functionally.

Modes of transport that hold an intermediary functional position between the car and mass transit play a special role in transportation systems. The list of such modes includes taxi cabs, small buses operating without a regular schedule (jitneys), small buses operating on flexible routes and on-call, carpooling, vanpooling, car rental. All these modes of transport come under an umbrella term called "paratransit". Ideally, prices of paratransit services should be formed in such a way that they are higher than public transit fares, but lower than the cost of traveling by car. Some agglomerations employ organizational and pricing measures to encourage usage of paratransit services. For example, they are entitled to free parking or exempt from tolls; taxi cabs might be allowed to use lanes that are off-limits to private cars; there are also incentives promoting car rental, carpooling and vanpooling.

Car rental offers a significant functional advantage. The consumer rents a car exactly when he or she needs it. The car is not idle and does not occupy a parking spot. Car rental is a good alternative to owning a car for a number of prominent categories of consumers who use automobiles occasionally.

Some believe that car rental is mainly targeted at tourists visiting a city. However, car rental has recently been given a new impetus thanks to the growing popularity of various forms of rental services targeted at city dwellers: car rental with a driver, 24-hour car rental, carsharing etc. Each form of car rental has its own niche in the transportation choices of city dwellers.

Urban transportation policy should make car rental more accessible through the development of relevant services. Ensuring the affordability of car rentals is an essential part of that. Making car rental services available and affordable can significantly reduce car ownership rates in urban agglomerations.

The aim of the research is to assess the availability of rental car and to establish the service availability factor as a crucial element of transport policy in urban areas that seeks to diversify modes of transport.

## **1 LITERATURE REVIEW**

A bulk of theoretical work published in the 1960s (Buchanan, 1964; Leibbrand, 1970; Smeed, 1961) analyze space requirements of automobiles and public transport in the urban environment. Those studies were the first to identify vehicle saturation limits in cities. Reuben Smeed was one of the first European researchers to raise the key issues of demand side management by means of introducing adequate road tolls.

Hibbs proved that deregulation of transport leads to disintegration of services (Hibbs, 1986). The importance of assigning an active regulatory role to transport policy was later recognized not only by the opponents, but also by the advocates of transport system deregulation. Vuchic and Pickup showed that disintegration of urban transport systems was one of the main causes of passengers' rejection of public transport options (Fawkner, 1995; Pickup, 1991; Vuchic, 1986).

Morlok argued that the connection between the privatization of transport system and the level of integration (disintegration) of transport services was not so straightforward. Retaining a central coordinating body during the process of privatization can lead to positive effects of privatization. Privatization will allow for cost savings in the urban transport system without affecting the integration of the transport services provided by various operators, including private ones (Morlok, 1987).

Homburger pointed to the need to make sure that public transport services are provided by a single city agency or by an "umbrella" structure that pools all city transport operators. Transport services might be consolidated in a single control center by encouraging municipal and private transportation companies to sign special agreements on the creation and operation of shared transport hubs, adoption of a joint tariff and coordinated schedules. Vuchic cites the case of Verkehrsverbund (transit federation) – an alliance of transit companies – as an example of successful consolidation that was implemented in several European cities. Transit federations plan and coordinate the operation of all modes of city transport, accumulate revenue and redistribute it among operators according to an agreed formula reflecting the operating costs of the operators (Homburger, Vuchic, 1972).

Pucher and Hirschman proved that the level and structure of public transport fares have a significant impact on the appeal of public transport. Innovative methods of fare collection make a big difference, too. The level and structure of transit tariffs must strike a balance between generating maximum revenue for companies and attracting the maximum number of passengers, which is the main objective of public transport (Puscher, Hirschman, 1993).

Newman et al. argued that highly efficient public transit systems are an essential prerequisite for building well-balanced transport systems in medium towns and big cities, and for their recovery from total automobile dependence (Newman, Kenworthy and Robinson, 1992; Pucher, Hirschman, 1993).

Vuchic substantiated the price level that keeps public transport attractive to potential passengers. The level of fares is not constant; it depends on the characteristics of each urban agglomeration, such its size, population density, social conditions etc. Another major factor influencing the level of tariffs is the quality and cost of competing transport services (Vuchic, 1981).

Vuchic proved that comparative analysis of the relationship of performance and investment costs should be conducted for the entirety of modes of transport. The entirety covers a vast range of various transit systems – from paratransit systems that are most effective in servicing small volumes of dispersed travel demand, to LRT, metro and suburban railroads that make it possible to transport large volumes of passenger traffic that are typical of transport networks and major transit corridors in the biggest agglomerations (Vuchic, 1981).



We have not found any studies investigating the issues of price formation and price regulation of paratransit and, more specifically, of car rental.

## 2 METHODS

We conducted our analysis of the affordability of car rental services using the following methodology:

(1) Twelve countries located in different parts of Eurasia were picked for the analysis. The selection includes Northern European (Norway, the Netherlands), Central and Eastern European (Hungary, Poland, Czech Republic), Western European (France, Germany) and Southern European (Spain, Italy) countries, as well as Turkey, Russia and China. The countries differ drastically in terms of their economic development, population size and density, road and transport infrastructure. A comparative analysis was done of the capital cities of the countries, under urban conditions.

(2) The cities were grouped according to their ranking in the TomTom Traffic Index (Table 1).

TTIF	Cities
20 – 30 %	Cities with moderate road congestion: Amsterdam (Netherlands), Prague (Czech Republic), Budapest (Hungary), Berlin (Germany), Madrid (Spain)
30 – 40 %	Cities with medium degree of congestion: Oslo (Norway), Warsaw (Poland), Paris (France)
Over 40 %	Cities with high degree of congestion: Rome (Italy), Istanbul (Turkey), Moscow (Russia), Beijing (China)

Table 1: Groups of cities for analysis

Increase in overall travel times when compared to a Free Flow situation. For example, a Congestion Level of 36% corresponds to 36% extra travel time for any trip, anywhere in the city, at any time compared to what it would be in a Free Flow situation. The TomTom Traffic Index figures are based on speed measurements from TomTom's historical traffic database. These speed measurements are used to calculate the travel times on individual road segments and entire networks. By weighting based on the number of measurements, busier and more important roads in the network have more influence than quieter, less important roads. This makes the statistics match the user experience of people driving in the cities.

(3) The cost of car ownership was determined using the findings in the LeasePlan CarCost Index 2016 that is compiled by Lease Plan Corporation (Netherlands) (<https://www.leaseplan.com/news/2016/2/5/leaseplan-carcost-index-the-netherlands-is-the-most->

expensive-country-for-motorists-czech-republic-listed-as-cheapest/). We converted the index into the cost of car ownership per two weeks.

(4) We calculated the cost of renting cars in the mid-market segment for two weeks by drawing on quotes by four major car hire companies: Hertz, Avis, Sixt and Europcar. The average cost of car hire was determined as the mean of the rates quoted by all four companies, excluding the most expensive and the least expensive deals in the country being considered.

(5) As an integral measure, we propose a new index of replacement that characterizes the possibility of substituting car rental for car ownership. The index can be abbreviated as IR (Index of replacement). It is calculated as the ratio of the cost of renting a car (RC) to the cost of owning a similar car (CO) over the same period of time (t):

$$IR = \frac{RC_t}{CO_t}$$

The higher the index, the less affordable are car rentals in the city, and consequently, the more difficult it is to substitute car rental services for car ownership. The lower the index, the more affordable car rentals are in the city. Consequently, the affordability of rent-a-car services should form a considerable alternative to car ownership in the city.

(6) The analysis utilized Eurostat data on car ownership levels. It has to be noted that car ownership levels were analyzed by country, so applying them to the capital cities implies a high degree of approximation.

### 3 ANALYSIS OF RESULTS

The results of the analysis of the affordability of car rentals in various cities are shown in Table 2.

City	Car ownership rate, cars/1,000per.	TomTom Traffic Index, %	Cost of car ownership, euros	Car rental prices, euros	Index of replacement
Cities with moderate road congestion					
Madrid	471	25	240	179	0.75
Amsterdam	473	22	307	318	1.03
Berlin	550	29	235	419	1.78
Budapest	315	22	182	423	2.32
Prague	450	28	193	495	2.56
Cities with medium degree of road congestion					
Oslo	500	30	354	655	1.85
Paris	483	38	253	496	1.96

Warsaw	526	37	213	431	2.02
Cities with high degree of road congestion					
Beijing	114	46	351	335	0.95
Rome	690	40	339	423	1.25
Istanbul	290	49	224	454	2.02
Moscow	317	44	234	624	2.67

Table 2: Analysis of affordability of car rentals in various cities

The obtained results demonstrate a weak inverse correlation between the index of replacement and car ownership levels (correlation index 0.15), which indicates the poor impact that the affordability of car rental services currently has on car ownership rates. There is also a very weak direct correlation between the index of replacement and traffic density (measured by the TomTom Traffic Index) (correlation coefficient 0.12).

The proposed index of replacement will make it possible to rank cities and countries by car rental affordability:

Cities (countries) with highly affordable car rental services. These are cities (countries) where the index of replacement is below 1 ( $IR \leq 1$ ). Consequently, in such cities the price of renting a car is lower than the cost of owning a similar car over the same period of time. Among the cities that were analyzed high affordability of car rental is found in Madrid and Beijing.

Cities (countries) with a medium level of car rental affordability. These are cities (countries) where the index of replacement ranges between 1 to 2 ( $1 < IR \leq 2$ ). In these cities (countries) the price of renting a car is comparable or is slightly higher than the cost of owning a similar car during the same period of time. A medium level of car rental affordability is exhibited by Amsterdam, Rome, Berlin, Oslo, and Paris.

Cities (countries) with a low level of car rental affordability. These are cities (countries) where the index of replacement is over 2 ( $IR > 2$ ). In these cities (countries) the price of renting a car is substantially higher than the cost of owning a similar car during the same period of time. A low level of car rental affordability is exhibited by Istanbul, Warsaw, Budapest, Prague, and Moscow.

## CONCLUSION

Urban transport policy should improve the availability of car rental by developing relevant services. Ensuring the affordability of car rentals is an essential part of it. The affordability of car rentals is an

important factor creating acceptable alternatives to car ownership in urban agglomerations for individuals who take occasional or seasonal trips.

A statistical evaluation of the level of affordability of car rental services does not reveal a significant correlation with car ownership rates and traffic density. A more precise correlation might be found by a further study into the dynamics of the relationship between the affordability of car rental and car ownership levels over a period of time.

The index of replacement can have an application in compiling a new international ranking of cities (countries) by car rental affordability. The ranking can be based on the index of replacement that is described in this work. Such a ranking can be useful to tourists, municipal authorities, owners of car rental companies, and city dwellers.

## REFERENCES

- Buchanan, C. et al., (1964), *Traffic in towns*, HMSO, London, UK.
- Leibbrand, K. (1970), *Transportation and town planning*, MIT Press, Cambridge, MA.
- Smeed, R.J. (1961), *The traffic problem in town*, Manchester Statistical Society, Manchester.
- Hibbs, J. (1986), "The market alternative to integration", *City Transport*, May/July, pp. 23–24.
- Fawkner, J. (1995), "Bus deregulation in Britain: profit or loss?", *Public Transport International*, Vol. 44 (November), pp. 18-23.
- Pickup, L. et al. *Bus deregulation in the metropolitan areas*, Aldershot and Brookfield Avebury, UK.
- Vuchic, V.R. (1986), "Deregulation: a return to the primitive", *City Transport*, May/July. pp. 18 – 20.
- Morlok, E.K. (1987), "Privatizing bus transit: cost savings from competitive contracting", *Journal of the Transportation Research Forum*, Vol. xxviii, N 1, pp. 72-81.
- Homburger W.S., Vukan V.R. (1972), *Transit Federation – a solution for service integration/ Revue de l'UITP 2*, Union Internationale des Transports Publics (UITP), Brussels, Belgium.
- Pucher, J., Hirshman, I. (1993), "Path to balanced transportation: expand public transportation services and require auto users to pay the full social, environmental costs of driving", *Public Transport International*, Union Internationale des Transports Publics (UITP), Vol. 41, N 3, Brussels, Belgium.
- Newman, P., Kenworthy, J., Robinson, L. (1992), *Winning back the cities*, Pluto Press (Australian Consumers' Association), Australia.

## HOW CUSTOMER EXPERIENCE ATTRIBUTES INFLUENCE CUSTOMER SATISFACTION AND ONLINE BANK CREDIBILITY

Loureiro, Sandra Maria Correia<sup>1</sup>; Sarmiento, Eduardo Moraes<sup>2</sup>

<sup>1</sup>Instituto Universitário de Lisboa (ISCTE-IUL) Business Research Unit (BRU/UNIDE)

<sup>2</sup>ISEG (Lisbon School of Economics & Management, Lisbon University), ULHT and ESHT

### ABSTRACT

The banking sector has been focused its attention towards attracting Generation Y since they have consolidated as a huge force with powerful spending power which will unavoidably rival with Baby Boomers' market dominance. Thus, this article analyses customer experience of Generation Y and its effect on customer satisfaction and bank credibility.

Empirical evidence, based on primary data from an online survey (550 questionnaires were spread over a two-month period in 2016 but only 205 were usable and completed) reveal that the customer experience attributes (mainly executional excellence and reputation) have a positive relationship on credibility and satisfaction. In addition, "Value for money", "Getting things right the first time" and "Put the consumer first" emerge as the most importance attributes for Generation Y in experiencing the bank.

*Keywords: Customer experience, Generation Y, Credibility, Satisfaction, Banking sector.*

### INTRODUCTION

In a progressive global and competitive world, banks must innovate and create different strategies to succeed. However, searching for competitive advantage through product differentiation in the banking sector is extremely difficult since products and services may be quickly copied thus forcing banks to find new ways and opportunities of identifying and developing relationships with customer and enhancing positive feelings about them. The banking sector is a consumer-oriented service industry, and their success increasingly depends on the quality of the consumer service provided, as well as the overall customer's satisfaction.

Under this context, relationship marketing turned to be a critical aspect to corporate banking success. Today's customers demand a high level of experience from banks, which, if fulfilled, could result in significantly improved customer satisfaction, and potentially retention levels (Putnam, 2012). Furthermore, since brand experience is the outcome of an attribute, the information processing in which consumers are engaged rationally and emotionally, it is extremely important to engage all

senses and to evoke emotional as well as an intellectual reaction towards a brand (Brakus, Schmitt, and Zarantonello, 2009).

Generation Y (Gen Y) is considerably less likely to have positive experiences, compared to all other age groups due to the high expectations they have toward banks' digital capabilities. Gen Y is far more interested in using mobile banking compared to other age groups, placing additional importance on the development of this channel (Capgemini and Efma, 2016). Under this context, customer experience may be an emerging opportunity in the new horizon of experience economy since it is expected that customers with positive experiences may be three to five times more likely to purchase additional products (Capgemini and Efma, 2015).

Prior studies with bank institutions revealed a gap because they didn't properly analyze which stimuli of online bank experience could influence the emotions and the behavioral intentions positively. Therefore, the research question is: which stimuli from bank experience attributes can influence customer satisfactions and credibility of Generation Y (or Gen Y)?

This article is organized into three parts. The first one gives the theoretical background which aims to contextualize the research. Then we present the method and results, In the end, the conclusions and implications.

## **THEORETICAL FRAMEWORK**

### *Experience conceptualization*

In an era of relationship marketing where marketers focus on the development of long-term relationships, the understanding of how consumers experience a brand is crucial for the meet such marketing goals. In the marketing literature, the concept of experience has been investigated in different contexts, recently, a concept has been presented that spans across these various contexts: the concept of brand experience (Zarantonello and Schmitt, 2010). In addition, Nysveen, Pedersen, and Skard (2012) consider both customer and brand experiences to span the context - and life cycle-specific experiences.

Since brand experience can be seen as the outcome of an attribute which consumers are both rationally and emotionally engaged, when creating a brand experience, the key is to engage all senses and to evoke emotional as well as an intellectual reaction towards a brand. In other words, it can be defined as subjective, internal consumer responses (sensations, feelings, and cognitions), as well as behavioral responses evoked by brand-related stimuli, are part of a brand's design, identity, communication and packaging strategy. They can take various forms and range from colors, sounds, haptics, to logos with special typefaces and designs, slogans with a high recall value or brand characters in the form of mascots (Brakus, Schmitt, and Zarantonello, 2009).

The degree to which companies can create a certain experience for customers depends on their ability to make use of all these brand stimuli in a favorable way (experiential marketing), and marketers see consumers as rational and emotional human beings concerned with achieving pleasurable experiences. Marketers can create different types of experiences for customers: sensory experiences (sense); affective experiences (feel); creative cognitive experiences (think); physical experiences, behaviors and lifestyles (act); and social-identity experiences that result from relating to a reference group or culture (relate) (Schmitt, 1999).

Brakus, Schmitt, and Zarantonello (2009) propose a framework with five experience dimensions that are responsible for the creation of brand experience as follows: sensory, affective, behavioral, and intellectual. Brand experiences can positively affect consumer satisfaction and brand loyalty, as well as brand associations (particularly brand personality). Brand experience is empirically distinct from other brand and customer-focused concepts including brand attachment, brand involvement, and customer delight (Zarantonello and Schmitt, 2010).

Mosley (2007) argues that product brand experiences are simpler than service brand experiences, as services require a higher level of interpersonal complexity and relationship quality and therefore, the relational dimension of experience is highly relevant in the service sector.

#### *Customer experience in banking sector*

The concept of customer experience appeared in marketing studies in 1982 by Holbrook and Hirschman and became generalized in marketing literature by Pine II and Gilmore in 1998. Nowadays, creating and delivering superior customer experience has become one of the prime objectives of organizations.

Customer experience may be defined as the internal and subjective response customers have to any direct or indirect contact with a company in a way that creates a memorable event (Pine II & Gilmore, 1998). Direct contact generally occurs in the course of purchase, use, and service and is usually initiated by the customer. Indirect contact most often involves unplanned encounters with representatives of a company's products, service or brands and takes the form of word-of-mouth recommendations or criticisms, advertising, news reports, reviews and so forth (Meyer and Schwager, 2007). In other words, Customer experience is the user's interpretation of his or her total interaction with the brand (Ghose, 2007).

In considering customer experience, it is appropriate to consider two perspectives of consumer behavior: (i) the traditional "information processing and decision oriented" perspective that suggests that customer is engaged primarily in goal-directed activities such as searching for information, evaluating available options and deciding whether to buy a particular product or service or not (Frow and Payne, 2007) and (ii) the "experiential" perspective. This view of consumption has broadened this

perspective considerably and includes the flow of fantasies, feelings and fun where such behavior may not necessarily be the goal (Payne, Storbacka, and Frow, 2007) but needs to be seen from both an information-processing approach that focuses on memory-based activities and on processes that are more sub-conscious and private in nature (Holbrook and Hirschman, 1982).

The nature of service encounter and kind of service provider do an essential function because the customers not just purchase the service delivered by the business, however, purchases “experience” from that business, too. The main reason to work on the experiences of the banks’ customers is that the prosperity of any bank depends upon its number of existing customers (Garg, Rahman, Qureshi, and Kumar, 2012). For services, it has been demonstrated that the creation and delivery of an emotion-rich experience provide brand differentiation and influences sales, consumer loyalty, and promotion of the brand (Morrison and Crane, 2007).

In studying of customer experience factors in banking, a customer requires convenience at its every contact point with the organization as regarding the location of the bank, available parking facilities, speed, hygienic environment and alike (Jain and Bagdare, 2009). According to (AHP) approach, the factor “convenience” possesses maximum weight it shows that though customer takes cognitive decisions regarding “monetary aspect” but still requires “convenience” in every aspect while dealing with the organization. In addition, employees, online functional elements, and servicescape possess distinctively higher weights than the other factors such as service process, marketing mix, customer interaction and online hedonic elements (Garg, Rahman, Qureshi and Kumar, 2012).

The research’s results about banking by Hardeep Chahal and Kamani Dutta study revealed that core service experience comprising cognitive, affective and behavioral factors is most significant dimension followed by relational experience and sensory experience dimensions. The cognition items affecting banking customer experience include knowledge of bank products, competitive interest on loans and information sharing. Bank managers when respect customer’s time and give special attention to knowledge, speed and service process, can generate positive behavioral experience. Similarly, affective items in the core service factor include problem handling, responding quality, aesthetic, and empathy, which have a significant impact on creating customer experience in banking sector. Behavioral characteristics affecting customer experience include concern and caring attitude, prompt customer service and error free bank services (Chahal and Dutta, 2014).

#### *Customer Satisfaction*

Customer satisfaction refers to “a person’s feelings of pleasure or disappointment that result from comparing a product’s perceived performance (or outcome) to their expectations” (Kotler and Keller, 2006: 144) and can generally be described as the full meeting of one’s expectations (Oliver, 1980).



Research indicates that satisfaction primarily consists of cognitive (include disconfirmation and expectations, perceived performance, equity, performance, fulfillment and price acceptance/willingness to pay) and affective variables (include emotional measures, post-purchase, word of mouth, arousal and pleasure) (Fraering and Minor, 2013).

The banking sector has been undergoing changes triggered by regulatory, structural, and technological factors, which make keeping customer satisfaction more difficult. Developing and maintaining customer satisfaction is important particularly in the service sector because that will lead to loyalty, increasing in profits through repeat patronage, less price sensitivity, and positive word-of-mouth (Foscht, Schloffer, Maloles and Chia, 2009).

Bank customer satisfaction is a hot topic of current scientific research. In response to the negative impact of the recent financial crisis of 2008, consumers have become very sensitive to all aspects of commercial bank activity. A satisfied customer remains loyal and to keep him a company requires five times less effort, time, and money than to get a new one (Belás and Gabčová, 2014). Customer “retention” relies on the quality of the relationship and the experience, which the customer has with their bank. Thus, creating satisfied, happy customers is crucial to maintaining their long-term loyalty (Baumann, Elliott, and Burton, 2012).

Nevertheless, various studies showed that even satisfied customers switch their bank if another one offers them a better product because even though loyal clients have a more intense, emotionally based connection to their bank and are consequently more resistant to competitor banks’ offers satisfied customers may quit their banks due to objective factors, e.g. conditions of products, price or distribution channels reliability determine their satisfaction and also subjective emotions and experiences that are getting more and more important (Murugiah and Akgam, 2015).

If the bank exceeds the expectations of their clients, positive conditions for their loyalty are created. Understanding customer loyalty requires understanding customer satisfaction first (Fraering and Minor, 2013).

According to Chavan and Ahmad (2013) there are eight important attributes of satisfaction in banking: paying individual attention to each client, personnel behavior inducing customer trust, attractive bank equipment, zero fees for issuing checks, zero error records, the possibility of online banking, security of transactions, helpful staff, and readiness of staff to answer to customer requirements regardless of occupancy. From a transaction-specific attribute, customer satisfaction is dependent on nine different factors: tangibility, e-fulfillment, convenience & availability, accuracy, responsiveness, empathy, promptness, personal assistance (Chavan and Ahmad, 2013). Furthermore, in online banking service, it was added the following factors that affect customer satisfaction: perceived quality of the service, perceived value, and customer expectation (Unyathanakorn and Rompho, 2014).

The older the customer, the greater the intention to remain with their bank for a longer time because most of the attention in terms of acquisition/customer retention should be placed on the segment of young, high-income customers, as they are the ones most willing to change banks (Baumann, Elliott and Burton, 2012).

When comparing older bank customers to younger ones, it was found that older customers are more loyal to their bank, more confident on the notion that their bank offers the best deal, and more satisfied with the preferential treatment they receive from their banks. Older customers are often seeing the perceived value in a banks' effort to recover services than are younger customers. On the other hand, the younger the bank customer is, the higher he/she perceives the availability and attractiveness of alternatives. Younger bank customers are more likely to end their relationship with their present bank and are less loyal and less satisfied with the services they get from their banks than the older customers. Older customers are more likely to have a higher perception about the satisfaction derived from their bank service, and the difficulty of switching to other banks (Tesfom and Birch, 2011).

#### *Brand Credibility*

Credibility has two main components: expertise and trustworthiness (Wernerfelt, 1988). Thus, brand credibility is the believability of the product information contained in a brand, which requires that consumers perceive brand as having the ability (i.e., expertise) and willingness (i.e., trustworthiness) to deliver continuously what has been promised (brands can function as signals because if and when they do not deliver what is promised, their brand equity will erode). In other words, "Brand credibility" is defined as the believability of the product position information contained in a brand, which depends on the willingness and ability of firms to deliver what they promise (Erdem, Swait, and Valenzuela, 2006).

Erdem et al. (2006) study demonstrated that credible brands provide more value to high-uncertainty-avoidance consumers because such brands have high perceived quality, lower perceived risk and lower information costs. Brand signaling theory suggests that credibility can build brand equity (Erdem and Swait, 1998). Furthermore, higher brand credibility can increase consumers' perceptions of product quality by influencing their psychophysical processes whereby objective quality levels are transferred into perceived, subjective quality levels (Erdem, Swait, and Louviere, 2002).

Maathuis, Rodenburg, and Sikkel (2004) have insisted on the significance of brand credibility in consumer's decision-making and choice perceptions, and the credible brand is expected to induce higher levels of consumer loyalty. In other words, a credible brand would easily generate loyal customers if it consistently conforms to its promised quality and trust induce brand's credibility which, then leads to a bigger customer brand relationship (Alam, Usman Arshad, & Adnan Shabbir,

2012). Sweeney and Swait (2007) results from samples of retail bank indicate that brand credibility serves in a defensive role: it significantly enhances word-of-mouth and reduces switching behaviors among customers.

#### *Generation Y*

This is a segment that comprises individuals who were born between 1980 and 2000 and that are also referred to as Millennials, net generation or Echo Boomers (Valentine and Powers, 2013). Individuals in this segment like to work in a team and in an organized and growth-oriented culture because they believe they would better accomplish their goals. They are also eager to achieve their objectives within a short time period (Viswanathan and Jain, 2013).

They are influenced by western culture, and therefore they are eager to spend money or experiment and adapt to new products and brands. Although they have high brand awareness, they are not loyal to a brand loyal being called "brand switchers". It is important to note that the purchasing power of this young segment will keep increasing over time (Jurisic and Azevedo, 2010). Since Gen Y's start to use social media the marketplace, the workplace and the society have been changing; it will ultimately lead to new business models, processes, and products (Bolton et al., 2013).

Thus, younger customers are more likely to change their banks easily, so if retail banks want to retain younger customers, they need to offer more meaningful incentives to younger customers than they offer to older customers. This situation highlights the need for managers to design different switching barrier packages for each customer age group (Tesfom and Birch, 2011).

Given that e-banking services are designed essentially to suit individuals who prefer convenience, quicker service, more frequent and less face-to-face retail banking services, one would expect that Generation Y individuals, would be expected to use the e-services more regularly given that individualistic societies tend to be more consumption-oriented and therefore more encouraging towards spending (Rugimbana, 2007).

Generation Y group likes to travel and prefers to spend money on experiences rather than materialistic items. Their responses to online marketing are expected to be different as they process website information five times faster than older generations and are the most emotional and least loyal customers compared to all other generations (Bilgihan, 2016). Bilgihan also demonstrated that trust is the most important antecedent of e-loyalty in online shopping for Gen Y customers. Brand equity is also a key precursor of e-loyalty. Finally, a positive online experience (flow) is also a significant precursor of e-loyalty (Bilgihan, 2016).

#### *Banking Sector*

For several years now, the banking sector has been under several challenges namely the technological development. The Internet has transformed the way in which individuals, groups, organizations

communicate, obtain information, access entertainment, and conduct their economic and social activities. Looking forward, by 2018 almost 3.6 billion people, i.e. half of the world's population will be connected to the internet or the mobile internet (Nagurney, 2014).

In response to market competition and with relatively low setup costs, traditional banks have adopted a policy of enhancing the possibilities of their online services. Interactive banking services have currently become a common practice, ubiquitously performed all over the world and are now an integral part of the modern commercial environment (Levy, 2014).

This significant change extends across all levels of service in the banking industry. Advances in technology, globalization, and customization have created a dynamic banking environment in an attempt to improve service quality and satisfy customers' need for faster, easier, independent and real-time service (González, Mueller-Dentiste, and Mack, 2008).

Internet banking has become a strategic tool for business development has gained wide acceptance internationally (Sahoo and Swain, 2012). There are some main benefits of Internet banking for both banks and customers (Sahoo and Swain, 2012): (i) its permanent availability; (ii) banks have succeeded reduced queues through technology. Also, banks use internet facility for customer's transactions and will reduce paperwork, will give a quick response to the customer; (iii) e-banking makes easier for customers to compare banks' services and products. Moreover, it can raise competition among banks, and allow banks to penetrate new markets and thus inflate their geographical reach; (iv) e-banking Customers can easily access services from abroad and through wireless communication systems, provides them enormous benefits regarding the ease and cost of transactions.

Mobile has become an intrinsic and vital part of bank customers' everyday life, and they expect banks to respond rapidly to their demands and provide the level of service they want (EFMA, 2014). According to the second annual Trends in Consumer Mobility report of Bank of America, of those consumers who use a mobile banking app, nearly two-thirds (62%) access it at least a few times a week or more, while one in five (20%) check once a day or more (Bank of America, 2015).

Mobile Banking covers various areas, from apps to mobile financial services and even mobile payments, and from smartphones to smart TVs. These are all part of the rapidly evolving mobile ecosystem (EFMA, 2014). In addition, according to the Consumer Mobility report of Bank of America (2015), 74% of consumers check their balance or statement, 63% consult transactions via their mobile banking app and 72% of Millennials (ages 25-34) generation report using mobile deposits. Additionally, nearly 38% pay bills, almost 32% use it to locate a branch or ATM and 15% manage investments.

Despite the huge worldwide migration towards the use of mobiles in recent years, mobile banking is still really in its infancy. There is a lot to be discovered, and many challenges to overcome the whole mobile ecosystem is continuing to grow and evolve (EFMA, 2014).

#### *Banking for generation Y*

As banks target technology-friendly Gen Y customers, they must focus on developing products and services in unique and innovative ways. Gen Y customers are more likely to be attracted by innovation, quality of service, and accessibility to various products and services such as payment systems and banking accounts. To that end, mobile and social media tools are powerful ways to engage Gen Y (Capgemini and Efma, 2015).

The reasons that younger generations patronize banks is that they offer more sophisticated, online and mobile banking services and is a more convenient access to ATMs (Putnam, 2012). Online or mobile banking is an influential factor for about 25% of younger generations, but only 18 % of older boomers or matures. Gen Y is more likely to pay attention to what their friends say, text or put in their Facebook pages about a bank than what the bank is saying about itself. Gen Y prefers to receive communications via the bank's online banking site (after login), e-mail or the bank's website more than by "snail mail."

Gen Y have some requirements & demands (Capgemini, 2014): (i) they are more interested in products and services that offer low fees and charges and banks that offer student accounts, without maintenance fees, and loans with lower commissions and fees; (ii) they look for banks with higher rates on savings accounts; (iii) they prefer banks whose processes are more streamlined and offer a high level of convenience; (iv) they will select a bank that delivers the greatest value and benefit to them. In addition, they prefer banks that have a transparent feedback system that will act on customer suggestions and complaints; (v) they prefer banks that provide mobile and online capabilities because of high reliance on smartphones.

Therefore, in order to encourage an ongoing mutually valuable relationship with Gen Y customers, banks need to focus on four key areas that could increase Gen Y customer stickiness (Capgemini, 2014): (i) banks should introduce specific checking and savings accounts with competitive interest rates and a high level of online and mobile banking convenience. Banks should provide attractive long-term savings, pension, and securities and insurance products and services to meet this need; (ii) banks should bundle payment instruments (Mobile Wallets - Prepaid Cards - Credit Cards - Personalized Cards); (iii) banks should focus on enhancing their online and mobile channels; (iv) banks need to embrace social media platforms to engage Gen Y customers who are more likely to trust experiences posted on social media by other customers and use social networks and platforms to voice their opinions.

## RESEARCH MODEL AND HYPOTHESES

The Customer Experience attributes encompass: Accessibility, Ease of doing business, Executional excellence, Personalized offering, Staff engagement, Value for money, and Reputation affect the organism. The organism is defined by the attitudinal state that includes satisfaction and by the perspective that includes credibility.

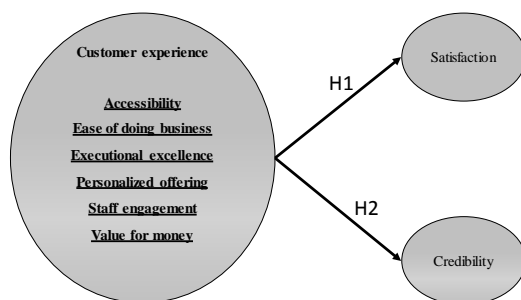

Figure 1. Research model

The overall hypotheses proposed for this study are the following:

**H1: Customer Experience, that is, Accessibility(H1a), Ease of doing business(H1b), Executional excellence(H1c), Personalized offering(H1d), Staff engagement(H1e), Value for money(H1f), and Reputation(H1g) positively affects customer satisfaction of Generation Y in experiencing the bank.**

**H2: Customer Experience, that is, Accessibility(H2a), Ease of doing business(H2b), Executional excellence(H2c), Personalized offering(H2d), Staff engagement(H2e), Value for money(H2f), and Reputation(H2g) positively affects bank credibility of Generation Y in experiencing the bank.**

## METHOD

### *Data Collection*

We collected secondary data through a revision of previous researches related to the topic. With the support of the theoretical background and in order to collect primary data an on-line survey was created and launched via the umfrageonline website, being available during February and March 2016. Therefore, it was chosen and online survey because (i) it allows a quick response and it possible to reach a higher number of Generation Y's customers in a small period of time in different places; (ii) the study is aimed at Generation Y that is also known as the Internet generation, increasing the

importance of using an on-line survey. The survey was spread to customers via Facebook. We posted the survey's link on several Facebook pages like universities and youth organizations.

#### *Questionnaire Design*

The questionnaire was mainly designed to measure: Customer Experience attributes, internal emotional consumer states. The items of the questionnaire were rated on a 5-point Likert scale: (1= strongly agree, 2= agree, 3= Neither agree nor disagree, 4= disagree, 5= strongly disagree).

Hence, in the first part, the respondent had four demographic questions: gender, age, marital status and educational background. In the second part, the respondents were asked to answer eighteen questions concerning the seven Customer Experience attributes (1-Accessibility, 2-Ease of doing business, 3-Executorial excellence, 4-Personalized offering, 5-Staff engagement, 6-Value for money, and 7-Reputation). Those eighteen questions were grouped into two groups. This part was based on the study of KMPG International (2014). In the third part, the respondents were asked to rank that Customer Experience attributes according to its importance to them according to the scale 1= most important, 7= less important.

In the fourth part, the respondents were asked to answer questions about customer satisfaction, based on Erdem and Swait (1998) and bank credibility, adapted from Leverin and Liljander (2006).

#### *Sample Profile*

The sample of this study consisted of Generation Y customers of banks from different countries around the world. In order to achieve the target sample, an online survey was spread through Facebook with URL embedded that lead the respondents to the survey.

Almost 550 questionnaires were spread over a two-month period in 2016. Thereby, we gathered a sample of 211 respondents. The data consists of 205 usable survey participants (120 male-58%; 85 female-42%). Most of the answers are from individuals aged between 21-25 (46.8%) and between 26-30 (35.1%) followed by 31-35 (13%) and 18-20 (5%). Regarding the marital status, most the respondents were single (180), and the others 25 were married.

Finally, regarding the education level, most of the sample is doing or already has University degree (100-49%), 41% were doing or already had a Master degree, 3% has a Ph.D. degree, and 7% had a senior high school degree.

## **RESULTS**

Table 1 shows the descriptive statistics and the reliability of the constructs. The constructs reveal to be reliable since the values of Cronbach's Alpha (CA) are higher than 0.7.

Table 1. Descriptive Statistics and Reliability

Construct	Items	Mean	S.D.
Accessibility	In my Bank, the physical proximity/ease of access is good	2.09	0.85
	In my Bank, the availability of services (around the clock) is good	2.27	0.95
Ease of doing business	My Bank has services and products that are easy to understand	2.47	0.92
Executional excellence CA= 0.762	It is ease of getting issues/queries/complaints resolved	2.44	0.89
	It is fast to make an inquiry/transaction	2.04	0.86
	My Bank is fast in resolving a complaint/resolving a query	2.46	0.93
	I get things right from the first time	2.47	0.85
	The services are Consistent – continuity in communications or interactions	2.34	0.82
Personalized offering	My Bank offers products and services that can be tailored to my specific needs.	1.95	0.92
	My Bank rewards my choice to do business with it.	2.98	0.93
Staff engagement CA=0.711	In my Bank, the staff has a positive attitude	2.21	0.80
	The staff are honest and tell the truth	2.32	0.89
	My Bank offer high quality of advice and service	2.41	0.85
Value for money	The fees/charges are fair and appropriate (Value for money).	2.77	1.08
	The rewards and promotions are available.	2.85	0.89
Reputation CA= 0.65	My Bank is well regarded in the media	2.27	1.03
	I trust that my Bank does the right thing	2.62	0.91
	My Bank puts the consumer first	2.79	0.96
Satisfaction	I am satisfied with the quality of my Bank's services.	2.30	0.85
	I am satisfied with the interactions that I have had with my Bank.	2.32	0.90
Credibility CA=0.80	My bank is committed to delivering on its claims, no more and no less	2.36	0.74
	My bank has a name I can trust	2.15	0.88
	My bank has the ability to deliver what it promises	2.24	0.73
	My bank's product claims are believable	2.35	0.75
	My experiences with my bank have led me to expect it to keep its promises	2.33	0.80
	My Bank delivers what it promises	2.37	0.80

Note: CA-Cronbach Alpha



In order to test the hypothesized relationships of H1 and H2, multiple regression analysis was used. In this case, multiple regression determined the relative importance as well as the significance of the relationship between customer experience, the organism state, and responses.

In order to test multicollinearity among independent variables, the Variance Inflation Factor (VIF) was examined, and we concluded that all VIF values in this study were within an acceptable range (VIF values were below 10). For all of them, Tolerance values were superior to 0.1. Given the sample's dimension, it can be considered that the Durbin-Watson test is at the inclusion zone (close to 2).

The seven attributes of Customer Experience (Accessibility, Ease of doing business, Executional excellence, Personalized offering, Staff engagement, Value for money and Reputation) were used as independent variables while Satisfaction was the dependent variable. The results in table 2 show that there is a significant positive relationship between the Customer Experience and Satisfaction ( $p < 0.05$ ). Satisfaction is explained by the seven predictors by 41.8%. Yet, only the Accessibility ( $\beta = 0.193$ ,  $p \leq 0.05$ ), Executional excellence ( $\beta = 0.267$ ,  $p \leq 0.05$ ) Personalized offering ( $\beta = 0.124$ ,  $p \leq 0.05$ ), and Reputation ( $\beta = 0.202$ ,  $p \leq 0.05$ ) are important to explain the Satisfaction variable. The Ease of doing business, Staff engagement, and Value for money do not significantly contribute to explaining the Satisfaction.

Table 2. Multiple regression; satisfaction as dependent variable

F(sig.) = 21.914 (p= 0.000)		Adjusted R2 = 0 .418			Durbin-Watson = 2.171	
	Unstandardized Coefficients B	Standardized Coefficients Beta	t	p(Sig.)	Collinearity Statistics	
					Tolerance	VIF
(Constant)	-0.204		-0.633	0.527		
Accessibility	0.205	0.193	3.084	0.002	0.728	1.374
Ease of doing business	0.070	0.068	1.012	0.313	0.626	1.598
Executional excellence	0.143	0.267	3.667	0.000	0.537	1.862
Personalized offering	0.130	0.124	1.995	0.047	0.738	1.356
Staff engagement	0.037	0.049	0.740	0.460	0.644	1.552
Value for money	0.031	0.033	0.552	0.582	0.785	1.274
Reputation	0.137	0.202	3.164	0.002	0.701	1.427

Regarding H 2, the seven attributes of Customer Experience; Accessibility, Ease of doing business, Executional excellence, Personalized offering, Staff engagement, Value for money and Reputation were used as independent variables while Credibility was the dependent variable. The results in table 2 show that there is a significant positive relationship between the Customer Experience and Credibility ( $p < 0.05$ ). The seven customer experience attributes help to explain 51.7% of the variability of Credibility. However, only the Executional excellence ( $\beta = 0.188$ ,  $p \leq 0.05$ ), Staff engagement ( $\beta = 0.172$ ,  $p \leq 0.05$ ), Value for money ( $\beta = 0.145$ ,  $p \leq 0.05$ ) and the Reputation ( $\beta = 0.402$ ,  $p \leq 0.05$ ) are important to explain the Credibility variable. The Accessibility, Ease of doing business and Personalized offering do not significantly contribute to explaining the Credibility.

Table 3. Multiple regression: credibility as dependent variable

F(sig.) = 32.248 (p= 0.000)		Adjusted R2 = 0.517			Durbin-Watson = 2.162	
	Unstandardized Coefficients B	Standardized Coefficients Beta	t	p(Sig.)	Collinearity Statistics	
					Tolerance	VIF
(Constant)	2.314		3.301	0.001		
Accessibility	0.152	0.060	1.047	0.297	0.728	1.374
Ease of doing business	-0.008	-0.003	-0.052	0.959	0.626	1.598
Executional excellence	0.242	0.188	2.838	0.005	0.537	1.862
Personalized offering	0.094	0.038	0.665	0.507	0.738	1.356
Staff engagement	0.312	0.172	2.833	0.005	0.644	1.552
Value for money	0.327	0.145	2.647	0.009	0.785	1.274
Reputation	0.652	0.402	6.917	0.000	0.701	1.427

We also intended to find how the Bank customer experience attributes are important for Gen Y customer. To achieve this task, we asked them (customers) to rank the seven attributes that represent the seven categories of customer experience. The customer experience attributes were: Value for money ; Getting things right the first time; Put the consumer first; Staff who are honest and tell the truth; Ease of getting issues/queries/complaints resolved; Availability of services and Offers products and services that can be tailored to my specific needs (KPMG, 2014).

A custom table was created to test the data. Table 4 shows the number and percentage of respondents for each rank; the results determined that the majority of respondents mentioned Value for money (i.e.

fair and appropriate fees and charges) as the most important attribute (rank 1) (68 respondents - 33.2%). The least important for most of the respondents (rank 7) was Offers products and services that can be tailored to my specific needs (90 respondents - 43.9%).

Table 4. Custom Table

Customer Experience attributes	Rank 1		Rank 2		Rank 3		Rank 4		Rank 5		Rank 6		Rank 7		Total	
	Number	%	Number	%	Number	%	Number	%	Number	%	Number	%	Number	%	Number	%
Availability of services (around the clock)	21	10.2%	31	15.1%	18	8.8%	25	12.2%	22	10.7%	57	27.8%	31	15.1%	205	100%
Offers products and services that can be tailored to my specific needs	13	6.3%	13	6.3%	18	8.8%	27	13.2%	21	10.2%	23	11.2%	90	43.9%	205	100%
Value for money (i.e. fair and appropriate fees and charges)	68	33.2%	29	14.1%	31	15.1%	22	10.7%	22	10.7%	19	9.3%	14	6.8%	205	100%
Getting things right the first time	39	19.0%	39	19.0%	30	14.6%	31	15.1%	25	12.2%	25	12.2%	16	7.8%	205	100%
Put the consumer first	37	18.0%	41	20.0%	51	24.9%	26	12.7%	23	11.2%	20	9.8%	7	3.4%	205	100%
Staff who are honest and tell the truth	19	9.3%	37	18.0%	29	14.1%	42	20.5%	29	14.1%	29	14.1%	20	9.8%	205	100%
Ease of getting issues/ queries/ complaints resolved	8	3.9%	15	7.3%	28	13.7%	32	15.6%	63	30.7%	32	15.6%	27	13.2%	205	100%

Table 5. Ranking of Customer Experience attributes

Customer Experience attributes	Rank	Number	%
Value for money (i.e. fair and appropriate fees and charges)	1	68	33.2
Getting things right the first time	2	39	19.0
Put the consumer first	3	51	24.9
Staff who are honest and tell the truth	4	42	20.5
Ease of getting issues/ queries/ complaints resolved)	5	63	30.7
Availability of services (around the clock)	6	57	27.8
Offers products and services that can be tailored to my specific needs	7	90	43.9

Regarding table 5, there are two attributes (Getting things right the first time and Put the consumer first) that have a close number of respondents 39 – 41 respectively. The final order of importance for the seven attributes, with the number and percentage of respondents who gave each rank, is the in following table 6 (1= most important, 7= less important).

## CONCLUSIONS AND MANAGERIAL IMPLICATIONS

The present study has the intention to go further in understanding how customer experience of Gen Y could affect the outcomes (customer satisfaction and bank credibility) of the banking sector's efforts from a marketing perspective.

In what concerns the "Rank the Customer Experience attributes" we saw that "Value for money" (i.e. fair and appropriate fees and charges) was the most importance attribute (33.2% of respondents). The least important attribute in this sample was "Offers products and services that can be tailored to my specific needs" (43.9% of respondents). Those results are consistent with the ones found by KPMG International for banks (KPMG International, 2014). The only different is that Gen Y in this sample gave "Getting things right the first time" and "Put the consumer first" attributes more importance than "Staff who are honest and tell the truth".

We found a significant positive relationship between the dependent variables and at least one of the independent or outcome variables. Therefore, the customer experienced attributes of Accessibility, Executional excellence, Personalized offering and Reputation have a positive impact on Satisfaction. On the other hand, the customer experienced attributes of Executional excellence, Staff engagement, Value for money, and Reputation have a positive influence on Credibility, which is consistent with the work of Syrett and Lamminman (2004) and Capgemini and Efma (2014). The results for Satisfaction are consistent with the ones found by Baumann, Elliott, and Burton (2012) that claim that customer "retention" satisfaction relies on the quality of the relationship and the experience that the customer has with their bank. Reputation has a dual role on both Satisfaction and Credibility.

These conclusions have implications to understand the importance of customer experience concept in the banking sector for Gen Y and contribute to the development of a new model for banks that focus on the emotional side of the interaction between Gen Y and banking sector. Particularly, banks need to be aware of the importance of the value for money for Gen Y as a first reason to stay or leave the Bank. Getting consumer first and doing things right at the first time occupy an important place in building positive Gen Y customer experience. Furthermore, particular attention should be paid to Reputation because it plays a leading role to achieve marketing efforts outcomes and it is the foundation to any relationship between Gen Y and banks.

Personalized genuine offerings along with excellence performance is a critical issue for Gen Y in the banking sector. Each of Executional Excellence and Personalized offering contributes to achieving the marketing goals of banks through different aspects. Moreover, it has been noticed that the Gen Y does not feel active or Energetic during experiencing the bank environment as he/she does in other industries. From that, bank's managers should consider that in planning the process of the interaction between Gen Y and bank by making this process more entertainment for example.

In sum, banks need to work in making Gen Y customer experience unique, not boring or something Gen Y need to deal with. This should be done with customized services and products that tailored with the special need of this segment along with ongoing innovations that benefit from continuing IT development.

## REFERENCES

- Alam, A., Usman Arshad, M., & Adnan Shabbir, S. (2012), "Brand credibility, customer loyalty and the role of religious orientation", *Asia Pacific Journal of Marketing and Logistics*, Vol. 24 No. 4, pp. 583-598, <http://dx.doi.org/10.1108/13555851211259034>.
- Auh, S., Bell, S., McLeod, C., & Shih, E. (2007), "Co-production and customer loyalty in financial services", *Journal of Retailing*, Vol. 83, No. 3, pp. 359-370, doi:10.1016/j.jretai.2007.03.001.
- Bank of America (2015), *Trends in Consumer Mobility Report* (pp. 3-7). Bank of America. Retrieved from [http://newsroom.bankofamerica.com/files/doc\\_library/additional/2015\\_BAC\\_Trends\\_in\\_Consumer\\_Mobility\\_Report.pdf](http://newsroom.bankofamerica.com/files/doc_library/additional/2015_BAC_Trends_in_Consumer_Mobility_Report.pdf).
- Baumann, C., Elliott, G., & Burton, S. (2012), "Modeling customer satisfaction and loyalty: survey data versus data mining", *Journal of Services Marketing*, Vol. 26, No. 3, pp. 148-157, doi:10.1108/08876041211223951.
- Belás, J., Chocholáková, A., & Gabčová, L. (2015), "Satisfaction and loyalty of banking customers: a gender approach", *Economics & Sociology*, Vol. 8, No. 1, pp. 176-188, <http://dx.doi.org/10.14254/2071-789x.2015/8-1/14>.
- Bilgihan, A. (2016), "Gen Y customer loyalty in online shopping: An integrated model of trust, user experience and branding", *Computers in Human Behavior*, Vol. 61, pp. 103-113, <http://dx.doi.org/10.1016/j.chb.2016.03.014>.
- Bolton, R., Parasuraman, A., Hoefnagels, A., Migchels, N., Kabadayi, S., & Gruber, T. et al. (2013), "Understanding Generation Y and their use of social media: a review and research agenda", *Journal of Service Management*, Vol. 24, No. 3, pp. 245-267, doi:10.1108/09564231311326987.
- Brakus, J., Schmitt, B., & Zarantonello, L. (2009), "Brand Experience: What Is It? How Is It Measured? Does It Affect Loyalty?", *Journal of Marketing*, Vol. 73, No. 3, pp. 52-68, doi:10.1509/jmkg.73.3.52.
- Capgemini & Efma (2015), *World Retail Banking Report 2015*, Retrieved from <https://www.capgemini.com/thought-leadership/world-retail-banking-report-2015>.
- Capgemini & Efma (2016), *World Retail Banking Report 2016*, Capgemini and Efma, Retrieved from <https://www.capgemini.com/experts/thought-leadership/world-retail-banking-report-2016>.
- Capgemini (2014), "What Makes Gen Y Stick with a Bank? Explore how banks can increase acquisition and foster retention of Gen Y customers" (pp. 9-12). Capgemini. Retrieved from [https://www.capgemini.com/resource-file-access/resource/pdf/gen\\_y\\_whitepaper.pdf](https://www.capgemini.com/resource-file-access/resource/pdf/gen_y_whitepaper.pdf).
- Chahal, H., & Dutta, K. (2014), "Measurement and impact of customer experience in banking sector" *Decision*, vol. 42, no. 1, pp. 57-70, doi:10.1007/s40622-014-0069-6.
- Chavan, J., & Ahmad, F. (2013), "Factors Affecting On Customer Satisfaction in Retail Banking: An Empirical Study", *International Journal of Business and Management Invention*, Vol. 2, No. 1, pp. 55-62.
- EFMA (2014), *Mobile banking: The dawn of a new era for retail banks* (pp. 6-8), EFMA. Retrieved from [https://www.efma.com/ressources/studies/2014/1-YQ1TH\\_E\\_study.pdf](https://www.efma.com/ressources/studies/2014/1-YQ1TH_E_study.pdf).
- Erdem, T. & Swait, J. (1998), "Brand Equity as a Signaling Phenomenon", *Journal of Consumer Psychology*, Vol. 7, No. 2, pp. 131-157, [http://dx.doi.org/10.1207/s15327663jcp0702\\_02](http://dx.doi.org/10.1207/s15327663jcp0702_02).
- Erdem, T., Swait, J., & Louviere, J. (2002), "The impact of brand credibility on consumer price sensitivity", *International Journal of Research in Marketing*, Vol. 19, No. 1, pp. 1-19, [http://dx.doi.org/10.1016/s0167-8116\(01\)00048-9](http://dx.doi.org/10.1016/s0167-8116(01)00048-9).
- Erdem, T., Swait, J., & Valenzuela, A. (2006), "Brands as Signals: A Cross-Country Validation Study", *Journal of Marketing*, Vol. 70, No. 1, pp. 34-49, <http://dx.doi.org/10.1509/jmkg.2006.70.1.34>.
- Eroglu, S., Machleit, K., & Davis, L. (2003), "Empirical testing of a model of online store atmospherics and shopper responses", *Psychology and Marketing*, Vol. 20, No. 2, pp. 139-150, <http://dx.doi.org/10.1002/mar.10064>.
- Foscht, T., Schloffer, J., Maloles, C., & Chia, S. (2009), "Assessing the outcomes of Generation-Y customers' loyalty", *International Journal of Bank Marketing*, Vol. 27, No. 3, pp. 218-241, doi:10.1108/02652320910950204.
- Fraering, M., & Minor, M. (2013), "Beyond loyalty: customer satisfaction, loyalty, and fortitude", *Journal of Services Marketing*, Vol. 27, No. 4, pp. 334-344, doi:10.1108/08876041311330807.

- Frow, P., & Payne, A. (2007), "Towards the 'perfect' customer experience", *Journal of Brand Management*, Vol. 15, No. 2, pp. 89-101, doi:10.1057/palgrave.bm.2550120.
- Garg, R., Rahman, Z., Qureshi, M., & Kumar, I. (2012), "Identifying and ranking critical success factors of customer experience in banks", *Journal of Modelling in Management*, Vol. 7, No. 2, pp. 201-220, doi:10.1108/17465661211242813.
- Ghose, K. (2007), *In thought leaders international conference on brand management*, England: Birmingham Business School.
- González, M., Mueller-Dentiste, R., & Mack, R. (2008), "An alternative approach in service quality: e-Banking case", *Quality Management Journal*, Vol. 15, No. 1, pp. 41-58.
- Holbrook, M., & Hirschman, E. (1982), "The Experiential Aspects of Consumption: Consumer Fantasies, Feelings, and Fun", *The Journal of Consumer Research*, Vol. 9, No. 2, pp. 132-138, doi:10.1086/208906.
- Hulten, B. (2009), "Sensory marketing: the multi-sensory brand-experience concept", *European Business Review*, Vol. 23, No. 3(2011), pp. 256-273, doi:10.1108/09555341111130245.
- Ind, N., & Coates, N. (2013), "The meanings of co-creation", *European Business Review*, Vol. 25, No. 1, pp. 86-95, doi:10.1108/09555341311287754.
- Jain, R., & Bagdare, S. (2009), "Determinants of Customer Experience in New Format Retail Stores", *Journal of Marketing & Communication*, Vol. 5, No. 2, pp. 34-44.
- Juriscic, B., & Azevedo, A. (2010), "Building customer-brand relationships in the mobile communications market: The role of brand tribalism and brand reputation", *Journal of Brand Management*, Vol. 18, No. 4-5, pp. 349-366, doi:10.1057/bm.2010.37.
- Keller, K., Apéria, T., & Georgson, M. (2008), *Strategic brand management*. Harlow, England: Prentice Hall Financial Times.
- Koo, D. & Ju, S. (2010), "The interactional effects of atmospherics and perceptual curiosity on emotions and online shopping intention", *Computers in Human Behavior*, Vol. 26, No. 3, pp. 377-388, <http://dx.doi.org/10.1016/j.chb.2009.11.009>.
- Koo, D. & Lee, J. (2011), "Inter-relationships among dominance, energetic and tense arousal, and pleasure, and differences in their impacts under online vs. offline environment", *Computers In Human Behavior*, Vol. 27, No. 5, pp. 1740-1750, <http://dx.doi.org/10.1016/j.chb.2011.03.001>.
- Kotler, P & Keller, K. (2006), *Marketing Management*, England: Prentice-Hall.
- KPMG International (2014), *Customer Experience Barometer*, Switzerland: KPMG network. Retrieved from <https://www.kpmg.com/dutchcaribbean/en/Documents/Publications/customer-experience-barometer-v1-fs.pdf>.
- Krishna, A. (2012), "An integrative review of sensory marketing: Engaging the senses to affect perception, judgment and behavior", *Journal of Consumer Psychology*, Vol. 22, No. 3, pp. 332-351, doi:10.1016/j.jcps.2011.08.003.
- Leverin, A. & Liljander, V. (2006), "Does relationship marketing improve customer relationship satisfaction and loyalty?", *International Journal of Bank Marketing*, Vol. 24, No. 4, pp. 232-251, <http://dx.doi.org/10.1108/02652320610671333>.
- Levy, S. (2014), "Does usage level of online services matter to customers' bank loyalty?", *Journal of Services Marketing*, Vol. 28, No. 4, pp. 292-299, <http://dx.doi.org/10.1108/jsm-09-2012-0162>.
- Maathuis, O., Rodenburg, J., & Sikkels, D. (2004), "Credibility, Emotion or Reason?", *Corporate Reputation Review*, Vol. 6, No. 4, pp. 333-345, <http://dx.doi.org/10.1057/palgrave.crr.1540003>.
- Mazursky, D. & Jacoby, J. (1986), "Exploring the development of store image", *Journal of Retailing*, Vol. 62, No. 2, pp. 145-165.
- Meyer, C., & Schwager, A. (2007), "Understanding Customer Experience", *Harvard Business Review*, pp. 117-126, Retrieved from <http://hbr.org>.
- Morrison, S., & Crane, F. (2007), "Building the service brand by creating and managing an emotional brand experience", *Journal of Brand Management*, Vol. 14, No. 5, pp. 410-421, doi:10.1057/palgrave.bm.2550080.
- Mosley, R. (2007), "Customer experience, organizational culture and the employer brand", *Journal of Brand Management*, Vol. 15, No. 2, pp. 123-134, doi:10.1057/palgrave.bm.2550124.
- Murugiah, L., & Akgam, H. (2015), "Study of Customer Satisfaction in the Banking Sector in Libya", *Journal of Economics, Business and Management*, Vol. 3, No. 7, pp. 674-677, doi:10.7763/joebm.2015.v3.264.
- Nagurney, A. (2014), *Cyber security and Financial Services*, In *INFORMS Conference on Business Analytics & Operations Research*. Boston: Isenberg School of Management, University of Massachusetts Amherst, Massachusetts 01003. Retrieved from [https://supernet.isenberg.umass.edu/visuals/Boston\\_Analytics\\_INFORMS\\_Cybersecurity\\_Nagurney.pdf](https://supernet.isenberg.umass.edu/visuals/Boston_Analytics_INFORMS_Cybersecurity_Nagurney.pdf).

- Nysveen, H., Pedersen, P., & Skard, S. (2012), "Brand experiences in service organizations: Exploring the individual effects of brand experience dimensions", *Journal of Brand Management*, Vol. 20, No. 5, pp. 404-423, doi:10.1057/bm.2012.31.
- Oliver, R. (1980), "A Cognitive Model of the Antecedents and Consequences of Satisfaction Decisions", *Journal of Marketing Research*, Vol. 17, No. 4, pp. 460-469. doi:10.2307/3150499.
- Payne, A., Storbacka, K., & Frow, P. (2007), "Managing the co-creation of value", *Academy of Marketing Science*, Vol. 36, No. 36, pp. 83-96, doi:10.1007/s11747-007-0070-0.
- Pine II, B., & H. Gilmore, J. (1998), "Welcome to the experience economy", *Harvard Business Review*, Vol. 76, No. 4, pp. 97-105
- Prahalad, C., & Ramaswamy, V. (2004), "Co-creation experiences: The next practice in value creation", *Journal of Interactive Marketing*, Vol. 13, No. 3, pp. 5-14, doi:10.1002/dir.20015.
- Putnam, M. (2012), *Attracting and Retaining Gen Y and Gen X. Fis strategic insights*, Vol. 6, march 2012. Slideshare.net. Retrieved 8 May 2016, from <http://www.slideshare.net/pmcadam/fis-strategic-insights-vol-6-march-2012>.
- Rugimbana, R. (2007), "Generation Y: How cultural values can be used to predict their choice of electronic financial services", *Journal of Financial Services Marketing*, Vol. 11, No. 4, pp. 301-313, doi:10.1057/palgrave.fsm.4760048.
- Russell, J. & Mehrabian, A. (1977), "Evidence for a three-factor theory of emotions", *Journal of Research in Personality*, Vol. 11, No. 3, pp. 273-294, [http://dx.doi.org/10.1016/0092-6566\(77\)90037-x](http://dx.doi.org/10.1016/0092-6566(77)90037-x).
- Sahoo, R. & Swain, S. (2012), "Study of Perceived Value and Performance of E-Banking in India with a Special Reference to Punjab National Bank", *Indus Journal of Management & Social Sciences*, Vol. 5, No. 1, pp. 64-75.
- Schmitt, B. (1999), "Experiential Marketing", *Journal of Marketing Management*, Vol. 15, No. 1-3, pp. 53-67, doi:10.1362/026725799784870496.
- Schmitt, B. (2003), *Customer experience management*, New York: Wiley.
- Sherman, E., Mathur, A., & Smith, R. (1997), "Store environment and consumer purchase behavior: Mediating role of consumer emotions", *Psychology and Marketing*, Vol. 14, No. 4, pp. 361-378, [http://dx.doi.org/10.1002/\(sici\)1520-6793\(199707\)14:4<361::aid-mar4>3.0.co;2-7](http://dx.doi.org/10.1002/(sici)1520-6793(199707)14:4<361::aid-mar4>3.0.co;2-7).
- Syrett, M. & Lamminman, J. (2004), "Advertising and millennials", *Young Consumers*, Vol. 5, No. 4, pp. 62-73, <http://dx.doi.org/10.1108/17473610410814355>.
- Sweeney, J. & Swait, J. (2008), "The effects of brand credibility on customer loyalty", *Journal of Retailing and Consumer Services*, Vol. 15, No. 3, pp. 179-193, <http://dx.doi.org/10.1016/j.jretconser.2007.04.001>.
- Tesfom, G., & Birch, N. (2011), "Do switching barriers in the retail banking industry influence bank customers in different age groups differently?", *Journal of Services Marketing*, Vol. 25, No. 5, pp. 371-380, doi:10.1108/08876041111149720.
- Unyathanakorn, K., & Rompho, N. (2014), "Factors Affecting Customer Satisfaction in Online Banking Service", *Journal of Marketing Development and Competitiveness*, Vol. 8, No. 2, pp. 50-60.
- Vargo, S., & Lusch, R. (2004), "Evolving to a New Dominant Logic for Marketing", *Journal of Marketing*, Vol. 68, No. 1, pp. 1-17, doi:10.1509/jmkg.68.1.1.24036.
- Valentine, D., & T. Powers, T. (2013), "Generation Y values and lifestyle segments", *Journal of Consumer Marketing*, Vol. 30, No. 7, pp. 597-606, doi:10.1108/jcm-07-2013-0650.
- Viswanathan, V., & Jain, V. (2013), "A dual-system approach to understanding "generation Y" decision making", *Journal of Consumer Marketing*, Vol. 30, No. 6, pp. 484-492, doi:10.1108/jcm-07-2013-0649.
- Wernerfelt, B. (1988), "Umbrella Branding as a Signal of New Product Quality: An Example of Signalling by Posting a Bond", *The RAND Journal of Economics*, Vol. 19, No. 3, pp. 458-466, <http://dx.doi.org/10.2307/2555667>.
- Zarantonello, L., & Schmitt, B. (2010), "Using the brand experience scale to profile consumers and predict consumer behavior", *Journal of Brand Management*, Vol. 17, No. 7, pp. 532-540, doi:10.1057/bm.2010.4.

# THE OLIVE OIL PRICES DETERMINANTS FROM PRODUCTION TO RETAIL: A STUDY OF THE OLIVE OIL SECTOR IN PORTUGAL AND SPAIN

Lousas, Carla<sup>1</sup>; Ribeiro, Humberto<sup>2</sup>; Alves, Sandra<sup>1</sup>; Veloso, Cláudia<sup>3</sup>

<sup>1</sup>High School of Technology and Management, Polytechnic Institute of Bragança, Bragança, Portugal

<sup>2</sup>GOVCOPP, Águeda School of Technology and Management, University of Aveiro, Aveiro, Portugal

<sup>3</sup>Águeda School of Technology and Management, University of Aveiro, Aveiro, Portugal

## ABSTRACT

With this paper we examine the factors that influenced the evolution of the olive oil prices over the past 30 years in the Iberian Peninsula (Portugal and Spain). The research aims to study the olive oil sector, not only by the means of a brief characterization, but also by performing an empirical study focused on the determinants that may affect the olive oil market, regardless being on the production or on the retail side. Accordingly, the research uses a comprehensive dataset, examining factors from olive production related to olive oil market conditions, which impact on retail conditions and consumption, and including other economic variables as well. Covering the period from 1986 to 2015, the data was subject to statistic testing and validation using a multiple regression analysis model. Our results suggest the presence of a relationship between the olive oil prices and a set of several factors, such as climate conditions, olive cultivated area, gross national income, and olive oil production, number of mills, value of exports and consumption.

*Keywords: Olive oil prices, olive oil production, retail and consumption, international trade, socioeconomic conditions, Portugal and Spain*

## INTRODUCTION

In the Iberian Peninsula, which comprises Portugal and Spain, the production of olive oil, which is also referred in this paper simply as “oil”, is very high, despite there are other countries in the world, outside the Mediterranean basin, that also produce significant amounts, such as California, in the United States, or Argentina and Australia. The reason these countries are also producers is due to their climate properties, since, as in the Mediterranean, the temperature of several regions in these countries is moderate (Pires, 2005).



In addition to the use in food, the olive oil also serves for nutritional and therapeutic uses, prevents the onset of breast cancer and cervical cancer, as it has monounsaturated fatty acids which reduce the bad cholesterol, meaning that it is a healthy fat (Barranco *et al.*, 2001; Kiritsakis, 1992).

In Portugal, the largest olive areas are in the Alentejo and Trás-os-Montes regions (Ministério da Agricultura do Desenvolvimento Rural e das Pescas, 2007). In Spain, the main olive oil producing region is Andalusia (Barranco *et al.*, 2001; Consejería de Agricultura y Pesca, 2011). The evolution of prices depends on many factors, such as the production level, the economic level and social level.

With this paper we will examine the factors that possibly influence the price of oil in recent years, in Portugal and Spain. For this reason, we will observe and analyze several agricultural, atmospheric, and socio-economic factors.

The data obtained will be analyzed using an econometric model, an OLS regression. This paper is organised as follows. It first starts with a research on olive oil, to examine the causes which may justify the oil price changes in the Iberian Peninsula. Second, the assumptions to study and the methods to use are defined. Finally, following the data description, the results are shown and discussed, allowing to present our final conclusions.

## **THEORETICAL FRAMEWORK**

In any scientific research it is necessary to know and deepen the theme that will be handled. Thus we will start with a brief summary on the price of olive oil and the determinants that influence theoretically this variable, as the weather, imports and exports of the product, level of production, or socio-economic conditions of consumers.

### *Price of olive oil: definition and evolution*

The price of oil is the amount received per unit in cash, being added to this amount all the costs for the elaboration as well (Instituto Nacional de Estatística, 2003).

The olive oil market in the Iberian Peninsula improved when its countries joined the European Union in 1986 (Comissão Europeia da Agricultura e Desenvolvimento Rural, 2003).

By doing the analysis about the olive oil sector in Portugal, according to the INE report, when an increase in the base price occurs, it turns out that it was coincident with a bad agricultural year, meaning there were decreases in production volume. When the harvest season is good, as in 2009, the production volume gradually increases thus achieving a high supply and therefore a lower price (Instituto Nacional de Estatística, 2010 a).

### Atmospheric conditions

The climate is one of the most important determinants impacting the formation of olives and therefore the oil. This factor affects their development, producing best olive oil or worse in quality, so depending on atmospheric conditions harvest each year (Kiritsakis, 1992).

Water for olives to grow is one of the crucial variants, so that productivity is more and better because all olive development processes depend on water (Rodrigues & Correia, 2009).

### Level production

Olive oil production is greatly affected by weather conditions and by pests, therefore its production varies from year to year and therefore yields will also fluctuate (Pinto, 2003; Guerra, 2010).

The European Union (EU) produces about 75% of world production. The EU's largest oil producer is Spain (over 50% of EU production), followed by Greece and Italy (Tasdogan *et al.*, 2005).

As shown in Figure 1, over the last ten years the olive production suffered from volatility.

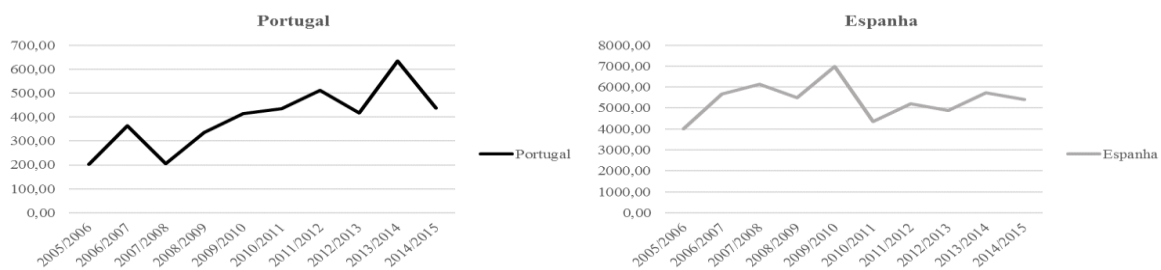

Figure 1. Difference of olive production between Portugal and Spain

Source: Adapted from collected data from INE (Instituto Nacional de Estatística) and MARM (Ministério do Medio Ambiente y Medio Ruaral Y Marino)

According to a study by INE regarding the harvest of 2014/2015 in Portugal there was a sharp drop compared to 2013/2014. This change was due to bad weather conditions. However, production in Portugal has been growing, with the exception of this last campaign, as seen in the previous figure (Instituto Nacional de Estatística, 2016).

The products on the market must be of top quality, so that in the retail the consumer is left satisfied at the time of purchase (Pires, 2005). "The commercial quality of a product is the set of characteristics or attributes which distinguishes them from other similar goods" (Pires, 2005, p.13).

The cultivated area is the sum of utilized agricultural area for the cultivation of olive trees (Instituto Nacional de Estatística, 2010 b; Gabinete de planeamento e política agro-alimentar & Direcção de serviços de produções vegetais, 2001).

According to figure 2, the area cultivated for the last 10 years in Portugal was initially gradually increased, however in the last 5 years a decrease occurred, while Spain recovers from a large drop that occurred in 2011/2012 and 2012/2013 campaigns. In figure 2 you can see that Portugal is still very far from reaching the values of neighbouring Spain.

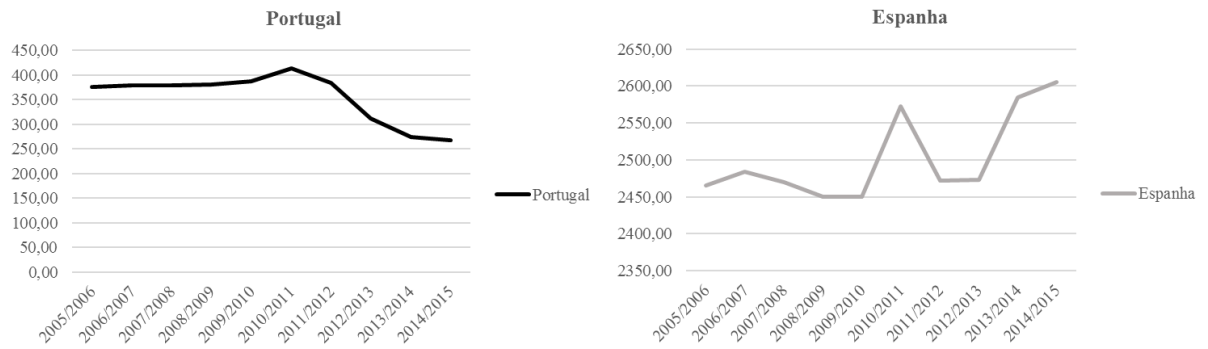

Figure 2. Cultivated area in the Iberian Peninsula (Portugal and Spain)

Source: Adapted from collected data from INE and MARM

An oil mill is an industrial plant where change olives and turn into different types of olive oil (Instituto Nacional de Estatística b), 2010).

Over the past few years the number of mills has been dramatically decreasing in Portugal, as more and more demands on the operating conditions are high. In 2014/2015 campaign only 474 mills were in operation for Portugal (Instituto Nacional de Estatística, 2016). While in the neighbouring country, in the same period there were around 1759 mills distributed throughout the country (Ministerio de Agricultura y Pesca, Alimentación y Medio Ambiente, 2015).

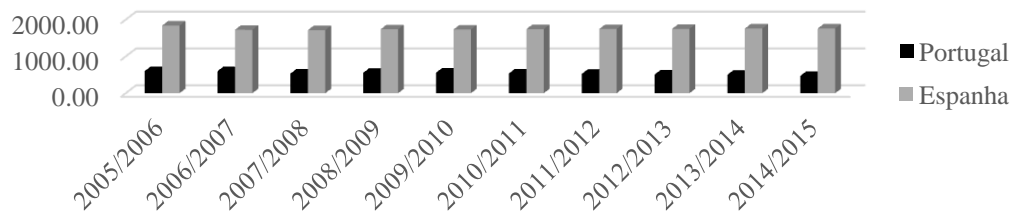

Figure 3. Number of oil mills in Portugal and Spain

Source: Adapted from collected data from INE and AAO (Agência para el aceite de oliva)

The economic level the good functioning of the mills depends on quantity, cost, the olive and the efficiency and effectiveness of the transformation (Pires, 2005).

#### Inputs and outputs

Imports of a product represent the entry of any well into a country (Instituto Nacional de Estatística, 1999). The balance of trade of olive oil in Portugal has about tons of olive oil imports 73500, the quantity of olive oil produced by Portugal just happy about 50% to 60% of the needs of the Portuguese consumption (Observatório dos Mercados Agrícolas e das Importações Agro-Alimentares, 2010).

The oil inputs to the Spanish region, for example in the 2009/10 harvest were only about 49.8 thousand tons (Consejería de Agricultura y Pesca, 2011).

Exports are equivalent to the outputs for international trade, i.e. is the trade of products for international countries (Instituto Nacional de Estadística, 1999).

At the moment the European Union is one of the main producers and as such is also the main exporters, since Spain is one of the main exporters, the harvest of 2014/15 were about 831,194 t (Ministerio de Agricultura y Pesca, Alimentación y Medio Ambiente, 2016).

The country with the largest portion of Portuguese exports is Brazil, which holds about 60% of total exports (Observatório dos Mercados Agrícolas e das Importações Agro-Alimentares, 2010).

#### *Socio-economic conditions of families*

In this case the household income is the total receipts acquired through social, received wages, net amounts resulting from work on their own or interest received (Rosa, 2010).

The human consumption, characterized by the quantities of a product or good that is available to the public, this product can be consumed in the initial medium or through industrial processing, in the latter case the oil is included (Instituto Nacional de Estadística, 2010 b).

As you can see in Figure 4, Spain had a very similar oil consumption over the past eight years, however in 2012/2013, there was a fall, and is now trying to exceed it. As for Portugal, the amount consumed is very similar over the last ten years represented in the figure below.

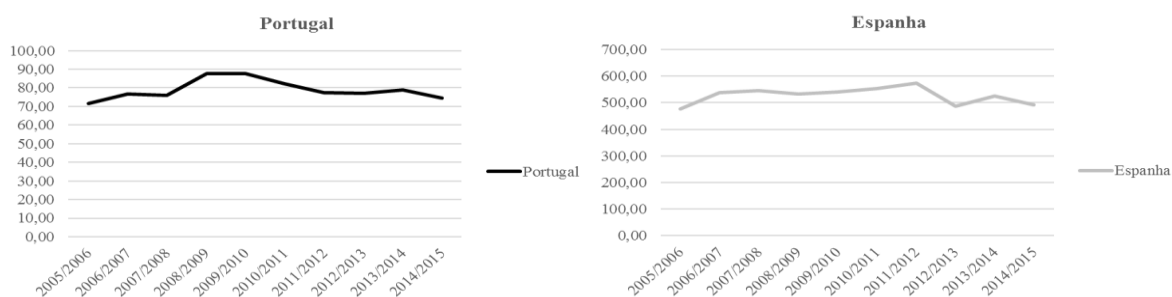

Figure 4. Consumption of olive oil in Portugal and Spain

Source: Adapted from collected data from COI (Conselho Oleícola Internacional Espanhol)

During the campaign of 2014/15 consumption of olive oil in Spain reached 492,200 tons (Ministerio de Agricultura y Pesca, Alimentación y Medio Ambiente, 2015). In Portugal the consumption of olive oil, according to the data in figure 4, in the 2014/2015 season was 74,450 tons (Instituto Nacional de Estadística, 2016).

## METHODOLOGY

This section provides the methodological part, consisting of the initial question, the construction of issues on his holding in the preparation and observation of an analysis model.

### *Description of the problem*

The starting question of this research is a scientific question, which includes a study of several variables and relationships between them. Which may result in new theoretical and scientific contributions. The research question in this paper is: “Which factors contribute significantly to the oil price variations in the Iberian Peninsula?”.

For the exploration of this topic, research was made on some subjects within the theme, such as: what are the biggest oil producers in Europe; the main factors that influence the price of this well for the countries covered by the research; and how the changes in the price of oil in the Iberian Peninsula occurred over the last 30 years.

With this research we are going to analyze the variables that influence the evolution of the price of oil, and from this basis an analysis model has been prepared enabling to understand, determine, and study the factors that influence the price of olive oil in the Iberian Peninsula.

The data for the arrangement of this analysis were obtained through literature searches, readings of various documents and some statistical databases such as the Portuguese and Spanish INE, Pordata, IOC (International Olive Council), and MARM, among others.

### *Construction of the analysis model and research hypotheses*

The analysis model considers several factors that possibly influence the price of oil (dependent variable) in the Iberian Peninsula. The independent variables were divided into groups, as can be seen in figure 5, below, together with a set of research hypotheses.

The following figure describes the analysis model that demonstrates the possible influence of the independent variables in the price of oil in order to answer the initial question.

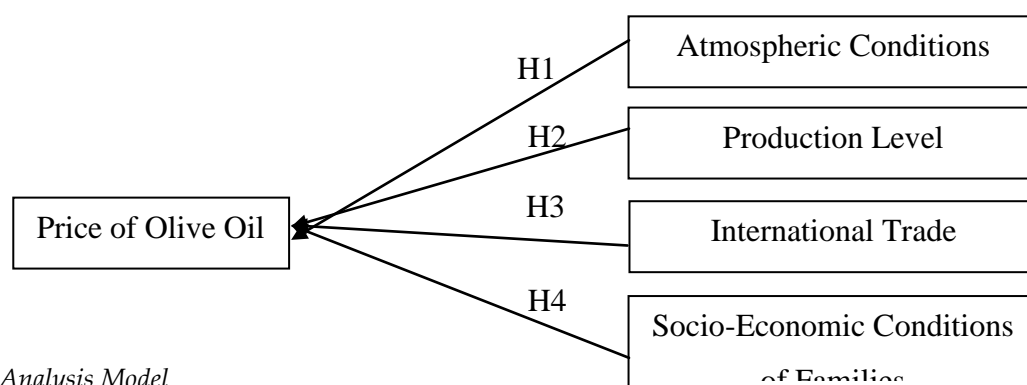

Figure 5. Analysis Model

According to the model shown in Figure 5, the following research hypotheses are to be tested:

**H1:** The price of oil is influenced by weather factor, called C (Weather in degrees centigrade (°C)); and PM (Average precipitation in millimetres (mm)), in the Iberian Peninsula;

**H2:** The price of oil is influenced by the level of production factor PA (Oil production in tonnes (t) in Spain and Portugal in hectolitres (hl)); PAO (Production of olives as thousand tonnes (1000t)); SC

(Cultivation of olive trees measured in thousand hectares (ha)); and LA (Number of mills)) in Spain and Portugal;

**H3:** The price of oil is influenced by inputs and outputs: E (Exports of olive oil to Portugal are measured in euros (€), while for Spain are measured in tonnes (t)); and I (Imports of olive oil to Portugal are measured in euros (€), while for Spain are measured in tonnes (t)); in the Iberian Peninsula;

**H4:** The price of oil is influenced by socio-economic conditions of the Portuguese and Spanish families: RNB (Gross national income in thousands of euros (10<sup>6</sup>€); and CA (Consumption of olive oil in metric tonnes (t)).

Analysis of the information previously collected needs to run several steps to obtain valid results. The first step is the preparation of data for the period to be examined, together with the research variables, which allow to calculate the descriptive statistics, the correlation matrix, and other statistics, using Gretl program. The second step is the evaluation of the relationship between variables, being this ratio is calculated through the OLS technique. This method is a mathematical optimization technique, which seeks to find the best fit for the data, ie. an estimate of demand parameters to fit a certain function of a dataset, being this function linear or nonlinear. The data adjustment results from the minimization of the sum of squares of the regression residuals to maximize the degree of adjustment. In order to test the absence of heteroscedasticity the White test was used, while to test the absence of autocorrelation we used the Durbin-Watson statistic test (Johnston & Dinardo, 1997).

## RESULTS

### *Preliminary analysis of the data*

Throughout the research, there were some difficulties faced. In the first place, not always was possible to find similar variables across the two countries; and, secondly, to find that these variables calculated with the same numerical metrics/quantities.

Accordingly, there two stages followed: the first, was to study the variables for the years 1986 to 2015, being this study carried out for both countries, but separately. The second step was to study every common variables for both countries.

With this second step, we intended to get better results, having a better understanding of the variables that influence the price of oil for both countries, simultaneously.

### *Descriptive statistics*

In Table 1 are depicted the descriptive statistics for Portugal, for the years 1986 to 2015; and Table 2 shows the descriptive statistics for Spain, for the period 1986 to 2015, as well. The tables constructed

for this paper are all placed in the appendices. These tables analyze the changes that have occurred in recent years, showing descriptive statistics according to the study steps listed previously in this paper. Over the years of study, concerning Portugal, depicted in Table 1, are shown some decreases in percentages, standing out variable I as the sharpest. Regarding the following ten years examined, there are some increases, although in some cases negligible, distinguishing CA as the most significant increase.

Observing Table 1, it appears that every final percentages are practically positive, with only three variables with negative percentages: PGA2, which represents Olive oil production, with the degrees of acidity between 2,1° the 3,3°, being measured in tonnes (t) for Spain, and for Portugal in hectolitres (hl); LA; and C.

Regarding the variations registered for Spain, available in Table 2, the oscillations are substantially positive. In the second case, is observed that there is only a negative percentage to atmospheric variables (C, PM), although the percentage meaning is negligible. By taking into account the overall variation is denoted that the percentage is always positive, with the exception again of the PM variable.

#### *Correlation Matrix*

Tables 3 and 4, which are shown in appendices, represent correlation matrices for the hypotheses tested. According to the hypothesis entered in Table 3, depicting Portugal correlation matrix, for the years 1986 to 2015, are highlighted the variables with the highest correlations values: PAO and PA; being another example RNB with CA. As for the Spanish country, according to Table 4, depicting correlation matrixes for 1986 to 2015, are underlined the variables SC and RNB, as the ones with the highest correlation values.

#### *Analysis of the factors behind the variations of the price of olive oil*

To examine whether indeed the variables studied influence the price of oil, an estimation using an OLS regression was performed. The following regression equations support the models developed here:

1) Equation for Portugal, including all Portuguese variables available:

$$\gamma PCA = \alpha_i + \beta_1 Ci + \beta_2 PMi + \beta_3 PAi + \beta_4 PAOi + \beta_7 SCi + \beta_8 LAi + \beta_9 Li + \beta_{10} Ei + \beta_{11} RNBi + \beta_{12} CAi + \epsilon_i$$

2) Equation for Portugal, employing common variables with Spain only:

$$\gamma PCA = \alpha_i + \beta_1 Ci + \beta_2 PMi + \beta_3 PAi + \beta_4 PAOi + \beta_5 SCi + \beta_6 Li + \beta_7 Ei + \beta_8 RNBi + \beta_9 CAi + \epsilon_i$$

3) Equation for Spain, including all Spanish variables available:

$$\gamma PCA = \alpha_i + \beta_1 Ci + \beta_2 PMi + \beta_3 PAi + \beta_4 PAOi + \beta_5 SCi + \beta_6 Li + \beta_7 Ei + \beta_8 RNBi + \beta_9 CAi + \epsilon_i$$

Where:

$\gamma_{PCA}$  - Current prices of olive oil in million euros (10<sup>6</sup>€)

$i$  - the study period;

$\alpha_i$  - Constant term;

$\beta$  - Coefficient of explanatory variables;

$\epsilon_i$  - Error term.

The equations were estimated using OLS, examining which factors affect most the price of oil over the last 25 years (1991-2015).

#### *Analysis of the results*

The variables significance and importance are depicted in the regression tables, shown in tables 5 and 6, in annex. At this stage were only considered the years 1991 to 2015 (25 years), so therefore allowing the significance level to be higher.

Table 5, representing regressions of variables for Portugal, depicts the various regression models for Portugal; while Table 6, showing regressions of variables for Spain, presents the models for Spain.

For Portugal, three multiple regression models were prepared. Model 1 includes all study variables, while Model 2 includes the variables that improve the final results obtained from the model 1 only. In Model 3 are considered only the common variables available for both countries.

As for Spain, a similar method was adopted. The Model 1 includes all the existing Spanish variables, and Model 2 shows only the variables that improve Model 1.

Tables 5 and 6, in appendices, show the determination coefficients and the overall significance test (test F) for all regressions. White test was used to test whether the models are or not heteroscedastic, and the Durbin-Watson test was employed to test the models in terms of autocorrelation.

Along the Table 5 and 6 are also shown the respective coefficients and standard deviations, representing the following levels of significance: statistically significant variables at 10%, 5%; and 1%, shown as \*, \*\*, and \*\*\*, respectively.

Following the first multiple regression analysis for Portugal (model 1), the results obtained were not good as expected. Nevertheless, it was possible to suggest that some variables influence the price of oil, namely C; SC, and E, all within the 5% significance level. The first model respects the White test and the Durbin-Watson test, ie there is no heteroscedasticity and autocorrelation, despite being a model with some degree of collinearity for a few variables: C; PA; PAO; LA; I; E and RNB. The second model was prepared in order to improve the first one, hoping to get better results, while removing the variables with higher multicollinearity (PA; PAO; I; and RNB). For Model 2, the variables with some significance level were: CA (10% only); C with 5%; and LA and E with 1%. This model has no heteroscedasticity, autocorrelation, or collinearity issues.



Concerning the third model, as for model 1, we note the absence of autocorrelation and heteroscedasticity. Nevertheless, some variables present some degree of collinearity: PA; PAO; I; E, and RNB. Variables found to be significant include: C (10% only); SC and E, at 5%; and RNB at 1%. As for the quality of the regression adjustment, Table 5, in annex, suggests that the models are statistically significant. The determining coefficients have similar values, approximately at 95%.

The analysis for Spain is composed by two models, as shown in Table 6, included in annexes. The first model results have some differences comparing with the Model 3 of Portugal. Here the significant variables are: RNB (10% only); SC at 5%; and PA and CA at 1%. The SC variable is commonly significant for both countries, as well as RNB, although it has a different significance level. This model registers an absence of autocorrelation, heteroskedasticity, and collinearity. The second model for Spain has been improved, compared to the first Spanish model. This improvement was possible by removing the following variables: C; PM; I; and E. As a result, the variables with the highest level of significance were: SC at 5%; and PA, RNB, and CA, at 1%. This model also respects the absence of collinearity, autocorrelation and heteroscedasticity. As for the correlation coefficients, both regressions exhibit identical values of 97%.

## DISCUSSION OF RESULTS

In this section we present the major findings, concerning the proposed research hypotheses testing. Due to space constraints, this section is focusing on the results for each hypothesis developed and depicted before in this paper.

**H1:** *The price of oil is influenced by weather factors (C and PM) in the Iberian Peninsula.*

The price of oil is influenced by C variable in every model constructed for Portugal (Table 5, appendices), suggesting to conclude that C, when changing from normal conditions, can influence the price of oil. Therefore we cannot reject this hypothesis for Portugal. As for PM variable, as the relationship is non-existent for both Portugal and to Spain, then one can suggest the partial rejection of this hypothesis, regarding PM only. Globally one cannot reject this hypothesis.

**H2:** *The price of oil is influenced by the level of production factor (PA; PAO, SC, and LA) in Spain and Portugal.*

PA influences only the price of olive oil in the regression 1 and 2 for Spain. There is a high significance level for the price of oil, and depending on the production the price of oil changes. As for PAO, significance level is non-existent for both countries. When analyzing SC, we note that is significant for the price of olive oil for both countries compared, which means it is a price influencer variable, because the more it is cultivated, more supply can exist for the product, and will soon influence its price. As for LA variable, we can just analyze for Portugal, because we could not gather enough data

for Spain. By analyzing this variable to Portugal, its degree of significance is very good, as shown in the model 2. With regard to the hypothesis testing, it may be rejected only completely for PAO variable, because all other variables influence the price of oil, although in different ways. Globally one cannot reject this hypothesis.

**H3:** *The price of oil is influenced by international trade, inputs and outputs (E and I), in the Iberian Peninsula.*

When analyzing E variable, we observe that has influence on the price of oil to Portugal only. However the economic level of this factor is important because the more a country exports a product, more revenue come by improving the trade balance. Therefore, for the variable E, we cannot reject this hypothesis. As for I, it appears to do not influence the price of oil in any case, so for this variable, one could suggest to reject the hypothesis. Nevertheless, globally one cannot reject this hypothesis.

**H4:** *The price of oil is influenced by socio-economic conditions of the Portuguese and Spanish families (RNB and CA).*

When analyzing the variable RNB for Portugal and Spain, one obtained significance levels of 1%, to 3 model in Portugal, and to model 2 in Spain. As for CA, it is significant for Spain, as shown in models 1 and 2. For Portugal, CA is significant in model 2 also, despite having a significance level at 90% only. Therefore, one can suggest that the price of oil is influenced by socio-economic conditions, as referred before, meaning that globally this hypothesis cannot be rejected as well.

## CONCLUSIONS

Throughout this paper were studied factors possibly influencing the determination of the prices of olive oil in Spain and Portugal. To achieve results, it was necessary to find an appropriate dataset, supported by reliable sources. The databases found allowed to gather data enabling to construct twelve research variables for Portugal, and nine research variables for Spain, over 30 years. Using this dataset, several tests were performed, forcing to fit the models, reducing the analysis timespan for 25 years, allowing this way to obtain some variables with statistical significance, being ultimately adopted ten variables for Portugal and nine for Spain.

One limitation of this study is concerning some difficulties to obtain data for variables that should be equal or similar for both countries analysed. As a consequence of this lack of data uniformity we could not use two variables for Spain. This lack of consistency within the time series also forced the authors to reduce the period of analysis.

This paper aimed to achieve more knowledge about the determinants of the prices of oil, in particular to understand which variables influence more the prices of oil, in a statistically manner, and to examine whether such variables would produce similar results for the two countries under study.

The factors that we found to contribute most significantly to the interdependence and causality in the prices of oil in the Iberian Peninsula are: SC and RNB. According to the models used, the variables with more weight in determining the price of oil for Portugal are C; LA; E; and CA. However, for Spain the most significant variables are: PA; SC; RNB; and CA.

Overall, the results obtained suggest the presence of a relationship between the olive oil prices and a set of several factors, such as climate conditions, olive cultivated area, gross national income, and olive oil production, number of mills, value of exports and consumption.

As a suggestion for further research, we would like to recommend expanding the scope of analysis, possibly increasing the number of years of study. Furthermore, studying other olive oil-producing countries, such as Italy and Greece, would increase the dataset, possibly adding further interesting insights. It would also be interesting to add some other research variables, such as the income of farmers, subsidies and aid for production, or the number of olive trees negotiated. The use of such variables is obviously depending of an enhancement of the statistical databases across the major countries producing olive oil.

## ACKNOWLEDGEMENTS

*This work was financially supported by the research unit on Governance, Competitiveness and Public Policy (project POCI-01-0145-FEDER-006939), funded by FEDER funds through COMPETE2020 - Programa Operacional Competitividade e Internacionalização (POCI) – and by national funds through FCT - Fundação para a Ciência e a Tecnologia.*



## REFERENCES

- Barranco, D., Fernández-Escobar, R., & Rallo, L. (2001). *El cultivo del olivo* (3ª Edición ed.). Madrid: Grupo Mundi-Prensa.
- Comissão Europeia da Agricultura e Desenvolvimento Rural. (2003). *Agricultura e Desenvolvimento Rural*. Retrieved 2016, 24-Março from Comissão Europeia: [ec.europa.eu/agriculture/eval/reports/oliveoil/sum\\_en.pdf](http://ec.europa.eu/agriculture/eval/reports/oliveoil/sum_en.pdf).
- Consejería de Agricultura y Pesca. (2011). *Análisis de mercado del aceite de oliva. Campaña 2009/2010*. Retrieved 2016, 31-Maio from Junta de Andalucía: <http://www.juntadeandalucia.es/agriculturaypesca/portal/export/sites/default/comun/galerias/aleriaDescargas/cap/servicioestadisticas/Estudioseinformes/agricultura/olivar/oli11021400.pdf>.
- Gabinete de planeamento e política agro-alimentar & Direcção de serviços de produções vegetais. (2001). *Organização comum de mercado do sector do azeite*. Lisboa: Gabinete de planeamento e política agro-alimentar (GPPAA).

- Guerra, I. R. (2010). Análisis cuantitativo y cualitativo del significado del aceite de oliva. Una aproximación desde el punto de vista del consumidor. Granada: Editorial de la Universidad de Granada.
- Instituto Nacional de Estatística. (1999). Balança alimentar portuguesa 1990-1997. Lisboa: INE-Instituto Nacional de Estatística.
- Instituto Nacional de Estatística. (2003). Estatísticas agrícolas 2002. Lisboa: INE- Instituto Nacional de Estatística.
- Instituto Nacional de Estatística. (2010 a). Contas económicas da agricultura 1980-2009. Lisboa: INE Instituto Nacional de Estatística.
- Instituto Nacional de Estatística. (2010 b). Estatísticas Agrícolas 2009. Lisboa: INE.
- Instituto Nacional de Estatística. (2016). Estatísticas Agrícolas 2015. Lisboa: INE.
- Johnston, J., & Dinardo, J. (1997). *Econometric Methods*. California: Mc Graw Hill .
- Kiritsakis, A. K. (1992). El aceite de oliva. Madrid: A. Madrid Vicente. Ministério da Agricultura do Desenvolvimento Rural e das Pescas (2007 Fevereiro).
- Olivicultura-diagnóstico sectorial (2016). Retrieved 2016 18-Abril from MADRP: [http://www.gppaa.min.agricultura.pt/pbl/diagnosticos/Azeite\\_\\_Diagnostico\\_Sectorial.pdf](http://www.gppaa.min.agricultura.pt/pbl/diagnosticos/Azeite__Diagnostico_Sectorial.pdf).
- Ministerio de Agricultura y Pesca, Alimentación y Medio Ambiente. (2015). Encuesta sobre superficies y rendimientos de cultivo. Madrid: Ministerio de Agricultura, Alimentación Medio Ambiente. Obtido de Ministerio de Agricultura y Pesca, Alimentación y Medio Ambiente: <http://www.mapama.gob.es/es/agricultura/temas/producciones-agricolas/aceiteoliva-y-aceituna-mesa/>.
- Ministerio de Agricultura y Pesca, Alimentación y Medio Ambiente . (2016). Comercio Exterior del aceite de oliva español-campaña 2014/2015. Madrid: Gobierno de España.
- Observatório dos Mercados Agrícolas e das Importações Agro-Alimentares. (2010). Evolução da balança de pagamentos no sector do azeite entre 2000 e 2009. Retrieved 2011 01-Junho from Confagri: <http://www.confagri.pt/Download/Balan%C3%A7aAzeite.pdf>.
- Pinto, L. (2003). Azeite e ambiente. Retrieved 2016 13-Abril from Cofederação Nacional da Agricultura: em: <http://www.cna.pt/atautor.htm>.
- Pires, D. R. (2005). Estudo de Valorização Comercial do Azeite. Jornada do Azeite de Trás-os-Montes (p. 57). Mirandela: Instituto Politécnico de Bragança - Escola Superior Agrária.
- Rodrigues, M. Â., & Correia, C. M. (2009). Manual da safra e contra a safra do olival. Bragança: Instituto Politécnico de Bragança-IPB.
- Rosa, M. J. (2010). Rendimento e poupança das famílias. Retrieved 2011 06-Junho from Pordata - Base de dados Portugal contemporâneo: <http://www.pordata.pt/Site/Workspace.aspx>.
- Tasdogan, C., Tsakiridou, E., & Konstadinos, M. (2005). Country market power in UE olive oil trade. Thessaloniki, Greece: South-Eastern Europe Journal of Economics.

## APPENDICES

Table 1. Descriptive statistics of Portugal for several periods from 1986 to 2015

Year	YPC A	C	PM	PA	PAO	PGA 1	PGA 2	SC	LA	I	E	RNB	CA
$\Delta$ 1986- 1990	392,9 4%	4,68 %	17,0 4%	23,70 %	103,4 3%	- 11,97 %	88,12 %	0,54 %	2,45 %	1942,1 2%	231,46 %	111,9 9%	- 11,5 4%
$\Delta$ 1990- 2000	31,50 %	- 4,62 %	- 23,5 8%	- 15,30 %	- 28,11 %	53,67 %	- 95,62 %	8,36 %	- 37,7 2%	113,32 %	153,84 %	155,9 5%	92,7 5%
$\Delta$ 2000- 2010	46,28 %	4,48 %	6,37 %	80,35 %	29,24 %	- 25,80 %	11,99 %	4,84 %	- 36,5 0%	109,60 %	218,90 %	38,08 %	31,5 8%
$\Delta$ 2011- 2015	- 19,11 %	- 7,44 %	7,46 %	- 2,42%	5,62 %	192,6 2%	930,9 8%	- 30,9 8%	- 15,6 6%	23,16 %	162,98 %	5,12 %	- 14,9 1%
$\Delta$ 1986- 2015	667,0 6%	- 3,45 %	2,23 %	84,39 %	99,61 %	193,7 0%	- 4,96 %	- 21,1 6%	- 65,8 3%	11145, 02%	6955,9 7%	687,6 0%	90,9 0%
<b>Average</b>	4,17	15,8 1	836, 98	46400 1	306,4 7	2101 80	1033 82	350, 81	854, 77	108468 ,00	87837, 10	1,12E +08	61,9 5
<b>Median</b>	4,07	15,7 4	824, 44	42421 0	287,9 2	1876 68	6352 5,9	340, 63	770, 00	101198 ,00	56704, 20	1,21E +08	61,5 0
<b>Standard Deviation</b>	1,96	0,43	180, 18	19019 8	118,0 0	7370 2,2	1024 95	31,4 8	338, 34	75783, 40	95303, 50	5,04E +07	17,1 4
<b>Minimum</b>	0,59	14,9 1	551, 00	15729 3	110,3 3	1218 34	6908, 23	267, 01	474, 00	2090,0 2	5285,9 2	2,16E +07	27,0 0
<b>Maximum</b>	8,06	16,7 7	1180 ,21	99985 3,00	634,2 1	5277 16	3407 71	441, 34	1700 ,00	284100 ,00	37297 3,00	1,74E +08	87,5 0

PGA1 – Olive oil production in the degrees of acidity between 2 and 0,1<sup>o</sup>, in tonnes (t) to Spain, and for Portugal in hectolitres (hl)

Table 2. Descriptive statistics of Spain for several periods from 1986 to 2015

Year	YPCA	C	PM	PA	PAO	SC	I	E	RNB	CA
$\Delta$ 1986-1990	-21,80%	3,45%	27,41%	38,67%	48,06%	0,60%	299557,14%	-56,52%	60,61%	-2,49%
$\Delta$ 1990-2000	241,30%	-1,71%	-3,67%	21,20%	17,46%	12,64%	254,17%	135,07%	112,17%	29,50%
$\Delta$ 2000-2010	-24,95%	4,25%	4,92%	107,39%	101,50%	3,60%	-54,28%	140,10%	79,21%	7,32%
$\Delta$ 2011-2015	54,34%	-5,33%	-32,45%	-39,16%	-22,26%	6,34%	137,75%	26,70%	1,13%	-8,75%
$\Delta$ 1986-2015	209,15%	0,36%	-13,02%	112,04%	172,44%	24,85%	1153442,86%	210,92%	517,57%	23,67%
<b>Average</b>	1661,30	15,24	588,08	893,98	4219,40	2334,80	71337,00	469840,00	6,40E+05	493,07
<b>Median</b>	1729,70	15,33	575,75	839,55	4314,60	2396,90	66216,00	447940,00	6,00E+05	497,40
<b>Standard Deviation</b>	714,10	0,52	112,63	385,76	1478,20	179,46	47756,00	257430,00	3,22E+05	81,13
<b>Minimum</b>	499,87	14,19	373,00	336,08	1694,20	2086,70	14,00	116242,00	1,69E+05	352,10
<b>Maximum</b>	3176,10	16,09	841,00	1781,50	6982,52	2605,20	161500,00	1102900,00	1,08E+06	631,20

Table 3. Correlation matrix for Portugal for the period from 1986 to 2015

YPCA	C	PM	PA	PAO	PGA1	PGA2	SC	LA	I	E	RNB	CA	
1,000	-0,079	-0,045	0,557	0,554	0,244	-0,239	-0,174	-0,302	0,545	0,554	0,404	0,465	YPCA
	1,000	0,230	-0,135	-0,043	-0,273	0,171	0,231	-0,028	0,030	-0,238	0,036	0,047	C
		1,000	-0,079	0,004	0,146	0,480	0,105	0,139	-0,187	-0,154	-0,163	-0,153	PM
			1,000	0,944	0,340	-0,130	-0,204	-0,249	0,653	0,740	0,481	0,497	PA
				1,000	0,320	0,001	-0,261	-0,162	0,584	0,689	0,388	0,368	PAO
					1,000	0,064	-0,362	-0,132	0,346	0,439	0,256	0,227	PGA1
						1,000	-0,380	0,750	-0,505	-0,335	-0,687	-0,634	PGA2
							1,000	-0,253	-0,028	-0,367	0,272	0,287	SC
								1,000	-0,791	-0,647	-0,918	-0,808	LA
									1,000	0,841	0,906	0,880	I
										1,000	0,713	0,632	E
											1,000	0,936	RNB
												1,000	CA

Table 4. *Correlation matrix for Spain for the period from 1986 to 2015*

YPCA	C	PM	PA	PAO	SC	I	E	RNB	CA	
1,000	0,383	0,268	0,340	0,465	0,704	0,399	0,549	0,649	0,713	YPCA
	1,000	0,509	0,250	0,281	0,259	0,111	0,059	0,176	0,360	C
		1,000	0,393	0,400	0,277	-0,079	0,126	0,169	0,539	PM
			1,000	0,722	0,719	0,093	0,777	0,726	0,791	PA
				1,000	0,705	0,251	0,675	0,711	0,724	PAO
					1,000	0,436	0,848	0,916	0,798	SC
						1,000	0,271	0,474	0,071	I
							1,000	0,890	0,694	E
								1,000	0,697	RNB
									1,000	CA

Table 5. *Regressions results for the models using Portuguese variables*

Variables	Model 1	Model 2	Model 3
Constant			
C	-0,921776**	-0,889472**	-0,617449*
PM	2,31E-04	5,72E-05	1,83E-04)
PA	1,78E-06		4,83E-06
PAO	2,92E-03		5,45E-03
SC	0,0415966**	0,0182671	0,0457204**
LA	4,33E-03	7,66E-03***	
I	2,05E-05		2,05E-05
E	2,40E-05**	1,95E-05***	2,50E-05**
RNB	-6,60E-08		-1,08E-07***
CA	0,0639107	0,0631602*	0,0874804
N	25	25	25
R-squared	0,959198	0,950549	0,955879
R-sq. adjusted	0,717717	0,657887	0,694760
P(F)	1,33E-08	2,17E-11	3,64E-09
P(White)	0,294766	0,844235	0,262483
P(DW)	0,366121	0,420634	0,32333

Table 6. *Regressions results for the models using Spanish variables*

Variables	Model 1	Model 2
Constant		
C	157,298	
PM	-0,12937	
PA	-1,67478***	-1,54198***
PAO	-0,0879971	-0,0642129
SC	-2,47966**	-0,893153**
I	3,79E-03	
E	1,14E-03	
RNB	1,22E-03*	1,57E-03***
CA	11,0738***	9,05071***
N	25	25
R-squared	0,978438	0,971760
R-sq. adjusted	0,777278	0,708302
P(F)	1,27E-11	8,80E-15
P(White)	0,193698	0,242255
P(DW)	0,144972	0,0629425



## EFFECT OF EMPLOYEE THRIVING ON INNOVATIVE WORK BEHAVIOUR

Lyndon, Shiji<sup>1</sup>; Rawat, Preeti<sup>1</sup>; Varghese, Billy Sam<sup>2</sup>

<sup>1</sup>HR Department, K.J. Somaiya Institute of Management Studies and Research, Mumbai, India

<sup>2</sup>UESI, New Delhi, India

### ABSTRACT

The purpose of the present study was to advance the literature on thriving by examining its influence on innovation in organizations. We posited positive linkage between employee thriving and innovative behaviour at workplace. The study adopted survey method to test the hypotheses. Data was collected from a sample of 223 employees working in service sector. As hypothesized, results suggest that the experience of thriving at work leads to employees engaging in innovative work behaviour. The results also suggest that amongst the two dimensions of thriving i.e. learning and vitality, learning opportunities is a better predictor of innovative work behaviour.

*Keywords: thriving, vitality, learning, innovative work behaviour*

### INTRODUCTION

Work constitutes a very important aspect of an individual and society's life. It is demonstrated by the fact that a significant amount of time of an individual's life is spent at the workplace and work also contributes greatly to the socio-economic development of any society (Harpaz, 1990). Despite the importance of work, research shows that work is a major contributor of stress (Sonnentag and Frese, 2003). However, work can also be a major source of thriving of an individual (Niessen et al., 2012). Thriving refers to psychological state wherein individuals experience positive energy and learning. Opportunities to thrive at work leads to positive outcomes. Past research has shown that thriving is an important antecedent to employee health and well-being (Shirom, Toker, Berliner, Shapira, and Melamed, 2008; Spreitzer et al., 2005), performance (Carmeli et al., 2009), leads to organizational citizenship behaviour (Porath et al., 2007) and thriving also stimulates proactivity at work (Ashby, Isen, and Turken, 1999; Carmeli, Ben-Hador, et al., 2009). Studies also show how experience of thriving can reduce burnout of an individual (Maslach, 2003).

Innovation is one of the key strategies identified by business organization to improve firm performance in the ever changing competitive environment (Han, Kim and Srivastava, 1998; Weerawardena, O'Cass and Julian, 2006). Past studies have investigated the influence of leadership

(Yidong and Xinxin, 2013) and organizational climate (Oldham and Cummings, 1996) on innovative work behaviour. Innovation is not part of the institutionalized system of practices (Janssen, 2005) hence organizational members who are change averse and are committed to existing processes (Dougherty and Heller, 1994; Kanter 1988) would neither themselves engage nor encourage innovative behaviour in the organization. Hence its an interesting question to find out what leads individual members to engage in innovative work behaviour. The objective of this research is to find out the linkages between thriving and innovation. And also to study the dimensions of thriving (vitality and) learning and its influence on innovative behaviour at workplace. The study contributes to the field by examining how employee experience of vitality and learning opportunities stimulate employees to engage in innovative behaviour at workplace.

## **THRIVING**

Spreitzer, Sutcliffe, Dutton, Sonenshein, and Grant (2005 : 538) defined thriving as “the psychological state in which individuals experience both a sense of vitality and a sense of learning at work”. Individuals who experience thriving feel alive and energetic about their work and feel they are growing because of the learning opportunities (Spreitzer et al., 2005). Thriving is a temporary psychological state and not an enduring disposition (Chaplin et al., 1988).

The two essential conditions of thriving are vitality and learning. Vitality refers to feeling of energy and aliveness (Nix, Ryan, Manly and Deci; 1999). Learning refers to opportunity for growth and development by acquiring required skills and competencies. Thriving is closely linked to personality growth and hence a continuous process and not a onetime activity (Ryff, 1989). Vitality without learning does not lead to thriving as it would not provide opportunities for the individual to flourish. While, learning without vitality shall not lead to positive outcomes as the individual might not be motivated to exhibit newly acquired competencies at work place (Spreitzer et al., 2005). Thus, thriving includes both affective (vitality) and cognitive (learning) aspects of psychological state (Spreitzer et al., 2005).

Thriving is not a dichotomous state where an employee either experiences thriving or not. Instead, it is a continuous experience where an individual may experience less or more thriving. Sonenshein (2005) conducted a qualitative study which captured both vitality and learning dimensions of thriving.

Spreitzer et al. (2005) developed a socially embedded model of thriving at work place which is based on the assumption at individuals thrive in the context of their situations in which they are placed. It is based on two dimensions of work i.e. the contextual features of the work unit and the resources which are produced while doing the work. The model explains how the contextual factors of the work

(decision making discretion, information sharing, climate to trust and respect) leads to agentic work behaviour (task focus, exploration, heedful relating) which leads to thriving at workplace. Further, the agentic behaviour of the individuals produces resources (knowledge, positive meaning, positive affective resources, relational resources) which again leads to experience of thriving. The model also explains how experience of thriving at work leads to positive outcomes such as healthy adaptation to work environment leading to positive development of the individual.

There are other constructs which are similar to the concept of thriving, such as the constructs of flow, engagement and subjective wellbeing (Carmeli & Spreitzer, 2009; Niessen et al., 2012; Spreitzer et al., 2005). Flow is defined as “a subjective state people when they are completely involved in something to the point of forgetting time, fatigue, and everything else but the activity itself” (Csikszentmihalyi and Rathunde 1993, p. 59). Flow leads to an intense involvement in the activity at hand (Schuler, 2012). Schaufeli and Bakker (2004) defined engagement as “a positive, fulfilling, work-related state of mind that is characterized by vigor, dedication and absorption. Vigor refers to high level of energy, dedicated signifies enthusiasm and pride and absorption is characterized by fully involved in ones work. Subjective well-being is defined as the “phenomena that includes people’s emotional responses, domain satisfactions, and global judgments of life satisfaction” (Dieber et al, 1999). Subjective well-being is a broad area which includes moods and emotions and cognitive evaluation of domain satisfaction and life satisfaction. The common thread which binds thriving with flow, engagement and subjective wellbeing is the vitality dimension of thriving. However, thriving is different from these constructs in that unlike thriving the other constructs do not have the dimension learning. Hence, individuals can experience flow, engagement or wellbeing without learning experience; while thriving isn’t complete without learning (Spreitzer et al., 2005).

## **INNOVATIVE WORK BEHAVIOUR**

Innovation has been widely used as a strategy by organizations to improve their products, services, procedures and processes (Aldrich, 1999; Jack and Anderson, 2002; Shane, 2008). Creativity and innovation are sometimes used interchangeably (Basadur, 1997) but they are different constructs. Creativity connotes development of novel ideas (Mumford and Gustafson, 1988) while innovative behaviour goes a step further to implementation of these novel ideas (Scott and Bruce, 1994). Innovation leads to either creation or radical redesign of existing products, services or services (Woodman, Sawyer and Griffin, 1993). Thus, innovation is aimed towards adding value to the organization

De Jong (2006) defined innovative work behaviour as “individuals’ behaviours directed toward the initiation and intentional introduction of new and useful ideas, processes, products, or procedure

within a work role, group or organization (p. 19)". Process of innovation involves three stages i.e. generation, promotion and application of novel ideas to improve organizational performance (Janssen, 2005). At each stage of this innovation process organizational members can engage in innovative behaviour (Yidong and Xinxin, 2013).

In order to positively encourage innovation at workplace, Jong and Hartong (2007) developed inventory of leaders' behaviour which influences employees innovative behaviour at the workplace. Inventory included behaviour such as innovative role-modelling, intellectual stimulation, stimulating knowledge diffusion, providing vision, consulting, delegating, support for innovation, organizing feedback, recognition, rewards, providing resources, monitoring and task assignment.

## **THRIVING AND INNOVATIVE WORK BEHAVIOUR**

Employees who experience thriving at work feel the momentum and can see themselves progress (Carmeli and Spreitzer, 2009). Thriving constitutes affective (vitality) and cognitive (learning) aspects of psychological state. When individuals experience positive moods and emotions, it builds social and psychological resources (Fredrickson, 2002) which would help them to engage in improving work processes. Positive moods and emotions affect cognitive thinking by expanding thinking faculty to come out up creative problem solutions, which would further help individuals to be more innovative. Opportunity to learn and develop at workplace helps individuals in multiple ways. Learning helps employee to gain expertise in their work (Amabile, 1998) and also to hone new skills. Thus, learning helps employees to try out new things, improve existing processes and practices and demonstrate creative behaviour (Carmeli and Spreitzer, 2009) which would ultimately result in innovation in the organization. Wallace et al. (2013) found that employees who experience thriving at work would be willing to engage in innovative behaviour. Based on the discussion, following hypothesis were developed.

H1: Thriving will lead to innovative behaviour in the organization.

H2: Vitality will lead to innovative behaviour in the organization.

H3: Learning will lead to innovative behaviour in the organization.

## **METHOD**

Survey data was collected from 223 employees from service industry. 71 percent participants were male and had a mean age of years. 64 percent were postgraduate with 45 percent having less than 10 years of work experience.

Thriving was measured by 8 item adapted scale developed by Porath, Spreitzer, Gibson and Garnett (2012). Innovative work behaviour was measured by 4 items scale developed by Dension et al. (1995). The responses for both the scale were captured on likert scale. Figure 1 shows the research model.

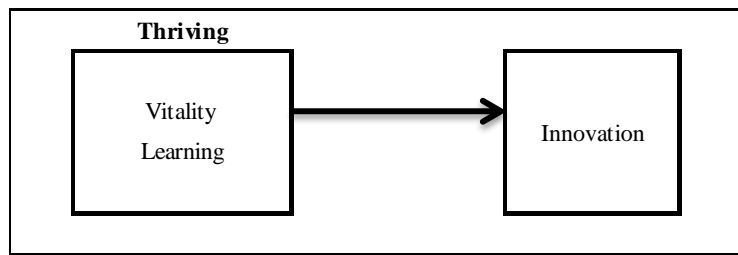

Figure 1: Research Model

### ANALYSIS

The results were analyzed using SPSS version 16. Kaiser-Meyer-Olkin (KMO) Test value of 0.88 and 0.84 of thriving and innovation scale respectively indicates that sampling is adequate and factor analysis can be carried out (Table 1 and 3). Thriving scale showed two dimension of thriving i.e. vitality and learning. It explained 70.7 percent of cumulative variance (Table 2). While, four item scale of innovation showed one dimension (Table 4) and it explained 70.7 percent of cumulative variance.

Kaiser-Meyer-Olkin Measure of Sampling Adequacy.		0.88
Bartlett's Test of Sphericity	Approx. Chi-Square	985.17
	df	28.00
	Sig.	0.00

Table 1: KMO and Bartlett's Test for Thriving Scale

Factor Variance	Vitality	Learning
% of variance	58.05	12.66
Cummulative variance %	58.05	70.7
Extraction Method: Principal Component Analysis.		
Rotation Method: Varimax with Kaiser Normalization.		
Rotation converged in 3 iterations.		

Table 2: Factor analysis of Thriving Scale

Kaiser-Meyer-Olkin Measure of Sampling Adequacy.		0.84
Bartlett's Test of Sphericity	Approx. Chi-Square	491.20
	df	6.00
	Sig.	0.00

Table 3: KMO and Bartlett's test for Innovation Scale

Factor Variance	Innovation
% of variance	75.11
Extraction Method: Principal Component Analysis.	
Rotation not possible as there is only one factor available	

Table 4: Factor Analysis for Innovation Scale

Table 5 reports the reliability of thriving and innovation scale. The alpha values are high (0.80) in both the scales (Nunnally, 1978). Table 6 shows the correlation between all the variables. It shows that innovation is correlated with thriving and both the dimensions of thriving i.e. vitality and learning.

	Cronbach's alpha	No. of Items
Thriving	0.896	8
Innovation	0.889	4

Table 5: Reliability Analysis

	Learning Mean	Vitality Mean	Thriving Mean	Innovation Mean
Learning Mean	1.00			
Vitality Mean	0.59(**)	1.00		
Thriving Mean	0.88(**)	0.90(**)	1.00	
Innovation Mean	0.65(**)	0.55(**)	0.67(**)	1.00

Table 6: Correlations between Variables

Table 7 reports the regress analysis. The results shows that thriving significantly influence innovation ( $R^2 = 0.45$ ,  $p < 0.001$ ). Both vitality ( $R^2 = 0.30$ ,  $p < 0.001$ ) and learning ( $R^2 = 0.42$ ,  $p < 0.001$ ) dimension of thriving significantly influences innovation.

Criterion Variable	Predictor Variable			
		Beta	t value	R2
Innovation	Thriving	0.88	13.45***	0.45***
	Dimensions of Thriving			
Innovation	Vitality	0.62	9.89***	0.30***
Innovation	Learning	0.65	12.64***	0.42***

N=222; \* $p \leq 0.05$ , \*\* $p \leq 0.01$ , \*\*\* $p \leq 0.001$

Table 7: Regression

## DISCUSSION

It is said that organizations who see and act upon the opportunities and possibilities for change through innovation in the current volatile and uncertain business environment will not only survive; they will successfully compete and flourish in the face of the emerging adverse and fluctuating

business and economic conditions<sup>6</sup>. Innovative changes require organizations to rethink how they perceive and sense customer's needs wants and expectations and how they adapt to an increasingly connected and digitized world. This brings focus on innovative behaviour of employees. Innovative work behavior was defined by De Jong (2006) as individuals' behaviours directed toward the initiation and intentional introduction of new and useful ideas, processes, products, or procedure within a work role, group or organization. It's a complex work behavior consisting of generation, promotion, and application of new ideas intended in the work role, group or organization, which aims at improving organizational performance (Janssen 2000, 2005).

Innovative behaviour involves being willing and competent in adapting and in knowing how to think differently. The purpose of the study was to advance the literature on thriving by examining its influence on innovation in organizations. We posited positive linkage between employee thriving and innovative behaviour at workplace. Thriving was the independent variable and innovative work behaviour was the dependent variable. The two essential conditions of thriving are vitality and learning. Vitality refers to feeling of energy and aliveness (Nix, Ryan, Manly and Deci; 1999). Learning refers to opportunity for growth and development by acquiring required skills and competencies. Thriving is a continuous process and not a onetime activity (Ryff, 1989). Thriving is not a dichotomous state where an employee either experiences thriving or not. Instead, it is a continuous experience where an individual may experience less or more thriving (Sonenshein, 2005).

Consistent with the findings of previous research (Carmeli and Spreitzer, 2009; Wallace et al., 2016) we found that thriving at workplace explained innovative behaviour of employees ( $R^2= 0.45$ ;  $p<0.001$ ). This supports the first hypothesis.

Vitality at work—closely aligns with the idea of intrinsic motivation, which has often been studied as a key element in relation to creativity (Amabile, 1996) and innovation (Anderson et al., in press). However, according to Sonenshein, Dutton, Grant, Spreitzer, and Sutcliffe (2006), thriving is distinct from intrinsic motivation in that although thriving may at times derive from a desire to perform a behaviour based on the affective enjoyment of the behavior itself (i.e., vitality), at other times the impetus for thriving has been described by emphasizing personally important achievement and recognition goals (i.e., learning). In our study vitality explained innovative work behaviour ( $R^2= 0.30$  ;  $p<0.001$ ). This supports the second hypothesis.

Thriving is self-regulatory in nature because it allows employees to gauge whether their work behaviors are providing personal development in a positive direction (Spreitzer, Sutcliffe, Dutton, Sonenshein, & Grant, 2005) and leading to the process of learning. This brings us to the component of

---

<sup>6</sup> 8 reasons why innovation is important to businesses today <http://www.imagination.com.au/innovation-blog/8-reasons-innovation-important-businesses-today/> aced on 10<sup>th</sup> May, 2017

learning in the construct of thriving. In our study learning explained innovative work behaviour ( $R^2=0.42$  ;  $p<0.001$ ). This supports the third hypothesis.

## LIMITATIONS AND FUTURE DIRECTIONS

The study was primarily cross sectional in nature. More insightful results can be drawn from longitudinal study. Longitudinal investigations would also provide an opportunity to examine the reciprocal nature of thriving and innovation to determine the role that successful innovation plays in subsequent thriving at work and vice versa, testing the suggestions by Spreitzer et al. (2005) that thriving operates through a continuous feedback loop to resources that enable future thriving. The study has not taken into consideration the contextual factors which can act as antecedents (for example passion, and creative self-efficacy) or moderators (e.g., job complexity), and mediators (e.g., job satisfaction) that could account for important variance in innovation. Finally, leadership style is a particularly important contextual factor that could be explored to expand our findings. Just as transformational leadership has been related to subordinate creativity (Shin and Zhou, 2003) and employee need satisfaction (Kovjanic, Schuh, Jonas, Quaquebeke, and Dick, 2012), supportive leadership styles (e.g., authentic leadership, ethical leadership) might further enhance the motivational benefits stemming from a high employee involvement climate and, thereby, promote thriving and innovation in the workplace.

## REFERENCES

- Amabile, T.M., 1998. *How to kill creativity* (Vol. 87). Boston, MA: Harvard Business School Publishing.
- Ashby, F.G., Isen, A.M., and Turken, A. U., 1999. A neuropsychological theory of positive affect and its influence on cognition. *Psychological review*, 106(3), p.529-550.
- Basadur, M., 1997. Organizational development interventions for enhancing creativity in the workplace. *The Journal of Creative Behavior*, 31(1), pp.59-72.
- Carmeli, A. and Spreitzer, G.M., 2009. Trust, connectivity, and thriving: Implications for innovative behaviors at work. *The Journal of Creative Behavior*, 43(3), pp.169-191.
- Carmeli, A., Ben-Hador, B., Waldman, D.A. and Rupp, D.E., 2009. How leaders cultivate social capital and nurture employee vigor: implications for job performance. *Journal of Applied Psychology*, 94(6), p.1553.
- Csikszentmihalyi, M. and Rathunde, K., 1993. The measurement of flow in everyday life: toward a theory of emergent motivation.
- De Jong, J.P. and Den Hartog, D.N., 2007. How leaders influence employees' innovative behaviour. *European Journal of innovation management*, 10(1), pp.41-64.
- De Jong, J.P. and Vermeulen, P.A., 2006. Determinants of product innovation in small firms a comparison across industries. *International small business journal*, 24(6), pp.587-609.
- Denison, D.R. and Mishra, A.K., 1995. Toward a theory of organizational culture and effectiveness. *Organization science*, 6(2), pp.204-223.
- Diener, E., Suh, E.M., Lucas, R.E. and Smith, H.L., 1999. Subjective well-being: Three decades of progress. *Psychological Bulletin*, 125(2), pp.276-302.
- Dougherty, D. and Heller, T., 1994. The illegitimacy of successful product innovation in established firms. *Organization Science*, 5(2), pp.200-218.
- Fredrickson, B.L., 2002. Positive emotions. *Handbook of positive psychology*, pp.120-134.



- Han, J.K., Kim, N. and Srivastava, R.K., 1998. Market orientation and organizational performance: is innovation a missing link?. *The Journal of marketing*, pp.30-45.
- Harpaz, I., 1990. The importance of work goals: An international perspective. *Journal of International Business Studies*, 21(1), pp.75-93.
- Jack, S.L. and Anderson, A.R., 2002. The effects of embeddedness on the entrepreneurial process. *Journal of business Venturing*, 17(5), pp.467-487.
- Janssen, O., 2005. The joint impact of perceived influence and supervisor supportiveness on employee innovative behaviour. *Journal of occupational and organizational psychology*, 78(4), pp.573-579.
- Kanter, R.M., 1988. Three tiers for innovation research. *Communication Research*, 15(5), pp.509-523.
- Kovjanic, S., Schuh, S.C., Jonas, K., Quaquebeke, N.V. and Dick, R., 2012. How do transformational leaders foster positive employee outcomes? A self-determination-based analysis of employees' needs as mediating links. *Journal of Organizational Behavior*, 33(8), pp.1031-1052.
- Maslach, C., 2003. Job burnout: New directions in research and intervention. *Current directions in psychological science*, 12(5), pp.189-192.
- Mumford, M.D. and Gustafson, S.B., 1988. Creativity syndrome: Integration, application, and innovation. *Psychological bulletin*, 103(1), p.27.
- Niessen, C., Sonnentag, S. and Sach, F., 2012. Thriving at work—A diary study. *Journal of Organizational Behavior*, 33(4), pp.468-487.
- Nix, G. A., Ryan, R. M., Manly, J. B., & Deci, E. L. (1999). Revitalization through self-regulation: The effects of autonomous and controlled motivation on happiness and vitality. *Journal of Experimental Social Psychology*, 35(3), 266-284.
- Nunally, J.C. and Bernstein, I.H., 1978. *Psychometric theory*.
- Oldham, G.R. and Cummings, A., 1996. Employee creativity: Personal and contextual factors at work. *Academy of management journal*, 39(3), pp.607-634.
- Porath, C., Spreitzer, G., Gibson, C. and Garnett, F.G., 2012. Thriving at work: Toward its measurement, construct validation, and theoretical refinement. *Journal of Organizational Behavior*, 33(2), pp.250-275.
- Ryff, C.D., 1989. Happiness is everything, or is it? Explorations on the meaning of psychological well-being. *Journal of personality and social psychology*, 57(6), p.1069.
- Schaufeli, W.B. and Bakker, A.B., 2004. Job demands, job resources, and their relationship with burnout and engagement: A multi-sample study. *Journal of organizational Behavior*, 25(3), pp.293-315.
- Schüler, J., 2012. Flow experience and learning. In *Encyclopedia of the Sciences of Learning* (pp. 1304-1305). Springer US.
- Scott, S.G. and Bruce, R.A., 1994. Determinants of innovative behavior: A path model of individual innovation in the workplace. *Academy of management journal*, 37(3), pp.580-607.
- Shane, S.A., 2008. *The illusions of entrepreneurship: The costly myths that entrepreneurs, investors, and policy makers live by*. Yale University Press.
- Shin, S.J. and Zhou, J., 2003. Transformational leadership, conservation, and creativity: Evidence from Korea. *Academy of management Journal*, 46(6), pp.703-714.
- Shirom, A., Toker, S., Berliner, S., Shapira, I. and Melamed, S., 2008. The effects of physical fitness and feeling vigorous on self-rated health. *Health Psychology*, 27(5), p.567.
- Sonenshein, S., Dutton, J., Grant, A., Spreitzer, G. and Sutcliffe, K., 2005. Narratives of thriving. *Narratives of life in organizations: Bringing organizations to life in and through stories*.
- Sonnentag, S. and Frese, M., 2003. *Stress in organizations*. John Wiley & Sons, Inc..
- Spreitzer, G., Sutcliffe, K., Dutton, J., Sonenshein, S., & Grant, A. M. (2005). A socially embedded model of thriving at work. *Organization science*, 16(5), 537-549.
- Wallace, J.C., Butts, M.M., Johnson, P.D., Stevens, F.G. and Smith, M.B., 2016. A multilevel model of employee innovation understanding the effects of regulatory focus, thriving, and employee involvement climate. *Journal of Management*, 42(4), pp.982-1004.
- Weerawardena, J., O'Cass, A. and Julian, C., 2006. Does industry matter? Examining the role of industry structure and organizational learning in innovation and brand performance. *Journal of business research*, 59(1), pp.37-45.
- Woodman, R.W., Sawyer, J.E. and Griffin, R.W., 1993. Toward a theory of organizational creativity. *Academy of management review*, 18(2), pp.293-321.
- Yidong, T. and Xinxin, L., 2013. How ethical leadership influence employees' innovative work behavior: A perspective of intrinsic motivation. *Journal of Business Ethics*, 116(2), pp.441-455.

# TOWARDS THE ADOPTION OF PATIENT GENERATED HEALTH DATA: A TECHNOLOGY READINESS INVESTIGATION OF LAGOS STATE NIGERIA

Maduka, Ikechukwu C.<sup>1</sup>; Odetayo, Michael<sup>1</sup>; Nkantah, Dianabasi<sup>1</sup>; Garcia-Perez,  
Alexeis<sup>2</sup>; Cegarra-Navarro, Juan Gabriel<sup>3</sup>; Olayanju, Lateef O.<sup>4</sup>

<sup>1</sup>Faculty of Engineering & Computing, Coventry University, UK

<sup>2</sup>Coventry Business School, Coventry University, UK

<sup>3</sup>Universidad Politécnica de Cartagena, Spain

<sup>4</sup>Faculty Health Sciences HCT, United Arab Emirates

## ABSTRACT

Establishing a population technology readiness is essential towards successful adoption of patient-generated health data in developing nations. It is widely accepted that data are numbers in context, i.e. in real-world conditions or a particular context. In this paper, the following question is addressed: which is the appropriate context to create and maintain an optimum level of health data technology readiness? To accomplish this, we surveyed 1443 randomly selected residents of Lagos State, Nigeria. Our findings suggest that individuals are positively predisposed towards adopting patient-generated health data. The uniqueness of this study lies on the fact that this is the first of such empirical evidence showing the State residents propensity to adopt PGHD.

*Keywords: Patient-generated health data (PGHD), Developing countries, Technology readiness, Adoption*

## INTRODUCTION

Considering the growing technology gap between developed and developing nations, technology leapfrogging has become a common paradigm seen in most developing nations in their race to stay abreast with the changing times in quality, yet economical healthcare delivery (Davison *et al.*, 2000; Fong, 2009). This concept of technology leapfrogging has also been evidenced in many developing nation's healthcare sector through health information technology (HIT) driven interventions marred with tales of failure, success and continuous local improvisation (Heeks, 2002; Idowu *et al.*, 2008). As a result of this, the question begging to be answered and still ignored by some who champion HIT deployment in most developing nations are; how technology ready are the potential users of HIT

systems considering all involved contexts? Secondly, how can these potential new users HIT technology readiness evidence inform on HIT implementation in these developing regions?

The significance of understanding a population technology readiness as a foundation for establishing their predisposition towards adoption and use of new technology keeps attracting significant attention from researchers and practitioners, and till present, continue to set precedents for technology implementation and adoption (Venkatesh *et al.*, 2003; Pagani, 2004). From studies that have investigated causes of HIT implementation or adoption failures in developing countries, it has been evidenced that the dearth of appropriate culture and organisational readiness are amongst the debilitating leading factors (Davies *et al.*, 2006; Idowu *et al.*, 2008; Panir, 2011). The case for technology readiness as a reason for these failures is further compounded by the paucity of literature on implementation and adoption of HIT in developing countries such as Nigeria (Malik and Khan, 2009).

## **THE NIGERIA HEALTH SECTOR AND PATIENT-GENERATED HEALTH DATA**

Presently, the Nigeria health sector is saddled with poor health information management system (HIMS), and amongst the numerous deleterious effects of this is the impediment to proper management of chronic diseases in the country (Azubuike and Ehiri, 1999; Asuzu, 2005; Asangansi and Shaguy, 2009; Chudi 2010; Benson and DHA, 2011). Also, is the incessant practice of self-medication and resulting drug abuse in the country as a result of factors that could be best categorised as personal or social on a wider context (Afolabi, 2008; Adisa and Fakeye, 2014). Studies have shown that most of these factors that lead to self-medication could be resolved if there are recurrent measures to educate the populace of the dangers of self-medication, to checkmate unrestricted over the counter sales of medicine while availing alternative mediums to improve doctor-patient communication without passing the rigors of physically booking hospital appointments (Idowu *et al.*, 2008; Afolabi, 2008). All the aforementioned challenges in no small way could benefit from a well-functioning HIMS which at the moment remains inadequate (Asangansi and Shaguy, 2009). Thus, there is need to rethink health interventions that doesn't rely solely on the government or the hospitals before patients communicate with their healthcare providers in Nigeria and other developing nations (Heeks, 2002; Asuzu, 2004; Davies *et al.*, 2006; Idowu *et al.*, 2008; Benson and DHA, 2011).

Patient-generated health data (PGHD) are health related data such as symptoms, lifestyle choices, and health history data amongst others that are gathered from patients or their designees to help address a health concern, and it is unique from other forms of health data as it is solely generated and shared by the patient outside clinical environment (Deering *et al.* 2013). Although gaining access to healthcare data is one of the main reasons why individuals access a database from outside the hospital

walls, without their context data is meaningless. An appropriated context drives informed and right decisions, which in turn can help patients address health issues early, manage long-term conditions, reduce preventable trips to hospital while making supplementary data available for an improved care and decision making for medical personals (Shapiro *et al.*, 2012; Wells *et al.*, 2014).

Notwithstanding how promising PGHD and its potential benefits appears in theory, its introduction in Lagos State Nigeria does not guarantee success, as its adoption will likely vary on the premises of individual psychographic attributes like technology readiness and demography (Parasuraman, 2000; Dabholkar and Bagozzi, 2002; Lin *et al.*, 2007). Also, while most doctors are willing to use PGHD, it is vital to have in mind that doctors differ by location, practice and gender (Wynia *et al.*, 2011). This means that users may have different understandings and uses for the data sets that have been codified by the transmitting patient. Therefore, questions surrounding technology mediums for PGHD capture, sharing, review and feedback between patients and their care provider, as well as stakeholders' responsibilities concerning PGHD introduction in Lagos State Nigeria requires thorough investigation. Moreover, giving the disparities in the social determinants of health across developed, developing and undeveloped nations, it will be inimical to generalise PGHD adoption frameworks (Marmot *et al.* 2008; Swan, 2009). Thus, it is extremely important to establish the PGHD technology readiness of Lagos State residents before its eventual adoption. This study addresses this gap by undertaking a PGHD-technology readiness study of Lagosians in order to establish their propensity to accept the PGHD concept.

#### *The technology readiness index (TRI) construct*

The importance of creating and maintaining a context that favours the interpretation of data in order to achieve the right levels of utilisation of information has been underlined in the extant literature. According Parasuraman (2000), the TRI construct represents a gestalt of mental contributors (optimism and innovativeness) and inhibitors (discomfort and insecurity) that could collectively define a person's predisposition towards using new technologies (see Figure 1). Thus, in the context of this research we argue that the TRI construct can be an important tool to value the "context" where data that has been compiled, is transformed into information by helping users build background knowledge on healthcare issues.

TRI is an individual-level characteristic that does not change within a short while nor alter unexpectedly in response to a stimulus (Parasuraman and Colby, 2015). The significance of TRI application is related to the novelty of e-health aspects during introduction to a population with little or no experience of e-health (Lanseng and Andreassen, 2007). To buttress this wide adaptability and reliability of the TRI construct, a longitudinal analysis of the academic license requests of TRI, and their result suggests that it has been applied to sectors that were early adopters of technology-based

service delivery models such as financial services, online retailing, various government institutions, nonprofit services and more recently to health care (Parasuraman and Colby, 2015).

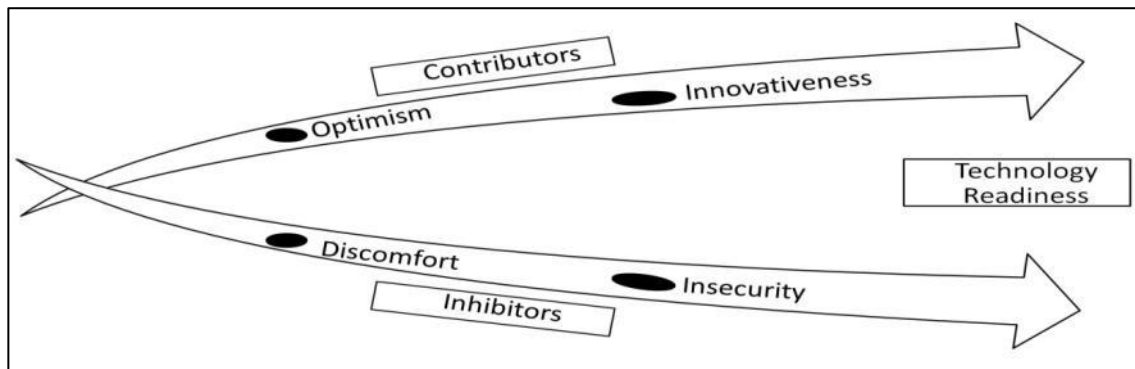

Figure 1. *The Four Dimensions of Technology Readiness*

Segmenting new technology adopters based on their TRI scores can be insightful - as it allows for the capture of different combination of beliefs, offering researchers a robust tool for defining research subjects (Colby and Parasuraman, 2001). As illustrated in Figure 2, the TRI segmentation depends on the outcome of each subject or subjects' TRI dimensions when reaching conclusion. The TRI segmentations include the highly tech-oriented "Explorers", the strongly engaged "Pioneers", the dispassionate "Skeptics", the cautious "Hesitators", and the tech-resistant "Avoiders" (Parasuraman and Colby, 2015).

TR DIMENSIONS	OPTIMISM	INNOVATIVENESS	DISCOMFORT	INSECURITY
<i>Explorers</i>	High	High	Low	Low
<i>Skeptics</i>	Low	Moderate	Low	Low
<i>Pioneers</i>	High	High	High	High
<i>Hesitators</i>	High	Low	Moderate	Moderate
<i>Avoiders</i>	Low	Low	High	High

Figure 2. *TRI Framework – from TRI Dimensions to TRI segmentation* (Parasuraman and Colby, 2015)

*Conceptual background*

Establishing a population readiness towards acceptance of new technology is an intrinsic foundation for adoption (Lanseng and Andreassen, 2007). A study by Lin *et al.*, (2007) on how personality dimensions impact users' readiness to adopt new technology using TRI, suggests that TRI is an antecedent of perceived usefulness and perceived ease of use of technology acceptance model (TAM).

This is supported by another self-service technology (SSTs) study on TR application; which demonstrated that TR influenced perceived SSTs service quality and behavioral intentions, and that perceived SSTs service quality has a positive impact on customer satisfaction and behavioral intentions towards SSTs (Lin and Hsieh, 2012). Furthermore, the analysis and cross-validation of TRI 1.0 and TRI 2.0 segmentation by Colby and Parasuraman (2001) and Parasuraman and Colby (2015), as well as its wide application has reinforced the consistency of the TR four-dimensions and its five-segmentations (Lanseng and Andreassen, 2007; Fisk *et al.*, 2011; Lin and Hsieh, 2012). We adopted the TRI framework due to its already established wide range usage over the years across several institutions and most importantly in similar studies investigating users (both patients and care providers) adoption of technologies supporting e-healthcare delivery (Godoe and Johansen, 2012).

Having established the use of the TRI framework for investigating the population PGHD-TR, we further focused on how the TR-dimensions will impact on Lagosians as seen from specific demographical attributes such as age, gender and level of education. This was informed by various studies that have examined the significance of individual differences and demography towards the adoption of new technologies (Harrison and Rainer 1992; Beaudry and Pinsonneault, 2005; Lee *et al.*, 2010; Dwivedi and Williams, 2008); Porter and Donthu, 2006). All these studies though different within the context of the environment and variables investigated have one commonality; they aimed to investigate and understand the technology readiness new adopters from a demographic perspective before actual implementation. This commonality is strongly hinged on the need to identify and understand various user attributes and how services or technology could be modeled or designed to meet their needs based on their uniqueness (Zmud, 1979). While considering the uniqueness of the population being studied, self-medication is a common habit within Nigeria (Afolabi, 2008; Arikpo *et al.*, 2010; Omolase *et al.*, 2007). Therefore, it was also important to investigate the relationship between the population dynamics and self-medication as illustrated by the research model (see Figure 3). In the context of this study, the demographics of the Lagos State population investigated includes; age, gender and education.

Figure 3 illustrates our proposed model, in which Technology Readiness is conceptualised as a joint process whereby patient age, gender and education level facilitate the creation of both contributors and inhibitors for adopting PGHD. The balance between contributors (i.e. optimism, innovativeness) and inhibitors (i.e. insecurity or attitude towards self-medication) compiled by TRI scores will then be available to users of the data for them to adopt PGHD. Therefore, giving that reviewed literatures suggest that readiness precedes acceptance and adoption, we hypothesise that age, gender and education are key determinants of Lagosians propensity to adopt PGHD, and as well having an influence on their attitude to self-medicate. On this basis, the following hypotheses are proposed:

- H1a. Age is positively related to Lagosians TR-optimism towards PGHD adoption.
- H1b. Age is positively related to Lagosians TR-innovativeness towards PGHD adoption.
- H1c. Age is positively related to Lagosians TR-discomfort towards PGHD adoption.
- H1d. Age is positively related to Lagosians TR-insecurity towards PGHD adoption.
- H1e. Age is positively related to Lagosians attitude towards self-medication
- H2a. Gender is positively related to TR-optimism towards PGHD adoption.
- H2b. Gender is positively related to TR-innovativeness towards PGHD adoption.
- H2c. Gender is positively related to TR-discomfort towards PGHD adoption.
- H2d. Gender is positively related to TR-insecurity towards PGHD adoption.
- H2e. Gender is positively related to Lagosians attitude towards self-medication
- H3a. Level of education is positively related to TR-optimism towards PGHD adoption.
- H3b. Level of education is positively related to TR-innovativeness towards PGHD adoption.
- H3c. Level of education is positively related to TR-discomfort towards PGHD adoption.
- H3d. Level of education is positively related to TR-insecurity towards PGHD adoption.
- H3e. Level of education is positively related to Lagosians attitude towards self-medication

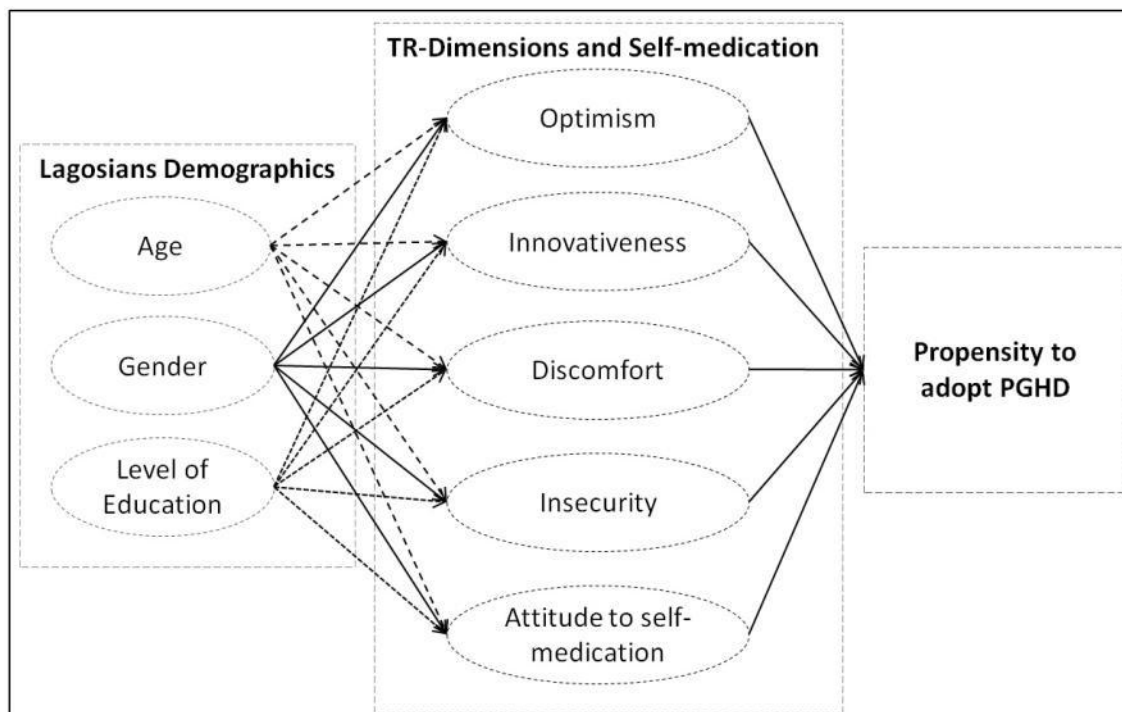

Figure 3. Research model and proposed hypotheses

## METHODS

Considering the cosmopolitan nature of Lagos state and how its diversified attributes depicts a microcosm of Nigeria, it was ideal to base the study in the state as the survey response could give an

insight into the average Nigeria predisposition and readiness to adopt PGHD and attitude to self-medication. After the Lagos State Health Service Commission (LSHSC) approved research ethics, a stratified sampling technique was adopted to ensure all 20 local government areas (LGAs) in the state were represented in the study. 100 consenting participants were randomly picked in each of the 20 LGAs giving a total sample of 2000 persons. A 23-item four-dimension (optimism, innovativeness, discomfort and insecurity) PGHD-TR scale was adapted from the TRI framework with written permission from Dr. A. Parasuraman. While demonstrating sound psychometrics, measured items were worded to fit the study environment, with each item scored and if need be, recoded on a 5-point Likert scale (from 1 = strongly disagree to 5 = strongly agree). An intrinsic challenge with scales that measure user's technology attitudes is the fact that technology keeps evolving over time and even at a faster speed in fields where service delivery technologies is much relied on as in the healthcare delivery field (Lanseng and Andreassen, 2007).

The refinement process employed both construct and content validity in other to boost scale confidence and this ensured the scale measured correctly the respondents PGHD-TR. Also measured were specific demographic attributes of the population such as age, gender, level of education and their attitude towards self-medication. In addition to establishing the population PGHD-TR, correlation analysis was carried out to investigate how the population dynamics correlated against each of the four PGHD-TR dimensions and their attitude to self-medication in order to gain deeper understanding of relationships shared between variables (Cohen *et al.*, 2013).

#### *Data collection*

Accepted responses were limited to respondents 18 years old and above - being legal age limit in Nigeria. An intercept method was used in distributing the PGHD-TR questionnaires in public locations across Lagos State, with concentration made in locations with high human traffic like schools, churches, mosques, shopping centers/mall, markets, hospitals, sports centers, government institutions, business centers and public transport hubs. After consenting to participate in the survey, respondents had the choice of filling out a paper version, having it communicated verbally (for not too literate, physically impaired and elderly participants) or respond online via a dedicated survey link.

In order to ensure a representative sample within the population was captured, a random sampling of 100 consenting Lagosians in each of the 20 local government areas in the State were targeted – totaling of 2000 questionnaires. Out of the 2000 questionnaires distributed, 1443 (72% response rate) usable questionnaires were retrieved for both online and paper version. The respondents feedback were summarised, coded and reverse scoring performed for the negatively worded items. Data analysis was done using IBM SPSS 24 and Table 1 shows the composition of the study population. For the correlational analysis, the nature of the data (i.e. nominal and ordinal) meant that non-parametric



techniques like Chi-Square test ( $H_{2b}$ ,  $H_{2c}$ ,  $H_{2d}$ ,  $H_{2e}$ ), Mann-Whitney U test ( $H_{1b}$ ,  $H_{1c}$ ,  $H_{1e}$ ,  $H_{2a}$ ,  $H_{3b}$ ,  $H_{3c}$ ,  $H_{3e}$ ) and Spearman rank correlation test ( $H_{1a}$ ,  $H_{1d}$ ,  $H_{3a}$ ,  $H_{3d}$ ) were employed in testing the proposed hypotheses.

#### *Respondents' PGHD-TR result*

To ensure reliability and validity of the questionnaire, the questionnaire was pretested during the design phase through a pilot study, as it was not yet published. This ensured the questionnaire measured what it intended to measure. Face and construct validity of the questionnaire were as well carried out so as to ensure the constructs of the data collection instrument provided sufficient coverage of the concepts being investigated. Further, we assessed the internal consistency as a measure of reliability for each of the TR-dimensions measured and this was done in line with Nunnally (1979) recommendation for alpha values above .70 being acceptable (see Table 2).

The resulting PGHD-TR analysis carried out entailed; getting the mean score of each of the 23 items measuring the population TR, and then aggregating the mean score of the items based on the TRI construct they measured (see Table 2). The aggregated PGHD-TR scores were further used to identify the correct TR-segmentation the general population fell under. The next analysis carried out entailed investigating how each of the PGHD-TR constructs correlated with the population demographics.

Age	Respondents (%)	Gender		Level of education (%)			
		Male	Female	Higher education	Secondary education	Primary education	None
18-25	313 (21.7)	132	181	135 (43.1)	169 (54)	7 (2.2)	2 (0.6)
26-35	367 (25.4)	187	180	327 (89.1)	23 (6.3)	17 (4.6)	0 (0)
36-45	185 (12.8)	96	89	144 (77.8)	23 (12.4)	16 (8.6)	2 (1.1)
46-55	293 (20.3)	194	99	217 (74.1)	41 (14)	33 (11.3)	2 (0.7)
56-65	212 (14.7)	98	114	132 (62.3)	40 (18.9)	32 (15.1)	8 (3.8)
66+	73 (5.1)	36	37	43 (58.9)	7 (9.6)	18 (24.7)	5 (6.8)
		743	700	998 (69.2)	303 (21)	123 (8.5)	19 (1.3)
Total	1443 (100)	1443		1443			
Descriptive - Respondents' Self-medication habit (%)							
1. Have you ever self-medicated?		Yes		No			
		1269 (87.9)		174 (12.1%)			
2. Reasons why respondents self-medicate							
				Response (%)			
High cost of hospital visits and prescription from hospital pharmacy						581 (19.2)	
It is an informed decision by me						511 (16.9)	
The local pharmacist (drug seller) advices me on what type of medication to purchase when I am ill						473 (15.6)	
Difficulty in accessing healthcare amenities						469 (15.5)	
I have access to drugs in my local pharmacy/shop, and though my purchase is not prescribed, the						411 (13.6)	

drugs are affordable		
I just assume the drug to take when I cannot get to the hospital or reach a doctor		300 (9.9)
It is a general practice in my family/area and nothing is wrong with it		255 (8.4)
Other		27 (.9%)
	Yes	No
3. Are you aware and concerned that your drug purchase from a local pharmacy/shop might be a counterfeit drug and that this might be harmful to your health?	1169 (92.1)	100 (7.9)
4. Will having seamless access to your health care provider and required information on prescription influence your decision not to self-medicate?	1150 (90.6)	119 (9.4)

Table 1. Study demographic profile and result of their self-medication habit

Items	TR Dimensions: (N = 1443; mean)			
	Optimism	Innovativeness	Discomfort	Insecurity
OPT1	3.93	-	-	-
OPT2	3.91	-	-	-
OPT3	4.44	-	-	-
OPT4	4.22	-	-	-
OPT5	4.28	-	-	-
OPT6	4.26	-	-	-
OPT7	4.31	-	-	-
OPT8	4.98	-	-	-
INN1	-	4.91	-	-
INN2	-	4.83	-	-
INN3	-	4.56	-	-
INN4	-	4.31	-	-
INN5	-	4.31	-	-
INN6	-	3.51	-	-
INN7	-	2.07	-	-
INN8	-	3.97	-	-
INN9	-	3.56	-	-
DIS1	-	-	1.18	-
DIS2	-	-	1.25	-
DIS3	-	-	1.18	-
INS1	-	-	-	4.10
INS2	-	-	-	2.86
INS3	-	-	-	1.56
Mean Total	4.29	4.00	1.20	2.89
TR-impact	High	High	Low	Low
Explorers	High	High	Low	Low
SD	.57	.92	.72	.62
Cronbach's alpha	0.72	0.85	0.76	0.77

Table 2. PGHD-TR means, TR-impact, standard deviations internal consistencies

All mean values are on a 5-point scale (1 = lowest, 5 = highest). The overall PGHD-TR score for each respondent was obtained by averaging the scores on the four dimensions (after reverse coding some scores on the discomfort and insecurity dimensions).

#### *Correlation analysis result*

Table 3 shows level of significance results from the nonparametric correlation analysis carried out on items measuring the studied population age, gender, level of education, against specific items measuring each PGHD-TR construct and attitude towards self-medication. We used an alpha level of .05 for all statistical tests.

N = 1443	p Value	Inference	
H1a. Age → OPT	.001**	Supported	rs = 0.113, p < .001
H1b. Age → INN	.023	Supported	U = 188717.5, p < .05
H1c. Age → DIS	.999	Not Supported	U = 44781, p > .05
H1d. Age → INS	.001**	Supported	rs = 0.182, p < .001
H1e. Age → SM	.001**	Supported	U = 83652.5, p < .001
H2a. Gender → OPT	.708	Not Supported	U = 257379.5, p > .05
H2b. Gender → INN	.612	Not Supported	2 (1, N = 1443) = 0.257, p = 0.612 (p > .05)
H2c. Gender → DIS	.697	Not Supported	2 (1, N = 1443) = 0.151, p = 0.697 (p > .05)
H2d. Gender → INS	.049	Supported	U = 246662, N = 1443, p = 0.049 (p < .05)
H2e. Gender → SM	.820	Not Supported	rs = 0.052, p > .05
H3a. Education → OPT	.002**	Supported	rs = 0.80, p < .001
H3b. Education → INN	.001**	Supported	U = 178312.5, p < .05
H3c. Education → DIS	.012	Supported	U = 38111, p < .05
H3d. Education → INS	.001**	Supported	rs = 0.88, p < .001
H3e. Education → SM	.379	Not Supported	U = 106721, p > .05

Table 3. Correlations between all study scales (hypotheses summary)

Spearman's Rho was calculated for ordinal variables, Chi-Square for nominal variables and Mann Whitney U for ordinal and nominal variables.

Correlation significant (p < .05); \*\*Correlation significant (p < .01).

## **DISCUSSION - RESPONDENTS' PGHD-TR**

From result of the PGHD-TR in Table 1, we observed an overall 4.29 and 4.00 PGHD-TR mean score for optimism and innovativeness respectively. The result shows that the respondents are highly optimistic and innovative towards eventual PGHD adoption. Since high score in optimism and innovativeness are good contributors of technology readiness (Colby and Parasuraman, 2001), it could be assumed that the surveyed population shares a general tendency to be good technology pioneers and thought leaders on new technology. Our findings also reveal that under the technology readiness inhibitor dimensions, all items under discomfort and insecurity had an overall mean score of 1.20 and 2.89 respectively. Although all individual items measured under these two dimensions had a low mean value, there was an exception as one item under insecurity (INS1: mean score 4.10), which measured the respondents' disposition towards concerns surrounding PGHD ownership had a high

mean score. This implied that the issue of PGHD ownership is vital and must be resolved with all involved stakeholders in the State.

The overall low mean score of the technology readiness inhibitor dimensions further implies that the respondents are not highly apprehensive towards adopting PGHD. Although overall mean score on the inhibiting dimensions are of positive implication towards PGHD readiness of the respondents, it is still important to have in mind that in the eventual introduction of PGHD in the State, every stakeholder impact on PGHD still needs to be established and backed with strong policy. Overall, the total mean score from this PGHD-TR survey (by summing up the mean from the four dimensions) which stood at 3.08 is an indication that the surveyed population are highly likely to adopt PGHD, but with shared concerns that needs to be addressed. Applying the overall mean score from each PGHD-TR dimension to the TR-segmentation; the surveyed population falls within the explorers segment - given their high score on optimism and innovativeness dimensions, while exhibiting low scores on the discomfort and insecurity dimensions.

*Respondents' age on PGHD-TR constructs and attitude to self-medication*

H<sub>1a</sub>. Age-OPT: The analysis revealed that there is a very strong positive correlation between the respondents age and their optimism:  $r_s = .113$ ,  $N = 1443$ ,  $p = .001$  ( $p < .01$ ). Remarkably, the respondents' age correlation to optimism showed a pyramidal trend as 96% of respondents within the 46-55 years old age category showed more optimism, followed by 95% of respondents within the 36-45 years old age category and 91% of respondents within the 56-65 years old category. It appears there is continuous increase in level of optimism with regards to the respondents' age, up until the 46-55 years old age category, after which a deep in optimism is observed.

H<sub>1b</sub>. Age-INN: The respondents age was statistically significant to their innovativeness:  $U = 188717.5$ ,  $N = 1443$ ,  $p = .023$  ( $p < .05$ ). 73% of the 1443 respondents were unaware of mHealth compared to 27% that were aware, and it was interesting to observe that level of innovativeness decreased as the respondents age increased.

H<sub>1c</sub>. Age-DIS: Age was not statistically significant to the respondents perceived discomfort:  $U = 44781$ ,  $N = 1443$ ,  $p = .999$  ( $p > .05$ ).

H<sub>1a</sub>. Age-INS: There was a very strong evidence of age being statistically significant to the degree of insecurity:  $r_s = .182$ ,  $N = 1443$ ,  $p = .001$  ( $p < .01$ ). We observed that degree of insecurity decreased as respondents' age increased. Even when assured that all security concerns towards PGHD use will be addressed before implementation, the data showed that the younger respondents remained more skeptical concerning their PGHD security.

H1e. Age-Self-medication: The result revealed that:  $U = 83652.5$ ,  $N = 1443$ ,  $p = .001$  ( $p < .01$ ). This implied that there was a very strong evidence of age being statistically significant to the respondents' attitude to self-medication. We observed that attitude to self-medication increased as age increased.

*Respondents' gender on PGHD-TR constructs and attitude to self-medication*

H2a. Gender-OPT: Based on the findings, we concluded that gender was not statistically significant to the respondents' degree of optimism:  $U = 257379.5$ ,  $N = 1443$ ,  $p = .708$  ( $p > .05$ ).

H2b. Gender-INN: Gender had no evidence of being statistically significant with the respondents' degree of innovativeness:  $\chi^2(1, N = 1443) = .257$ ,  $p = .612$  ( $p > .05$ ).

H2c. Gender-DIS: Gender was not statistically significant with the respondents' degree of discomfort:  $\chi^2(1, N = 1443) = .151$ ,  $p = .697$  ( $p > .05$ ).

H2d. Gender-INS: The result revealed that the degree of insecurity felt in the male group statistically, was significantly higher than the female group:  $U = 246662$ ,  $N = 1443$ ,  $p = .049$  ( $p < .05$ ).

H2e. Gender-Self-medication: Gender was of no statistical significance to the respondents' attitude towards self-medication.  $r_s = .052$ ,  $N = 1443$ ,  $p = .820$  ( $p > .05$ ).

*Respondents' level of education on PGHD-TR constructs and attitude to self-medication*

H3a. Level of education-OPT: We observed that degree of optimism statistically, was significantly higher in those with higher education, followed by those with secondary school education and least in those with primary education:  $r_s = .80$ ,  $N = 1443$ ,  $p = .002$  ( $p < .01$ ).

H3b. Level of education-INN: The degree of innovativeness statistically, was significantly higher in those with higher education, followed by those with secondary school education and least in those with primary education:  $U = 178312.5$ ,  $N = 1443$ ,  $p = 0.001$  ( $p < .01$ ).

H3c. Level of education-DIS: We observed that degree of discomfort statistically was, significantly higher in those with higher education, followed by those with secondary school education and least in those with primary education:  $U = 38111$ ,  $N = 1443$ ,  $p = 0.012$  ( $p < .05$ ).

H3d. Level of education-INS: Interestingly, the degree of insecurity statistically, was significantly higher in those with higher education, followed by those with secondary school education and least in those with primary education:  $r_s = 0.88$ ,  $N = 1443$ ,  $p = .001$  ( $p < .01$ ).

H3e. Level of education-Self-medication: The result revealed that level of education was not statistically significant to the respondents' attitude to self-medication:  $U = 106721$ ,  $N = 1443$ ,  $p = .379$  ( $p > .05$ ). 88% of the 1443 respondents admitted they self-medicate compared to 12% that did not self-medicate.

## CONCLUSION AND PRACTICAL IMPLICATIONS OF THIS RESEARCH

In terms of the research question driving this research (i.e. which is the appropriate context to create and maintain an optimum level of health data technology readiness?), we were unable to detect any

significant relationship between users' level of education and their attitude towards self-medication. A possible explanation for these results may relate to the fact that although public education may prevent users from possible problems caused by self-medication, users may need further information about the source, appropriateness of the data or nature of the sample before they decide to self-medicate. The respondents' age showed no evidence of statistical significance with the item measuring the discomfort construct while level of education also did not have any statistical significance towards their attitude to self-medicate. The links associated with gender in the model provide somehow surprising results. The link between gender and the variables studied in this study are statistically insignificant except in one out of all the relationships cases. A plausible explanation for this result would be the fact that PGHD adoption relates to equality between women and men with respect to their accesses to data. However, although men and women have the same opportunities to access data, this idea cannot be extrapolated to the respondents' degree of innovativeness.

The PGHD-TR survey has established that the respondents within the population sampled for this study are mostly explorers based on their overall mean score under each TR-dimension. The aggregated mean score of the four-dimensions gave the study sample a TR score of 3.08 and this is a positive tell-sign that the population will be positively predisposed, as well as being technology ready (explorers) towards accepting and adopting PGHD (Parasuraman, 2000; Colby and Parasuraman, 2001; Parasuraman and Colby 2015). Looking at the hypothesised relationships between the respondents' demographic attributes, the influence of age and level of education agreed closest to the proposed hypothesised relationships unlike their gender. In both age and level of education correlational analysis respectively, 4 out of 5 of each item measured under the PGHD-TR constructs and their attitude to self-medicate showed significant positive relationship. Interestingly, gender disagreed with 4 out of the 5 hypothesised relationships as it only showed almost a weak evidence of positive relationship with item measuring insecurity as seen in Table 3. The implication of these findings from the study suggests that; the average Lagosians PGHD-TR disposition would be most likely influenced by age and level of education regardless of gender. This should be considered when rolling out PGHD interventions in the State.

The study has also shown that issues surrounding PGHD ownership, access and usage is of high priority to the respondents and must be resolved. Ideally, patients absolutely own and decide whom they share their PGHD with (Shapiro *et al.*, 2014; Deering *et al.*, 2014). As most of the respondents' admit that the nature of their ailment could influence their decision not to adopt the practice, it is essential that this be addressed between patients' and their care provider. The need to ensure privacy, security and responsible use of PGHD in its eventual implementation will in no small measure encourage adoption of PGHD in the State. As internet connectivity keeps growing in Nigeria, findings

from this study also shows that though the respondents were positively predisposed towards using their mobile device for capturing and sharing their PGHD, the frequency of PGHD correspondence with their care provider needs to be resolved within involved parties.

Irrespective of the respondent's level of education, it was interesting to discover that 73% of them had no prior knowledge of mHealth, yet majority of them (91%) agree strongly that having means to seamlessly reach their care provider would influence their decision not to self-medicate. This suggests that there is strong evidence between access to healthcare information from care providers and patients' attitude to self-medication in Lagos State. While PGHD has shown potentials to bridge such gap, it is important that its eventual implementation in the State takes into consideration its novelty, thus a great deal of public awareness across all age groups and education on PGHD processes is required.

## ACKNOWLEDGEMENT

The authors want to thank Lagos State Health Service Commission for approving and collaborating with the research in Lagos state, Nigeria.

## REFERENCES

- Adisa, R. and Fakeye, T.O. (2014), "Treatment non-adherence among patients with poorly controlled type 2 diabetes in ambulatory care settings in southwestern Nigeria", *African health sciences*, vol. 14, no. 1, pp. 1-10.
- Afolabi, A. (2008), "Factors influencing the pattern of self-medication in an adult Nigerian population", *Annals of African medicine*, vol. 7, no. 3, pp. 120-127.
- Asangansi, I. and Shaguy, J. (2009), "Complex dynamics in the socio-technical infrastructure: The case of the Nigerian health management information system", *Proceedings of the IFIP9*, vol. 4.
- Arikpo, G., Eja, M. and Enyi-Idoh, K. (2010), "Self-Medication in Rural Africa: The Nigerian Experience", *The Internet Journal of Health*, vol. 11, no. 1.
- Asuzu, M. (2005), "Commentary: The necessity for a health systems reform in Nigeria", *Journal of Community Medicine and Primary Health Care*, vol. 16, no. 1, pp. 1-3.
- Azubuike, M.C. and Ehiri, J.E. (1999), "Health information systems in developing countries: benefits, problems, and prospects", *The journal of the Royal Society for the Promotion of Health*, vol. 119, no. 3, pp. 180-184.
- Beaudry, A. and Pinsonneault, A. (2005), "Understanding user responses to information technology: A coping model of user adaptation", *MIS quarterly*, pp. 493-524.
- Benson, M. and DHA, A.C. (2011), "Hospital information systems in Nigeria: a review of literature", *The Journal of Global Health Care Systems*, vol. 1, no. 3.
- Chudi, I.P. (2010), "Healthcare problems in developing countries", *Medical Practice and Reviews*, vol. 1, no. 1, pp. 9-11.
- Cohen, J., Cohen, P., West, S.G. and Aiken, L.S. (2013), *Applied multiple regression/correlation analysis for the behavioral sciences*, Routledge.
- Colby, C.L. and Parasuraman, A. (2001), *Techno-Ready Marketing: How and Why Customers Adopt Technology*, Simon and Schuster.
- Dabholkar, P.A. and Bagozzi, R.P. (2002), "An attitudinal model of technology-based self-service: moderating effects of consumer traits and situational factors", *Journal of the Academy of Marketing Science*, vol. 30, no. 3, pp. 184-201.

- Davies, J., Trude, B., McConnell, H., Ramirez, R., Shields, T., Drury, P., Kumekawa, J., Louw, J., Fereday, G. and Nyamai-Kisia, C. (2006), "Improving health, connecting people: the role of ICTs in the health sector of developing countries: a framework paper", *Info Dev.*, pp. 16-31.
- Davison, R., Vogel, D., Harris, R. and Jones, N. (2000), "Technology Leapfrogging in Developing Countries-An Inevitable Luxury?", *The Electronic Journal of Information Systems in Developing Countries*, vol. 1.
- Deering, M.J., Siminerio, E. and Weinstein, S. (2013), "Issue brief: patient-generated health data and health IT", Office of the National Coordinator for Health Information Technology.
- Dwivedi, Y.K. and Williams, M.D. (2008), "Demographic influence on UK citizens'e-government adoption", *Electronic Government, an International Journal*, vol. 5, no. 3, pp. 261-274.
- Fisk, R.P., Patricio, L., Lin, J.C. and Chang, H. (2011), "The role of technology readiness in self-service technology acceptance", *Managing Service Quality: An International Journal*, vol. 21, no. 4, pp. 424-444.
- Fong, M. (2009), "Technology leapfrogging for developing countries", *Encyclopedia of Information Science and Technology*. Hershey, Pennsylvania: IGI Global, pp. 3707-3713.
- Godoe, P. and Johansen, T. (2012), "Understanding adoption of new technologies: Technology readiness and technology acceptance as an integrated concept", *Journal of European Psychology Students*, vol. 3, no. 1.
- Harrison, A.W. and Rainer Jr, R.K. (1992), "The influence of individual differences on skill in end-user computing", *Journal of Management Information Systems*, vol. 9, no. 1, pp. 93-111.
- Heeks, R. (2002), "Information systems and developing countries: Failure, success, and local improvisations", *The information society*, vol. 18, no. 2, pp. 101-112.
- Idowu, P., Cornford, D. and Bastin, L. (2008), "Health informatics deployment in Nigeria", *Journal of Health Informatics in Developing Countries*, vol. 2, no. 1.
- Lanseng, E.J. and Andreassen, T.W. (2007), "Electronic healthcare: a study of people's readiness and attitude toward performing self-diagnosis", *International Journal of Service Industry Management*, vol. 18, no. 4, pp. 394-417.
- Lee, H., Jeong Cho, H., Xu, W. and Fairhurst, A. (2010), "The influence of consumer traits and demographics on intention to use retail self-service checkouts", *Marketing Intelligence and Planning*, vol. 28, no. 1, pp. 46-58.
- Lin, J.C. and Hsieh, P. (2012), "Refinement of the technology readiness index scale: a replication and cross-validation in the self-service technology context", *Journal of Service Management*, vol. 23, no. 1, pp. 34-53.
- Lin, C., Shih, H. and Sher, P.J. (2007), "Integrating technology readiness into technology acceptance: The TRAM model", *Psychology and Marketing*, vol. 24, no. 7, pp. 641-657.
- Malik, M.A. and Khan, H.R. (2009), "Understanding the implementation of an electronic hospital information system in a developing country: a case study from Pakistan", *Proceedings of the Third Australasian Workshop on Health Informatics and Knowledge Management-Volume 97* Australian Computer Society, Inc., pp. 31.
- Marmot, M., Friel, S., Bell, R., Houweling, T.A., Taylor, S. and Commission on Social Determinants of Health (2008), "Closing the gap in a generation: health equity through action on the social determinants of health", *The Lancet*, vol. 372, no. 9650, pp. 1661-1669.
- Nunnally, J.C. (1979), "Citation classic-psychometric theory", *Current Contents/Social & Behavioral Sciences*, , no. 22, pp. 12-12.
- Omolase, C., Adeleke, O., Afolabi, A. and Ofolabi, O. (2007), "Self medication amongst general outpatients in a Nigerian community hospital", *Annals of Ibadan postgraduate medicine*, vol. 5, no. 2, pp. 64-67.
- Pagani, M. (2004), "Determinants of adoption of third generation mobile multimedia services", *Journal of interactive marketing*, vol. 18, no. 3, pp. 46-59.
- Panir, M.J.H. (2011), "Role of ICTs in the health sector in developing countries: a critical review of literature", *Journal of Health Informatics in Developing Countries*, vol. 5, no. 1.
- Parasuraman, A. (2000), "Technology Readiness Index (TRI) a multiple-item scale to measure readiness to embrace new technologies", *Journal of service research*, vol. 2, no. 4, pp. 307-320.
- Parasuraman, A. and Colby, C.L. (2015), "An updated and streamlined technology readiness index: TRI 2.0", *Journal of service research*, vol. 18, no. 1, pp. 59-74.
- Porter, C.E. and Donthu, N. (2006), "Using the technology acceptance model to explain how attitudes determine Internet usage: The role of perceived access barriers and demographics", *Journal of business research*, vol. 59, no. 9, pp. 999-1007.
- Shapiro, M., Johnston, D., Wald, J. and Mon, D. (2012), "Patient-generated health data", *RTI International*, April.
- Swan, M. (2009), "Emerging patient-driven health care models: an examination of health social networks, consumer personalized medicine and quantified self-tracking", *International journal of environmental research and public health*, vol. 6, no. 2, pp. 492-525.
- Venkatesh, V., Morris, M.G., Davis, G.B. and Davis, F.D. (2003), "User acceptance of information technology: Toward a unified view", *MIS quarterly*, pp. 425-478.



- Wells, S., Rozenblum, R., Park, A., Dunn, M. and Bates, D. (2014), "Personal health records for patients with chronic disease: a major opportunity", *Appl Clin Inform*, vol. 5, no. 2, pp. 416-429.
- Wynia, M.K., Torres, G.W. and Lemieux, J. (2011), "Many physicians are willing to use patients' electronic personal health records, but doctors differ by location, gender, and practice", *Health affairs (Project Hope)*, vol. 30, no. 2, pp. 266-273.
- Zmud, R.W. (1979), "Individual differences and MIS success: A review of the empirical literature", *Management science*, vol. 25, no. 10, pp. 966-979.

## CASE STUDIES AND MANAGEMENT ACCOUNTING RESEARCH: EPISTEMOLOGICAL CONSIDERATIONS

**Makrygiannakis, Georgios**

Department of Accounting and Finance, Technological Education Institute of Sterea Hellada, Psahna, Evvoea, Greece

### ABSTRACT

In management accounting qualitative research is usually hetero-identified in relation to quantitative approaches. Yet, this negative positioning is no longer enough to cover inter-paradigmatic debates between qualitative researchers, which are often based on contrasting epistemological positions. The paper presents the implications of epistemology on case study research, as well as the form and role of the subjectivist, positivist, realist, and critical case study.

*Keywords: case studies, management accounting, epistemology*

### INTRODUCTION

Case study research has developed from a peripheral approach to the dominant quantitative research, to a self-distinguished research tradition with its own strengths and challenges. It is now considered as the most adequate approach to address how and why research questions, to bring to the foreground the complexity of management accounting practice in real organisational contexts, to study non-functional practice rationalities, and to address change in accounting and organisations (Ferreira and Merchant, 1992; Pettigrew *et al.*, 2001; Scapens, 1992, Yin, 2003).

Case studies are methods and not methodologies (Llewellyn, 1992; Otley and Berry, 1994; Richardson, 2012; Scapens, 1990; 1992). The case study allows flexibility and individual variation, and can be used with any philosophical perspective, whether positivist, subjectivist, or critical (Dube and Pare, 2003; Richardson, 2012). But that does not mean that the case method of the different paradigms is identical. The role that the case method has in any piece of research is dependent on the epistemological assumptions of the study (Otley and Berry, 1994). Subsequently, different types of case study methods are used in different methodologies (Scapens, 1990). In this paper different types of case study are discussed and later used to describe the different use (and relative value) of the methods employed by different research paradigms.

Although in management accounting there are many discussions on what can be described as the operational work that case studies are employed to do, there is not much discussion on epistemological implications on case study work. However, by simply categorising case studies under operational classifications covers the many differences between epistemologically different approaches. Otley and Berry (1994) note, "...the precise role that case-based methods can play will also be dependent upon the epistemological stance taken by the researcher." But it is not only the role that differs but also the whole form and entity of the method.

The case study method can take quite different forms under different research paradigms. The objectives and challenges inherent to each tradition are not the same, and naturally the criteria for designing and judging quality case studies are quite different under different epistemologies (Cresswell, 2007: 15-30; Dube and Pare, 2003). Otley and Berry (1994) warn that "...many, but not all, of the criticisms raised about research case studies in accounting and control are criticisms that workers adopting one epistemological stance do not follow the nostrums of another." They advise, "[c]ase studies are not value free...[thus]...they are likely to be more valuable where they are clear about their initial theoretical propositions and where they consciously attempt to develop their own theoretical modifications, however tentatively" (Otley and Berry, 1994), a thesis that Scapens (1990) and many others support.

Despite the above tolerant and rather relativistic positions, we recently witnessed a strong debate in MA on the topic. The traditional dichotomy in MA research between the mainstream 'positivistic' research and the 'alternative' interpretative one has created more confusion than clarity, as becomes evident from the dialogical paper of fifteen researchers in Ahrens *et al.* (2008). Part of the problem is because interpretative research is usually hetero-identified in relation to the 'others' (*Ibid.*). Yet, this negative positioning is no longer enough to cover inter-paradigmatic debates (Baxter *et al.*, 2008) between qualitative researchers. Particularly, there are researchers starting to prescribe to case studies both realist and subjective elements (Kakkuri-Knuuttila *et al.*, 2008a; Kakkuri-Knuuttila *et al.*, 2008b; Lukka and Modell, 2010), others suggesting that qualitative work could be informed by different paradigms (Armstrong, 2008; Davila and Oyon, 2008; Richardson, 2012), or at least different social theories (Baxter *et al.*, 2008) – thus practically with different paradigms again, as not all the social theories are paradigmatically unified. Finally there are researchers that explicitly interconnect the method with the subjectivist paradigm (Ahrens and Chapman, 2006; Parker, 2012).

It thus seems that "...the notion of interpretive research in management accounting is [still] in need of clarification" (Kakkuri-Knuuttila *et al.*, 2008b). This paper attempts to contribute to that direction by discussing how different epistemologies results in different case study methods, and how these may be employed in management accounting research. The operational classifications of case study

research are presented in the next section. The implications of epistemology on the case study method, whether following the subjectivist, positivist, realist, or critical paradigm, are discussed next, and then the paper concludes.

## **OPERATIONAL CLASSIFICATION OF CASE STUDIES**

According to Otley and Berry (1994), case studies are classified as 'explorative', 'critical case', and 'illustrative'. They consider the central role of case studies to be exploration, which moves beyond description towards explanation. From a positivist stance, deductive work generates hypotheses from prior theory and attempts to test them empirically. Inductive work attempts to theoretically explain observed phenomena. A critical case can be used in order to falsify a theory, or to modify and implement an existing theory, while an illustrative case can be used to illustrate a pre-defined theory. Most scholars, though, prefer a four-category classification, the descriptive, illustrative, exploratory, and explanatory cases.

Descriptive case studies have the objective to describe accounting and control systems, techniques and procedures, in order to present the actual accounting practice in real-life organisations (Scapens, 1990). Kaplan (1986) strongly favours descriptive case studies, as an attempt to acquire the practitioners' knowledge. Perhaps the clearer way to describe this method is that "...a descriptive study does not have a set of clearly delineated dependent and independent variables. The absence of a limited number of well-defined variables distinguishes case-study descriptive research from other types of research" (Simon in Kaplan, 1986: 434). Descriptive case studies provide three benefits for management accounting academics (Kaplan, 1986): they provide the basis for other forms of research, track interesting practices and organisations (illustrative), and highlight leading-edge practice. Finally, they support the reproduction of academic knowledge by providing university teaching with rich descriptions of practice.

Illustrative studies try to illustrate new and innovative practices developed in particular companies (Scapens, 1990). The method is employed mainly to present best practices or best companies, something that is somewhat fuzzy as to what best practice consists. Kaplan's approach, which was presented above, is profoundly targeting 'best practices'. Otley and Berry (1994) use the term differently, as they consider illustrative studies as aiming to illustrate a particular pre-defined theory. They note that it is difficult to accept that they do anything other than reinforcing the initial theoretical position. Nevertheless this argument is rooted in empiricism. Theory from a non-instrumentalist point of view is an attempted effort to understand and explain reality and, as such, pre-defined theory is

part of the exploratory or the explanatory designs in some of the paradigms that will be shortly discussed.

The distinction between the different types of case study is not always clear-cut (Ryan *et al.*, 1992; Scapens, 1990), and this becomes more obvious when discussing the exploratory and explanatory case methods. For example Scapens (1990) notes, “the distinction between exploration and explanation can be ambiguous”, a statement that Otley and Berry (1994) probably support, since in their classification they are both categorised as one: exploratory studies, which are described as moving away from mere description towards explanation.

Exploratory case methods are used to explore reasons of particular accounting and control practices (e.g. Setthasakko, 2010). It seems that Scapens (1990) inscribes in them positivistic functionality since, he argues, they represent preliminary investigations, aiming at producing hypotheses. They are considered to be the first step of a next study that will test these hypotheses. Perhaps we should prefer to describe them as preliminary investigations, aiming at producing theory, whether predictive or analytical. Explanatory cases are used as an attempt to explain the reasons of accounting and control practices. The focus of study is on the specific, rather than on producing generalisations. Theory is used for understanding and explaining the specific case(s) (Scapens, 1990). Of course what explanation is differs among different epistemologies (Humphrey and Scapens, 1996; Kakkuri-Knuutila *et al.*, 2008; Scapens, 1990), which leads to completely different forms of the explanatory case method.

Finally, case studies may be distinguished to single-case and multi-case studies; the former are based on a single entity, while the latter are concerned with more than one case (Kaplan, 1986; Scapens, 1992). While the sample size is not of particular concern to the field researcher (Ferreira and Merchant, 1992), it could be argued that in single case the researcher focuses more on the specific, while in multi-case designs the focus may be theory replication and development (Scapens, 2004), or case comparison (Maxwell, 2004).

## **EPISTEMOLOGICAL CLASSIFICATION OF CASE STUDIES**

There are different paradigmatic positions in regards to the nature of reality and the ways that reality(-ies) are addressed. At the one extreme, positivism accepts a reality external to the perception of individuals, which can and should be studied objectively. This emphasis on objectivity leads to a clear preference on quantitative research. At the other extreme, subjectivist paradigms argue in favour of a plethora of subjective realities, while the primary effort of research is to understand this multiplicity. Qualitative research methods are advanced for that reason (Hopper and Powell, 1985).

Realism accepts the partial externality of reality but, unlike positivism, addresses a stratified and not flat empirical reality (Llewellyn, 2007), as well as multiple perceptions about the external reality (Krauss, 2005). Since case studies are the dominant methods of the subjective paradigms the discussion will start with them.

### *Subjectivist*

The aim of many subjectivist case studies is to enquire, understand, and present the multiple realities of the people under enquiry. This is why the leading scholars of that tradition argue for 'richness' in the field studies; rich is not synonymous with detail but "has more to do with making understandable the actions and motivations of often very skilful people..." (Ahrens and Dent, 1998). Rich field studies are able to highlight better these different realities.

Scapens (1990; 1992), under a constructivist epistemology, inscribes to case studies the mission of helping us understand the social structures that shape current practice. All forms of case studies are useful, but explanatory ones are essential for the above. Explanation under such epistemology aims at understanding the processes, which are involved in managers' actions. Any explanation is perceived as "open, flexible and temporal, rooted in an interactive relation between theory and observation..." (Humphrey and Scapens, 1996).

Consequently, the principles for evaluating interpretive case study research are not the same as those in the case of positive studies (Klein and Myers, 1999; Lincoln and Guba, 2003: 274-281). In some cases, and particularly "...for some phenomenologically orientated, interpretivist and constructivist researchers, there is no unambiguous social reality 'out there' to be accounted for, so there is little need to evolve methodological canons to help explicate its laws" (Miles and Huberman, 1994: 2). For example, Klein and Myers (1999), having their starting point on the philosophy of phenomenology and hermeneutics, as well as experience from anthropological research, proposed seven principles for the evaluation of the phenomenological field studies: hermeneutic circle, contextualisation, research interaction, abstraction and generalisation, dialogic reasoning, multiple interpretations, and finally the principle of suspicion.

### *Positivist*

Positivist case studies might try to establish an experimental environment in order to test a theory. Comparative analysis is an effort towards a natural experiment, while others from a quasi positivist stance propose the study of a single organisation, in order to provide adequate experimental control (Lee, 1989; Otley and Berry, 1994). The emphasis of a positivist case study method, similarly to the familiar for positivists survey method, is the establishment of rigour to the scientific inquiry (Dube and Pare, 2003; Pare, 2001). Rigour is established through a close and clear application of procedures

and criteria proposed by scholars like Dube and Pare (2003), Eisenhardt (1989), Lee (1989), Pare (2001) and Yin (2003). The criteria of validity and reliability known by the familiar quantitative positive studies are accepted, even if modified, in order to judge the quality of research.

Under the positivist paradigm, case studies tend to be descriptive or exploratory. The aim of the later is in "...defining questions, proposing new constructs and/or building new theories" (Dube and Pare, 2003). The positivist case study can be better understood as a part of bigger project that employs surveys in a later stage, or had employed them in a previous one (Kaplan, 1986; e.g. Awwad and Akroush, 2016). The theory-building ability of the case study method is connected by these scholars to an approach as close to pure induction as possible (Eisenhardt, 1987). That is, as relatively free from prior theorising. Their aim is in hypothesis development (Kaplan, 1986). Nevertheless, positivist case studies have been recently used to test hypotheses, for explanatory reasons (Dube and Pare, 2003), since it is proposed that they are a valid method in order to falsify theories (Bent, 2006). Lee (1989) provides a 'scientific' methodological deductive framework in that direction. In that explanatory case, prior theorising is considered to be essential (Lee, 1989; Yin, 2003), and regarded to add rigour to the study (Dube and Pare, 2003).

#### *Realist*

The realist case study is placed between the subjective and positivist methods discussed above. Some similarities with the positivist case methods are that they usually use the same criteria for evaluating the quality of a case project. Part of that similarity is because the positivist case studies are themselves a departure from the mainstream tradition of positivism, towards a more realist stance, since the dominant statistical methods are downgraded.

Nevertheless there are differences, rooted again in the different epistemologies. A realist case study cannot be limited to descriptions. Realists regard description as insufficient and are quite sceptical about the utility of prediction, and thus argue that explanation is necessary. Realists are also less defending of their case studies and consider them more self-standing than positivists. The latter might adopt a defensive position, first since one positivist epistemic criterion is objectivity. Objectivity is sometimes unfortunately regarded as an ontological position, when what it truly implies is that reality can be objectively known (Dobson, 1999). Case studies have less objectivity, thus as already discussed positivists usually place their case studies as a part of a bigger study, which is able to account for objectivity. Secondly, because for positivists causal inference is connected to observed regularities (Maxwell, 2004; Maxwell and Mittapalli, 2007), something not easily assessed with the smaller samples of case study research. By contrast realists do not consider qualitative data inferior to quantitative, as they do not accept that there is really an objective way of acquiring knowledge, and

thus they do not design their case studies as part of larger enquiry. Theorising through statistical methods is one way of understanding reality, but this method, as all methods are, is incomplete, partial, and theory laden.

Thus realists are more confident about the value of case studies since they considered them, first, one valid way of acquiring knowledge, and second, a method that can be used for explanatory knowledge. Explanation is about acquiring “local knowledge”, knowledge about the actual events and processes that lead to specific outcomes (Huberman and Miles, 1985). Causality is “...consisting not of regularities but of real (and in principle observable) causal mechanisms and processes, which may or may not produce regularities” (Maxwell, 2004: 247) and cannot be assessed independently of the context of the processes (Maxwell and Mittapalli, 2007; Sayer, 1992: 60-61; 2000: 114-118).

Triangulation is central to the realist case study (Perry, 1998). “Triangulation has been generally considered a process of using several perceptions to clarify meaning, verifying the repeatability of an observation or interpretation” (Stake, 2005: 454). By acknowledging that there are different perceptions of the external reality, the aim is to bypass the perceived realities and come as close to the external one as possible; triangulation is a means to that cause. It has to be noticed that this point shares theoretical similarities with recent pragmatic approaches proposed for MA research, where “...all studies intended to add to our theoretical understanding need to include an etic element, since it must be the researcher who draws *the conclusions* from his/her findings” (Kakkuri-Knuuttila *et al.*, 2008 –original emphasis). This thesis integrates a moderate form of constructivism and a moderate form of realism (Lukka and Modell, 2010). The difference is that realism uses subjectivity in order to come close to the external reality while pragmatism addresses objectified explanations at a second stage. While many pragmatists are ontological realists, they implement a socially negotiated criterion of truth in their epistemology (Baert, 2003; Pleasants, 2003). This in turn is reflected in their case-criteria. For instance, Lukka and Modell (2010 – their quotation marks) suggest the criterion of plausibility, “used to denote whether an explanation “makes sense” and whether it can be inter-subjectively accepted as a likely one.” The use of different criteria for the evaluation of the case method results in turn in a different form of the method, compared to the realist one.

Finally realist case study methods are more complex than positivist ones, and not only because they want to be self-standing. Central contributors to the theories of realism disregard both inductivism and deductivism (Bhaskar, 1998: 48-103) and propose the alternatives of abduction and retroduction. Some researchers in the realist stream are still maintaining them in their research designs, but the design is based on combinations, parallel and interchanging applications of deduction and induction (Sobh and Perry, 2006), which unavoidably results in a more complex method.



A further distinction is that prior theory always precedes realist case study method; while in the positivist this is not always the case. More significantly, prior theory has a completely different meaning for the two traditions. In positivism prior theory is used in order to test deductively the predictive power of the theory. In contrast, the realist tradition is sceptical about the ability of predictions. In realism prior theory is usually part of an abductive or retroductive design (Lukka and Modell, 2010; Modell, 2017) and is used as a path to approach the data through its predefined and perhaps later reshaped theoretical concepts. Moreover, it is quite likely that positivist approaches will be framed within functional research, while realists make inferences to more abstract levels of theory and aim in understanding of the social and political implications of management accounting.

### *Critical*

Critical case studies are usually designed in a longitudinal mode. Data are categorised according to a well-defined, established before the empirical enquiry, theoretical framework. The aim is that this framework will reveal social inequalities, which will be criticised in an effort to liberate people from their historical mental, emotional, and social structures (Guba and Lincoln, 1998; Perry *et al.*, 1998), an effort to bring social balance and justice.

Critical theories are not paradigms in the traditional way. In the Hopper and Powell (1985) classification they are distinguished in 'objective' and 'subjective' approaches. Their meeting point is simply the critique and the effort to be active social criticisms rather than passive recorders of reality. As such, there are no unique quality criteria of the critical case studies (Healy and Perry, 2000). Technically speaking, their case methods follow their epistemology, i.e. either a constructivist or a realist one.

Nevertheless, it more precise to argue that critical cases are similar but not the same case methods as their relative non-critical ones, even if sharing the same paradigm. A critical researcher may wish to engage actively in the enquiry, wanting to do something about the phenomenon under investigation (Laughlin, 1995). Technically speaking again, this will most probably lead to a different approach to the enquiry. Engaging with the field is not a neutral activity but actually an act of intervention (Wengraf, 2001). Critical researchers are more likely to choose a highly intervening engagement with the field than non-critical ones. In turn, this will lead to different kinds of data and a differentiated case method.

## **CONCLUSIONS**

Despite the above discussed epistemological differences it is not suggested that case studies are neutral and empty shells. True enough, epistemology gives meaning to case study research but case

studies entail a greater degree of intervention between the researcher and the participants if, for instance, compared to a survey. Given this similarity, this paper explores some of the fundamental differences of epistemologically distinct case study methods. While this paper does not offer a throughout discussion, it highlights that epistemology shapes the whole form of the case method. The position advanced is that there is a role for case study research for every paradigm, the aims and outputs of epistemologically different case methods are distinct. This has implications on the design of a research project: Depending on the questions addressed and the research problem at hand researchers may need to adopt one or another epistemological position. This position will facilitate the research procedure, but will also frame the findings and contributions of the research problems within its range.

## REFERENCES

- Ahrens, T. (2008) 'Overcoming the subjective-objective divide in interpretive management accounting research', *Accounting, Organizations and Society*, 33(2-3), 292-297.
- Ahrens, T., Becker, A., Burns, J., Chapman, C. S., Granlund, M., Habersam, M., Hansen, A., Khalifa, R., Malmi, T., Mennicken, A., Mikes, A., Panozzo, F., Piber, M., Quattrone, P. and Scheytt, T. (2008) 'The future of interpretive accounting research—A polyphonic debate', *Critical Perspectives on Accounting*, 19(6), 840-866.
- Ahrens, T. and Chapman, C. S. (2006) 'Doing Qualitative Field Research in Management Accounting: Positioning Data to Contribute to Theory' in Christopher S. Chapman, A. G. H. and Michael, D. S., eds., *Handbooks of Management Accounting Research*, Elsevier, 299-318.
- Armstrong, P. (2008) 'Calling out for more: Comment on the future of interpretive accounting research', *Critical Perspectives on Accounting*, 19(6), 867-879.
- Awwad, A. and Akroush, D. (2016). 'New product development performance success measures: An exploratory research', *EuroMed Journal of Business*, 11(1), 2-29.
- Baert, P. (2003) 'Pragmatism, Realism and Hermeneutics', *Foundations of Science*, 8(1), 89-106.
- Baxter, J., Boedker, C. and Chua, W. F. (2008) 'The future(s) of interpretive accounting research—A polyphonic response from beyond the metropolis', *Critical Perspectives on Accounting*, 19(6), 880-886.
- Bent, F. (2006) 'Five Misunderstandings About Case Study Research', *Qualitative inquiry*, 12(2), 219-245.
- Bhaskar, R. (1998c) 'The logic of scientific discovery' in Archer, M., Bhaskar, R., Collier, A., Lawson, T. and Norrie, A., eds., *Critical Realism: Essential Readings*, Abingdon: Routledge, 48-104.
- Creswell, J. W. (2007) *Qualitative Inquiry and Research Design: Choosing Among Five Approaches*, 2nd ed., Thousand Oaks: SAGE Publications.
- Davila, T. and Oyon, D. (2008) 'Cross-paradigm collaboration and the advancement of management accounting knowledge', *Critical Perspectives on Accounting*, 19(6), 887-893.
- Dobson, P. J. (2001) 'Longitudinal Case Research: A Critical Realist Perspective', *Systemic Practice and Action Research*, 14(3), 283-296.
- Dube, L. and Pare, G. (2003) 'Rigor in information systems positivist case research: Current practices, trends, and recommendations', *Mis Quarterly*, 27(4), 597-636.
- Eisenhardt, K. (1989) 'Building theories from case study research', *Academy of Management Review*, 14(4), 532-550.
- Ferreira, L. and Merchant, K. (1992) 'Field research in management accounting and control: a review and evaluation', *Accounting, Auditing & Accountability Journal*, 5(4).
- Healy, M. and Perry, C. (2000) 'Comprehensive criteria to judge validity and reliability of qualitative research within the realism paradigm', *Qualitative Market Research: An International Journal*, 3(3), 118-126.
- Hopper, T. and Powell, A. (1985) 'Making sense of research into the organizational and social aspects of management accounting: A review of its underlying assumptions', *Journal of management Studies*, 22(5), 429-465.
- Huberman, A. M. and Miles, M. B. (1985) 'Assessing local causality in qualitative research' in Berg, D. and Smith, K., eds., *The self in social inquiry: Researching methods*, Thousand Oaks: Sage, 351-381.

- Humphrey, C. and Scapens, R. (1996) 'Methodological themes: Theories and case studies of organizational accounting practices: limitation or liberation?', *Accounting, Auditing & Accountability Journal*, 9(4), 86-106.
- Kakkuri-Knuuttila, M., Lukka, K. and Kuorikoski, J. (2008a) 'Straddling between paradigms: A naturalistic philosophical case study on interpretive research in management accounting', *Accounting, Organizations and Society*, 33(2-3), 267-291.
- Kakkuri-Knuuttila, M.-L., Lukka, K. and Kuorikoski, J. (2008b) 'No premature closures of debates, please: A response to Ahrens', *Accounting, Organizations and Society*, 33(2-3), 298-301.
- Kaplan, R. (1986) 'The role for empirical research in management accounting', *Accounting, Organizations and Society*, 11(4-5), 429-452.
- Klein, H. and Myers, M. (1999) 'A set of principles for conducting and evaluating interpretive field studies in information systems', *Mis Quarterly*, 23(1), 67-93.
- Krauss, S. (2005) 'Research paradigms and meaning making: A primer', *The Qualitative Report*, 10(4), 758-770.
- Laughlin, R. (1995) 'Empirical research in accounting: alternative approaches and a case for "middle-range" thinking', *Accounting, Auditing & Accountability Journal*, 8(1), 63-87.
- Lee, A. (1989) 'A scientific methodology for MIS case studies', *Mis Quarterly*, 13(1), 33-50.
- Lincoln, Y. and Guba, E. (2003) 'Paradigmatic Controversies, Contradictions, and Emerging Confluences.' in Denzin, N. and Lincoln, Y., eds., *The Landscape of Qualitative Research.*, 2nd ed., Thousand Oaks: Sage Publications Inc, 253-291.
- Llewellyn, S. (1992) 'The role of case study methods in management accounting research: A comment', *The British Accounting Review*, 24(1), 17-31.
- Llewellyn, S. (2007) 'Case studies and differentiated realities', *Qualitative Research in Accounting & Management*, 4(1), 53-68.
- Lukka, K. and Modell, S. (2010) 'Validation in interpretive management accounting research', *Accounting, Organizations and Society*, 35(4), 462-477.
- Maxwell, J. A. (2004) 'Using Qualitative Methods for Causal Explanation', *Field Methods*, 16(3), 243-264.
- Maxwell, J. A. and Mittapalli, K. (2007) 'The Value of Critical Realism for Qualitative Research', in Annual conference of the International Association for Critical Realism, Philadelphia, August, 17-19,
- Miles, M. and Huberman, A. (1994) *Qualitative data analysis*, 2nd ed., Thousand Oaks: Sage Publications.
- Modell, S. (2017) 'Critical realist accounting research: In search of its emancipatory potential', *Critical Perspectives on Accounting*, Forthcoming.
- Otley, D. and Berry, A. (1994) 'Case study research in management accounting and control', *Management Accounting Research*, 5(1), 45-65.
- Pare, G. (2001) 'Using a positivist case study methodology to build and test theories in information systems: Illustrations from four exemplary studies', available: <http://gresi.hec.ca/SHAPS/cp/gescach/formajout/ajout/test/uploaded/cahier0109.pdf> [accessed 17/3/2009].
- Parker, L. (2012) 'Qualitative management accounting research: Assessing deliverables and relevance', *Critical Perspectives on Accounting*, 23(1), 54-70.
- Perry, C. (1998) 'Processes of a case study methodology for postgraduate research in marketing', *European Journal of Marketing*, 32(9/10), 785-802.
- Pettigrew, A., Woodman, R. and Cameron, K. (2001) 'Studying organizational change and development: Challenges for future research', *Academy of Management Journal*, 44(4), 697-713.
- Pleasant, N. (2003) 'A Philosophy for the Social Sciences: Realism, Pragmatism, or neither?', *Foundations of Science*, 8(1), 69-87.
- Richardson, A. J. (2012) 'Paradigms, theory and management accounting practice: A comment on Parker (forthcoming) "Qualitative management accounting research: Assessing deliverables and relevance"', *Critical Perspectives on Accounting*, 23(1), 83-88.
- Ryan, B., Scapens, R. and Theobald, M. (1992) *Research method and methodology in finance and accounting*, London: Academic Press Ltd.
- Sayer, A. (1992) *Method in social science: a realist approach*, 2nd ed., New York: Routledge.
- Sayer, R. A. (2000) *Realism and social science*, London: Sage Publications.
- Scapens, R. (1990) 'Researching management accounting practice: the role of case study methods', *The British Accounting Review*, 22(3), 259-281.
- Scapens, R. (1992) 'The role of case study methods in management accounting research: a personal reflection and reply', *The British Accounting Review*, 24(4), 369-383.
- Scapens, R. W. (2004) 'Doing Case Study Research' in Humphrey, C. and Lee, B., eds., *The real life guide to accounting research*, Oxford: Elsevier, 257-279.

- Setthasakko, W. (2010) 'Barriers to the development of environmental management accounting', *EuroMed Journal of Business*, 5(3), 315-331.
- Sobh, R. and Perry, C. (2006) 'Research design and data analysis in realism research', *European Journal of Marketing*, 40(11/12), 1194-1209.
- Stake, R. (2005) 'Qualitative Case Studies' in Denzin, N., Lincoln, Y., ed. *The Sage handbook of qualitative research*, 3rd ed., Thousand Oaks: Sage Publications, 443-446.
- Wengraf, T. (2001) *Qualitative research interviewing: Biographic narrative and semi-structured methods*, London: Sage Publications Ltd.
- Yin, R. (2003) *Case study research: design and methods*, 3rd ed., Thousand Oaks: Sage Publications.

## AN INTRODUCTION TO BIOETHICAL RIGHTS

**Maniatis, Antonios**

University of Applied Sciences, Athens, Greece

### ABSTRACT

This paper includes a constitutional - law overview of the four generations of fundamental rights and introduces to the new set of bioethical rights by correlating them to some older ones. For instance, not only people are endowed with the 4G fundamental right to bioethics but also they deserve to be endowed with the “forgotten” right to pursuit of happiness, which should be correlated to bioethical questions, such as the revindication of women beyond the age limit of 50 years to medically assisted procreation. The 3G right to respect and restitution of human beings, exhibited in museums, particularly to autochthonous people, is under recognition in the current era of 4G rights, as it is the case of France, which has not adopted a general law on the matter, yet. Last but not least, various issues, such as the legal protection of the embryo against medical error and the role of the gestational mother, highlight the important economic dimension of the field of bioethics.

*Keywords: Bioethics, Climate Change Law, Demeter / Nature / Pacha Mama, Ethics, Fundamental rights, Genetic engineering, Gestational mother, Right to compensation for damage caused to an embryo, Right to restitution of human remains protected as heritage, Right to pursuit of happiness*

### INTRODUCTION: BIOETHICS, A NEW FIELD OF ETHICS

The current research has to do with a particular topic of global interest, human rights related to Bioethics. Bioethics, conceived in the years 1960 as a field of moral analysis, constitutes a term relevant to a multidisciplinary approach (philosophy, theology, sociology, law...), having as an objective to fix a certain number of theoretical principles and solve practical questions that emerged in the developed societies due to the advent of techniques on the living beings (genetical manipulation, cloning, artificial procreation, research on stem cells, therapeutic fury...) (Borillo, 2011).

On the one hand, as far as the normative dimension of Bioethics is concerned, this field has been affected by two opposite schools of thought. These schools, according to the theory of Weber, are the “Ethics of responsibility” and the “Ethics of conviction”. The first approach promotes the practical consequences of the action, in the decision – making timing and the partisans of this School will count precisely with common failures of man, as signalized by Weber (Weber, 1995). In this context, the woman’s right must prevail on the life of embryo and the patient’s freedom on the doctor’s obligation

of care. As a result, each person is considered as responsible for its own options and the law can interfere uniquely as long as a behavior causes harm to third persons.

On the other hand, the Ethics of conviction is based on the concept of immutable principles basically coming from religions (for instance, prohibition of abortion and of euthanasia in the name of sacredness of life).

Due to the very brief history of Bioethics and the limited extent of legislative dispositions on the matter in national legal orders, this paper is going to take an introductory approach to this “crossroad of various sciences” as for ethical questions relevant to human life.

We suppose that there are various 4G fundamental rights related to bioethics.

The current paper will shed light to the following subjects:

- the history of the consecration of the previous generations of fundamental rights in the history of mankind,
- the current generation of rights,
- the right to pursuit of happiness,
- the new ethical right to restitution of human remains, protected as cultural heritage,
- the right to compensation for damage caused to an embryo and
- rights related to Medically Assisted Procreation and economic impacts.

## **AN OVERVIEW OF PREVIOUS GENERATIONS OF FUNDAMENTAL RIGHTS**

Fundamental are the rights of persons, either natural or legal, that have to do with the role of the State. The doctrine recognizes four consecutive generations, in the history of emergence of these public-law rights (Maniatis, 2017a).

First of all, there are the classical rights, such as the civil rights to life and freedom, and the political rights, that began to emerge mainly through the French Revolution (1789-1799). This Revolution manifested a special interest on the right to life but it did not abolish the institution of capital punishment. Not only it maintained the death sentence in spite of an opposite proposal but it consecrated a single way of execution, the Guillotine, by alleging the principle of equality and to avoid the pain felt by the executed. This approach was consistent with the idea that the purpose of capital punishment was simply to end life rather than to inflict pain. This ethical concept has been later adopted even for the imprisonment, which is conceived *as* punishment, not *for* punishment.

After World War I, the second generation emerged, including three groups. The first one is the most known, in relation with this period of history. It is about social rights, with the State as a donator of crucial services for the weak social groups, if not for the entire population as it is the case of the delivery of educational services. The second group consists in “economic” (civil) rights, having to do

with the participation of people to the market as employees. It is about the dynamic group of strictly related rights to work, to syndicalism and to strike.

Last but not least, there is also a set of cultural rights, like the rights to art, sport etc.

Finally, the third generation began to emerge about in 1975, having to do with rights initially and mainly of people in the framework of the international community rather than of each person in the interior of a State.

This all-time classic set includes inter alia the following rights:

-mainly to the natural environment but also to the cultural one, as it is the case the specific right to cultural heritage of humanity,

-to water,

-to peace,

- to development.

As already signalized, the emblematic case consists in the enjoyment and the protection of the environment, particularly of the natural one, so the post-Cold War international community was intensively characterized by ecological concerns, strictly related to human life and health. Essentially, it is not about a mere right to the environment but an entire, dynamic set of rights and principles, such as the right to water (mainly to drinking water), to sustainable development (which at the same time is mainly a general fundamental principle) and to energy, although the energy was usually conceived as a concept relevant to the right to the development of the economy. It is also to mention the modern tool of the principle of precaution, which initially emerged in the international and European context. The legal development of this tool confirms the remark that the environment constitutes one of the sectors with major incidence of the European Union Law on national law (Nunziata, 2014).

## **AN OVERVIEW OF 4G FUNDAMENTAL RIGHTS**

Nowadays, humanity leads a new era of consecration of fundamental rights, in which 4G ones emerge. If the environment constitutes the emblematic right of the previous generation, the typical right of the new wave consists in the legal concept of the "Information Society". For instance, through the revision of the Greek Constitution, held in 2001, this text has been endowed with a lot of modern rights and tools, of both third generation (right to protect the environment, for the first time explicitly consecrated, sustainability) and fourth generation, such as the rights to participation in the Information Society and to protection of personal data. It is to point out that as the most important contribution of Greece to the European legal culture are considered article 24 of the Constitution, dedicated to the environment, and the environmental jurisprudence of the Council of State (Chrysogonos and Contiades, 2004).

Rights and principles belonging to a certain generation are in a process of development or eventually retrocession, in the periods of the next generations. For instance, as far as the tool of sustainability is concerned, besides the alleged principle of equality between antiquities and modern monuments, sustainability could have been used in favor of two listed buildings located in the street of the new Acropolis Museum of Athens, in the framework of the correspondent trial before the Council of State, in 2009 (Maniatis, 2010). This supreme administrative tribunal of Greece avoids any explicit use of the constitutional principle of sustainability, after its introduction in the Constitution through the 2001 revision, not to mention that this Court had already consecrated it through its pioneer jurisprudence, some years earlier! Perhaps the judges, who on international scale are inspired by a wider tendency of judicial "self-restraint" in their duties, not only in the environmental disputes, consider the block of constitutional dispositions on the right to sustainable development as a too drastic legal "weapon" to make an explicit use, even in the famous trials. In other words, they do not find it indispensable to be explicitly based on the principle of sustainable development, to achieve the protection of the environment, independently from the fact that there is a School of Thought that does not consider this principle itself as a tool of the Environmental Law but only one of its components (sustainability).

Furthermore, the United Nations Framework Convention on Climate Change entered into force on 21 March 1994 and has actually near-universal membership. The UNFCCC is a "Rio Convention", along with the UN Convention on Biological Diversity and the Convention to Combat Desertification, adopted at the "Rio Earth Summit" in 1992. The three international texts are intrinsically linked. Due to the date of entrance into force, the UNFCCC ties in with the 4G character of the correspondent right to Containing Climate Change (CCC). The Paris Agreement (in French "Accord de Paris") on Climate Change is an official agreement within the UNFCCC, dealing with greenhouse gases emissions mitigation, adaptation and finance, starting in the year 2020. This world's first comprehensive climate agreement was adopted by consensus on 12 December 2015 and entered into force on 4 November 2016. It provides an opportunity for countries to cope with the threat of climate change by keeping a global temperature rise this century well below 2 degrees Celsius and to pursue efforts to limit the temperature increase to 1,5 degrees Celsius. However, we have to signalize that it makes no explicit mention to the human right to water, despite the precedent of the Oslo Principles on Global Climate Change Obligations. So, the right to water, which is of utmost importance for life, remains one of the most marginal 3G rights worldwide, perhaps like the second generation right to tourism, whose the separate, specific branch of law is relatively new (Mylonopoulos, 2016).

The aim of the Paris Agreement is to enhance the implementation of the UNFCCC through:



*“(a). Holding the increase in the global average temperature to well below 2 °C above industrial levels and to pursue efforts to limit the temperature increase to 1.5 °C above preindustrial levels, recognizing that this would significantly reduce the risks and impacts of climate change;*

*(b) Increasing the ability to adapt to the adverse impacts of climate change and foster climate resilience and low greenhouse gas emissions development, in a manner that does not threaten food production;*

*(c) Making finance flows consistent with a pathway towards low greenhouse gas emissions and climate-resilient development”.*

The contribution of each State to achieve the worldwide goal of the Agreement is determined by all States separately and is called “Nationally Determined Contribution (NDC)”. However, no mechanism has been previewed to force a State to set a target in its NDC by a specific date and no enforcement will be if a set target within a NDC is not met. There will be only a “name and encourage” plan. Unlike its predecessor, the Kyoto Protocol, which sets commitment targets endowed with a legal force, the Paris Agreement allows for voluntary and nationally determined targets.

In 2015 Climate Change Law (or Climate Law) was still in the process of acquisition of its autonomy against the older, general branch of Environmental Law (Nespor, 2015). From June 2015 and on, the right to CCC has gained a sufficient judicial protection, mainly due to a Dutch sentence emitted then against the correspondent government. As far as the Climate Law is concerned, it has gained its autonomous status against the older general branch of Environmental Law, after the Paris Agreement on Climate Change.

Besides, other 4G rights have emerged, such as the relevant to genetic engineering and bioethics as well as to the world of animals (Del Giudice, 2016). Many 4G rights have a very important economic impact, as it is the case of the right to energy efficiency, especially of buildings, which comes from the 3G general right to energy (Bordin, 2014).

Last but not least, there is a great similarity between the fourth generation and the third one, particularly because they share the collective or communitarian nature (rights having to do with the interest of the entire community) and above all the solidarity character, which is located within the private sector. It is to signalize that this character may be also conceived in another similar context, namely as solidarity coming from the private sector towards State authorities which operate as the representatives of public interest. The solidarity character of 4G rights within society is exemplified by Internet, which constitutes a virtual reality field, in which man can express solidarity towards victims of an illegal act or help them.

## THE RIGHT TO PURSUIT OF HAPPINESS

The subject of happiness is not merely juridical but has to do mainly with other sciences, such as psychology, and to the social enquiry, like the case of bioethics (Maniatis, 2017b). The great intellectual, Umberto Eco, made an all-time classic comment, on the matter, in 2014 (Eco, 2014). He formulated the opinion that the literature on happiness is enormous, from Epicurus and perhaps before him and on, but he believes that nobody knows in what happiness consists. He cannot admit that it is about a permanent status for common people. The question is that happiness, conceived as an absolute fulness, is a very transitory situation, episodic and brief, like a moment in the course of an excursion in the countryside. Furthermore, the idea of happiness evokes always the personal happiness and hardly ever the one of the human species.

In the current period of 4G rights, a part of the doctrine has begun to attempt to prove that there is also an implicitly consecrated constitutional right relevant to happiness. However, it would be more accurate to classify it in the first generation due to its inclusion in the Declaration of Independence of the 13 USA, of 4<sup>th</sup> July 1776. This revolutionary text recognized the human right to pursuit of happiness along with the classical rights to life and to freedom of human beings. This right is also included in the French Declaration of the Rights of Man and the Citizen. This text of 26<sup>th</sup> August 1789 is directly influenced by Thomas Jefferson, the primary author of the American Declaration, who was at the time in France, serving as a diplomat, and worked closely with General Lafayette in composing a Bill of Rights for France. This first fundamental text of French Revolution recognizes the rights of men to property, liberty and life. It makes also reference to the objective of the "happiness of all". Despite the lack of explicit mention of slavery in the Declaration, slave uprisings in the Haitian Revolution took inspiration from its words. In 1793, due to the rebellion of slaves in Haiti, a part of the French revolutionists adopted the policy of abolition of slavery. It is to point out that the Declaration constitutes the point of reference of the French institutions, mainly in the Constitutions of 1852, 1946 and 1958. The Preamble of the current Constitution makes an explicit reference to it whilst even the Constitutional Council tends to invoke it. The right to pursuit of happiness, being

present in the above-mentioned Declarations, was omitted in the Constitutions of the era that was inaugurated by them.

As far as the juridical science is concerned, it seems rather divided on this “forgotten” human right. On the one hand, in 2008 the opinion was formulated that this right exists, resulting from various factors, like the historical antecedent (Gemma, 2008). Although the right was recognized in Declarations and not in ulterior formal Constitutions, it is not regarded as strange in both the vocabulary and the principles of Constitutional Law.

It is logical to look for a legal back in article 2a of the Italian Constitution (and in the similar disposition of article 25 par. 1a of the newer Greek Constitution), according to which: “*The Republic recognizes and guarantees the inviolable rights of the person, both as an individual and in the social groups where human personality is expressed*”. This disposition is endowed with a content quite similar to the question of recognition of new human rights. Various rights have been deduced from sectors of doctrine and jurisprudence in Italian legal order, beyond the explicitly consecrated in various constitutional dispositions. For instance, the Constitutional Court has expressed its interest in new human rights, like the right to protection from genetic manipulations.

However, the right to pursuit of happiness does not have the same nature to the consecrated in the Constitutions and to those deduced from these. It is possible to be deduced from the Constitution, via the recourse to either the teleological interpretation or the systematic one. It constitutes the *ratio* of all the other constitutional rights, being considered as a system, and from this *ratio* would be possible to deduce this right, being transversal to the other ones. It is connected with the phenomenon of multiplication of constitutional rights of various nature, in the process of interpretation of the fundamental charter. From the explicit provision of one or more constitutional rights it is possible to deduce rights that are implicitly formulated, because either these rights are the prerequisites of the explicitly consecrated rights (for instance, the right to life is not mentioned in the Italian Constitution whilst it is previewed in other Constitutions) or simply result from the mentioned rights (like the right to the environment in correlation with the right to health, being mentioned in article 32 of the same Constitution). On account of these data, it is obvious that the right to pursuit of happiness is not just another right, beyond the classical ones. It is in a logical relation not with some single rights but with the entire constellation of the constitutional rights.

Nevertheless, it is notable that the right to pursuit of happiness has historically acquired an autonomous rank, let alone in a logical connection with the rights of major importance for the existence and the happiness of human beings (life and freedom), as already mentioned. From this context, in view of the new discipline of bioethics, the USA Declaration does not back up uniquely the prohibition of any form of slavery but also the respect for human life and the right to procreation.

## THE RIGHT TO RESTITUTION OF HUMAN REMAINS PROTECTED AS HERITAGE

Nowadays, a fundamental right is under recognition, albeit in a rather shy and quite limited way. It is about the right to restitution of remains of the body of a deceased person and, more generally, to respect of these remains against the traditional approach of their exhibition in museums, as far as they are protected as heritage.

The secularization and the slow easing of the position of the Church have permitted the development of various collections including human remains, mainly in the 19<sup>th</sup> century (Hershkovitch, Rykner, 2011). However, from 1970s and on, the problem of respect for the human body emerged and the presentation of human remains to the public was contested. On this quite ambivalent topic, France has a pioneer position: it has adopted, since 1994, a first legislative text on bioethics, namely law n. 94-653 of 29<sup>th</sup> July 1994 relevant to respect of human body. The French legislator continued this approach, which has led to the promulgation of laws of 6<sup>th</sup> August 2004 relevant to bioethics and then of 19<sup>th</sup> December 2008 relevant to the funeral management. These newer texts result from the interest particularly in the use of human beings and in the means to prevent slavery.

For instance, within the last text there is Chapter III, having to do with the status and the destination of the ashes of deceased persons, whose the body gave rise to cremation. According to article 11, after article 16-1 of Civil Code, an article 16-1-1 is inserted, composed as follows:

“ *Art. 16-1-1.* - The respect due to the human body does not cease with the death.

The remains of deceased persons, including the ashes of those whose bodies have given rise to cremation, must be treated with respect, dignity and decency”.

As far as the problem of the presence of human remains in the national collections is concerned, another disposition coming from the first law on bioethics, has been invoked in both restitution cases that captured very much the interest of media in France (Hershkovitch, Rykner, 2011). It is about article 16-1-3 of Civil Code, according to which “*the human body, its elements and its products cannot be the object of a patrimonial right*”. The first case had to do with the serious ethical question of restitution of mortal remains of Saartje Baartman, known with the ironic nickname “Hottentot Venus”. Finally, the body of that black young woman, coming from the actual territory of South Africa, was given to this country in 2002, through an exceptional law of the French Parliament, namely without any use of the conventional administrative procedure of declassification of cultural goods. In a similar way, the norm on the matter was also invoked by the municipality of Rouen in the trial introduced by the French State against it, in the case of the tattoo head of a Maori warrior, which had been offered to it as a gift. The Minister of Culture did not share the volunteer of the Municipality to give the head to the museum TE Papa of Wellington, following the trend of many European museums in the

framework of the case of the tattoo heads of Maori people, located out of New Zealand. However, the disposition on the matter has to do with the living people, not the human remains, as it has been confirmed by the administrative jurisprudence in the Maori head case. The law of 4<sup>th</sup> January 2002, relevant to the “museums of France” has made it possible to integrate scientific collections into national collections and, consequently, to submit them to the status of public ownership, which includes the traditional principles of imprescriptible character of the owner’s claims and of inalienability. The violation of the principle of inalienability of the public ownership led the Minister of Culture to activate a procedure against the decision of the Municipal Council of Rouen, relevant to the return of the Maori head to the museum Te Papa. Nevertheless, it is to signalize that not only this decision was not legal because it transgressed the inalienability principle but also it could not get rid of this principle through the administrative procedure of declassification! Indeed, law prohibits any declassifications of goods integrated in collections of “Museums of France”. Finally, another exceptional law was adopted, of 4<sup>th</sup> May 2010, to reset the Maori heads to New Zealand.

Anyway, the question of restitution of human remains to autochthonous people is very delicate in various points of view, particularly because these remains may result in destruction for religious reasons. For instance, the former director of British Museum Neil McGregor has declared that this museum decided the restitution of two bags containing the ashes coming from the cremation of two chiefs, to the Aborigine representatives of Tasmania (Hershkovitch, Rykner, 2011). With the ashes, it is not technically possible to make an analysis of DNA, which has been destroyed. However, the question is whether in some decades or centuries other scientific methods emerge, ensuring this analysis, or not. The decision of the museum was more difficult to make, on account of the fact that the community of Aborigines had the intention to return the ashes to nature, to resume a broken cycle. Last but not least, if France has informally begun to establish a 4G right to restitution of human remains, USA are the pioneer country on the matter, by adopting the “Native American Graves Protection and Repatriation Act” (NAGPRA, Public Law 101-610), in 1990, to pay respect for the rights of autochthonous people. This law has been successfully applied and has inspired other countries to adopt some solutions of legislative or para-legislative nature. So, the right to restitution of human remains is a 3G one, at least as far as the USA are concerned.

## **THE RIGHT TO COMPENSATION FOR DAMAGE CAUSED TO AN EMBRYO**

The Italian Supreme Court emitted the sentence n. 16754/2012, for which the doctrine has manifested an important interest. The Court of Cassation, which has judged the aforementioned right to happiness as a thoroughly imaginary in a case relevant to tourism law (Ferro, 2014), in another case had to cope with the issue of compensatory damage for children born with Down syndrome due to a

failed diagnosis of the illness during the pregnancy. First of all, the right to health is widely recognized explicitly in Constitutions, as it is the case of article 32 of the Italian one, as already signaled. The doctrine remarks that this article makes speech not of “person” but of the “individual” as a subject of this right. As a result, it is possible, due to this formulation, to attribute it to the conceived, which is not legally a “person” but may be considered as an “individual” (D’Amico, 2015). It denies the existence of a right to be born healthy whilst even the above-mentioned sentence, which recognizes the right to compensation of the human being born with Down syndrome, seems to recognize the right on the matter. The “ratio decidendi” of the sentence consists rather in an “extension” of the compensation, which is directly attributed to the mother (and also to other members of the family), to the born, who is a subject that suffers personally the incidences of the medical error. The sentence ties in with the constitutional dictation, given that it excludes (explicitly) the compensation of the child against the mother that, in spite of the diagnosis of the pathological findings, is the unique entitled to makes up the decision to go on with pregnancy. Indeed, it is exclusively up to the woman the faculty to opt for the voluntary interruption of pregnancy in presence of dangers for her life or for her health, as it is clearly fixed in Law n. 194/1978.

Besides, the Constitutional Court of Italy, particularly in its sentence n. 27/1975, has denied, in the matter of abortion, the possibility to equate the conceived, not being a “person” in terms of Civil Law, to the mother, who is a person. The same Court, in the matter of medically assisted procreation, particularly in sentence n. 159/2009, has admitted that law n. 40/2004 can reconcile the rights of the embryo with the claims of the procreation. It is about the treatment of the conceived as an object, instead of being a subject of rights (D’Amico, 2015).

According to another opinion on the above-mentioned judgement of the Court of Cassation, granting such compensation to the baby born with Down syndrome is tantamount to postulating a right not to be born. Subsequently, the doctrine tries to refute this right by showing that it is illegitimate and that, consequently, so is the aforementioned compensation. Some of the objections to this hypothetical right are:

- a. It is wrong to reduce the quality of a whole life to the conditions in which one is born,
- b. Only the individual can decide about the quality of his own life, and he can only do so as a living being (Magnone, 2015).

We consider that this approach is not well founded given that the embryo does have some rights, in spite of the fact that it is not endowed with the legal status of a person, yet. It is not logical to deny the right to compensation to the damage suffered by the victim itself, even if the damage was caused when the victim was still an embryo. In the legal orders, entities having no human beings as members

do have rights, such as the foundations. These nonprofit organizations under the private law are endowed *inter alia* with the rights to honor and property and deserve compensation in case of damage. So, it is not normal to deny any right, like compensation, to the embryo, as long as it became a person. Besides, in the current framework of Environmental Law there is the rather ambivalent trend to recognize Nature itself as a subject of rights! It is about Nature or the goddess "Pacha Mama" (meaning Mother Earth) or essentially the goddess of the ancient Greek religion Demeter (meaning equally Mother Earth), namely the entire ecosystem as a whole, as a separate subject of rights relevant to its circle of life, as it is the case of the Constitution of Ecuador.

Finally, it is also to take account of the fact that legal orders have the tendency to a wider protection in favor of the embryo, as it the case of the Greek State which has recently completed this protection by previewing the physical injury against the embryo, committed from negligence, as a crime.

## **RIGHTS RELATED TO MEDICALLY ASSISTED PROCREATION AND ECONOMIC IMPACTS**

Not only Nature (alternatively called " Mother Earth ") has begun to be institutionalized as a subject of rights but the notion of mother has been significantly enriched through the scientific intervention to nature of the human being. The advent of new technologies has led to the existence of up to three types of mother. Due to the techniques of assisted fertility, three types of mother can be defined:

- a. Genetic, whose contribution to the child was the ovum, and hence genes,
- b. Gestational and
- c. Social, who rears the baby already born.

A woman can enact one, two or all three roles of mother to a child.

As for the technique of gestational mother, the above-mentioned School of Thought "Ethics of conviction" raises severe criticism. For instance, in the course of public auditions of the French National Assembly, a woman jurist, as a guardian of human dignity, did not hesitate to denunciate to the deputies the gestational mothers' practices, regarded as "*a slavery of technically assisted procreation*" (Borillo, 2011).

On the other side, Bioethics tends to become a biological power or biopower, in case that the access to the techniques of medically assisted procreation is prohibited to all women with menopause, in the name of the biological incapacity of these women to conceive a child (Borillo, 2011). It is to underline that this neologism is mainly accepted in French, in form of " biopouvoir ". This notion, which has been the object of a discussion explosion the last years, can be understood in two different ways (Paltrinieri, 2013). According to the first interpretation, this term is synonym of a theory on the power

and has to do with the political philosophy. The second approach is associated to the social sciences and has to do with the (“objective”) description of the present. As far as the prohibition of procreation is concerned, this exclusion is very important and has led to Greece to the emergence of a social movement of protest against the age limit of 50 years, although the right to pursuit of happiness, to which the right to procreation could be correlated, has received no recognition in this legal order, yet. Indeed, this right seems to be rather completely “unknown”.

The medically assisted procreation has been regulated by Law 3089/2002 and Law n. 3305/2005 in Greece whilst the Greek Church, in spite of its opposition to this technique, formulated its arguments that were taken into consideration by the State in the law-making procedure for the adoption of the first legal act. In this country, there is an entire “industry” facilitating with a profit couples that cannot get a child and want to find a solution to their serious problem. Women are offered to enact the role of a gestational mother, just to acquire an income in the black market (Nikolaou, 2015). To this particular illegal profession are devoted mainly young women, just as the role of genetic mother is above all connected with youth. Of course, there is also the legitimate alternative, for instance with the use of the grandmother of the embryo as a gestational mother. This practice is not merely an acceptable solution by law but also a very strong example of modern fundamental rights; it exemplifies the above-mentioned principle of solidarity within society, let alone within family, which is typical for both 3G rights and 4G ones. New dynamic roles and networks have emerged, with the central figure of grandmother, which has the right not only to enact the role of social mother or at least to back up her daughter as far as raising children is concerned, but also to become the gestational mother of her grandchild!

## **CONCLUSION : A CONSTELLATION OF 2G AND 3G ETHICAL RIGHTS AND 4G BIOETHICAL RIGHTS**

The current research has highlighted some 3G and mainly 4G fundamental rights, related not only to genetic engineering and bioethics but also to the wider notion of ethics. Indeed, it is not realistic to take an approach to the field of bioethics without analyzing some nearby questions, which have caused ethical debates, traditional or not.

On the one hand, as far as the field of ethics is concerned, the freedom to abortion on some strict conditions does not seem illogical. For instance, the issue of prenatal diagnosis for multi-factorial diseases is guided in the Greek legal order by article 5 par. 5 of the Constitution, according to which: « *Everyone has right to protection of health and his genetic identity. A law defines the issues relevant to the protection of every person against the biomedical interventions* ». This kind of diagnosis of serious illnesses from which the unborn embryo suffers, such as the aforementioned case of Down syndrome and



Mediterranean anemia, is perhaps among the few cases where it could not be argued that free growth of personality and reproductive freedom (with its negative aspect of not acquiring descendants) predominate the protection of the embryo (Charisi et al., 2014). The law could not require from someone to raise a child who will certainly suffer in his life. The fact that abortion has been partly decriminalized in the late 2G period, through the adoption of the Abortion Act in 1967 in the UK, and mainly in the 3G period, in 70s and 80s, implicates the institutionalization of a nowadays consolidated right of women.

In a similar way, the 3G right to respect and mainly to restitution of human remains belonging to museums is an ethical one, strictly related to the bioethical legislation. The revindication on the matter is quite logical and should not be limited to the rights of autochthonous people. This topic has also another serious particularity in legal terms, consisting in the public law principle of inalienability of public collections, let alone the fact that the administrative procedure of declassification may be proved to be very difficult to activate, if not excluded, as it the case of donations and legacies in the French legal order (Maori head case). France has also another particularity, given that the declassification results from pressures of foreign countries and is sometimes linked with trade agreements, as it is the case of the "loan" of the Uiwge manuscripts to South Korea.

On the other hand, as for bioethics, it has to do with too important questions to be exempted from rules whilst formal Constitutions should be modernized on the matter, as it has been the already mentioned case of the Greek one. We think that no absolute approaches are suitable for the delicate problems that this modern discipline has to cope with. In legal terms, it would be recommended to explicitly recognize the status of the conceived in the Constitutions, which anyway must be thoroughly protected at least against harmful medical errors.

Last but not least, the age limit for medically assisted procreation constitutes an unconstitutional restriction against women of over 50 years given that they do have the right to acquire a child, as long as biotechnology is available. For these developments, the constitutional recognition of the "forgotten" human right to pursuit of happiness is a highly recommended development, having to do not only with bioethical matters but also with other activities with an important business impact, such as inter alia religion and the group of recreational rights (namely recreation, culture, education, sport, tourism and hospitality).

## REFERENCES

- Bordin, A. (2014), "Il risparmio energetico nelle abitazioni", *Ambiente e Sviluppo*, 1, pp. 56-64 (in Italian).  
Borillo, D. (2011), *Bioéthique, À savoir*, Éditions Dalloz (in French).  
Charisi, A., Deliligka A., Chrysovergis I., Chatzinikolaou F. (2014), "Moral issues of prenatal control", *Aristotle University Medical Journal*, Vol. 41, 2 (Special issue), June, pp. 23-26.

- Chryssogonos, K. and Contiades, X. (2004), *Der Beitrag Griechenlands zur europäischen Rechtskultur: der verfassungsrechtliche Umweltschutz*, in *JöR n.F.* (in German).
- D'Amico, M. (2015), "Il concepito e il diritto a nascere sani: profili costituzionali alla luce della decisione della Corte di Cassazione (N. 16754 del 2012)", *Bioetica*, 1, pp. 23-40 (in Italian).
- Del Giudice, F. (2016), *Compendio di Diritto Costituzionale*, XX Edizione, Edizioni Giuridiche Simon (in Italian).
- Eco, U. (2014), "La bustina di minerva Il diritto alla felicità". *L'Espresso* (in Italian).
- Ferro, G. (2014), "Nuove frontiere della tutela del turista – consumatore nello spazio giuridico europeo e antiche diatribe domestiche: riflettendo sulle c.s. "danno da vacanza rovinata"", *Forum di Quaderni Costituzionali*, [http://www.forumcostituzionale.it/wordpress/images/stories/pdf/documenti\\_forum/paper/0488\\_ferro.pdf](http://www.forumcostituzionale.it/wordpress/images/stories/pdf/documenti_forum/paper/0488_ferro.pdf). (Accessed 29 April 2017, in Italian).
- Gemma, G. (2008), "Esiste un diritto costituzionale alla felicità?", *AFDSUDC*, 12, pp. 519-531 (in Italian).
- Herschkovitch, C., Rykner, D. (2011), *La restitution des œuvres d'art Solutions et impasses*, Éditions Hazan, Paris (in French).
- Magnone, C. (2015), "Risarcimento per essere nata: un diritto a non nascere? Riflessioni sulla sentenza della Cassazione n. 16754/2012, (N. 16754 del 2012)", *Bioetica*, 1, pp. 41-62 (in Italian).
- Maniatis, A. (2017a), "Judiciary and the Technological Rule of Law", in VIII Scientific and Professional Conference with International Participation (Tara), pp. 531-540.
- Maniatis, A. (2017b), "The Right to Pursuit of Happiness and Italian Tourism Law", *Tourism Development Journal*, Vol. 15, 1, pp. 49-58.
- Mylonopoulos, D. (2016), *Tourism Law*, Nomiki Vivliothiki 2016 (in Greek).
- Nespor S. (2015), "I principi di Oslo: nuove prospettive per il contenzioso climatico", *Giornale di diritto amministrativo*, 6, pp. 750-755 (in Italian).
- Nunziata, M. (2014), "I principi europei di precauzione, prevenzione e "chi inquilina paga"", *Giornale di diritto amministrativo*, 6, pp. 656-666 (in Italian).
- Nikolaou, B. (2015), "We are looking for a young woman to give birth to our child", *Eleftheros Typos*, Holly Saturday – Easter 12 April, p. 26 (in Greek).
- Patrinieri, L. (2013), "Biopouvoir, les sources historiques d'une fiction politique", *Revue d'histoire moderne et contemporaine*, 60-4/4 bis, pp. 49-75 (in French).
- Weber, M. (1995), *Le savant et le politique*, Plon, Paris (in French).

## THE RIGHT TO RECREATION ( / $\Psi$ , X ) WITH EMPHASIS ON TOURISM

Maniatis, Antonios

University of Applied Sciences, Athens, Greece

### ABSTRACT

This paper focuses on recreation, as a fundamental right of each “anonymous” citizen, like the mathematics symbols of the unknown factors, usually called  $\Psi$  and X. It has to do mainly with heritage and tourism as specific rights exemplifying the general right to recreation, which could be called as the right “ /  $\Psi$ , X ”, inspired by the Greek homonymous word “αναψυχή”, which means “recreation”. Besides, as far as heritage is concerned, the coverage of monuments with earth serves various purposes of the State whilst private individuals also make use of it illegally, to continue their building works. It is recommended to consecrate the right to unearthing monuments and to correlate them with business activities of recreation, the cultural tourism included. The general right to recreation, strictly related with the “forgotten” right to pursuit of happiness, should be consecrated in Constitutions along with the right to free time and could include the specific right to recreation, exemplified by nightlife and carnival, and the separate set of rights to culture (culture, education) and to physical movement (sport, tourism and hospitality).

*Keywords: Acropolis Museum of Athens, Constitutionalism, Cultural rights to recreation (Culture and Education), Cultural tourism, Fundamental rights, Heritage, Movement rights to recreation (Sport, Tourism and Hospitality), Right to pursuit of happiness, Right to recreation (Right /  $\Psi$ , X), Right to unearthing monuments*

### INTRODUCTION: RECREATION, THE GENERAL RIGHT FOR “UNKNOWN” INDIVIDUALS

The current research focuses on the fundamental right to recreation, exemplified by the specific right to heritage, particularly the cultural one, and the right to tourism. Heritage is a particularly sensitive part of culture and mainly of the environment. It has to do usually with the cultural environment but also, in some cases, with the natural environment, like petrified forests. Tourism may be strictly related to the goods, particularly the material ones, of cultural heritage.

Recreational activities will be analyzed, with emphasis on tourism in correlation with heritage.

We suppose that the right to recreation needs further recognition and promotion.

The paper examines the following topics:

- all generations of fundamental rights,
- the right to pursuit of happiness,
- the right to vacations,
- the right to heritage and tourism as versions of the right to recreation,
- the Acropolis Museum of Athens, as a case study,
- the antiquities in the city of Kalamata, as a second case study, and
- the protection and promotion of heritage.

#### An Overview of the Generations of Fundamental Rights

Fundamental rights are defined as the legal rights of persons, either natural or legal, that have to do with the role of the State. These public law rights are usually consecrated in formal Constitutions but a fundamental right may be an unrecognized possibility, at least explicitly in this supreme level of norms.

As far as the world history of the emergence of fundamental rights is concerned, there are four generations. The first one has to do with two groups, consisting in civil rights, such as the right to life, to liberty, to property etc., and political rights, exemplified by the rights to elect and to be elected particularly in the parliamentary elections and to participate in a political party.

The second generation appeared after the end of World War I but was developed mainly after the end of World War II. If it is known particularly as the generation of social rights, it is not connected uniquely with the model of Welfare State delivering free services to people, like education. It has to do with the set of economic rights, such as the employment, the syndicalism and the strike. In this era, new rights have been recognized, to human rest, free time and recreation. The French State was pioneer to recognize explicitly the universal right to recreation, in the Preamble of its Constitution of 1946. According to par. 11 of this text, the French nation *“shall guarantee to all, notably to children, mothers and elderly workers, protection of their health, material security, rest and leisure”*. This rule is so important that scholars make use of it even to back up the right to sports, which has no constitutional consecration (Marcilloux – Giummarra, 2011). Anyway, it goes without saying that there is also another set of rights in the framework of this generation, related to various forms of culture.

The third generation has to do with modern activities, coming from the international law doctrine and rules. The public law doctrine was very reluctant to recognize it, at least till the end of 20<sup>th</sup> century. There is still vagueness on the matter, in various aspects, such as the content of the rights, their subjects (having to do with people as entities in the framework of the international communities or with private individuals), their legal nature in combination with the question of sanctions...

The rights of this generation emerged from about 1975 and on, although the term is a little bit more

recent, introduced and used by the doctrine and not by the norms themselves. As already signalized, they were institutionalized mainly due to the initiative and the mobility of UN and have a crucial content for the destiny of people, particularly of those of the underdeveloped world. However, even national constitutional orders have been endowed with norms on them, as it is the case of the right to the environment which is regarded as the mainstreaming right of this generation. They are frequently called "solidarity rights" because they have to do with the expression of solidarity (fraternity) for people or private individuals, usually directly or even indirectly, by supporting the State helping the weak or endangered social groups. They are similar mainly to social rights (second generation), because they focus on the socioeconomic support of various groups. They are also related to civil rights, as they are not merely a possibility to help members of the society but also to enjoy some goods by the subjects of 3G rights, themselves. For instance, the right to the environment has a double content, to the enjoyment and to the protection of goods of the natural or the cultural environment. So, as far as the protection is concerned, the private individual may protect the environment for his own interest or by merely expressing his solidarity to other members of the society. In a similar way, another emblematic right of the 3G era consisted in the right (being also a very important general principle) to the sustainable development of regions, countries or the entire planet.

The fourth generation is still a marginal matter in the level of the doctrine and has not been recognized, at least explicitly, by the jurisprudence as a separate generation. Anyway, it began to emerge about in 1995 and has as its emblematic right the participation to the Information Society. The so-called "Knowledge Age" is strictly related to the advent of new technologies, mainly in the field of communications and information. On the one hand, there is the set of rights promoting the communications, as already signalized, and, on the other hand, rights to protection against information have also been institutionalized, exemplified by the right to protection of personal data. There are also other rights, already recognized or still in process of recognition. For instance, some of them are related to genetic engineering and are close to the relatively new science of Bioethics. There is also a trend having to do with the recognition of rights related to the world of animals.

## **THE RIGHT TO PURSUIT OF HAPPINESS**

In the current era of 4G rights, another fundamental right could be recognized. It is about the "forgotten" possibility to pursuit of happiness, essentially the right to hope, which seems to be an all-time classic issue (Maniatis, 2017a). It emerged within the American Declaration of Independence, of 4<sup>th</sup> July 1776. According to this revolutionary text of the 13 independent United States of America: "*We hold these*

*truths to be self-evident, that all men are created equal, that they are endowed by their Creator with certain unalienable Rights, that among these are Life, Liberty and the pursuit of Happiness*". Furthermore, the right to pursuit of happiness is also implicitly included in the French Declaration of the Rights of Man and the Citizen, of 26<sup>th</sup> August 1789, which makes a reference to the objective of the "happiness of all". This Declaration constitutes the point of reference of the French institutions, mainly in the Constitutions of 1852, 1946 and 1958. The Preamble of the current Constitution makes an explicit reference to it whilst even the Constitutional Council tends to invoke it.

The right to pursuit of happiness, being present in the above-mentioned declarations, was omitted in the Constitutions of the era that was inaugurated by them.

Umberto Eco made an all-time classic comment, on the right to happiness, in 2014 (Eco, 2014). He formulated the opinion that the literature on happiness is enormous, from Epicurus and perhaps before him and on, but he believed that nobody knows in what happiness consists. He could not admit that it is about a permanent status for common people. The question is that happiness, conceived as an absolute fulness, is a very transitory situation, episodic and brief, like a moment in the course of an excursion in the countryside. So, happiness is obviously related to recreational activities, such as excursion and tourism journeys. Furthermore, the idea of happiness evokes always the personal happiness and hardly ever the one of the human species.

As far as the juridical science is concerned, it seems rather divided on this "forgotten" human right whilst still a few experts have treated this quite unelaborated topic. On the one hand, in 2008 the opinion was formulated that this right exists, resulting from various factors, like the historical antecedent (Gemma, 2008). Although the right was recognized in Declarations and not in ulterior formal Constitutions, it is not regarded as strange in both the vocabulary and the principles of Constitutional Law.

It is logical to look for a legal back in article 2a of the Italian Constitution (and the similar article 25 par. 1a of the Greek Constitution), according to which: *"The Republic recognizes and guarantees the inviolable rights of the person, both as an individual and in the social groups where human personality is expressed"*. This disposition is endowed with a content quite similar to the question of recognition of new human rights. Various rights have been deduced from sectors of doctrine and jurisprudence in Italian legal order, beyond the explicitly consecrated in various constitutional dispositions.

However, the right to pursuit of happiness does not have the same nature to the consecrated in the Constitutions and to those deduced from these. It is possible to be deduced from the Constitution, via the recourse to either the teleological interpretation or the systematic one. It constitutes the *ratio* of all the other constitutional rights, being considered as a system, and from this *ratio* would be possible to deduce this right, being transversal to the other ones. It is connected with the phenomenon of multiplication of constitutional rights of various nature, in the process of interpretation of the fundamental charter. From the explicit provision of one or more constitutional rights it is possible to deduce rights that are implicitly formulated, because either these rights are the prerequisites of the explicitly consecrated rights (for instance, the right to life is not mentioned in the Italian Constitution whilst it is previewed in other Constitutions) or simply result from the mentioned rights (like the right to the environment in correlation with the right to health, being mentioned in article 32 of the same Constitution). On account of these data, it is obvious that the right to pursuit of happiness is not just another right, beyond the classical ones. It is in a logical relation not with some single rights but with the entire constellation of the constitutional rights.

Nevertheless, there is also another article to wonder about its utility as a constitutional back of the right on the matter (Rotondo, 2013). It is about article 3, according to which:

*“All citizens have equal social dignity and are equal before the law, without distinction of sex, race, language, religion, political opinion, personal and social conditions.*

*It is the duty of the Republic to remove those obstacles of an economic or social nature which constrain the freedom and equality of citizens, thereby impeding the full development of the human person and the effective participation of all workers in the political, economic and social organization of the country”.*

Whilst a lot of stakes have been introduced to article 3 by the Constitutional Court's interpretations, it is to wonder whether man should instead do the opposite route and interpret it extensively, as a right to research of happiness, or not. According to this approach, the right to happiness seems to be the mother of all rights. In case that a person is a victim of discrimination, is treated as a B Class citizen, is submitted to violence for what he is, for his own status, is deprived of an assured income, he cannot feel happy.

Besides, there is the opinion that the right to pursuit of happiness is the fundament for constitutional pretensions that cannot be based on other rights, being explicitly consecrated in the Constitution (Gemma, 2008). These pretensions are related to the acts or omissions of other persons, mainly in public domain of life. For instance, they are disconnected from the disappointment of a fan, provoked by the defeat of the team that he supports. So recreational activities of minor importance are not linked with the serious question of the right on the matter.

The human needs, mainly of psychological order, may be translated as versions of the constitutional interest in happiness. An example has to do with the area of family relationships and to events related to these. As for the behavior of parents towards the children, exist behaviors, being absolutely unrecognized by norms and judicial decisions, of persons that tend to place their children in conflict to the other spouse or that cause suffering of children without justifying reason. In this concept, we add the example of the revindication of women beyond the age limit of 50 years to medically assisted procreation.

Moreover, the existence of a right to pursuit of happiness should not be regarded as the legal victory of the individualism but can be correlated to the symmetrical phenomenon of the so-called "fundamental duties" of citizens. Indeed, it is in full harmony with the concept of solidarity of private individuals (Gemma, 2008).

However, this right is not fully admitted within the juridical science. For instance, a part of the Italian doctrine signalizes on the hypothetical new rights that there is the danger of an absolute approach to the type of the constitutional right to vacations, without defining its material limits (Ferro, 2014). In the framework of this controversy, the doctrine makes reference to a "privilege" ruling the "new rights". As these rights have not managed to be a part of positive law so far, they cannot be placed in the more severe field of norms that rule the traditional rights, being explicitly consecrated in the Constitution.

## **THE RIGHT TO VACATIONS**

The right to vacations, let alone to peaceful ones, may be regarded as one of the various specific versions of the eventual "right to happiness" or "to serenity" (Maniatis, 2017a). Nevertheless, the civil jurisprudence of the Italian Supreme Court is not friendly to such a development. The tribunal, in its decision n. 26972 of 11<sup>th</sup> November 2008, denied the existence of a right to happiness, in the framework of a case having to do with claims on recovery of material damage. This right was eloquently considered as "wholly imaginary". If a part of the doctrine, invoking the judicial negativism, considers that positive law is quite satisfactory to back any civil law pretensions in case of damage, the tourism law cases included, it does not stop in this point but also adds that the right of pursuit to happiness is merely a fiction.

It is also to signalize that Italy became just the second State, after France in 2006, to put a Tourism Code into force, in 2011, but this text has not recognized the existence



of a “right to vacations”, at all (Ferro, 2014). In a similar way, within Italian Constitutional Law there is no autonomous fundamental right to vacations.

## **THE RIGHTS TO HERITAGE AND TOURISM AS VERSIONS OF THE RIGHT TO RECREATION**

The general right to recreation includes some other separate rights, besides the right to recreation itself. This specific right is exemplified by the rights to nightlife and to carnival, which are excluded from an explicit constitutional consecration, let alone the fact that Europe, with the exception of a few countries like Greece, has not developed particularly the nightlife recreation, even in the peak of tourism season!

We suggest the mainstreaming content of the general right to recreation be classified in the following groups (specific recreational rights):

### *A. Rights to culture*

The cultural rights consist in:

- a. Right to culture (particularly to art, first of all consecrated in the German Constitution of 1919) and to cultural heritage,
- b. Right to education (the physical education included).

### *B. Rights to movement*

The rights to physical movement of human beings, particularly from one place to another, include the following rights:

- a. To sports.

It is about a genuine and separate right, although strictly related to physical education in schools, as a specific version of the above-mentioned right to education. It was Mexico that initially intended to consecrate it in its Constitution but the Soviet Union became the first State to adopt a constitutional disposition on sport associations, in its 1936, whilst France has not done a similar step to date, as already signalized.

- b. To tourism, which constitutes a logical couple with the symmetrical human right to hospitality. It is to point out that “tourism and hotel industry” were included as public policy scopes in the first version of the 1946 Constitution of Italy, but this mention disappeared through the 2001 revision! So, the constitutional right to tourism may be regarded as a second generation right, which remains unrecognized, at least explicitly, in the vast majority of

countries, Italy included nowadays!

As far as tourism is concerned, it is not merely a taboo in constitutional terms but also a source of various prejudices and misperceptions. For instance, nobody wants to be identified as a tourist whilst there are decent alternatives like “traveler” or “visitor”. Furthermore, criticism exists against the phenomenon of “anonymization” of individuals participating in the movement of mass tourism, for instance discernable with the badge, the small hat etc. (Mylonopoulos, 2016). However, massive tourism constitutes an important democratization of tourism and more widely of leisure activities, in full correspondence not only to the human right of pursuit of happiness but also to the 3G right to development of tourism destinations. Of course, it is also associated to the movement of 4G right to protection of personal data of tourists.

### **CASE STUDY I: THE ACROPOLIS MUSEUM OF ATHENS**

The new Acropolis Museum in Athens, a modern architecture sample being constructed in front of the rock of Parthenon, has constituted an important tourism destination since June 2009. Nevertheless, it is not widely known on international scale that the Greek Ministry of Culture wanted to demolish two buildings of the same street, already listed as modern monuments, in favor of the Museum that would be inaugurated soon. The Council of State blocked the suppression of the listed buildings status, let alone was led to interpret the Constitution in a pioneer way. It judged that private individuals have not only the right but also the “responsibility” to protect the environment. This formulation was original, given that the Constitution explicitly refers to this fundamental right and not also to a kind of responsibility (quasi “debt” or “obligation”). So, visitors of the Museum and tourists can enjoy a walk in this pedestrians’ street, including the sight of the above-mentioned modern monuments that are still in operation.

So, the new juridical principle of equality between antiquities and modern monuments has been confirmed, whilst also the principle of sustainability could be alleged in favor of these buildings. It is to point out also another paradox, which consists in the tendency of this supreme administrative Court to avoid any explicit use of the constitutional tool of sustainability, after its introduction in the Constitution through the 2001 revision, not to mention that this Court had already consecrated it through its pioneer jurisprudence, some years earlier! Perhaps the judges, who on international scale are inspired by a wider tendency of judicial “self-restraint” in their duties, not only in the environmental disputes, consider the block of dispositions on the right to sustainable development as a too drastic legal “weapon” to make an explicit use, even in the famous trials. This case of self-restraint ties in with the material primacy of the Museum of Acropolis against the rest cultural goods of the same region, which does not implicate an absolute, negative approach against them but

coexistence. In other words, we believe that the Council of State has proceeded to a tacit (operational) classification of the general constitutional principles relevant to the Environmental Law and has reserved the use of the sustainable development principle for particularly delicate disputes, in a subsidiary way.

Besides, the case of this Museum has been used to prove that the official definition of tourism, adopted by the World Tourism Organization, is not absolutely accurate, as long as it previews a journey of at least 24 hours. For instance, a Frenchman can leave Paris for Athens in the morning, visit the Acropolis Museum (as well as the rock of Parthenon) and return to his country in the evening, having completed a tourism journey (Mylonopoulos, 2016)! The doctrine has logically supported that tourism should be exempted by clichés like that, which anyway do not facilitate even the world of business.

## CASE STUDY II: ANTIQUITIES IN THE CITY OF KALAMATA

The problem of the coverage with earth of an ancient immobile monument in the “Ypapanti” square of Kalamata, a city in Greece, emerged after excavation works in the Southern edge of the square, in the beginnings of 2008. Nevertheless, the antiquities on the matter have been earthed up since 1961 (Garoufou and Kallioupi, 2011).

Coverage with earth constitutes a controversial issue, particularly widespread in the archeological practice (Asimakopoulos, 2012). During the excavation for the metro of Thessalonica, an Early Christian Basilica was discovered, in the station “Syntrivani” (Marinos, 2012). The monument was to be transferred in a distance of about 200 meters, in the park of the Faculty of Theology. This decision was attacked and finally the coverage with earth was decided. “*The future cannot and should not be built against the past*”, according to some archeologists like Mr. Paul Chrysostomou, reminding of the final paragraph of the Amsterdam declaration, adopted in 1978. It is about the director of the excavation which was held in the cemetery of Archontikon, in Pella, with hundreds of impressive findings, such as the famous gold masks of Macedonian warriors. Samples of these masks were transferred to the Louvre Museum, in the periodical exhibition on Macedonia of Alexander the Great, which was completed in January 2012. However, identical samples, of the 6<sup>th</sup> century BC, were found in the hands of antiquities looters in October 2011, in a district out of Thessalonica. In summer 2011, during which no excavations were held, in the totally unguarded – due to the lack of resources – site of Archontikon over 10 pits of mound diggers were localized.

The recent double case of discoveries in the Central region of Macedonia, in Greece, reveals a permanent error, according to which the coverage with earth protects the monuments not only from the harm of their material substance but also from crimes. The “Syntrivani” square is added to the

casuistic of the coverage of the White Tower with earth and the prevention of the unearthing of the nicest temple in the "Antigonidon" square, which was transferred there in virtue of the ancient custom of the "wandering temples"...(Maniatis, 2010a).

As the State makes use of the coverage with earth as a "mortgage" for an on-the-field research, to be accomplished by the future generations of archaeologists, some private individuals take benefit from it as a "mortgage" for illicit excavations of the current era. As a result, a finding emerges, consisting in the counterbalancing dynamic of criminality against the controversial practice of Public Administration. So, administrative and private practices result in a homogeneous total, particularly in the countryside.

The recent developments in Kalamata shed light to other aspects of the problem of coverage with earth. The Municipality of Kalamata had planned the unearthing of the earthed-up monument in the "Ypapanti" square, within the scope "Regeneration of the Historical Center of Kalamata", but in the controversial way consisting in maintenance underground. This technique, thoroughly omitted by Law 3028/2002 on culture, has to do with the maintenance of the monument unearthed, below a glass cover (Maniatis, 2011). At last, the State decided, in spring 2011, to keep the monument earthed-up due to its own protection.

This somehow vague reason is not convincing provided that the monument does not seem to be in danger of antiquities looting or of natural damage, as it is located in the center of the city, on account of the unearthing experience during a semester, in 1960-1961.

The State sets the bad example to citizens as in the urban fabric denies them their own right to heritage, according to the principle of sustainable development, in virtue of par. 1 and 6 of article 24 in combination of par. 1 of article 106 of the Constitution. What has not been realized is that the dynamic of private individuals' criminality against the State, as the owner of the ancient monuments, more generally against the public interest, corresponds to controversial practices of the Public Administration like this. Owners of immobile things, particularly in the urban fabric, have the tendency to decide to earth up the findings of cultural interest. This is confirmed mainly when they desire to proceed to building works, a case in which complicity of the businessmen (building contractors) may occur.

Besides, the case of the earthed-up hypothetical gymnasium of the ancient City – State of "Pharai", in the South of the Venetian castle (former Citadel with a probable worship of the goddess Minerva) is comparable with another archeological site of the same city. It is about the ancient temple dedicated to Neptune, god of the sea and sailors' protector. Neptune's site constitutes a dipole along with the actual Southern town, the Old Town. In virtue of the General Plan of Country Planning and Sustainable Development, a State program being in vigor since July 2008, which recommends the

combined protection of monuments per space unity, a question emerges, consisting in not only the continuation of the excavation and the promotion of the archeological site in "Akovitika" of Kalamata (including antiquities besides Neptune's site) but also its correlation to the antiquities of the "Ypapanti" square. These antiquities should be unearthed and in principle maintained on the field, in the surface of the ground as Neptune's site is proposed to constitute a nautical archeological "open museum". This proposal is actual, given that the economic crisis of Greece has led to the abolition of Nautical Week, since summer 2010, against the nautical collective memory! Another thing that may be proved to be important is the correlation to the old, in vigor till the beginnings of the year 1960, official name of Kalamata, "Kalamai". That place name, meaning reeds, resulted from the fact that reeds fit in with wetlands. Consequently, if, according to an assumption, the current place name "Kalamata" corresponds to the goddess of the town having good eyes, namely Minerva and afterwards Madonna, the legally abolished place name "Kalamai" reminds of Neptune's site (although it may be connected even with the goddess, given that near the Castle the river "Nedon" exists).

## DISCUSSION ON THE PROTECTION AND PROMOTION OF HERITAGE

The above-mentioned case studies, mainly of the ancient monuments of Kalamata, are conducive to the following conclusions of a wider significance:

- 1) *Coverage with earth and illicit excavations in the open air, coverage with earth for self-interested reasons by the State and for building by private individuals in the town*

In the open air and in the urban fabric, State and society are involved in controversial practices, against the monuments, with the coverage with earth as a point of reference. This thing should be realized by the competent public authorities that anyway are supposed to have taken in time measures of guardianship of the archeological sites and of unearthing the monuments through programmed excavations, by observing the fundamental principle of proportionality.

- 2) *The climax of depreciation: "burying" ("marginal placement"), "coverage with earth", "rubbishing"*

The case of the maintenance underground usually constitutes a peculiar depreciation of the monument, consequently "burying" in the sense of marginal placement. However, it is to signalize that this term is adequate to cover even other cases of monuments, which are maintained in the surface of the ground but without the relevant protection.

The opinion that the "burying" of the unearthed monuments is presumed to constitute a more important problem for the Greek cultural heritage than the one of coverage with earth (in spite of the fact that by nature this coverage implicates more negative consequences for each monument in a separate way) favors the perpetuation of the coverage with earth. Well, it favors the obscurantism in the domain of history and archeology as well as the socioeconomic underdevelopment (Maniatis and

Kapralou, 2012). In fact, the coverage with earth cannot be assessed as long as nobody is sure about what exactly exists under the surface of the ground. Anyway, there is also the eventuality of “rubbishing” a monument, even in case it has not already been earthed-up. This happens, for instance, when an earthed-up monument is offended, either materially either morally, like through the non-convincing refusal of the State to allow its requested unearthing. This is confirmed as long as arguments reducing the archeological importance of the monument are used, without activating any democratic mechanisms of public exchange of views. It is to signalize that even the European Landscape Convention, promulgated by Greece through Law 3827/2010, consecrates no fundamental right to unearthing of monuments, or at least to public exchange of views and decision-making on the matter (Maniatis, 2010b). The irony of the fate is that the Municipality of Kalamata some years ago created a system of underground bins of rubbish to replace the grey bins in the surface of the ground...

3) *Depreciation of the nautical culture available for tourism business*

The case of Neptune’s temple highlights an important lack of protection and promotion of the culture of the Greek nautical nation. The landscape should be protected thoroughly and the recommended revival of the Nautical Week is proposed to resume through the highlighting of areas like this. As for the proposed “open museum”, man could benefit from international conventions, like the European Landscape Convention, which includes earth, internal waters and sea areas. Anyway, the Nautical Week constitutes a great challenge for leisure activities and tourism business, so a potential framework for the promotion of commercial products and services and for sponsorship.

4) *Need of a combined protection of landmarks and place names*

The need of protection of place names, particularly of the traditional ones, has emerged. The protection on the matter constitutes an important vacuum of the European Landscape Convention. It is recommended to protect in a combined way the landmarks of a certain area and the correspondent place names.

## **CONCLUSION: RECREATION, A CHALLENGE FOR CONSTITUTIONALISM**

The paper hypothesis has been fully confirmed as the right to recreation has not been explicitly consecrated in many Constitutions like the Italian and the Greek ones, yet. The right on the matter deserves to be called as the right “/ Ψ, X”, inspired by the Greek homonymous word “αναψυχή”, which means “recreation” and be treated in the democratic context implied by this name. Leisure activities must be seen as a universal human right, endowed with the back of companies accomplishing their mission or promoting themselves through sponsorship. The right to recreation

should be incorporated in the Constitutions along with:

- the general, similar right to pursuit of happiness
- the right to free time (right to vacations) and
- the specific recreational rights to culture (culture, the heritage included, and education) and to physical movement (sport, tourism – hospitality) (Maniatis, 2017b).

The current century is the time of pursuit of happiness through the recreational rights!

Last but not least, this challenge for current constitutionalism worldwide, should be completed by a special care for the specific right of recreation itself. This recreation is not a topic of minor importance in socioeconomic terms and has been marked sometimes by significant legal prohibitions, as it is the case of the carnival in mainstreaming tourism destinations, such as Venice and Tenerife. Indeed, it is worth consecrating explicitly the nightlife and the carnival and developing a systematic public policy for both these tourist attractions...

\*\*\*

Prohibitions are a policy of the past, recreation, let alone its artistic forms like carnival, a challenge for the future...

## REFERENCES

- Asimakopoulos, D. (2012), Administrative and penal measures for the protection of cultural goods (on the basis of L. 3658/2008), with emphasis on antiquities looting, unpublished diploma paper, Officers School of Greek Police, Athens (in Greek).
- Eco, U. (2014), "La bustina di minerva Il diritto alla felicità", *L'Espresso* (in Italian).
- Ferro, G. (2014), "Nuove frontiere della tutela del turista – consumatore nello spazio giuridico europeo e antiche diatribe domestiche: riflettendo sulle c.s. "danno da vacanza rovinata"", *Forum di Quaderni Costituzionali*, [http://www.forumcostituzionale.it/wordpress/images/stories/pdf/documenti\\_forum/paper/0488\\_ferro.pdf](http://www.forumcostituzionale.it/wordpress/images/stories/pdf/documenti_forum/paper/0488_ferro.pdf). (Accessed 29 April 2017, in Italian).
- Garoufou, P. and Kallioupi, P. (2011), "The question of unearthing and of hypothesis of the immobile monuments in the area of the "Ypapanti" square of Kalamata", *Limit*, February, p. 28 f. (in Greek).
- Gemma, G. (2008), "Esiste un diritto costituzionale alla felicità?", *AFDSUDC*, 12, pp. 519-531 (in Italian).
- Marcilloux – Giummarra, S. (2011), "L'implicite mais réelle influence de la Constitution sur le droit du sport", paper presented at VIIIe Congrès français de droit constitutionnel, AFDC, Nancy, 16, 17, et 18 juin 2011, available at: <http://www.droitconstitutionnel.org/congresNancy/comN1/marcillouxTD1.pdf>. (accessed 29 April 2017, in French).
- Maniatis, A. (2010a), Archeological on-the-field research and museums. A supplementary education in Cultural Law, *Ant. N. Sakkoulas Editions Athens – Komotini* (in Greek).
- Maniatis, A. (2010b), Fundamental Rights and Architectural Heritage. A contribution to Administrative Law, *Ant. N. Sakkoulas Editions 2010* (in Greek).
- Maniatis, A. (2011), "Half a Century Earthed-up Half a Struggle "Buried"", *Law + Nature* May (in Greek).
- Maniatis, A. and Kapralou P. (2012), "Institutional framework of country planning and of sustainable development with emphasis on museums", in *Association of Greek Regional Scientists, The Future of the Development Planning and of Country Planning of Greece* (in Greek).
- Maniatis, A. (2017a), "The Right to Pursuit of Happiness and Italian Tourism Law", *Tourism Development Journal*, Vol. 15, 1, pp. 49-58.
- Maniatis, A. (2017b), "Right / Ψ X", *Public Law*, 2017, 1, pp. 29-42 (in Greek).

- Marinos, V. (2012), Administrative and penal measures for the protection of cultural goods (on the basis of L. 3658/2008), with emphasis on antiquities looting, unpublished diploma paper, Officers School of Greek Police, Athens (in Greek).
- Mylonopoulos D. (2016), Tourism Law, Nomiki Vivliothiki 2016 (in Greek).
- Rotondo, G. (2013), "Al di là del bene e del male Il Diritto alla Felicità", Linkiesta.it, <http://www.linkiesta.it/it/blog-post/2013/12/04/il-diritto-alla-felicità/19773/> (in Italian).
- Vainopoulos, R. and Mercier, S. (2009), Le Tourisme, Le Cavalier Bleu Éditions (in French).



## OPTIONS FOR DIAGNOSTICS OF ECONOMIC EVOLUTION TURNING POINTS

Marek, Luboš<sup>1</sup>; Hindls, Richard<sup>1</sup>; Hronová, Stanislava<sup>2</sup>

<sup>1</sup>Department of Statistics and Probability, University of Economics, Prague, Czech Republic

<sup>2</sup>Department of Economic Statistics, University of Economics, Prague, Czech Republic

### ABSTRACT

This paper presents approaches to detecting turning points in economic evolution on the basis of probit analysis. Most methods describing the business cycle are based on evaluating information obtained from the evolution of certain short-term indices, with the idea of estimating a value (or rate) of an aggregate index so that a turn of the economic evolution is indicated. Probit analysis estimates probability of occurrence of such turning points. We apply our approach to data collected in the Czech Republic from 2007 to 2015.

*Keywords: GDP, turning point prediction, probit analysis*

### INTRODUCTION

The business cycle, i.e., alternating stages of growth and recession, is an integral part of economic evolution in all countries. Causes of such phenomena may be internal, based on the specific conditions governing the economic evolution in the given country (such as economic crises accompanying the transition from centrally planned economies to the market environment in the early 1990s); however, worldwide and multinational factors have been becoming more and more pronounced due to globalisation and cohesion of economies. The beginning of the new millennium witnessed several small-scale shakeouts, which coalesced into a mortgage crisis, followed by banking and fiscal crises. The economic recession in developed countries was so significant in the period of 2007-2009 that it has since been referred to as an economic crisis. The developed countries' economies are now growing, but the question of why that crisis occurred and, more importantly, whether its occurrence might have been predicted or estimated, is still highly relevant.

The fundamental starting point for our consideration is the nature of the business cycle – the expansion stage is characterised by growth and terminates when decline comes. But is each and every decline, in the sense of a slowdown in the GDP an indication that the recession and crisis are really coming? How can we recognise whether the economic changes are or are not so significant that the recession and subsequent crisis are to be expected?

The national economy is a complex live organism that cannot be pre-programmed and controlled with the aid of rigid charts and models. Neither can we expect to be able to "read" the symptoms from evolution of a single phenomenon expressed by a single index. In order to obtain the information related to the condition of the national economy, we need to continuously follow and evaluate the evolution of a number of indices that are relevant for diagnostics and predictions. On the other hand, how can we say which indices are relevant in this sense? Is their scope fixed, or does it undergo dynamic changes? In what way can we synthesise information implied by the evolution of these indices? These are questions asked by those who try to identify turning points, i.e., changes in the character of economic evolution in either direction.

Most methods that try to describe the business cycle and identify the turning points are based on evaluating information derived from evolution of a certain group of short-term (monthly and quarterly) indices. In the present text we describe a technique developed on the basis of probit analysis; this method will enable us to indicate, with high rates of probability, that a turn in the economic evolution is coming.

## **THEORETICAL AND METHODOLOGICAL BASIS**

All considerations of whether we can predict turning points in economic evolution and how to do it are based on the definition of the business cycle. A generally accepted definition was formulated by Burns and Mitchell (1946) during their work for the National Bureau of Economic Research (NBER): "Business cycles are a type of fluctuation found in the aggregate economic activity of nations that organize their work mainly in business enterprises: a cycle consists of expansions occurring at about the same time in many economic activities, followed by similarly general recessions, contractions, and revivals which merge into the expansion phase of the next cycle; this sequence of changes is recurrent but not periodic; in duration business cycles vary from more than one year to ten or twelve years; they are not divisible into shorter cycles of similar character with amplitudes approximating their own". Subsequently to this generally valid and respected definition, the economic and statistical practice has created a pragmatic definition, based on the GDP growth rates in two consecutive calendar quarters: the recession is beginning (or the growth is ending) when GDP has gone down in two consecutive quarters; and vice versa, the growth is beginning (the recession is ending) when GDP has been growing in two consecutive quarters. It has turned out that this "two-quarter rule" and the NBER definition are not too distant from each other (cf. Negro, 2001).

The two-quarter rule is an indicator of changes in the economy that have already taken place, bringing information ex-post, on the basis of the past described by statistical data. On the contrary, we seek the turning points and therefore need to predict such changes. Hence we have to use tools based on the

past but having potential for predictions. This approach, of course, leads us to monitoring the evolution of a certain group of indices that (directly or indirectly) affect the GDP evolution. Methods of leading indicators, econometric models, and probit models are most frequently used to generalise the information stemming from the inference on the evolution of values in a certain group of indices.

The notion of leading indicators was, as related to predicting the turning points in the business cycle, first introduced in the late 1930s thanks to the work at the NBER (cf. Mitchell and Burns, 1961). The then defined group of leading indicators has gradually been modified according to the underlying economic conditions. But the universal basis always consists of monthly (quarterly) values of the selected indices covering the industries, construction industry, consumption, capital markets and finances. In the 1990s, indicators obtained by business cycle surveys (expectations in industries, construction industry, services, and the Index of Consumer Expectations) got to the limelight. An advantage of these indicators is that they are easy to obtain and have a great potential for predictions.

The necessity of synthesis the information coming from the evolution of the leading indicators brought about the composite (leading) indicators. A general problem when setting up a composite indicator is the choice of a suitable group of leading indicators and determination of the weights with which the individual leading indicators are reflected in the resulting composite indicator. With regard to the subjective nature of the choice of the leading indicators and the weights, the ability of composite indicators to predict the turning points is rather problematic.

Another type of synthesis of the information concerning the evolution of a selected group of indices is represented by *econometric models*. There are two categories of these methods for predicting the turning points: the first sets up a model for estimating the growth rate of the GDP and other aggregates. The other one directly predicts the turning points. In this area, in addition to the traditional models based on simultaneous equations (cf., e.g., Fair, 1994 or Klein, 1991), there are VAR models (cf., e.g., Hamilton, 1989; Zellner et al., 1991; and Li and Dorfman, 1996) or dynamic factor models using leading indicators (cf., e.g., Kim and Nelson, 1998; Stock and Watson, 1993; and Jun and Joo, 1993). All these approaches assume that the basic conditions of the economy remain preserved during the stages of growth and recession. What is changing is the positive or negative sign of the growth rate. In other words, the economy goes from growth to recession via turning points and the latter reflect the changes in economic behaviour of economic subjects, not only the negative phenomena (shocks) in the economy.

*Probit models* predict the turning points with the aid of a probabilistic model in which a probability value of a turning point occurrence is estimated. An advantage of probit analysis is, in comparison with traditional econometric models, not determining the actual values of the index in question (most often the GDP) but only estimating the probability of occurrence of a situation in which a turning point might be present. It is not a direct calculation of, say, the GDP value, quarterly indices or annual

growth rates. We could say that it is a statistically recognised "potential for a change", or identification of "turning trends".

Probit models, similar to other models for estimating the turning points in the business cycle, prevailed in the 1990s. The probit model based on financial indices (cf. Estrella and Mishkin, 1998) may be viewed as one of the important inputs in this area. Nyberg (2010) proposed the dynamic extensions of probit model of Estrella and Mishkin (1998) to predict monthly recession periods in the USA and Germany. Another approach, based on estimating probability of turning point in the unemployment rate evolution, was applied in the economic practice (cf. Chin D., Geweke J. and Miller P., 2000). This model makes use of both financial and non-financial indices on the input. Hao, L. and Ng, E. C. Y. (2011) examined the ability of various financial and macroeconomic variables to forecast Canadian recessions; they used the advanced dynamic, autoregressive, dynamic autoregressive probit models and the conventional static probit model. Proano, C. R. and Theobald, T. (2014) have proposed a composite indicator for real-time recession forecasting based on alternative dynamic probit models and have used a lot of monthly macroeconomic and financial leading indicators from the Germany and USA.

The probit model introduced in the present paper is to be used for detecting the turning points in the trend of an index in question (or its long-term evolution trends). One of its advantages is the fact that it need not utilise smooth trend functions, some of which even do not admit inflexion points in the evolution curve, such as the line; others may have inflexion points (such as higher-degree polynomials) but these points rather reflect the mathematical character of the selected function. i.e., are of a formal nature. Another advantage is that neither adaptive nor stochastic models are used for the description of the turning points and therefore the assumptions for the use of such models need not be verified, which would often be a complicated procedure.

## **BASIC CONCEPT OF THE MODEL**

The suggested probit model assumes that we have at our disposal one dependent variable and several independent ones. The dependent variable is, in this instance, the basic index expressing the economic performance, namely, the GDP, or rather its quarterly growth rates, in the period from 2007 to 2015. We feel that this period of time provides us with a sufficiently long time series; moreover, the Czech economy underwent several critical moments during that time.

For independent variables we take indices that are decisive for the evolution of the economy, and therefore the GDP growth rate. We identified the most important ones from among those by gradual reduction and factual analysis (cf. the Tables and calculations below). While identifying the suitable independent variables (and eliminating the less suitable ones), we were guided by the principle that we need indices whose values sensitively respond to the conjunctural cycle stages, are available timely and

with a high degree of reliability, and represent the key industries or economic sectors. In particular, we focused our attention on the indices representing the following areas:

- The general industry as the dominant sector in the Czech economy;
- The construction industry, whose results very sensitively respond to the stages of the conjunctural cycle in the Czech economy; and
- The area of salaries and wages, which markedly reflects the stages of the economy growth and recession.

From among a number of indices offered by the official statistics (the Czech Statistical Office) with quarterly frequency, we have chosen the following characteristics for our independent variables, respecting the above-mentioned principles and restrictions.

The industrial *production index* (a year-to-year quarterly index, denoted by  $x_1$ ). It expresses the dynamics of industrial production. Another index is that of the *sales from industrial activities* (a year-to-year quarterly index, denoted by  $x_6$ ), It expresses the dynamics of industrial revenues.

We have chosen two indices from the construction industry: one for the "recorded past" – the *construction production index* (a year-to-year quarterly index of the physical volume, denoted by  $x_2$ ); and another one for the "contracted future", i.e., the *new construction orders* (denoted by  $x_4$ ). The construction production expresses the dynamics of the volume of construction works carried out by businesses in which construction is the prevailing type of activity. The "new orders" index follows the value of the *building construction* and *civil engineering works* in the Czech Republic. These indices also indicate future demand for construction materials and labour force in the months to come.

In the area of wages and salaries we have also chosen two indices: the *unemployment rate* (percentage values, denoted by  $x_3$ ), and *wages and salaries* (a year-to-year quarterly index in current prices, denoted by  $x_5$ ). The Czech Statistical Office calculates and publishes the so-called general unemployment rate, which is the ratio of the unemployed to the total labour force (15 to 64 years of age); both the numerator and the denominator in this fraction correspond to the definitions and recommendations of the International Labour Organisation (ILO). The data are adjusted of seasonal influences. The wages and salaries index is based on the methodology of national accounting and expresses the volume of regular and irregular monetary and in-kind income received as fee for work carried out according to the employment and other laws. It includes the income tax and social insurance paid by employees.

## **THEORETICAL PROBIT CONCEPT FOR DETECTING TURNING POINTS**

The concept of the turning point indication with the aid of the probit analysis can be formulated as follows: we monitor the evolution of a certain index,  $y_t$ , and look for a moment of time at which a turn in the evolution occurs (both qualitative and quantitative). This moment is then viewed as a turning

point brought about by economic phenomena on such a scope that the actual evolution is turned to the opposite direction and an overall change in the economic climate is observed.

Our first task is to choose an index whose character is sufficiently aggregate so that its change indicates an overall change in the economic climate. Logically, an aggregate from the system of the national accounts will be most suitable. Most frequently, the GDP is our choice; but another aggregate might be chosen provided that it expresses the overall performance of the economy. The  $y_t$  variable will be the dependent variable in the regression sense, and  $t = 1, 2, \dots, n$  will be the time variable.

The evolution of the index  $y_t$  is affected by  $p$  exogenous factors  $x_{1t}, x_{2t}, \dots, x_{pt}$ , that is, it is connected with the evolution of these factors. In other words, they are  $p$  independent variables. Their evolution may, as explained above, have an intervention character and may bring about a change in the evolution of the aggregate index  $y_t$ . Our next task is to find those exogenous (factor) variables that are significant and may influence the evolution of  $y_t$ . Probability  $P_Z$  that the behaviour of index  $y_t$  will undergo a qualitative change (in either direction) thus depends on exogenous variables  $x_1, x_2, \dots, x_p$ . Let us define the probability of a turning point occurrence as

$$P_Z = F(x_1, x_2, \dots, x_p). \quad (1)$$

Now we re-define the variable  $y_t$ . Namely, we create a new random variable  $Z$  as follows: the time series  $y_t$  will not be represented by its original numerical values (e.g., the GDP or its growth rate values), but will, with the aid of this artificial variable  $Z$ , be transformed to a "zero-one" form. Here  $Z_t = 0$  means that there is no turning point in the dependent variable's evolution at time  $t$ . On the contrary,  $Z_t = 1$  indicates presence of a turning point.

We have denoted by  $P_Z$  the probability that there is a turning point. Now we have to define the theoretical value of  $y_t$  at point  $Z_t$  as a function of the exogenous variables  $x_1, x_2, \dots, x_p$ . We can take into consideration the fact that, the dependence of  $Z_t$  at time  $t$  on the exogenous variables  $x_1, x_2, \dots, x_p$  is expressed by a theoretical linear regression hyperplane

$$\pi_{Z_t} = \alpha_0 + \alpha_1 x_{1t} + \alpha_2 x_{2t} + \dots + \alpha_p x_{pt}, \quad t = 1, 2, \dots, n \quad (2)$$

where  $\alpha_j, j = 1, 2, \dots, p$  are the theoretical partial regression parameters of this linear regression hyperplane.

As already mentioned above, the empirical value of  $Z_t$  indicates whether there is or is not a turning point at time  $t$ . The vector  $\mathbf{Z}$  of such values is thus an empirical estimate of the vector of the theoretical values of the linear regression hyperplane  $\pi$ , and vector  $\mathbf{Y}$  is a point estimator for the vector of the theoretical values of the linear regression hyperplane  $\pi$ . That is

$$\mathbf{Y} = \text{est } \pi, \quad (3)$$

Let us first assume that the parameters  $\vartheta_j, j = 1, 2, \dots, p$  are known. We transform  $y_t$  to the above-mentioned artificial "zero-one" variable at time  $t$ ; now we are getting to the basic idea of the turning point indication. If the run of the evolution is to actually occur at time  $t$ , the theoretical random variable  $\vartheta_t$  must exceed a certain threshold value (let us denote it by  $H_t$ ). It means that

$$\pi_t > H_t. \quad (4)$$

must hold at time  $t$ . The threshold value  $H_t$  is a random variable and we can assume that it is governed by the normal distribution with known parameters  $\vartheta$  and  $\vartheta^2$ . The probability that the monitored index achieves a status in which we indicate a turning point according to Formula (4) can be derived from

$$P(\pi > H) = P(H < \pi) = P\left(\frac{H - \mu}{\sigma} < \frac{\pi - \mu}{\sigma}\right) = F\left(\frac{\pi - \mu}{\sigma}\right) = F(\psi), \quad (5)$$

where

$$\psi = \frac{\pi - \mu}{\sigma} = \beta_0 + \beta_1 x_1 + \beta_2 x_2 + \dots + \beta_p x_p$$

is the normed form already mentioned in Formula (2). For the parameters of the theoretical regression hyperplane, we have

$$\beta_0 = \frac{\alpha_0 - \mu}{\sigma}, \quad \beta_1 = \frac{\alpha_1}{\sigma}, \quad \beta_2 = \frac{\alpha_2}{\sigma}, \dots, \quad \beta_p = \frac{\alpha_p}{\sigma}. \quad (6)$$

According to (5), the probability value  $F(\vartheta)$  corresponds to the distribution function of the normed normal distribution and is called *probit*. From the practical point of view, we will not deal with a vector of the theoretical values of the linear regression hyperplane  $\clubsuit$ , for the estimator given by Formula (3), but with its regression estimate  $\mathbf{Y}$ .

## ILLUSTRATION ON TIME SERIES OF NATIONAL ECONOMY IN THE CZECH REPUBLIC

Our search for the turning points stems from Formula (2). The choice of the exogenous variables will therefore play an important role. This choice is not easy to make, it will never be unambiguous, there should be an adequate number of such variables, and their choice should always respect statistical criteria (such as eliminating multicollinearity), as well as factual criteria (where the latter are of primary importance).

The exogenous variables must be factually related to the index expressing the overall performance of the economy – the aggregate dynamics of the GDP in this instance. The model setup includes identification of the dependent variable, the set of the independent variables, and the subsequent estimate of the linear regression hyperplane  $\vartheta \cdot \vartheta = \vartheta_0 + \vartheta_1 x_1 + \vartheta_2 x_2 + \dots + \vartheta_p x_p$  according to (2); that is,

$$Y_{(t)} = \text{est}\pi = \text{est}\alpha_0 + \text{est}\alpha_1x_1 + \text{est}\alpha_2x_2 + \text{est}\alpha_3x_3 + \text{est}\alpha_4x_4 + \text{est}\alpha_5x_5 + \text{est}\alpha_6x_6 = \quad (7)$$

$$= \alpha_0 + \alpha_1x_1 + \alpha_2x_2 + \alpha_3x_3 + \alpha_4x_4 + \alpha_5x_5 + \alpha_6x_6$$

The GDP, or rather its quarter-to-quarter indices, play the role of the dependent variable, as Table 1 shows. The corresponding probits are then determined.

4	Quarter	GDP	GDP indices	Year	Quarter	GDP	GDP indices
2007	Q1	942,051	.	2012	Q1	1,017,859	0.998
	Q2	944,126	1.002		Q2	1,014,883	0.997
	Q3	967,813	1.025		Q3	1,011,265	0.996
	Q4	979,829	1.012		Q4	1,014,942	1.004
2008	Q1	991,805	1.012	2013	Q1	1,013,154	0.998
	Q2	1,005,646	1.014		Q2	1,015,088	1.002
	Q3	1,017,012	1.011		Q3	1,020,879	1.006
	Q4	996,313	0.980		Q4	1,047,879	1.026
2009	Q1	993,972	0.998	2014	Q1	1,054,375	1.006
	Q2	974,788	0.981		Q2	1,070,196	1.015
	Q3	971,644	0.997		Q3	1,086,133	1.015
	Q4	983,089	1.012		Q4	1,101,830	1.014
2010	Q1	978,222	0.995	2015	Q1	1,119,947	1.016
	Q2	988,348	1.010		Q2	1,135,893	1.014
	Q3	992,387	1.004		Q3	1,147,260	1.010
	Q4	990,361	0.998		Q4	1,153,639	1.006
2011	Q1	998,308	1.008				
	Q2	1,003,298	1.005				
	Q3	1,008,390	1.005				
	Q4	1,019,675	1.011				

Table 7. Quarterly GDP values in the Czech Republic (million CZK, current prices, seasonally adjusted), and quarter-to-quarter indices of the GDP (source: [www.czso.cz](http://www.czso.cz))

The evolution of the quarter-to-quarter GDP indices is shown in Fig. 1. On the basis of factual economic considerations and visual counts we identified the turning points in Fig. 1. They are marked by dark triangles in Fig. 1, by bold black print with grey highlighting of the relevant fields in Table 1 for evolution peaks, and by white bold print with black highlighting for evolution saddles. Namely, there are the 3rd quarter in 2007 (peak), 4th quarter in 2009 (peak), 4th quarter in 2013 (peak), and 4th quarter in 2008 (saddle).



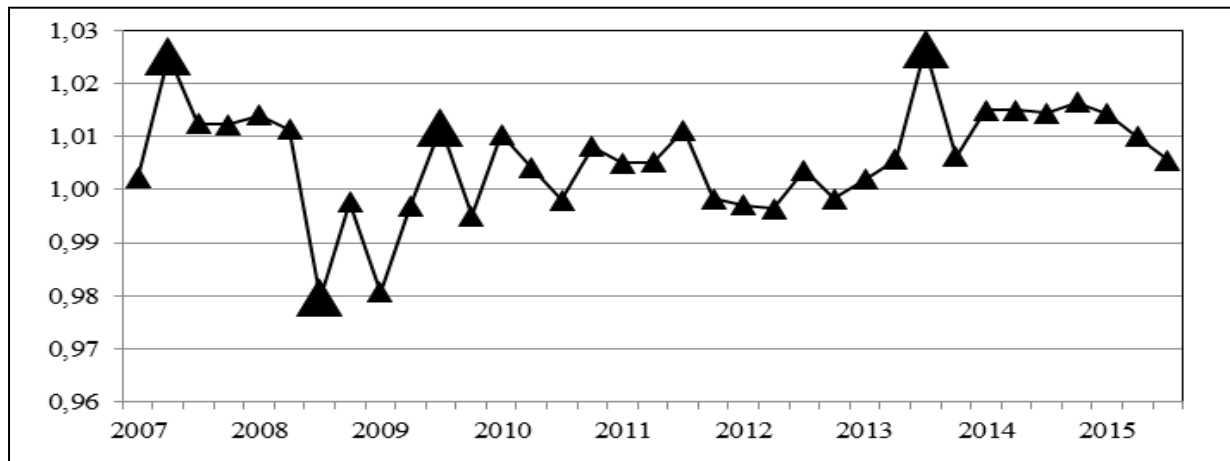

Figure 3. *Quarter-to-quarter GDP indices*

The first turning point (Q3-2007, with seasonally adjusted data) was a peak of the positive development in the Czech economy before the coming mortgage crisis, which then also prevailed in our economy. It is followed by a saddle representing the deep recession (2008 and 2009, the Q4-2008 saddle). A temporary recovery of the Czech economy (Q4-2009), which was not very distinct, was followed by more troubles (fiscal difficulties in European countries including the Czech Republic); however, these troubles did not bring about an evolution saddle. And finally there is the recovery of the Czech economy after overcoming the crises (Q4-2013).

Let us have a closer look at certain aspects of the economic evolution in the Czech Republic in the important nodes, so that we realise the causes for the turning points visible in the chart. The development in the Czech economy after 2000 can be divided into several stages: the recovery from 2001 to 2004, conjuncture from 2005 to 2007, followed by the recession and crisis (2008 and 2009). Nonetheless, the first two stages had different features. The year 2004 started a period of high growth rates, forewarned by a slowdown in the growth rate of the final consumption expenditure by households (year to year 3.4%, compared to the preceding value of 5%), growing gross fixed capital formation (year to year 4.0%, compared to the stagnation in the preceding year), and – above all – the positive foreign trade balance for the first time since 1993. On the other hand, the year 2007, when our analysis begins, indicated an overheated economy with a high rate of investment growth (by 13.5% in 2007), high growth in the final consumption expenditure by households (by 4.0% in both 2006 and 2007), record net borrowing of non-financial corporations (amounting to 211 bln. CZK – a sum never seen before), and the subsequent debtor position abroad, with the total net borrowing of the national economy amounting to (again the record figure of) 155 bln. CZK.

Years 2008 and 2009 brought a deep drop in the GDP growth, not only in the Czech Republic. Moreover, there was a drop in investments (year to year by 10.1%), drop in the final consumption expenditure by households (by 0.7%), and the government deficit amounted to a record value of 216

bln. CZK (5.5% of the GDP). Afterwards came another – fiscal – crisis, followed by growing indebtedness (a growing government debt of EU countries and growing deficits in budgets). The evolution of the GDP in the Czech Republic somehow stabilised as late as in 2013, accompanied by a slowdown in the recession in investments, a decrease of the government deficit, and a positive balance of the results of non-financial corporations.

However, such factual considerations of the turning points in the evolution of the national economy are insufficient for the use of formalised mathematical-statistical tools. Let us therefore analyse the turning points from the formal point of view, with the aid of the probit method. This method has a certain potential for predictions; we will also verify the "prediction ability". The latter is mainly characterised by the fact that probit is nothing else but probability of occurrence of a certain situation. Once we set up a model containing one endogenous and several exogenous variables of the type described in Formula (2), the probit values will enable us to make statements about probability values of occurrence of turning points.

A key issue to be resolved at the very beginning is the time shift in exogenous variables  $x_p$  with respect to the endogenous variable  $y$  (the GDP). The stochastic character of probits grants them with prognostic potential. If the exogenous variables have been properly chosen, their evolution may suggest in advance the evolution of  $y$  (the GDP), thus containing information on predictions. That is why we step one period back in the series of the exogenous variables: their evolution will thus be one step ahead of that of the endogenous variable. In other words, the  $x_p$  variables now enter the probit model from the periods Q1-2007 through Q3-2015, while the  $y$  variable from the periods Q2-2007 through Q4-2015. Let us now deal with formalisation of the probit method. For the moments of time which correspond to the turning points, we introduce the artificial "zero-one" variables, where a turning point (whether a peak or a saddle) has the value one, and the other points (with no turn in the GDP evolution) have the value zero. The output of this probit indication of the turning points is illustrated in Table 2 and Fig. 2. The  $Y_{(Q)}$  values stand for the regression estimates (obtained by the least-squared method) for the vector of the theoretical values of the linear regression hyperplane according to Formula (3), or for the particular estimates on the basis of the input data according to Formula (7):

$$Y_{(Q)} = \text{est}\pi = \text{est}\alpha_0 + \text{est}\alpha_1x_1 + \text{est}\alpha_2x_2 + \text{est}\alpha_3x_3 + \text{est}\alpha_4x_4 + \text{est}\alpha_5x_5 + \text{est}\alpha_6x_6 = \\ = 0.94289 + 0.00140x_1 + 0.00009x_2 - 0.00030x_3 - 0.00002x_4 - 0.00024x_5 - 0.00061x_6 \quad (7a)$$

The probits corresponding to the  $Y$  values were subsequently determined according to Formula (5). The turning points are marked with the "zero-one" variables as described above. We also state the estimates of the average and the standard deviation,  $s$ , which were necessary for the calculation of the probits according to Formula (5).

The average value for the "zero-one" variables (the "Turning point" column) amounts to 0.171, with a standard deviation value of 0.372. The average of  $Y_{(Q)}$  calculated according to Formula (7a) amounts to 1.006. Their standard deviation is 0.006. We will need these estimated characteristics for norming when calculating the probits.

t	Quarter	Turning point	Probit	Y(Q)	t	Quarter	Turning point	Probit	Y(Q)
2007	Q1	.	.	.	2012	Q1	0	0.306	1.003
	Q2	0	0.844	1.011		Q2	0	0.274	1.002
	Q3	1	0.744	1.009		Q3	0	0.276	1.002
	Q4	0	0.740	1.009		Q4	0	0.128	0.999
2008	Q1	0	0.434	1.005	2013	Q1	0	0.107	0.999
	Q2	0	0.616	1.007		Q2	0	0.184	1.001
	Q3	0	0.678	1.006		Q3	0	0.946	1.006
	Q4	1	0.019	0.994		Q4	1	0.720	1.009
2009	Q1	0	0.006	0.992	2014	Q1	0	0.771	1.010
	Q2	0	0.008	0.992		Q2	1	0.671	1.008
	Q3	0	0.785	0.997		Q3	0	0.540	1.006
	Q4	1	0.502	1.006		Q4	0	0.490	1.006
2010	Q1	0	0.699	1.009	2015	Q1	0	0.809	1.011
	Q2	0	0.827	1.011		Q2	0	0.768	1.011
	Q3	0	0.856	1.012		Q3	0	0.825	1.011
	Q4	0	0.675	1.012		Q4	0	0.777	1.010
2011	Q1	0	0.704	1.013					
	Q2	0	0.698	1.010					
	Q3	0	0.436	1.005					
	Q4	0	0.421	1.006					

Table 8. *Probit indication of turning points (authors' own calculations)*

Table 2 and Fig. 2 indicate that low values of the probits do not imply turning points in the evolution of the Czech economy. On the contrary, the Q3-2007 turning point (a grey field in Table 2 and a triangle mark ▲ in Fig. 2) the probit probability of a turning point occurrence as estimated in the preceding time step  $t_{\otimes}1$ , i.e., in Q2-2007, amounts to 0.844 (the probit value is marked with a large square mark ■ in Fig. 2). In other words, since the exogenous variables have been put one step (one quarter) backwards, a high value of probit at time Q2-2007 indicates a turning point in the GDP evolution at time Q3-2007, or rather, it indicates a high value of probability that the turn may occur in the next period.

A similar interpretation (cf. Table 2 and Fig. 2) is valid for Q4-2008 (one period ahead, i.e., at Q3-2008, the probit distinctly grows to 0.678; hence a coming turning point – saddle – is signaled). Similarly for Q4-2009 and Q4-2013 (always with the probit flag one step ahead) – in the last two instances the turning points are evolution peaks.

The coefficient of determination for the case of using the linear regression hyperplane with a time shift of the exogenous variables by one step backwards equals  $r^2 = 0.74477 = 74.477\%$ .

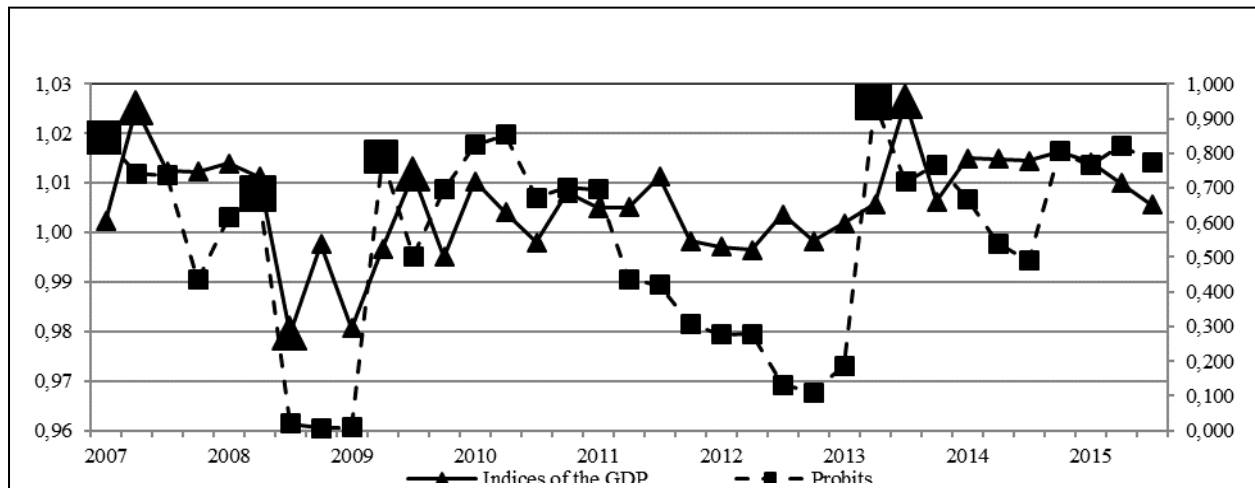

Figure 4. *Probits for the turning points*

In any case the most important task in the probit indication of the turning points is the requirement for a timely signal that the potential for the occurrence of an evolution turning point is growing. This would bring substantial information to be used in decision making in the economic policy.

The most important task in the probit indication of the turning points is the requirement for a timely signal that the potential for the occurrence of an evolution turning point is growing. This would bring substantial information to be used in decision making in the economic policy. However some open questions remain: What price level should be chosen for certain volume indices? It has not been satisfactorily shown which of the options – fixed prices, current prices, previous year's prices, etc. – is the best? Should original or seasonally cleaned data be used? A reply to this question will probably have to be found experimentally. A certain complication in this respect is implied from the fact that for data obtained from the public-domain sources it is usually unknown what procedures were used for the seasonal cleaning and/or whether all indices we would like to include in the model were seasonally cleaned by the same procedure? What length of the time series should be used?

## CONCLUSIONS

Detecting a turning point in economic evolution and, in particular, a possible beginning of recession is an all-encompassing problem. Its solution cannot be restricted to the use of one formalised (statistical or econometric) method. Neither can it be narrowed down to an indefinite factual analysis not based on data and evaluation of the evolution of key indices. Successfully coping with a risk of a turning point (of course, especially for recession, but also conjuncture as a way out of economic problems prevailing in a country or group of countries) is only possible by applying a carefully balanced combination of factual analysis and detailed analysis of key economic data.

Our method is an attempt at finding this very combination. It primarily preselects the decisive factors (exogenous variables) whose evolution may include potential for influencing the overall economic development. This, however, is not enough. We also have to analyse the genetic background of such influence on the aggregate index (usually the GDP, but another aggregate index is also possible). Now it is the right time for a factual analysis of the accompanying variables (as illustrated in the *Basic Concept of the Model* chapter of the present paper), and also for quantifying the possible risk, implied by the measure of this genetic background. It may be viewed as a kind of "risk seismograph".

The factual concept must defend the role and influence of the exogenous variables on the aggregate evolution, including a proper choice and reasoning of the selected indices – answering the question "how" and "why" the transfer occurs. The subsequent quantification (here with the aid of the probit method) must calculate the risk of transfer – answering the question "how much" or "to what extent". The main contribution of our method is the combination of both approaches, when both are simultaneously evaluated and intertwined. At the same time, we explicitly express the probability that a turning point (in either direction) occurs. Moreover, our model is interactive because we can add or remove the exogenous variables. Last but not least, there is a prediction potential – thanks to the one-step time delay of the endogenous variable (here the GDP) behind the lead exogenous variables we can try to predict changes to come.

## ACKNOWLEDGEMENTS

This paper was written with the support of the Czech Science Foundation project No. P402/12/G097 "DYME – Dynamic Models in Economics" and with the support of the Institutional Support to Long-Term Conceptual Development of Research Organisation, the Faculty of Informatics and Statistics of the University of Economics, Prague.

## REFERENCES

- Andersson, E., Bock, D., Frisé, M. (2004), "Detection of Turning Points in Business Cycles" Journal of Business Cycle Measurement and Analysis, OEC, Vol. 1, No. 1.
- Burns, A. F., Mitchell, W. C. (1946), *Measuring business cycles*, National Bureau of Economic Research, New York.
- Chin D., Geweke J., Miller P. (2000), *Predicting turning points*, Federal Reserve Bank of Minneapolis, Research Department, Staff Report № 267.
- Diebold, F. X., Rudebusch, G. D. (1996), "Measuring business cycles: A modern perspective", *Review of Economics and Statistics*, Vol. 78, pp. 67-77.
- Eliot, G., Granmger, C.W.J., Timmermann, A. (2006), *Handbook of Economic Forecasting*. North-Holland-Elsevier, Amsterdam.
- Estrella, A. and F. Mishkin (1998), "Predicting U.S. Recessions: Financial Variables as Leading Indicators", *The Review of Economics and Statistics*, Vol. 80, pp. 45–61.
- Fair, R. (1994), *Testing macroeconomic models*, Harvard University Press.

- Hamilton, J. D. (1989), "A new approach to the economic analysis of nonstationary time series and the business cycle", *Econometrica*, Vol. 57, pp. 357-384.
- Hao, L. and Ng, E. C. Y. (2011), "Predicting Canadian recessions using dynamic probit modelling approaches", *Canadian Journal of Economics*, Vol. 44, pp. 1297-1330.
- Hronová, S., Hindls, R. (2002), "Detekce a prognóza bodů obratu v ekonomickém vývoji" [Detection and prognosis of turning points in the economic development], *Politická ekonomie*, Vol. 50, pp. 217-227.
- Jun, D. B. and Joo, Y. J. (1993), "Predicting turning points in business cycles by detection of slope changes in the leading composite index", *Journal of Forecasting*, Vol. 12, pp. 97-213.
- Kim, C. J., Nelson, C. R. (1998), "Business cycle turning points, a new coincident index, and tests of duration dependence based on a dynamic factor model with regime switching", *Review of Economics and Statistics*, Vol. 80, pp. 188-201.
- Klein, L. R. (1991), *Comparative Performance of US Econometric Models*, Oxford University Press.
- Lahiri, K., Wang, J. G. (1994), "Predicting cyclical turning points with a leading index in a Markov Switching model", *Journal of Forecasting*, Vol. 13, pp. 245-263.
- Li, D. T., Dorfman, J. H. (1996), "Predicting turning points through the integration of multiple models", *Journal of Business and Economic Statistics*, Vol. 14, pp. 421-428.
- Mitchell, W. C., Burns, A. F. (1961), "Statistical indicators of cyclical revivals" (reprinted from Bulletin 69, New York, NBER, May 28, 1938), In: *Business cycles indicators*, Princeton University Press, pp. 162-183.
- Negro Del, M. (2001), "Turn, Turn, Turn: Predicting Turning Points in Economic Activity", *Federal Reserve Bank of Atlanta Economic Review* 86 (Second Quarter), pp. 1-12.
- Nyberg, H. (2010), "Dynamic probit models and financial variables in recession forecasting". *Journal of Forecasting*, Vol. 29, pp. 215-230.
- Proano, C. R. and Theobald, T. (2014), "Predicting recessions with a composite real-time dynamic probit model", *International Journal of Forecasting*, Vol. 30, pp. 898-917.
- Stock, J. H., Watson, M. W. (1993), "A Procedure for Predicting Recessions with Leading Indicators: Econometric Issues and Recent Experience". *Business Cycles, Indicators and Forecasting*, Vol. 28, pp. 95-156.
- Zellner, A., Hong, C., Min, C. K. (1991), "Forecasting Turning Points in International Output Growth Rates Using Bayesian Exponentially Weighted Autoregression, Time-Varying Parameter, and Pooling Techniques", *Journal of Econometrics*, Vol. 49, pp. 275-304.

## THE INFLUENCE OF PERSONAL AND ORGANIZATIONAL FACTORS ON ENTREPRENEURSHIP INTENTION: AN APPLICATION IN THE HEALTHCARE SECTOR

Marques, Carla Susana<sup>1</sup>; Valente, Sandra<sup>2</sup>; Lages, Marisa<sup>1</sup>

<sup>1</sup>CETRAD Research Center, University of Trás-os-Montes e Alto Douro (UTAD), Vila Real, Portugal

<sup>2</sup>Trás-os-Montes and Alto Douro Hospital Center (CHTMAD), Vila Real, Portugal

### ABSTRACT

This study sought to contribute to research on entrepreneurial intention (EI) by identifying which constructs of the entrepreneurial profile and internal conditions of healthcare organizations support entrepreneurship and contribute to the EI of nurses.

In addition to psychological attributes, cognitive processes, motivations, sociodemographic and professional characteristics, and entrepreneurial abilities, the literature indicates that internal conditions of organizations also contribute to explaining EI.

To evaluate this model empirically, the primary data were collected with questionnaires distributed to nurses. In two public hospitals—the Trás-os-Montes and Alto Douro Hospital Center (CHTMAD) and the Local Health Unit of the Northeast (ULSNE)—638 nurses filled out the questionnaire. The data were analyzed using inferential and regression analyses.

The results suggest that the dimensions related to personal attributes, namely, motivation and entrepreneurial skills, are the constructs that best explain the EI of these professionals within their organizations. A broad discussion is needed about how to implement internal conditions that promote an intrapreneurial and innovative culture in healthcare organizations.

The results confirm that healthcare organization administrators need to develop conditions that enhance the EI of their healthcare professionals and differentiate their practices from other organizations.

*Keywords: Entrepreneurial profile, entrepreneurial intention, intrapreneurship, health organizations, nurses.*

### AIMS

Society is currently experiencing an era of extensive entrepreneurship, dominated not only by increased entrepreneurial activity but also a fundamental change in the way of thinking about life,

organizations, and the environment. The concept of intrapreneurship has emerged, which can be defined as the way an organization can be transformed from inside to become more profitable when more visionary employees are allowed to implement their entrepreneurial ideas. Any organization can benefit from sustaining and encouraging entrepreneurship because, through entrepreneurship, organizations can develop, reinvent themselves, improve their performance, and ensure survival in the marketplace (Cadaru & Badulescu 2015). To this end, organizations must take into account their employees' entrepreneurial profile, as well as the internal organizational conditions that foment an entrepreneurial culture.

The entrepreneur is considered an agent of change: an innovator who produces new products, identifies new markets, combines resources to lead to new and unique modes of competitive advantage, and creates changes in the rules of market competitiveness. In contrast, the intrapreneur seeks to change the current state of his or her organization and to innovate within this context, which requires an organizational culture and environment that encourages successful intrapreneurship (Smith et al. 2016). An internal work environment that rewards and recognizes employee discretion—combined with the appropriate level of organizational boundaries, such as formalization, centralization, technological routines, and connectivity—is crucial to fostering organizational culture and job satisfaction. This, in turn, can lead to development of entrepreneurial orientation and intention within organizations (Karyotakis & Moustakis 2016).

Entrepreneurial intention (EI) is considered a significant construct in the most recent research on entrepreneurship, based on the evidence that EI predicts future entrepreneurial activity even in the very long term (Liñán & Fayolle 2015). Some studies have already related EI to entrepreneurial skills (e.g., Adeyemo 2009, Ibrahim & Lucky 2014), taking into account personal characteristics and context factors (e.g., Karimi et al. 2015, Singh et al. 2016). However, only a few studies have been conducted in health organizations (e.g., Lages 2015) and have specifically involved the growing number of nurses who are part of change processes in different areas of healthcare activities. Erdmann et al. (2009: 642) suggest that: "The visibility of ... nurse[s] is ... [increased] by ... [a] search of the interactive and associative possibilities of [their] social contribution[s] in ... different spaces and fields of action, in order to broaden and make known ... [nurses'] field of intervention". According to DeSantis and Scales (2015), nurses have an extremely important role in the healthcare system. However, to engage in innovative behavior, nurses need management support, resources, a favorable work environment, and knowledge about innovation and the role of nurses. Nursing leadership is, thus, vital to the development of nursing practices, fostering and supporting the level of intensity required for innovation processes.



Taking into account the aforementioned research, the present study had as its main objective to identify which constructs of the entrepreneurial profile and internal conditions of organizations promote the EI of a specific group of health professionals, namely, nurses. This research was justified by the lack of studies in this area, including the need for a fuller understanding of the relationship between the entrepreneurial profile, organizations' internal conditions, and healthcare professionals' EI in this case, nurses. The study sought to provide top administrators of health organizations with the information needed to develop conditions that foster their employees' intrapreneurial intentions, thereby differentiating how they exercise their profession in workplace activities from other organizations' employees.

After this introduction, a brief theoretical discussion of EI and related factors is provided. Section three describes the methodology used. In the fourth section, the results are presented, followed by the final sections' discussion of findings and this study's limitations and implications.

## **BACKGROUND**

### *Entrepreneurial Intention*

Intention can be interpreted as an indication of how willing an individual is to try something and how much effort he or she is willing to expend in order to engage in certain behaviors for a particular length of time (Kusmintarti et al. 2016). The decision to become an entrepreneur needs to be considered voluntarily and consciously (Krueger et al. 2000), so, logically, how this decision is made needs to be analyzed (Liñán & Chen 2009). Within the field of entrepreneurship, EI is already a consolidated area of research (e.g., Fayolle & Liñán 2014), with a growing number of entrepreneurship studies using this construct as a powerful theoretical reference (e.g., Liñán & Fayolle 2015). According to Fayolle and Liñán (2014), the work done by Shapero and Sokol (1982) and Shapero (1984) marks the period in which the literature on EI started its rapid growth (e.g., Fayolle & Liñán 2014, Fayolle et al. 2014).

EI can be defined as an individual's self-recognized conviction that he or she intends to start a new business and consciously plans to do so at some point in the future (Thompson 2009). Ibrahim and Lucky (2014) defined EI as a set of ideas that guide, coordinate, and control the action of creating and developing a new business, including its implementation and the evaluation of the external or internal environments of relevant organizations. In general, EIs depend on perceptions of the personal attractiveness and social norms of the viability of entrepreneurship, but some authors also mention that EIs depend on perceptions of personal convenience and viability, as well as individuals' propensity to act (Krueger et al. 2000). For a variety of authors (Krueger et al. 2000, Ismail et al. 2015), studying EI helps to understand its antecedents and to anticipate this intention (Ibrahim & Lucky

2014). Therefore, one of the dimensions chosen for the present study was to examine the EI of a specific group of healthcare professionals – nurses - in order to identify the antecedents of their EIs.

#### *Internal conditions of organizations*

A set of conditions can be identified that make the internal environment of an organization more welcoming to entrepreneurial attitudes. Most of these conditions are associated with the openness with which organizations deal with their employees, as well as the incentives administrators provide for employees to develop an entrepreneurial culture within the organization (e.g., Antoncic & Hisrich 2003). Bhardwaj and Sushil (2012) argue that, by giving appropriate rewards to employees, intrapreneurial activity can be improved. An effective reward system needs to consider goals, feedback, result-based incentives, and an emphasis on individual responsibility. Currently, dynamic and soft conditions advocate work environments that encourage new ideas, innovation, proactive behavior, risk-taking, and rational management, rewarding experiments, maturity, willingness to change, and open-mindedness (Karyotakis & Moustakis 2015). Several researchers have recognized the importance of internal organization conditions to promoting and supporting the development of an entrepreneurial environment (Kuratko et al. 2001, Hornsby et al. 2009). Notably, the size and type of organization (i.e., public, private, or non-profit) influence the internal conditions that the organization provides its employees (Zapkau et al. 2015). Kuratko et al. (2014) identify five specific dimensions that contribute to an environment that encourages entrepreneurial behavior: manager and/or coordinator support, autonomy, rewards, availability of time, and organizational procedures. Therefore following research hypothesis was proposed:

**H<sub>1</sub>:** The internal conditions of a healthcare organization foster the EI of nurses.

#### *Sociodemographic and socio-professional factors*

Previous research on EI has identified some factors related to individuals' intention to start a business, including social aspects, socio-professional contexts (e.g., Nabi & Liñan 2011, Karimi et al.

2015), and sociodemographic aspects, such as gender and training (e.g., Phipps et al. 2015). Regarding gender, several studies highlight the impact of gender on EI and gender differences among entrepreneurs (e.g., Pejić Bach et al. 2016). Liñán et al. (2011) refer to several determinants of EI, including demographic factors such as age, gender, education, and work experience. In regard to the target organizations of this study (i.e., healthcare institutions), a multitude of factors can stimulate intrapreneurship in these organizations, among which are social, administrative, demographic, professional, and educational aspects. Individual and sociocultural factors have a significant explanatory power for entrepreneurial intent and the decision to start a business (Singh et al. 2016, Darbyshire 2014). Based on these findings, the following hypothesis was formulated:

**H<sub>2</sub>:** Sociodemographic and professional characteristics influence the EI of nurses.

#### *Psychological and cognitive factors*

Despite some skepticism in the past, personality traits continue to attract considerable attention in entrepreneurship research. Studies of psychological and/or personality factors have revealed the complexities inherent in personality and cognition, with different types of variables influencing the way people see, interpret, and react to reality (Liñán & Fayolle 2015). Individuals' personality influence their behaviors and attitudes. Since the decision to start a business is a human behavior, it is influenced by psychological factors (Chedli 2016). In their studies in the healthcare sector, Marques et al. (2013) and Lages et al. (2016) identified the psychological factors of creativity and/or innovation, self-esteem and/or self-confidence, and self-autonomy. In the present study, based on the review of the literature discussed above, the following research hypothesis was proposed:

**H<sub>3</sub>:** Psychological factors influence the EI of nurses.

The cognitive approach emphasizes the fact that everything humans do or say is influenced by mental processes, motivations, perceptions, or attitudes. Through these processes, people acquire information and then store, transform, and use it to achieve different goals, make decisions, or solve problems (Fernández et al. 2009). Entrepreneurial cognition focuses on entrepreneurs' mental models and on the ways they link their psychological traits to entrepreneurial processes and outcomes (Chen et al. 2015, Virick et al. 2015). Tang et al. (2007), Marques et al. (2013) and Lages et al. (2016) refer factors such as perseverance, an optimistic perception of success, and the influence of affective states as cognitions that influence entrepreneurial behavior. Muehlfeld et al. (2015) confirm that one characteristic typically attributed to entrepreneurs is perseverance, namely, their commitment to a

chosen path and fearless pursuit despite adversity (e.g., Baron 2004, Holland & Shepherd 2013, Verheul et al. 2012, Patel & Thatcher 2014). In the present study, the cognitive attributes associated with the profile of the healthcare professionals under study were: (1) an optimistic perception of success, (2) perseverance, and (3) the influence of affective states. Based on this line of thought, the following hypothesis was formulated:

**H<sub>4</sub>:** Cognitive factors influence the EI of nurses.

#### *Motivational factors*

Chedli (2016) lists a number of motivational factors that influence entrepreneurial behavior. These fall into two categories: (1) psychological motivations, such as personality traits and satisfaction of personal needs and (2) contextual motivations, such as sociological interactions between individuals and their environment, situations, economic settings, and government aid. Debariev et al.'s (2015) study identified three motivational factors—personal attitude, perceived behavioral control, and subjective norms— that have a positive impact on EI. Romero-Martínez and Milone (2016), in turn, report that autonomy at work, self-actualization, and the need to find an alternative to unemployment are the main motivations for entrepreneurship. Research by Indarti and Rostiani (2008) identified a desire for self-realization as a determinant of EI. Taking into account the healthcare organizations and professionals involved in the present study, autonomy and self-actualization were considered determining variables for intrapreneurial intention. Thus, the following hypothesis was proposed:

**H<sub>5</sub>:** Motivations for intrapreneurship influence the EI of nurses.

#### *Entrepreneurial skills*

Entrepreneurial skills are necessary basic skills that enable individuals to start and successfully develop a financially viable business (Adeyemo 2009). Ibrahim and Lucky (2014) also observed that entrepreneurial skills are an important factor for the development of successful entrepreneurship and that these are related to entrepreneurs' EI. According to Ibrahim and Lucky (2014), in the context of entrepreneurship, capacity has been identified as one of the most important and necessary factors in becoming entrepreneurs and being successful in entrepreneurial activities, including as a characteristic of those who intend to become entrepreneurs. Phipps et al. (2015) emphasize that individuals need relevant knowledge and skills in order for their intrapreneurial intentions to succeed. Therefore, the following research hypothesis was formulated:

**H6:** The entrepreneurial capacities of nurses positively influence their IE.

### Conceptual Model

Based on the objective and research hypotheses presented in the previous subsections, the conceptual research model in Figure 1 was proposed. This model included the conceptualization and incorporation of relevant dimensions from the following studies: Tang et al. (2007), Marques et al. (2013), Lages et al. (2016) Liñan (2008) and Liñan and Chen (2009).

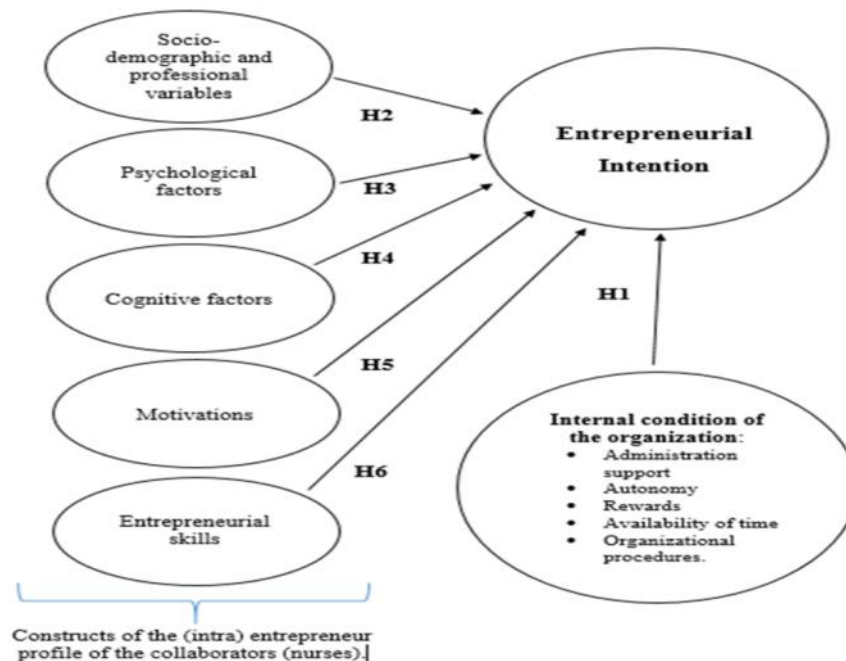

Figure 1 – The conceptual model.

## METHODS

In the two public hospitals involved in this study, 1,384 questionnaires were distributed –823 in the Trás-os-Montes and Alto Douro Hospital Center (CHTMAD) and 561 in the Local Health Unit of the Northeast (ULSNE) in the first half of 2016, and 638 questionnaires were collected. The five-part questionnaire contained closed-ended, multiple-choice questions with answers using a five-point Likert-type scale. The anonymity of the study participants was safeguarded to ensure ethical principles, and the data were treated using methods that guaranteed confidentiality. The scales used were validated by previous studies. More specifically, the scale of psychological and cognitive factors was taken from Marques et al.'s (2013) work. The entrepreneurship scale was originally developed by Liñan (2008) and translated and retranslated for the present study. For the EI scale, the scale was based on the one used by Liñan and Chen (2009), and the scale of organizations' internal conditions

came from Lages et al. (2016) study. The hypotheses developed for this study were tested via analyses of multiple linear regression coefficients and their respective statistical significance using a stepwise algorithm. In addition to these calculations, the explanatory capacity of the models (i.e., adjusted r-squared), the validity and suitability of the models for the data (i.e., analysis of variance), and possible multicollinearity problems (i.e., the condition index value) were analyzed.

## RESULTS

### *Characterization of Sample*

This research dealt with a sample of participants in a feminized healthcare profession (i.e., 79.9% of respondents are female), who were mostly married or in a civil union. In terms of age, 70.9% of the respondents were over 36 years old. Regarding qualifications, 85.3% of the sample have a higher education degree, and 12.6% have a master's degree. The data also revealed that only 18.2% of the participants were trained in management. A majority (62.4%) of the nurses worked in CHMTAD and 37.6% in ULSNE, dispersed across several hospital units. Almost 40% of the sample was concentrated in the Vila Real Hospital. In terms of employment status, 88.6% of the respondents had a permanent contract, while 10.9% have a fixed-term contract.

### *Validation of Research Instrument*

The factorial analysis for motivations for entrepreneurship led to the retention of two factors: self-realization (5 items; Cronbach's alpha = 0,898) and need/family influence (3 items; Cronbach's alpha = 0,789) that account for 71.58% of the explained variance, with good internal reliability results (KMO = 0,828).

The factorial solution for the items related to entrepreneurial skills led to the retention of a single factor (6 items; Cronbach's alpha =0,911). This is associated with 69.48% of the explained variance and an extremely good result from the internal reliability analysis (KMO = 0,888). The matrix of the components was also subjected to a varimax rotation.

The factor analysis of the items related to EI resulted in the retention of a single factor (6 items; Cronbach's alpha = 0,971), which accounts for 87.66% of the explained variance. This factor also produced extremely good result in the internal reliability analysis (KMO = 0,928).

The factor analysis of the main components for the cognitive profile items led to the retention of three factors: optimistic perception of success (5 items; Cronbach's alpha = 0,733), perseverance (2 items; Cronbach's alpha = 0,645) and influence of affective states (1 item) with acceptable results for internal reliability (KMO = 0,754).

In relation to psychological factors the factor analysis of the main components of the psychological profile resulted in the retention of three factors: propensity to risk and innovation (8 items; Cronbach's alpha = 0,845), self-control (3 items; Cronbach's alpha = 0,703) and autonomy (2 items; Cronbach's alpha = 0,723). These factors account for 52.88% of the explained variance. All internal reliability results are above the acceptable level for index creation (reliability (KMO = 0,918).

#### *Linear Regression Model*

In order to respond to the objective defined for this study, the research hypotheses were verified using multiple linear regression models. These included EI as the dependent variable and the independent variables of the entrepreneurial profile (i.e., motivations and cognitive, psychological, sociodemographic, and professional factors, as well as entrepreneurial capacities) and organizations' internal conditions. The results are presented in Table 1 and Figure 2.

**Table 1:** Linear regression models for predicting EI

		Coefficient	Standard error	p	Observations
Motivations	Self-realization	0.323	0.045	< 0.001	R2 adjusted 0.130; F = 43.800 (p < 0.001)
	Family need/influence	0.153	0.045	< 0.05	
	Constant	0.520	0.173		
Entrepreneurial skills	Entrepreneurial skills	0.644	0.049	< 0.001	R2 adjusted 0.222; F = 175.259 (p < 0.001)
	Constant	-0.084	0.166		
Cognitive profile	Optimistic perception of success	0.401	0.079	< 0.001	R2 adjusted 0.060; F = 20.013 (p < 0.001)
	Influence of affective states	0.120	0.046	< 0.001	
	Constant	0.360	0.274		
Psychological profile	Creativity and innovation	0.413	0.065	< 0.001	R2 adjusted 0.062; F = 40.381 (p < 0.001)
	Constant	0.494	0.251		
Sociodemographic and professional profile	Female gender	-0.450	0.115	< 0.001	R2 adjusted 0.053; F = 9.932 (p < 0.001)
	Age	-0.191	0.063	< 0.05	
	Management training	0.249	0.114	< 0.05	
Internal conditions of organization	Constant	3.273	0.306		R2 adjusted 0.038; F = 22.926 (p < 0.001)
	Operational autonomy	0.313	0.065	< 0.001	

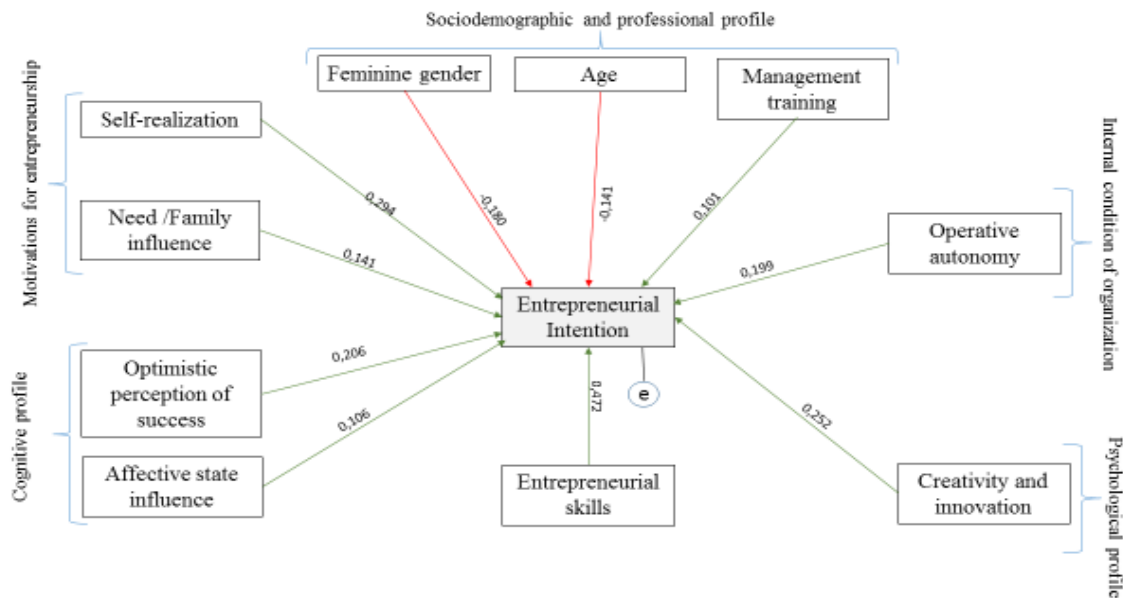

Figure 2 - Linear regression models for predicting EI

The results in Table 1 and Figure 2 can be divided into two large groups that can influence the nurses' EI: (1) the factors that constitute the entrepreneurial profile and (2) factors arising from organizations' internal conditions. Regarding nurses entrepreneurs, the results indicate that:

- The intrapreneurship motivations of self-realization and family need and/or influence contribute positively to EI.
- With regard to entrepreneurial skills, professionals with a higher level of entrepreneurial skills have a higher EI.
- Regarding cognitive profile factors, an optimistic perception of success and the influence of affective states contribute positively to EI.
- In the psychological profile, only the propensity to risk and innovation makes a statistically significant contribution to EI, and, the greater the respondents' propensity to risk and innovation manifested, the greater is their EI.
- With regard to the sociodemographic and professional profile, being female means a lower EI and being older also contributes negatively to EI, but having management training implies an increase in nurses' EI.
- Regarding organizations' internal conditions, the results verified that only the dimension of operational autonomy has statistical significance: the greater the autonomy granted by the health organization to the professional, the higher the level of EI within the organization.



## CONCLUSIONS

Ferreira et al. (2013) identified the permanent need to proactively design, create, and carry out activities and the skills to deal with and motivate people as entrepreneurial characteristics. The present study sought to fill the gap in the literature arising from the inexistence of valid instruments capable of measuring these characteristics quantitatively in a specific professional area such as healthcare. To this end, this section starts by presenting the results for the verification of the research hypotheses.

A positive relationship exists between operational autonomy and respondents' EI, thus reinforcing the conclusions of some authors who argue that individuals with greater autonomy at work have a higher level of EI (Hornsby et al. 1993, Kuratko et al. 2014) – confirm H<sub>1</sub>. The data offer support for H<sub>2</sub> since the analysis verified that being female means lower EI levels and that a more advanced age also contributes negatively to EI. In contrast, having training in management means a higher level of EI, which is in agreement with previous studies (Antoncic & Hisrich 2003, Rodrigues et al. 2008, Martiarena 2013, Urbano et al. 2013). The results of the present study provide support for H<sub>3</sub> so that, the higher the risk and innovation propensity manifested by respondents, the higher their EI, as suggested by the studies reviewed (Rodrigues et al. 2008, Martiarena 2013, Urbano et al. 2013). Since the factors of optimistic perception of success and influence of affective states contribute positively to EI, as argued by Marques et al. (2013) and Lages et al. (2016), H<sub>4</sub> was also confirmed. Based on the present results, H<sub>5</sub> is confirmed given that self-actualization and family need and/or influence contribute positively to EI. This has been corroborated by previous studies (Antoncic & Hisrich 2003, Baron 2004, Rodrigues et al. 2008). The final hypothesis was also confirmed since the data verified that, the higher the level of entrepreneurial skills of nurses, the higher their EI is. This confirms the findings of prior research (Phipps et al. 2015).

Given the limited research in this area, the present study could stimulate other scholars' interest in conducting future studies in this field because the present results confirm the great potential for research on this subject. Thus, due to the pioneering nature and singularity of the present study—in addition to its other merits—these findings are a significant contribution to the literature on EI. This study could also have future implications for both the scientific community and healthcare organizations. A study of this nature always entails some limitations: one limitation observed was that the questionnaires were only distributed to nurses in two public hospitals in a northern region of Portugal, so future research could extend this study's approach to include other regions of this country and carry out comparative studies with other type of institutions, especially in the private sector.

## IMPLICATIONS FOR NURSING MANAGEMENT

Organizational research is clearly important to the healthcare system, in particular when assessing the impacts of nursing, because most nurses perform functions in complex organizational contexts (Aiken & Patrician 2000). The importance of this study lies in how it recognizes nurses as potential entrepreneurs, as well as the influence of healthcare organizations' internal conditions that support entrepreneurship. The results could help top administrators and intermediate managers of healthcare organizations to develop activities that enhance the EI of nurses, thereby differentiating how they exercise their professions through workplace activities from other organizations' employees.

## ACKNOWLEDGEMENTS

This work is supported by: European Structural and Investment Funds in the FEDER component, through the Operational Competitiveness and Internationalization Programme (COMPETE 2020) [Project No. 006971 (UID/SOC/04011); Funding Reference: POCI-01-0145-FEDER-006971]; and national funds, through the FCT – Portuguese Foundation for Science and Technology under the project UID/SOC/04011/2013.

## REFERENCES

- Adeyemo S.A. (2009) Understanding and acquisition of entrepreneurial skills: a pedagogical re-orientation for classroom teacher in science education. *Journal of Turkish Science Education* 6(3), 57.
- Aiken, L.H., & Patrician, P.A. (2000). Measuring organizational traits of hospitals: the Revised Nursing Work Index. *Nursing research*, 49(3), 146-153.
- Antonic B. & Hisrich R. (2003) Clarifying the intrapreneurship concept. *Journal of Small Business and Enterprise Development* 10(1), 7-24.
- Baron R. (2004) Potential benefits of the cognitive perspective: expanding entrepreneurship's array of conceptual tools. *Journal of Business Venturing* 19, 169-172.
- Bhardwaj B.R. & Sushil (2012) Internal environment for corporate entrepreneurship: assessing CEAI model for emerging economies. *Journal of Chinese Entrepreneurship* 4(1), 70-87.
- Cadar O. & Badulescu D. (2015) Entrepreneur, entrepreneurship and intrapreneurship: a literature review. *The Annals of University of Oradea, Economic Sciences* 24 (2), 658-664.
- Chedli M.K.E. (2016) Entrepreneurial motivation and performance of enterprises. *Economics, Management and Financial Markets* 11(1), 175.
- Chen M.H., Chang Y.Y., & Lo Y.H. (2015) Creativity cognitive style, conflict, and career success for creative entrepreneurs. *Journal of Business Research* 68(4), 906-910.
- Darbyshire P. (2014) An idea whose time has come: nursing entrepreneurialism. *Whitireia Nursing & Health Journal* 21, 9-14.
- Debarliev S., Janeska-Iliev A., Bozhinovska T., & Ilieva, V. (2015) Antecedents of entrepreneurial intention: evidence from Republic of Macedonia. *Business and Economic Horizons* 11(3), 143-161.
- DeSantis K. & Scales T. W. (2015) NEW (nurse entrepreneurship worldwide). *Academy of Business Research Journal* 4, 92.
- Erdmann A.L., Fernandes J.V., Melo C., Carvalho B.R., Menezes Q., Freitas R.D., & Backes M.T.S. (2009) A visibilidade da profissão de enfermeiro: reconhecendo conquistas e lacunas. *Revista Brasileira de Enfermagem* 62(4), 637-643.
- Fayolle A. & Liñán F. (2014) The future of research on entrepreneurial intentions. *Journal of Business Research* 67(5), 663-666.

- Fayolle A., Liñán F., & Moriano J. (2014) Beyond entrepreneurial intentions: values and motivations in entrepreneurship. *International Entrepreneurship and Management Journal* 10(4), 679–689.
- Fernández J., Liñán F., & Santos F. (2009) Cognitive aspects of potential entrepreneurs in southern and northern Europe, an analysis using GEM-data. *Revista de Economía Mundial* 23, 151-178.
- Ferreira G.E., Rozendo C.A., dos Santos R.M., Pinto E.A., Costa A.C.S., & Porto A.R. (2013) Características empreendedoras do futuro enfermeiro. *Cogitare Enfermagem* 18(4), 688-694.
- Holland D.V. & Shepherd D.A. (2013) Deciding to persist: adversity, values, and entrepreneurs' decision policies. *Entrepreneurship Theory and Practice* 37(2), 331-358.
- Hornsby J., Kuratko D., Shepherd D., & Bott J. (2009) Managers' corporate entrepreneurial actions: examining perception and position. *Journal of Business Venturing* 24(3), 236-247.
- Hornsby S., Naftziger W., Kuratko F., & Montagno V. (1993) An interactive model of the corporate entrepreneurship process. *Entrepreneurship: Theory and Practice* 17(2), 29-37.
- Ibrahim N.A. & Lucky E.O.I. (2014) Relationship between entrepreneurial orientation, entrepreneurial skills, environmental factor and entrepreneurial intention among Nigerian students in UUM. *Entrepreneurship and Innovation Management Journal* 2(4), 203-213.
- Indarti N. & Rostiani R. (2008) Students' intentions of entrepreneurship: a comparison study between Indonesia, Japan, and Norway. *Jurnal Ekonomika dan Bisnis Indonesia* 23(4), 1-27.
- Ismail K., Anuar M.A., Omar W.W., Aziz A.A., Seohod K., & Akhtar C.S. (2015) Entrepreneurial intention, entrepreneurial orientation of faculty and students towards commercialization. *Procedia-Social and Behavioral Sciences* 181, 349-355.
- Karimi S., Biemans H.J.A., Mahdei K.N., Lans T., Chizari T., & Mulder M. (2015) Testing the relationship between personality characteristics, contextual factors and entrepreneurial intentions in a developing country. *International Journal of Psychology* September. DOI: 10.1002/ijop.12209
- Karyotakis K.M. & Moustakis V.S. (2016) Organizational factors, organizational culture, job satisfaction and entrepreneurial orientation in public administration. *The European Journal of Applied Economics* 13(1), 47-59.
- Karyotakis, K.M., & Moustakis, V.S. (2015). Innovating in Public Administration. Paper presented at the 12th Student Conference of Science and Technology, Athens University of Economics and Business & Hellenic Management Association, Athens, 14 May (pp. 114-124). In Greek.
- Krueger N.F., Reilly M.D., & Carsrud A.L. (2000) Competing models of entrepreneurial intentions. *Journal of Business Venturing* 15(5), 411-432.
- Kuratko D., Hornsby J., & Covin J. (2014) Diagnosing a firm's internal environment for corporate entrepreneurship. *Business Horizons* 57, 37-47.
- Kuratko D., Ireland R., & Hornsby J. (2001) Improving firm performance through entrepreneurial actions: Acordia's corporate entrepreneurship strategy. *Academy of Management Executive* 15(4), 60-71.
- Kusmintarti A., Thoyib A., Maskie G., & Ashar K. (2016) Entrepreneurial characteristics as a mediation of entrepreneurial education influence on entrepreneurial intention. *Journal of Entrepreneurship Education* 19(1), 24.
- Lages M., Marques C.S., Ferreira J. & Ferreira F. (2016) Intrapreneurship and Firm Entrepreneurial Orientation: insights from the health care service industry. *International Entrepreneurship and Management Journal*. DOI: 10.1007/s11365-016-0428-1.
- Liñán F. & Chen Y.W. (2009) Development and cross-cultural application of a specific instrument to measure entrepreneurial intentions. *Entrepreneurship Theory and Practice* 33(3), 593-617.
- Liñán F. & Fayolle A. (2015) A systematic literature review on entrepreneurial intentions: citation, thematic analyses, and research agenda. *International Entrepreneurship and Management Journal* 11(4), 907–933.
- Liñán F. (2008) Skill and value perceptions: how do they affect entrepreneurial intentions? *International Entrepreneurship and Management Journal* 4(3), 257-272.
- Liñán F., Cohard J., & Cantuche J. (2011) Factors affecting entrepreneurial intention levels: a role for education. *Entrepreneurial Management Journal* 7, 195-218.
- Marques C.S., Ferreira J. J., Ferreira F.A., & Lages M.F. (2013) Entrepreneurial orientation and motivation to start up a business: evidence from the health service industry. *International Entrepreneurship and Management Journal* 9(1), 77-94.
- Martiarena A. (2013) What's so entrepreneurial about intrapreneurs? *Small Business Economics* 40, 27-39
- Muehlfeld K., Urbig D., & Weitzel U. (2015) Entrepreneurs' exploratory perseverance in learning settings. *Entrepreneurship Theory and Practice* December. DOI: 10.1111/etap.12224
- Nabi G. & Liñán F. (2011) Graduate entrepreneurship in the developing world: intentions, education and development. *Education and Training*, 53, 325-334.

- Patel P.C. & Thatcher S.M. (2014) Sticking it out individual attributes and persistence in self-employment. *Journal of Management* 40(7), 1932-1979.
- Pejić Bach M., Merkač Skok M., & Suša D. (2016) Determinants of entrepreneurial intentions in ICT industry: gender and country of origin perspective. *Naše gospodarstvo/Our Economy* 62(1), 37-45.
- Phipps S.T., Prieto L.C., & Kungu K.K. (2015) Exploring the influence of creativity and political skill on entrepreneurial intentions among men and women: a comparison between Kenya and the United States. *International Journal of Entrepreneurship* 19, 179.
- Rodrigues G., Raposo M., Ferreira J., & Paço A. (2008) Entrepreneurship education and business creation propensity: testing a structural model. *International Journal Entrepreneurship and Small Business* 4(4), 485-504.
- Romero-Martínez A. M. & Milone M. (2016) El emprendimiento en España: intención emprendedora, motivaciones y obstáculos. *Revista de Globalización, Competitividad y Gobernabilidad* 1(1), 95
- Shapiro A. & Sokol L. (1982) The social dimensions of entrepreneurship. *Encyclopedia of Entrepreneurship* (C.A. Kent, D.L. Sexton, & K.H. Vesper eds), pp.72-90. Prentice-Hall, Englewood Cliffs, NJ.
- Shapiro, A. (1984). The entrepreneurial event. In C.A. Kent (Ed.), *The environment for entrepreneurship*. Lexington, Mass: Lexington Books.
- Singh B., Verma P., & Rao M.K. (2016) Influence of individual and socio-cultural factors on entrepreneurial intention. *South Asian Journal of Management* 23(1), 33-55.
- Smith L., Rees P., & Murray N. (2016) Turning entrepreneurs into intrapreneurs: Thomas Cook, a case-study. *Tourism Management* 56, 191-204.
- Tang J., Tang Z., & Lohrke F. (2007) Developing an entrepreneurial typology: the roles of entrepreneurial alertness and attributional style. *International Entrepreneurship and Management Journal* 4(3), 273-294.
- Thompson E. R. (2009) Individual entrepreneurial intent: construct clarification and development of an internationally reliable metric. *Entrepreneurship Theory and Practice* 33(3), 669-694.
- Urbano, D., Alvarez, C., & Turró, A. (2013). Organizational resources and intrapreneurial activities: an international study. *Management Decision*, 51(4), 854-870.
- Verheul I., Thurik R., Grilo I., & Van der Zwan P. (2012) Explaining preferences and actual involvement in self-employment: gender and the entrepreneurial personality. *Journal of Economic Psychology* 33(2), 325-341.
- Virick M., Basu A., & Rogers A. (2015) Antecedents of entrepreneurial intention among laid-off individuals: a cognitive appraisal approach. *Journal of Small Business Management* 53(2), 450-468.
- Zapkau F. B., Schwens C., Steinmetz H., & Kabst R. (2015) Disentangling the effect of prior entrepreneurial exposure on entrepreneurial intention. *Journal of Business Research* 68(3), 639-653.

## PROFILE OF WOMEN ENTREPRENEURS IN HEALTHCARE SETOR: AN EXPLORATORY STUDY

Marques, Carla Susana<sup>1</sup>; Mestre, Marta<sup>2</sup>; Nascimento, Maria M.<sup>3</sup>

<sup>1</sup>CETRAD Unit Research, University of Trás-os-Montes e Alto Douro, UTAD, Vila Real, Portugal

<sup>2</sup>Mouços Social and Parish Centre, Vila real, Portugal

<sup>3</sup>Dept. Mathematics, University of Trás-os-Montes e Alto Douro, UTAD, Vila Real, Portugal

### ABSTRACT

This paper aim to identify the main characteristics of the women entrepreneur's profile in healthcare setor. It's an exploratory study that emerged from the qualitative study supported by semi-structured interviews to women in a northern Portuguese town.

Using the interview technique, we collected data about women entrepreneurs in healthcare setor, which were analysed quantitatively (descriptive statistics) and qualitatively (content analysis) giving rise to an exploratory and descriptive study. As results we may summarize that women entrepreneurs in the healthcare sector in a Portugal town are successful; their motivations were a combination of factors (*e.g.* training in the area, personal recognition and economic needs); obstacles have been identified; the work-family balance is not a limiting factor for their business; institutional support did not affect the start-up of the business and these womens entrepreneurs do not feel discriminated. In the expressions of the entrepreneurs they showed self-confidence and self-realization, energy and perseverance.

The elaboration of this study will contribute to enriching knowledge about the profile of women entrepreneurs in the healthcare sector, their motivations and obstacles.

*Keywords: women entrepreneurs; profile; motivations; work-family balance; healthcare setor, Portugal.*

### INTRODUCTION

Entrepreneurship is a silent revolution in markets, distinguishing business creation and value added, dedicating time, and effort, assuming financial, psychological, and social risks that are inherent to it, but concomitantly welcome the gratifications of personal and economic satisfaction (Mari et al. 2016). However, for entrepreneurship developed and subsisted, there are a number of structuring factors, namely: financial support; policies and programs; education and training; transfer of R&D results; commercial and professional infrastructure; opening up of the internal market; access to physical infrastructure and social and cultural norms.

When analyzing the concept of entrepreneurship from a gender perspective, female entrepreneurship is characterized by the result of a different experience, which in turn shapes the entrepreneurial intention, and stereotypes are also perceived in the social relations of gender (McClelland, 1961; Brush & Gatewood, 2008). The focus of the Global Entrepreneurship Monitor Portugal 2013 (Caetano 2014) in the individual participation allows the socio-economic analysis of among other characteristics on the entrepreneurs. With this information, it is possible to assess the level of inclusion in the labor market, since several groups (*e.g.*, those classified by age, gender or education) engage in business activity (Kelley et al. 2015).

Studies on women entrepreneurship are emergent given the nature of the increasing evolution of the role of women in contemporary society, as well as the appearance of new issues within this group (*e.g.*, Carter & Shaw 2006, Brush et al. 2014, De Vita et al 2014, Marlow 2014, Henry et al. 2015).

In the research on the theoretical referential in relation to the healthcare sector together with women's entrepreneurship in the healthcare area, we have a bibliographical gap regarding the specificity of the theme. However, many studies have been done on entrepreneurship in the healthcare sector (*e.g.* Marques et al. 2013, Lages et al. 2016), but none of them takes into account the gender variable women, in our study. Thus, we may say that the investigation of entrepreneurship based on the healthcare sector is growing, but for now neither focuses women.

Considering the importance to foster women entrepreneurship and the healthcare sector, our study is an exploratory one in qualitative perspective, with the main of identify the key characteristics of the women entrepreneur's profile in healthcare setor.

The elaboration of this study will contribute to enriching knowledge about the profile of women entrepreneurs in the healthcare sector, motivations and obstacles, as the studies on the subject of entrepreneurship in the healthcare sector, focusing on the female gender are rare.

After this introduction, a brief theoretical discussion about some attributes and motivations of women entrepreneurs. Section three describes the methodology used. In the fourth section, the results are presented, followed by the final sections' discussion of findings and this study's limitations and implications.

## **BACKGROUND**

### *Sex and Gender in an Entrepreneurship Perspective*

Entrepreneurship is considered as one of the primordial mechanisms, promoters of economic development, innovation, and well-being. Considered as a dynamic process of change, vision and design, it is based on the identification of opportunities and creation of new solutions by the entrepreneur, with the objective of meeting the needs of individuals (IFDEP, 2014).

In the literature, concepts such as gender and entrepreneurship have expanded over the last few years, but these still remain limited theoretically and methodologically (Calas et al. 2009). As a way of understanding the roots of entrepreneurship, history presents us with four important milestones for the emancipation of women in the labor market. Until the Industrial Revolution in the XIX century, the women were incapable to work outside the household (Hamilton, 2013). Through this revolution, and with the increasing demand for labor, female inclusion has intensified. However, the wage disparities, and the poor working conditions, in this period began to give rise to demands for labor rights. The ideological shift associated with domestic activity has become a dominant gender discourse, linked in large part to industrialization, the separation of production and consumption, household and labor activity, played an important role in the definition of gender roles. In the emerging middle class in Europe (Gatrell 2008). Another important momentous in history was the first and second World Wars, because with less men because of their deaths in combat, it became essential to hire women in the labor market, as a way to fill the activities that were performed until then by men (United Nations 2010). In Portugal, the various political, social, and economic transformations that took place since the 1970s provoked deep changes at various levels, in health in education, in social structure, and in citizenship. Parallel to these changes, the position of women in the labor market, as well as the legal procedure, and the recognition of equal rights between men and women; have undergone fundamental changes, namely of the political regime through the implementation of democracy in Portugal (IFDEP, 2014).

Silveira (2012) presents different associations around the gender issue: associated with the male rationality, calculism and logical thinking; And to female the emotions, intuition and affections, the same emphasizes the existence of a significant asymmetry between the two genders based on the difference of the sex and the culture in which they are inserted. This author refers that gender relations are the result of continuous learning, of social interaction, and not solely of the biological factor. So gender is a social construction and sex is something biological, which is pre-determined at birth.

### *Women's Entrepreneurship*

When we talk about the first studies on women's entrepreneurship we refer to the 70's of the 20th century and was one of the first works by Schwartz (1976). Schwartz (1976) sought to address aspects related to the characteristics of the personality of the entrepreneurial woman, their motivations, and also the difficulties they face. Through her research she concluded that the reasons why lead men and women to open their own business are similar, as well as their qualities as entrepreneurs (Gomes et al. 2014). However, it was notorious that women faced more barriers to the business, impeding the success of their organizations (Gomes et al. 2014).

According to Jennings and Brush (2013) the subdomain of women's entrepreneurship has passed many of the key development milestones associated with the maturation of a field of research. Brush et al.

(2009) refer that business activity is increasing among women, proving to be the most entrepreneurial population in emergency worldwide. However, in spite of this considerable increase on the part of women entrepreneurs, men have still been at the forefront of the entrepreneurial field in recent years, with disparities persisted across all countries (Shinnar et al. 2012).

According to GEM Portugal 2013 (Caetano 2014), the Entrepreneurial Activity Rate Early-Stage Total (TEA) in Portugal in 2013, the number of early-stage male entrepreneurs was 10.8% of the male population in adulthood, while the number of female early-stage was 5.8% of the adult population. There was an intensification of the imbalance of the involvement of men and women included in entrepreneurial activities. Thus, in 2012, “the number of early-stage male entrepreneurs corresponded to 9.3% of the adult male population and the number of early-stage female entrepreneurs to 6.2% of the adult female population, The increase in the overall TEA rate in Portugal is mainly due to the increase in the number of entrepreneurial men” (Caetano, 2014, p. 29)

### *Entrepreneurship profile*

There are psychological approaches to entrepreneurship, which seek to identify unique behaviors and traits in the personality of the entrepreneurial individual, allowing him to achieve success. Among them, we highlight the ones that are presented in Table 1.

**Table 1:** Predictive skills of the entrepreneur profile

skills	Some authors
Search and opportunity recognition	Ability to identify, exploit and capture the value of business opportunities (Birley & Muzyka, 2001, p. 22).
Goal Orientation	Entrepreneurs do not just define situations, but also imagine visions of what they want to achieve. Their main task seems to be to imagine and define what they want to do and, almost always, how they will do it (Filion, 2000, p. 3).
Creative and innovative problem solving	Longenecker and Moore (1998) refer to the entrepreneur's ability to create a new way of using resources, taking risks and responsibilities, continually innovating.
Self confidence	Potreck-Rose and Jacob (2006) refer to self-confidence as a positive attitude toward one's own abilities and performance. It includes the convictions of knowing and being able to do something, to do well, to achieve something, to endure difficulties and to be able to do without certain things.
Assertiveness	Ames & Flinn (2007) Indicate that good levels of assertiveness must be sought in order to achieve goals in relation to tasks, while preserving and improving relationships between people.
Initiative	Entrepreneurs (...) provide jobs, introduce innovations and stimulate economic growth. We no longer see them as suppliers of goods and autoparts of no interest. Instead, they are seen as energizers who take the necessary risks in a growing, productive economy (Longenecker et al. 1997, p. 3).
Assumption of calculated risks	The business passport (...) will be the entrepreneurial capacity, that is, the capacity to innovate, to take risks intelligently, to act quickly and efficiently to adapt to the continuous changes of the economic environment (Kaufman, 1991, p. 3).
Use of influence strategies	Once entrepreneurs recognize the importance of their face-to-face contact with others, they quickly and vigorously seek to do so (Markman & Baron, 2003, p. 114).



Entrepreneurial Spirit	Developing the entrepreneurial profile is to enable the student to create, lead and implement the process of developing new life plans. (...) Entrepreneurial training is based on the development of self-knowledge, with emphasis on perseverance, imagination and creativity, associated with innovation (Souza et al. 2004, p. 4).
------------------------	--

Source: IFDEP (2014, p. 15-17).

### *Motivations*

McClelland (1972) advocates that values, human motivations and the need for self-actualization move individuals in search of entrepreneurial activities. It is also evident that the need for achievement and achievement is one of the main reasons that motivate the individual to have a proactive and dynamic attitude. Marques et al. (2011) adds that entrepreneurship in general is persuaded by the following motivating factors: self-actualization; independence; unemployment or need for security; education and previous experience; social status. Now speaking specifically about the motivations that lead the women's entrepreneurship group to open the business itself, we have authors who defend the:

- Spirit of survival; Dissatisfaction with male leadership; Designing a niche market; Own will at the time of deciding; and finally, the main incentive is the combination of factors such as challenge, pleasure and contentment to face obstacles (Anderson & Woodcock 1996)
- Independence; desire for personal fulfillment; need for survival or a way to reconcile work with family; stagnation of professional career and perception of opportunities in the market (Machado, 2003).
- Difficulties in advancing their professional career, the organizational policies in force in the business context, and the difficulty in the duality of roles, that is, the reconciliation between work and family (IFDEP, 2014).

## **METHODOLOGY**

To answer the research question "What is the profile of women entrepreneurs in healthcare setor?", a qualitative investigation was carried out, with specific quantitative analyzes in an exploratory and descriptive study. Thus, in the data collection we applied a focused and structured interview, with 24 questions, divided by two segments: socioeconomic characterization and the profile of the entrepreneurial woman in the healthcare setor. The questions of the interview were adapted based on Marques et al. (2017) study.

At the time of the interviews, there was always a concern to safeguard the identity of the interviewees. The sampling was intentional, since we applied the interview to the entrepreneurs who made it available, having as only concern that the women were the owners of their own business related to the health area. This is because there is no Portuguese database to identify companies that are

owned by women, nor by sector of activity. The questions were also based on the “GEM Portugal 2013” (Caetano 2014) and “GEM special report: Women’s entrepreneurship” (Kelley et al. 2015), and the interviews were applied to 16 entrepreneurial women, aged between 25 and 53 years, holding business related to the healthcare sector. The use of this method allowed an analysis of the characterization of the entrepreneurial woman in the healthcare sector.

In this work we intend to characterize the entrepreneurs of Vila Real, Portugal, having as reference our research question: What is the profile of women entrepreneurs in the healthcare area? To do this, we defined six propositions:

- P1:** Women entrepreneurs in the health sector want to be successful.
- P2:** The motivation of women entrepreneurs in healthcare sector is common.
- P3:** Barriers to business creation are the bureaucracy and funding
- P4:** work-family balance is not a conditioning factor for business.
- P5:** Institutional support does not affect the start-up of the business.
- P6:** Woman entrepreneurs in the healthcare sector feels discriminated against.

Despite the efforts made and the limitations to the intended characterization, we were only able to collect 16 interviews in the city of Vila Real, Portugal. Because the size of the sample is small and local – only for business in the city of Vila Real, Portugal – it was decided to establish this first characterization for the entrepreneurial woman in the healthcare sector of this city. Qualitative analysis was done using counts and percentages (tables and graphs) using the *IBM SPSS Statistics program 22*. The content of the women’s entrepreneur’s comments was standardised based on the literature using word clouds<sup>7</sup>. The descriptive statistics and graphs built based on the program, and we still used clouds of words.

## RESULTS: ANALYSIS AND DISCUSSION

### *Socio-economic characterization*

The women’s entrepreneurs age varies between 25 and 53 years, with the average age of 39,2. Most of these women are married (68.8%) and the others are single. Half of the women entrepreneurs in the health area of Vila Real lives with their children and 12.5% lives with their parents. The majority (62.5%) have a degree, 31.3% have a master’s or post-graduate degree and 6.3% (one of 16 women) had a PhD. These entrepreneurs in healthcare sector in Vila Real present an academic profile similar to the early-stage described in GEM (2013).

---

<sup>7</sup> A word cloud is a graphic representation that gives greater prominence to words that appear more frequently in given texts (e.g. responses to open-ended survey questions or interview transcriptions), displaying them differently by size, color and brightness. Thus, for example, the words in the largest font-size are those most commonly encountered in the texts.

Regarding the importance of education and training in the creation of the business, all 16 interviewees (100%) reported being a relevant factor. The words associated of the role of training in the management of entrepreneurial business (content analysis) were: training in management, knowledge, contribute, creation, fundamental, management, important and role.

Regarding the type of business of the 16 interviewees, the highest percentage of entrepreneurship in the healthcare setor are dental medical clinics (31.3%), and there are other diversified businesses (Figure 1). Concerning the functions that entrepreneurs carry out in their own business, 23.5% of these women are technicians and managers (Figure 2).

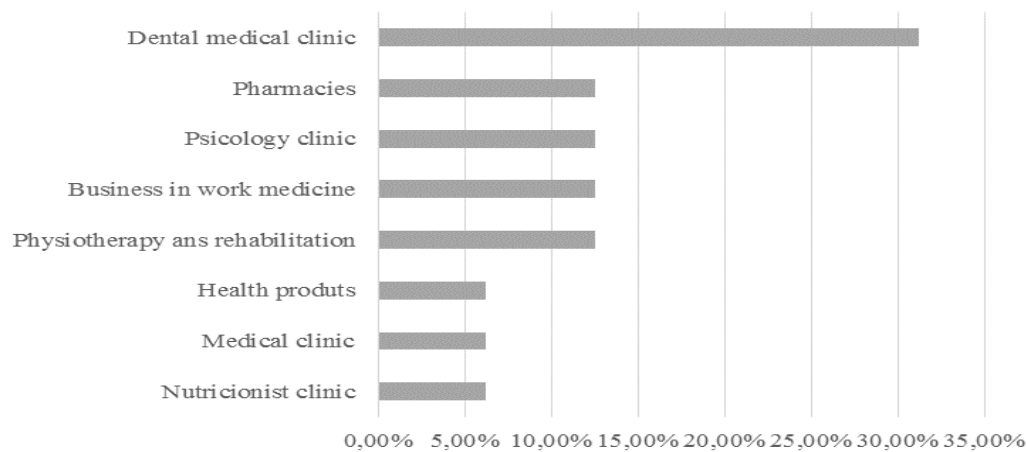

Figure 1. Business in the healthcare setor of the women entrepreneurs in Vila Real town

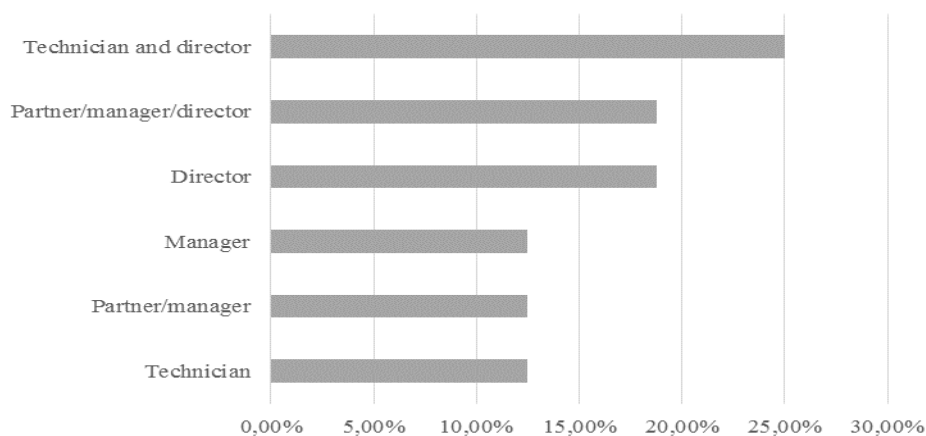

Figure 2. Functions in their own business of women's entrepreneurs

### *Motivations*

The graphic representation cloud of words was used and following Portuguese words stand out: area, mine, have, work, clinic, dental, create, formation, taste, medicine, motivated, academic. The cross-analysis of these motivations with the function groups in your business, as it highlighted the technical "my training area". In this cross-sectional analysis, we highlight that 57.1% of the women (4

out of 7) who reported a combination of factors had told us to perform technical functions and managers and/or managing partners (Figure 3).

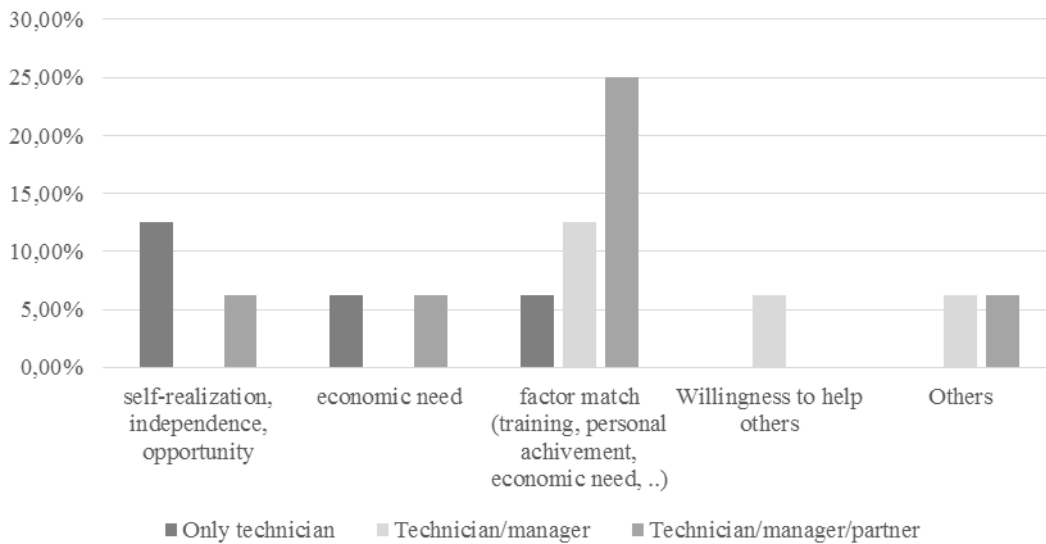

Figure 3. Motivations of the women entrepreneurs to create their business in the area of healthcare and functions in this business

The clouds of the words related to the personal characteristics that these women entrepreneurs in the healthcare area of Vila Real, refer as being those that help in their entrepreneurial activity - perseverance, organization (in green on the left) -, those that help and prejudice - sympathy, emotivity (in the gray, center) - and which ones hurt your business (in red on the right, Figura 4).



Figure 4. Characteristics of women entrepreneurs in their healthcare business

Among the personal characteristics that help, those women in their own business stand out in the foreground of the cloud of Portuguese word are organization and perseverance; and in the background: attention, responsibility, and sympathy. Finally in the third plane: ambition, actualization, boldness, and confidence. The personal characteristics that help and hinder them in your business the only referred were sympathy, emotion, and youth. The personal characteristics that harm the

entrepreneurs of this area in your business, in the cloud of Portuguese words the emphasis is for not being and being, followed by perfectionism and kindness.

### Obstacles

The main obstacles to the creation of their business to these women entrepreneurs in the healthcare area: four women (25%) reported bureaucracy, three mentioned space (18.8%) and two (12.5%) indicated the weight of taxes. The result of all responses is displayed in the word cloud (Figure 5).



Figure 5. Word Cloud for obstacles to the creation of women entrepreneurs' business

### Roles of women

About people who supported and motivated these women entrepreneurs in the area of health in Vila Real, they mentioned in the first place parents, family and husband. Then friends, brothers, and fathers. Finally, other relatives as children, sister, brother, boyfriend and cousins. Concerning the priority of family *versus* work, these women entrepreneurs prove to be “the two”, adding that one without the other would be inconceivable to those women.

Crossing these results with those of the marital status of those women entrepreneurs, it is clear that within them, the priority is family and work and in the married ones family and work or family alone, overall of 72.8% (figure 6). Thus, in spite of a small sample of the municipality of Vila Real, the balance of the family *versus* work seems to be evident, as mentioned in Brush et al. (2014) and Berger and Kuckertz (2016).

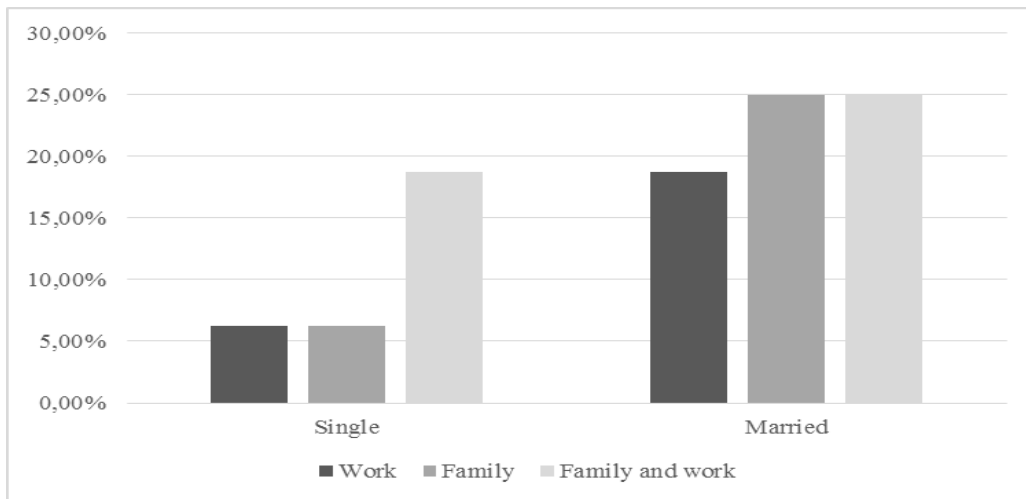

Figure 6. Marital status of women entrepreneurs and their priority

*Discrimination and self-perception*

Of the 16 womens entrepreneurs only one (6.3%) reported that she experienced discrimination as an entrepreneurial woman; which is a satisfactory result compared to the “GEM Portugal 2013” (Caetano 2014), “GEM special report: Women’s entrepreneurship” (Kelley et al. 2015) and the IFDEP (2014) reports.

Finally, inquiring about how she thinks society sees her, in the following cloud of words, the following words stand out: entrepreneur, professional, courageous, woman, among others.



Figure 7. Word cloud of these women entrepreneurs of how society sees them

In summary five of the propositions were confirmed (P1, P2, P3, P4 and P5) and only one was rejected – P6.

## FINAL REMARKS

In spite of the limitation of a small sample, from the 16 interviewees we may have a first approach to the profile of the women health entrepreneurs in Vila Real have the same age range as the early-stage entrepreneurs (Caetano 2014, Kelley et al. 2015) most are married, and the household is slightly higher than Portuguese one.

The motivation of those entrepreneurs was in agreement with their area of training and resulted from a match of factors (Anderson & Woodcock 1996): personal achievement, independence and opportunity arose (Vale et al. 2014). As for the personal characteristics, those that help, help and hinder, and harm their own business are distinguished, being in line with those mentioned for the entrepreneurs in general (Schmidt & Bohnenberger 2008). Finally, the motivation of women entrepreneurs in healthcare in this town can be considered common. The obstacles to the creation of the business referred by these women entrepreneurs are mainly related to complaints of institutional context: bureaucracy, bureaucracies, financial, taxes and licenses (Baughn et al. 2006). To conclude, the obstacles were identified with a slightly different connotation from that exposed in the literature.

It was evidenced the reconciliation of work with the family (Greene et al. 2007, Welter et al. 2014). However, the women roles – family *versus* work – is not a conditioning factor for their business.

In the expressions of the entrepreneurs they showed self-confidence and self-realization (Vale et al. 2014, Anderson & Woodcock 2009), energy and perseverance (IFDEP 2014, Schmidt & Bohnenberger 2008). In addition, we have also seen that these entrepreneurs do not experience discrimination, contrary to what many authors refer to as Gupta et al. (2013).

The results suggested by the results that may be useful to women entrepreneurs and political decision-makers showing that this is a very feminine sector, without discrimination, and incentive policies should be developed to create start-ups in this sector, starting with the development of entrepreneurial skills and opportunity recognition in education and training related to healthcare.

While encouraging, the results of our preliminary study need to be viewed with caution. Their generalisability is limited given the strong dependence on the narrowly defined context of analysis and decision groups involved (i.e. only 16 women entrepreneurs), as well as the subjective component of the interview methodology adopted.

Regarding future research, we recommend 1) quantitative studies; 2) studies with different stakeholders in this sector to confirm the robustness of the results; 3) studies across the same sector in different countries to increase the generalisability of the results; 4) comparisons of different methodological approaches and 5) the development of a number of case studies that could complete the framework of research. In this way, methodological improvements and the availability of larger samples will help to strengthen the preliminary conclusions drawn here

## ACKNOWLEDGEMENTS

This work is supported by: European Structural and Investment Funds in the FEDER component, through the Operational Competitiveness and Internationalization Programme (COMPETE 2020) [Project No. 006971 (UID/SOC/04011); Funding Reference: POCI-01-0145-FEDER-006971]; and national funds, through the FCT – Portuguese Foundation for Science and Technology under the project UID/SOC/04011/2013.

## REFERENCES

- Anderson A.H. & Woodcock P. (1996). *Effective entrepreneurship: A skills and activity-based approach*. Blackwell Business.
- Baughn C.C., Chua B.L. & Neupert K.E. (2006). The normative context for women's participation in entrepreneurship: a multicountry study. *Entrepreneurship Theory and Practice*, 30(5), 687-708.
- Berger E.S.C. & Kuckertz A. (eds) (2016). *Complexity in Entrepreneurship, Innovation and Technology Research: Applications of Emergent and Neglected Methods*. Springer.
- Brush C. & Gatewood E. (2008). Women growing businesses: Clearing the hurdles. *Business Horizons*, 51, 175–179.
- Brush C.G., De Bruin A. & Welter F. (2009). A gender-aware framework for women's entrepreneurship. *International Journal of Gender and Entrepreneurship*, 1(1), 8-24.
- Brush C.G., de Bruin A. & Welter F. (2014). Advancing theory development in venture creation: Signposts for understanding gender. In K.V. Lewis C., Henry E.J., Gatewood & Watson J. (Eds.), *Women's entrepreneurship in the 21st century: An international multi-level research analysis* (pp. 11–26). Cheltenham, UK: Edward Elgar Publishing.
- Caetano A. (2014). *GEM PORTUGAL 2013| 2004-2013: uma década de empreendedorismo em Portugal*.
- Calas M.B., Smircich L. & Bourne K.A. (2009). Extending the boundaries: Reframing “entrepreneurship as social change” through feminist perspectives. *Academy of Management Review*, 34(3), 552-569.
- Carter S.L. & Shaw, E. (2006). *Women's business ownership: Recent research and policy developments*.
- De Vita L., Mari M. & Poggese S. (2014). Women entrepreneurs in and from developing countries: Evidences from the literature. *European Management Journal*, 32(3), 451-460.
- Dessy L.T. (2016). *Empreendedorismo Feminino: Estudo das Mulheres Empreendedoras Erveiras do Mercado do Ver-o-Peso (Pará/Brasil)*. Dissertação de mestrado não publicada, Universidade de Trás-os-Montes e Alto Douro, Vila Real.
- Gatrell, C. (2008). *Embodying women's work*. UK: McGraw-Hill Education.
- Gomes A., Araújo U., Martins C.M. & Santana W.G. (2014). Female Entrepreneurship as Subject of Research. *Review of Business Management*, 16(51), 319-342.
- Greene P.G., Brush C.G. & Gatewood, E. (2007). Perspectives on women entrepreneurs: Past findings and new directions. M. Minniti (ed.), *Entrepreneurship: The Engine of Growth, Perspective Series*. London: Praeger Publisher – Greenwood Publishing Group.
- Gupta V.K., Goktan, A.B. & Gunay G. (2013). Gender differences in evaluation of new business opportunity: A stereotype threat perspective. *Journal of Business Venturing*, 29(2), 273-288.
- Hamilton, E. (2013). The discourse of entrepreneurial masculinities (and femininities). *Entrepreneurship & Regional Development*, 25(1-2), 90-99.
- Henry C., Foss L. & Ahl H. (2015). Gender and entrepreneurship research: A review of methodological approaches. *International Small Business Journal*, 34(3).
- IFDEP (2014). *Empreendedorismo Feminino um olhar sobre Portugal, 2014*. Departamento de Research.
- Jennings, J.E. and Brush, C.G., 2013. Research on women entrepreneurs: challenges to (and from) the broader entrepreneurship literature?. *Academy of Management Annals*, 7(1), 663-715.
- Kelley D., Brush C., Greene P., Herrington M., Ali A. & Kew P. (2015). *GEM special report: Women's entrepreneurship*.
- Lages M., Marques C.S., Ferreira J. & Ferreira F. (2016) *Intrapreneurship and Firm Entrepreneurial Orientation: insights from the health care service industry*. *International Entrepreneurship and Management Journal*. DOI: 10.1007/s11365-016-0428-1.



- Machado H.V., St-Cyr L., Mione A. & Alves M.C.M. (2003). O processo de criação de empresas por mulheres. *RAE eletrônica*, 2(2), (on-line) Available at <http://www.scielo.br/pdf/raeel/v2n2/v2n2a07>.
- Mari M., Poggesi, S. & De Vita, L. (2016). Family embeddedness and business performance: Evidences from women-owned firms. *Management Decision*, 54(2), 476–500.
- Marlow S. (2014). Exploring future research agendas in the field of gender and entrepreneurship. *International Journal of Gender and Entrepreneurship*, 6(2), 102-120.
- Marques C., Santos G., Gerry C. & Gomes G. (2011). Business motivation and work-family balance among urban and rural women entrepreneurs in Portugal. In R. Fairchild (Ed.), *Entrepreneurship: Motivation, performance and risk reward*. Hauppauge, NY: Nova Science Publishers.
- Marques C.S., Ferreira J. J., Ferreira F.A., & Lages M.F. (2013) Entrepreneurial orientation and motivation to start up a business: evidence from the health service industry. *International Entrepreneurship and Management Journal*, 9(1), 77-94.
- Marques C.S., Leal C., Ferreira J. & Ratten V. (2017). The formal-informal dilemma for women micro-entrepreneurs: evidence from Brazil. *Journal of Enterprising Communities: People and Places in the Global Economy*, 11(3).
- McClelland, D. (1961). *The Achieving Society*. Princeton, New Jersey: Van Nostrand.
- Pinto, A. M. C. (2016). Uma análise do perfil empreendedor dos microempresários localizados no beco da poeira na cidade de Fortaleza, Ceará. Dissertação de mestrado não publicada, Universidade de Trás-os-Montes e Alto Douro, Vila Real.
- Schmidt S. & Bohnenberger, M.C. (2009). Entrepreneurial profile and organizational performance. *Rev. adm. contemp.*, 13(3). <http://dx.doi.org/10.1590/S1415-65552009000300007>.
- Schwartz, E.B. (1976). Entrepreneurship: A new female frontier, *Journal of Contemporary Business*, Winter, 47-76.
- Shinnar R.S., Giacomini O. & Janssen F. (2012). Entrepreneurial perceptions and intentions: The role of gender and culture. *Entrepreneurship Theory and Practice*, 36(3), 465-493.
- Silveira R. (2012). Diversidade de Género-Mulheres. Available at [http://www.dhnet.org.br/dados/cursos/edh/redh/03/03\\_rosa1\\_diversidade\\_genero.pdf](http://www.dhnet.org.br/dados/cursos/edh/redh/03/03_rosa1_diversidade_genero.pdf)
- United Nations (2010). *Achieving Gender Equality, Women's Empowerment and Strengthening Development Cooperation*. Dialogues at the Economic and Social Council. New York.
- Vale G.M.V., Corrêa V.S. & dos Reis R.F. (2014). Motivations for Entrepreneurship: Necessity Versus Opportunity?. *Revista de Administração Contemporânea*, 18(3), 311.
- Welter F., Brush C. & De Bruin A. (2014). The gendering of entrepreneurship context. Institut für Mittelstandsforschung Bonn (Hrsg.): Working Paper 1/14. Available at SSRN: <https://ssrn.com/abstract=2557272>

# INFLUENCE OF UPDATING ENVIRONMENTAL KNOWLEDGE THROUGH LEARNING PROCESSES TO IMPROVE PERFORMANCE IN A TOURIST MARKET

Martínez-Martínez, Aurora<sup>1</sup>; Cegarra-Navarro, Juan Gabriel<sup>2</sup>; García-Pérez, Alexeis<sup>3</sup>

<sup>1</sup>Facultad de Ciencias Jurídicas, Sociales y Humanidades, Universidad Internacional de la Rioja, Logroño, Spain

<sup>2</sup>Facultad de Ciencias de la Empresa, Universidad Politécnica de Cartagena, Cartagena, Spain

<sup>3</sup>Centre for Business in Society, Coventry University, Coventry, United Kingdom

## ABSTRACT

This paper examines the relationship between environmental knowledge, organisational learning and business performance through an empirical study of 87 companies in the Spanish hospitality sector. This study includes “time” as variable in the analysis and by focusing on the need to update environmental knowledge six years after the learning process took place. The results of the study indicate that environmental knowledge has a positive impact on business performance. Therefore, our findings show that in order to achieve a sustained effect on performance, it is necessary for the organisation to keep its environmental knowledge stocks up to date. That is, there is a need to review the organisation’s environmental awareness at a regular intervals (in our particular research, six years after the initial analysis). This can be achieved by defining environmental knowledge as one of the priorities of the organisational learning processes. The paper discusses both conceptual and practical implications for the development of successful hotel operations and management.

*Keywords: environmental knowledge, organisational learning, market, hospitality industry, business performance*

## 1. INTRODUCTION

The environment and its protection are a common global concern. An increasing number of organisations are embracing environmental and sustainability challenges into their strategies and activities (Dangelico and Pontrandolfo, 2015). The extant literature contains evidence that by integrating the environment-friendly tasks into organisation strategies a number of benefits can be achieved. These include improved performance not only on organisational but also on environment-relevant aspects. In particular, organisations can implement several actions to reduce their negative impact on the environment and -directly or indirectly, they can improve their business performance

(Hsu and Hu, 2008; Martínez-Martínez, Cegarra-Navarro and García-Pérez, 2015; Boiral, Raineri and Talbot, 2016; Font, Garay and Jones, 2016; Kabongo and Boiral, 2017).

Environment protection and the improvement of organisational performance are two of the key business priorities worldwide and the basis for attaining sustainable development (Cegarra-Navarro and Martínez-Martínez, 2010). In other words, sustainable development is one of the most widespread ideals of the self-dubbed "knowledge society" (Waldimir *et al.*, 2011). In this context, environmental knowledge and learning have taken on a central role on how the duality organisation–environment is managed (Sinclair, Diduck and Fitzpatrick, 2008).

The dynamics of tourism as an activity and as an industry, combined with the growing concerns about the environment call for a continuous effort in seeking new approaches, tools and perspectives for the acquisition of environmental knowledge by organisations in the hospitality sector (Song *et al.*, 2012). Uncertainty inherent to many resource and environmental decisions underscores the importance of environmental learning through the need to explore and exploit new environmental knowledge (Grant and Spender, 1996; Zahra and George, 2002). Further, the need for institutional innovation and generative change in response to the sustainability imperative emphasises the necessity of organisational learning in the hospitality industry (Kates *et al.*, 2001).

Concern for the environment is an important, sustaining characteristic in several sectors. In the case of the hospitality industry, this commitment is especially important since stakeholders demand special environmental protection and natural resources are clearly not unlimited. However, the hospitality industry has been marginally affected by environmental regulation, becoming a widely neglected research setting. The sector is thus able to shed some light on why some organisations, e.g. hotels, produce different responses to the environmental concerns of their customers compared to others (Darnall, Henriques and Sadorsky, 2010; Fraj, Matute and Melero, 2015; Boiral, Raineri and Talbot, 2016; Rahman and Reynolds, 2016). It may be postulated that the reason why hotels adopt environmental knowledge in the long term could be related to process and to environmental learning, which enable the exploration and exploitation of environmental knowledge (Kim and Rhee, 2009) and its subsequent updating over **time**. The purpose of this study therefore is to analyse the role played by organisational learning over time as key aspect for updating the environmental knowledge of an organisation, along with the impact these processes may have on business performance. This paper contributes to the relevant literature in several dimensions.

Firstly, it analyses the relationship between environmental knowledge and performance in the context of the hospitality industry unlike the majority of previous studies, which have examined industrial firms (Molina-Azorín *et al.*, 2009; Dangelico and Pontrandolfo, 2015). This established focus in the research literature probably arose because the activities of businesses potentially have a more negative

impact on the environment (Bowen, 2000; Darnall, Henriques and Sadorsky, 2010), whereas service firms have received much less attention (Mina, Bascavusoglu-Moreau and Hughes, 2014). Secondly, while most of the previous research uses measures of proactivity on environmental performance (e.g. the negative effects of emissions and waste), this paper measures environmental impact as a result of implementing environmental organisational learning. Thirdly, this paper incorporates a longitudinal perspective, focusing on the changes of environmental knowledge along a period of time -mediated by organisational learning processes, with the impact it has on business performance. The longitudinal study described in this paper involved two observations of the same variables over a period of six years (2008 and 2014).

The proposed theoretical framework is presented in the following section. The methodology section provides details of the empirical tool used to collect appropriate data to test the conceptual model presented in the theoretical framework. Finally, the theoretical contribution and managerial implications of this research are discussed in section 4.

## **2. THE PROPOSED RESEARCH MODEL**

### **2.1. Environmental knowledge and the Spanish hospitality industry**

In order to answer the questions proposed by this research, a model was developed using quantitative data from the Spanish hospitality sector, particularly the section of the industry that deals with hotel operation and management. As a service industry, the hospitality sector is particularly relevant as the focus of research on environmental knowledge and organisational learning for two main reasons. First, this sector has an increasing importance on the global economy. Secondly, tourism and the tourist industry show an increasingly growing environmental concern. In contrast, the service sector, which makes a great contribution to development, is being held responsible for many of the issues leading to the planet's environmental degradation.

The United States, China, Spain and France remain the world's top tourism destinations (WTO, 2016). These countries not only attract the highest numbers of tourists but also have a combined income of approximately US\$ 400 billion. Previous studies have shown that in the both developed and developing economies the service sector has been found to be contributing to more than 70% of the gross domestic product (GDP) (Mittal and Dhar, 2016).

Hotels carry out activities with a substantial dependence on the environment, an element that has modified the global competitive context. Therefore, hotel managers are required to reconsider their position in the conservation of natural resources. In addition, "green" tourism has led to increasingly demanding tourists who remain concerned about the products and services offered by hoteliers. In this context, the implementation of an environmentally-friendly strategy could become a key success factor

for the competitiveness of hotels (Stegorean, Petre and Chis, 2014). As a consequence, organisations within the hospitality sector face an increasingly complex and competitive environment, forcing them to continuously learn and adapt to the new business environment and embrace innovation as being critical to the survival and success (Cruz et al., 2016). Preservation of the environment therefore becomes a key factor to consider in developing and managing hotel operations (Martínez-Martínez, Cegarra-Navarro and García-Pérez, 2015).

Environmental knowledge is defined as a system to connect data, analysis and people which presents an opportunity to formalise industrial ecology in a business setting (Wernick, 2003). According to Fryxell and Lo (2015), environmental knowledge is defined as a general knowledge of facts, concepts, and relationships concerning the natural environment and its major ecosystems. Thus, environmental knowledge involves what societies know about the environment, key relationships leading to environmental aspects or impacts, and an appreciation of systems, and collective responsibilities necessary for sustainable development (Frick, Kaiser and Wilson, 2004; Po-Shin and Li-Hsing, 2009; Whyte, 2013). Based on this understanding, we focus on gaining an understanding of how the updating of environmental knowledge, mediated by learning processes, may contribute to the development of new environmental-informed responses or to adapting existing environmental approaches (Cegarra-Navarro and Martínez-Martínez, 2010).

## 2.2. Connecting environmental knowledge to organisational learning over time

Environmental knowledge has been invoked to characterize the way in which hospitality companies are able to create a path for the implementation of environmental practices that promote sustainable development (Martínez-Martínez, Cegarra-Navarro and García-Pérez, 2015). In this paper, the authors adopt this view and therefore take an approach that considers environmental knowledge as the knowledge that can help hotel managers develop better environmental solutions (Martínez-Martínez, Cegarra-Navarro and García-Pérez, 2015). Employees and management hold environmental knowledge at an individual and organisational levels. At every level they become stakeholders of such knowledge, take responsibility, experiment, make mistakes and acquire new environmental knowledge as they socialise and in the process of seeking continuous improvement in every aspect of the firm's transformation process (Spender, 1998). This use of environmental knowledge helps employees find solutions to problems and improve their performance (Klassen and McLaughlin, 1996; Céspedes-Lorente, Burgos-Jiménez and Álvarez-Gil, 2003; Easterby-Smith and Prieto, 2008; Boiral, Raineri and Talbot, 2016). In this context it is worth noting that other research has shown how tacit and individual environmental knowledge of stakeholders by sharing and use of tacit environmental knowledge also can imply the development of it (Boiral, 2002). Likewise, the implementation of environmental programs requires learning, collaboration and helping relationships between employees, which are

facilitated by environmental knowledge (Paillé and Raineri, 2015). These considerations led us to frame the first hypothesis of our study as follows:

*H1. Environmental knowledge (t) positively influences organisational learning (t)*

Organisational adaptation to a volatile environment has long been a major topic of research. It has been documented that an organisation's adaptation requires a balance between exploration and exploitation to attain long-time viability in the face of a changing environment (Kim and Rhee, 2009). We add to such an argument by proposing that for such adaptation to be successful the organisational learning processes should also be updated. What one may see as drivers of the exploitation and exploration processes of environmental knowledge over time within firms is their updated organisational learning strategies (Sinclair, Diduck and Fitzpatrick, 2008; Kim and Rhee, 2009; Liao, Chang and Wu, 2010; Kalmuk and Acar, 2015). As Martínez-Martínez, Cegarra-Navarro and García-Pérez (2015) noted, "time" provides hospitality companies with the temporal space they need to adjust and adapt to the new environmental challenges such as planning aims to enable recycling. For example, time implements a shared calendar for adjustment and revision of environmental practices and, delivers space for both synchronization and adjustment of knowledge structures. As a result, new environmental knowledge through learning orientation requires systematic update and represents a firm's internal cognitive map in answering the needs of customers and markets through the updating of environmental knowledge (Sheng and Chien, 2016). This led us to hypothesise that:

*H2. Organisational learning(t) positively influences environmental knowledge (t+6)*

Once the staff has updated knowledge concerning its environment (e.g. new regulations to improve integrity of tourism industry), this knowledge can be viewed as a source of better solutions that meet new market needs or requirements (Sinclair, Diduck and Fitzpatrick, 2008; Kim and Rhee, 2009; Liao, Chang and Wu, 2010; Kalmuk and Acar, 2015). In other words, since environmental knowledge such as that of legislative changes has a dynamic nature, it requires solutions to be updated for managers to create (exploration), retain, transfer and use (exploitation) an organisation's explicit and tacit environmental knowledge over time (Easterby-Smith and Prieto, 2008). In the same way organisations need to develop dynamic capabilities, understood as routinised knowledge directed to the development and adaptation of operating routines (Zollo and Winter, 2002; Kabongo and Boiral, 2017). This allows them to incorporate into their routines the measures dictated by changes in the environment (Boiral, Raineri and Talbot, 2016; Font, Garay and Jones, 2016). Hotels operate in a context of intensive innovation and need to review their learning processes, which are implemented to create and update environmental knowledge (Martínez-Martínez, Cegarra-Navarro and García-Pérez, 2015). For example, according to Psomas, Fotopoulos and Kafetzopoulos (2010) and Tarí et al., (2010) a way to increase and update environmental knowledge is implementing a quality standard's such as ISO 9001, which

suggests that hotels need to update their environmental knowledge through organisational learning over time (Fraj, Matute and Melero, 2015). Thus, longitudinal studies might potentially elucidate the long-term effects of organisational learning on environmental knowledge. We therefore propose the following hypothesis:

H3. Environmental learning (t+6) has positively effects on organisational learning (t+6)

One of the most important reasons for implementing “green organisational learning” strategies is the customer and their views, often touted as the central stakeholder in driving hotels to be environmentally friendly. Indeed, a growing consumer base exists who are attracted by the ecological appeal of lodging facilities (Han *et al.*, 2011; Han and Chan, 2013). In the case of these hotels environmental protection activities are embedded in business operations and may bring some benefits, such as the reduction of operating costs by exploiting ecological efficiencies, an increased demand by attracting ‘green’ consumers, gaining a competitive advantage, achieving marketing benefits and improved relationships with stakeholders, improving corporate reputation, obtaining additional social benefits, reducing long-term risks, innovation or a higher ability to influence or to operate ahead of the formalisation of new regulations (Álvarez Gil, Búrgos Jimenez and Céspedes Lorente, 2001; González-Benito and González-Benito, 2005; Callan and Thomas, 2009; Molina-Azorín *et al.*, 2009; Cegarra-Navarro and Martínez-Martínez, 2010; Mina, Bascavusoglu-Moreau and Hughes, 2014; Dangelico and Pontrandolfo, 2015)

The above considerations have allowed us to propose that hotel performance is likely to be associated with environmental knowledge. As noted above, through organisational learning it can be possible to increase environmental knowledge, help hotels improve their business performance and obtain also a sources of competitive advantage (Easterby-Smith and Prieto, 2008; Civre and Omerzel, 2015). Thus, the following hypothesis is proposed:

H4. The existence of an up-to-date organisational learning strategy (t+6) could help hotels achieve better levels of business performance.

Taking all of the above into consideration, this study proposes the structural model shown in Figure 1, which can be briefly described as follows: Hotels must exploit and explore new environmental knowledge to internalise such knowledge through updated learning processes and thereby improve their business performance.

Figure 1: Theoretical Model

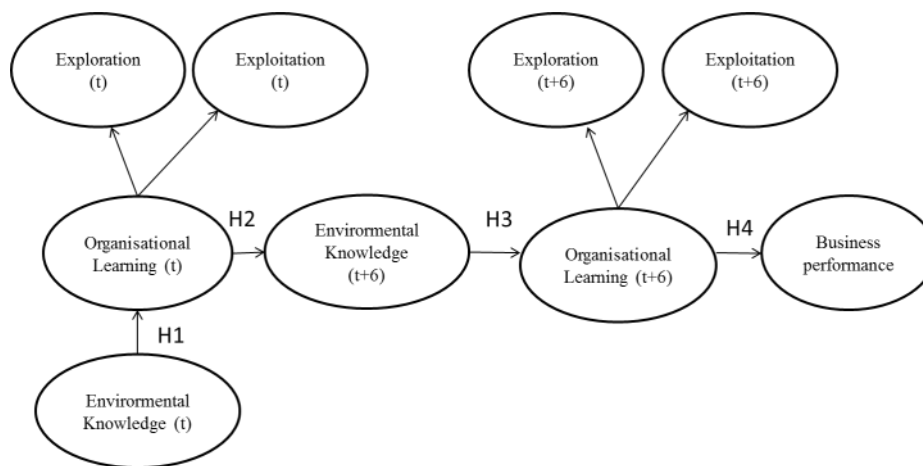

### 3. METHOD

#### 3.1 Data collection

The population samplings used in this study comprised hotel managers. Spain is the third most visited country in the world. Not only its geography as a western European country with a Mediterranean weather, but also the fact that Spain is seen as a safe destination with a strong economic recovery are factors that make Spain appealing both to visitors and investors alike. Tourism contributes 13% of the Spanish GDP and provides 11% of all jobs. By the end of 2016, 70 million tourists had visited the country in the year. According to the World Travel and Tourism Council (WTTC), in 2017, these numbers will increase in a 2.9%. The WTTC also forecasts an average 2.7% annual increase in visitors until 2020. It should also be noted that the Spanish tourism sector is very complex and requires intensive use of knowledge resources to competitively operate in the market and satisfy its customer needs (Martínez-Martínez, Cegarra-Navarro and García-Pérez, 2015).

A list of 560 Hotel Operators was provided by the SABI database (from the SABI Database based on the statistics for the year 2006), which was used as an initial sampling frame. All companies were included in the CNAE-552 (the Spanish National Classification of Economic Activities 552) and had ten or more employees. Before conducting the survey, the businesses were contacted by telephone and invited to participate in the study. Data sets were gathered in two phases, the first of which lasted two months, from early September to the end of October 2008. From a sample of 245 companies, 127 companies responded to the survey. The second stage in the data collection process within this research was conducted six years after the completion of the first phase. For approximately two months, between January and February 2014, the same companies that had completed the survey six years earlier were contacted. A survey was conducted and a total of 87 responses were collected, for a response rate of 15.53% of the total.



### 3.2 Measures

Churchill's (1979) approach to questionnaire development was used, combining scales from several other relevant empirical studies with new items to make an initial list of 16 items. Several items were modified through interviews with colleagues and a first draft of the questionnaire was tested with three hotels. The questionnaire constructs were operationalised and measured as follow:

With regard to the items making up knowledge exploration, the technique of Mom, Van Den Bosch and Volberda (2007) was followed in adopting a broader notion on knowledge exploration. This means that the exploration scale determines the extent to which the HHU supports activities that allow its employees to learn new skills or knowledge (Mom, Van Den Bosch and Volberda, 2007). The existence of conditions necessary to support knowledge exploitation (ET) were measured using an adapted version of a scale designed by Bontis, Crossan and Hulland (2002) to measure the construct 'feed-back learning flows'. They were focused on the utilisation of knowledge, which is embedded in the HHU to develop plans and the response implementation of such plans.

Environmental knowledge was computed using the scale of (Martínez-Martínez, Cegarra-Navarro and García-Pérez, 2015), who highlight the importance of supporting policies, rules, reporting structures and decision-making protocols that encourage the introduction of clean technologies and approaches to reduce pollution that often leads to substantial savings of materials and energy.

As the use of objective measures may pose some challenges to researchers while making causal inference from the historical data (March and Sutton, 1997), this study adopts subjective measures to achieve a more comprehensive evaluation of performance of the firm. In this regard, several measures of business performance have appeared in literature and we adopt the growth-based measures proposed by Kaplan and Norton (1992) and Klassen and McLaughlin, (1996) for sales, profits and profitability on total assets.

### 3.3 Data analysis and results

The data collected was analysed using the PLS-Graph software version 03.00 Build 1058. PLS was selected due to the characteristics of the model and population sample, which met Chin's (2003) criteria. The proposed model is complex and uses reflective indicators, and the data collected is non-normal. Using PLS involves a two-stage approach (Barclay, Higgins and Thompson, 1995). The first step required an assessment of the measurement model. This allows for the relationships between the observable or manifest variables and the theoretical concepts or latent variables to be specified. This analysis is performed in relation to individual item reliability, construct reliability, average variance extracted (AVE), and discriminant validity of the indicators of latent variables. In the second stage, the structural model is evaluated. The aim of this is testing the extent to which the causal relationships specified by the proposed model are consistent with the data available. For hypothesis testing, the

bootstrapping procedure recommended by Chin (1998) was used. In order to analyse the relationship between the different constructs and their indicators, a latent model perspective was adopted in which the latent variable is understood to be the cause of the indicators.

First-order constructs or dimensions are therefore referred to as reflective indicators. knowledge exploration (KEr), knowledge exploitation (KEt), environmental knowledge, and business performance (BP) were operationalised as first-order reflective constructs.

The results in Table 1 show that all of the constructs considered are reliable. The values for composite reliability are greater than the stricter value of 0.8 for basic research (Nunnally, 1978). The AVE should be greater than 0.5, meaning that at least 50% variance of the indicators should be accounted for (Fornell and Larcker, 1981). All the constructs in this model exceeded this condition. To assess the discriminant validity, the square root of the AVE (the diagonal in Table 1) was compared with the correlations between the constructs (the off-diagonal elements). On average, each construct relates more strongly to its own measures than to others.

**Table 1: Construct correlation matrix**

	Mean	SD	CR	AVE	1	2	3	4	5	6	7	8	9
1. Environmental knowledge (t)	6.91	1.72	0.79	0.50	0.71								
2. Knowledge Exploration (t)	7.01	1.67	0.77	0.62	0.65	0.79							
3. Knowledge Exploitation (t)	6.56	1.81	0.74	0.57	0.55	0.61	0.7						
4. Organisational Learning (t)	6.78	1.57	n.a.	n.a.	0.67	0.78	0.71	n.a.					
5. Environmental knowledge (t+n)	6.86	1.74	0.64	0.50	0.70	0.61	0.5	0.62	0.7				
6. Knowledge Exploration (t+n)	6.84	1.72	0.79	0.60	0.60	0.75	0.6	0.85	0.6	0.77			
7. Knowledge Exploitation (t+n)	6.49	1.92	0.74	0.52	0.51	0.57	0.7	0.71	0.5	0.68	0.7		
8. Organisational Learning (t+n)	6.67	1.67	n.a.	n.a.	0.63	0.77	0.7	0.93	0.6	0.71	0.7	n.a.	
9. Business Performance (t+n)	5.82	1.87	0.89	0.51	0.53	0.37	0.3	0.41	0.6	0.37	0.3	0.42	0.71

Notes:

Mean = the average score for all of the items included in this measure; S.D. = Standard Deviation; CR = Composite Reliability; AVE = Average Variance Extracted. The bold numbers on the diagonal are the square root of the Average Variance Extracted. Off-diagonal elements are correlations among construct.

As noted above, a second-order confirmatory factor analysis was conducted of a model depicting the constructs of knowledge exploration and knowledge exploitation. From an examination of the results

shown in Table 2 and Table 3, all first-order and second-order factor loadings were significant. In addition to this, all the knowledge creation constructs involving two dimensions [i.e. organisational learning (t) and organisational learning (t+n)] explain a high amount of variance in their respective knowledge processes (i.e. knowledge exploration and knowledge exploitation), thereby providing evidence that organisational learning (t) and organisational learning (t+n) are multifaceted constructs, construed from two dimensions (i.e. knowledge exploration and knowledge exploitation).

**Table 2. Second-order confirmatory factor analysis of Organisational Learning (t)**

First-order construct	Indicator	First-order Loading	Second-order Loading
Knowledge Exploration R2=0.85	KEr_1	0.87 a	
	KEr_2	0.87 a	0.92 a
	KEr_3	0.80 a	
	KEr_4	0.82 a	
Knowledge Exploitation R2=0.80	KEt_1	0.82 a	
	KEt_2	0.85 a	0.89 a
	KEt_3	0.70 a	
	KEt_4	0.88 a	

Note: <sup>a</sup> <0.01 [(based on t(4999), two-tailed test); t(0.01, 4999) = 2.577]; Year 2008

**Table 3. Second-order confirmatory factor analysis of Organisational Learning (t+n)**

First-order construct	Indicator	First-order Loading	Second-order Loading
Knowledge Exploration R2=0.68	KEr_1	0.78 a	
	KEr_2	0.56 a	0.82 a
	KEr_3	0.56 a	
	KEr_4	0.77 a	
Knowledge Exploitation R2=0.90	KEt_1	0.90 a	
	KEt_2	0.87 a	0.93 a
	KEt_3	0.17 a	
	KEt_4	0.90 a	

Note: <sup>a</sup> <0.01 [(based on t(4999), two-tailed test); t(0.01, 4999) = 2.577]; Year 2014

### 3. Results

This study uses PLS-Graph software version 3.00 to conduct an analysis of the data collected. The structural model resulting from the PLS analysis is summarised in Figure 2, where the variance of endogenous variables (R2) and the standardised path coefficients are shown. Figure 2 shows that all relationships are significant in all the scenarios analysed. Hence, the findings provided full support for H1, H2, H3 and H4.

Figure 2. Structural equation model

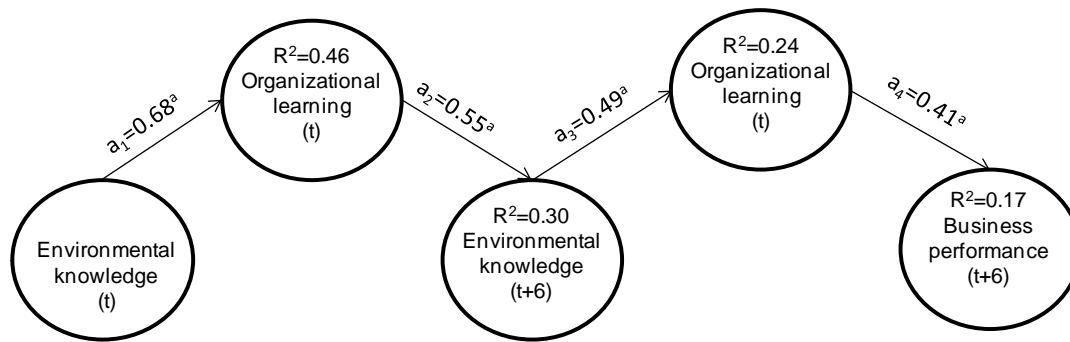

Notes:

Notes: <sup>a</sup> <0.01 [(based on t(4999), two-tailed test); t(0.01, 4999) = 2.577]

#### 4. THEORETICAL CONTRIBUTION AND MANAGERIAL IMPLICATIONS.

By examining the relationship between environmental knowledge, organisational learning and business performance, this research has made a number of significant contributions to the body of knowledge in areas such as knowledge management and sustainable hospitality management practices.

Our key theoretical contributions fall into three main areas. First of all, the research has shown that there is a direct relationship between environmental knowledge and business performance, mediated by organisational learning. Whilst this relationship had been studied in other, mainly industry settings, the research fills a gap in this domain for the context of service-related organisations. In particular, its focus on the hospitality sector makes this research relevant for a significant number of hotels and their supply chain around the world.

Secondly, the research has addressed the challenges of sustainability and environmental performance from a new perspective. Instead of focusing on the problem (e.g. current environmental issues such as pollution, climate change, environment degradation, etc.) to propose a solution, we have sought to understand how addressing the roots of the problem may lead not only to its reduction but also to direct benefits for the organisation.

Finally, the paper has incorporated a longitudinal perspective, focusing on the relationship between the three key concepts being studied (i.e. environmental knowledge, organisational learning processes, business performance) over a period of time. This provides an improved perspective when compared to most previous studies.

The research also has a number of implications for management. From the fact that environmental knowledge has a positive impact on business performance, decision makers within the hospitality sector and in particular hotels' management will better understand the importance of demonstrating the industry's concern for the environment and putting in place mechanisms to raise awareness of

relevant environmental issues in their specific organisations. The implementation of environmentally responsible activities and of new and revised policies influencing both operational and management strategies could lead to the long-term sustainability of their businesses.

Additionally, this research shows that environmentally responsible activities, policies and strategies must be sustainable for such improvements in performance to remain. That is, that the organisation needs to put in place mechanisms for a continuous acquisition and use of environmental knowledge in order to achieve a sustained effect on performance and the environment.

The main limitation of this study relates to its focus on the Spanish hospitality industry and specifically in hotels. In order to corroborate the validity of our findings in other service-related industries and thus improve the empirical understanding of this topic, similar analyses would need to include other organisations within the hospitality industry, other sectors which have an impact on the environment, and even organisations and sectors in different geographic and socio-economic contexts.

## REFERENCES

- Álvarez Gil, M. J., Búrgos Jimenez, J. and Céspedes Lorente, J. J. (2001) 'An analysis of environmental management, organizational context and performance of Spanish hotels', *Omega-International Journal of Management Science*, 29(6), pp. 457–471. doi: [http://dx.doi.org/10.1016/S0305-0483\(01\)00033-0](http://dx.doi.org/10.1016/S0305-0483(01)00033-0).
- Barclay, D., Higgins, C. and Thompson, R. (1995) 'The partial least squares (PLS) approach to causal modeling: Personal computer adoption and use as an illustration', *Technology studies*, 2(2), pp. 285–309.
- Boiral, O. (2002) 'Tacit Knowledge and Environmental management', *Long range plann*, 35(3), pp. 291–317.
- Boiral, O., Raineri, N. and Talbot, D. (2016) 'Managers ' Citizenship Behaviors for the Environment: A Developmental Perspective . *Journal of Business Ethics* , 1-15 . Theoretical Background and Hypotheses Corporate Greening Through Managers ' OCB', pp. 1–15.
- Bontis, N., Crossan, M. M. and Hulland, J. (2002) 'Managing an Organizational Learning System By Aligning Stocks and Flows of Knowledge', *Journal of management studies*, 39(4), pp. 437–469. doi: 10.5465/APBPP.1999.27594761.
- Bowen, F. E. (2000) 'Environmental visibility: A trigger of green organizational response?', *Business Strategy and the Environment*, 9(2), pp. 92–107. doi: 10.1002/(SICI)1099-0836(200003/04)9:2<92::AID-BSE230>3.0.CO;2-X.
- Callan, S. J. and Thomas, J. M. (2009) 'Corporate Financial Performance and Corporate Social Performance: An Update and Reinvestigation', 78(February), pp. 61–78. doi: 10.1002/csr.
- Cegarra-Navarro, J. G. and Martínez-Martínez, A. (2010) 'Managing environmental knowledge through learning processes in Spanish hospitality companies', *Spanish Journal of Psychology*, 13(2), pp. 827–840.
- Céspedes-Lorente, J., Burgos-Jiménez, J. de and Álvarez-Gil, M. J. (2003) 'Stakeholders' environmental influence. An empirical analysis in the Spanish hotel industry', *Scandinavian Journal of Management*, 19(3), pp. 333–358. doi: 10.1016/S0956-5221(02)00034-9.
- Chin, W. W. (1998) 'The partial least squares approach for structural equation modeling', in Mahwah, N. L. E. A. (ed.) *Modern methods for business research*. Marcoulide, pp. 295–336.
- Chin, W. W., Marcolin, E. and Newsted, P. R. (2003) 'A partial least squares latent variable modeling approach for measuring interaction effects: results from a Monte Carlo simulation study and an electronic mail emotion/adoption study', *Information System Research*, 14(2), pp. 189–217.
- Churchill, G. A. (1979) 'A Paradigm for Developing Better Measures of Marketing Constructs', *Journal of Marketing Research*. American Marketing Association, 16(1), pp. 64–73.
- Civre, Z. and Omerzel, D. G. (2015) 'The behaviour of tourism firms in the area of innovativeness', *Economic Research-Ekonomska Istraživanja*, 28(1), pp. 312–330. doi: 10.1080/1331677X.2015.1043778.
- Cruz, A. D., Martínez, E. E. V., Hincapié, J. M. M. and Torres, F. R. (2016) 'Innovation in tourism companies, where are they and where are they going? An approach to the state of knowledge', *Intangible Capital*, 12(4), pp. 1088–1155. doi: 10.3926/ic.778.

- Dangelico, R. M. and Pontrandolfo, P. (2015) 'Being "Green and Competitive": The Impact of Environmental Actions and Collaborations on Firm Performance', *Business Strategy and the Environment*, 24(6), pp. 413–430. doi: 10.1002/bse.1828.
- Darnall, N., Henriques, I. and Sadorsky, P. (2010) 'Adopting proactive environmental strategy: The influence of stakeholders and firm size', *Journal of Management Studies*, 47(6), pp. 1072–1094. doi: 10.1111/j.1467-6486.2009.00873.x.
- Easterby-Smith, M. and Prieto, I. M. (2008) 'Dynamic capabilities and knowledge management: An integrative role for learning?', *British Journal of Management*, 19(3), pp. 235–249. doi: 10.1111/j.1467-8551.2007.00543.x.
- Font, X., Garay, L. and Jones, S. (2016) 'Sustainability motivations and practices in small tourism enterprises in European protected areas', *Journal of Cleaner Production*. Elsevier Ltd, 137, pp. 1439–1448. doi: 10.1016/j.jclepro.2014.01.071.
- Fornell, C. and Larcker, D. F. (1981) 'Evaluating Structural Equation Models with Unobservable Variables and Measurement Error', *Journal of Marketing Research*. American Marketing Association, 18(1), pp. 39–50.
- Fraj, E., Matute, J. and Melero, I. (2015) 'Environmental strategies and organizational competitiveness in the hotel industry: The role of learning and innovation as determinants of environmental success', *Tourism Management*, 46, pp. 30–42. doi: 10.1016/j.tourman.2014.05.009.
- Frick, J., Kaiser, F. G. and Wilson, M. (2004) 'Environmental knowledge and conservation behavior: Exploring prevalence and structure in a representative sample', *Personality and Individual Differences*, 37(8), pp. 1597–1613. doi: 10.1016/j.paid.2004.02.015.
- Fryxell, G. E. and Lo, C. W. H. (2015) 'The influence of environmental knowledge and values on managerial behavior in China: a comparison of managers in Guangzhou and Beijing', 10th international conference of the Greening of Industry Network, pp. 1–35.
- González-Benito, J. and González-Benito, Ó. (2005) 'Environmental proactivity and business performance: An empirical analysis', *Omega*, 33(1), pp. 1–15. doi: 10.1016/j.omega.2004.03.002.
- Grant, R. M. and Spender, J. (1996) 'Knowledge and the Firm: Overview', *Strategic Management Journal*, 17(Winter), pp. 5–9.
- Han, H., Hsu, L.-T. J., Lee, J.-S. and Sheu, C. (2011) 'Are lodging customers ready to go green? An examination of attitudes, demographics, and eco-friendly intentions', *International Journal of Hospitality Management*, 30(2), pp. 345–355. doi: 10.1016/j.ijhm.2010.07.008.
- Han, X. and Chan, K. (2013) 'Perception of Green Hotels Among Tourists in Hong Kong: An Exploratory Study', *Services Marketing Quarterly*, 34(4), pp. 339–352. doi: 10.1080/15332969.2013.827069.
- Hsu, C.-W. and Hu, A. H. (2008) 'Green supply chain management in the electronic industry', *International Journal of Environmental Science & Technology*, 5(2), pp. 205–216.
- Kabongo, J. D. and Boiral, O. (2017) 'Doing More with Less: Building Dynamic Capabilities for Eco-Efficiency', *Business Strategy and the Environment*. doi: 10.1002/bse.1958.
- Kalmuk, G. and Acar, A. Z. (2015) 'The Mediating Role of Organizational Learning Capability on the Relationship Between Innovation and Firm's Performance: A Conceptual Framework', *Procedia - Social and Behavioral Sciences*. Elsevier B.V., 210, pp. 164–169. doi: 10.1016/j.sbspro.2015.11.355.
- Kaplan, R. S. and Norton, D. P. (1992) 'The Balanced Scorecard Measures That Drive Performance', *Harvard Business Review*, 70(1), pp. 71–79.
- Kates, R. W., Clark, W. C., Corell, R., Hall, J. M., Jaeger, C. C., Lowe, I., McCarthy, J. J., Schellnhuber, H. J., Bolin, B., Dickson, N. M., Faucheux, S., Gallopin, G. C., Grubler, A., Huntley, B., Jäger, J., Jodha, N. S., Kasperson, R. E., Mabogunje, A., Matson, P., Mooney, H., Moore, B., Riordan, T. and Svedin, U. (2001) 'Environmental and development: sustainability science', *Science*, 292(5517), pp. 641–642. Available at: <http://science.sciencemag.org/content/292/5517/641>.
- Kim, T. and Rhee, M. (2009) 'Exploration and exploitation: internal variety and environmental dynamism', *Strategic Organization*, 7(1), pp. 11–41. doi: 10.1177/1476127008100125.
- Klassen, R. D. and McLaughlin, C. P. (1996) 'The Impact of Environmental Management on Firm Performance', *Management Science*, 42(8), pp. 1199–1214. doi: 10.1287/mnsc.42.8.1199.
- Liao, S. H., Chang, W. J. and Wu, C. C. (2010) 'An integrated model for learning organization with strategic view: Benchmarking in the knowledge-intensive industry', *Expert Systems with Applications*, 37(5), pp. 3792–3798. doi: 10.1016/j.eswa.2009.11.041.
- March, J. G. and Sutton, R. (1997) 'Organizational Performance as a Dependent Variable', *Organization Science*, 8(6), pp. 698–706. doi: 10.1287/orsc.8.6.698.
- Martínez-Martínez, A., Cegarra-Navarro, J.-G. and García-Pérez, A. (2015) 'Environmental knowledge management: A long-term enabler of tourism development', *Tourism Management*, 50, pp. 281–291. doi: 10.1016/j.tourman.2015.03.006.

- Mina, A., Bascavusoglu-Moreau, E. and Hughes, A. (2014) 'Open service innovation and the firm's search for external knowledge', *Research Policy*. Elsevier B.V., 43(5), pp. 853–866. doi: 10.1016/j.respol.2013.07.004.
- Mittal, S. and Dhar, R. L. (2016) 'Effect of green transformational leadership on green creativity: A study of tourist hotels', *Tourism Management*. Elsevier Ltd, 57, pp. 118–127. doi: 10.1016/j.tourman.2016.05.007.
- Molina-Azorín, J. F., Claver-Cortés, E., Pereira-Moliner, J. and Tari, J. J. (2009) 'Environmental practices and firm performance: an empirical analysis in the Spanish hotel industry', *Journal of Cleaner Production*, 17(5), pp. 516–524. doi: 10.1016/j.jclepro.2008.09.001.
- Mom, T. J. M., Van Den Bosch, F. A. J. and Volberda, H. W. (2007) 'Investigating managers' exploration and exploitation activities: The influence of top-down, bottom-up, and horizontal knowledge inflows', *Journal of Management Studies*, 44(6), pp. 910–931. doi: 10.1111/j.1467-6486.2007.00697.x.
- Nunnally, J. (1978) *Psychometric theory*. New York: McGraw-Hill.
- Paillé, P. and Raineri, N. (2015) 'Linking perceived corporate environmental policies and employees eco-initiatives: The influence of perceived organizational support and psychological contract breach', *Journal of Business Research*. Elsevier Inc., 68(11), pp. 2404–2411. doi: 10.1016/j.jbusres.2015.02.021.
- Po-Shin, H. and Li-Hsing, S. (2009) 'Effective environmental management through environmental knowledge management', *International Journal of Environmental Science & Technology*, 6(1), pp. 35–50. doi: 10.1007/BF03326058.
- Rahman, I. and Reynolds, D. (2016) 'Predicting green hotel behavioral intentions using a theory of environmental commitment and sacrifice for the environment', *International Journal of Hospitality Management*. Elsevier Ltd, 52, pp. 107–116. doi: 10.1016/j.ijhm.2015.09.007.
- Sheng, M. L. and Chien, I. (2016) 'Rethinking organizational learning orientation on radical and incremental innovation in high-tech firms', *Journal of Business Research*. Elsevier Inc., 69(6), pp. 2302–2308. doi: 10.1016/j.jbusres.2015.12.046.
- Sinclair, A. J., Diduck, A. and Fitzpatrick, P. (2008) 'Conceptualizing learning for sustainability through environmental assessment: critical reflections on 15 years of research', *Environmental Impact Assessment Review*, 28(7), pp. 415–428. doi: 10.1016/j.eiar.2007.11.001.
- Song, H., Dwyer, L., Li, G. and Cao, Z. (2012) 'Tourism economics research: A review and assessment', *Annals of Tourism Research*. Elsevier Ltd, 39(3), pp. 1653–1682. doi: 10.1016/j.annals.2012.05.023.
- Spender, J.C. (1998) 'Making knowledge the basis of a dynamic theory of the firm', *Strategic Management Journal*, 17(Winter Special Issue), pp. 45–62. doi: 10.1002/smj.4250171106.
- Stegerean, R., Petre, A. and Chis, A. (2014) 'Environmental strategy and hotel competitiveness-evidence from Brasov County', in Popa, I., Dobrin, C., and Ciocoiu, C. (eds) *International management conference 'Management challenges for sustainable development'*. Bucharest, Romania, pp. 590–297.
- Waldimir, A., Da, L., Steil, A. V. and Selig, P. M. (2011) 'Learning in Organizations As Outcome of Environmental Assessment Processes'.
- Wernick, I. (2003) 'Environmental Knowledge Management', *Journal of Industrial Ecology*, 6(2), pp. 7–9. doi: 10.1162/108819802763471735.
- Whyte, K. P. (2013) 'On the role of traditional ecological knowledge as a collaborative concept: a philosophical study', *Ecological Processes*, 2(7), pp. 1–12. doi: 10.1186/2192-1709-2-7.
- WTO (2016) *World Tourism Barometer*, Unwto. doi:10.18111/wtobarometereng.2015.13.4.1.
- Zahra, S. A. and George, G. (2002) 'Absorptive capacity: a review, reconceptualization, and extension', *Academy of Management Review*. Academy of Management, 27(2), pp. 185–203. doi: 10.5465/AMR.2002.6587995.
- Zollo, M. and Winter, S. G. (2002) 'Deliberate Learning and the Evolution of Dynamic Capabilities', *Organization Science*, 13(3), pp. 339–351. doi: 10.1287/orsc.13.3.339.2780.

## APPENDIX: QUESTIONNAIRE ITEMS

---

**Knowledge Exploration: Indicate the extent to which each of the agents indicated below has capacity to influence on the hotel's environmental performance (0= no capacity and 10= high capacity):**

---

KEr\_1: Your company cares about collecting information about the most important groups

KEr\_2: Your company supports the exchange of ideas and formal dialogues (for example meetings)

KEr\_3: Your company has manuals and documents on customer service procedures

KEr\_4: We emphasize the search and sharing of new values and thoughts

---

**Knowledge Exploitation: Indicate the extent to which each of the agents indicated below has capacity to influence on the hotel's environmental performance (0= no capacity and 10= high capacity):**

---

KEt\_1: When our customers want us to modify a product or service, we make efforts to modify it.

KEt\_2: Your company rewards the creativity of employees

KEt\_3: Your company supports the use of metaphors to resolve employee doubts

KEt\_4: Your company shares information with the most important collectives of the question

---

**Environmental knowledge (0= high disagreement and 10= high agreement):**

---

EK\_1: Priority is being given to organic products (biodegradable, recyclable, etc).

EK\_2: The company (hotel) uses less polluting industrial processes and products.

EK\_3: The company (hotel) has developed a green program (waste management, control of effluents, inventory of pollution sources).

EK\_4: The company (hotel) has developed a drafting of environmental emergency plans and measures.

---

**Business Performance (0=much worse than competitors and 10=much better than competitors):**

---

BP\_1: Growth rate of sales

BP\_2: Growth rate of profits

BP\_3: Profitability rate on total assets

BP\_4: Greater productivity

---



# THE SUCCESS OF CROSS BORDER ACQUISITIONS: DOES CULTURAL DISTANCE MATTER FOR CONSUMERS?

Matarazzo, Michela<sup>1</sup>; Lanzilli, Giulia<sup>2</sup>; Resciniti, Riccardo<sup>2</sup>

Marconi University, Rome, Italy

University of Sannio, Benevento, Italy

## ABSTRACT

The aim of this research is to investigate the effect of cultural distance on the reputation transferability from a local target firm to a foreign acquirer by analyzing local country consumers. The work compares two foreign acquiring companies: a Chinese firm (large cultural distance to Italy) and a Spanish firm (small cultural distance to Italy). The findings show that Italian consumers have more negative attitudes and lower repurchase intentions toward the post-acquisition target if the acquirer has large cultural distance rather than it has small cultural distance. Furthermore, the study aims at verifying that the case of small cultural distance fosters the reputation transferability more than the opposite case of large cultural distance. The research could be of value and interest because little has been written dealing with the acquisition process in relation to market-based performance, particularly analyzing the consumer behavior toward a post-acquisition target.

*Keywords: Cross-border acquisitions, cultural distance, reputation transferability.*

## 1.INTRODUCTION

Cross-border mergers and acquisitions (M&As) have become increasingly popular over the last decade and represent an important alternative for strategic expansion. A large part of scholars has focused on cross-border M&As performances in order to define and suggest good practices and reduce the failure number of such operations (Perry and Herd, 2004; Teerikangas and Very, 2006). However, few studies have focused on consumers' perspective after an acquisition operation (Thorbjørnsen and Dahlén, 2011; Fong *et al.*, 2013). This variable could shed more light on the prospects of acquisition (Heinberg *et al.*, 2016)

Another theoretically and empirically under-investigated phenomenon is the impact of cultural distance on the reputation transferability in the acquisition process. Cultural distance plays a considerable and complex role in acquisitions because of its impact on the reputation transferability. The aim of this research is to fill this gap by investigating, in cross-border acquisitions, how cultural

distance between the country of the acquirer and that of the acquired company influences the reputation transferability from a local target firm to a foreign acquirer.

The study contributes to the cross-border acquisition literature in several manners. First, it investigates the impact of cross-border acquisitions on consumer behaviour. Previous studies put more emphasis on objective data stressing managerial, organizational and financial aspects (Bandick, 2011) and ignoring the influence that cross-border acquisitions could have on consumers' responses. Second, this study analyzes the impact of cultural distance between the acquirer and acquired firm on consumers' choices. Existing literature is mainly based on the impact of cultural distance on organizational aspects in the cross-border acquisition rather than a consumers' behavior (Kirkman and Shapiro, 2001). Third, for the first time, reputation transferability and cultural distance among firms involved in a cross-border acquisition are linked in the same interpretative model.

In the following section, a review of the literature on the relation between the three topics analyzed is presented. Then the article describes the methodology adopted and the results. The last section summarizes the authors' findings and discusses future research areas.

## 2. THEORETICAL BACKGROUND AND HYPOTHESES

A commonly accepted definition of corporate reputation is "a perceptual representation of a firm's past actions and future prospects that describe the firm's overall appeal to all its key constituents when compared to other leading rivals" (Fombrun, 1996 p.72). Fombrun *et al.* (2000) developed the RQ (Reputation Quotient) model based on six dimensions: emotional appeal, products and services, financial performance, vision and leadership, workplace environment and social responsibility. Additionally, according to Lafferty and Goldsmith (1999) corporate reputation have a significant influence on consumers' attitudes and purchase intentions. In fact, corporate reputation is in part a measure of future prospects, which may be clouded by an acquisition (Saxton, 2004). Acquisitions can create uncertainty for consumers, therefore the high reputation of the company could reduce it (Saxton and Dollinger, 2004).

Little of the research on corporate reputation has paid adequate attention to link reputational transferability and cultural distance among firms involved in the acquisition process. Hofstede defined the concept of culture as the "collective programming of the human mind" which he operationalized by means of six dimensions (Hofstede, 2001): power distance; individualism/collectivism; masculinity/femininity; uncertainty avoidance; long/short term orientation and indulgence/restraint. Hofstede developed his original model proposing only the first four dimensions along which cultural values could be analyzed. Further research led him to add a fifth (long-term orientation), and then a sixth dimension (indulgence versus self-restraint).

Doney *et al.* (1998) suggested that norms and values linked to Hofstede's dimensions influence the extent and manner in which the transfer of reputation to the corporate level can take place. They highlighted how significantly cultural differences on the side of the corporate audience could shape perception and create conditions, which either support or inhibit transference of reputation. Therefore, it is reasonable to expect that intangible assets are even less likely to accrue to an acquirer when cultural differences are large (Saxton, 2004 p.185). The creation of positive attitudes toward new organizations, the emergence of a sense of shared identity and trust among organizational members is facilitated if the other part shares the same values and norms (Stahl and Voigt, 2008).

Thus, we suppose that in presence of large cultural distance between the acquired and the acquirer firm, consumers will have a more negative attitude and lower repurchase intention toward the post-acquisition target. Consumers react that way because they perceive the acquiring firm as operating under different norms and values, therefore trust can be erode.

The research considered China and Spain to investigate this phenomenon. The choice of countries was based following the Kogut and Singh's index (1988), a composite measure of Hofstede's dimensions of national cultures.

The above discussion leads to the following hypotheses:

*H1a:* Consumers have more negative attitude toward a post-acquisition target with high reputation when the foreign acquirer has large cultural distance from the home market (Chinese firm) than they do when the foreign acquirer has small cultural distance (Spanish firm).

*H1b:* Consumers have lower repurchase intentions toward the post-acquisition target with high reputation when the foreign acquirer has large cultural distance from the home market (Chinese firm) than they do when the foreign acquirer has small cultural distance (Spanish firm).

Figure 1: Research model

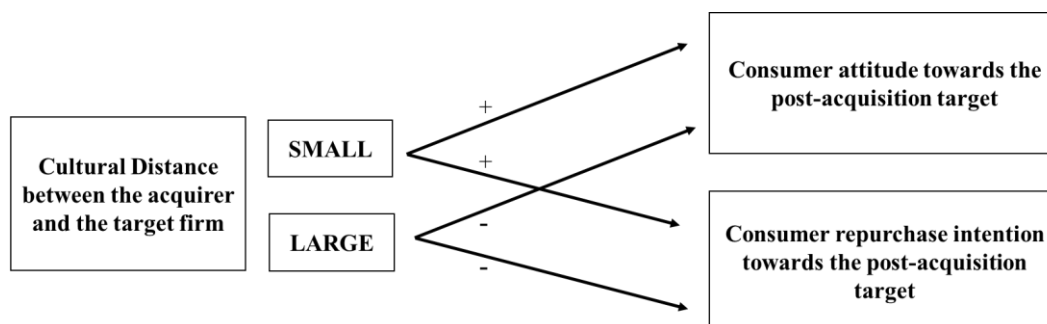

Source: Our elaboration

### 3.METHODOLOGY

In order to test the hypotheses above-mentioned, the following assumptions were made (Fong et al., 2013): the foreign firm acquires all shares of a local firm; the corporate name of the acquired target remains unchanged; the foreign acquirer assigned a new CEO and key positions in the firm; the foreign acquirer firm has high reputation; the respondents are habitual customers of the acquired firm.

The current study takes into account a cross-border acquisition of an Italian firm, which operates in the food sector. It is a real firm, but with disguised brand name. It is the market leader in Italy for processed meat products (ham, mortadella, salami, sausages etc.), which are completely manufactured and packaged in the home country. Moreover, the study considers two acquirers: the first with large cultural distance (Chinese firm) and the second with small cultural distance to Italy (Spanish firm). We compared consumers' attitude and repurchase intentions in two business scenario: the first one with large cultural distance and the second one with small cultural distance between the acquirer and the acquired firm. In both scenario, acquirer and acquired firm are supposed to have high reputation. The valence was manipulated using a number of stars (\*) on six corporate attributes considered. The greater the number of stars, the higher the reputation status.

The survey was conducted on 424 Italian students through online questionnaire built on validated scales in the literature. The use of students as respondents is a common practice in consumer behavior studies (Chaudhuri and Holbrook, 2001; Fong et al. 2013) considering that they are a more homogeneous group than ordinary individuals are. Of the 424 students who participated in this study, 216 replied to the first type of questionnaire (local target acquisition from a Chinese firm, Scenario 1) and 208 replied to the second type of questionnaire (local target acquisition from a Spanish firm, Scenario 2).

In order to allow participants to better understand the relevant points of our research, both the acquired and the acquirer firm profile was described in the first section of the questionnaire, and participants were informed about the high corporate reputation of the firms involved. This study considers six dimensions of Fombrun *et al.* (2000) as criteria to evaluate corporate reputation. In the second section, respondents were asked to express their attitudes toward the post-acquisition target on nine, seven-point scale, anchored as "disagree very much" and "agree very much" (Javalgi *et al.*, 1994; Mathwick *et al.*, 2004; Pope *et al.*, 2004). Later, participants were asked if they would consider repurchasing products of the post-acquisition target on four, nine-point scale, anchored at "disagree very much" and "agree very much" (Heitmann *et al.*, 2007). Each measure demonstrated a relatively high internal consistency (Cronbach's  $\alpha=0.99$  and  $\alpha=0.98$ ). The last page contained questions related to personal information.

#### 4.RESULTS

The manipulation check for the valence of the reputation of the local firm acquired was successful. In both scenario, the perceived reputation of the target firm was the same ( $M_1= 6,38$  versus  $M_2= 6,47$ ;  $t=-1.48$ ;  $p>0.05$ ).

Hypotheses were assessed using t-test. Italian respondents evaluated the post-acquisition target more negatively if the acquiring firm has large cultural distance rather than the acquiring firm has small cultural distance ( $M_{Lcd} = 2.62$  versus  $M_{Scd} = 5.81$   $p < .001$ . See Table 1). The results, therefore, are in line with the hypothesis H<sub>1</sub>.

In a similar manner, H<sub>2</sub> predicts that Italian consumers have lower intentions to repurchase products of the post-acquisition target if the acquiring firm has large cultural distance rather than small cultural distance. As expected, the main effect was significant ( $M_{Lcd} = 2.75$  versus  $M_{Scd} = 7.1$   $p < .001$ . See table 1).

The findings support the hypothesis above-mentioned.

Table 1: Results of H1 and H2

	Means (M)		Std. Deviation		t	Sig.
	Large Cultural Distance (MLcd)	Small Cultural Distance (MScd)	Large Cultural Distance	Small Cultural Distance		
Attitude toward the post-acquisition target	2,6157	5,8088	1,66347	1,30265	-22,05	0,000***
Repurchase intention toward the post-acquisition target	2,7488	7,0901	2,12002	1,80193	-22,749	0,000***

\*\*\* $p<.001$

## 5.DISCUSSION

Findings indicate that cultural distance could hinder the transfer of reputation from the local target to the acquirer. In fact, the transfer of reputation assets of the local target only occurs in case of small cultural distance between the acquired and the acquirer.

A reason why Italian consumers had more negative attitudes and lower purchase intentions in case of large cultural distance could be relative to their own culture. Italian culture is characterized by both high masculinity and individualism (geert-hofstede.com/italy.html). Schweizer and Wijnberg (1999) argue that the more are masculinity and individualism, the less corporate reputation transferability will be. Anyway, this study provides evidence of reputation transferability if the acquiring firm shows

small cultural distance. The reason would be that Italy has high level of uncertainty avoidance, therefore Italians are more frightened by distant cultures.

These results provide important evidences that the cultural distance directly affects consumers' attitudes and purchase intentions toward the post-acquisition target.

## **6.MANAGERIAL IMPLICATION**

The managerial implications of the study refer to companies engaging cross-border acquisitions. In order to get the intangible benefits of a faithful behavior, a well-established brand and a good reputation, firms should carefully analyze the reactions of consumers. When the cultural distance between the acquiring and the acquired firm is large, the host acquiring firm can't reap the benefits of the reputational capital and of the customer target. Therefore, when the cultural distance seems to hamper the reputational transferability and the acquisition benefits, managers could consider other entry modes.

Prior research suggests that to enhance consumers' attitude to an acquired firm post-acquisition, the multinational has to increase its legitimacy in order to be perceived as a national firm (Zaheer, 1995; Luo and Mezas, 2002) and to factor in customers opinions (Thornbjornsen and Dahlén, 2011).

This research also finds that in case of small cultural distance, local target reputation could be transferred to the post-acquisition target. Thus, an acquiring firm with similar characteristic can acquire an Italian firm of made in Italy and benefit from the advantages of its high reputation, customer base and market resources. Taking into account all factors, foreign companies with small cultural distance to Italy may benefit from the local target reputation transferability. Italian will continue to consider that product as made in Italy, and they will have a positive attitude toward the post-acquisition target and its products.

## **7.LIMITATION AND FUTURE RESEARCH**

The present study has some limitations, and the recognition of these should represent opportunities for future research. The findings are limited to the product tested. Future research with other products or services not belonging to sector of made in Italy, could shed light on limits of these findings. Second, the study only considers acquirers with high reputation; however, considering a foreign acquirer with low reputation may lead to different results despite the presence of small cultural distance. Thus, future research could consider a low reputation foreign acquirer in order to extend this line of research.

Third, as our sample solely consists of Italian consumers, we recommend future studies to replicate our test in other settings, analyzing the reaction of consumers from other countries in order to contribute to the generalizability of our findings.

## REFERENCES

- Bandick, R. (2011). Foreign acquisition, wages and productivity. *The World Economy*, 34,6, 931-951.
- Chaudhuri, A., & Holbrook, M.B. (2001). The chain of effects from brand trust and brand affect to brand performance: the role of brand loyalty. *Journal of marketing*, 65, 2, 81-93.
- Doney, P.M., Cannon, J.P., & Mullen, M.R. (1998). Understanding the influence of national culture on the development of trust. *Academy of management review*, 23, 3, 601-620.
- Fombrun, C.J. (1996). *Reputation: Realizing value from the corporate image*. Boston: Harvard Business School Press.
- Fombrun, C.J., Gardberg, N.A., & Sever, J.M. (2000). The Reputation Quotient<sup>SM</sup>: a multi-stakeholder measure of corporate reputation. *Journal of Brand Management*, 7, 4, 241-255.
- Fong, C.M., Lee, C.L., & Du, Y. (2013). Target reputation transferability, consumer animosity, and cross-border acquisition success: a comparison between China and Taiwan. *International Business Review*, 22, 1, 174-186.
- Hofstede, G. (2001). *Culture's consequences: comparing values, behaviors, institutions and organizations across nations*. 2nd Edition, Thousand Oaks CA: Sage Publications.
- Heinberg, M., Ozkaya, H.E., & Taube, M. (2016). A brand built on sand: is acquiring a local brand in an emerging market an ill-advised strategy for foreign companies?. *Journal of the Academy of Marketing Science*, 44, 5, 586-607.
- Heitmann, M., Lehmann, D.R., & Herrmann, A. (2007). Choice goal attainment and decision and consumption satisfaction. *Journal of Marketing Research*, 44, 2, 234-250.
- Javalgi, R.G., Traylor, M.B., Gross, A.C., & Lampman, E. (1994). Awareness of sponsorship and corporate image: an empirical investigation. *Journal of Advertising*, 23, 4, 47-58.
- Kirkman, B.L., & Shapiro, D.L. (2001). The impact of cultural values on job satisfaction and organizational commitment in self-managing work teams: the mediating role of employee resistance. *Academy of Management journal*, 44, 3, 557-569.
- Kogut, B., & Singh, H. (1988). The effect of national culture on the choice of entry mode. *Journal of International Business Studies*, 19, 3, 411-32.
- Lafferty, B.A., & Goldsmith, R.E. (1999). Corporate credibility's role in consumers' attitudes and purchase intentions when a high versus a low credibility endorser is used in the ad. *Journal of Business Research*, 44, 2, 109-116.
- Luo, Y., & Mezas, J.M. (2002). Liabilities of foreignness: concepts, constructs, and consequences. *Journal of International Management*, 8, 3, 217-221.
- Mathwick, C., & Rigdon, E. (2004). Play, flow, and the online search experience. *Journal of consumer research*, 31, 2, 324-332.
- Perry, J.S., & Herd, T.J. (2004). Reducing M&A risk through improved due diligence. *Strategy & Leadership*, 32,2, 12-19.
- Pope, N.K.L., Voges, K.E., & Brown, M.R. (2004). The effect of provocation in the form of mild erotica on attitude to the ad and corporate image. *Journal of Advertising*, 33, 1, 69-82.
- Saxton, T. (2004). Acquisitions and intangible resources: reputations as a mobile and transferable asset. *Advances in Mergers and Acquisition*, 3, 177-191.
- Saxton, T., & Dollinger, M. (2004). Target reputation and appropriability: picking and deploying resources in acquisitions. *Journal of Management*, 30, 1, 123-147.
- Schweizer, T.S., & Wijnberg, N.M. (1999). Transferring reputation to the corporation in different cultures: individuals, collectives, systems and the strategic management of corporate reputation. *Corporate Reputation Review*, 2, 3, 249-266.
- Stahl, G. K., & Voigt, A. (2008). Do cultural differences matter in mergers and acquisitions? A tentative model and examination. *Organization Science*, 19, 1, 160-176.
- Teerikangas, S., & Very, P. (2006). The culture-performance relationship in M&A: from yes/no to how. *British Journal of Management*, 17, S1, S31-S48.

- Thorbjørnsen, H., & Dahlén, M. (2011). Customer reactions to acquirer-dominant mergers and acquisitions. *International journal of Research in Marketing*, 28, 4, 332-341.
- Zaheer, S. (1995). Overcoming the liability of foreignness. *Academy of Management Journal*, 38, 2, 341-363.



# THE COST OF CAPITAL IN THE BOND MARKET. WHEN THE FIRMS ALLEGEDLY RESTATED EARNINGS

Felice Matozza<sup>1</sup>; Elisabetta Mafrolla<sup>2</sup>; Anna Maria Biscotti<sup>2</sup>

<sup>1</sup>University of Roma Tre, Italy

<sup>2</sup>University of Foggia, Italy

## ABSTRACT

This paper studies the market reaction to an inconvenient event, i.e. the accounting restatement of earnings, occurring when the firms acknowledge that they released financial statements that were not in accordance with GAAP. Through an empirical test on 133 bonds issued by restating firms from 26 IFRS-adopting countries, we find that due to restatements the cost of financing increases among bonds, similar to those increases previously observed among stocks and private debt. Hence, restatements signal lower firm value, as the results indicate that they impair corporate bond ratings and increase bond yield spreads. Furthermore, the increase in bond yield spreads is significantly larger when the error is more severe. Our findings suggest that rating agencies and bondholders perceive restatements as a critical determinant of the risk of debt financing. Overall, our research fills an important void in the extant restatements literature and completes the framework for measuring the feasible impact of restatements on the corporate cost of capital.

*Keywords: restatement; bond market; agency ratings; bond yield spread; severity*

## 1. INTRODUCTION

Firms meet an accounting restatement when they acknowledge that they released financial statements that were not in accordance with GAAP, usually because their statements were affected by a material omission or misstatement (Palmrose & Scholz, 2004).

Previous studies document a massive recourse to accounting restatements. For example, in 2002 in the USA, restatements involved approximately 10% of listed firms, representing a market value of roughly 2 billion US dollars. Empirical evidence shows that restatements cause a reduction in shareholder value, decreasing stock returns and increasing the cost of equity (Palmrose et al., 2004; Hribar & Jenkins, 2004; Albring et al., 2013). In a two-day window after the announcement of restatements, firms have been found to suffer an approximate 9% abnormal decrease in stock returns; in a one-month period after restatements, the cost of the equity capital increases by over 10%. Similarly, looking at the effects of restatements on private loan contracting, an 11% increase in the

total loan rate has been found during the one-year period following a restatement (Graham et al., 2008).

Conclusively, restatements risk the credibility of firm disclosure, likely reducing the value of the firm and increasing company risk (Graham et al., 2008).

Existing literature has examined the adverse consequences of accounting restatement from the perspectives of equity holders (Palmrose et al., 2004; Hribar & Jenkins, 2004) and private debt contractors (Graham et al., 2008; Park & Wu, 2009). Given that both stock and bond markets are dependent on the same underlying firm value, it could be of interest to study the effects of accounting restatements on corporate bond financing, an area that has been overlooked by the literature. This paper aims to fill this gap by providing empirical evidence of the impact of accounting restatements on bond issues.

We focus on the bond market for two primary reasons. First, corporate bond issues increased in volume and frequency in the last decade (Creditreform Rating AG, 2015) due to the decline in both bank lending and interest rates driven by the advent of the global financial crises (Tendulkar & Hancock, 2014). Second, corporate bonds complement equity and private debt in building firms' capital structure. Studying the effect of restatements on bond markets can help to provide a comprehensive framework to measure the impact of restatements on the cost of capital. Our study investigates the unexplored question of whether restatements affect bond issues and how they are perceived by credit rating agencies and bondholders, which drive the cost of bonds.

To test our predictions, we selected all restatements occurring in the period 2006-2014 from listed firms that are mandatory IFRS adopters (26 countries), ultimately collecting 133 bonds issued by restating firms.

In line with our expectations, we documented that compared with bonds issued before restatement, bonds issued after restatement have lower corporate ratings. Moreover, after restatement, bondholders require a higher risk premium. We also investigated whether bond markets punish more severe restatement through a sharper decrease in bond ratings and a larger increase in yield spreads in the post-restatement period. Using principal component analysis to proxy the severity of errors, we found that firms with more severe restatements have a larger increase in yield spreads after the error announcement. Finally, studying a pair-matched sample of restating and non-restating firms, we found that the bonds of the restating firms underperform those of the non-restating firms only in the aftermath of the restatement.

This paper makes several contributions.

*In primis*, our study stands beside the literature investigating the effects of restatement on the cost of equity (Hribar & Jenkins, 2004) and on private debt financing (Graham et al., 2008). We provide new

insights from the alternative perspective of public debtholders, which are supposed to be more cash-than earnings-focused in their estimate of firm value because “payment has to be made by cash” (Standard & Poor’s Rating Services, 2014).

Second, since restatements increase information uncertainty (Dechow et al., 1996; Palmrose et al., 2004; Hribar & Jenkins, 2004), this work reinforces Lu et al.’s (2010) study, which shows that information uncertainty has a significant impact on increasing bond yield spreads.

Third, to date, empirical research on restatements has examined US (Palmrose et al., 2004; Palmrose & Scholz, 2004; Srinivasan, 2005), Chinese (Firth et al. 2011; Jiang et al., 2015; Ma et al., 2015) and German (Hitz et al., 2012; Böcking et al., 2015; Strohmenger, 2014) firms, whereas research from other countries is still lacking. To our knowledge, this work is the first cross-national empirical analysis of restatements.

The rest of the paper follows the outline given below. Section 2 reviews the related literature. Section 3 develops the hypotheses that this research will test. Section 4 explains the empirical methods. Section 5 describes the sample. Section 6 presents the results, and Section 7 concludes the paper with a brief discussion.

## 2. LITERATURE REVIEW

An accounting restatement consists of adjustments to a previously published accounting statement due to the occurrence of a material error(s)<sup>8</sup>. A restatement can be forced either by external auditors or by market authorities; moreover, firms themselves can voluntarily report error(s), which are typically discovered by performing an internal review process (Chung & McCracken, 2014). In accounting literature, a financial restatement that corrects previous accounting errors is viewed as a clear measure of poor accounting (Palmrose and Scholz, 2004) and audit (DeFond and Zhang, 2014) quality. Moreover, restatement is a proxy used to measure earnings quality, and it is more direct than discretionary accruals and other earnings quality measures (Francis, 2011; Dechow et al., 2010; DeFond & Zhang, 2014).

Restatements lead investors to reassess the quality of a firm’s financial information, as they perceive a greater risk of encountering misleading information in the aftermath of restatements (Kravet and Shevlin, 2010). Extensive research has variously studied the adverse impacts of restatements on firm value, such as downward revisions in market value (Palmrose et al., 2004; Karpoff et al., 2008; Dechow et al., 1996), lower firm growth (Albring et al., 2013), higher auditor and board turnover (Hennes et al., 2014; Srinivasan, 2005), and an increase in audit fees (Feldmann et al., 2009).

One major stream of research demonstrated that restating firms suffer a significant increase in the cost of capital, although mainly focusing on the cost of equity.

### *2.1 Restatements and the cost of equity*

Research has extensively documented that restatements cause a substantial loss of market value, with abnormal returns estimates ranging from -4% to -19% in the aftermath of restatement announcements (Dechow et al., 1996; Anderson & Yohn, 2002; Palmrose et al., 2004; Hribar & Jenkins, 2004).

Studying a sample of firms that allegedly overstated reported earnings and that were under enforcement action by the Security and Exchange Commission, Dechow et al. (1996) initiated the literature on the causes and consequences of restatements. They found that firms overstating earnings initially enjoy a lower cost of capital, but once the earnings manipulation is revealed and the restatement occurs, the firms experience significant increases in their cost of capital, proxied by the increase in short-term interest and the dispersion of analyst forecasts. Palmrose et al. (2004) first systematically studied equity market reactions to the announcement of restatements. They found that market-adjusted abnormal returns systematically decrease by 9.2% over a 2-day event window and also noticed a significant increase in the analysts' forecast dispersion at the time of the restatement announcement; this dispersion is negatively correlated with the market reaction to earnings restatement. Anderson and Yohn (2002) similarly studied how markets and dealers react to the announcement of restatements. They examined the market returns and bid-ask spread effects at the time when the accounting problem that lead to restatement is announced and found that both the markets and the dealers perceive an increase in information asymmetry for problems related to revenue recognition, consequently leading to a depreciation in firm value. Finally, Hribar and Jenkins (2004) split the estimation of the loss in market value measured by previous research into two main proxies, on the one hand measuring the decrease in expected future earnings and cash flow – the so-called “numerator effect” – representing firm value, and on the other hand measuring the reduction in the cost of equity capital – the so-called “denominator effect” (Kasznik, 2004: 358) – representing the discount rate. Directly measuring the implied cost of capital through various valuation models, they estimated an average increase in the cost of equity that ranges from 7% to 19% in the month immediately following the restatement.

Restatements impact firms differently, as companies suffer greater financial problems when restatement is more severe. For example, Palmrose et al. (2004) found that restatements involving more negative adjustments of previously reported income are linked to more negative returns. Albring et al. (2013) similarly showed that firms with the largest corrections of prior earnings

---

<sup>8</sup> According to International Accounting Standard no. 8. par. 41, material accounting errors are revealed by adjusting the comparative figures of companies' financial statements for the prior period(s) in which the error occurred. The correction is made in the first set of financial statements authorized for issue after their discovery (IASB, 2005).

experience a larger decrease in externally financed growth after restatement. Consistently, Hennes et al. (2014) documented that error severity is an important determinant of auditor turnover after restatements. Finally, Bardos and Mishra (2014) examined the effect of litigation-triggering restatements on the cost of equity and expected future cash flows compared to restatements that are not followed by litigation. They found that the cost of equity increases after restatement for all firms, but the increase in the cost of equity is substantially greater for firms that are sued for restatement. Conclusively, previous research shows that accounting restatement is a detrimental event that negatively affects the market value of the firm, reducing both its expected earnings and cash flows and augmenting its information uncertainty, thus increasing the cost of equity capital (Palmrose et al., 2004; Hribar & Jenkins, 2004; Dechow et al., 1996). Moreover, when the errors corrected by restatement are more severe, the impact on the financial performance of the firm is stronger (Palmrose et al., 2004; Albring et al., 2013).

## **2.2 Restatements and the debt market**

Debt has a central role in firm financing, as it complements equity in building the firm's capital structure and, together with equity, is an efficient means to reduce the agency costs of the firm (Jensen, 1986).

Graham et al. (2008) and Park and Wu (2009) studied the impact of restatements on debt capital. Because restatements raise concerns about the credibility of financial statements, they increase the perceived informational asymmetry from the bank's perspective. Consequently, Graham et al. (2008) empirically showed how banks use both price and non-price terms to reduce informational asymmetry with borrowers in the aftermath of restatements. They found that banks try to monitor borrowers by using tighter contract terms and a more efficient lending structure, as private bank loans initiated after restatements have higher spreads, shorter maturity, higher fees and more stringent contract terms compared with bank loans initiated before restatements. They further found that firms continue to pay high loan spreads up to five years post-restatement.

Park and Wu (2009) analyzed the secondary loan market. They found that cumulative average abnormal loan returns were significantly negative during the restatement announcement window. Unlike the stock and bond markets, the secondary loan market includes both public and private lending contracts. In a private lending agreement, lenders have the possibility to access information about restatements earlier than the public markets. Park and Wu (2009) surprisingly found that the secondary loan market anticipates impending restatements, with downward revisions of returns starting at least 30 days before the event. Finally, they compared debt and equity secondary markets and documented that information on restatement is incorporated earlier into the cost of debt than it is into the cost of equity. These findings show that in a context where banks and institutional investors

operate with the advantage of private contract agreements, including special access to information, they anticipate restatement announcements. In contrast, previous findings in the main equity market documented that sellers do not anticipate restatement announcement dates (Drake et al., 2015) and similarly that analysts are more likely to revise their forecasts in the aftermath of a restatement disclosure but not before (Griffin, 2004). Hence, due to significant differences in the behavior of market participants in a private compared to a public context, it could be of interest to study the impact of restatement on the public debt market.

### 3. HYPOTHESIS DEVELOPMENT

This paper examines the effect of restatements on the bond markets. Similar to Hribar and Jenkins (2004), we disentangle the bond price effect of restatements into changes in the expected cash flows and changes in the cost of debt. The assumption behind this approach is that the intrinsic value of the firm should be estimated considering both the “numerator effect” of the expected earnings and cash flows and the “denominator effect” of the discount rate.

We adopt credit ratings as a proxy for expected future earnings and cash flows (the “numerator effect”). Credit ratings assigned to bond issues may play a crucial role in enabling companies to raise additional capital, directly providing a measure that can be utilized by investors when making investment decisions. In formulating a rating for an individual corporate bond, rating agencies often take into account both issuer creditworthiness and the credit quality of the bond issue (Standard & Poor’s Ratings Services, 2014) and further evaluate the current and historical financial information of the issuer. Moreover, an agency may adjust the credit rating of an issue when identifying factors that could impact the level of credit risk (Standard & Poor’s Ratings Services, 2014). Restatements inform credit rating agencies that they were using erroneous accounting numbers when they originally assessed the firm’s credit risk, increasing suspicions regarding the future financial reliability of the restating company. Hence, restatements may impact investors’ beliefs about a firm’s future ability to generate cash flow (Graham et al., 2008; Hribar & Jenkins, 2004) because previously disclosed financial statement information was affected by material error(s). In this context, a negative reaction from rating agencies is expected, with a revised and downgraded credit rating of the firm in the aftermath of the error announcement. The following hypothesis is therefore formulated and tested:

*Hypothesis 1: Bonds issued after restatements have lower ratings than bonds issued before restatements.*

As a second hypothesis, we suppose that restatements may affect projections, also impacting the cost of debt. Restatements undermine firms’ perceived ability to meet bond principal payments and interest, as bondholders consider the restatement to be a sign of poor accounting and audit quality.

The best way to compensate for additional credit risk is to require higher risk premiums; therefore, we expect the following:

*Hypothesis 2: Bonds issued after restatements have higher yield spreads than bonds issued before restatements.*

Finally, we extend the literature by exploring the how error severity affects bond ratings and risk premiums. We investigate whether rating agencies and bondholders simply view an error announcement as an adverse event, or whether they instead consider information about the severity of the error in detail and consequently adjust the risk premium. Previous research shows that accounting errors with more serious effects on financial statements bring the competence of management into question (Huang & Scholz, 2012), as severe restatements often contain opportunistic managerial manipulation (Palmrose et al., 2004; Hennes et al., 2008). The more severe the materiality of restatement, the greater the adverse consequences faced by firms (Graham et al., 2008; Albring et al., 2013; Huang and Scholz, 2012; Hennes et al., 2014; Hitz et al., 2012; Palmrose & Scholz, 2004; Bardos et al., 2014). Hence, in line with previous work, we offer the following hypothesis:

*Hypothesis 3: A greater severity in the restatement causes lower bond ratings and a greater increase in bond yield spreads.*

#### 4. RESEARCH DESIGN

This paper empirically investigates the impact of restatements on the bond market. We use two alternate measures of the cost of bond financing, consistent with prior research (Jiang, 2008; Liu & Jiraporn, 2010). We test Hypotheses 1 and 3 using corporate bond ratings as proxies for expected earnings and cash flows from the bond investment; we test Hypothesis 2 and 3 using bond yield spreads as a proxy for the discount rate of the investment.

##### 4.1 Empirical model

Similar to prior literature (Crabtree et al., 2014; Crabtree & Maher, 2009), we test whether rating agencies incorporate restatements into the assigned bond ratings (i.e., Hypothesis 1) using the ordered logistic regression analysis described in Equation (1).

$$\begin{aligned}
 RATING = & \alpha_0 + \beta_1 RESTATE + \gamma_1 SUB + \gamma_2 SIZE + \gamma_3 MATURITY + \gamma_4 COUNTRY + \gamma_5 INCOME + \\
 & + \gamma_6 CFO + \gamma_7 LEV + \gamma_8 ASSETS + \gamma_9 PPE + \gamma_{10} ROA\_D + \gamma_{11} RET\_D + \gamma_{12} BIG4 + \varepsilon
 \end{aligned}
 \tag{1}$$

We subsequently examine the relation between accounting restatement and yield spreads. A potential problem with *RATING* is that it may contain information regarding restatement and control variables. To mitigate collinearity and endogeneity concerns when testing Hypothesis 2 and examining the effect of restatements on bond pricing, we implement a two-stage regression procedure, similar to Anderson et al. (2004) and Mansi et al. (2011). Consequently, we rename the vector of the residuals ( $\varepsilon$ ) from

Equation (1) as *ORTH* and regress Equation (2) as a second stage of the regression contained in Equation (1), adopting the ordinary least squares procedure.<sup>9</sup> *ORTH* in Equation (2) incorporates credit rating information without the influence of restatement and other control variables.

$$YLDSPREAD = \alpha_0 + \beta_1 RESTATE + \beta_2 ORTH + \gamma_1 SUB + \gamma_2 SIZE + \gamma_3 MATURITY + \gamma_5 INCOME + \gamma_6 CFO + \gamma_7 LEV + \gamma_8 ASSETS + \gamma_9 PPE + \gamma_{10} ROA\_D + \gamma_{11} RET\_D + \gamma_{12} BIG4 + \eta_k Industry + \nu$$

(2)

Finally, to test how bond ratings and bond pricing change for various levels of restatement severity (Hypothesis 3), we adopt an interaction model, and Equations (1) and (2) are respectively changed into the following Equations (3) and (4):

$$RATING = \alpha_0 + \beta_1 RESTATE + \beta_3 SEVERITY + \beta_4 RESTATE * SEVERITY + \gamma_1 SUB + \gamma_2 SIZE + \gamma_3 MATURITY + \gamma_4 COUNTRY + \gamma_5 INCOME + \gamma_6 CFO + \gamma_7 LEV + \gamma_8 ASSETS + \gamma_9 PPE + \gamma_{10} ROA\_D + \gamma_{11} RET\_D + \gamma_{12} BIG4 + \eta_k Industry + \varepsilon$$

(3)

$$YLDSPREAD = \alpha_0 + \beta_1 RESTATE + \beta_2 ORTH + \beta_3 SEVERITY + \beta_4 RESTATE * SEVERITY + \gamma_1 SUB + \gamma_2 SIZE + \gamma_3 MATURITY + \gamma_5 INCOME + \gamma_6 CFO + \gamma_7 LEV + \gamma_8 ASSETS + \gamma_9 PPE + \gamma_{10} ROA\_D + \gamma_{11} RET\_D + \gamma_{12} BIG4 + \eta_k Industry + \nu$$

(4)

For all regressions, we utilized robust standard errors to correct for heteroscedasticity (White, 1980) and firm clustering, in line with the previous literature (Ge & Liu, 2015; Ge & Kim, 2014).

#### 4.2 Description of the variables

In Equations (1) and (3), the dependent variable *RATING* is the ordinal representation of each issue's initial rating provided by Standard and Poor's. When Standard and Poor's ratings are missing, we use Moody's ratings (Liu & Jiraporn, 2010). Rating agencies provide an independent assessment of firm credit quality based on inside information. The issue is assigned to a rating category that ranges from AAA, indicating the highest credit quality, to D, the poorest quality, according to the scale provided by Standard and Poor's. We follow bond rating conversion adopted by Liu and Jiraporn (2010), in which *RATING* takes on a value of 22 for AAA-rated bonds and a score of 1 for D-rated bonds.

In Equations (2) and (4), the dependent variable is *YLDSPREAD*, which is the difference between the corporate bond yield at issuance and a Treasury bond yield with comparable maturity (Jiang, 2008; Ge & Liu, 2015).

To test whether restatement in our sample influences bond credit ratings and yield spreads, we adopt the explanatory variable *RESTATE*, which is a dummy variable that equals 1 if a bond is issued after a restatement announcement, and 0 otherwise. In line with Hypothesis 1, we expect a negative

<sup>9</sup> To apply the ordinary least square procedure, in the first step, we changed the ordinal variable *RATING* into its natural logarithm (Ge & Kim, 2014).



relationship between *RESTATE* and *RATING* in Equation (1), whereas Hypothesis 2 predicts that *RESTATE* will be positively associated with *YLDSPREAD* in Equation (2).

To test Hypothesis 3, in Equations (3) and (4) we include *SEVERITY* and the interaction between *SEVERITY* and *RESTATE* in the model, examining whether *RATING* and *YLDSPREAD* are sensitive to *SEVERITY* after the restatement. A number of factors can measure the severity of restatement, such as the magnitude of market reaction to the error announcement (Hennes et al., 2014; Wilson, 2008), the absolute value of the error amount scaled by total assets (Huang & Scholz, 2012; Srinivasan, 2005), the number of years restated (Huang & Scholz, 2012; Palmrose et al., 2004), the number of accounts misstated (Palmrose et al., 2004; Palmrose & Scholz, 2004), the reasons for restatement (Wilson, 2008; Palmrose et al., 2004; Palmrose & Scholz, 2004), whether restatements involved earnings (Wiedman & Hendricks, 2013), and whether restatements were due to irregularities (intentional misapplication of GAAP) or to errors (unintentional misreporting) (Chen et al., 2014; Albring et al., 2013; Hennes et al., 2008). In line with previous empirical analysis (Hennes et al., 2014; Burks, 2010; Hitz et al., 2012), in this study, *SEVERITY* is based on a principal component analysis of multiple restatement measures. It is a linear combination of three measures: (1) the natural logarithm of the number of years the firm restated; (2) the direction of the restatement, which is a categorical variable that equals 1 for downwards restatements and 0 for upwards restatements; and (3) the magnitude of the restatement, which is the absolute value of the error amount divided by total assets at the first fiscal year-end before the restatement announcement. Higher values for this factor represent a more severe restatement. Prior research suggests that restatements with greater negative income effects are of greater concern to market participants (Palmrose et al., 2004). We similarly expect that a greater *SEVERITY\*RESTATE* negatively affects the bond market.

Based on prior research on the determinants of the cost of debt (Crabtree et al., 2014; Liu et al., 2010; Ge & Kim, 2014; Crabtree & Maher, 2009; Jiang, 2008), we included in the model several bond- and firm-control variables. The bond-control variables are *SUB*, *SIZE*, *MATURITY* and *COUNTRY*. *SUB* is a binary variable that equals 1 if the issue is of subordinated bonds, 0 otherwise. Subordinated bonds are expected to be associated with higher risk, thus exhibiting a negative relationship with bond rating and a positive relationship with bond yield spreads (Crabtree & Maher, 2009). *SIZE* is the natural logarithm of the bonds' issue amount. *MATURITY* is the natural logarithm of the bonds' maturity (in years) and should be negatively related to *RATING* and positively related to *YLDSPREAD* (Ge and Kim, 2014). Last, country risk is an important determinant of corporate bond ratings (Standard & Poor's Ratings Services, 2014). As a result, in Equation (1) we also controlled for country risk (Bae & Goyal, 2009) by converting the sovereign risk rating obtained by Moody's sequentially to numbers, with 20 for AAA-rated countries to zero for C-rated countries (Kräussl, 2005). In the regression

analysis, we use a logarithmic transformation of this sovereign credit rating measurement to compute the variable *COUNTRY*. A higher sovereign credit rating indicates lower country risk, so we expect *COUNTRY* to be positively related to *RATING*.<sup>10</sup>

The firm control variables in our model are *INCOME*, *CFO*, *PPE*, *LEV*, *ASSETS*, *ROA\_D*, *RET\_D*, and *BIG4*. *INCOME* is measured as operating income for the year divided by total assets. It controls for firm productivity, and we expect that it is positively related to *RATING* but negatively related to *YLDSPREAD*, as higher *INCOME* indicates a lower default risk for bonds. We included *CFO* (Crabtree & Maher, 2009; Jiang, 2008), which is cash flow from operations scaled by total assets, controlling for firm liquidity. *CFO* is expected to have a positive relationship with *RATING* and a negative relationship with *YLDSPREAD* because firms with greater cash flow are more likely to repay debt. We also controlled for firm leverage (*LEV*) measured as total debt divided by total assets. The greater the leverage, the higher the probability of default, so we predict *LEV* to be positively associated with *YLDSPREAD* and negatively associated with *RATING*. *ASSETS* controls for firms' size and is the natural logarithm of total assets. Since issuers with greater assets are perceived to be less risky, we predict that *ASSETS* will be positively linked to *RATING* and negatively related to *YLDSPREAD*. In addition, we included *PPE*, which is gross property, plant, and equipment scaled by total assets, to account for differences in firms' capital intensity (Liu et al., 2010; Liu & Jiraporn, 2010; Crabtree & Maher, 2009). *ROA\_D* is the standard deviation of return on assets (net income/total assets) for the past five years (Crabtree et al., 2014). It controls for firms' normal profitability and the impact of extraordinary items on the growth of the firm, thereby measuring the volatility of earnings. We further control for firm risk by measuring the annualized standard deviation of daily stock returns for the past year (*RET\_D*) (Anderson et al., 2004; Jiang, 2008). Finally, we adopted a control for firms' corporate governance, measuring the quality of external auditing by adopting the binary variable *BIG4*, which equals 1 if the auditor is a Big 4 audit company, and 0 otherwise (Becker et al., 1998; Teoh & Wong, 1993). We measured all firm-control variables at the fiscal year-end prior to the bond issue to ensure that the information is publicly available to bondholders at the time of the issue.

## 5. SAMPLE SELECTION AND DESCRIPTION

We examined a sample of listed companies that restated their financial statements over the period between 2006 and 2014. We begin the sample collection procedure by including all listed firms from countries that mandatorily adopted IFRS as of 31/12/2005, excluding banks (Standard Industrial Classification codes 6000-6199), in line with previous work (Stanley & Sharma, 2011; Perols & Lougee,

---

<sup>10</sup> To avoid redundancy, we do not include *COUNTRY* in Equations (2) and (4), since *YLDSPREAD* already controls for macroeconomic factors (Ge & Liu, 2015; Ge & Kim, 2014) and is a direct measure of a firm's incremental cost of public debt

2011). Similar to Daske et al. (2008), the countries involved in our study are Australia, Austria, Belgium, the Czech Republic, Denmark, Finland, France, Germany, Greece, Hong Kong, Hungary, Ireland, Italy, Luxemburg, the Netherlands, Norway, the Philippines, Poland, Portugal, Singapore, South Africa, Spain, Sweden, Switzerland, the United Kingdom and Venezuela. We used the Datastream database from Thompson Reuters to identify firms that restated annual financial statements prepared in accordance with the IFRS. We manually collected information about the direction of restatement, the number of errors and the number of years restated using the annual reports available both on corporate websites and in the Osiris database provided by Bureau van Dijk. We also complemented these data by collecting from other sources, e.g., we gathered information about auditors from the Eikon database from Thomson Reuters, bond data from the Deal Analytics app, also provided by Eikon, and the remaining data came from Datastream. We found 362 restating firms and restricted the final sample to restating firms with at least one bond issue between 2006 and 2015. After merging data sources and dropping observations with missing values, our final sample contains 133 restatements from 28 firms.<sup>11</sup> The 28 issuing firm sample does not differ in error severity or general firm characteristics from the 334 non-issuing firms sample, as documented by a test of equality in means. This test is omitted here for brevity, but it is available from the authors on demand. Table 1 presents the descriptive statistics for our observations.

**Table 1. Descriptive Statistics**

Variables	Min.	Median	Mean	Max.	N
RATINGS	8.000	15.00	14.90	18.00	133
YLDSPREAD	1.000	161.0	205.8	858.0	133
SEVERITY	-1.414	0.451	0.408	2.825	133
RESTATE	0.000	0.000	0.443	1.000	133
SUB	0.000	0.000	0.195	1.000	133
SIZE\$	90.68	600.0	692.6	2,398	133
MATURITY\$	2	9	21	100	133
COUNTRY	11.00	20.00	18.74	20.00	133
INCOME	-0.002	0.042	0.046	0.117	133
CFO	-0.014	0.064	0.062	0.156	133
LEV	0.014	0.247	0.269	0.689	133
ASSETS\$	913.2	47,930	126,800	761,800	133
PPE	0.001	0.421	0.422	1.056	133

(Sengupta, 1998; Jiang, 2008).

<sup>11</sup> Our sample size is comparable with those used in previous studies addressing restatements. For example, Hitz et al. (2012) analyzed a sample of 45 observations, Nahar Abdullah et al. (2010) included 31 firm-years of companies that restated their annual reports, DeFond & Jiambalvo (1991) examined 41 firm-years of companies that overstated prior year earnings, and Bardos & Zaiats (2012) found that 28 out of 436 US restating firms issued bonds in the restatement period, and their number of debt issuances (128) is similar to our sample (133).

ROA_DEV	0.001	0.012	0.018	0.063	133
RET_DEV	0.119	0.264	0.309	1.125	133
BIG4	0.000	1.000	0.939	1.000	133

§ Data before logarithmic transformation

§§ Data in million €

On average, 44% of the bonds in our sample were issued in the aftermath of restatements ( $mean(RESTATE)=0.44$ ). The average credit rating ( $RATING$ ) for the observations is 14.9, ranging from 8 to 18. As expected, the comparable sovereign credit rating ( $COUNTRY$ ) is slightly higher, being on average 18.7 and ranging from 11 to 20. The average bond yield spread ( $YLDSPREAD$ ) is approximately 206. This value is very similar to values found in previous research, e.g., 224 found by Liu et al. (2010), 226 by Ge and Kim (2014), and 247 by Mansi et al. (2004). Almost 20% of bond issues are subordinated ( $mean(SUB)=0.20$ ). The average offering amount ( $SIZE$ ) is € 693 million, with an average maturity of 21 years. On average, the firms in our sample have low productivity ( $mean(INCOME)=0.04$ ), low liquidity ( $mean(CFO)=0.06$ ), and are highly indebted ( $mean(LEV)=0.26$ ). There is considerable variation in firm size, as average total assets is approximately € 127 million, whereas the median total assets is less than 48 € million, and more than 40% of assets is invested in property, plants and equipment ( $mean(PPE)=0.42$ ). The activity of these firms slightly deviates from the normal flows ( $mean(ROA\_D)=0.01$ ), and the stock market is fairly volatile, as the standard deviation of the daily stock returns over the year is approximately 30% ( $mean(RET\_D)=0.30$ ). Finally, more than 93% of the restated annual statements were controlled by a Big 4 audit company ( $mean(BIG4)=0.93$ ).

Table 2 provides the Pearson correlations of the variables used in the models.

**Table 2. Pearson's correlations**

Variables	1. RATING	2.	3.	4.	5.	6.	7.	8.	9.	10.	11.	12.	13.	14.	15.
2.YLDSPRE AD	-0.67														
3. SEVERITY	-0.10	0.07													
4. RESTATE	-0.36	0.22	-												
5. SUB	-0.02	0.25	-	0.06											
6. SIZE	-0.01	0.01	0.23	0.03	0.18										
7. MATURITY	-0.04	0.12	-	0.01	0.76	0.11									
8.	-0.21	0.30	-	-	-	-	-								

COUNTRY		0.17	0.12	0.03	0.03	0.03									
9. INCOME	-0.03	-	0.18	-	-	0.08	-	-							
		0.11		0.07	0.43		0.39	0.01							
10. CFO	0.01	-	0.35	-	-	0.05	-	-	0.76						
		0.13		0.17	0.46		0.36	0.04							
11. LEV	-0.38	0.15	0.39	0.01	-	0.09	-	0.16	0.46	0.55					
				0.46		0.31									
12. ASSETS	0.46	-	0.13	-	0.46	0.24	0.38	-	-	-	-				
		0.20		0.11				0.14	0.45	0.33	0.52				
13. PPE	-0.27	0.07	0.43	0.11	-	0.07	-	-	0.50	0.63	0.73	-			
				0.45		0.39	0.15					0.48			
14. ROA_DEV	-0.51	0.15	0.29	0.02	-	0.08	-	0.03	0.52	0.41	0.52	-	0.46		
				0.36		0.30						0.57			
15. RET_DEV	-0.23	0.26	0.07	-	-	0.11	-	0.20	0.10	0.09	0.14	-	0.08	0.15	
				0.04	0.09		0.03					0.04			
16. BIG4	0.12	0.10	-	-	0.12	-	0.08	0.01	-	-	-	0.16	-	-	-
			0.02	0.03	0.05				0.16	0.21	0.08		0.13	0.27	0.06

Significant correlations ( $p < 0.10$ ) are *bolded*.

As expected, *RESTATE* is negatively and significantly related to *RATING* and positively and significantly correlated with *YLDSREAD* ( $\rho = 0.22$ ). This provides initial evidence that rating agencies and bondholders perceive accounting restatements negatively. Moreover, *RESTATE* is significantly and negatively correlated with *CFO*, which proxies firms' liquidity ( $\rho = -0.17$ ). As expected, *RATING* is correlated with *ASSETS*, *LEV*, *ROA\_D*, *RET\_D*, *PPE* and *COUNTRY*, higher bond ratings being associated respectively with larger firm size ( $\rho = 0.46$ ), higher indebtedness ( $\rho = -0.38$ ), lower volatility in net income ( $\rho = -0.51$ ), lower volatility in daily stock returns ( $\rho = -0.23$ ), higher flexibility in asset structure ( $\rho = -0.27$ ), and lower sovereign risk premiums ( $\rho = -0.21$ ). Last, consistent with our predictions, *RATING* correlates highly and negatively with *YLDSREAD* ( $\rho = -0.67$ ). Finally, also as expected, *YLDSREAD* is positively and significantly correlated to the volatility in stock returns, measured by *RET\_D* ( $\rho = 0.26$ ); to *COUNTRY* ( $\rho = 0.30$ ), evidencing sovereign risk premiums; to the dummy *SUB* ( $\rho = 0.25$ ), indicating a subordinated issue; to *LEV* ( $\rho = 0.15$ ), controlling for debt-dependence; and to *ROA\_D* ( $\rho = 0.15$ ); but it is negatively and significantly correlated to the size of the firm as measured by *ASSETS* ( $\rho = -0.20$ ).

## 6. RESULTS

Table 3 reports the results of the regression analysis.

**Table 3. The impact of restatement on the bond market**

Variable	Coef.	(1)	(2)	(3)	(4)
		RATING	RATING	YLDSPREAD	YLDSPREAD
RESTATE	$\beta_1$	-1.06*	-1.04	56.77**	43.79***
		(-1.76)	(-1.57)	(2.53)	(2.66)
ORTH	$\beta_2$	-	-	-975.29***	-908.59***
				(-6.10)	(6.79)
SEVERITY	$\beta_3$	-	-0.49	-	2.62
			(-1.62)		(0.27)
SEVERITY*RESTATE	$\beta_4$	-	-0.43	-	39.55***
			(-0.92)		(2.81)
SUB	$\gamma_1$	-3.24**	-3.59***	226.06***	224.81***
		(-2.46)	(-2.68)	(3.65)	(3.78)
SIZE	$\gamma_2$	0.01	0.06	-14.88	-12.91
		(0.30)	(0.17)	(-1.48)	(-1.21)
MATURITY	$\gamma_3$	-0.04	-0.12	38.67*	-32.69
		(-0.06)	(-0.19)	(1.91)	(-1.60)
COUNTRY	$\gamma_4$	13.20***	14.61***	-	-
		(4.06)	(3.37)		
INCOME	$\gamma_5$	56.21***	57.41***	-1100.7	-1201.81*
		(3.71)	(3.77)	(-1.58)	(-1.81)
CFO	$\gamma_6$	4.70	3.49	367.09	505.71
		(0.54)	(0.38)	(1.02)	(1.37)
LEV	$\gamma_7$	-7.55***	-6.34***	254.81**	207.48*
		(-3.25)	(-2.61)	(2.34)	(1.87)
ASSETS	$\gamma_8$	0.49	0.96*	-25.74**	-41.70***
		(0.94)	(1.83)	(-2.18)	(-2.86)
PPE	$\gamma_9$	-0.26	0.31	13.72	-21.57
		(-0.18)	(0.22)	(0.27)	(-0.44)
ROA_D	$\gamma_{10}$	-90.83**	-79.68***	1125.0	780.29
		(-2.54)	(-2.70)	(1.46)	(1.03)
RET_D	$\gamma_{11}$	-3.83	-3.79	269.27***	265.96***
		(-1.50)	(-1.50)	(9.71)	(8.45)
BIG 4	$\gamma_{12}$	1.56**	1.84**	65.74***	59.58***
		(2.41)	(2.12)	(2.99)	(2.67)
Industry dummies		Included	Included	Included	Included
Adj-R2		32.59	34.53	62.03	64.15

Observations	133	133	133	133
--------------	-----	-----	-----	-----

**Note:** This table presents respectively the estimates of: Equations (1) and (2) in Columns (1) and (3), and Equations (3) and (4) in Columns (2) and (4). Adj-R<sup>2</sup> is McFadden's Pseudo-R<sup>2</sup> in columns (1) and (2).

*Estimates are corrected for firm clustering and for heteroscedasticity and serial correlation (Huber White robust standard errors). The constant is omitted.*

*\*, \*\*, and \*\*\* denote statistical significance respectively at the 0.10, 0.05 and 0.01 levels.*

Column (1) shows the effect of restatements on corporate bond ratings, as described in Equation (1).<sup>12</sup> We find a significant negative impact of *RESTATE* on *RATING* ( $\beta_1 < 0$ ;  $p < 0.10$ ). This relationship validates Hypothesis 1, supporting the expectation that credit rating agencies perceive restatement announcements as a factor that reduces expected earnings and future cash flows, thereby increasing credit risk. All control variables have the expected signs for their coefficients. We find that *SUB* ( $\gamma_1 < 0$ ;  $p < 0.05$ ), *LEV* ( $\gamma_7 < 0$ ;  $p < 0.01$ ), and *ROA\_D* ( $\gamma_{10} < 0$ ;  $p < 0.05$ ) affect *RATING* negatively, whereas *INCOME* ( $\gamma_5 > 0$ ;  $p < 0.01$ ) has a positive impact. Consequently, consistent with our expectations, we find that more profitable firms receive better credit ratings, whereas highly leveraged firms and more risky and volatile investments receive lower ratings. Also *COUNTRY* is positively and significantly linked with *RATING* ( $\gamma_4 > 0$ ;  $p < 0.01$ ), documenting that firms operating in low risk countries enjoy higher corporate bond ratings. Finally, corporate governance control positively impacts *RATING* ( $\gamma_{12} > 0$ ;  $p < 0.05$ ), supporting that firms supervised by a Big 4 audit company receive higher ratings compared to counterparts. Overall, the results for our control variables support the findings of prior studies (Crabtree et al., 2014; Liu & Jiraporn, 2010).

Column (3) of Table 3 lists the results of Equation (2), studying the impact of the restatement on the bond yield spreads.

The coefficient of *RESTATE* is positive and significant ( $\beta_1 > 0$ ;  $p < 0.05$ ), suggesting that bondholders perceive restatements as a credit risk-increasing factor and thus require higher risk premiums. We document that after the restatement announcement, the yield spreads increase on average by nearly 57 basis points. As expected, *SUB* ( $\gamma_1 > 0$ ;  $p < 0.01$ ) and *MATURITY* ( $\gamma_3 > 0$ ;  $p < 0.10$ ) are positively associated with *YLDSPREAD*. In regard to firm-level controls, the coefficients of *LEV* ( $\gamma_7 > 0$ ;  $p < 0.05$ ) and *RET\_D* ( $\gamma_{11} > 0.01$ ;  $p < 0.01$ ) are positive and significant, showing that more highly leveraged and more volatile firms pay higher bond yield spreads. Finally, *ASSETS* is negative and significantly

<sup>12</sup> The database in this study is composed of bonds issued by a single firm in the same fiscal year; this violates the assumption of independence in the residuals, so the standard errors from the ordinary least squares procedures may be biased. To circumvent this problem and avoid spurious correlation, we used Hierarchical Linear Models (HLM) for robustness. HLM use the maximum likelihood method to estimate coefficients and are widely used in social science research to address potential

associated with *YLDSPREAD* ( $\gamma_s < 0$ ;  $p < 0.05$ ), suggesting that smaller firms issue bonds at a higher cost. Overall, the results for these control variables are consistent with those from prior studies (Ge and Liu, 2015; Liu et al., 2010).

Columns (2) and (4) in Table 3 show the results of the analysis from Equations (3) and (4), respectively, studying the effect of the severity of restatements on bond ratings and bond yield spreads. While the interaction term *SEVERITY\*RESTATE* is not significant when *RATING* is the dependent variable, it positively and significantly influences yield spreads, indicating that firms with more severe errors suffer an approximately 40% higher increase in risk premiums after the restatement. These findings partly validate our prediction under Hypothesis 3, showing that the market is more efficient than financial analysts when they measure the severity of a restatement and downgrade their opinions about investment in restating firms.

The *Pseudo-R*<sup>2</sup> of Equations (1) and (3) is approximately 30%; the *Adjusted-R*<sup>2</sup> of Equations (2) and (4) is greater than 60%; these results support the overall satisfactory empirical explanatory power of the adopted models.

### 6.1 Corroborating analysis

In line with previous works (Albring et al., 2013; Chen et al., 2013), we corroborated the empirical findings by checking whether the results hold when comparing restating firms to a matched sample of non-restating firms. We used a pair-matched sample design, where each restating firm is matched by country, stock exchange, industry and size to a control firm that made no restatement. We regressed the sample, which included both the restatement and the pair-matched firms, and included the variable *PAIR-MATCHED*, an indicator that equals 1 for the bonds issued by the pair-matched sample and 0 for bonds issued by the restating firms. The results are displayed in Table 4.

**Table 4. Robustness test on a pair-matched sample**

Variable	Coef.	(1)	(2)	(3)	(4)
		RATING	RATING	YLDSPREAD	YLDSPREAD
RESTATE	$\beta_1$	-1.22*** (-2.96)	-1.21*** (-3.07)	49.58** (2.00)	40.68** (2.47)
ORTH	$\beta_2$	-	-	-614.90*** (-7.72)	-597.07*** (-8.03)
SEVERITY	$\beta_3$	-	- 0.39* (-1.84)	-	5.71 (0.60)
SEVERITY*RESTATE	$\beta_4$	-	-0.19	-	38.13**

multilevel observation problems (Seibert et al., 2004). The results are consistent with those displayed in Table 3 and are unreported here for brevity; they are available from the authors on request.



			(-0.70)		(2.23)
PAIR MATCHED	$\beta_5$	-0.61	-0.62	22.92	27.09
		(-0.75)	(-0.82)	(1.20)	(1.44)
SUB	$\gamma_1$	-2.58***	-2.13***	282.47***	276.32***
		(-2.92)	(-2.76)	(5.20)	(5.52)
SIZE	$\gamma_2$	0.27	0.18	-19.84	-20.76*
		(0.96)	(0.56)	(-1.61)	(-1.74)
MATURITY	$\gamma_3$	-0.08	-0.01	-31.94*	-27.15
		(-0.23)	(-0.04)	(-1.69)	(-1.52)
COUNTRY	$\gamma_4$	4.58***	4.21**	-	-
		(2.97)	(2.36)		
INCOME	$\gamma_5$	12.71	15.86**	-546.28*	-641.38**
		(1.55)	(2.48)	(-1.96)	(-2.18)
CFO	$\gamma_6$	6.68	-3.32	101.92	167.65
		(0.77)	(-0.40)	(0.33)	(0.56)
LEV	$\gamma_7$	-5.22**	-4.10*	213.92***	166.81**
		(-1.99)	(-1.83)	(2.67)	(2.12)
ASSETS	$\gamma_8$	0.60**	0.99***	-29.21***	-36.95***
		(2.39)	(4.49)	(-3.24)	(-4.06)
PPE	$\gamma_9$	-0.25	0.47	-16.52	-30.76
		(-0.21)	(0.46)	(-0.45)	(-0.85)
ROA_D	$\gamma_{10}$	-21.06	-15.95	901.67**	858.05**
		(-1.41)	(-1.16)	(2.28)	(2.10)
RET_D	$\gamma_{11}$	-2.27**	-2.54**	302.08***	288.85***
		(-2.53)	(-2.42)	(7.97)	(6.76)
BIG 4	$\gamma_{12}$	0.31	0.33	82.61***	83.73***
		(0.56)	(0.73)	(3.53)	(3.34)
Industry dummies		Included	Included	Included	Included
Adj-R2		17.60	19.69	57.05	58.58
Observations		268	268	268	268

**Note:** This table presents the impact of restatement on the bond ratings and bond yield spreads in restating firms compared with a non-restating pair-matched sample. Respectively the estimates of Equations (1) and (2) are displayed in Columns (1) and (3), and Equations (3) and (4) in Columns (2) and (4). Adj-R<sup>2</sup> is McFadden's Pseudo-R<sup>2</sup> in columns (1) and (2).

*Estimates are corrected for firm clustering and for heteroscedasticity and serial correlation (Huber White robust standard errors). The constant is omitted.*

*\*, \*\*, and \*\*\* denote statistical significance respectively at the 0.10, 0.05 and 0.01 levels.*

The main results ( $\beta_1$ ) remain consistent and in some cases become more significant, although the *PAIR-MATCHED* indicator has no statistical relevance. This unexpected result shows that the pair-matched sample is considered to be similar to the restating firms unless the restatement event occurs, providing additional evidence that the ratings agencies do not anticipate the restatements. Apparently, there is no impact from restatements on the evaluation of bond issues until the restatement occurs. Restating and non-restating firms similarly affect both the bond rating and the bond yield spread; nevertheless, in the aftermath of a restatement event, the agencies' ratings drop, and the costs of the bonds rise with a coefficient equal to 56.77.

## 7. DISCUSSION AND CONCLUSIONS

Several studies have documented that restatements have serious consequences on the equity and private loans markets, but no study to date has analyzed the economic consequences of restatements on the bond market. This paper adds to the accounting literature by empirically demonstrating how restatements affect the decisions of the rating agencies and bond market participants. After firms announce restatements, Graham et al. (2008) found that private loan spreads increase by approximately one half (49%); we found that public loan spreads increase by approximately 57 basis points. Conclusively, restatement leads to a downgrading of bond ratings and a rise in the bond yield spreads, suggesting that firms committing an accounting error(s) suffer a reduction in firm value and an increase in the cost of public debt capital. We further find that firms with greater restatement severity are also associated with a greater increase in bond yield spread, demonstrating that the materiality of restatement aggravates the rise of risk premiums. Surprisingly, we also documented that the rating agencies price the restatement *per se* and do not appear to care about the severity of the restatement. Hence, we can state that the market is more efficient than the rating agencies in evaluating the severity of the error that caused the restatement event.

From a practical perspective, our study has implications for the accounting choices of CEOs and CFOs and for their decisions about the capital structure of the firm. Given our findings that restatements are expensively priced by both rating agencies and investors, they should consider the risk of issuing bonds at an extra cost in the aftermath of a restatement.

## REFERENCES

- Albring, S. M., Huang, S. X., Pereira, R., & Xu, X. (2013). The effects of accounting restatements on firm growth. *Journal of Accounting and Public Policy*, 32(5), 357-376.
- Anderson, R. C., Mansi, S. A., & Reeb, D. M. (2004). Board characteristics, accounting report integrity, and the cost of debt. *Journal of Accounting and Economics*, 37(3), 315-342.
- Anderson, K. and T. Yohn. (2002). The Effect of 10-K Restatements on Firm Value, Information Asymmetries, and Investors' Reliance on Earnings. Working paper, Georgetown University.

- Bae, K. H., & Goyal, V. K. (2009). Creditor rights, enforcement, and bank loans. *The Journal of Finance*, 64(2), 823-860.
- Bardos, K. S., & Mishra, D. (2014). Financial restatements, litigation and implied cost of equity. *Applied Financial Economics*, 24(1), 51-71.
- Bardos, K. S., & Zaiats, N. (2012). Equity and debt issuance by firms violating GAAP. *Accounting and Finance*, 52(s1), 77-108.
- Bardos, K. S., Golec, J., & Harding, J. P. (2013). Litigation risk and market reaction to restatements. *Journal of Financial Research*, 36(1), 19-42.
- Becker, C., DeFond, M., Jiambalvo, J., & Subramanyam, K.R. (1998). The effect of audit quality on earnings management. *Contemporary Accounting Research*, 15(1), 1-24.
- Böcking, H. J., Gros, M., & Worret, D. (2015). Enforcement of accounting standards: how effective is the German two-tier system in detecting earnings management? *Review of Managerial Science*, 9(3), 431-485.
- Burks, J. J. (2010). Disciplinary measures in response to restatements after Sarbanes–Oxley. *Journal of Accounting and Public Policy*, 29(3), 195-225.
- Chen, X., Cheng, Q., & Lo, A. K. (2013). Accounting Restatements and External Financing Choices. *Contemporary Accounting Research*, 30(2), 750-779.
- Chen, X., Cheng, Q., & Lo, A. K. (2014). Is the decline in the information content of earnings following restatements short-lived?. *The Accounting Review*, 89(1), 177-207.
- Chung, J., & McCracken, S. (2014). Understanding the restatement process. *Accounting Perspectives*, 13(4), 253-281.
- Crabtree, A., & Maher, J. J. (2009). The influence of differences in taxable income and book income on the bond credit market. *Journal of the American Taxation Association*, 31(1), 75-99.
- Crabtree, A., Maher, J. J., & Wan, H. (2014). New debt issues and earnings management. *Advances in Accounting*, 30(1), 116-127.
- Creditreform Rating AG (2015). Corporate bonds in Europe 2005-2014. Available at [http://www.creditreform-rating.de/fileadmin/user\\_upload/creditreform-rating.de/Dokumente/Fachpublikationen/Creditreform\\_Rating\\_Corporate\\_Bonds\\_in\\_Europe.pdf](http://www.creditreform-rating.de/fileadmin/user_upload/creditreform-rating.de/Dokumente/Fachpublikationen/Creditreform_Rating_Corporate_Bonds_in_Europe.pdf)
- Daske, H., Hail, L., Leuz, C., & Verdi, R. (2008). Mandatory IFRS reporting around the world: Early evidence on the economic consequences. *Journal of Accounting Research*, 46(5), 1085-1142.
- Dechow, P. M., Sloan, R. G., & Sweeney, A. P. (1996). Causes and consequences of earnings manipulation: An analysis of firms subject to enforcement actions by the SEC. *Contemporary Accounting Research*, 13(1), 1-36.
- Dechow, P., Ge, W., & Schrand, C. (2010). Understanding earnings quality: A review of the proxies, their determinants and their consequences. *Journal of Accounting and Economics*, 50(2), 344-401.
- DeFond, M., & Zhang, J. (2014). A review of archival auditing research. *Journal of Accounting and Economics*, 58(2), 275-326.
- Drake, M. S., Myers, L. A., Scholz, S., & Sharp, N. Y. (2015). Short selling around restatement announcements: When do bears pounce? *Journal of Accounting, Auditing & Finance*, 30(2), 218-245.
- Feldmann, D. A., Read, W. J., & Abdolmohammadi, M. J. (2009). Financial restatements, audit fees, and the moderating effect of CFO turnover. *Auditing: A Journal of Practice & Theory*, 28(1), 205-223.
- Firth, M., Rui, O. M., & Wu, W. (2011). Cooking the books: Recipes and costs of falsified financial statements in China. *Journal of Corporate Finance*, 17(2), 371-390.
- Francis, J. R. (2011). A framework for understanding and researching audit quality. *Auditing: A Journal of Practice & Theory*, 30(2), 125-152.
- Ge, W., & Kim, J. B. (2014). Real earnings management and the cost of new corporate bonds. *Journal of Business Research*, 67(4), 641-647.
- Ge, W., & Liu, M. (2015). Corporate social responsibility and the cost of corporate bonds. *Journal of Accounting and Public Policy*, 34(6), 597-624.
- Graham, J. R., Li, S., & Qiu, J. (2008). Corporate misreporting and bank loan contracting. *Journal of Financial Economics*, 89(1), 44-61.
- Griffin, P. A. (2003). A league of their own? Financial analysts' responses to restatements and corrective disclosures. *Journal of Accounting, Auditing and Finance*, 18(4), 479-517.
- Hennes, K. M., Leone, A. J., & Miller, B. P. (2008). The importance of distinguishing errors from irregularities in restatement research: The case of restatements and CEO/CFO turnover. *The Accounting Review*, 83(6), 1487-1519.
- Hennes, K. M., Leone, A. J., & Miller, B. P. (2014). Determinants and market consequences of auditor dismissals after accounting restatements. *The Accounting Review*, 89(3), 1051-1082.
- Hitz, J.M., Ernstberger, J., & Stich, M. (2012). Enforcement of accounting standards in Europe: Capital-market-based evidence for the two-tier mechanism in Germany. *European Accounting Review*, 21(2), 253-281.

- Hribar, P., & Jenkins, N. T. (2004). The effect of accounting restatements on earnings revisions and the estimated cost of capital. *Review of Accounting Studies*, 9(2-3), 337-356.
- Huang, Y., & Scholz, S. (2012). Evidence on the association between financial restatements and auditor resignations. *Accounting Horizons*, 26(3), 439-464.
- IASB – International Accounting Standards Board (2005). International Accounting Standard (IAS) no. 8 – Accounting Policies, Changes in Accounting Estimates and Errors, December 2005: London.
- Jensen, M. C. (1986). Agency cost of free cash flow, corporate finance, and takeovers. *American Economic Review*, 76: 323–329.
- Jiang, H., Habib, A., & Zhou, D. (2015). Accounting restatements and audit quality in China. *Advances in Accounting*, 31(1), 125-135.
- Jiang, J. (2008). Beating earnings benchmarks and the cost of debt. *The Accounting Review*, 83(2), 377-416.
- Kaszniak, R. (2004). Discussion of “The effect of accounting restatements on earnings revisions and the estimated cost of capital”. *Review of Accounting Studies*, 9(2-3), 357–367.
- Karpoff, J. M., Lee, D. S., & Martin, G. S. (2008a). The consequences to managers for financial misrepresentation. *Journal of Financial Economics*, 88(2), 193-215.
- Karpoff, J. M., Lee, D. S., & Martin, G. S. (2008b). The cost to firms of cooking the books. *Journal of Financial and Quantitative Analysis*, 43(3), 581-612.
- Kräussl, R. (2005). Do credit rating agencies add to the dynamics of emerging market crises?. *Journal of Financial Stability*, 1(3), 355-385.
- Kravet, T., & Shevlin, T. (2010). Accounting restatements and information risk. *Review of Accounting Studies*, 15(2), 264-294.
- Liu, Y., & Jiraporn, P. (2010). The effect of CEO power on bond ratings and yields. *Journal of Empirical Finance*, 17(4), 744-762.
- Liu, Y., Ning, Y., & Davidson III, W. N. (2010). Earnings management surrounding new debt issues. *The Financial Review*, 45(3), 659-681.
- Lu, C. W., Chen, T. K., & Liao, H. H. (2010). Information uncertainty, information asymmetry and corporate bond yield spreads. *Journal of Banking & Finance*, 34(9), 2265-2279.
- Ma, C., Zhang, J., & Yang, B. (2015). Financial restatement and auditor dismissal. *China Journal of Accounting Studies*, 3(3), 209-229.
- Mansi, S. A., Maxwell, W. F., & Miller, D. P. (2004). Does auditor quality and tenure matter to investors? Evidence from the bond market. *Journal of Accounting Research*, 42(4), 755-793.
- Mansi, S. A., Maxwell, W. F., & Miller, D. P. (2011). Analyst forecast characteristics and the cost of debt. *Review of Accounting Studies*, 16(1), 116-142.
- Palmrose, Z. V., & Scholz, S. (2004). The accounting causes and legal consequences of non-GAAP reporting: evidence from restatements. *Contemporary Accounting Research*, 21(1), 139-180.
- Palmrose, Z. V., Richardson, V. J., & Scholz, S. (2004). Determinants of market reactions to restatement announcements. *Journal of Accounting and Economics*, 37(1), 59-89.
- Park, J. C., & Wu, Q. (2009). Financial restatements, cost of debt and information spillover: Evidence from the secondary loan market. *Journal of Business Finance & Accounting*, 36(9-10), 1117-1147.
- Perols, J. L., & Lougee, B. A. (2011). The relation between earnings management and financial statement fraud. *Advances in Accounting*, 27(1), 39-53.
- Seibert, S. E., Silver, S. R., & Randolph, W. A. (2004). Taking empowerment to the next level: A multiple-level model of empowerment, performance, and satisfaction. *Academy of Management Journal*, 47(3), 332-349.
- Sengupta, P. (1998). Corporate disclosure quality and the cost of debt. *The Accounting Review*, 73(4), 459-474.
- Stanley, B. W., & Sharma, V. I. (2011). To cheat or not to cheat how bank debt influences the decision to misreport. *Journal of Accounting, Auditing & Finance*, 26(2), 383-414.
- Srinivasan, S. (2005). Consequences of financial reporting failure for outside directors: Evidence from accounting restatements and audit committee members. *Journal of Accounting Research*, 43(2), 291-334.
- Standard & Poor's Ratings Services (2014). Guide to credit rating essentials. New York, NY: Standard & Poor's
- Strohmeier, M. (2014). Enforcement Releases, Firm Characteristics, and Earnings Quality: Insights from Germany's Two-tiered Enforcement System. *Journal of International Financial Management & Accounting*, 25(3), 271-304.
- Teoh, S. H., & Wong, T. J. (1993). Perceived auditor quality and the earnings response coefficient. *The Accounting Review*, 68(2), 346-366.
- Tendulkar, R., & Hancock, G. (2014). Corporate Bond Markets: A Global Perspective (Vol. 1). Staff Working Paper of the IOSCO Research Department. IOSCO. Available at <http://www.iosco.org/research/pdf/swp/SW4-Corporate-Bond-Markets-Vol-1-A-global-perspective.pdf>

- White, H. (1980). A heteroskedasticity-consistent covariance matrix estimator and a direct test for heteroskedasticity. *Econometrica*, 48(4), 817-838.
- Wiedman, C. I., & Hendricks, K. B. (2013). Firm accrual quality following restatements: A signaling view. *Journal of Business Finance & Accounting*, 40(9-10), 1095-1125.
- Wilson, W. M. (2008). An empirical analysis of the decline in the information content of earnings following restatements. *The Accounting Review*, 83(2), 519-548.

## APPLYING SECI MODEL TO TRANSFER ORGANIZATIONAL MEMORY THROUGH CORPORATE MUSEUMS

Matricano, Diego

Department of Management, Università degli Studi della Campania "Luigi Vanvitelli", Italy

### ABSTRACT

The present paper starts from the idea that companies implementing corporate museums need to share and transfer organizational memory in a proper way in order to strengthen their brand identity. From the review of dedicated literature, in fact, it results that the above companies have to face some difficulties dealing with the selection of the memory to be transmitted and with the way customers assimilate it.

By reflecting on the topic, it arises the need for searching for a theoretical model able to frame this process. The SECI model, proposed in reference to knowledge management, seems very useful in this vein. The phases of socialization, externalization, combination and internalization seem to describe the process through which companies can define the organizational memory they want to share and transfer through corporate museums and visitors/customers can internalize it.

Despite some criticalities that necessarily emerge – and that cannot be ignored – when referring an existing theoretical model to a new topic, this paper tries to get corporate museums halfway between museology and management literature.

*Keywords: corporate museums; brand identity; memory; SECI model; knowledge management*

### INTRODUCTION

The fact that companies are more and more involved in the implementation of corporate museums in order to strengthen their corporate identity is rather evident (Poulsson and Kale, 2004; Prahalad and Ramaswamy, 2004; Vargo and Lusch, 2004a, 2004b; Lusch and Vargo, 2006; Payne et al., 2009; Tynan and McKechnie, 2009).

However, despite the growth of this phenomenon, the way companies should manage these museums still needs to be unfolded. Corporate museums, in fact, still lie in the field of museology even if – as a matter of fact – they should move closer to the field of management since they are meant as a marketing instrument (Danilov, 1992; Amari, 1997; Griffiths, 1999; Gilodi, 2002; Nissley and Casey, 2002; Stigliani and Ravasi, 2007; Montella, 2010, 2014; Bonti, 2014; Piatkowska, 2014). This passage, however, is not effortless. Corporate managers, exhibitions directors and curators, in fact, need to

manage the organizational memory (Nissley and Casey, 2002) to be shared with visitors/customers in a proper way in order to avoid possible mistakes and strengthen corporate identity.

The present paper starts from this emerging need. Corporate managers (who hold the organizational memory to be transferred) and exhibitions directors and curators (who need to find the best way to transfer it from the company to visitors/customers) aim to remind the visitors/customers of the information to which they are exposed (selective attention), to reconcile information with what they already believe (selective distortion), and to remind them of the good characteristics of the brand they like and to forget good characteristics of other brands (selective retention), as suggested by Kotler and Scott (1993). This aim is very challenging for corporate managers and exhibitions directors and curators since the memory to be transmitted needs to fit with the brand identity (Nissley and Casey, 2002). It is important, then, that corporate managers select the memory to be transmitted, share it with exhibition directors and curators who, in turn, transfer it to visitors/customers during the exhibition. If visitors/customers assimilate it by paying selective attention and by putting into practice selective retention, then companies can feel satisfied; if visitors assimilate it by paying selective distortion, then companies are not going to be fulfilled. According to the above, corporate managers, exhibitions directors and curators need to refer to a theoretical model able to transfer organizational memory in a proper way.

In reference to the search of theoretical models that can be used by corporate managers and exhibitions directors and curators, the above passages seem to recall a well-known theoretical model proposed in the field of knowledge management: the SECI model (Nonaka and Takeuchi, 1995). This model assumes that knowledge creation takes place through four phases: socialization (tacit knowledge is created from tacit knowledge); externalization (explicit knowledge is created from tacit knowledge); combination (explicit knowledge is created from explicit knowledge); and internalization (tacit knowledge is created from explicit knowledge). By assuming that the memory that companies aim to transfer to visitors/customers can be treated and managed like knowledge – they both are intangible resources – it seems that corporate managers and exhibitions directors and curators can leverage on the SECI model as well.

According to the above, the structure of the paper is the following. In the section “Literature review”, both the literatures focused on corporate museums and organizational memory and on the SECI model are reviewed. After this, in the section “Applying SECI model when implementing corporate museums”, the four phases of the SECI model are recalled and referred to the organizational memory that companies want to transfer through the implementation of corporate museums. In the section “Limitations, conclusions and further developments”, after highlighting the main limitations of this

study, some conclusions are drawn and some further developments, which need to be enlarged and enriched by comments and suggestions of other management scholars, are hypothesized.

## LITERATURE REVIEW

### *Corporate museums and organizational memory*

According to Bonti (2014), corporate museums are not passive collections of artifacts belonging to the organizations. On the contrary, they are valuable marketing tools that are usually situated close to the company's headquarters or factories and run by the company itself. As such, they can offer relevant, novel, surprising, informative and engaging interactions and experiences to customers (Poulsson and Kale, 2004) and they are expected to be marketing tools able to transfer organizational memory (Danilov, 1992; Katriel, 1994; Nissley and Casey, 2002). Broadly speaking, organizational memory can be defined as the set of company's values that corporate managers want to recall and transfer to customers.

The final aim that corporate managers and exhibition directors and curators try to pursue through the implementation of corporate museums is to transfer organizational memory to visitors/customers. This happens through a process that – from the visitors/customers' perspective – is articulated in three steps (Lambin, 2000) that consist in providing: 1) a cognitive response, referred to learning something; 2) an affective response, referred to feeling something; and 3) a behavioural response, referred to doing something.

If corporate managers and exhibitions directors and curators properly manage the three steps of the above process, then corporate museums can really improve the politics of remembering and/or of forgetting, in reference to the past or to the present, and to the politics of imagining, in reference to the future (Nissley and Casey, 2002).

In this vein, it results that management scholars have not paid yet so much attention on the theoretical frameworks that can be used to manage the transfers of organizational memory. The transfers involve at first corporate managers and exhibition directors and curators; later on they involve exhibition directors and curators and visitors/customers.

This seems to be a relevant gap to be filled in.

### *Knowledge management: the SECI model*

The origins of SECI model can be dated back to 1991 when Nonaka published his seminal work entitled "*The knowledge-creating company*". This contribution has been enriched over the years (Nonaka, 1994; Nonaka and Takeuchi, 1995; Nonaka *et al.*, 1996; Nonaka and Konno, 1998; Nonaka *et al.*, 2000, 2014;



Nonaka and Nishiguchi, 2001; Nonaka and Toyama, 2003) and up to now it represents one of the most known and used model in the field of knowledge management.

Even if the model is well known, it seems appropriate to recall each of the four phases in order to underline their main characteristics and their possible reference to organizational memory.

The SECI model starts with the socialization phase. Over this phase, which takes place inside the company and depends on the context, individuals exchange their tacit knowledge (Argote and Ingram, 2000). The affiliation to the company, the relationship and the proximity between employees – who are willing to favourite this exchange – make the socialization happen. In particular, employees exchange tacit knowledge through observations and imitation. Because of the context and through observations and imitation, new tacit knowledge is created.

The second phase of the SECI model deals with externalization. Over this phase, employees transform the tacit knowledge created through the act of socialization into explicit knowledge. As underlined by Nonaka and Takeuchi (1995), the phase of externalization is the most critical one since tacit knowledge needs to be formalized through metaphors, analogies, concepts, figures, and models that are expected to symbolize the tacit knowledge in a proper way.

The third phase of the SECI model deals with combination. During this phase, explicit knowledge is turned into explicit knowledge. The explicit knowledge – which has already been formalized through metaphors, analogies, concepts, figures, and models – needs to be systemized (Nonaka and Takeuchi, 1995). Generally speaking, this happens through language and, in fact, as a result explicit knowledge is formalized into reports, documents and notes. This favours the following sharing of explicit knowledge.

The last phase of the SECI model deals with internalization. In this case, the explicit knowledge is turned into tacit one. Employees embody the explicit knowledge shared through reports, documents and notes and internalize it. As underlined by Nonaka (1991), internalization implies the dissemination of explicit knowledge. Generally speaking, in the organizations this phase takes place through the act of learning by doing.

Relevance of the SECI model seems to be due to the fact that: it considers both tacit and explicit knowledge; it assumes that knowledge creation is a social and an individual process; and it aims to create and disseminate new knowledge.

Because of what was said above, it seems that the SECI model could be referred to companies implementing corporate museums. In this case, companies aim to create and disseminate organizational memory and, in order to do this, they need to consider both tacit and explicit knowledge and to manage both a social and an individual process.

## APPLYING SECI MODEL TO TRANSFER ORGANIZATIONAL MEMORY

As underlined before, corporate museums and organizational memory on the one hand and knowledge management on the other hand have always been considered as standing alone topics of research. The aim of the present paper, instead, is to try to combine them and, in particular, to try to apply the SECI model in order to transfer organizational memory. In the following lines, the four phases included in the SECI model (socialization, externalization, combination and internalization) are recalled and referred to the process through which corporate managers and exhibition directors and curators try to transfer organizational memory to visitors/customers.

To the knowledge of the author, this is one of the first trials of referring the SECI model to organizational memory. This implies that some criticalities necessarily arise. Hopefully, they are properly managed and reduced at an acceptable level.

### *Socialization*

As already said, the SECI model begins with the phase of socialization. During this phase, tacit knowledge is shared in order to create new tacit knowledge. In reference to the implementation of corporate museums, it is obvious that corporate managers are aware of the brand identity but it might happen that exhibition directors and curators are not. In this vein, corporate managers need to communicate the brand identity to exhibition directors and curators. Over dedicated meeting and through observations – which are events and facts that favour the act of socialization – exhibition directors and curators can apprehend from corporate managers the organizational memory linked to the brand. In this phase of SECI model, it is important the context in which socialization takes place. Generally speaking, the context in which this phase takes place is the company headquarters where its organizational memory lies. By referring the SECI model to corporate museums, it seems reasonable to suggest that:

**P1:** When implementing corporate museums, corporate managers need to socialize with exhibition directors and curators so that these last ones can apprehend the organizational memory that corporate managers want to transfer to visitors/customers.

### *Externalization*

The second phase of SECI model deals with externalization. Over this phase, tacit knowledge is transformed into explicit. As for the implementation of corporate museums, exhibition directors and curators (who have already apprehended the organizational memory that corporate managers want to transfer to visitors/customers) need to externalize the apprehended organizational memory in a new way that lies outside the company and falls in a corporate museum. In this vein, metaphors, analogies, concepts, figures, and models (Nonaka *et al.*, 2000) need to be properly selected and used since they

represent the *incipit* of the exhibition. In this phase, in fact, exhibition directors and curators start thinking about the best means to communicate the company's organizational memory with the outside. By referring the SECI model to corporate museums, it seems reasonable to suggest that:

**P2:** When implementing corporate museums, exhibition directors and curators need to externalize the apprehended organizational memory to be transferred to visitors/customers so that corporate managers can validate or reject it.

#### *Combination*

The third phase of the SECI model deals with combination. Over this phase, explicit knowledge is created from explicit knowledge. In reference to the implementation of corporate museums, exhibition directors and curators need to systemize the organizational memory (previously apprehended by corporate managers, externalized through metaphors, analogies, concepts, figures, and models and validated by corporate managers) through language. Similarly to the explicit knowledge that results from combination and that can be easily formalized into reports, documents, and notes, the organizational memory that results from combination can be easily shaped into an exhibition that can be easily communicated to visitors/customers. By referring the SECI model to corporate museums, it seems reasonable to suggest that:

**P3:** When implementing corporate museums, exhibition directors and curators need to combine the apprehended organizational memory that corporate managers aim to transfer so that it can be easily communicated to visitors/customers.

#### *Internalization*

The last phase of SECI model deals with internalization. Over this phase, explicit knowledge is turned into tacit one. In the original SECI model (Nonaka and Takeuchi, 1995), it is clearly underlined that this phase – differently from the previous ones referred to organizational learning – refers to individual learning. Something similar can be assumed by referring the SECI model to corporate museums. In the previous phases, in fact, attention was paid over corporate managers and exhibition directors and curators that have to socialize, externalize and combine organizational memory. In this phase, instead, attention is paid over visitors/customers who internalize the organizational memory embodied in the corporate museum. Exhibition directors and curators need to manage the politics of memory with due diligence since they can stimulate the politics of remembering and of forgetting – in reference to the past and to the present – and the politics of imagining – in reference to the future – of visitors/customers joining the exhibition (Nissley and Casey, 2002). According to the above reasoning, it seems reasonable to suggest that:

**P4:** When implementing corporate museums, exhibition directors and curators need to manage the politics of memory in proper way (by leveraging on selective attention and selective retention) so that visitors/customers can internalize the organizational memory that corporate managers aim to transfer.

## LIMITATIONS, CONCLUSIONS AND FURTHER DEVELOPMENTS

The present paper has tried to apply the SECI model to the transfer of organizational memory through corporate museums. The trial is not easy since it is based on the mix of two different fields of research: corporate museums and organizational memory on the one hand and knowledge management on the other. These two fields of research have always been considered as standing alone even if an overlapping seems to exist.

In reference to the limitations of the paper, it is obvious that the main one is linked to the fact that this is a theoretical paper trying to combine different fields of research without testing them. Both qualitative and quantitative analyses could be useful in this vein.

Despite the above limitation, it seems that the mix of different topics (corporate museums and organizational memory on the one hand and knowledge management on the other) can disclose a new and intriguing field of research that other scholar might enrich by proposing alternative perspectives and by providing qualitative and quantitative analyses in order to assess its validity.

## REFERENCES

- Amari, M. (1997), *I Musei delle Aziende. La Cultura della Tecnica tra Arte e Storia*, Franco Angeli, Milano.
- Argote, L., and Ingram, P. (2000), "Knowledge transfer: a basis for competitive advantage in firms", *Organizational Behavior and Human Decision Processes*, Vol. 82 No. 1, pp 150–169.
- Bonti, M. (2014), "The Corporate Museums and their Social Function: Some Evidence from Italy", *European Scientific Journal*, Vol. Special Issue No. 1, pp. 141-150.
- Danilov, V.J. (1992), *A Planning Guide for Corporate Museums, Galleries, and Visitor Centers*, Greenwood Publishing Group, Westport, CT.
- Gilodi, C. (2002), "Il museo d'impresa: forma esclusiva per il corporate marketing", *LIUC Papers*, Vol. 10 No. 1, pp. 1-37.
- Griffiths, J. (1999), "In good company? What's the point of corporate museums", *Museums Journal*, Vol. 10 No. 1, pp. 35-37.
- Katriel, T. (1994), "Sites of memory: Discourses of the past in Israeli pioneering settlement museums", *Quarterly Journal of Speech*, Vol. 80 No. 1, pp. 1-20.
- Kotler, P., and Scott, W. G. (1993), *Marketing Management*, Isedi, Torino.
- Lambin, J. (2000), *Marketing Strategico*, Mac Graw Hill, Milano.
- Lusch, R.F. and Vargo, S.L. (2006), "Service-dominant logic: reactions, reflections and refinements", *Marketing Theory*, Vol. 6 No. 3, pp. 281-288.
- Montella, M.M. (2010), "Musei d'impresa come strumento di comunicazione. Possibili innovazioni di prodotto, processo, organizzazione". *Esperienze d'Impresa: Dipartimento di Studi e Ricerche Aziendali, Università di Salerno*, Vol. 2, pp. 147-164.
- Montella, M.M. (2014), "Nuovi strumenti di internal marketing e knowledge management: i musei d'impresa", *Sviluppo & Organizzazione*, Vol. agosto-settembre, pp. 66-74.
- Nissley, N. and Casey, A. (2002), "The politics of the exhibition: Viewing corporate museums through the paradigmatic lens of organizational memory", *British Journal of Management*, Vol. 13 No. 1, pp. 35-45.

- Nonaka, I. (1991), "The knowledge creating company", *Harvard Business Review*, Vol. November–December, pp. 162–171.
- Nonaka, I., and Takeuchi, H. (1995). *The Knowledge-Creating Company: How Japanese Companies Create the Dynamics of Innovation*, Oxford University Press, New York.
- Nonaka, I. (1994), "A dynamic theory of organizational knowledge creation", *Organization Science*, Vol. 5 No. 1, pp. 14-37.
- Nonaka, I. and Konno, N. (1998), "The concept of ba: Building a foundation for knowledge creation", *California Management Review*, Vol. 40 No. 3, pp. 40-54.
- Nonaka, I. and Nishiguchi, T. (2001), *Knowledge Emergence: Social, Technical, and Revolutionary Dimensions of Knowledge Creation*, Oxford University Press, New York.
- Nonaka, I. and Toyama, R. (2003), "The knowledge-creating theory revisited: knowledge creation as a synthesizing process", *Knowledge Management Research & Practice*, Vol. 1 No. 1, pp. 2-10.
- Nonaka, I., Kodama, M., Hirose, A. and Kohlbacher, F. (2014), "Dynamic fractal organizations for promoting knowledge-based transformation—A new paradigm for organizational theory", *European Management Journal*, Vol. 32 No. 1, pp. 137-146.
- Nonaka, I., Toyama, R. and Konno, N. (2000), "SECI, Ba and leadership: a unified model of dynamic knowledge creation", *Long range planning*, Vol. 33 No. 1, pp. 5-34.
- Nonaka, L., Takeuchi, H. and Umemoto, K. (1996), "A theory of organizational knowledge creation", *International Journal of Technology Management*, Vol. 11 No. 7-8, pp. 833-845.
- Payne, A., Storbacka, K., Frow, P. and Knox, S. (2009), "Co-creating brands: Diagnosing and designing the relationship experience", *Journal of Business Research*, Vol. 62 No. 3, pp. 379-389.
- Piatkowska, K.K. (2014), "The corporate museum: a new type of museum created as a component of marketing company", *The International Journal of the Inclusive Museum*, Vol. 6 No. 2, pp. 29-37.
- Poulsson, S.H. and Kale, S.H. (2004), "The experience economy and commercial experiences", *The Marketing Review*, Vol. 4 No. 3, pp. 267-277.
- Prahalad, C.K. and Ramaswamy, V. (2004), "Co-creation experiences: The next practice in value creation", *Journal of Interactive Marketing*, Vol. 18 No. 3, pp. 5-14.
- Stigliani, I. and Ravasi, D. (2007), "Organizational artifacts and the expression of identity in corporate museums of Alfa Romeo, Kartell and Piaggio", in Lerpold L., Ravasi D., van Rekom J., Soenen G. (Eds.), *Organizational Identity in Practice*, Routledge, NY.
- Tynan, C. and Mckechnie, S. (2009), "Experience marketing: a review and reassessment. *Journal of Marketing Management*, Vol. 25 No. 5-6, pp. 501-517.
- Vargo S.L. and Lusch, R.F. (2004b), "The four service marketing myths: remnants of a goods-based, manufacturing model", *Journal of Service Research*, Vol. 6 No. 4, pp. 324-335.
- Vargo, S.L. and Lusch, R.F. (2004a), "Evolving to a new dominant logic for marketing", *Journal of Marketing*, Vol. 68 No. 1, pp. 1-17.

## GENDER ASYMMETRY IN BEHAVIORAL RESPONSES OF TRANSPORT FEE PAYERS

Mayburov, Igor<sup>1,2</sup>; Leontyeva, Yulia<sup>1</sup>

<sup>1</sup>Dept. Graduated School of Economics and Management, Ural Federal University, UrFU, Ekaterinburg, Russian Federation

<sup>2</sup>Dept. Graduated School of Economics and Management, Ural Federal University, UrFU, Ekaterinburg, Far Eastern Federal University, FEFU, Vladivostok, Russian Federation

### ABSTRACT

The article looks at how people react to the introduction to additional transport related fees when using private transport. The authors prove that a switch to road pricing and paid parking in urban areas is inevitable. An overview is done of scholarly work on the problem of people's behavioral response by means of sociological surveys and laboratory experiments. The proposed research method is a laboratory experiment based around a consumer behavior survey of students faced with the need to pay additional transport related fees. The experiment stipulates the length of the trip, the size of the per-kilometer congestion charge, the parking fee, the price of gasoline, and the public transport fare. Following the experiment, the students' readiness to pay the additional charges or to use public transport is assessed. It is proven that women exhibit smaller levels of readiness to use public transport, while men are more likely to abandon their cars. Different levels of readiness to voluntarily pay the additional transport related charges are measured in female and male students. It is concluded that female drivers exhibit higher levels of propensity and compliance when it comes to paying transport related charges, whereas men need to be kept under tighter control because they are less inclined to voluntarily pay the transport related charges. The aim of the research is to develop a method of assessing behavioral responses of transport fee payers that will make it possible to differentiate between the responses exhibited by male and female inhabitants.

*Keywords: Behavioral responses, laboratory experiments, public transport, private transport*

### INTRODUCTION

A substantial fleet of privately owned cars is one of the most vivid signs of the times. Growth of car ownership rates took place in different countries at different times and at different pace. In the USA, the number of privately owned cars skyrocketed in the 1930s. In Western Europe, private car ownership grew rapidly between the 1950s and 1970s. In Russia, the phenomenon started to manifest

itself much later, around the mid-1990s. At present, growth in the number of privately owned cars has slowed down, but has not stopped.

There is no doubt about the fact that widespread car ownership has considerably increased population mobility, giving people more opportunities to choose where to live, work and spend their leisure time. Ultimately, mass produced and affordable cars gave ordinary people a new range of opportunities and improved their standards of living.

Today, the car is a basic component of the life of households with any level of income practically in any country. The advantages of having a car are so obvious to all societal classes that mass car ownership has swept all developed and developing countries. The one-car-per-family concept has been replaced with the concept of two and three cars per family; that is, there emerges a standard of "one car per adult". Urban areas had a particularly rapid onset of the processes that led city dwellers into a kind of dead end that proved to be difficult to escape. People's unabated desire to use their cars for any kind of trips clashed with the limited capacity of cities to fulfill that desire. Excessive use of cars in the urban environment has led to a chronic shortage of parking space and road network capacity and, as a result, to traffic jams and the overall inefficiency of city transport systems.

This has even brought about calls for abstaining from driving in the city environment altogether. Of course, giving up one's car completely is another extreme, its opposite being city dwellers' desire to use cars for any kinds of travel. Vuchic (Vuchic, 1981) argues that cities that are completely car free are economically and socially unlivable. It is not cars that generate negative effects and problems, but their excessive use and a lack of alternatives. A "conflict between cities and cars" can be solved by developing balanced intermodal transport systems and by restricting car use to the level where its benefits are realized, while associated negative externalities are reduced to a minimum. A reduction in the number of car rides will be followed by a growth in the effectiveness of car use and the efficiency of public transport thanks to an increase in demand.

It has to be noted that regardless of car ownership rates there will always be one category of city dwellers who will never use a private car due to physical, psychological and other limitations. This group will always choose public transport. Urban transport policy should focus on changing the behavior of another group of city dwellers – those who can choose between public transport and private vehicles. A strategic advantage of big cities is their capability to provide quality and competitive public transport services to passengers who always have to choose between public transport and their own car. When making the choice, the city dweller compares the factors of price, time of travel, comfort and safety.

One of the key factors influencing urban transport habits is the ratio of public transport fares to the cost of traveling by car. The cost of a car trip should be much higher than the price paid for going to the same destination by public transport, all transfers included. Fiscal instruments of regulation prove the most effective for creating price disproportion. The sum total of transport-related charges that car owners pay when possessing and using their vehicles in a city should be fiscally significant and as close to the time of using parking facilities and the road network as possible. In this case they will produce a number of socially significant effects.

First of all, they will curtail the use of private cars in the urban environment through a higher cost of travel. Second, environmental and noise pollution will improve thanks to traffic reduction. Third, additional funds obtained from transport-related charges will help expand the road network in the city. Fourth, additional subsidies and growing ridership will result in improvements to public transport.

Transport-related charges should, therefore, lead to a reduction in car use in the urban environment. It is a very sensitive issue for car owners. Are they prepared to pay additional transport-related charges? Are they prepared to opt against using their vehicles? These questions make it particularly relevant to study behavior responses of car owners. It is extremely important to identify gender differences in the responses.

The importance of looking at gender differences in transport behavior is due to the growing role of female drivers. The task seems particularly timely for Russian cities as the past decade was marked by accelerated growth in the number of cars owned and driven by women. In Europe, the processes occurred much earlier. Women of various ages dominate among newly licensed drivers as a large part of the male population in urban areas already have driver's licenses.

## **1 LITERATURE REVIEW**

Pioneering studies of urban transport systems amid rapidly growing car ownership were conducted by Wardrop (Wardrop, 1952) and Hollatz (Hollatz, 1965). Wardrop studied an equilibrium distribution of public and private transport flows within a section of a road network. The point of equilibrium was determined by comparing total disutility (total costs) of all travellers. Wardrop proved that when each road user chooses their preferred means of transport, this choice is not socially optimal. It is necessary to implement incentives encouraging the use of public transport. At the same time, it is necessary to adopt measures to discourage the use of private transport. Hollatz and Tamms showed that high concentrations of cars in a city not only lead to lower efficiency of the entire transport system of the city, but generally decreases the quality of life and safety for the entire urban community.



Studies that were conducted in many countries in the 1960s (Buchanan, 1964; Fitch, 1964) showed that the use of cars in cities was associated with benefits as well as problems. The scholars already started to advocate the priority of public transport.

Weyrich proved that car travel fosters spatial segregation of activities and the segregation of residential areas. High-quality public transportation usually contributes to mixed land uses, stimulating the creation of major activity centers and more diversified residential developments. The strong bias toward cars over all other modes leads to separated rather than diversified land use (Weyrich, Lind, 1996).

Stanger researched the possibility of using public transport for serving wealthier groups of society. He studied the efficiency of rail systems such as BART (Bay Area Rapid Transit in San Francisco), the Washington Metro and METROLINK in Los-Angeles. The systems predominantly serve wealthy suburbs. Stanger studied the structure of commuter flows and proved that high-quality transit systems with reasonable fares can be an attractive option for various social and ethnic groups (Stanger et al., 1995).

A study by Newman and Kenworthy covered the experience of various cities across the globe that indicated that economically strong, socially healthy and livable cities boast intermodal transit systems that incorporate extended and efficient public transport systems. The systems provide a good alternative to car travel (Newman and Kenworthy, 1989).

Vuchic argued that two basic elements needed to be identified with regard to car use in the urban environment. The first one is a set of measures aimed at improving the capacity of the existing road network in coordination with available parking facilities. The second basic element implies that restrictions should be imposed on the intensity of car use in order to keep a balance between the demand for and the supply of road capacity and, consequently to prevent congestion. Managing parking demand by means of restricting parking supply and charging for parking is the most effective policy. Another highly effective demand management measure is the introduction of a fee for using certain sections of the road network in the city. Initially the measure was very unpopular, but became politically acceptable as the community realized that they were faced with a simple alternative: pay and travel in acceptable conditions, or don't pay and waste hours in traffic jams (Vuchic, 1981).

If the motorist does not have to pay for parking (which is the case in most towns of Russia), his or her car-related charges usually make up only 10 to 15 percent of the total cost of a car trip. This makes car travel extremely cheap from the point of view of most car owners. The factor makes a huge difference, turning the car into the priority mode of transport in the city. As a result, the low level of fixed and

variable car related charges makes a significant contribution to congestion and the paralysis that regularly strikes the road system in most Russian cities (Mayburov, 2016).

The theoretical study into transport choices will be conducted by means of laboratory experiments. Over the past few decades behavioural economics has received a strong impetus. Initially economists used laboratory experiments for verifying econometric models and theoretical forecasts. Over the past few decades laboratory experiments have allowed a wider application of research findings. One of the most important trends in laboratory experiments today is the harvesting of information about economic agents' behavior.

Vernon Smith earned the 2002 Nobel Memorial Prize in Economic Sciences for "for having established laboratory experiments as a tool in empirical economic analysis, especially in the study of alternative market mechanisms". Smith believes that economic experiments help close the gap between decision theory and decision behavior, and the gap between evidence concerning how people think about economic questions and evidence concerning how people behave in experimental markets (Smith, 1991).

The possibility of using laboratory experiments for research on transport choices is a yet little explored field that has not received proper attention of the economic community. We are not aware of any studies investigating gender differences in transport behavior responses.

Our experiments in transport choices might be built around the method of public-goods experiments because participants, when choosing their own car or public transport, decide whether to invest their money in the development of private or public goods. J. Alm studied so-called public-goods experiments. The method is different in presenting participants with two choices. They are to decide whether to invest their money in private goods or public goods (Alm, 2011).

## 2 METHODS

The aim of the research is to develop a method of assessing behavioral responses of transport fee payers that will make it possible to differentiate between the responses exhibited by male and female inhabitants of urban areas.

The proposed research method is a laboratory experiment formatted as a survey of students to learn about their transport behavior when faced with the choice between private vehicles and public transport for daily pendulum migration.

Four groups of 25 students each were selected for the survey. The students were studying for undergraduate degrees in economics. To ensure comparability of results, all subjects were picked among third-year students, their average age being 20 years.

The experiment consisted of two stages. At stage one, the students earned an income measured in points by giving correct answers to questions in a test. At stage two, the students learnt about the size of their income and were to choose how they would make a set number of trips to school – either by car, or by public transport.

The students were given questionnaires consisting of two parts. Part one contained economic-themed questions that made it possible to evaluate the students' professional competency and their moral convictions about voluntary compliance. The students earned their income by answering the questions from part one of the questionnaire. All groups of subjects had identical questionnaires regardless of their majors and time of the survey.

The questionnaires were supplemented with questions that revealed the students' disposition the family income (whether the family has an apartment, a country house, a car). The personal questions were included in part two of the questionnaire. The answers to the questions did not contribute to the students' 'income', but were used only for creating their personality profiles.

We decided to create the real-life environment of the laboratory evasion experiment by motivating students with grades. The reason is that our university follows a grading system that evaluates knowledge on a 100-point scale. If a student earns 80% of maximum grade points, which is only possible if he or she gets top grades for all assignments, he or she is entitled to a first class pass in the course. The possibility of earning points during a course and thus avoiding the final test provides very good motivation for students. Consequently, awarding points to students as their income in the experiment encourages them to participate in the experiment and drives them to do things in order to earn the income. The approach is a methodological innovation that we added to the laboratory evasion experiment design.

Eventually, the rationality of the students' transport choices was driven by their desire to save a fairly large part of their income to get a higher grade in the course. This motivation forces the students to be frugal with the income, treating it as real money, which brings the choices exhibited by the students during the experiment closer to their real life behavior.

The experiment contained basic assumptions, variables and constants. The key assumption was that all subjects own a car. The second assumption was the availability of a public transport stop within walking distance.

The constant was the number of trips from home to school and back that the students were to make regardless of their income.

The gender of the students and various ratios of the cost of traveling by car to the cost of traveling by public transport were the variables of the experiment. The conditions of car travel in terms of the conditions of road use and parking in the urban environment were also a variable parameter.

### 3 ANALYSIS OF RESULTS

A series of experiments yielded meaningful results. We shall structure the results around the training methods and demographic profiles of the students.

#### 3.1 Analysis of transport choices at different price levels

Table 1 shows the results of laboratory experiments with different ratios of prices of car rides and trips by public transport. The results are differentiated by demographic traits of the subjects, namely their gender and the income level of the families they grew up in.

№	Index	Share, %	Ratio of prices of trips by public transport and by car (in equivalent units)		
			1.0 : 1.0	1.0 : 1.5	1.0 : 2.0
1	Sample:				
	men	25	3	35	68
	women	75	1	18	39
2	Income level				
	higher than the median	65	0	27	51
	lower than the median	35	7	43	88

Table 1: Choice of public transport depending on the prices of travelling by car and public transport, %

The experiment found that when the prices of travelling by car and by public transport are the same, practically all participants opt for private cars. Things turn around only when there is disparity, with the price of a car ride being 50 percent higher than a single bus fare. In this case, 18 percent of women and 35 percent of men choose to use public transport to go to work (school). When the price of a car journey is twice as high as that of a bus ticket, as many as 39 percent of women and 68 percent of men opt for public transport. However, one cannot be sure that there is a price ratio that will make costumers decide against using cars altogether.

Consumers' demographic traits make a big difference to their transport choices. For example, one could notice a strong gender division in transport behavior. It is possible to conclude that men take a more

pragmatic approach to choosing a means of transport. Quantitatively, there is almost a two-fold difference in the travel behavior responses of men and women. For women, transport comfort will be more significant a factor than the price of the trip, while men will give priority to the price issue when choosing the means of transport.

There is an interesting correlation between behavior responses and the income level. It has to be noted that the income that the student earns during the experiment is significantly different from the income of the family he or she was raised in. The reason is that the earned income determines their current ability to pay, while the wealth of their family indicates their long-term solvency. Consequently, these parameters form different behavioral responses.

Consumers from well-off families are less inclined to choose public transport even where there is a significant price difference between the modes of transport. For example, if traveling by car costs 50 percent more than by public transport, only 27 percent of persons from well-off families are prepared to opt for public transport, whereas the share of students from low-income families choosing public transport is much higher – 43 percent. When the price of a car ride is twice as high as that of a public transport fare, 51 percent of persons from well-off families are prepared to take a bus to go to school, while the share of students from low-income families opting for public transport is drastically different – 88 percent.

Therefore, the conducted laboratory experiments with different ratios of prices of car rides and trips by public transport infer a conclusion that the price ratio is an important factor impacting consumers' decision when choosing a means of transport. Consequently, in order to achieve a shift in behavioral responses of people toward public transport it is necessary to increase the price disparity between privately owned cars and public transport for making otherwise identical trips.

### *3.2 Analysis of behavior responses to implementation of parking charges*

In order to find out what transport related charges, if increased, would be tolerated by population, during the experiment we set different conditions of paid parking. The students were to choose a mode of transport (public or private transport). If opting for the car, they were to pay a parking charge during the daytime. The basic assumption of this part of the experiment was the availability of nighttime paid parking facilities to all subjects. This assumption means that the students viewed paying for parking during the daytime as extra costs that they had to cover out of the income they had earned during the experiment. The students inflicted the costs by choosing the car for making a set number of trips. The amount of the costs was designed to make the total price of a car trip 50 percent higher than the price paid for a public transport ride.

Table 2 shows the results of the laboratory experiments for the variable “readiness to pay for daytime parking”.

No	Index	Share, %	Not ready to pay for parking (decided to use public transit or pay a fine), %	Ready to pay for daytime parking, %
1	Sample			
	men	25	48	52
	women	75	25	75
2	Income			
	above average	65	32	68
	below average	35	58	42

Table 2: Transport behavior reactions to implementation of paid parking

The results of the experiment indicate that female drivers exhibited stronger readiness to pay for parking (71 percent), than men (52 percent). If we compare the share of those who are not prepared to pay for parking with those who opt for public transport at the price ratio of 1:1.5, we might conclude that 13 percent of men will use parking facilities without paying for them. Women are less prone to evade parking fees, with only 7 percent of them stating they would use parking facilities without paying for them. It would be logical to assume that women are more compliant legally and are more disposed to pay for parking.

The level of family income has a big impact, too. Students from well-off families demonstrate greater readiness to pay for parking (68 percent), than children from low-income families. Besides, only 5 percent of students from well-off families admitted that they would use parking facilities without paying for them, while 15 percent of children from low-income families said they would do so.

The laboratory experiments for the variable parameter “readiness to pay for daytime parking” enable one to suppose that female drivers and drivers from better-off families are more disposed to pay additional charges for daytime parking.

### *3.3 Analysis of transport behavior reactions to implementation of congestion charge*

The subject of the biggest interest is the results of an experiment with the variable “readiness to pay congestion charge”. This is due to the fact that not a single Russian town has implemented a congestion charge yet, whereas paid parking has been embraced by a substantial number of Russian towns.

If the subjects opted for using their cars, they were to pay a charge for using roads in the center of the city. The amount of the charge was designed to make the total price of a car trip 50 percent higher than the price paid for a public transport ride. The terms of the experiment stipulated that the charge was unavoidable and would be debited to their card accounts once they enter the charge zone.

Table 3 shows the results of laboratory experiments for the variable “readiness to pay the congestion charge”.

No	Index	Share, %	Not ready to pay congestion charge (prefer to travel by public transport), %	Ready to pay congestion charge, %
1	Sample			
	men	25	71	29
	women	75	54	46
2	Income			
	above average	65	60	40
	below average	35	88	12

Table 3: Transport behavior responses to implementation of congestion charge

The results of the experiment show that female drivers are more disposed to pay the congestion charge (46 percent), while men are a lot less willing to support the implementation of the charge (29 percent). The level of income in the subjects’ families had a substantial influence, too. Children from better-off families demonstrate bigger readiness to pay the congestion charge (40 percent), than children from low-income families who are practically unprepared to embrace the charge (a mere 12 percent).

The results of the laboratory experiments for the variable parameter “readiness to pay the congestion charge” make it possible to conclude that female motorists and drivers from wealthier families are more disposed to bear the additional cost of using roads in the center of town. Male drivers manifested lower readiness to pay the congestion charge.

Generally speaking, there are positive and negative sides to such behavior responses to the introduction of the congestion charge. The negative side is the low support among city dwellers and the possibility of protests when the congestion charge is implemented. In this case it is necessary to step up the promotion of transport alternatives and emphasize the effects of reduced traffic congestion in the city. One of the positive aspects is the potency to change the mentality of drivers. Although the

congestion charge was equal to the daytime parking fee, people were more negative about the congestion charge. Twice as many subjects decided to give up their cars in the case of the congestion charge than in the case of paid parking. Consequently, this charge could be used for adjusting city dwellers' transport behavior.

## CONCLUSION

An urban transport policy that employs fiscal instruments aimed at discouraging car travel in the urban environment will simultaneously increase the efficiency of private and public transport.

It is possible to conclude that men take a more pragmatic approach to choosing a means of transport. Quantitatively, there is almost a two-fold difference in the travel behavior responses of men and women. For women, transport comfort will be more significant a factor than the price of the trip, while men will give priority to the price issue when choosing the means of transport.

The conducted laboratory experiments with different ratios of prices of car rides and trips by public transport infer a conclusion that the price ratio is an important factor impacting consumers' decision when choosing a means of transport. Consequently, in order to achieve a shift in behavioral responses of people toward public transport it is necessary to increase the price disparity between privately owned cars and public transport for making otherwise identical trips.

The results of the laboratory experiments for the variable parameter "readiness to pay the congestion charge" make it possible to conclude that female motorists and drivers from wealthier families are more disposed to bear the additional cost of using roads in the center of town. Male drivers manifested lower readiness to pay the congestion charge.

## REFERENCES

- Vuchic, V.R. (1981), *Urban public transportation: systems and technology*, Prentice-Hall Englewood Cliffs, NY.
- Wardrop, J.G. (1952), *Proceedings of the Institution of Civil Engineers*, [1], pp.325-362
- Hollantz and Tamms (1965), *Die Kommunalen Verkehrsprobleme in der Bundesrepublik Deutschland*, Essen, Vulkan-Verlag, Germany.
- Fitch Lyle and Associates (1964), *Urban transportation and public policy*, Chandler, San Francisco, CA.
- Weyrich, P.M., William S. L. (1996), *Conservatives and mass transit: Is it time for a new look?* Free Congress Foundation and American Public Transit Association, Washington, DC.
- Buchanan, C. et al. (1964), *Traffic in towns*, Her Majesty's Stationery Office (HMSO), London, UK.
- Stanger, R. et al. (1995), *Report on the status of the Metrolink system with emphasis on the MTA's costs and benefits*, Southern California Regional Rail Authority, Los Angeles, California.
- Newman, P., Kenworthy, J. (1989), "Gasoline consumption and cities: a comparison of U. S. cities with a global survey", *Journal of the American Planning Association*, Vol. 55, pp. 23 – 37.
- Mayburov, I., Leontyeva, Y. (2016), "Forming the social optimum of passenger flows in urban agglomerations in Russia", *International Conference on Sustainable Cities (ICSC 2016)*, 19-20 May, E3S Web of Conferences, Vol.6.
- Vernon, S.L. (1991), *Papers in Experimental Economics*, Cambridge University Press, New York, 795 p.



Alm, J. (2011), Testing Behavioral Public Economics Theories in the Laboratory. New Orleans, Tulane University, Working Paper №1102.

## IDENTIFICATION OF LEADERSHIP COMPETENCIES IN THE INTERNATIONAL ENVIRONMENT

**Mazánek, Lukáš; Pekárek, Jan; Vraniak, Lukáš; Konečná, Zdenka**

Dept. of Management, BUT, Faculty of Business and Management, Brno, Czech rep

### ABSTRACT

The aim of this study is to describe the significance of leadership competencies in the companies „operating“ in the international environment. We surveyed 96 manufacturing companies to obtain questionnaire responds from 54 South Moravian international manufacturing companies' CEOs. The total of 25 questions, mapped 5 groups of interest in the field of technical (professionally expert), strategic, personality, social and intercultural competencies level perception of company CEO. Every question was rated from 1 – 5, when as higher value than higher frequency and perception of importance of the competence was assumed. This research approach is based on five-factor leadership model, nevertheless the attention is focused only at factor defined as individual competence. Therefore, as well other factors can affected the overall leadership effectiveness. There had been identified competencies, which are the most frequently used and those, which are perceived as the most important to adopt for managers who wish to be perceived as a leader. Among the three most important competencies there were identified the ability to make decisions, ability to negotiate, and ability to organize the work of subordinates. Thanks to the understanding which competencies are key to leadership, we are able to use these results in HR management. The clear practice implication is to create a competency model that can be used as a beneficial tool for recruiting and leadership development.

*Keywords: Leadership, competencies, international environment, manufacturing company*

### INTRODUCTION

Human resource management in international environment is defined as “the process of employing and developing people in international or global organizations” (Armstrong and Stephens, 2015). According Briscoe at al. (2009) the human resources management represents examining and implementing all human resource management activities that affect the process of human resource management in organizations in a global environment. “The purpose of human resources management is to emphasize the organization's overall interests - the interests of organization's members are

recognized, but are subordinate to enterprise's interests. This also implies the importance attached to strategic integration and strong culture based on the vision of top management and its lead. This requires people who will be committed to this strategy, who will be adaptable to change and who will behave in accordance with the corporate culture" (Armstrong and Stephens, 2015)

In connection with developments and challenges in human resource management, Stone & Daedrick (2015) mention several factors that can influence the future of human resource management in organizations, including economic change, globalization, the use of new technologies, and the diversity of contemporary society. The way, how successful can companies handle these challenges can also affect the application of a suitable leadership concept. According to Armstrong and Stephens (2015), leaders focus their attention on the most important source – people. They motivate workers and gain their commitment and engagement. Applying a suitable leadership concept enables companies to get a competitive advantage through a balanced relationship between the leader and the subordinates. Ideally, it is not the traditional relationship of two groups with different interests - the interest of the leader in fulfilling the tasks on the one side and the interest of the workers in obtaining wages on the other side (Pavlica et al., 2013). The concept of leadership includes the ability of the leader to create a real vision of the enterprise direction and to explain its followers their role according to vision achieving (Kotter, 1991).

## **THEORETICAL BACKGROUND**

### *Competencies*

Prusak (2016) emphasizes the value of human capital and that human capital is a combination of knowledge, innovation, abilities, experience, creativity, social and personal skills, and physical, mental, intellectual and moral characteristics of predispositions and intrinsic motivations with a company with which they are able to cooperate. At the same time, the authors emphasize the complex structure of human capital by pointing to the following components: competence (knowledge and skills), motivation and utilization of potential and intellectual properties.

According to Kubeš et al (2004), competency models can significantly unify the view of what will be needed in the future, what behavior the organization should promote, develop and reward. According to Plamínek (2015), it can have a practical use of a competence approach, giving people more benefits: a clear definition of the direction of society. A clear definition of performance requirements. Setting the terms of cooperation; identification of the necessary human resources; creating an evaluation system; limiting conflicts of jurisdiction; reducing the need for operational management; increasing efficiency of performance in the company; higher success rate of changes and many more. Mikušová (2015) also confirms that competency models are an inevitable part of integrated human resources management.

*Leadership*

Leaders inspire and motivate their followers, it is important for them to feel that their work is meaningful and important to the business. Obviously, even the best leaders cannot have the perfect knowledge and skills in all areas. This is the reason why they create the team of experts, which are specialists in their field and with the right lead is highly synergic effect in fulfilling the assigned task achieved (Veber, 2009). It is advisable for the leaders to continue develop themselves and develop their knowledge, while an important part is openness to learning from others and the ability to receive advice from more experienced people. In addition is important to listen to their followers and take their remarks and suggestions to improve business processes. The neglecting of employees' remarks, together with the traditional reluctance to make changes, dampens the potential for growth in business efficiency and has a negative impact on employee motivation (Kotter, 1991). An important is leader's role in building an organizational culture, where he has an irreplaceable place to build a confidential environment because, in the absence of confidence, all decisions and implementation of the chosen strategy are doomed to failure (James and Woten, 2010). Talented people are currently considered the most valuable capital, the role of the leader is to recognize the talent of their followers and to assign appropriate work to develop their talent and exploit their full potential within the enterprise (Ulrich et al., 2012). A separate chapter is the role of the leader and in the context of managing change, and crisis management, where their proactive approach and ability to make quick decisions is welcomed (James and Woten, 2010).

One of the actual typology of leadership effectiveness represents the dynamic five-factor model of leadership, created by Seiler and Pfister (2009). This model originated from the Complex adaptive system theory (CAS) and Complex theory of leadership (CLT), which understand leadership as dynamic process contains more independent, nevertheless cooperating variables (agents). Authors are focused especially on the person of leader, as important, active part of this dynamic five-factor model illustrated below in the figure number 1. In our research, we are focused at the first peremptory factor of leader effectiveness represented by these five facets of individual leader competences.

Table 1. Five Factors, Main Components, and Examples		
Factor	Components	Examples
Individual competence	Professional competence	Job knowledge; technological knowledge
	Strategic competence	Strategic decision making; knowledge management; problem-solving skills
	Personal competence	Stress-resistance; self-motivation; hierarchy awareness
	Social competence	Empathy; tolerance; communication skills; leadership skills
	Intercultural competence	Foreign language knowledge; knowledge of foreign cultures and countries
Group	Structural aspects	Group composition; objectives and duties; norms and roles
	Dynamic aspects	Relationships; communication; group dynamics
Organization	Strategy	Internationalization, expansion, downsizing; reward, salary, bonus systems; company goals
	Structure	Hierarchical structure and responsibilities; infrastructure
	Processes	Standardized processes; knowledge transfer and management
	Culture and climate	Feedback culture; error management culture; ethical climate
Context	Static components	History; geography; national culture
	Dynamic components	Political, economical, and social development; international treaties and law; weather
Situation	Clarity	Information availability; information ambiguity; information relevance
	Familiarity	Preliminary experiences with comparable situations; novelty of the situation
	Pressure	Pressure for decision and action; time pressure; danger

Figure 1 Dynamic five-factor model of leadership (Seiler and Pfister, 2009)

Here we see the main components defined in five fields represented by competences of the leader itself (soft as well hard personal characteristics), the influence of group lead by the leader, the influence of organization where leader work, the influence of particular task and situational external social and political factors.

Individual competence includes all the individual capabilities, knowledge, and experiences of a leader. Undoubtedly, individual competence is the foundation for successful leadership. An individual has the most direct control over his or her own behavior. Many studies that examine leadership competencies provide typologies or lists of relevant skills and attributes. Abraham et al. (2001), for example, found that skills such as communication, team building, problem solving and decision-making are important for effective leadership. Kirkpatrick and Locke (1991) stated initiative, intelligence, and business knowledge are key determinants of successful leadership behavior. Ireland and Hitt (1999) added flexibility, strategic thinking, and teamwork. Propp, Glickman, and Uehara (2003) included other leadership core competences such as experience, technical skills, the ability to manage relationships, and acknowledgment of informal organizational structure. Brownell (2008) examined a range of leadership competencies and found team leadership, effective listening, coaching, feedback, and conflict management as well as trustworthiness, integrity, positive attitude perseverance, and flexibility among the most important skills and abilities. To identify the main components of this factor, Bolten's

model of international leadership competencies (2005) was adopted. He defined five key competencies for international leaders: professional, strategic, personal, social, and intercultural. Professional competence refers to all knowledge and abilities related to performing in the current function, such as market knowledge, work knowledge, technical knowledge, and so on. Strategic competence includes all knowledge concerning strategic decisions and their implementation within the organization. Risk, cost and profit awareness, knowledge management, problem solving, and decision-making skills are examples. Personal competence refers to the ability to perform as an individual and to have the ability for self-development. Self-motivation, stress resistance, ability to self-criticize, and hierarchy awareness are part of this competence. Social competence refers to abilities that are important in interactions with others. It includes teamwork, empathy, tolerance, taking the initiative, communicating, and leading. Intercultural competence includes the capability to master foreign languages, possess some knowledge of domestic and foreign cultures as well as intercultural processes, and being open minded to intercultural learning and tolerant toward cultural ambiguities (Seiler and Pfister, 2009).

## RESEARCH

### *Sample*

There was conducted the quantitative research among 96 manufacturing companies. The sample was randomly selected based on willingness of CEOs to cooperate voluntarily with researchers, and its layout copies the representation of international manufacturing company in the basic set of Czech international manufacturing companies. During the three-month phase in 2017 (1/2017 – 4/2017) we have obtained questionnaire responds from 54 South Moravian international manufacturing companies' CEOs.

There were collected overall information about our respondents. The gender were in 74% male and 26% female (see fig. 2). The number of followers were in 44,4% more than 10 people in managed group and in 55,6% the CEOs had less than 10 followers (see fig. 3). We had been interested in the experience of the leaders and results are showing that the most of our respondents are working in this position from 4 to 7 years (see fig. 4).

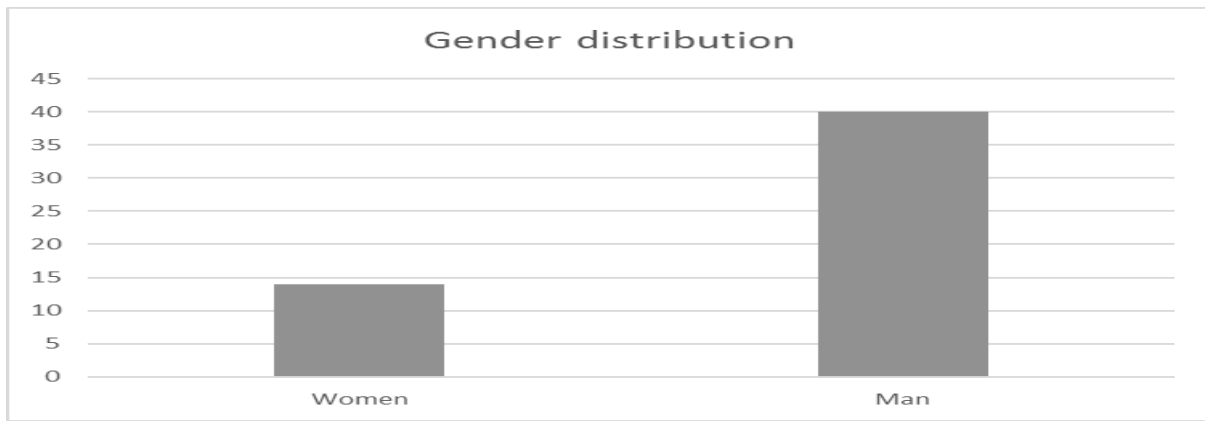

Figure 2. Gender distribution in the research sample

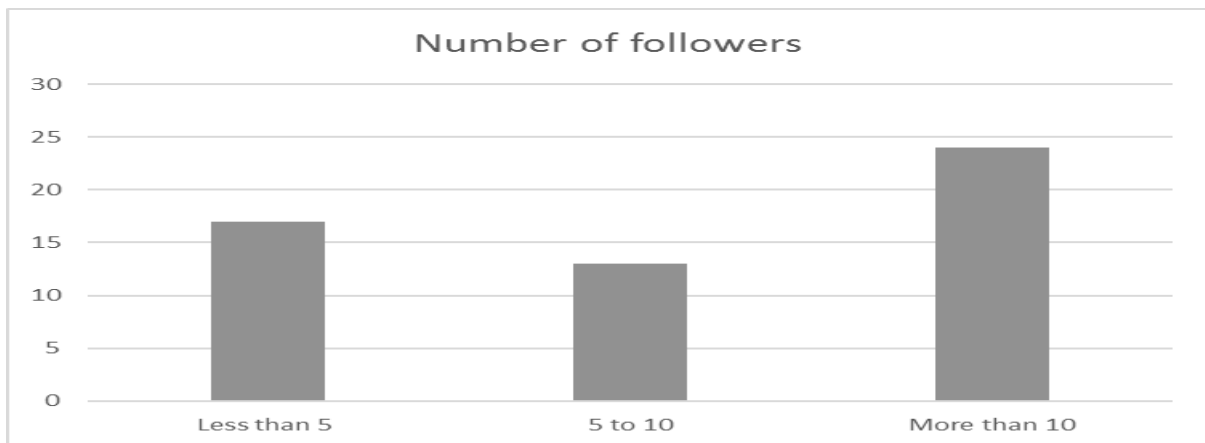

Figure 3. Number of followers



Figure 4. Years of experience of the leaders

*Research questions*

The total of 25 questions, mapped 5 groups of interest of company CEO competencies (see table 1).

Topic ID	Topic name	Number of questions
1	Evaluation of competence significance in the company	25
1.1	Technical (professionally expert)	5
1.2	Strategic	5
1.3	Personality	5
1.4	Social	5
1.5	Intercultural	5

Table 1. *Structure of researched fields (Source: Own work, based on collected data)*

The survey data shows differences how respondents perceive different competences. The respondents provided two perspectives – how the competence is important and how often the competence is used in their position. They rated both perspectives on the scale from 1 to 5, where 1 means that the competence is not important at all and 5 means the competence is of very high importance. The same for frequency of use – 1 means the competence is used very occasionally, 5 mean it is used very often. In order to estimate overall significance of individual competences, we multiplied the frequency and importance. Table 2 shows the individual competences as well as their mean values.

Topic ID	Factor	Importance	Frequency	Significance
1.1	Knowledge of economics and finance	3,6	3,6	13,9
	Professional knowledge of the field	4,3	4,4	19,3
	Knowledge of labor law	3,0	2,8	9,4
	Knowledge of ICT	3,5	3,9	14,3
	Ability to make decisions	4,7	4,7	22,4
1.2	Ability to manage time	4,3	4,1	18,2
	Ability to organize the work of subordinate collaborators	4,4	4,4	19,9
	Ability to formulate an attractive vision of the future	3,5	3,0	11,3
	Ability to carry risk	4,3	4,0	17,6
	Ability to transfer key knowledge and experience	4,0	3,7	15,2
1.3	Ability to work under pressure and stress	4,2	3,6	16,0
	Creative thinking	3,9	3,6	14,5
	Positive thinking	4,0	4,1	16,8
	Natural authority	4,1	4,0	17,0
	Ethical behavior	4,4	4,3	19,5
1.4	Ability to negotiate	4,5	4,6	20,6
	Ability to work in a team	4,5	4,4	19,8
	Ability to solve conflicts	4,3	3,6	15,6
	Empathy	3,8	3,6	14,1
	Ability to motivate	4,1	3,8	16,0
1.5	Professional English language skills	3,6	3,3	13,2
	Professional German language skills	2,7	2,1	6,7
	Other language skills	2,3	1,8	4,6
	Knowledge of other nations' culture	2,5	2,1	6,4



Approach to working abroad	2,8	2,3	7,7
----------------------------	-----	-----	-----

Table 2. *Competences and their importance, frequency and significance* (Source: authors' own composition based on the survey)

### *Discussion*

The most significant competencies were (in order) ability to make decisions (s=22,4), ability to negotiate (s=20,6), ability to organize the work of subordinate collaborators (s=19,9), teamwork (s=19,8) and ethical behaviour (s=19,5).

On the other hand among the least significant competences were identified non-English language skills (s= 4,6) and knowledge of other nations' culture (s=6,4). An interesting finding is the low level of perceived significance of German language skills (s=6,7) and low level of be capable to work abroad (s=7,7). When discussing low level of German language skills, there is a fact that our republic is the neighbor to the Austria and Germany. Despite that, it could be explained due to the willingness of German nations to speak English. Next up the lower score of working abroad could be explained as the historical consequences of almost 40 years of closed borders.

Due to our focus at companies operating in the international environment there hadn't been found any more significant competence of leaders in the intercultural field than ability to master the English language (s=13,2). Other identified competencies weren't in any special relation to international environment. In the field of technical competencies were the most important the ability to make a decision (s=22,4) and on the other hand as almost useless shows the competence of labor law understanding (s=9,4). In the field of strategic competencies was identified as the most important the ability to organize work of subordinates (s=19,9) and the lowest score gain the ability to formulate an attractive vision of the future (s=11,3). This competency overall gain the average evaluation however due to the low frequency of use, the final score expressed by the significance was quite low. In the field of social competencies the most important competency is ability to negotiate (s=20,6) and what is remarkable, there had been identified relatively low score for empathy (s=14,1). This may pose some problems in the future, because leadership is based on the relationship with followers and the empathy plays its important role here. Finally in the field of leader personality the most important is ethical behavior (s=19,5) and the other personality competencies gain mostly average evaluation. (see figure 5.).

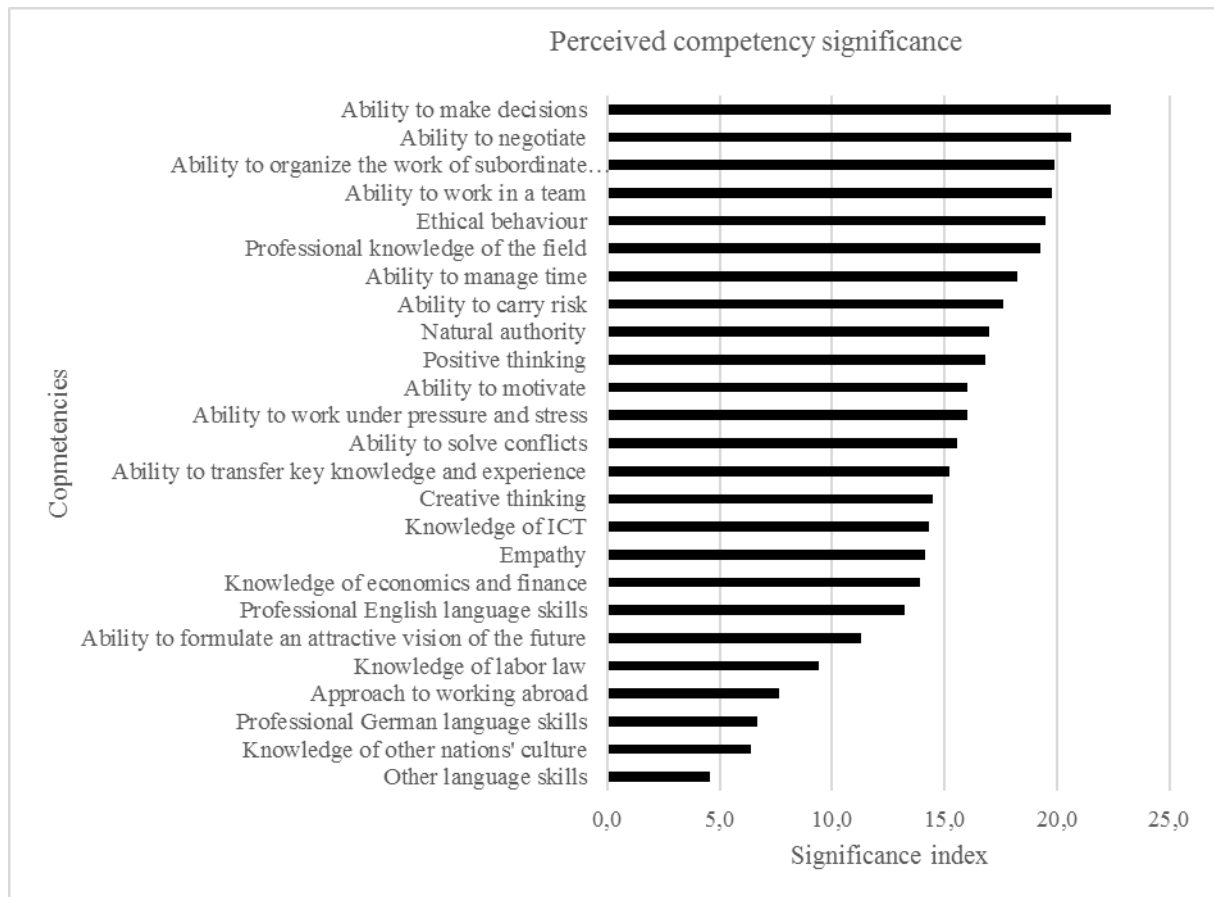

Figure 5. *Perceived competency significance of leaders in the international environment*

## CONCLUSION

In the studies conducted so far, the values of the staff were examined in the context of the management of international teams (Hofstede, 1993, 1999, 2001, Trompenaars, 2000, Shalhoop, Sanger, 2012), behavior of managers in international environment (Thomas, 2002, , Nový, Schroll-Machl et al., 1999) and styles of leadership in different cultures (House, Javidan, Dorfman, Gupta, 2004, Dědina, Odcházal, 2007). Realized studies have shown a significant influence of managers on the behavior and performance of other staff (e.g. Hagberg, Heifetz, 2000, Dolan, Garcia, 2002, Dolan et al., 2006 and others). Output of several comparative international studies (Thomas, 1996, Stumpf, 2005, House, et al., 2004) was the definition of the personality profile of a successful international manager, i.e. assumptions that managers in a multicultural environment would unconditionally be able to be well-oriented in the environment of multinational companies, and to perform the performances expected from them. In addition, there are defined procedures recommended for managers working in a multicultural environment to form and consolidate their position in international companies (Schein, 1996, Thomas, 2000, Bolten, 2005, DeSanctis, Silberzahn, Chen, 2012).

In the research projects carried out up to now in Czech Republic were examined the specificities of manager behavior (Nový, Schroll-Machl, 1999, Dědina, Odcházal, 2007) using the tool developed in western economics, which were not adjusted to Czech conditions (Dědina, Odcházal, 2007). Regarding this topic were carried out several – but sporadic case studies describing the environment one particular enterprise (e.g. Groenwald, 1998)

Our study continues with this extensive research of managerial competencies and presents materials allowing us to create competency model based on the results of the behavioral research of managers. This competence model will cover competencies that have been identified as the most important for managers in the role of leaders across companies operating in an international environment. Next up this competency model will serve HR specialist during the recruitment and as well professional development and training of the managers who would be perceived as a leaders in their profession.

## REFERENCES

- Abraham, S. E., Karns, L. A., Shaw, K., and Mena, M. A. (2001), Managerial competencies and the managerial performance appraisal process. *Journal of Management Development*, 20 (9/10), 842–853.
- Armstrong, M. and T. Stephens. (2015), *Řízení lidských zdrojů: moderní pojetí a postupy*: Praha: Grada Publishing, ISBN 978-80-247-5258-7.
- Bolten, J. (2005). *Interkulturelle Personalentwicklungsmaßnahmen: Training, Coaching und Mediation* [Intercultural personnel development treatments: Training, coaching and mediation]. In G. K. Stahl, W. Mayrhofer, & T. M. Kühlmann (Eds.), *Internationales Personalmanagement* (pp. 307–324). Munich, Germany: Hampf.
- Brownell, J. (2008), Leading on land and sea: Competencies and context. *International Journal of Hospitality Management*, 27, 137–150.
- Dědina, J. and J. Odcházal (2007), *Management a moderní organizování firmy*. 1. vyd. Praha: Grada, 2007, 324 s. ISBN 978-80-247-2149-1, 2007.
- Desanctis, G. and L. Jiang (2005), Communication and the learning effectiveness of multinational teams. In: *Managing multinational teams: Global perspectives*. Emerald Group Publishing Limited, p. 97-123.
- Doh, J. P., & Stumpf, S. A. (Eds.). (2005). *Handbook on responsible leadership and governance in global business*. Edward Elgar Publishing.
- Dolan, S. L., & Garcia, S. (2002). Managing by values: Cultural redesign for strategic organizational change at the dawn of the twenty-first century. *Journal of Management Development*, 21(2), 101-117.
- Dolan, S., S. Garcia and B. Richley (2006) *Managing by values: A corporate guide to living, being alive, and making a living in the 21st century*. Springer.
- Groenwald, H (1998), *Transformační procesy v řízení lidských zdrojů joint venture ŠKODA-VOLKSWAGEN*. Praha: VŠE.
- Hagberg, R., & Heifetz, J. (2000). *Corporate culture/organizational culture: Understanding and assessment*.
- Hofstede, G. (1993), Cultural constraints in management theories. *The Academy of Management Executive*, 7.1: 81-94.
- Hofstede, G. (1999), Problems remain, but theories will change: The universal and the specific in 21st-century global management. *Organizational dynamics*, 28.1: 34-44.
- Hofstede, G. (2001), *Culture's consequences: Comparing values, behaviors, institutions and organizations across nations*. Sage, 2001.
- House, R. J., Hanges, P. J., Javidan, M., Dorfman, P. W., & Gupta, V. (Eds.). (2004). *Culture, leadership, and organizations: The GLOBE study of 62 societies*. Sage publications.
- Ireland, R. D., and Hitt, M. A. (1999). Achieving and maintaining strategic competitiveness in the 21st century: The role of strategic leadership. *Academy of Management Executive*, 13 (1), 43–57.
- Kirkpatrick, S. A., and Locke, E. A. (1991). Leadership: Do traits matter? *Academy of Management Executive*, 5(2), 48.

- Kubeš, M., Spillerová, D. and Kurnický, R. (2004), *Manažerské kompetence: Způsobilost výjimečných manažerů*. Praha: Grada Publishing, 184 s. ISBN 80-247-0698-9.
- Mikušová, M. and A. Čopíková (2015), *Vytvoření modelu kompetencí krizového manažera malého podniku za použití saatyho metody*. Scientific Papers of the University of Pardubice. Series D, Faculty of Economics [online], 22(33), ISSN 1211555X.
- Nový, I., & Schroll-Machl, S. (1999). *Interkulturní komunikace v řízení a podnikání*. Praha.
- Pavlica, K. E. Jarošová, and R. Kaiser (2013), "Integrating Management Competencies Development with an Organizational Culture Formation", *Organizacija*, 46, 5, 186-195.
- Plamínek, J. and R. Fišer (2015), *Řízení podle kompetencí*. Praha: Grada, 2015. Expert (Grada). ISBN 80-247-1074-9.
- Propp, D. A., Glickman, S., & Uehara, D. T. (2003), ED leadership competency matrix: An administrative management tool. *American Journal of Emergency Medicine*, 21(6), 483–486.
- Prusak, R. (2016), The impact of employee competencies management as part of the human capital on the intellectual capital implementing process. *Management (1429-9321)* [online]. B.m.: De Gruyter Open, 5., 20(1), 27–39. ISSN 14299321.
- Seiler, S. and A. Pfister (2009), "Why did I do this?" Understanding leadership behavior based on a dynamic five-factor model of leadership. *Journal of Leadership Studies*, 3, 41-52.
- Schein, E. H. (1996). Three cultures of management: The key to organizational learning. *Sloan management review*, 38(1), 9.
- Shalhoop, J. and M. Sanger (2012), Understanding leadership in China: leadership profiles of state-owned enterprises, multinational corporations, and major economic trading partners. In: *Advances in global leadership*. Emerald Group Publishing Limited, p. 321-348
- Silberzahn, R. and Y. Chen (2012), Toward Better Understanding of Interaction Dynamics in Multicultural Teams: A Status Perspective. In: *Looking Back, Moving Forward: A Review of Group and Team-Based Research*. Emerald Group Publishing Limited, p. 327-357."
- Finnemore, M., Scott, W. R., Meyer, J. W., Thomas, G. M., Meyer, J. W., Ramirez, F. O., ... & Bergesen, A. (1996). Norms, culture, and world politics: insights from sociology's institutionalism.
- Thomas, D. C. (2002). *Essentials of international management: A cross-cultural perspective*. Sage Publications, Inc.
- Trompenaars, F. and P. Woolliams (2000), *When two worlds collide*. Amsterdam: THT, Intercultural Management Consulting.

## MANDATORY ENTREPRENEURS' CHARACTERISTICS TO NEW VENTURES' INTERNATIONALIZATION

Meneses, Raquel<sup>1</sup>; Moutinho, Nuno<sup>1</sup>; Azevedo, José<sup>2</sup>

<sup>1</sup>School of Economics and Management of the University of Porto (FEP)

<sup>2</sup>Faculty of Arts and Humanities of the University of Porto (FLUP)

### ABSTRACT

As International New Ventures are defined as firms that internationalizes almost since inception, many researchers have linked their nature to entrepreneurs' characteristics. This study will try to define what entrepreneurs' individual features are really necessary to international new ventures, using semi-structured interviews to the owners of 21 Portuguese companies from the technological sector and performing a fuzzy-set qualitative comparative analysis (fsQCA). Previous work has failed to address this question, may be because this methodology capable of examining complex causal situations is rarely used. Our major finding is that for a firm to have an early process of internationalization it is absolutely necessary that the entrepreneur has a previous international network of contacts. All other individual characteristics of the entrepreneur were not considered mandatory although some combinations of them would lead to the same result.

*Keywords: Entrepreneurship; Entrepreneurs; Networks; Social Capital; fsQCA; Global Orientation; International New Ventures*

### INTRODUCTION

Traditionally, internationalization is seen as a gradual time-consuming process, based on firms' knowledge (Johanson and Vahlne, 1977), or on firms' contact (Johanson and Matsson, 1987; Johanson and Vahlne, 2011). In those approaches, the entrepreneur is invisible. More recently, literature about international entrepreneurship (Oviatt and McDougall, 1994, 1997, 2005) makes entrepreneur a central piece in internationalization. International New Ventures are firms that internationalizes almost since inception (Oviatt and McDougall, 1997). Many researchers have studied different entrepreneurs' characteristics and their consequences on firms' internationalization. However, nobody knows what entrepreneurs' characteristics are really necessary to international new ventures.

This paper is based on the fuzzy-set qualitative comparative analysis (fsQCA). The literature shows that this method is suitable for the examination of complex causal situations (Ragin, 2008). Therefore, it can show how the characteristics of companies (causal conditions) can be combined in different

ways to reach the same solution (their own brand production - outcome), and what configurations are necessary or sufficient (Fiss, 2011).

This paper proceeds in the following way: the next section discusses the process of internationalization in the new ventures cases, and the impact of objective and subjective characteristics of entrepreneurs on it. The third section describes the fzQCA and presents the results. The following sections are the analysis and the conclusion, which identifies the limitations of the study and formulates suggestions for future research.

## **INTERNATIONALIZATION OF NEW VENTURES**

Traditionally, internationalization is seen as a gradual process, based on firm experiential knowledge (Johanson and Vahlne, 1977). Firms need time to develop a domestic base and then progressively enters in closer markets. Internationalization gives more experience and it makes possible to go further. Rennie (1993) claims that there is a new type of firms that consider the world as their market almost from inception, and Cavusgil (1994, p.18) states that “gradual internationalization is dead” and “small is beautiful”. The works of Oviatt and McDougall (1994, 1997) develop a new approach and the study of International New Ventures is very important since the nineties. This new trend is based on technological development, new market conditions and people characteristics (Nummela et al., 2004). Now, the entrepreneur is seen as playing a key role in all process.

This vision is not completely new. Bilkey and Tesar (1977) show the importance of entrepreneurs in all internationalization process. Miesenbock (1988) claims that decision-maker is the key variable in small business internationalization. Thus, people with different traits influence firms’ internationalization differently. Thus different entrepreneurs’ stories will give different firms’ stories, too. Ghannad and Andersson (2012, p. 148) claim that a “good understanding of the firm’s development could be reached by studying the entrepreneurs’ backgrounds”. So, it is important to know if there is any entrepreneur characteristic that is necessary or sufficient to the internationalization of the firm.

According to Westhead et al (2001), older entrepreneurs have more contacts, experience and management know-how, so their firms are more likely to be exporters. These international contacts and international experience play a key role in all internationalization process (McDougall et al., 1994; Madsen and Servais, 1997; Nummela et al., 2004). However, Andersson et al. (2004) found that younger entrepreneurs are more prone to internationalize firms than older ones. So, there is no consensus about the influence of age in internationalization.

According to Andersson (2000, p. 80), “the technical entrepreneur’s main interest is technology” and “internationalization is not the main interest of this entrepreneur”. Therefore, technical entrepreneurs

delay firms' entry in foreign markets, so it is expectable that firms with entrepreneurs with very technical formal education are not international new ventures.

On the other side, marketing entrepreneur "is proactive in the internationalization process and is creating new channels to reach the customer" (Andersson, 2000, p. 80). Marketing entrepreneur must be present in international new ventures.

Social capital is often defined as the sum of resources that a firm (individual, organization) can access or mobilize by virtue of possessing a durable network of relationships (Bourdieu and Wacquant, 1992). More recently, literature has been enlightening not only organizational but also inter-personal relations. These relationships enable partners to get more contacts, more information, to get closer to resources, and to know opportunities (Hakansson and Snehota, 1995; Harris and Wheeler, 2005). As Harris and Wheeler (2005, p. 189) note: "The individuals with whom entrepreneurs hold personal relationships offer access to their own network of relationships in other countries, from simple contacts to deeply trusted relationships", so these relations could play an important role in overcoming internationalization problems (Ghauri et al., 2003).

Global orientation is a managers' positive attitude to international affairs and their capacity to adapt to foreign markets (Nummela et al., 2004). Firms with entrepreneurs with global orientation will internationalize easier and faster (Bloodgood et al. 1996; Ghanmand and Andersson, 2012). Dremann et al., (2005) and De Vries and Florent-Treacy (2003) demonstrate how important childhood is to understand entrepreneurs' mindset. So, this global orientation could be a consequence of foreign or migrant parents. If a person grows up within an international environment, it has a borderless vision of the world. At the same time parents had established social connection in diverse countries and second-generation could exploit those networks. This global orientation could result from international experience from living abroad, in diverse countries, too. On the other side, Zou (2007) states that international knowledge of entrepreneur is not a determinant of firm internationalization, only the capacity to detect opportunities.

Kirzner (1973) argues that the opportunities exist in the market; they arise because markets are never in equilibrium. However, only some people recognize them. Nowadays, the principal role of entrepreneurs is seen as an opportunity of discovery and exploitation (Mainela et al., 2014). Opportunities exist, independently of people being aware about their existence. (Alvarez and Barney, 2007). So, it is important to be conscious of what is happening around the world to capture and leverage opportunities. According to that thought, general awareness facilitates internationalization of new ventures.

Based on the literature review and following fsQCA, this study proposes the following:

- Marketing Entrepreneur Mindset, International Social Capital, and General Awareness are necessary conditions for internationalization.
- Single causal conditions may be present or absent within configurations of internationalization, depending on how they combine with other causal conditions.
- No single best configuration of conditions leads to internationalization, but there exist multiple, equally effective configurations of causal conditions.
- The presence or absence of age, individually or combined, can either promote or inhibit internationalization.
- Technical entrepreneur mindset must be absent to get internationalization.

## METHOD

Because the literature of international entrepreneurship never studied the existence of necessary conditions, a qualitative analysis is the most appropriate methodology (Eisenhardt and Graebner, 2007). According to Ragin (2000), the fsQCA method favors the dialogue between empirical evidence and theory and therefore it allows results to support the whole analysis. This explicit iteration provides a deeper understanding of case studies by reaching different solutions for different cases. So far, its application to the study of companies has been limited (Felício et al., 2015), and as best as our knowledge, it has never been applied in international entrepreneurship studies.

This method establishes a bridge between the case-oriented approach that treats cases as whole and the variable-oriented approach that uses a “half-verbal-conceptual and half-mathematical-analytical” language (Ragin, 2000, p. 4). For that reason, one of the great advantages of the fsQCA is that through Boolean algebra and algorithms, this method reduces a large number of causal conditions to a much smaller number of configurations that lead to the outcome (Felício et al., 2015), thus treating cases as a whole.

This study analyses 21 Portuguese companies from the technological sector to remove contextual differences. All of the companies are less than 6 years old (to be considered new), and some have already internationalized (they are international new ventures). Table 1 shows the companies considered in the present study.

Table 1 – Companies in the sample

Agri Marketplace	A B2B global online marketplace where farmers and industry/retailers can make business transactions, supported by premium partners.
Agroop	A farm management application capable of managing operations in an intuitive, collaborative and efficient way.
Baseform	It makes forward-thinking software for networked water infrastructures, offering



		best-in-class SaaS analytics and planning solutions.
B-Guest		A Guest Engagement Platform that has been designed to shorten the distance between hotels and guests, connecting them in the best possible way.
Biti		A media environment designed for children to enjoy full autonomy in their digital world, allowing parents to draw the limits.
Black Block		A hybrid solar drying system, designed to dehydrate food and agribusiness products – such as aromatic herbs.
Brain-e		An online platform where everyone can manage the energy consumption and be sure to save money every month.
Change	Tomorrow	It provides a do-it-yourself like and easy to use Participatory Democracy platform capable of adapting to the best practices as well as local specificities.
City Guru		A web and mobile app providing direct access to local guides (professional and amateur) and allowing a personal contact through real time chat.
Clickly		An in-article content discovery technology that allows readers to discover relevant content in an interactive format.
Cuckuu		A social network that allows anyone to surprise and be surprised at the right time, turning trivial moments into something people will never forget.
Egg Electronics		Manufacturer of personal premium quality charging devices that blends user-centered product engineering with design.
Eguru		An app using a crowdsourced pool of drivers and a logistics algorithm used to transform the delivery of any item a quick and effortless activity.
Eventfuel		Mobile apps for events with the purpose of giving to attendees a rich experience featuring speaker profiles, session summaries, automatic check in, push notifications, live polls and per session feedback.
Fibersail		A shape sensing system based on FBG fiber optic research to monitor and analyze windmill blades in terms of shape, condition and behavior.
Graf.ly		Digital newsroom platform that puts journalists and editors in full control, and help media organizations to focus on content and monetization, not tools.
Learninghubz		Online platform and curation tools bringing together the best online business management training with internally produced and curated video training.
Probe.ly		It performs scans of web applications and lifecycle management of the vulnerabilities found in a sleek and intuitive web interface.
Sensefinity		It provides Internet of Things for the masses, since projects can immediately start using data gathered from their assets and delivered by their ubiquitous GSM data-pipe with multinational companies and worldwide coverage.
Spindots		It provides management, design and programming of web portals, information systems and decision support, customer relationship management, platform management, training and advice on information systems

Trigger systems Platform to control irrigation systems using exclusive calculation models based on weather forecasts determining the exact amount to irrigate.

. The analysis uses documents, interviews, and news in the press. The leading sources of information are the semi-structured interviews with the sample companies' owners. The information requires interpretation and coding that results in 8 categories reflecting the causal conditions that lead to brand creation as an outcome (see Table 2).

Table 2 – Causal Conditions

Category	Label	Meaning
Age of entrepreneurs	Age	Age of entrepreneurs on the inception date (1 - less than 30 years old; 0,5 - between 30 and 40; and 0 - more than 40)
Global Orientation	GlobOr	A borderless mindset resulted from childhood exposure to international environment, based on nationality, parents' nationality, and international migration or deep and diverse international not work experiences (between 0 and 1)
Technical Entrepreneur	Tec	Entrepreneur with more technical skill, according to formal education (between 0 and 1)
Marketing Entrepreneur	Mark	Entrepreneur with more marketing skills, according to formal education (between 0 and 1)
International Network	Net	How large is the entrepreneur's international network (between 0 and 1)
General Awareness	Int	How curious about macro-environment entrepreneurs are, based in newspapers and general reviews readings (between 0 and 1)
International Mobility	IntMob	How many trips have entrepreneur did during this project (between 0 and 1)
Previous Entrepreneur Experience	PrevEnt	If entrepreneurs had had any previous experience as entrepreneurs based on the number of firms he had already created (between 0 and 1)

As a multiple stage analytic procedure, we have several steps. The first step was the selection of the theoretical attributes. In our study, these attributes were entrepreneurs' age (when the firm was created); global orientation (childhood international exposition, international experience, and international diversity - number of different countries); educational background (technical entrepreneur; marketing entrepreneur); previous entrepreneur experience; international network; and general concern.

The second step was, according to Ragin (2008), the establishment of a score with six fuzzy-set values (0 – fully out; 0.2 – mostly but not fully out; 0.4 – more or less out; 0.6 – more or less in; 0.8 – mostly but not fully in; and 1 – fully in) for each category in each case.

As explained above, the outcome is internationalization. Two different approaches were used: 1) Business Internationalization - a dichotomous outcome (1, if firm has any international experience and 0 otherwise); 2) International Commitment - a fuzzy set outcome (between 0, if it is not present in any foreign country and 1, if it is present in more than four countries). Please refer to table 3.

Table 3 – Value of Conditions in Each Case (firm)

Cases	age	GolbOr	Mark	Tec	PrevEnt	Intwork	IntMob	Net	Int	BusInt	Commitm
1	0,5	1	0	0,2	0	1	1	1	1	1	0,4
2	1	0,4	0	1	0	0	1	0,4	1	1	0,2
3	0	0	0	0,4	0,5	0	0	1	1	1	1
4	1	0,4	0	1	1	0,5	1	1	0,8	1	0,6
5	1	0,5	0	1	0	0	1	1	0,4	1	1
6	0	1	1	0	0	1	0	0,8	1	0	0
7	0,5	0	0	1	0	0	0	0,4	0,8	0	0
8	0,5	0,6	0	0,6	0,5	1	0	0	1	0	0
9	0,5	0,8	0,6	0,4	0,5	0,5	1	1	0,4	1	1
10	0	0,8	0	1	0,5	1	1	1	0,4	0	0
11	0	0,5	0	1	1	1	1	0	1	0	0
12	0,5	0,4	0	1	1	0	1	1	1	1	0,6
13	0,5	0	0	0,4	1	0	1	1	1	1	0
14	0	0,2	1	0	0	0	1	0,8	1	0	0,2
15	0,5	0,8	1	0	1	1	1	1	1	1	0,8
16	0	0,8	0	1	0	1	1	1	1	1	1
17	1	0,4	0	1	0	0	0,5	0,6	0,6	1	0
18	0	0,6	0	1	1	0	0	0	1	0	0
19	0	1	0	0,4	1	1	1	1	1	1	0,4
20	0	0,4	0	1	0	0	0	0	0,8	0	0
21	0,5	0,2	0	1	0,5	0	0,5	1	0,8	0	0

In what concerns entrepreneurs' age, our sample was very diverse: four companies with young entrepreneurs (less than 30 years old), 8 cases with entrepreneurs between 30 e 40 years old, and the majority (9 cases) had entrepreneurs older than 40 years.

The international exposition of entrepreneurs presented a great diversity, varying between what we consider a completely international exposition (resulting from a childhood experienced abroad and /or more than one year living abroad – 8 cases), to a total absence of any kind of international experience (4 cases). In the middle ground, we found 9 entrepreneurs with some international exposition.

In the group of completely international experience, six have already lived in more than 4 different countries, one in three different countries, and one in only one country.

In terms of the educational background, 3 entrepreneurs were considered marketing entrepreneurs (as they completed formal education in Management) and 12 as technical entrepreneurs (formal education in technical or technological areas).

Considering the main type of network presented, we found 12 entrepreneurs with a completely international network, and only 3 with a completely domestic one.

In what concerns the outcome, 12 firms were already internationalized and only 9 were not.

## RESULTS

Table 4 shows the results for the necessary conditions. In theory, the outcome is a subset of necessary conditions, so “it does not say anything for the cases disclosing the outcome” (Bol and Luppi, 2013, p. 205).

Table 4 – Necessary conditions

Outcome variable: busint		
Conditions tested:		
	Consistency	Coverage
age	0.541667	0.812500
~age	0.458333	0.423077
golbor	0.541667	0.601852
~golbor	0.458333	0.539216
mark	0.133333	0.444444
~mark	0.866667	0.597701
tec	0.650000	0.541667
~tec	0.350000	0.636364
prevent	0.500000	0.631579
~prevent	0.500000	0.521739
intwork	0.416667	0.555556
~intwork	0.583333	0.583333
intmob	0.875000	0.750000
~intmob	0.125000	0.214286
net	0.916667	0.733333
~net	0.083333	0.166667
int	0.850000	0.566667
~int	0.150000	0.600000
Outcome variable: commitment		
Conditions tested:		
	Consistency	Coverage
age	0.513889	0.462500
~age	0.625000	0.346154
golbor	0.680556	0.453704
~golbor	0.513889	0.362745
mark	0.222222	0.444444
~mark	0.777778	0.321839
tec	0.666667	0.333333
~tec	0.416667	0.454545
prevent	0.472222	0.357895
~prevent	0.527778	0.330435
intwork	0.500000	0.400000
~intwork	0.555556	0.333333
intmob	0.861111	0.442857
~intmob	0.138889	0.142857
net	1.000000	0.480000
~net	0.055556	0.066667
int	0.833333	0.333333
~int	0.194444	0.466667

Ragin (2008) argues that we should not accept conditions with consistency values below 0.75 and states that “in the case of necessary conditions, the consistency value should be set much higher”, so we decide to use a cut point of 0.9.

Hence, the data from Table 4 shows that in order to internationalize (independently the way we evaluate internationalization), entrepreneurs must have an international network. It is very interesting to note that having an international network required a deep commitment. This result confirms the crucial role of social capital (international networks). On the other side, it contradicts the idea that Marketing entrepreneurs and Global Orientation are necessary conditions.

#### *Reassessing Cases*

The next step is to generate a truth table (in the appendix) with the fsQCA program (Ragin et al., 2006) to produce the distribution of the 21 cases by the possible combinations. According to Ragin et al. (2008, p. 75) “the truth table algorithm incorporates a two-stage analytic procedure.” The second step is to specify the possible causal conditions vis-a-vis the outcome.

The fsQCA 2.5 allows a complex solution, a parsimonious solution and an intermediate solution. Rihoux and Ragin (2009) find that an intermediate solution is superior, so we use that to take conclusions. According to literature review, we consider that Age could be absent or present, Technical Entrepreneur should be absent; Marketing Entrepreneur should be present; Social Capital should be present; Global Orientation could be present or absent; and General Awareness should be present.

```
File: F:/RootsandWings/Final/Roots e wings.csv
Model: commitment = f(age, golbor, mark, tec, prevent, intwork, intmob, net, int)
```

	raw coverage	unique coverage	consistency
int*intmob*~mark*~golbor*age	0.275000	0.258333	0.868421
int*net*intmob*intwork*~mark*golbor*~age	0.225000	0.208333	0.870968
solution coverage: 0.483333			
solution consistency: 0.865672			

```
File: F:/RootsandWings/Final/Roots e wings.csv
Model: commitment = f(age, golbor, mark, tec, prevent, intwork, intmob, net, int)
```

	raw coverage	unique coverage	consistency
int*net*intmob*intwork*prevent*golbor*~age	0.180556	0.069444	0.565217
int*net*intmob*intwork*tec*golbor*~age	0.250000	0.138889	0.818182
solution coverage: 0.319444			
solution consistency: 0.696970			

*International Business (yes/no)*

From all possible combinations, seven of them reflect the case studies, and therefore all others are removed. From among the seven, three have a consistency above 0.75, and for that reason are assigned the value of one while the remaining is assigned the value of zero.

Table 5 shows that two combinations of solutions generate the same outcome (internationalization). The intermediate solution generates a very good value for consistency (0.8656), while coverage is good (0.483).

This result reflects two conditions present in all of the solutions (int, and intmob). It highlights the idea that entrepreneurs should be very active and aware about what is happening (Zou, 2007). Surprisingly, marketing entrepreneur must be absent in both recipes.

So, there are two possible recipes to get internationalization before firms are 6 years old:

- int\*intmob\*~mark\*~globo\*age

Thus, international new ventures can have older entrepreneurs if they are fully aware about what's happening (to detect opportunities), and if they present an international mobility. Educational background and global orientation seem to be confounding variables.

- int\*net\*intmob\*intwork\*globo\*~mark\*~age

Thus, firms with young entrepreneurs, interested in what is happening, with international network, and international and diverse work experience, and with global orientation could be international new ventures too. Educational background seems to be a confounding variable.

*International Commitment (number of countries)*

From all possible combinations, seven of them reflect the case studies, and therefore all others are removed. From among the seven, two have a consistency above 0.75, and for that reason are assigned the value of one while the remaining is assigned the value of zero.

Table 5 shows that two combinations of solutions generate the same outcome (internationalization). The intermediate solution generates not so good values for consistency (0.6969) and coverage (0.319).

It is very interesting to note that there are two recipes but they are very similar:

- int\*net\*intmob\*intwork\*prevent\*globo\*~age
- int\*net\*intmob\*intwork\*tec\*globo\*~age

Considering that, to be an international new ventures firms must have young entrepreneurs with social capital (international networks), very active (with awareness about what is happening and with international mobility), with international work experience and a global orientation. And with technical mindset or previous experience as entrepreneur.

These results confirm the idea that younger entrepreneurs present more proactivity so their firms show an earlier internationalization, confirming also the common sense thought that general awareness is very important (to detect opportunities) and international knowledge (resulting from global orientation or from international work experience) is very important to accelerate internationalization process. On the other side, according to those results, technical entrepreneurs are important. The explanation could be that in order to expand so quickly, firms must have a very innovative product and technical entrepreneurs are very concerned about product development.

Considering the onset propositions, the analysis produces the following conclusions:

- Entrepreneurs' International Network is a necessary condition for young internationalization.
- The recipes to go further (more than four countries) are more demanding than the recipes to start the process of internationalization.
- Marketing entrepreneurs could be an obstacle to begin the process of internationalization.
- No single best configuration of conditions leads to firms' internationalization.
- No recipe generates the entry in a high number of countries.

## CONCLUSION

This study investigates how some companies can internationalize in a very young age (less than six years old) using the fuzzy-set method for its investigation. The greatest advantage of this method is the admission of *equivinality*, that is, the recognition that "different equally effective configurations of conditions may lead or contribute to the same outcome" (Gonçalves et al., 2016, p. 3).

Hambrick and Mason (1984) argue that the company is a mirror of its managers. According to the network approach, liability of outsidership is the biggest obstacle to internationalize. Nevertheless, according to our study, new ventures could start internationalization if entrepreneurs have an international network. This is mandatory to go further in the internationalization process. Young, very active entrepreneurs (with general awareness, and international mobility), with global orientation and international work experience, with previous entrepreneur experience or technical mindset are two causal combinations that leads to more commitment to internationalization.

The importance of the technical mindset could be connected to the nature of the sample, as all 21 firms are technological. In this sector, innovation, namely technological development, is a distinctive factor. This point is a limitation of our work, so it is very important to repeat this methodology in others sectors. It is possible to include other entrepreneurs' traits like gender, formal education, work experience, or to include not only individual characteristics but all top management team features. Nevertheless, this study fills a gap in the literature, identifying mandatory individual characteristics of entrepreneurs to internationalize their companies almost since the inception.

## ACKNOWLEDGEMENT

*This work was supported by the Project "Roots and Wings: Glocalized Networks and Mobile Media Entrepreneurship in Austin and Lisbon"*

## REFERENCES

- Alvarez, S. A., and Barney, J. B. (2007). Discovery and creation: Alternative theories of entrepreneurial action. *Strategic entrepreneurship journal*, 1(1-2), 11-26.
- Andersson, S (2000), Internationalization of the Firm from an Entrepreneurial Perspective, *International Studies of Management and Organization*, Vol. 30 No.1, pp.63-92.
- Andersson, S (2004), Internationalization in Different Contexts, *Journal of Business Venturing*, vol. 19, pp. 851 - 875.
- Bilkey, W. J., and Tesar, G. (1977). The export behavior of smaller-sized Wisconsin manufacturing firms. *Journal of international business studies*, 8(1), 93-98.
- Bloodgood, J. M., Sapienza, H. J., and Almeida, J. G. (1996). The internationalization of new high-potential US ventures: Antecedents and outcomes. *Entrepreneurship: Theory and Practice*, 20(4), 61-77.
- Bol, D., and Luppi, F. (2013). Confronting theories based on necessary relations: making the best of QCA possibilities. *Political Research Quarterly*, 205-210.
- Bourdieu, P., and Wacquant, L. (1992). *Réponses*. Paris: Seuil, 4.
- Cavusgil, S. T., and Knight, G. A. (1994). A quiet revolution in Australian exporters. *Marketing News*, 28(11), 18-21.
- Drennan, J., Kennedy, J., and Renfrow, P. (2005). Impact of childhood experiences on the development of entrepreneurial intentions. *The International Journal of Entrepreneurship and Innovation*, 6(4), 231-238.
- Eisenhardt, K. M., and Graebner, M. E. (2007). Theory building from cases: opportunities and challenges. *Academy of Management Journal*, 50(1), 25-32.
- Felício, J. A., Duarte, M., and Rodrigues, R. (2015). Global mindset and SME internationalization: A fuzzy-set QCA approach. *Journal of Business Research*.
- Fiss, P. C. (2011). Building better causal theories: A fuzzy set approach to typologies in organization research. *Academy of Management Journal*, 54(2), 393-420.
- Ghannad, N., and Andersson, S. (2012). The influence of the entrepreneur's background on the behaviour and development of born globals' internationalisation processes. *International Journal of Entrepreneurship and Small Business*, 15(2), 136-153.
- Ghauri, P., Lutz, C., and Tesfom, G. (2003). Using networks to solve export-marketing problems of small-and medium-sized firms from developing countries. *European Journal of Marketing*, 37(5/6), 728-752.
- Gonçalves, H. M., Lourenço, T. F., and Silva, G. M. (2016). Green buying behavior and the theory of consumption values: A fuzzy-set approach. *Journal of Business Research*, 69(4), 1484-1491.
- Hakansson, H. S., and Snehota, I. (1995). *I.(1995), Developing relationship in business network*. London New York.
- Hambrick, D. C., and Mason, P. A. (1984). Upper echelons: The organization as a reflection of its top managers. *Academy of management review*, 9(2), 193-206.
- Harris, S., and Wheeler, C. (2005). Entrepreneurs' relationships for internationalization: functions, origins and strategies. *International business review*, 14(2), 187-207.
- Israel, K. (1973). *Competition and entrepreneurship*. The university of Chicago Press, Chicago.
- Johanson, J., and Mattsson, L. G. (1987). Interorganizational relations in industrial systems: a network approach compared with the transaction-cost approach. *International Studies of Management and Organization*, 17(1), 34-48.
- Johanson, J., and Vahlne, J. E. (1977). The internationalization process of the firm—a model of knowledge development and increasing foreign market commitments. *Journal of international business studies*, 8(1), 23-32.
- Johanson, J., and Vahlne, J. E. (2011). Markets as networks: implications for strategy-making. *Journal of the Academy of Marketing Science*, 39(4), 484-491.
- Madsen, T. K., and Servais, P. (1997). The internationalization of born globals: an evolutionary process?. *International business review*, 6(6), 561-583.
- Mainela, T., Puhakka, V., and Servais, P. (2014). The concept of international opportunity in international entrepreneurship: a review and a research agenda. *International Journal of Management Reviews*, 16(1), 105-129.



- Miesenbock, K. J. (1988). Small businesses and exporting: a literature review. *International Small Business Journal*, 6(2), 42-61.
- Nummela, N., Saarenketo, S., and Puumalainen, K. (2004). A global mindset—a prerequisite for successful internationalization?. *Canadian Journal of Administrative Sciences/Revue Canadienne des Sciences de l'Administration*, 21(1), 51-64.
- Oviatt, B. M., and McDougall, P. P. (1994). Toward a theory of international new ventures. *Journal of international business studies*, 25(1), 45-64.
- Oviatt, B. M., and McDougall, P. P. (1997). Challenges for internationalization process theory: The case of international new ventures. *MIR: Management International Review*, 85-99.
- Oviatt, B. M., and McDougall, P. P. (2005). Defining international entrepreneurship and modeling the speed of internationalization. *Entrepreneurship theory and practice*, 29(5), 537-554.
- Ragin, C. C. (2000). *Fuzzy-set social science*: University of Chicago Press.
- Ragin, C. C. (2008). *Redesigning social inquiry: Fuzzy sets and beyond*: Wiley Online Library.
- Ragin, C. C., Drass, K. A., and Davey, S. (2006). *Fuzzy-set/qualitative comparative analysis 2.0*. Tucson, Arizona: Department of Sociology, University of Arizona.
- Rennie, K. (1993). Business-level competitive strategy: A contingency link to internationalization. *Journal of Management*, 18(3), 473-487.
- Rihoux, B., and Ragin, C. C. (2009). *Configurational comparative methods: Qualitative comparative analysis (QCA) and related techniques*: Sage.
- Vries, M. F., and Florent-Treacy, E. (2003). Roustam Tariko (B): the measure of the man. *Entrepreneurship Theory and Practice*, 27(3), 319-329.
- Westhead, P., Wright, M., and Ucbasaran, D. (2001). The internationalization of new and small firms: A resource-based view. *Journal of business venturing*, 16(4), 333-358.
- Zou, T. (2007). An Overview of Researches on the Growth of Small-and Medium-Enterprises Based on the Enterprise Cluster. The Effects of Extreme Political Acts and Political Risk on International Banking Systems 3  
John L Simpson Improvement of Insurance Company's Service Management: An Application of Activity Based on Costing/Management, 133.

## CONSUMER FAD DYNAMIC. THE GIN CASE

**Meneses, Raquel; Almeida, Rui**

School of Economics and Management, University of Porto, FEP – UP, Porto, Portugal

### ABSTRACT

This study aims to characterize the consumption of an international consumer product fad. There is made a literature review of the concepts which can be related to an international fad. The review begins with the study of the product life cycle in order to evaluate which characteristics a life cycle has from the production point of view. The CAGE distances are also studied due to the particular importance of the cultural and geographic distance in an international fad. As for the social behavior, the herd behavior is studied to understand the process of sequential decision making and also the influence of the conformism. For the product, the way an innovation is perceived is also approached.

To know more about the subject, the Gin case is presented. The quantitative study starts with an initial model with the variables which can have impact in the consumption of the Gin. Based in the initial model, a survey is built and conducted, obtaining 143 valid responses. The data is analyzed based in a structural equation modelling.

The results verify the positive impact of need for group differentiation in the consumption gin. The perceived newness has direct impact in it consumption. An international fad lasts while it is differentiator for the consumer, so the herd behavior influence is not validated.

*Key Words: newness, group differentiation, fads, conformism, herd behavior*

### INTRODUCTION

We are witnessing a continuous change of the society, a change of: tastes, education, cultures, priorities, demography, among others. Thus along the time, new products are constantly being introduced and some of the older ones, tend to disappear. This causes international fads. This study aims to understand the characteristics each lead to the consumption of a product fad and if it is possible to relate the emerging of a fad to a country or group of countries.

To develop this study, the concepts of the different players of an international fad need to be studied: product, consumer and country. The product can have impact on the international fad, for example, in terms of its characteristics, innovativeness and response to demand. The consumer also plays an important role in the fad due to its social behavior and ability to adopt products. The countries are

also very important to consider, mainly, due to the distances between the country of origin of a fad and the next country to receive it.

There are some studies about global trends, but they are not applicable to these very enthusiastic international fads. Regarding this gap, we ask: Which are the critical features of a fad? In order to better understand the subject of study, there were used a product as a case study: Gin. Before making a survey, the initial model was built taking into account the literature review. With the results of the data collected through survey conclusions can be made.

## **LITERATURE REVIEW**

Fads are considered rapid and short-lived fluctuations, changing very quickly without apparent reason (Bikhchandani, et al., 1992). It is more likely for someone to adopt a fad if they are pressured by a social context, if they have experience with other innovations, if the access is easy and if there is a significant external promotion to the fad. Fads are cyclical and not all are new fads. Sometimes what is promoted as a new way of thinking of acting is an appeal to return to practices of many years ago. The duration of the life cycle of a fad is continuously getting shorter along the years (Carson, et al., 1999).

### **CAGE distances**

This framework identifies the key differences between two countries and characterizes them in four dimensions: Cultural (C), Administrative (A), Geographic (G), and Economic (E). There are many countries which seem to be closer but with the CAGE analyze of the distances the opinion changes (Ghemawat, 2007).

Very often, the companies become so dazzle by the size of the markets and the portion of it that has not been explored yet, that they forget important details, forgetting the difficulties that arise while entering new markets which usually have very substantial differences. So, there are an underestimation of the costs of doing international businesses, related to distances between the countries (Ghemawat, 2001). All the CAGE dimensions are very important to take into account during the decision of internationalization, the degree of acceptance of one product can be positively or negatively affected by, for example, the local habits and behaviors.

### **Social behavior**

The social relations are very important to spread a product. The social behavior aims to understand how persons interact to each other and which impacts can have some behaviors. The herd behavior model (Banerjee, 1992) suggests that the decision making is sequential. It begins with one person that takes a decision based in the available information. The next person knows the decision of previous one, and without having the same information, takes the same decision. The using of information

contained in the decisions made by other individuals decreases the sensitivity to their own information and consequently each individual is continuously less informative to the others (Banerjee (1992). This is also called as “groupthink” (Schrifstein & Stein, 1990). As Melissas (2005, p. 517) notes “people do not go and eat in an empty restaurant”. So fad behavior depends of social network (Tassier, 2004), and it can also fulfil the subconscious need to fit in social group and get social acceptance (Seiler, et al., 2014).

The modification of the behavior or attitude of an individual in order to harmonize the behavior of a group of people is defined as conformism (Cerclé, et al., 2001). The conformism proves that under certain conditions, the opinion of one individual can be changed in order to have a better acceptance within a group of people. But to have conformism of opinion, there is a need to clearly define what kind of behavior is the one to imitate. In a social system, these behaviors are defined by individuals who can be seen as leaders of opinion. If these individuals adopt an opinion or behavior, they will influence the others.

### **Adoption life cycle**

Concerning the degree of innovativeness of the individuals, there are five adopter categories: innovators, early adopters, early majority, late majority and laggards (Rogers (2003). Innovators are individuals who are prepared to deal with uncertainty about the innovations because of their will to experience new ideas. Because of these relations outside the system together with the adventure spirit may cause a lack of respect by the other individuals of the system itself (Sahin, 2006; Rogers, 2003). The Early adopters are considered to have the highest degree of opinion leadership. Other members of the social system come to the early adopters to get advices and information about the innovations. As leaders of opinion, they can decrease the uncertainty about an innovation by adopting it. Therefore, they represent a very important role in the diffusion of the innovation (Rogers, 2003; Sahin, 2006).

When the early majority adopts an innovation, the percentage of the system that has already adopted the innovation reaches the 50%. So the early majority adopters are the ones who adopt the new ideas before the average individuals of the system. They do not have leadership roles but their social interaction and interpersonal networks are good and important in the innovation diffusion process (Rogers, 2003; Sahin, 2006). The late majority adopters are more skeptical about new ideas, the pressure from colleagues and economic necessities can lead to the adoption of the innovation. This uncertainty about the new ideas can be reduced by persuasion from their peers through their interpersonal relations (Sahin, 2006). The laggards are more skeptical about innovations than the late majority due to their traditional view. The members of this category need to make sure that the new idea works before adopting it due to their lack of resources and awareness of innovations.

**Perceived newness**

According to Dinnin (2009) the newness of a product can be defined as a perceived aspect of the product. Besides the sense of ownership, the appeal for new possessions can give a shortterm sense of additional distinctive value for the consumer. So the perception of newness is considered to be an important part of the consumption experience. The performance of the product can be positively influence by the sense of uniqueness, originality and innovativeness. Newness can be considered to be a signal of quality or benefits. The newness leads the consumer to additional trials of the products, to enter in tendencies of seeking for product variety or even to repeat acquisitions of products that satisfy effectively the consumer. To reach a sense of newness, the situational product involvement is necessary but not sufficient. According to Dinnin (2009), the product involvement is defined as the interpretation of the product by the consumer. The product itself cannot determine the involvement. The involvement is determined by the behavior of the consumer towards the product in terms of consumer's level of interest, arousal, enthusiasm or excitement. However, by definition, this involvement tends to decline over time. The peak of temporary situation involvement normally occurs when the decision of purchase is made.

The product physical appearance is a central channel for consumer's relationships with the products once it is the first product's characteristic which connects with a potential buyer.

Superior designs can mark distinctions from product's competitors and help to gain recognition within the consumers. Thus, the presentation of a product plays an important role in the transmitting to the consumer a sense of a perfect product (Dinnin, 2009; Bloch, et al., 2003).

**Conclusion**

The literature review revealed some important concepts to consider in the definition of the international consumer trend model.

The CAGE framework defends that the lower are the cultural, administrative, geographical and economic distances between two countries, the easier it is to do business. This analysis is very important to choose the destination of the internationalization of a product. The cultural aspect plays an important role within the CAGE analysis because of its impact on the social behavior and consequently on the product adoption. Real new products require more learning of the product. In the positioning of a real new product, the cultural distance is important to reduce the gap existing between informed utility and the real experienced utility.

The growth of the product in the new country, depends on its acceptance. The technology adoption life cycle classifies the social system in five categories: Innovators, early adopters, early majority, late majority and laggards. This classification considers the degree of innovativeness along the time. The early growth depends on the capacity of opinion leadership of the early adopters, the more successful

it is the faster the growth will be. It is important to consider in the study of the international consumer fads that not only the social systems contain different groups of individuals which have a more innovative view or a more traditional view, but also the opinion of some groups can be influenced by others.

The social behavior can influence negatively or positively the success of the new product. The herd behavior causes an increase of the acceptance of the product by the individuals of the social system. This requires a leader of opinion, a set of early adopters who can define and give confidence to the rest of the other members which compose the social system. The conformism approach defends that, under certain circumstances, the opinion of an individual can be manipulated and changed.

To better transmit the new product or the incremental new product to the customers, the way of implementing and presenting is determinant. In order to a sense of perception of newness be achieved by the customers, there is the need to be aware of: the situational product involvement, sense of the product as pristine and physical possession. In other words, the customer needs to be attracted to the product by its appearance and feel a sense of added value.

The features which can influence positively consumption of a product are: the degree of newness, the CAGE distances and the social behavior. The degree of newness influences the consumption by the sense obtained by the consumer of added value. The higher the perception of newness, the higher the positive impact on the consumption. As for the CAGE distances, the distance between the countries can also have a big impact in the consumption. The closer culturally, administratively, geographically and economically, the higher is the positive impact on the consumption. The social behavior can have positive impact if there is an opinion leadership and a herd behavior. So, Social behavior plays an important role in two ways. First, the higher the degree of innovativeness of the individuals and the capacity of opinion leadership impacts positively in the social behavior. The herd behavior relies on the sequential decision process to justify that the majority of the individuals will follow the first ones. So if the first one as a high degree of innovativeness and if the herd behavior is present in the group, the social behavior will have positive impact in the consumption.

## **METHODOLOGY**

The quantitative data was collected using a survey but this time, instead of asking the suppliers of the products, the data was collected from consumers. This data was tested and simulated with the Partial Least Square model. The software used was the SmartPLS.

### **Case study**

It is important to analyze practical cases not only to verify the theoretical information but also to gain awareness of other factors which can be as much or even more important to the success of an

international fad. The case studies used should be products which are currently a fad. Based on observations of the market, the case study chosen was gin. The exploratory study aims to understand the question of investigation from the point of view of the supplier of the products. This was made by the means of interviews with owners of restaurants and bars. The goal was to identify possible variables to use in the quantitative study.

Based in the information of the literature review, complemented with the exploratory interviews result it is possible to define the model. So, in order to answer the research question “which are the critical features that define a model of internationalization of product fads?” the Figure 1 demonstrates the variables of an international fad.

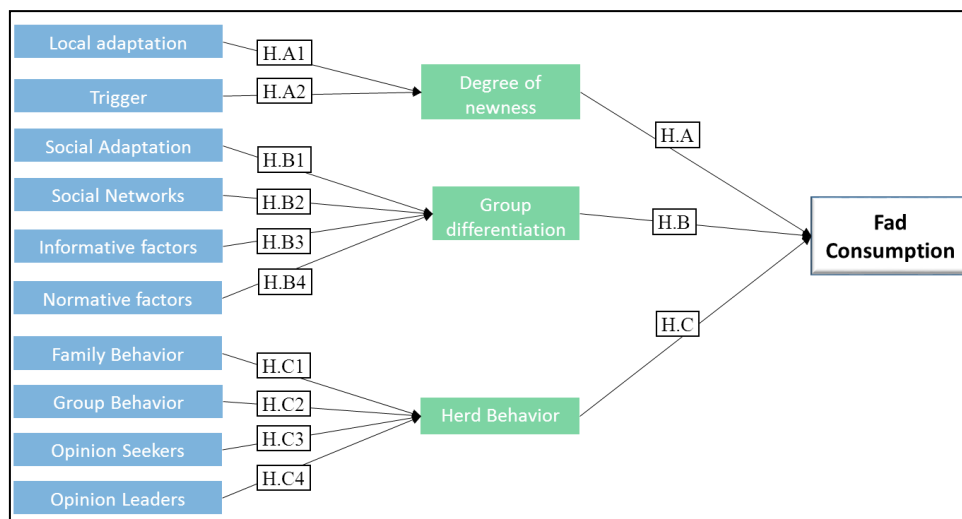

Figure 1 – Fad Model.

The Hypothesis A stands for the positive impact of the perceived newness in the consumption of the fad. The newness can be positively affected by the local adaptation (A1) of the product and by the trigger (A2) associated to the implementation of the product. The Hypothesis B represents the positive impact in the consumption caused by the need of differentiation of the consumer. The differentiation of the consumer is positively affected by ability of the consumer to Adapt Socially (B1), by the Social Networks (B2) and also by the Interpersonal Influence. The interpersonal influence is constituted by the informative factors (B3) and by the normative factors (B4). The Hypothesis C refers to the positive impact of the Herd Behavior in the consumption of the product. The Herd Behavior is positively affected by the Group Behavior and by the Opinion Leadership. The Group Behavior is constituted by the family behavior (C1) and by the group behavior (C2). The opinion leadership is constituted by the measurements of Opinion Seekers (C3) and Opinion Leaders (C4).

## Scales

In order to improve the quality and amount of information the survey can be a very useful tool. It can provide a more accurate information due to the process itself, with a standardized interview the respondents are asked exactly the same way.

When studying some aspects of the social behavior there are some questionnaires that are used to classify the individuals of the sample in a more reliable way. A scale of opinion leadership and opinion seeking can be used to identify some of the adopter categories. According to Flynn et al. (1996) opinion leadership or opinion seeking occurs when, respectively, consumers influence or seek influence from others. Both opinion leadership and opinion seeker scales are composed by six items each and are scored on 7 point scales (Bearden & Netemeyer, 1999). According to Lynn & Harris (1997) the continuous search to services, goods and experiences that few others possess are caused by the need for personal uniqueness and social status. However, consumers differ in the extent of this desire for unique products in terms of need for uniqueness, status aspiration and materialism. The measurement scale of the desire for unique consumer products consist in eight items and is scored using a five-point scale from *strongly disagree* to *strongly agree*. However, in the survey it will be used in a seven point scale in order to be included with the other items (Bearden & Netemeyer, 1999).

The conformism was defined in the literature review as the modification of the behavior or attitude of an individual in order to harmonize the behavior of a group of people. This need to harmonize, to meet to expectations of other members of the group can be considered as being a group influence between the individuals. So the interpersonal influence scale can be used to measure the conformism of the respondents of the survey (Cerclé, et al., 2001).

The interpersonal influence is the willingness to conform to the expectations of other individuals in terms of purchase decisions, tendency to learn about certain products that emerges by observing other individuals. According to Bearden et al. (1989), the models used to explain consumer behavior frequently include interpersonal influence which represents an important determinant of an individual behavior. The measurement scale of the interpersonal influence consists in twelve items, each scored in a scale from one to seven in which one means *strongly disagree* and seven means *strongly agree* (Bearden & Netemeyer, 1999).

The fad consumption is defined by the frequency of consumption, chosen from a drop down list, evaluated from 1 to 6 points: less than once per year (1), every two months (2), every month (3), every week (4), 2 days per week (5) and everyday (6).

The second generation models, such as the Structural Equation Modeling (SEM), emerged as an alternative to the limitations of the first generation ones. The SEM models allow multivariate analysis which overcome the first limitation of the first generation ones. The variables which cannot be directly



observed and its existence is measured by manifestations in indicative variables can also be considered and used. These models also consider measurement errors for the variables used and observed. Overcome of first generation limitations, enlarge the number and type of situations were studies can be conducted (Haenlein & Kaplan, 2004; Wong, 2013). In order to choose the right model to use in the investigation, there is the need to take into account the characteristics of our research and which type of variables it has. There are several variables such as group differentiation and opinion leaders, among others, which were measured through indicators or other variables. Once the SEM models measure unobserved variables, and the first generation ones do not, an SEM model is the correct type to use.

Among the SEM models, the choice is now between the CB-SEM and the PLS-SEM. In the modeling phase we will have both formative and reflective indicators. There will be used formative indicators in variables as the "Group Behavior" and the "Local Adaptation". PLSSEM is the correct choice due to its ability to use both types of variables.

The survey was available for responses from the 22<sup>nd</sup> July of 2016 until the 9<sup>th</sup> September of 2016. The model has 13 paths in the inner model, which corresponds to a minimum value of 130 responses for the model being studied. The survey had 143 valid responses.

## RESULTS

The sample is composed by 78 (55%) female individuals and by 65 (45%) male individuals, there is almost no difference between the genders in terms of knowing gin, 81% (63) of the females and 82% (53) of the male respondents had already tasted it. The average age of the respondents is 28,7 years, the youngest has 18 years old and the oldest has 58 years old.

### Results of the modeling

According to Kim, et al. (2008), the internal consistency for reliability is calculated using the Cronbach's Alpha (Alpha) and the Fornell's composite reliability (CR). The Cronbach's Alpha needs to be greater than 0,6 (Sekeran & Bougie, 2009) (Hair, et al., 2005) and the Fornell's composite reliability needs to be greater than 0,7 (Kim, et al.,2008).

To test how the results of a certain measurement fit or not the designed theory, we need to examine the construct validity. This is examined by testing the convergent validity and the discriminant validity. Convergent validity occurs when there is a high correlation between two instruments which measure the same concept. To test convergent validity, the minimum value of the Average Variance Extracted (AVE) needs to be 0,5. Discriminant validity occurs when the scores of the measurements of two variables, which were predicted to be uncorrelated, prove that they are indeed uncorrelated. The

discriminant validity is proven if the square roots of the Average Variance Extracted is higher than the correlations between the variables (Sekeran & Bougie, 2009; Kim, et al., 2008; Wixom & Watson, 2001).

Some items were deleted to improve the results of the Cronbach's Alpha and Composite Reliability. In the variable "Social Adaptation", the items "SocialAdap3" and "SocialAdap6" were removed. In the case of the variable "Newness", the items "Newness1" and "Newness3" were also removed.

To have an adequate convergent validity the Average Variance Extracted (AVE) needs to be above 0,5 (Wixom & Watson (2001). To have a satisfactory discriminant validity, the AVE should be greater than the variance between the variable and the other variables used. Some items were deleted to improve the Average Variance Extracted (AVE). In the variable "Group Differentiation", the items "GroupDiff8", "GroupDiff4" and "GroupDiff2" were removed. From the variable "informative factor" only the item "inf7" was removed. From the variable "normative factor" only the item "nor11". From the variable "Opinion Leaders" the items "OL4" and "OL5" were removed. The results are presented in the Table 1. Table 1 – Measurement Model Quality

Variable	Type of indicator	Alpha	CR	AVE
Group Differentiation	Reflective	0.754	0.833	0.501
Group behavior	Formative	N/A	N/A	N/A
Herd Behavior	Reflective	0.669	0.783	0.425
Informative factor	Reflective	0.698	0.743	0.510
Local Adaptation	Formative	N/A	N/A	N/A
Newness	Reflective	0.610	0.831	0.713
Normative factor	Reflective	0.856	0.880	0.517
Opinion Leaders	Reflective	0.799	0.846	0.581
Opinion Seekers	Reflective	0.855	0.886	0.569
Social Adaptation	Reflective	0.660	0.714	0.411
Trigger	Formative	N/A	N/A	N/A

Almost all variables meet the requirements of the minimums values for the Cronbach's Alpha (>0,6), Composite Reliability (>0,7) and Average Variance Extracted (>0,5). There are only 2 values that are below the minimum value for the AVE, the "Herd Behavior" and "Social Adaptation" are below 0,5. There were made some tests to improve this value, but it would mean the decrease of the Cronbach's Alpha below the minimum limit (<0,6).

To have discriminant validity, the correlations between the variables need to be lower than the square roots of the average variance extracted (Kim, et al., 2008), all the values of the square roots of the Average Variance Extracted are higher than the correlations between the variables. So it has discriminant validity. To conclude, the model is validated as its reliability, convergent validity and discriminant validity were verified.

### Model Parameters and Statistical testing

To evaluate the significance of the relation and impact of each value, bootstrapping estimation was used (in SmartPLS). Results are presented in Table 2.

Table 2 - Results of the bootstrapping for the gin model.

Hypothesis	Sample Mean	Standard Deviation	T Statistics
C1 - Family -> Herd Behavior	0.144	0.088	1.520
B - Group Differentiation -> Consumption	0.211	0.105	2.179
C2 - Group behavior -> Herd Behavior	0.149	0.097	1.057
C - Herd Behavior -> Consumption	-0.089	0.105	1.013
B3 - Informative factor -> Group Differentiation	0.075	0.124	0.414
A - Newness -> Consumption	0.181	0.079	2.193
B4 - Normative factor -> Group Differentiation	0.256	0.099	2.589
C4 - Opinion Leaders -> Herd Behavior	0.171	0.111	1.355
C3 - Opinion Seakers -> Herd Behavior	0.320	0.087	3.637
B1 - Social Adaptation -> Group Differentiation	0.171	0.165	0.998
B2 - Social Network Frequency -> Group Differentiation	0.049	0.093	0.601
A2 - Trigger -> Newness	0.377	0.079	4.603

Only hypothesis with a probability of 95% were validated ( $T\text{-statistic} \geq 1.96$ ). Only hypothesis A, A2, B, B4, and C3 are validated. Herd Behavior is not validated, the other two variables are significant and have positive impact.

The Hypothesis A, the positive impact of the perceived newness in the consumption of the fad, is confirmed for the consumption of Gin, the positive impact of the trigger in the degree of newness was also verified. This means that the perceived newness of the product by the individual is one of the reasons which leads to consumption. This perception is also directly influenced by the beauty and way the product is presented, the trigger which capture the consumer attention. This can be related to the renewal of the Gin in terms of presentation, preparation and increase of its variety. The consumer has an excitement attitude towards Gin and the product can be considered as having a perfect physical form which gives a sense off added value to the consumer and cause the need to possess it and try it.

The Hypothesis B, the positive impact in the consumption caused by the need of differentiation of the consumer, is verified for the general consumption of gin. The normative factors were also verified as having positive impact in the need for differentiation. The verification of the positive impact of the group differentiation means that, the individual consumes this product in order to reach a sense of differentiation within the group of friends or other consumers. For the cases in which the normative factors were also verified as having a positive impact in the group differentiation, it means that these

individuals are influenced by the expectations of the other members of the group. The search to try new things and products is a result of a need of the individual to expose to the group that he or she is a product connoisseur, an innovator. The Hypothesis C, the positive impact of the Herd Behavior in the consumption of the product, was not validated. This result, together with the validation of the hypothesis B, means that a product has success while it still is distinctive and it is not generalized. A product has successful consumption while it is differentiator and still has perceived newness. The mass consumption characterized by a herding behavior is not verified in a consumer fad.

### **Conclusion**

When implementing a new product there should be some awareness about the type of product. The incremental new products have a lower degree of uncertainty in its adoption. The case of Gin was a result of an adaptation of its presentation because the product was already in market many years before which means that the degree of uncertainty was low when implementing it and its adoption was easy. The presentation of a new product and its packaging transmit towards the consumer a sense of newness. The physical appearance and superior designs give the consumer a sense of added value. This causes emotions towards the brands of new products. The herd behavior was considered to cause the increase the consumption of a product. However, the opposite was proved, a fad needs to differentiate the consumer among its group of friends. Once a product becomes massively consumed, it ceases to be differentiator and the consumption decreases. So when the acceptance of a certain product reaches a high level, it can also mean the end of the fad. The increasing number of consumers can be faster or slower depending on the acceptance and conformism of the product and it is represented by the number 1 (on figure 2). The number 2 represents a point of stagnation where the number of users reached a point where the reason of the success of the product is questioned: with so many users, is the product still differentiator? This lack of differentiation causes a decrease of the number of users shown on the point number 3. Considering this product in a certain country, the point number 2 can mean the import of a new fad which can be a substitute product. The import of a fad from another country can mean the import of a brand new product, which is important because it means that the perceived newness can be implied. This is caused by the individuals that launched the first product, the innovators, which can feel that the product no longer gives them any type of differentiation and they start to look for other products and experience them.

However, another thing can happen, a renewal. A renewal of the product, as seen in the Gin case, can boost the number of individuals which consume the product. If a renewal brings new characteristics which can give a new sense of perceived newness to the product, the innovators, early adopters and early majority can start consuming this new version of the product.

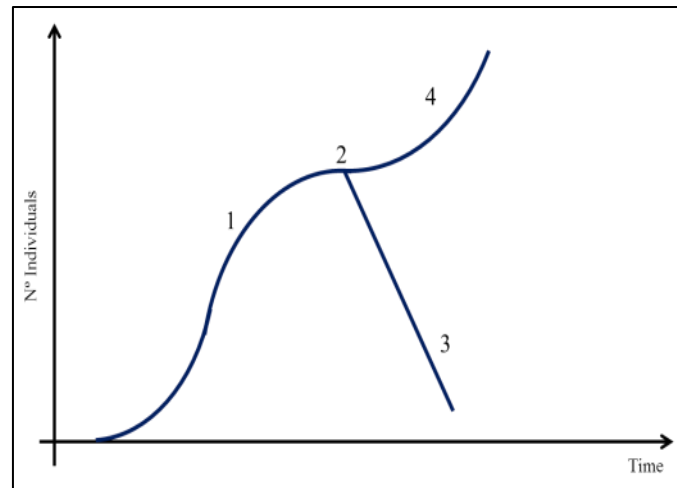

Figure 2 – Typical fad live cycle.

The individuals responsible for the increase of the number of consumers in the phase 1 of the Figure feel that the product is no longer differentiator, so they start to search for a new product (3) or a renewal (4) of the existing product. If the innovators, early adopters and early majority start consuming another product fad, the consumption of the current will stop. So the mass success of a product is the end of the products fad. With this behavior, the individual tries new and differentiator products which gives him the sense of group differentiation. This sense can be achieved by choosing more exotic products which are not available or known for most of the people. But the more exotic, the more distant can be the country of origin of the product. This distance can be mainly cultural, but it can be also geographical.

Taking into account the results of this study, the possible future fads identified in the survey can be discussed. However, this study was made using practical only one case of beverage. So the possible fads in the technology domain should not be discussed due to the marked differences between the two types of products.

The implementation of the exotic food in a country should be preceded of a study of the evolution of the exotic food sales and implementation in close markets. If an exotic product from a culturally distant country which is already being commercialize in a country with a close cultural distance, the implementation is easier and the exotic differentiation is still there. The perceived newness should be visible and undeniable; helping in the group differentiation. As suggestion, further studies in this area should be conducted. In order to compare results between countries and verify that if, for example. The mapping of the first consumptions along the Europe is also very interesting to do.

When implementing the product, it should have a distinctive design with an appearance that makes the consumer perceive the product is unique and differentiator. The differentiation should be analyzed also taking into account the cultural distance. The higher the distance, the more exotic,

which means higher differentiation. But in the moment of implementing it, if it is a real new product it requires more time and come adaptation.

The fad will last while it is still differentiator, after that there is a need to search for a new market where it can still be differentiator and acceptable. From the point of view of the fad importer, before the fad stops being differentiator, he needs to look for other different products. The products should be preferably exotic, from countries culturally distant, but are already being consumed in countries culturally close.

## REFERENCES

- Banerjee, A. V., 1992. A simple model of Herd Behavior. *The Quarterly Journal of Economics*, 107(3), pp. 797-817.
- Bearden, W. O. & Netemeyer, R. G., 1999. *Handbook of Marketing Scales*. 2 ed. Thousand Oaks: Sage Publications.
- Bearden, W. O., Netemeyer, R. G. & Teel, J. E., 1989. Measurement of consumer Susceptibility to interpersonal influence. *Journal of consumer research*, Volume 15, pp. 473-481.
- Becker, G. S. & Murphy, . M., 2001. *Social Economics: Market Behavior in a Social Environment*. s.l.:Belknap Press.
- Bikhchandani, S., Hirshleifer, D. & Welch, I., 1992. A theory of fads, fashion, custom and cultural change as informational cascades. *Journal of political economy*, 100(5), pp. 992-1026.
- Bloch, P. H., Brunel, F. F. & Arnold, T. J., 2003. Individual Differences in the Centrality of Visual Product Aesthetics: Concept and Measurement. *Journal of Consumer Research*, 29(4), pp. 551-565.
- Carson, P. P., Lanier, P. A., Carson, K. D. & Birkenmeier, B. J., 1999. A historical perspective on fad adoption and abandonment. *Journal of management history*, 5(6), pp. 320-333.
- Cerclé, A., Somat, A. & Serpa, M. T., 2001. *Manual de psicologia social*. s.l.:s.n.
- Dinnin, A., 2009. The Appeal of Out New Stuff: How Newness Creates Value. *Association for Consumer Research*, Volume 36, pp. 261-265.
- Flynn, L. R., Goldsmith, R. E. & Eastman, J. K., 1996. Opinion Leaders and Opinion Seekers: Two New Measurement Scales". *Journal of the Academy of Marketing Science*, 24(2), pp. 137-147.
- Ghemawat, P., 2001. Distance still matters.. *Harvard business review*, 79(8), pp. 137-147.
- Ghemawat, P., 2007. *Redefining global strategy: crossing borders in a World where differences still mater*. Boston: Harvard business school press.
- Haenlein, M. & Kaplan, A. M., 2004. A Beginner's Guide to Partial Least. *Understanding Statistics*, 3(4), pp. 283-297.
- Hair, J., Anderson, R. E., Tatham, R. L. & Black, W. C., 2005. *Análise Multivariada de dados*. 5 ed. Porto Alegre: Bookman.
- Kim, D. J., Ferrin, D. L. & Rao, H. R., 2008. A trust-base consumer decision-making model in eletronic commerce: the role of trust, perceived risk, and their antecedents. *Decision support Systems*, Volume 44, pp. 544-564.
- Lynn, M. & Harris, J., 1997. The Desire for Unique Consumer Products: A New Individual Differences Scale. *Psychology & Marketing*, 14(6), pp. 601-616.
- Melissas, N., 2005. Herd behaviour as an incentive scheme. *Economic Theory*, 26(3), pp. 517-536.
- Rogers, E. M., 2003. *Diffusion of innovations*, Fifth Edition. New York: The Free Press.
- Sahin, I., 2006. Detailed review of Regers' diffusion on innovations theory and educational technology-related studies based on Rogers' theory. *The turkish online journal of educational technology*, 5(2).
- Schrfstein, D. S. & Stein, J. C., 1990. Herd Behavior and Investment. *The American Economic Review*, 80(3), pp. 465-479.
- Seiler, M. J., Lane, M. A. & Harrison, D. M., 2014. Mimetic Herding Behavior and the Decision to Strategically Default. *The Journal of Real Estate Finance and Economics*, Volume 49, pp. 621-653.
- Sekeran, U. & Bougie, R., 2009. *Research Methods for Business*. Chichester(West Sussex): John Wiley & Sons Ltd.
- Tassier, T., 2004. A model of fads, fashions, and group formation. *Complexity*, 9(5), pp. 51-61.

- Wixom, B. H. & Watson, H. J., 2001. An Empirical Investigation of the Factors Affecting Data Warehousing Success. *MIS Quarterly*, 25(1), pp. 17-41.
- Wong, K. K.-K., 2013. Partial Least Squares Structural Equation Modeling (PLS-SEM) Techniques Using SmartPLS. *Marketing Bulletin*, 24(1), pp. 1-32.

## ECONOMIC AND FINANCIAL BALANCE OF ITALIAN PLASTIC MANUFACTURERS DURING THE CRISIS (2008-2015)

Migliaccio, Guido; De Blasio, Veronica

Department of Law, Economics, Management and Quantitative Methods, University of Sannio, Benevento, Italy

### ABSTRACT

This work focuses on the situation of plastic manufacturers in Italy. It aims to analyse their financial structure and economic situation, in the period before, during and after the crisis (2008-2015), in relation to economic and financial ratios trend. The study focuses on three research questions: what is the actual situation and which trend there has been in the last decade in Italy? What was the effect of the international crisis on the financial structure of companies in the sector? What changes has the international crisis brought on the financial structure of plastic firms' industry? How profitability evolved during the period in question?

To these aims and starting from AIDA data, the study carries out a trend analysis. The financial structure is assessed using ratios (Leverage, Current ratio, Quick ratio, Financing ratio for non-current assets) and Fixed asset to equity capital margin. By evaluating ROE, ROI and ROS, the profitability was investigated.

The study shows that the recent economic crisis has hit different industries in different ways; particularly, it has affected Italian plastic industry in a limited way because of the increasing product demand. Ratios values are highly satisfactory, despite the dominance of the debts on internal sources, which is unjustified given the cheap equity borrowing. Future studies should deepen the issue by comparing Italian and other countries' situation in order to enrich international literature. In fact, the focus on production and technical aspects and the impact of plastic on environmental pollution have always been the main object of interest.

**Keywords:** Plastic manufacturers, Global Crisis; Financial ratios; Profitability ratios.

### INTRODUCTION AND PURPOSE: STRUCTURE OF THE ESSAY

The recent international economic crisis has affected the nations and the industries with different intensities and consequences. It was also an opportunity for scholars to detailed analyses of the causes

---

This paper is the result of a collaborative work. However, it is possible to attribute to Veronica De Blasio: Plastic material production in the world; Plastic material production in Italy and The evolution of economic and financial structure: results from a quantitative analysis. The other sections are of Guido Migliaccio.



and possible solutions to propose to the globalized economic system and every company. This study focuses on the plastics industry trend in Italy during the economic crisis. Plastic is one of the most important industrial product everywhere. It replaces gradually other expensive and strict raw materials. Plastic material sector has been affected by the recent global crisis, albeit in a slighter way than the other business sectors. Therefore, it represents a useful case study for its global dimension and for the verification of its relations with the economic crisis causes. However, it raises the issue in terms of its real use in order to avoid environmental pollution, given the problems of waste and recycling (Glerean, 2012). Sector analysis is useful for both typical purposes, related to the financial statements analysis, and for the ecological and social implications inferred from plastic environmental impact. This sector unites managerial and social issues and the indications obtainable from it may be useful to develop, at the same time, appropriate employment and environmental policies.

This research answers three questions focused on financial and economic dynamics:

RQ1: What is the current situation and what did the trend in the last decade?

RQ2: What was the effect of international crisis on firms' financial structure?

RQ3: How the profitability changed during the period in question?

In the future, the research must be extended to the economic and environmental aspects, which are intimately tight, and to the dissemination of environmental reports among the firms.

In order to answer to these research questions, the study carries a quantitative analysis based on the financial statements of a sample of companies for eight consecutive years. By analysing the time trend of some capital and revenue ratios, a first view on industry trend and on consolidation efforts developed.

The study, after explaining the research approach and the methodology, gives some evidences about the studies on the environmental impact of plastics, which are relevant and frequent. In literature, fewer researches have dealt with the economic and capital balance of firms. The aim of this work is to fill this gap.

Subsequently, the essay shows some data on the plastics industry both in Italy and in the world. These data are the subject of the analysis.

Finally, the results show a growth industry. The economic and capital structure benefit from this situation, despite a substantial debt persists, which is unjustifiable regarded the lower costs of money in the European Union.

## RESEARCH APPROACH

Our research approach is quantitative. It develops an analysis on ratios and indexes carried on a sample of 3.227 companies from AIDA database (<https://aida.bvdinfo.com> – 19/9/2016). The companies considered have two characteristics:

- 1) They belong to Ateco 22.20.00 2007 ([www.istat.it](http://www.istat.it) - 27/03/2016): they produce plastic goods;
- 2) They do not belong to special Ateco classes: «Manufacture of plastic plates, sheets, tubes and profiles», «Manufacture of plastic packing goods», «Manufacture of builders' ware of plastic».

Before the analysis, the study presents the statistical data and their elaborations on global, European and Italian production.

The empirical analysis develops a characterization of the financial structure by using the following ratios: leverage, quick ratio, current ratio, fixed asset to equity capital margin. By evaluating ROE, ROI and ROS, the profitability was investigated.

Finally, we presented conclusions and possible future in order to make clear open questions.

## INTERNATIONAL AND ITALIAN LITERATURE REVIEW

The international studies concerning the production of plastic are wide and articulated. There is a prevalence of technical and engineering studies about the realization of quality goods. Economic studies are less numerous and classified in two groups: some of them analyse the environmental impact of plastic materials and the social consequences; others are more managerially oriented and analyse economic and financial balance of manufacturers.

A brief and necessary mention must be devoted to ecological economy, albeit it is not the specific aim of this research, but rather of a possible future continuation. There is the wide research of Zaman and Swapan (2016) which presents the environmental and economic benefits of global waste management systems in the context of zero waste practices. Other studies are synthetized as follows: Corbett (2000) analyses the environmental management systems in the New Zealand plastics industry; Steuer *et al.* (2017) show the analysis of the value chain and network structure of informal waste recycling in Beijing, China; Alcántara-Concepción *et al.* (2016) analyse the Environmental impacts of computers (at the end of their lives) and their management alternatives in México; Zhou *et al.* (2014) present the characteristics and the recovery potential of plastic wastes obtained from landfill mining, etc.

A wide international literature analyses economic and social effects of pollution, which derives from plastic packaging (Ravi, 2015; Valarmathy, 2015; Accorsi *et al.*, 2014; Cai and Savio, 2013; and Cozzi, 2016).

A limited number of studies focuses on specific management issues in plastics industry, presented as follows:

- Lélis and Simon (2013) study the relationship management in the automotive chain. The object focuses on the relationship management in an industry of automobile plastic parts in São Paulo, Brazil. The results show the relationship management factors which contribute to the efficiency of supply chain management and highlight the aspects which can be improved concerning the chain collaboration in terms of informal communication and lack of joint business planning between the company partner;
- Damoah and Nyarko (2016) study the influence of leadership strategies on organisational commitment. The purpose of this research is to examine the effect of different dimensions of leadership strategies on employees' commitment, in order to identify the best strategies required to improve the commitment of employees in a developing country's context. Well 132 employees based on the two major plastic manufacturing companies in Ghana. Based on the findings, organisations are therefore encouraged to adopt the democratic leadership strategy to improve the commitment of the work force;
- Xu *et al.* (2016) present some evidences on a sustainable performance assessment framework for plastic film supply chain management from a Chinese perspective, because the application of biaxial-oriented polypropylene plastic film has had a significant influence on the economic, environmental and social performance of supply chain management;
- Resende *et al.* (2014) present the results of a lean production project implementation developed in a plastic injection company. The main aim of the project was the application of lean principles and tools involving the company's stakeholders. Some tangible and financial results obtained, were an increase in productivity of the assembly lines and of the operating income, a reduction of the cycle time etc. Intangible results were the operators' engagement and involvement with continuous improvement and with lean implementation;
- Van Eygen *et al.* (2017) analyse the national plastic flows in Austria from the production stage up to the waste management stage, reference for the year of 2010;
- Paksoy *et al.* (2006). In this study, the supply chain management strategies and applications of two plastic profile manufacturer firms, which are two of the six greatest in the Turkish market, are benchmarked based on a questionnaire;
- Low and Lee (2008). In the current mould-making industries, the challenge is to shorten the mould lead-time while maintaining the desired quality. In the current practice of local mould-making

industries, almost all the data for the mould design, manufacture and testing stage are often either confused or duplicated unnecessarily. This paper presents a framework for how the data from the different stages of the mould project could be managed more efficiently through the use of templates;

- Hallam *et al.* (2009). This project focused on a small manufacturer of plastic bags to identify the critical and non-critical factors of production and develop a strategy for the firm to manage those critical factors in order to improve production rates and quality while decreasing waste. The results of the project demonstrated a strategy that could achieve all three objectives for the company, namely increased productivity, quality, and reduced waste, all of which drive bottom line financial improvements, a key performance outcome in any lean enterprise;
- Aydogan *et al.* (2013). This chapter presents a mathematical model which is a fuzzy goal programming model for imprecise goals for reverse logistic network design with multiple objectives in plastic sector. The considered objectives are to reduce cost in reverse logistics, to improve product quality, and to provide environmental benefits by minimizing waste production.

Asamongtham (2012) studies the factors affecting cost management of SME factory entrepreneurs in the plastic industry in Pathumthani during the economic crisis. The findings reveal that the overall cost management was at a moderate level and was not different in terms of business size, but as classified by years in business. Villa (1997) underlines that an efficient financial structure ensures a permanent position on the market. Maybe, it is perhaps the only example of writing which relates financial structure of the plastics companies to durability.

From this literature review, it emerges a lack of studies about the composition of sources and application of funds that derive from the financial statements and on the average profitability of the industry. In fact, it seems useful in order to understand the industry in question. The next notes are a first attempt to fill this gap.

## **PLASTIC MATERIAL PRODUCTION IN THE WORLD**

The industry sector of manufacture and transformation of plastic materials is one of the most important in Italy and in the world.

Plastic, from year to year, has reached a huge development, because of its properties and possible uses. Its success is due to a specific combination of materials: it can be flexible or stiff, heavy or light, opaque or transparent, with sealing and/or blocking properties. All these merits, together with the lower costs of production have lead the plastic to replace other materials, especially the metal (Kerns, 2016).

The recent global crisis affected the plastics industry, like all industries. However, the crisis hardly affected this sector, compared to the others; in fact, it began its recover in 2010-2011. Globally, plastic material production has grown by 10 million tons reaching 280 million tons with a growth rate of 9% per year ([www.plasticseurope.org](http://www.plasticseurope.org) - 23/03/2016). The global and European trend (table 1) records a constant growth despite the crisis. In 2014, the production reaches the value of 311 million tons.

Table 1: Global and European plastic production

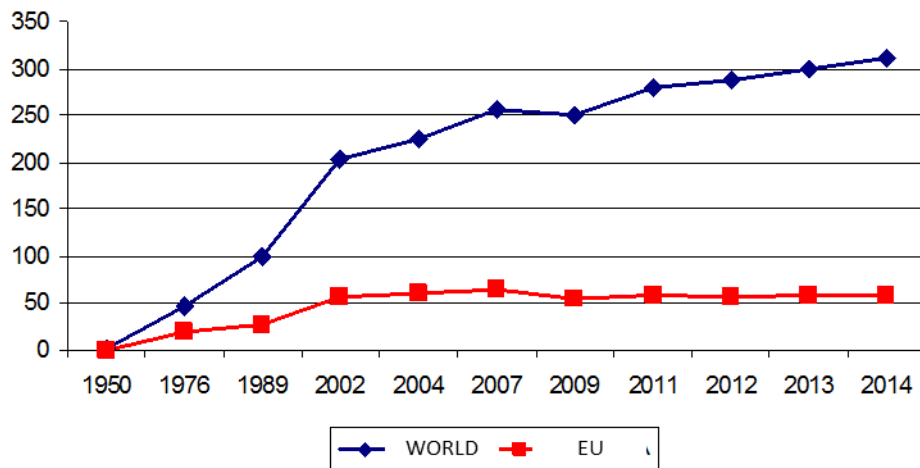

Source: data from PlasticsEurope Market Research Group (PEMRG)

The markets for plastics are shifting towards Asia characterized by growth rates higher than average: in Asia, there is a growing production capacity. Currently (table 2), China has the 26% followed by Europe with the 20%, NAFTA 19%, the remaining Asia 16%, Africa 7%, Latin America 5% and, lastly, Japan 4% (<http://www.plasticseurope.org/plasticsindustry/plasticseurope.aspx> - 24/03/2016). The Europe produces 47, 8 million tons of plastic materials whose manufacture and transformation is highly concentrated in five countries: Germany with the 24, 9% followed by Italy (14, 3%), France (9, 6%), Great Britain (7, 7%) and Spain (7, 4). The remaining part belongs to the other 22 European countries.

Table 2: Global plastic material production

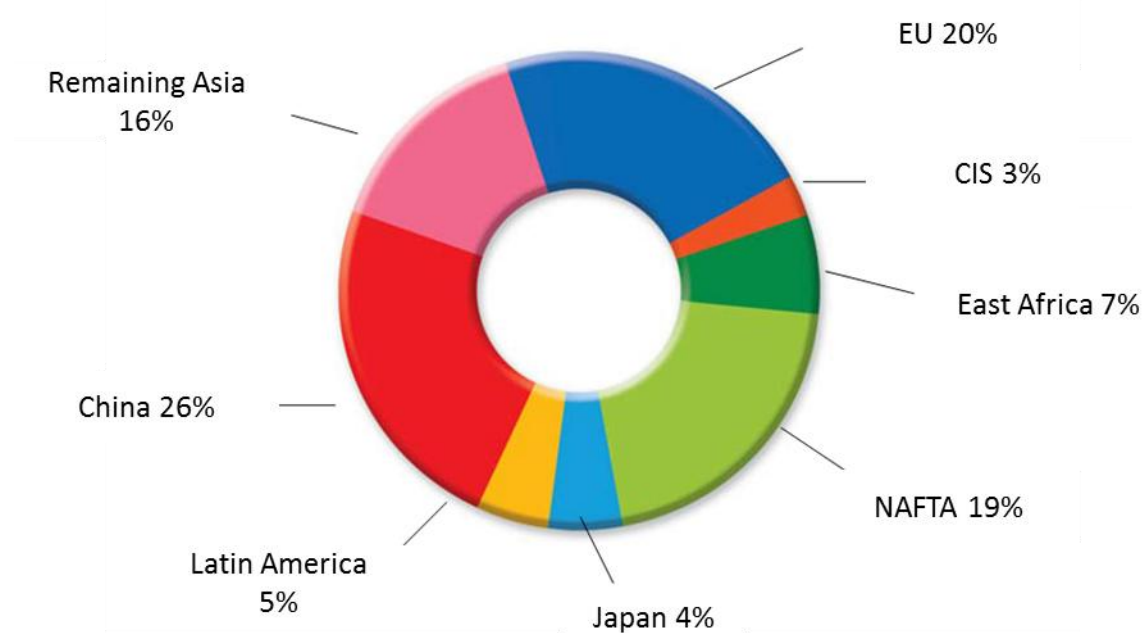

<http://www.plasticseurope.org/plasticsindustry/plasticseurope.aspx> (24/03/2016)

## 5. THE PRODUCTION OF PLASTICS MATERIALS IN ITALY

The plastic materials transformation and the realization of parts and products for the final user is one of the most important production activities in Italy, which has gained significant results even in the crisis.

In 2009, Italy was (The European House – Ambrosetti, 2013):

- the third in Europe for employment (146 thousand), turnover (€ 32 billion) and added value (about € 8 billion) in the production and transformation of plastic materials, under Germany and France. Italy, as well as the rest of the Europe (except Germany), employs around 90% of the workforce and the 87% of the added value in the transformation;

- the second in Europe for consumption market of plastic materials after Germany (7,1 compared to 11,9 million tons/year).

Currently, the industry in question is stable: it records about 180 thousand workers, 11 thousand companies, growing compared to 2009 (ISTAT, 2016).

Plastic materials are extremely versatile and usable in different sectors.

Its main use is for packaging that takes up in Italy more than 45% of production, considering versatility, lightness, robustness, chemical inertness, reliability and economy.

The building takes up in Italy more than 11%, particularly for hardware, industrial plant building, coatings, plumbing, thermal and acoustic insulation; the furniture takes up about 6%; the transport over 4% in various parts like air bag, safety-belt etc.; agriculture more than 3%.

## 6. THE EVOLUTION OF THE ECONOMIC AND FINANCIAL STRUCTURE: RESULTS FROM A QUANTITATIVE ANALYSIS

The paragraph carries an asset analysis on the sample identified before. We used the indexes and ratios calculated on reclassified financial statements of Aida database.

By rearranging the information, we reported every formulation from [https://help.bvdinfo.com/mergedProjects/73\\_IT/Data/Financial/AidaRatioDef.htm](https://help.bvdinfo.com/mergedProjects/73_IT/Data/Financial/AidaRatioDef.htm) (22/02/17).

### 6.1 Financial and patrimonial analysis

#### 6.1.1. Indebtedness level

The *Leverage* (Total assets/Equity) expresses the coverage of uses with own funds. In Italy there is the trend shown in the table 3:

2008	2009	2010	2011	2012	2013	2014	2015
9,09	8,30	10,39	9,32	7,94	11,01	9,88	10,15

Source: elaboration on AIDA database.

The industry is characterised by high leverage, sometimes fluctuating. In 2015 there is a 10, 15 of slight decrease compared to 11, 01 of 2013. There is also a move from 8, 30 of 2009 to 10, 39 of 2010 and a decrease in 2011-2012 followed by a peak in 2013. The industry is characterised by an imbalance between own funds and third party funds, which are dominant. This could cause increasing borrowing costs, which would reduce firms' profitability. Therefore, this fact has to be linked to the following datum about Roe, Roi and Ros ratios. It must be noted that in some of the considered years, the cost of money was low because of the effects of monetary and European Central Bank too.

#### 6.1.2. Short- term financial balance

It can be analysed by using the *quick ratio* and the *current ratio*.

- a) The *quick ratio*  $[(\text{Current assets} - \text{Remainder})/\text{Current liabilities}]$  expresses the short-term financial situation, by considering current liquidity and liquidity on deadline such as security investments in liquidity (Fadda *et al.*, 2008) (table 4).

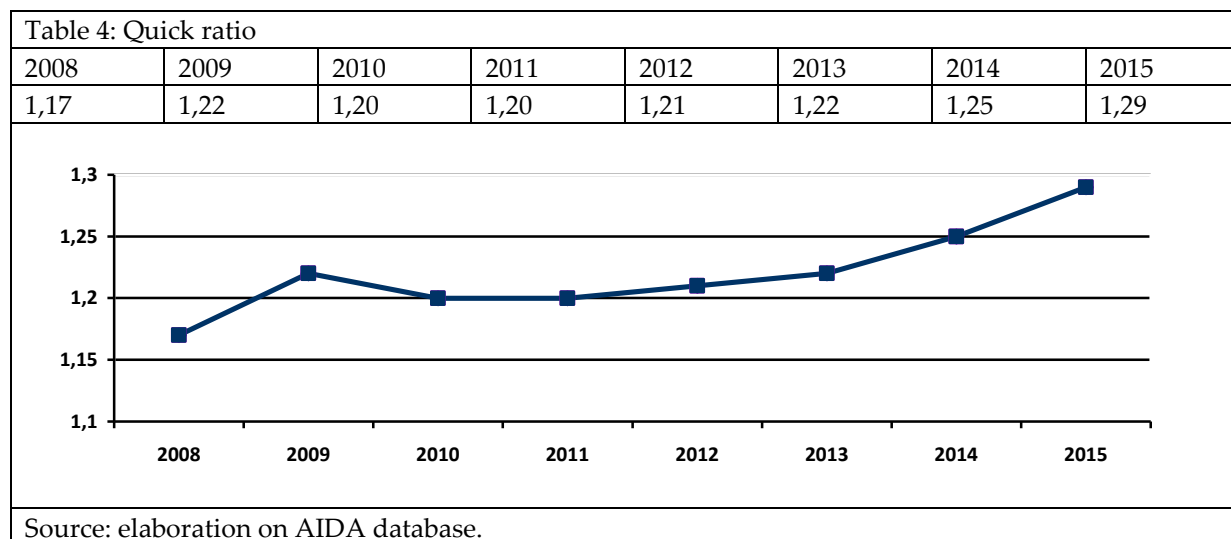

The index has a fluctuating trend in the years 2008-2012, and then it remains stable and increases. During the period examined, the quick ratio records average values underline a good financial situation in 2008-2011. In 2014-2015, it becomes increasingly positive.

- b) The *current ratio* (Current assets/Short term debts) expresses the coverage of short-term debts with short-term investments, including stock (table 5).

The companies worked in a situation of financial balance improving from year to year despite the

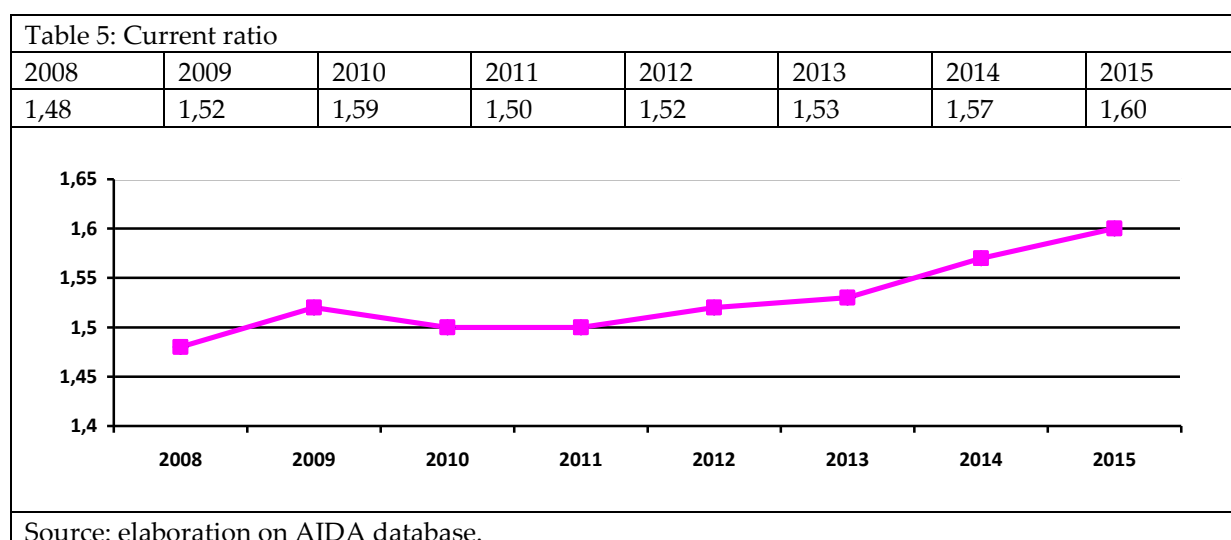

crisis. It is a particular important evidence because it is a sign of a good working capital management, which has not been affected by the detrimental effects of the crisis that, sometimes, has lead to quick choices with negative effects on short-term asset balance. It is useful to compare (table 6) in a graph,



the two last indexes: the dimension of the stock (which is close to liquidity) has not affected in a significant way the financial dynamic.

Table 6. Current ratio e quick ratio: a comparison.

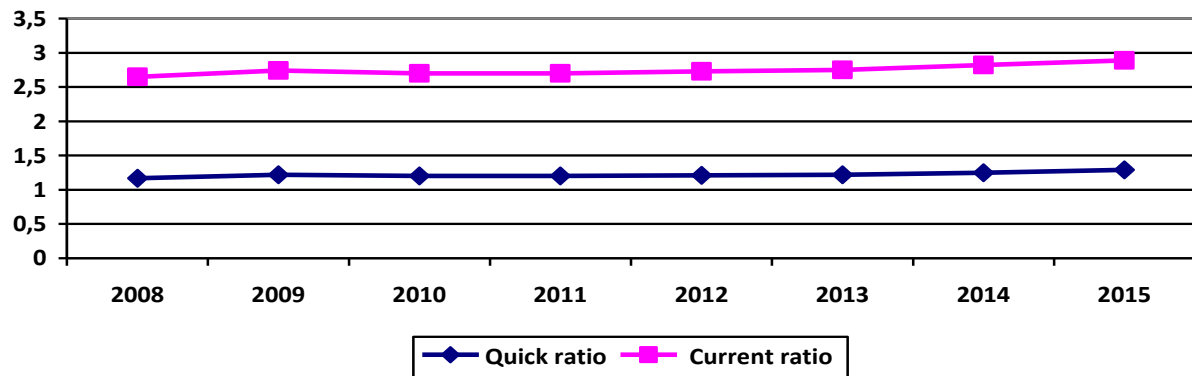

Source: elaboration on AIDA database.

### 6.1.3. Medium and long- term financial balance

The analysis focuses on fixed asset to equity capital margin and financing ratio for non-current assets.

- a) The *fixed asset to equity capital margin* (Equity – Net fixed assets) expresses, in absolute values, the coverage of non-current assets with equity capital (table 7).

2008	2009	2010	2011	2012	2013	2014	2015
-642	- 578	- 579	- 526	- 524	- 415	- 393	- 316

It has always-negative values: third party equity is necessary in order to cover long-term investments. However, the trend is increasingly improving and it has a reduction of about 50%. This datum states the debt ratio trend, which highlights a great intervention of the external sources compared to the equity capital.

- b) The *financing ratio for non-current assets* [(Equity + Long-term debts)/Fixed assets] considers the use of both own funds and third party equity in order to cover long-term investments (table 8).

2008	2009	2010	2011	2012	2013	2014	2015
2,66	3,07	2,50	2,77	3,01	3,25	3,26	3,28

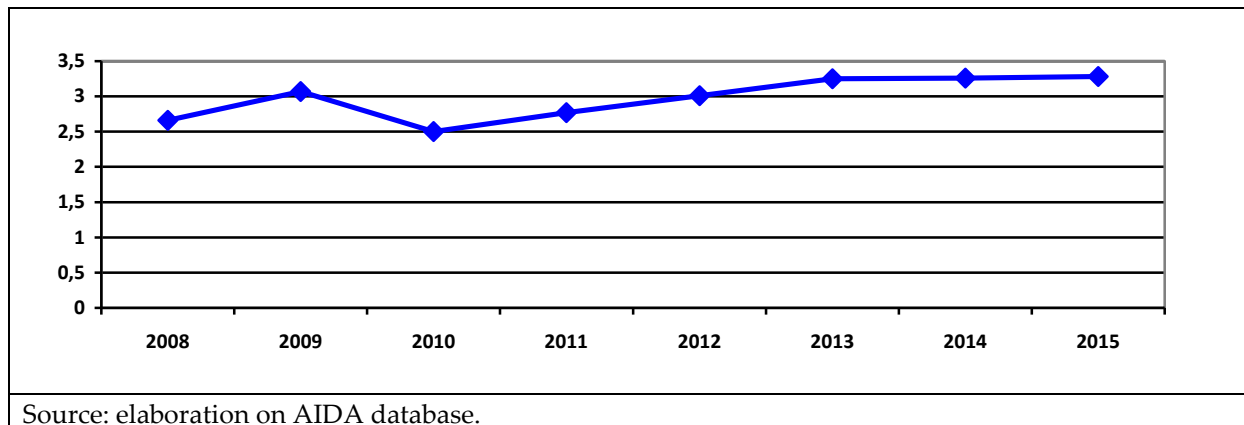

The trend is almost constant, except for 2010, which represents a minimum peak. After 2010, the trend is increasing. The industry tends to take constant values despite the reduction of the fixed asset to equity capital margin. This is interpreted in various ways. It could be the effect of the decreasing value of the durable assets for the obsolescence and senescence, which take to new investments, or it could be due to an increasing long-term debt. In this analysis, it is not possible to determine precisely the reason, which will ask for more data.

## 6.2 Profitability analysis

The ratios used are ROE, ROI and ROS. ROE (*Return on equity*) (Net income/Equity) is a measure of the company profitability, which referred to different areas: operations, financial and extra-ordinary operations (Tieghi, 2004). In order to evaluate and organise the strategies to improve company profitability there is a need for a ratio, which measure the potential of company profitability, regardless of extra-ordinary operations, financial events and tax burden. This is the role of Roi (*Return on Investment*) [Operating income/ (Equity + Bonds + Long-term bonds + Bank debts + Long-term bank debts + Debt to members + Long-term debt to members)], which expresses effectiveness and efficiency in the management of the firm business areas (purchase, production and sales) (Bubbio, 2007).

ROS (*Return On Sales*) [Operating income/ (Sales revenue + other revenues)] expresses the remaining margin after the coverage of the business costs with sales revenues (Campedelli, 1990).

Profitability ratios do not have thresholds parameters and change from one industry to another. The industry considered is characterised by the following values (table 9).

Year	Roe	Roi	Ros
2008	6,46	7,89	4,27
2009	4,22	6,63	3,48
2010	7,89	7,17	4,15
2011	6,98	7,18	4,17
2012	6,56	6,62	3,59
2013	6,21	7,56	3,88
2014	9,14	8,19	4,16

2015	11,90	8,84	4,47
------	-------	------	------

The sector has a good profitability profile, despite the crisis. The minimum values, even positive, are present in 2009. Then, they improve with discontinuity (table 10). They rank consistently among even greater levels than government securities considered as a valuable benchmark. Even in the worst years, the profitability is positive and acceptable.

Table 10: Profitability ratios

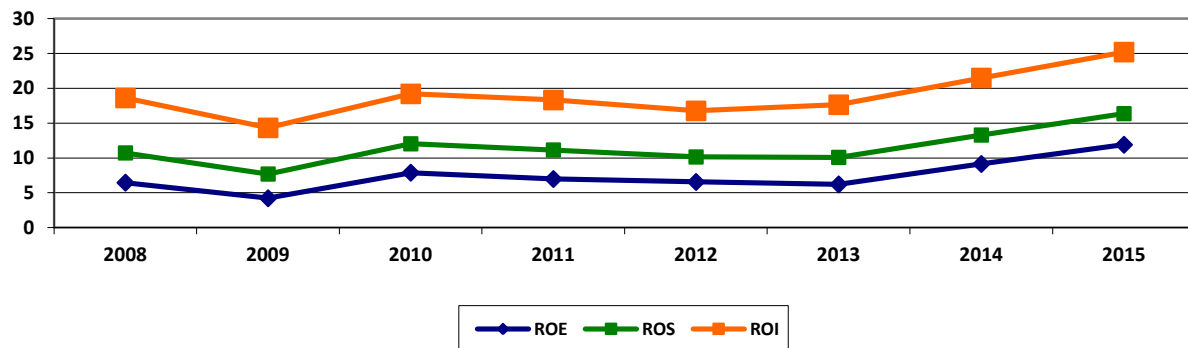

Source: elaboration from AIDA database.

## 7. CONCLUSIONS

The recent economic crisis affected the different productive sectors with different consequences. The plastic material production shows a low negative effect of the crisis on Italian companies, mainly resulting from the growing need of the product on all international markets. Italian industry has followed the international trend, by recording similar satisfactory values also in the crisis years.

This study investigated the effects of the crisis on capital, financial and income balances on a sample of Italian companies with a good market space in the global and European production.

The analysis derives from the study of a high number of firms' financial statements for eight consecutive years. It shows that the positive market conditions have obviously beneficial effects on relations between sources and financial investments and on corporate profitability. The worrying situation is about the relation between internal and external sources: the predominance of the second ones reduces the profitability, which has, however, a good and positive value. Positive profitability outcomes could also derive from a judicious monetary policy of the European Central Bank, which has kept the interests low for capital procurement.

The plastics industry therefore requires, however, a significant investment of equity capital in a national financial market still characterized by significant under-capitalization of companies, therefore, they have to address to third-party sources. The opposite signs of the structure and the index of fixed income coverage, which also considers the medium and long-term loans, confirm this judgment. The first highlights the equity gap replaced by third-party capital for fixed asset coverage.

Even if it seems evident that capital costs have not affected the profitability, the undercapitalisation represents a limit to freedom in firm management. The excessive use of third party equity leads to frequent financial emergencies due to the deadlines imposed by the return of the funds and to the need for new sources. Moreover, the administration could be dampened by fundraisers' need to criticize the choices of new investments made by the internal bodies, and that may harm the refund of the third party equity. It is quite realistic to think that a better balance between financial sources would allow freer, more efficient and more effective choices, which are also more profitable, leading to self-financing and to investments free from thirds' choices. The short-term situation is satisfactory and presents a positive relation between liquidity and stock, considering the trend and the linked ratios.

Such issues, however, must consider the necessary quality of the data obtained from Aida database. During the research, it seemed preferable to eliminate the margin cash, because it was in contradiction with the short-term financial ratios. The contradiction probably derives from the information system mode of calculation.

A deeper analysis must ask for other ratios, which had better explained the relation between sources/application of funds, in particular for the impact of the equity capital on total sources. It will be possible to devise an eradication policy for the industry in question and for a great number of its firms. The readjustment of sources does not seem so problematic, given the high profitability of the sector, which can also improve by reducing financial costs. Such investigation should be deepened and extended to comparisons, among different countries. Moreover, it represents a new proposal compared to the traditional international bibliography, which is highly focused on technical aspects and production of plastics and their relative impact on environmental pollution.

## REFERENCES

- Accorsi, R., Cascini, A., Cholette, S., Manzini, R., Mora, C. (2014), "Economic and environmental assessment of reusable plastic containers: A food catering supply chain case study", *International Journal of Production Economics*, Vol, 152, pp. 88-101.
- Alcántara-Concepción, V., Gavilán-García, A., Gavilán-García, I.C. (2016), "Environmental impacts at the end of life of computers and their management alternatives in México", *Journal of Cleaner Production*, Vol. 131, pp. 615-628.
- Antonelli, V., D'Alessio, R., Dell'Atti, V. (2007), *Analisi di bilancio e Basilea 2, Indici, rating di settore, valutazioni*, 2ª edizione, Ipsoa, Milano.
- Asamongtham, P. (2012), "Factors affecting cost management of SME factory entrepreneurs in the plastic industry in Pathumthani during the economic crisis", *European Journal of Economics, Finance and Administrative Sciences*, No 53, pp. 6-14.
- Aydogan, E.K., Ates, N., Uzal, N., Zaral, F., Papajorgji, P. (2013), "Sustainable waste management system and reverse logistic network design in plastic industry: A case study of Turkey", *Enterprise Business Modeling, Optimization Techniques, and Flexible Information Systems*, pp. 159-176, also in *Sustainable Practices: Concepts, Methodologies, Tools, and Applications*, Vol. 2, pp. 867-880.

- Bubbio, A. (2007), *Il sistema degli indici di bilancio e flussi finanziari. Due strumenti a supporto dell'attività di direzione*, Isedi, Milano.
- Cai M., Savio G.D. (2013), *Il riciclo della plastica. L'impatto economico della filiera italiana del riciclo indipendente della plastica*, Franco Angeli, Milano.
- Campebelli, B. (1990), *Le analisi di bilancio per la revisione aziendale*, Giappichelli, Torino.
- Corbett, L.M. (2000), "Environmental management systems in the New Zealand plastics industry", *International Journal of Operations and Production Management*, Vol. 20 No 2, pp. 204-224.
- Cozzi, S. (2016), "Inquinamento marino. Plastica, problema planetario", *Largo consumo*, Vol. 36 No 3, p. 30.
- Damoah, O.B.O. and Nyarko, A. I. (2016), "The influence of leadership strategies on organisational commitment: Evidence from the plastic manufacturing sector of Ghana", *Management Education*, Vol. 16 No 4, pp. 1-12.
- Fadda, L., Fontana, F., Garelli, R. (2008), *Analisi di bilancio*, Giappichelli, Torino.
- Glerean, P. (2012), "Il futuro della plastica", *Largo consumo*, Vol. 32 No 12, p. 108
- Hallam, C., Flannery, W., Liu, S.-C. (2009), "Lean production for technology management: Increasing production, reducing waste and quality improvement strategies in a plastic bags manufacturing facility", *PICMET 2009: Portland International Conference on Management of Engineering and Technology*; Portland, OR; United States; 2-6 August 2009.  
[https://aida.bvdinfo.com/Search.QuickSearch.serv?\\_CID=1&context=U7E4CLBUK2UWO30](https://aida.bvdinfo.com/Search.QuickSearch.serv?_CID=1&context=U7E4CLBUK2UWO30) consultato il 19/09/2016
- Istat (2016), *Rapporto sulla competitività dei settori produttivi*, Istat, Roma.
- Kerns, J. (2016), "Replacing metal with plastic", *Machine Design*, Vol. 88 No 9, pp. 34-42.
- Kume, K. and Fujiwara, T. (2016), "Production Flexibility of Real Options in Daily Supply Chain", *Global Journal of Flexible Systems Management*, Vol. 17 No 3, pp. 249-264.
- Lélis, E.C. and Simon, A.T. (2013), "Relationship management in a plastic part industry of the automotive chain", *Gestao e Producao*, Vol. 20 No 4, pp. 899-911.
- Low, M.L.H. and Lee, K.S. (2008), "Mould data management in plastic injection mould industries", *International Journal of Production Research*, Vol. 46, No 22, pp. 6269-6304
- Migliaccio, G. (2013), *La dimensione quantitativa della gestione. Aspetti teorici e applicativi*, Angeli, Milano.
- Paksoy, T., Aricioglu, M.A., Gules, H.K., Alaykiran, K. (2006), "Supply chain management strategies and applications: A benchmarking study in plastic profile industry", *Portland International Conference on Management of Engineering and Technology*, Vol. 2, pp. 826-836.
- Ravi, V. (2015), "Analysis of interactions among barriers of eco-efficiency in electronics packaging industry", *Journal of Cleaner Production*, Vol. 101, pp. 1-10.
- Resende, V., Alves, A.C., Batista, A., Silva, A. (2014), "Financial and human benefits of lean production in the plastic injection industry: An action research study", *International Journal of Industrial Engineering and Management*, Vol. 5 No 2, pp. 61-75.
- Ricci, P. (Ed.) (2012), *L'economia dell'azienda: paradigmi e declinazioni*, Giuffrè, Milano.
- Steuer, B., Ramusch, R., Part, F., Salhofer, S. (2017), "Analysis of the value chain and network structure of informal waste recycling in Beijing, China", *Resources, Conservation and Recycling*, Vol. 117, pp. 137-150.
- The European House – Ambrosetti (2013), *L'eccellenza della filiera della plastica per il rilancio industriale dell'Italia e dell'Europa*, Milano, dal sito: <http://www.corepla.it>.
- Tieghi, M. and Gigli, S. (2004), *Gli strumenti per l'analisi del bilancio di esercizio*, Il Mulino, Bologna.
- Valarmathy, R.S. (2015), "Eradication of plastic carry bags: The shop owners' perception", *Indian Journal of Marketing*, Vol. 45 No 2, pp. 31-40.
- Van Eygen, E., Feketitsch, J., Laner, D., Rechberger, H., Fellner, J. (2017), "Comprehensive analysis and quantification of national plastic flows: The case of Austria", *Resources, Conservation and Recycling*, Vol. 117, pp. 183-194.
- Villa, E. (1997), "Componenti in plastica: una efficiente struttura finanziaria garantisce la permanenza sul mercato", *Amministrazione & finanza*, Vol. 12 No 14, pp. 35 – 39.  
[www.ec.europa.eu/eurostat/statisticsexplained/index.php/manufacturing\\_statistics\\_-\\_NACE\\_Rev.\\_2#further\\_Eurostat\\_information](http://www.ec.europa.eu/eurostat/statisticsexplained/index.php/manufacturing_statistics_-_NACE_Rev._2#further_Eurostat_information) consultato 23/03/2016  
[www.istat.it/it/strumenti/definizioni-e-classificazioni/ateco-2007#codesearch](http://www.istat.it/it/strumenti/definizioni-e-classificazioni/ateco-2007#codesearch) consultato il 27/03/2016  
[www.plasticseurope.org](http://www.plasticseurope.org) consultato il 23/03/2016
- Xu, J., Jiang, X., Wu, Z. (2016), "A Sustainable Performance Assessment Framework for Plastic Film Supply Chain Management from a Chinese Perspective", *Sustainability*, Vol. 8 No 10.
- Zaman, A.U., Swapan, M.S.H. (2016), "Performance evaluation and benchmarking of global waste management systems", *Resources, Conservation and Recycling*, Vol. 114, pp. 32-41.

Zhou, C., Fang, W., Xu, W., Cao, A., Wang, R. (2014), "Characteristics and the recovery potential of plastic wastes obtained from landfill mining", *Journal of Cleaner Production*, Vol. 80, pp. 80-86.

## CITIZEN SATISFACTION IN ITALY: RESULTS FROM AN EMPIRICAL RESEARCH

Migliaccio, Guido<sup>1</sup>; Russo, Agostino<sup>2</sup>

<sup>1</sup>Department of Law, Economics, Management and Quantitative Methods, University of Sannio, Benevento, Italy;

<sup>2</sup>Salaries service, Province of Benevento, Benevento, Italy

### ABSTRACT

The Italian public administration research consistently effective and efficient organizational models aimed at the full satisfaction of the user. A continuing problem is the use of a fair assessment mode of the services offered: from the results often depend economic interests related to incentive bonuses payable to executives and staff.

It is understandable, therefore, the delicacy and difficulty of identifying tools, methods and interpretative criteria of citizen satisfaction investigations.

This paper describes an empirical research carried out at the employment office of Province of Benevento in Italy. Online questionnaire they were evaluated some aspects of the service provided to users. They have participated for about 10% of the users. The results diverge significantly compared to similar surveys carried out in the same context with different methodologies. Even within the limits of the method used, the project can be easily exported to other offices of public administration, considering its low costs, provided that it registers an actual need for transparency.

*Keywords: Citizen Satisfaction; Employment offices; Public Employment Services.*

### INTRODUCTION AND MOTIVATION: AIMS AND STRUCTURE OF THE PAPER

The organization and the high cost of the Italian Public Administration are the object of study by Italian researchers and part of the international Academy. The various attempts to make a public apparatus economically, effectively and efficiently are the subject of reflections of many experts (Migliaccio, 2011). In recent years there has been a sharp change of the general approach, moving from bureaucratic logic to meritocratic criteria. The State must consist of simple offices that respond immediately to citizen's

---

The paper is the result of a collaborative work. However it is possible to attribute to Agostino Russo: research methodology, results and discussion. The other sections are of Guido Migliaccio.

needs. This paper proposes some significant insights into the managerial skills of the Italian Public Administration: citizens should participate more in political choices that must be evaluated also in relation to social, economic and financial results achieved by various agencies in different levels of intervention.

The first significant problem that should be solved is in relation to the mode used to probe the actual citizens of the assessments with the services provided by public administration offices. Here is the first question:

RQ 1: how to assess the quality of services offered to the citizen?

Arises, then, the problem of the methodology to be proposed, so that, the instrument chosen is proposed to champion of citizens sensitive to the research. It is obvious that we must protect the confidentiality of information gathered, so that, they are really expressive of the user judgment. Here is the second question:

RQ 2: how to propose the survey instrument chosen for our citizens?

Finally, to be considered is the problem of the interpretation of the results that may be different to that which in similar surveys is conducted with different criteria and methodologies, even with support by law in force as it's been happening in Italy. Here is the third question:

RQ 3: how to interpret the survey results?

In order to respond to the questions outlined we propose an experimental investigation, through on-line questionnaire, realized with collaboration of the employment office of the Benevento province, which is a municipality of modest size located in southern Italy.

In particular, the objectives of this paper are:

- to emphasize the importance of a correct and transparent relationship with citizens;
- to highlight how the assessment of users of a public service can improve its effectiveness and efficiency;
- stress that the information system can constantly monitor the user-public administration relationship;
- to propose an appropriate methodology using up-to-date IT systems to properly reflect the opinion of citizens to the quality of a public service.

After outlining the theoretical framework in which this study is grafted with connection, in particular, to previous investigations of similar content developed in Italy and abroad, the paper explains the purpose of the investigation, the instrument used, the mode of administration and, finally, the results obtained comparing other results from similar surveys.



In conclusion, we present some considerations and the possible scenarios export cases of this experience in other areas of Italian public administration and other nations that have similar demands, however pointing out the limits and possibilities of future research developments.

## **THEORETICAL BACKGROUND**

The analysis of the satisfaction of the citizens of a state with respect to the provision of public services and therefore the function of offices is widely investigated in the Italian and international scientific doctrine.

It talks about of the purpose of this kind of analysis that should be mainly aimed at measuring the effectiveness and efficiency of services provided and thus achieve improvement programs that derive from citizens' proposals. Politicians can also use the information to manage and steer the consent of voters favoring a more flexible relationship between represented and representatives.

The technical tools used to measure the satisfaction of the citizens are different. Morgeson (2014), for example, investigated the topic of satisfaction with government services from a variety of perspectives, using case studies and empirical results from satisfaction studies at the federal level.

The Italian scientific literature suggested contributions related to the overall theme of the satisfaction of Italian citizens (Lo Schiavo 1997, Polidori and Fiorillo, 2003) and European (Lo Schiavo, 2002), proposing specific statistical surveys related to limited contexts, for example the city of Rimini (Giacalone *et al.*, 2014). Much more diffused, however, are the studies published relating to specific sectors of the national economy, interesting for both the method used to investigate the satisfaction of its citizens, that for the achievements that can be inspiring for effective public policies.

For example, Scanagatta and Segatta (2008) analyzed the information needs of the operators of social services particularly interested in the detection of opinions, information, or other data relating to the structure in which they operate. The study was conducted in the Veneto region and leads us to reflect on the essential elements and fundamental to understanding the centrality of citizen satisfaction and the best type of surveys needed for the operator to get a proper measurement.

Other studies relative to Italian context have focused attention on satisfaction of some stakeholders of health services (Scanagatta and Furlanetto, 2008; Vainieri, 2006), the courts (Finocchiaro *et al.*, 2012), of the prefectures (Rizzo, 2006), services removal of garbage (Council *et al.*, 2012), and state tax (D'Angelo and Orlando, 2003).

There are no significant relevant experience related to the satisfaction of users of renovated provinces and, in particular, of the provincial labor employment offices. That is why this research has tried to fill this gap.

International studies relating to the satisfaction of the citizens are very numerous. As in Italy, researchers are experimenting with measurement models of citizen satisfaction, especially for the efficiency evaluation of public administration services.

Interestingly, for example, the study from Daunoriene and Zekeviciene (2015) which, although it concerns a small country in development such as Lithuania proposes a reference model of public institutions' quality practices, citizen satisfaction and performance quality. Using secondary data alongside with methodological measurement, this paper representation provides information about citizens' perceptions about the influence of public institutions' quality improvement actions on citizen satisfaction and public institutions' quality performance. Developing and exploring reference model integrating different relationships between public institutions' quality practices and infrastructure quality, and application waiting time and quality information. Moreover, the relationship between public institutions' performance quality and public institutions' quality practices shows the importance of continuous improvement initiatives. Reference model tested on the secondary statistical data presents evidence and information provides results in order to take effective decisions.

There are also those who work "in reverse" by measuring the user dissatisfaction aiming to arrive at a similar knowledge. This is the case, for example, the study by Olsen (2015) who introduces the importance of equivalence framing on understanding how satisfaction measures affect citizens' evaluation of public services. Two experiments were conducted on citizens' evaluations of hospital services in a large, nationally representative sample of Danish citizens. Both experiments found that exposing citizens to a patient dissatisfaction measure led to more negative views of public service than exposing them to a logically equivalent satisfaction metric.

Recently further empirical analyzes have been conducted, for example, that of Tummers *et al.* (2016) which measured the impact of red tape on citizen satisfaction: red tape has a strong negative effect on citizen satisfaction, and that this effect is weaker when citizens have high knowledge of political processes.

Contrary to the Italian literature, many foreign authors have ventured into the test methods for the evaluation of effectiveness and efficiency of the labor employment offices in different states. Referencing the 1990's eg. Althin and Behrenz (2015) aimed to measure the efficiency and productivity of Swedish labor employment offices. Using four inputs, five outputs, and two quality attributes the efficiency and productivity of 253 Swedish labor employment offices are evaluated using models of relative technical efficiency and Malmquist productivity indices. Even Vassiliev *et al.* (2006) have experienced a quantitative evaluation of the labor employment offices' performance in Switzerland based on production efficiency measures. They use Data Envelopment Analysis (DEA) to estimate the performance of all employment offices and then account for factors in the local operating environment

that are outside managerial control. This approach, and the ranking of labor employment offices, may easily be interpreted by policymakers and provides guidelines for raising the efficiency of the public employment service.

Interestingly is the more recent study by Hainmueller *et al.* (2016) both it refers to an economically strong country such as Germany, and because it focuses on caseworker-to-clients ratio that is an important, but understudied, policy parameter that affects both the quality and cost of public employment services helping job seekers find employment. In the international bibliographic landscape, However, the study closely matches the intent of this paper is to Sivitanidou (1996). Although related to a search more than twenty years ago, the article tries to measure how office-commercial firms value access to service employment centers. Proposes to hedonic value analysis within polycentric Los Angeles. These tests involve the analysis of office property values per unit land across sites differing in center access.

Despite the laudable efforts of so many scholars from different cultural backgrounds, it has not yet been proven an adequate method of analysis of the degree of customer satisfaction to employment office on the side of potential labor demand. This study, therefore, has applied to employment agencies an empirical research in order to assess their degree of satisfaction enriching, even within the limits indicated below, the areas of research on the subject.

## RESEARCH METHODOLOGY

In Italy, as in many other countries, it is accentuated the need of the community to give back “word” to the citizen/user investing they with a key role in the evaluation process with the help of tools and commonly used methods of ICT.

With this experimental study we tried to evaluate the effectiveness of a public office with innovative methods and tools.

With a questionnaire were collected feedback on the quality of the services and staff that provide them, introducing a new type of alternative assessment to the official one adopted by the Province of Benevento, a city located in southern Italy.

The survey was conducted at the Employment Office of the Province of Benevento in frequent contact with citizens via the front-office.

The questionnaire (Table 1) consists of a brief presentation of research indicating its purpose and of 20 questions. in it they highlight the need for transparency, accountability, and the measurement of company performance. Four final questions are intended to gather information on the characteristics of the investigated sample.

Employment Office of the Province of Benevento

#### CUSTOMER SATISFACTION SURVEY FOR THE IMPROVEMENT OF SERVICES TO CITIZENS USERS

The Province of Benevento, as a new local authority, in a general reorganization framework of powers and functions, and the changed relationship between Public Administration and citizen, intends to pay particular attention to the issues of transparency, accountability and corporate and individual performance. It wants to adopt and enable new mechanisms of participation and collaboration between citizens/users and Public Administration, enable a new type of social control, placing at the center of its mission the citizen/user satisfaction.

The Employment office of the Benevento Province in addition to pursuing the primary goal of maximum employability through the match between supply and demand, providing to young and old people, tools and mechanisms for access to employment, intends, with this questionnaire, give practical effect to purposes of Legislative Decree no. 150/2009 on the optimization of the public labor productivity and efficiency and transparency in public administrations, as well as the most recent Legislative Decree no. 33/2013 subject of transparency and dissemination of information by public authorities.

In view of continuous improvement of the service offered, with this questionnaire, it wants to collect the public feedback, find the strengths and weaknesses, paying particular attention to the critical situation in order to act on it to improve our service.

	Choose only one value				
1. Public reception: service indication	1	2	3	4	5
2. Kindness of the staff	1	2	3	4	5
3. Shortness of waiting	1	2	3	4	5
4. Clarity of information received	1	2	3	4	5
5. Completeness of information received	1	2	3	4	5
6. Staff's availability to the telephone	1	2	3	4	5
7. Adequacy of opening hours to the public of the CPI offices	1	2	3	4	5
8. The signage within the building is clear, appropriate and suitable for the purpose of informing	1	2	3	4	5
9. In general, employees provide consistent and reliable service expectations	1	2	3	4	5
10. In general, employees are available and provide timely service	1	2	3	4	5
11. In general, employees are expert and have a deep knowledge of the treated theme	1	2	3	4	5
12. In general, employees are accessible and easy to contact from the outside through computer contacts (email, pec)	1	2	3	4	5
13. In general, employees are courteous, polite and respectful of others' needs	1	2	3	4	5
14. In general, employees are listening to me and speak in order for me understandable	1	2	3	4	5
15. In general, the structure of the Employment office offers comfortable surroundings	1	2	3	4	5
16. In general, employees strive to understand my needs	1	2	3	4	5
17. Acknowledge and uses the portal SannioLavoro	1	2	3	4	5
18. How satisfied/a total performance of the Centre for Employment	1	2	3	4	5

19. Overall, the value of this service for me is (from very low to very high) 1 2 3 4 5
20. Compared to the time spent and the other sacrifices to access the service considers that the service received has satisfied his needs 1 2 3 4 5

21. Motivation for which he/she has got to at Employment office: choose all corresponding search for a permanent job

search of any job

handling administrative practices

search for a part-time job

search for a temporary job

Attend a training course

Attend stage or apprenticeships

Access to information

Changing jobs

other

Users General information

22. Titolo study:

23. Sex:  Female  Male;

24. Age ..... Only numerical values are allowed for this field

You want actively to thank in advance all those who will participate in this survey, knowing that your precious collaboration is indispensable and irreplaceable element for achieving the maximum citizen satisfaction.

Table 1: *Questionnaire*

Initially, the questionnaire was in paper format and the compilation did not ensure the necessary privacy for delivery on site to an employee in charge of the collection: it was feared that the assessments were influenced or even "suggested".

In fact the first paper questionnaires collected (over a hundred) had almost unanimously, for all the questions, the maximum expressible judgment. It was necessary, therefore, to abandon the paper instrument and prepare the on-line form, choosing <http://app1.provincia.benevento.it/limesurvey/index.php/admin/survey/sa/index> site that allows online surveys line.

It must, preliminary report a first limit of such a tool, constituted by the fact that the values of ratings vary from a minimum of 1 to a maximum of 5, not being possible to change the amplitude of such scale. It would have been more interesting to have a range of values from 1 to 10, this would have allowed to investigate the results with greater depth. The other limit is that of authentication. To preserve anonymity and to the objective impossibility to customize because of the lack of economic resources and processing times, access to the site was left free, it does not require personal credentials. It was

orally reported to users benefitting services of the Centre for Employment the Internet address to connect and recommended filling in this form.

The transition from paper-based tool to online has raised concerns, mistrust, fear among the employees of the Employment office to evaluation methods not approved by law, and had to ensure the them that questionnaire' results were only an experimental value without any concrete implication on the assessment and delivery of monetary awards which continued to be made by the system formally adopted by the Province.

Such a reaction of concern and mistrust, for the transition from a system governed by law, to an online system that does not allow "adjustments" but that forces you to take note of an assessment given, can be considered a confirmation of the validity of the instrument itself but before of the basic idea of the experiment.

## RESULTS AND DISCUSSION

Among the results of empirical research conducted in the period October 2014 - January 2015 must be reported, the modest subscription of those who have joined the survey: the average turnout of 30-40 users per day, for about 2000/2500 estimated users in the period investigation, led to the compilation of only 240 questionnaires, approximately 10% of the potential. This is probably due to the distrust towards to investigation in addition to the almost total absence, in the citizen/user of the culture of participation in an evaluation process. Table 2 below indicates, first of some statistical data related to the investigation.

Total users estimated	Total questionnaires completed	Compilation%	Average time of compiling	Arithmetic average	Average age
2500	240	9,6%	2,48 minuti	3,72	33,54

Table 2: *Survey characteristics*

The percentage of membership, compared to total number of users is still good enough to be able to consider the useful results, especially since, those who completed the questionnaire did so in full freedom and that the sample is completely random.

The analytical results are in Table 3.

Question	Score
A15 In general the structure of the Employment office offers a comfortable environment	4,25
A8 The signage within the building is clear, appropriate and suitable for the purpose of informing	4,08
A13 In general employees are courteous, polite and respectful of others' needs	4,05
A7 Adequacy of opening hours to the public of the CPI offices	3,98
A16 In general employees strive to understand my needs	3,93
A2 Kindness of staff	3,85

A11 In general employees are expert and have a deep knowledge of treated theme	3,84
A9 In general employees provide consistent and reliable service expectations	3,79
A14 In general employees are listening to me and speak in order for me to understandable	3,79
A1 Public reception: service indication	3,66
A4 Clarity of information received	3,64
A19 Overall, the value of this service for me is (from very low to very high)	3,63
A17 Acknowledge and uses the portal SannioLavoro	3,61
A18 How satisfied a total performance of the Center for Employment	3,61
A10 In general employees are available and provide timely service	3,60
A20 Compared to the time spent and the other sacrifices to access the service considers that the service received has satisfied his needs	3,53
A5 Completeness of information received	3,48
A6 Staff's Availability to the telephone	3,43
A12 In general employees are accessible and easy to contact from the outside through computer contact (e-mail, Pec)	3,33
A3 Shortness of waiting	3,26

Table 3: *Detailed Results of the questionnaire in descending order of score*

The purpose of the investigation has tended to investigate citizen satisfaction with connection to services received, but also to redefine the flow of the activities conducted at the office to avoid waste and improve the quality of services. We must therefore focus primarily on summary data rather than analyzing the outcome of each individual question.

The Employment Office fulfills discreetly, without exceeding in any field, to supply utility moderately satisfying the citizen's. This is confirmed by the average value, which stood at 3,72/5.

This result is different from that obtained from the official assessment, proposed by the evaluation council and confirmed by the political council, often positioned at the highest level.

A reflection is necessary if, using different evaluation systems and various players, you come to conflicting results.

To consider also that the official assessment leads to give out awards pecuniary from state finance.

The overall assessment registered by questionnaire it would position manager and staff at level "Adequate" which means "average in line with performance standards or expectations. Manifestation of average satisfactory behavior/results although with defects or sporadic and unsystematic gaps. The assessed needn't to of support interventions". The economic effect would be a curtailment of more than 40% of the pecuniary award.

Changing subjects, tools and method, then, you come to significantly different results!

The experiment conducted in the Province of Benevento, on Innovation footsteps, it proposes to change perspective; the centrality of the citizen, or stakeholders in general, on one hand and the quality of services other side and around these to hook the evaluation system of manager and the staff.

The macro objective of this experiment, stated above, in order to better analyze the feasibility and the degree of implementation of the same, is further divided into at least three sub-goals:

- 1 define a reproducible system and applicable in every Public Administration .;
- 2 gradually replace or come up beside the assessment of strategic and management objectives, the assessment of the services provided, timing and quality of the these;
- 3 reduce the large gap that exists between evaluation or rather we should say of self-assessment of Public Administration and evaluation (at the time only perception) that citizens have of the services offered by Public Administration.

With regard to the first point: despite the initial difficulties encountered however the test has continued and has produced results in a generally wary territory with respect to changes. In addition, it is having reached this result allows to state, with good conviction, that this experimental method, with the help of ICT technologies lends itself to be easily and instantly replicated anywhere in the national territory and in many other public offices.

In reference to the second point, starting from the premise that it is possible by changing the subject, the tools and the method, to evaluate and making judgments, it should be noted that the “evaluation of a service” is a synthesis of several evaluations:

- the baseline performance, and for a local authority may be a certificate, the registration, authorization or the concession, etc;
- of the structure: ease of access, service delivery mode;
- of the relations: courtesy and competence of the front office staff;
- of the top management that proposes innovation and change, able to anticipate the times by identifying new needs and then propose new services and modes of delivery them;
- of the back office staff that helps make possible, not only provide the service, but also the services’ quality;
- the quality of service received and time services delivered.

Hence, it is hoped that the evaluation of the services can replace the evaluation for objectives. The work of employees can and should be aimed at achieving the objectives but the estimation should not be made only on the objectives.



Regarding, finally, the third point we need to focus on “cultural” change that is fundamental in order to make evaluation of the public service in a way and with more consistent methods to the needs of citizen’s. Given that “the search for an indicator or set of indicators, that solves definitively every problem of measurement, control and decision, in the public sector is in vain an activity as well as little proper methodologically (Mussari, 2001)” or to quote Albert Einstein, “not Everything that can be counted counts, and not everything that counts can be counted” would be more appropriate to define and share a new evaluation system that has as its main focus to give credibility to the evaluation, as well as measure the “creation social value “in perspective” social innovation “and last but not least, make smart way assessment, in the sense of maximum accessibility, immediacy, security and reliability of the results. It should switch from artisanal assessment and self assessment to the Web assessment, using Media for the assessment of managers and staff, and especially considering the perception of user about services received.

The use of the web and, in general, of non-traditional tools and channels (wiki and social networks) should be used to capture, from stakeholder ratings, a different version of the public administration's reality, being aware that open and diffused is more credible and more trustworthy than one's own judgment.

Another problem that arises is the measurement of the assessment of the overall quality of services and therefore the measurement of a new concept “business reputation” and every person involved in the process, at all levels; reputation understood as the process of estimating and trust gained and to monitor it and maintain over time.

Quality and reputation, in fact, converge in a single evaluation system.

A comprehensive evaluation system should not only show the results of individual and organizational goals and / or performances, but must, on the one hand, seek and evaluate the overall quality required for customer satisfaction and, on the other hand, the measurement of the reputation. Reputation, it can be imagined as the equivalent of a rating system, then switch from a judgment of few to a widespread judgment.

This concept should allow us to abandon the current view of executive management as an incardined figure in an articulated, bureaucratized and enclosed system within the limits of the entity to reach a "public manager" rating and recognition of its capabilities / Quality in an enlarged system at a regional or rather national level between homogeneous entities or homogeneous professional figures.

Only in this way the evaluated subject acquire a spendable rating and it can build a labor market even within the public administration capable of selecting, attract and reward, finally, the deserving subject, which the current legislation was not yet fully able to implement.

## CONCLUSIVE REMARKS, LIMITATIONS AND FUTURE RESEARCH

The paper have illustrated an experimental research carried out recently at employment office of the province of Benevento. Through questionnaires this paper wanted to analyze the degree of satisfaction of services provided to its citizens, considering different aspects. The survey has had several purposes: surely that of improve the effectiveness and office's efficiency, but also to compare the results obtained with the official ones deriving from a different analysis methodology. The best reviews are about the structure of the Employment Office that offers a comfortable environment. The signage within the building is clear, appropriate and suitable for the purpose of informing. In general, employees are courteous, polite and respectful of others' needs; They strive to understand the needs of the public. Employees are expert and have a deep knowledge of the treated theme. The opening hours for the public of the offices are adequate.

The main criticisms are, however, relative to the time spent and the other sacrifices to access the service, especially because the staff is unavailable on the phone and is hardly contactable from the outside through computer contact (email, PEC). The information provided should be more detailed and clear. Surely it is useful to know the positive aspects of the service, even to gratify deserving staff. Criticisms that help increase the efficiency and efficiency of the service are much more useful. From the survey clearly emerges the need to enhance the means of distance contact between offices and citizens who wish to receive comprehensive and quickly responses. In the specific case, the offices should activate an easily accessible telephone service and also telematic contact tools that also use social networks that are increasingly popular with users.

It is also necessary to highlight some of the criticisms of the methodology used to probe the opinions of citizens. First, it is necessary to avoid the paper questionnaire of collecting information that cannot and does not guarantee anonymity and then the sincerity of the responses that could be easily changed. It is preferable and it must be encouraged the use of on line tools instead of the paper questionnaire. Only through universal diffusion and easy use of apps allows the citizen to play a key role in the evaluation of public services.

Another critical problem, occurring which leads to adequate reflections is the unwillingness to participate in investigations of this kind from the users. We witness an obvious paradox: citizens require a transparent and efficient administration but, at the same time, they are unwilling to cooperate with it in meaningful reform attempts. This could result from distrust towards to surveys which are sometimes considered useless or the little time available to devote to attempts of this kind. Adoption of scientific instruments of citizen's satisfaction assessment has led to significantly different results than those that often follow official regulations: this can lead to a severe criticism compared to the existing rules governing the assessment of the quality of services. A significant reform of the legislation is

therefore necessary in favor of Tools and Methodologies that can really probe the evaluation of citizens, avoiding undue interference in the information gathering process.

In this sense, the survey provides a clear and indisputable guideline, proposing a different philosophy of the evaluation to be extended also to the reputation of the office and people working in it.

The illustrated research, however, is certainly not without limits, especially considering that it was realized in an office of a city of modest size with a questionnaire that can surely be richer and more articulate, expanding the range of possible evaluations and adding further matters to be evaluated. Just enough, also, the adhesion which obviously should be more massive.

The same outcomes, then, should be subjected to more rigorous statistical analysis that distinguishes the results in relation to sex, age, educational qualification, the employment status of those who participate, etc. thus reaching a disaggregated assessments certainly more useful for decision-making.

The attempt is, anyway, significant and could be exported to many offices of any other public administration in Italy and in many foreign countries, even considering the low costs for its implementation. However, it is necessary to find people who are really interested in knowing the user's judgment without prejudice and without leanings: some norms shall allocate awards pecuniary incentives in favor of manager and staff having a direct monetary interest in the outcome of the investigations. This could significantly compromise the design, performance and outcomes of any type of investigation.

## REFERENCES

- Althin, R. and Behrenz, L. (2005). "Efficiency and productivity of employment offices: Evidence from Sweden", *International Journal of Manpower*, Vol. 26 No 2, pp. 196-206.
- Consiglio S., Ragozini G., Zaccaria A. M. (Eds.) (2012), *Soddisfazione del cittadino e politiche pubbliche. La raccolta differenziata a Napoli*, Carocci, Roma, I.
- D'Angelo A. and Orlando A. (2003), "Qualità per i cittadini. Fisco e Citizen Satisfaction: un modello a equazioni strutturali per la rilevazione della qualità percepita dal contribuente", *De Qualitate*, No 4, pp. 72-80.
- Daunoriene, A. and Zekeviciene, A. (2015), "A reference model of public institutions' quality practices, citizens' satisfaction and performance quality", *Engineering Economics*, Vol. 26 No 4, pp. 422-430.
- Finocchiaro, R.; Mannino F. and Vivona P. (Eds) (2012), *Customer satisfaction negli uffici giudiziari giudicanti di Catania. Analisi della soddisfazione dei cittadini utenti e degli avvocati e praticanti avvocati*, Giuffrè, Milano, I.
- Giacalone, M.; Cusatelli, C. and De Lorenzo, A. (2014), "A citizen-satisfaction survey in Rimini", *Statistica applicata*, Vol. 26 No 1, pp. 51-63.
- Hainmueller, J; Hofmann, B.; Krug, G. and Wolf, K., (2016), "Do Lower Caseloads Improve the Performance of Public Employment Services? New Evidence from German Employment Offices", *Scandinavian journal of economics*, Vol. 118 No 4, pp. 941-974.
- Lo Schiavo, L. (1997), "Cittadini e la soddisfazione per i servizi pubblici", *Micro & macro marketing*, Vol. 6 No 1, pp. 155-172.
- Lo Schiavo, L. (2002), "La soddisfazione dei cittadini europei per i servizi pubblici", *Qualità*, Vol. 32 No 3, pp. 19-21.
- Migliaccio, G. (2011), "Aspects of Communication and Reporting in Italian Public Administration: Considerations about Recent Innovations", *Review of international comparative management*, vol. 12 No 4, , pp. 640-650.
- Morgeson F. (2014), *Citizen Satisfaction: Improving Government Performance, Efficiency, and Citizen*, Palgrave Macmillan, New York. US.

- Mussari, R.(Ed.) (2001), *Manuale operativo per il controllo di gestione. Analisi e strumenti per l'innovazione*, Rubettino, Soveria Mannelli, I.
- Olsen, A.L. (2015), "Citizen (Dis)satisfaction: An experimental equivalence framing study", *Public Administration Review*, Vol. 75 No 3, pp. 469-478.
- Polidori, P. and Fiorillo, F. (2003), "Le autorità per i servizi pubblici fra obiettivi locali, efficienza e soddisfazione dei cittadini", *Rivista di politica economica*, Vol. 93 No 7/8, pp. 135-156.
- Pye, R. (1976), "Effect of telecommunications on the location of office employment", *Omega*, Vol. 4 No 3, pp. 289-300.
- Rizzo, M. V. (2006), "Le prefetture adesso rilevano la soddisfazione dei cittadini", *Amministrazione civile*, Vol. 6 No 10, pp. 34-35.
- Scanagatta, S. and Furlanetto, A. (Eds) (2008), *Voci e consenso in sanità. Soddisfazione e legittimazione dei cittadini nella Regione Veneto*, FrancoAngeli, Milano, I.
- Sivitanidou, R. (1996), "Do office-commercial firms value access to service employment centers? A hedonic value analysis within polycentric Los Angeles", *Journal of urban economics*, Vol. 40 No 2, pp. 125-149.
- Tummers, L.; Weske, U.; Bouwman, R. and Grimmelikhuijsen, S. (2016), "The Impact of Red Tape on Citizen Satisfaction: An Experimental Study", *International Public Management Journal*, Vol. 19 No 3, pp. 320-341.
- Vainieri, M. (2006), "Che cosa influenza la soddisfazione dei cittadini toscani nei servizi territoriali di base? L'indagine di laboratorio 'management e sanità' del 2005", *Salute e territorio*, Vol. 27 No 156, pp. 137-142.
- Vassiliev, A.; Ferro Luzzi, G., Flückiger, Y. and Ramirez, J.V. (2006), "Unemployment and employment offices' efficiency: What can be done?", *Socio-Economic Planning Sciences*, Vol. 40 No 3, pp. 169-186.

## CAPITAL STRUCTURE AND PERFORMANCE: EVIDENCE FROM INDONESIA STOCK EXCHANGE

Miglietta, Nicola<sup>1</sup>; Battisti, Enrico<sup>1</sup>; Monge, Filippo<sup>2</sup>

<sup>1</sup>Department of Management, University of Turin, Turin, Italy

<sup>2</sup>Department of Economics and Statistics "Cognetti de Martiis", University of Turin, Italy

### ABSTRACT

This paper aims to investigate the impact that some economic and financial variables have on the performance of the companies listed in the Indonesia Stock Exchange (IDX), in order to compare companies *Shari'ah Compliant* within companies *not Shari'ha Compliant*, that are listed in the same market through the capital structure analysis. In particular, this paper explores the relationship between debts (including short-term debt, long-term debt and total debt), firm size (given by revenue size), total asset and performance measured by ROE (Return on Equity), ROA (Return on Asset) and Market to Book Value, in order to highlights differences between the companies listed in the same Islamic stock market. The empirical analysis suggests that for the companies observed the firms' performance are not influenced by the variables investigated. Therefore, there are no significant differences between the listed companies analyzed, both *Shari'ha Compliant* and *not Shari'ha Compliant*, in the various sectors considered.

*Keywords: Islamic corporate finance; capital structure; performance; Indonesia Stock Exchange (IDX); Sharī'ah Compliant; not Sharī'ah Compliant.*

### INTRODUCTION

The Islamic Corporate finance – understood as that whole things of Legal institutions, financial instruments, procedure, transactions and contracts that operate in accordance with the mandates and the traditions of the Islamic law (*Shari'ah*) – represents, in relative terms, almost the 3% (2016) of the worldwide finance and it's obtaining a more significant importance inside of the financial world system, with more than 20% of growth rates per year.

At the beginning of the 2017, the market value of the Asset Under Management (AUM) managed by Islamic financial institutions was more than 2.500 billions of dollars, with growth estimates close to 3.000 billions of dollars. It should be underlined how the fundamental *Sharia'ah* precepts have not only limited significance between the God-Man relationship but they represent the principles of behavior for the community of believers in every aspects of the public life since they supervise the adjustment of all economic activities.

The key factor of the Islamic finance is not the “Religion” but the component of “Economic Justice” which draws inspiration from the Islamic ethics. Shortly, the main regulations in the Economic-Financial field are attributable to the prohibition to apply a fixed and predetermined interest rate (*ribā*), guaranteed regardless of the investments performance; the principle of profit and loss sharing is also regulated by the *Shari’ah*, as the prohibition to implement economic practices that involve uncertainty (*Gharar*) and speculation (*Maysir*); in the end the ban to use, invest and trade forbidden activities. According to the principles of the Islamic law, there is freedom in the negotiating and economic activities though the possibility to make the agreements between parties it could be exercised within certain limits.

The purpose of this paper is to investigate the impact that some economic and financial variables have on the performance of the companies listed in the Indonesia Stock Exchange (IDX), in order to compare companies *Shari’ah Compliant* within companies *not Shari’ah Compliant*, that are listed in the same market through the capital structure analysis.

The remainder of the paper is structured as follows. First, a theoretical background examines capital structure and firm performance. The research method is then presented, followed by a discussion of the empirical results of this study. Finally, we finish the paper with some conclusions and possible directions for future research.

## **THEORETICAL BACKGROUND**

One of the most essential decisions that a financial manager has to make involves capital structure; financing decision of the company are an essential element of a study of capital structure composition (Sanusi, 2014). In this sense, there is much empirical evidence on the way managers of traditional companies make the capital structure decision and a large body of theoretical literature on this topic exists (e.g. Modigliani and Miller, 1958; Aggarwal, 1981; Pinegar and Wilbricht, 1989; Harris and Raviv, 1991; Rajan and Zingales, 1995; Ross et al., 1997; Booth et al., 2001; Damodaran, 2006; Tardivo et al., 2012; Brealey et al., 2015). Also from an Islamic point of view, the main theories of capital structure and its relationship with the creation of shareholder value have featured many academics. It determined the principles that underpin the system of the financial choice for the Islamic firms (e.g. Gunn and Shackman, 2013; Sanusi, 2014; Hoque et al., 2014; Ahmad and Azhar, 2015; Chandra, 2015).

Firm’s performance is affected by several factors and capital structure is one of the significant feature among them (e.g. Majumdar and Chhibber, 1999; Gleason et al., 2000; Jermias, 2008; Chandra, 2015). In this sense, in literature some empirical studies have analysed, in Islamic context, if there is some relation (negative, positive or not relation) between firm’s performance and capital structure (e.g. Razak et al., 2008; Pratheepkanth, 2011; San and Heng, 2011). In particular, these studies have

considered economic and financial factors like profitability, firm size, leverage, total asset, leverage, liquidity, volatility, age, growth opportunity, bankruptcy cost and taxes (e.g. Sheikh and Wang, 2013; Sanusi, 2014; Ahmad and Wan Aris, 2015; Wan Shahzinda and Wan Shahdila, 2015).

In addition, the relationship between capital structure and its determinants is very widespread in literature. Furthermore, empirical research on capital structure in Islamic countries has been the focus of single country studies (e.g. Ahmad and Azhar, 2015; Younus et al., 2014; Hossain and Hossain, 2015) or multi-country studies (e.g. Omet and Mashharawe, 2003; Gunn and Shackman, 2013). Previous single-country studies have focused on the Malaysian market (e.g. Hassan et al., 2012; Sanusi, 2014; Miglietta and Battisti, 2015, 2016) and some, especially in recent years, on the Indonesian market (Chandra, 2015).

In this sense, as previously introduced, one of the most important principles of the Islamic finance is the prohibition of *ribà*, which is defined as “any predetermined or fixed return in financial transaction” (Aggarwal and Yousef, 2000). Moreover, from a financial point of view, it is usually interpreted that any form of interest is forbidden. In the Islamic world, an alternative to debt finance should be the profit and loss principle, whereby banks issue equity-based instruments, such as *mudarabah* and *musharaka* (Gunn and Shackman, 2014). In this sense, the concept of profit and loss sharing is the main method utilized in Islamic banking system to comply with the prohibition of interest; it is a contractual agreement among two or more transaction parts, which allows them to bring together their resources to invest in a project to share in profit and loss (Dar and Presley, 2000). In particular, debt based on interest is not accepted according to the Islamic Index. For this reason, there is a threshold of debt to total assets (debt ratio); if the interest based on debt does not exceed this threshold then it can be allowed. The level of debt ratio must be lower than 33 per cent (Biancone and Radwan, 2016). In this sense, Derigs and Mazban (2008) point out that some research does not essentially call for Islamic firms to have a level of debt equal to zero but instead seek to define various financial ratio thresholds. The authors identify a range of 30-40 per cent to be a suitable maximum debt to equity ratio (or better a level of debt to total assets between 23-29 per cent). Islamic Financial Institutions have adopted other qualitative Shari’ah Compliant screening criteria around the world (FTSA Shari’ah Gkibak Equity Index):

- cash and interest bearing securities to total assets (interest ratio); the level of interest ratio must be lower than 33 per cent;
- cash and account receivable to total assets (liquidity ratio); the level of liquidity ratio must be lower than 50 per cent;
- not permissible income to total revenues (not permissible income); the income ineligible ratio must be lower than 5 per cent.

It is important to note that in the literature there are different ways of representing the above-mentioned quantitative criteria (e.g. S&P 500 Sahi'ah Index, Dow Jones Islamic Market Index, Morgan Stanley Capital International). There are also qualitative screening criteria that represent the classification of the business of each firm; in particular, companies must have their activities within the permitted activities and avoid those not permitted - which are referred as to Haram activities - (for example conventional financial service, alcohol, pork-related products, tobacco, gambling, some entertainment activities, pornography).

## RESEARCH METHODOLOGY

Using an exploratory research methodology, this study investigates the listed companies in the Indonesia Stock Exchange (IDX). This research is divided into two parts. In the first, we have identified within the IDX the listed companies *Shari'ah compliant* and *not Shari'ah compliant*. In the second, starting from the approach used by Wan Shazlinda and Wan Shahdila (2015), we used an empirical analysis (regression model) in order to highlights differences between the companies listed in the same Islamic stock market.

The companies considered are the 523 firms that make the Jakarta Stock Exchange Composite Index that, in the first part of our research, we have divided into ten macro-sectors: Basic Material, Communication Service, Consumer service, Consumer Good, Energy, Financial service, Industrial, Real estate, Technology and Healthcare. The listed companies in the Indonesian market have been split into *Shari'ah compliant* and *not Shari'ah compliant*, following the list of the firms that form the Indonesia Shari'ha Stock Index. These companies follow the Islamic law since their business is not connected with *haram* activities, for example the sale of alcoholic products, pork meat, porn industry, gamble industry and traditional financial-insurance services. The *ribà* is also a prohibition for the capital structure of the companies, which cannot be indebted through services by traditional finance. Few financial ratios have been established by the Islamic law with the aim to summarize and list the admissible situations and the forbidden from the *Shari'ah* rules about indebtedness. Some companies are excluded from this rule: firms with debt on average market capitalization from the past 12 months is equal or above of 33%; firms that the sum of the cash and securities on market capitalization is equal or more than 33%; finally, the companies which the credits into market capitalization are equal or more than 33%. All of these ratios have the aim to monitor the companies leverage since at the rising of it the companies automatically have a higher risk that is not allowed on the *Shari'ha* principles.

In the second part of our research, according to Wan Shazlinda and Wan Shahdila (2015)' approach, we have considered, for *Shari'ah* and *not Shari'ah Compliant* firms as dependent variables four performance



measures - ROE (Return on Equity), ROA (Return on Assets) and Market to Book Value (Market capitalization to Equity Book Value). As independent variables, we have considered three capital structure measures - the short-term debts, the medium-long-term debt, total debts - and two other variable (i.e. firm size and total asset). The timeline of reference is five years (from 2011 to 2015). The primary source of our research *Data Stream* from Reuters.

## EMPIRICAL EVIDENCE

In the first part of our study, we have divided the listed companies in *Shari'ah Compliant* and *not Shari'ah Compliant*. Of the 523 listed companies in the IDX, 306 are *Sharia'ah Compliant* (58,50%) and 217 are *not Sharia'ah Compliant* (41,50%). In addition, as discussed earlier, we have separated these companies into ten macro-sectors. The results in presented in the following table.

	Number of Shari'ah Compliant companies	Percentage of Shari'ah Compliant companies	Number of Not Shari'ah Compliant companies	Percentage of not Shari'ah Compliant companies
Basic materials	45	15%	24	11%
Communication service	4	1%	6	3%
Consumer service	61	20%	31	14%
Consumer goods	44	14%	25	12%
Energy	15	5%	8	4%
Financial service	9	3%	88	41%
Healthcare	13	4%	2	1%
Industrial	66	22%	23	11%
Real Estate	39	13%	3	1%
Technology	10	3%	7	3%
<b>Total</b>	<b>306</b>	<b>100%</b>	<b>217</b>	<b>100%</b>

Table 1. Listed companies *Shari'ah Compliant* and *not Shari'ah Compliant*

The sector with the largest number of *Shari'ah Compliant* companies is "Industrial" (22%), while in the case of *not Shari'ah Compliant* firms is "Financial Service" (41%).

In the second part of our study, with the aim to investigate the difference between the listed companies in Islamic market, in term of debts, firm size, total asset, ROE, ROA and the Market to Book Value, we have used the regression analysis to examine the data and to observe the possible correlation between those variable that were compared. In order to comment on the results obtained, we have taken into account an overall assessment of the results obtained over the years analyzed in the various sectors, divided into *Shari'ah* and *not Shari'ah compliant* companies.

Looking at the overall results obtained through the five-year extended regression analysis (2011 to 2015), there is a lack of influence by independent variables analyzed on selected performance indices. In general, no clear and significant relationship between the data was found in the sectors analyzed

(especially in those with a greater number of enterprises), and therefore the underlying hypothesis of this study was not demonstrated both in terms of *Shari'ah Compliant* companies and those *not Shari'ah Compliant*. The few areas where such importance has been reported are those where the number of businesses is low, such as the Healthcare, Real Estate, Technology and Communication Services sectors.

Below are the synthesis results obtained in the most numerous sectors. As far as the Basic Materials sector is concerned, debt variables, as well as those relating to total assets and size as total revenue, do not influence any significant performance estimate. It is only in the year 2015 that an increase of  $R^2$  is recorded with regard to the influence that short-term debt has on ROA. The same evidence is found for *Shari'ah Compliant* companies in this same industry, as proof that it is obviously not necessary to look for the underlying reason for this lack of relationship within the limits of the indebtedness of firms aligned with the dictates of Islam. In Consumer Goods sector both in *Shari'ah Compliant* and in *not Shari'ah Compliant* companies, the results of the regression analysis remain not sufficient to explain a true relationship. In Consumer Service sector emerges that independent variables have no significant influence on ROE, ROA and Market to Book value. For the companies classified as conforming to *Shari'ah*, the evidence found is the same as *not Shari'ah compliant* companies. However, it should be emphasized that the significance factor F is always very high in these linear regressions, so the data show variances that are not dissimilar to each other. In Energy sector both in *Shari'ah Compliant* and in *not Shari'ah Compliant companies*, the results of the regression analysis remain not sufficient to explain a true relationship. However, in the case of short-term debt related to ROA, the test F is near one, so optimal, but an  $R^2$  always close to zero that indicating the lack of relation between the quantities analyzed. Even in Financial Service sector, the results are confirmed in line with the previous ones, or even in this case the  $R^2$  close to zero. In Industrial sector, the test F is always close to one, proving that independent variables have a variance almost identical to that of dependent variables. In fact, the poor influence shown by the determination coefficient never exceeds 0.2.

The results of our research are largely in line with the evidences obtained in the paper that gave rise to this work. In particular, Wan Shahzinda and Wan Shahdila (2015) point out that short-term, medium-long-term and total debt do not influence the ROE and ROA of *Shari'ah compliant* companies as emerged in our study. Even in Malaysian construction companies, the  $R^2$  determinant coefficient is too weak to explain dependent variables by independent ones.

It can therefore be asserted that this finding is in line with the *Shari'ah*-based principle that firms cannot face excessive debt and must seek to be less risky compare to traditional ones. Not even the size (understood as total revenue) and the total assets seems to affect preferences regarding the capital structure of *Shari'ah compliant companies*, as Wan Shahzinda and Wan Shahdila (2015) also point out.

With reference to *not Shari'ah compliant* companies, also in the paper of Wan Shahzlinda and Wan Shahdila (2015) there is no significant impact on the debt to the Market to Book Value, suggesting that neither the debts nor the size or the total of the assets clearly explain that variable. It is in line with what emerged from this work, even the result in terms of the lack of a remarkable impact on total and medium to long-term debt on ROA. The obtained results in terms of the lack of significance of total assets related to all three dependent variables both for *Shari'ah compliant companies* and for *not Shari'ah companies* are in line with Wan Shahzlinda and Wan Shahdila (2015)'s evidences.

## DISCUSSION AND CONCLUSIONS

The empirical analysis suggests that for the companies observed the firms performance are not influenced by the variables investigated. Therefore, there are no significant differences between the listed companies analyzed, both *Shari'ha Compliant* and *not Shari'ha Compliant*, in the various sectors considered.

It is highlighted that the independent ones do not explain the dependent variables, because the  $R^2$  of this regression sign in the most of the cases values around zero. The industries that the determination coefficient is close to "one" are those of the Healthcare, Real estate, Technology and Communication Services to whom the sample of analysis is small. A result around "one" is statistical significant regarding the variables considered. This feedback, indeed, is relatively remarkable since the statistical analysis made on a small number of companies is cannot be considered explanatory and representative. The relevance of this work, that wants observe the impact of some variables on the evaluation of the firms' performance *Sharia'ah* and *not Shari'ha Compliant*, is strengthened by the size of the sample that has a high importance in order to provide an indicative and comparable result. In particular, as previously introduced, few studies in literature analyze, in an Islamic context, the relationship between capital structure and performance. In particular, the results of our research are in line with the results from other some studies that focus on the same aspects in different markets.

Wan Shahzlinda and Wan Shahdila (2015) based of a sample of Malaysian companies in construction sector, highlight that, the short debts, medium and long term and the totals debts do not affected the ROE and ROA of *Shari'ah compliant* companies, as there is no influence from the total assets and total revenues on the dependent variables. The companies *not Shari'ah compliant* report correlations coefficient equal as resulting in this study also in term of relevance of the debts on the ROA and the Market to Book Value.

Ebid (2009), based on a sample of non-financial Egyptian listed firms, shows that using three of accounting-based measures of financial performance (i.e. ROE, ROA and gross profit margin), the

results reveal that capital structure choice decision, in general terms, has a weak-to-no impact on firm's performance.

Sheikh and Wang (2013), based on a sample of non-financial firms in Pakistan, underline that all measure of capital structure (i.e. total debt ratio, long and short term debt ratio) are negatively related to ROA; furthermore, total debt ratio, long and short term debt ratio are negatively related to Market to Book Value. Only the short-term debt ratio is positively related to Market to Book Value but the relationship is found insignificant.

Finally, Salim and Yadav (2012), based on a sample of 237 Malaysian listed companies on the Bursa Malaysia Stock Exchange, show that firm performance, which is measured by ROA, ROE and earning per share (EPS) have negative relationship with short term debt, long term debt, total debt, as independent variable.

In the future, starting from the evidence obtained in this preliminary work, it could be interesting to understand why there are no differences between *Shari'ha* and *not Shari'ah Compliant* companies. It could also extend research to other Islamic markets or jointly consider the effects of multiple independent variables on performance measures.

## REFERENCES

- Abor, J. (2007), "Debt policy and performance of SMEs: Evidence form Ghanaian and South African firms", The Journal of Risk Finance, Vol.8 No.4, pp.364-379.
- Aggarwal, R. (1981) "International differences in capital structure norms: an empirical study of large European companies", Management International Review, Vol. 21 No.1, pp. 75-88.
- Ahmad, N. and Azhar, N.N. (2015), "Investigating of Shariah Compliant Companies Capital Structure Determinants", Advanced Science Letters, Vol. 21 No. 6, pp.1986-1989.
- Biancone, P.P and Radwan, M. (2016), "European Companies: evaluation for Sharia Compliance "opportunity and challenges"", European Journal of Islamic Finance, No. 5, pp. 1-8.
- Booth, L., Alvazian, V., Demircuc-Kunt, A. and Maksimovic, V. (2001), "Capital structures in developing countries", Journal of Finance, Vol. 56 No. 1, pp. 87-130.
- Brealey, R., Myers, S., Allen, F. and Sandri, S. (2015), *Principi di finanza aziendale*, McGraw-Hill, Milano.
- Bresciani S. and Ferraris, A. (2016), "Innovation-receiving subsidiaries and dual embeddedness: impact on business performance", Baltic Journal of Management, Vol. 11 No. 1, pp.108-130.
- Bresciani, S., Thrassou A. and Vrontis D. (2015), "Strategic R&D internationalisation in developing Asian countries - the Italian experience", World Review of Entrepreneurship, Management and Sustainable Development (WREMSD), Vol. 11 No. 2/3, pp. 200-2016.
- Chandra, T. (2015), "Analysis of factors affecting capital structure on listed company in Kompas 100 index", International Journal of Applied Business and Economic Research, Vol.13 No.9, pp. 7049-7066.
- Chandra, T. (2015), "The Determinants of the Capital Structure: Empirical Evidence from Indonesian Stock Exchange Companies", Revista KAMERA, Vol. 43 No. 2, pp.76-87.
- Damodaran, A. (2006), *Finanza aziendale*, Apogeo, Milano.
- Dar, H. and Presley, J., (2000) "Islamic Finance: A Western Perspective", International Journal of Islamic Financial Services, Vol.1 No.1, pp.1-9.
- Derigs, U. and Marzban, S. (2008), "Review and Analysis of current Shariah-compliant Equity Screening Practices", International Journal of Islamic and Middle Eastern Finance and Management, Vol. 1 No. 4, pp. 285-303.
- Ebid, I.E. (2009), "The impact of capital structure choice on firm Performance: empirical evidence from egypt", The Journal of Risk Finance, Vol.10 No. 5, pp. 477-487.

- Gleason, K.C., Mathur, L.K. and Mathur I. (2000), "The interrelationship between cultures, capital structure, and performance: Evidence from European retailers", *Journals of Business Research*, Vol.50 No.2, pp.185-91.
- Gunn, T. and Shackman, J. (2013), "A comparative analysis of the implications of the Islamic religion on corporate capital structures of firms in emerging market countries", *International Journal of Islamic and Middle Eastern Finance and Management*, Vol. 7 No. 3, pp. 277-287.
- Harris, M. and Raviv, A. (1991), "The theory of capital structure", *Journal of finance*, Vol. 46, pp. 297-355.
- Hassan, N., Shafi, R. and Mohamed, S. (2012), "The determinants of capital structure: evaluation between Shariah-compliant and conventional companies", *Proceedings of the International Conference on Innovation Management and Technology Research*, University Teknologi MARA, Selangor.
- Hoque, J., Hossain, A. and Hossain, K. (2014), "Impact of Capital Structure Policy On Value Of The Firm. A Study on Some Selected Corporate Manufacturing Firms under Dhaka Stock Exchange", *Ecoforum Journal*, Vol.3 No.2, pp.77-84.
- Hossain, M. I. and Hossain, M. A. (2015), "Determinants of Capital Structure and Testing of Theories: A Study on the Listed Manufacturing Companies in Bangladesh", *International Journal of Economics and Finance*, Vol.7 No.4, pp.176-190.
- Majumdar, S.K. and Chhibber, P. (1999), "Capital structure and performance: Evidence from a transition economy on an aspect of corporate governance", *Public Choice*, Vol. 98 No.3/4, pp.287-305.
- Miglietta, N. and Battisti, E. (2015) "A Comparative Study on Beta in Islamic Finance: Evidence from Malaysian Stock Exchange", *International Journal of Finance and Accounting*, Vol. 4 No. 6, pp.333-338.
- Miglietta, N. and Battisti, E. (2016), "Islamic and Traditional Corporate Finance: a Comparative Study on WACC", *European Journal of Islamic Finance*, Vol. 4, pp.1-9.
- Modigliani, F. and Miller, M.H. (1958), "The cost of capital, corporation finance and theory of investment". *The American Economic Review*, Vol. 48 No. 3, pp. 261-297.
- Omet, G. and Mashharawe, F. (2003), "The capital structure choice in tax contrasting environments: evidence from the Jordanian, Kuwaiti, Omani and Saudi corporate sectors", Working paper, The Hashemite University, Amman.
- Pinegar, J.M and Wilbricht, L. (1989), "What managers think of capital structure theory: a survey", *Finance Management*, Vol. 18 No. 4, pp.82-91.
- Pratheepkanth, P. (2011), "Capital Structure and Financial Performance: Evidence from Selected Business Companies in Colombo Stock Exchange Sri Lanka", *Journal of Arts, Science & Commerce*, Vol. II No. 2, pp. 171-183.
- Rajan, R. and Zingales, L. (1995), "What do we know about capital structure? Some evidence from international data", *The Journal of Finance*, Vol. 50 No. 5, pp. 1421-1460.
- Razah, N.H.A., Ahmad, R. and Aliahmed, H.J. (2008), "Government ownership and performance: an analysis of listed companies in Malaysia", *Corporate Ownership and Control*, Vol. 6 No. 2, pp. 434-442.
- Ross, S.A., Westerfield, R.W. and Jaffe, J.F. (1997), *Finanza Aziendale*, Il Mulino, Bologna.
- Salim, M. and Yadav, R. (2012), "Capital Structure and Firm Performance: Evidence from Malaysian Listed Companies", *Procedia - Social and Behavioral Sciences*, Vol. 65, pp. 156-166.
- Salvi, A. and Miglietta, N. (2014), *Principi di Finanza Islamica*, Cacucci Editore, Bari.
- San, O.T. and Heng, T.B. (2011), "Capital structure and Corporate Performance of Malaysian Construction Sector", *International Journal of Humanities and Social Science*, Vol. 1 No. 2, pp. 28-36.
- Sanusi Nur Azura, B.T. (2014), "The dynamics of capital structure in the presence of zakat and corporate tax", *International Journal of Islamic and Middle Eastern Finance and Management*, Vol. 7 No. 1, pp. 89-111.
- Sheikh, N.A. and Wang, Z. (2013), "The impact of capital structure on performance: An empirical study of non-financial listed firms in Pakistan", *International Journal of Commerce and Management*, Vol. 23 No. 4, pp.354-368.
- Tardivo, G., Schiesari, R. and Miglietta, N. (2012), *Corporate Finance*, Isedi, Torino.
- Wan Shahzinda, S.B.S. and Wan Shahdila, S.B.S. (2015), "Impact of Firm Leverage to Performance: Evidence from Shari'ah and Non-Shari'ah Compliant Companies in Malaysia", *First International Conference on Economics and Banking (ICEB)*, pp.140-148.
- Younus, S., Ishfaq, K., Usman, M. and Azeem, M. (2014) "Capital Structure and Financial Performance: Evidence from Sugar Industry in Karachi Stock Exchange Pakistan", *International Journal of Academic Research in Accounting, Finance and Management Sciences*, Vol.4 No.4, pp.272-279.

## ENTREPRENEURSHIP UNTAPPED: TESTING TRAINING FOR START-UPS BY PHD STEM GRADUATES

Mihai-Yiannaki, Simona<sup>1</sup>; Varnava-Marouchou, Despina<sup>2</sup>; Konis, Elmos<sup>2</sup>;

Hadjichristodoulou, Vassilia<sup>3</sup>

<sup>1</sup>Dept. of Accounting, Economics and Finance, European University Cyprus, Nicosia, Cyprus

<sup>2</sup>Dept. of Management and Marketing, European University Cyprus, Nicosia, Cyprus

<sup>3</sup>Dept. of Management, Cyprus International Institute of Management (CIIM), Nicosia, Cyprus

### ABSTRACT

This paper presents the preliminary results of a research study as part of: "SCIENT: A European University-Business Alliance aiming to foster young SCIENTists' ENTrepreneurial spirit" (SCIENT), an ERASMUS+, KA2 project that runs for 24 months until end of 2017 in seven European Union countries: Cyprus, Malta, Portugal, Lithuania, the UK, Spain and Italy.

The main aim of the project was to develop the transversal skills of Ph.D STEM graduates and to provide them with a new professional path based on entrepreneurial skills. The research shows the feedback responses from the training, internship and mentoring activities from participants, trainers, and guest speakers. As methodological tools, the results are based on a set of online surveys on 98 participants and 34 trainers from the seven participating countries.

The findings led to pertinent conclusions regarding the training programme content, organisational challenges, participant and trainer concerns and external practitioners' input.

It was immediately apparent that different countries, presenters, participants, facilities and scheduling provided varying impressions regarding the overall programme and specific training modules. There were, however, some wide-ranging agreements across countries and throughout all the programmes, which are presented in this paper.

*Keywords: entrepreneurship, start-ups, education, training, European project, Knowledge alliance, knowledge transfer, STEM education.*

### INTRODUCTION

This paper presents the preliminary results of a research study as part of: "SCIENT: A European University-Business Alliance aiming to foster young SCIENTists' ENTrepreneurial spirit" (SCIENT), an ERASMUS+, KA2 project that runs for 24 months until end of 2017 in seven European Union countries: Cyprus, Malta, Portugal, Lithuania, the U.K., Spain and Italy.

SCIENT's practical aim after a thorough research on E.U. countries gap on STEM entrepreneurial needs and skills, is to develop an innovative Pan-European entrepreneurship program for PhD STEM students/graduates. Since scientific knowledge lies at the heart of the European knowledge economy, SCIENT focuses in developing successful scientific entrepreneurs by fine-tuning their transversal skills and providing them with a new professional path.

This study aimed to identify both similarities and differences in terms of training content, participants, trainers and guest speakers, amongst the participating countries.

The ultimate goal of the research was to make doctoral students and graduates aware of their career options and about the possibility of using their research findings to start their own company, exploiting their opportunities beyond an academic/researcher career.

The present paper reports and presents the data obtained through an online survey from the students who have participated in a pilot training course during 2016, designed specifically for the STEM PhD students and graduates.

## LITERATURE REVIEW

Previous research on entrepreneurship education specifically for STEM has been very sparse, (Boocock and Frank. 2008). Although, there have being some useful contributions that have indicated substantial difference in practice, both, between different STEM programs, different European countries and institutions within them. In a field where an official interpretation has been absent, there is a particular difficulty for all stakeholders involved in reaching a common understanding. In this literature review, therefore, an attempt is made to iron out some of these differences and also similarities by first establishing how entrepreneurship education is understood and defined and thus recognize and acknowledge the different approaches to it.

For example, much Entrepreneurship Education (EE) literature discussed the trend of the increasing number of EE programmes in universities, but also teaching associated to boosting creativity (Mihai Yiannaki, 2011; 2012) and knowledge transfer, a major factor in supporting entrepreneurship. Where others have moved the focus towards the actual process and content of EE programmes (Vesper & Gartner, 1997). Furthermore, more current works investigate the course content (Shepherd, 2004). Each of these authors, are making a serious attempt to merge practice and actual observation of what entrepreneurs do and how they learn.

Taking into consideration that the European Parliament, in (2006) recommended that 'entrepreneurship' should be one of the eight key competences for Lifelong Learning the understanding of the role of entrepreneurship education particularly for STEM is very important as it has a lasting impact on the student learning outcomes.

In the literature there have being many attempts to identify the key obstacles of STEM entrepreneurship education. It is important to review the entrepreneurship obstacles in order to identify them and create measures to overcome them.

Such obstacles are summarized as: lack of finance (Schoof, 2006; Atieno, 2009), unawareness of the availability of government programs specifically designed to support STEM students and help them in launching their new venture (Maas and Herrington, 2006) and lack of training reducing the managerial and entrepreneurial ability (Orford et al., 2003). Shortages of education is another barrier (Schoof, 2006). Furthermore, there is lack of an integrated approach to policy in this field of study, which also leads to the absence of regular and robust tools for strategic orientation and assessment as well as a lack of replicability (Schoof, 2006).

What's more scientist often lack the ability to spot business opportunities and develop products that meet customer needs even though they can often explain the general applications of new technologies (Markham et al, 2002). Besides STEM has to move away from the long standing functional approach to business education to one that also embraces specific skills specially designed for STEM students

In summary, however Baumol (2005) emphasizes the current view on STEM when he states that the linkages between education, innovation and entrepreneurship are still not well understood.

## **METHODOLOGY**

Methodology wise, the study used online surveys for both participants and the trainers, that included open questions for obtaining qualitative feedback, closed questions for statistics purpose, but also a Likert scale for several questions. The set of questions were developed following literature review findings, partner's experience in the field of training, and brainstorming techniques during the consortium meetings.

For the participants the areas covered by the survey were: Country of Training, Age Group of Participants, Academic Background, Information about the Project obtained through, Prior Experience, Motivation for Training, Quality Dimensions, Interactivity and Engagement, Learning about Company Practices, Usefulness of Programme Topics, Comprehensiveness of Programme, Relative Appreciation of Individual Modules, Appreciation of Individual Programme Elements and Suggestions for Changes, Perceived Effects of Participation, Overall Testimonials by Participants.

The Qualitative questions for the participants were:

1. Decision Why did you decide to participate to this training?
2. Which part of the training did you like the most? Please explain.
3. Which part of the training did you like the most?



4. What would like to add to the present training programme?
5. What would like to change to the present training programme?
6. If this programme was structured differently, in terms of duration, training days/times, full time or part time, online or face-to-face, what suggestions would you make?
7. In which training topics/areas would you like to receive further training?
8. Which entrepreneurial skills do you feel you need to develop further?
9. Testimonials

For the trainers the areas covered by the survey were: Country of Training, Prior Experience of Trainers, Perception of Student's Interest, Quality Dimension Choice of Topics, Quality Dimension Coverage of Essentials of Entrepreneurship, Appreciation of Merits of Individual Modules, Verbal Assessment of the Programme, Quality Dimension Mix of Theory and Practice, Support for Business Creation, Perception of student's Reaction to the Programme and Perceived Effects, Overall Assessment.

The Qualitative questions for the trainers were:

1. Do you have experience with organizing similar trainings? If yes, which ones? Please explain.
2. Which part of the training material (including the exercises) did you like the most? Please explain.
3. What would you like to add to the present training programme?
4. What would you like to add to the present training programme?
5. What would you like to remove/change to the present training programme?
6. Suggestions if this programme could be structured differently, in terms of duration, training days/times, full time or part time, online or face-to-face, what suggestions would you make?
7. In which training topics/areas would you like to receive further information/material/additional support to develop your training better?
8. Please describe the participants' reaction in a few words (enthusiastic, motivated, bored, passive etc.)
9. Effects What were the main effects that you identified on students during the course implementation?
10. Suggestions & Comments for the training as a whole.

Based on the answers obtained from the respondents, an analysis was performed in identifying the common findings and drawing relevant conclusions on the training performed.

Once the participants completed the theoretical (class) part of SCIENT Entrepreneurship Programme, they had the opportunity to participate in an internship activity working in interdisciplinary teams alongside other research students and under the guidance of academic faculty, employers/managers, investors and entrepreneurs. 10 pilot participants from each country visited companies within their own country and another 10 visited companies abroad. Specific instructions and guidance for all these stages have been provided in the train the trainers' handbook developed as part of the SCIENT Entrepreneurship Programme. All partners provided a list with key words of the research topic of each participant and they sent those lists among themselves, to find the most suitable company for each person. SPS from Germany was the partner responsible for the organisation of the Internship Activity for all partner countries.

Once the internship activity was completed, the hosting company and the intern had to complete an online evaluation questionnaire, giving feedback about the internship experience and suggesting ways of improvement. The questionnaire for the survey was developed by ISOB with the valuable contribution of GrantXpert, Fundeun and EUC. The survey was hosted on the Lime Survey based online-survey system run by ISOB.

On the Internship survey, the directions of analysis sought were: Country of Internship vs. Country of Origin, Experience in Prior Internships, Expectations before the Internship, Quality Dimension Meeting Student's Expectations, Satisfaction Quality Dimensions of Project, Own Achievements, Most Important Positive Aspects, Suggestions for Improvement, Future Contact with Host Company, and Testimonials.

Last, but not least, on the mentorship survey, the directions of analysis were related to the degree of advancement in the business creation and product prototype, besides filling the gaps of the in-class and internship training.

Overall the findings are presented in synthesis in the following part, in a way that combines both quantitative and qualitative results.

## **RESEARCH FINDINGS**

The research findings are clustered in participants, trainers, internship and mentorship results.

### *Participants results*

A preliminary analysis of the main findings regarding 98 of the participants that took part in the pilot training program are outlined below.

The participants' ages ranged from 35 years old and younger, which is typical for PhD and graduate students. In fact, 78% were 35 or younger, while also some more experienced graduates took part in the trainings. For example, Cyprus and Portugal attracted a significant group of younger participants, while all participants in Italy belonged to the 25/35 group.

Almost 2/3 of the participants either had a PhD or were PhD candidates. Three quarters of the participants had no prior experience with similar programs,

The survey examined the following indicators in terms of quality and intensity of the training delivery: the motivation of the participants for their participation in the training program, the interactivity and engagement of the program, the usefulness of the program, the comprehensiveness of the content, which part of the program was more valuable. Also suggestions were made as to what other topics should be added for such training program.

Developing entrepreneurial competences was the main motivator for participation in the pilot training. Some of the participants intended at obtaining primarily knowledge, while others had already a business idea and were looking for ways to implement it in practice. Another reason was the possibility of networking and finding possible investors were also important motivators.

Interactivity and engagement was also used as an indicator of the quality of the program. Almost 70% of the participants agreed strongly that the program was both interactive and engaging with Cyprus, Spain and in the UK scoring the highest score.

Almost 60% of participants strongly agreed that the course managed to familiarize the students with actual practices of real companies. Again, Cyprus, Spain and the UK scored the highest score in this section.

Three quarters of the participants found the actual topics chosen for the program to be very valuable while an additional 23,5% found them to be somewhat valuable. Only one participant did not find the topics valuable. Furthermore, almost 4 out of 10 participants felt that the content was comprehensive in the sense that all fundamentals were covered. The program attained a high level of quality throughout the program. All of the individual modules are rated on a level of 8 or 9 out of 10, without much significant differentiation between them.

Students were also asked for their opinion of which parts of the program were the most valuable for them. A broad range of topics were mentioned. The topics that students found most valuable, in order of preference, were Business Model Canvas/Business Modelling, Pitching and Guest Speakers with, Group Dynamic.

Asked which components should be added, a broad range of suggestions were made amongst them were: to have more guest speakers, more practicing of pitching, organizing an additional summer school, direct contact with investors and more time allocation for the program.

When participants were asked of suggestions for the improvement of the program the vast majority of them did not suggest any changes. However, those who make suggestion for included more time to practice and shorter sessions over a longer duration.

Almost half of the participants were inspired by the training to start their own business. For around 10% of students the training helped them to clarify that they do not want to start their own business. Again, the level of impact on the participants was the highest in Cyprus, Spain and the UK.

The preliminary conclusions' on participants' feedback on the training can be outlined as follows:

- The program was well received by the overall majority of the participants.
- Students evaluated the program as useful, comprehensive, interactive and engaging. All modules included in the program received more than 8 out of 10 points.
- Some of the suggestions made by the students included the involvement of more business quest speakers, allocate more time for pitching skills, shorter modules over a longer time.
- Almost half of the participants were inspired by the training to start their own business.

#### *Trainers results*

A pool of 48 trainers took part in the training, of which 71%, respectively 34 responded to the online survey, who agreed on above 80% average that the training material is ready for implementation, with several changes suggested. Their experience ranges from professional qualifications training, academic and business and start up incubators' training, besides being themselves entrepreneurs.

The major concern emerging from this survey was if the training material is enough developed to continue the training of future STEM entrepreneurs. The findings were positive, as shown in the following table:

Do you think the training material developed is ready for implementation and dissemination?								Total
	Cyprus	Italy	Lithuania	Malta	Portugal	Spain	United Kingdom	
Yes	4 36,4%	1 20,0%	0 0,0%	1 33,3%	4 57,1%	3 100,0%	0 0,0%	13 38,2%
Rather yes than no	5 45,5%	2 40,0%	0 0,0%	1 33,3%	3 42,9%	0 0,0%	1 25,0%	12 35,3%
Rather no than yes	2 18,2%	2 40,0%	1 100,0%	1 33,3%	0 0,0%	0 0,0%	2 50,0%	8 23,5%
No	0 0,0%	0 0,0%	0 0,0%	0 0,0%	0 0,0%	0 0,0%	1 25,0%	1 2,9%
Total respondents numbers and %	11 100,0%	5 100,0%	1 100,0%	3 100,0%	7 100,0%	3 100,0%	4 100,0%	34 100,0%

Table 9. Answers to question: Do you think the training material developed is ready for implementation and dissemination?

The preliminary conclusions' on trainers' feedback on the training can be outlined as follows:

- The trainers affirmed the merit of the programme by more than 75% in all of the quality dimensions covered, according to the internal evaluation indicator system.
- The mostly quite experienced trainers assess the program as useful, comprehensive, motivating and engaging, while the programme was well received by the trainers who delivered it.
- No clear weaknesses or points for improvement stand out in the sense that they were mentioned by a majority of trainers. However, a minority of trainers claims that the programme as a whole should be "fine-tuned" concerning the technical aspects of the training material and a number of elements that should be expanded, as the involvement of business practitioners, time for practicing and training in pitching skills.
- Suggestions for alternative structuring of the program (some suggest to use shorter modules over a longer period, while others appreciate the compact format) show that delivering the course in various formats could further increase the outreach.
- It is recommended that options for improvement should be discussed in each national pilot testing evaluation programme and that the synthesis pilot evaluation report should suggest a list of common points for final fine-tuning which should be discussed by the partnership as a whole.

The training material suggested in 12 modules indicated in general a good blend of theory and practice and appropriation, with over 70% interesting material and structure.

Obviously, several challenges in instructing regarded teaching slides produced by others, duration of the course in terms of keeping the participants engaged all through the day, here suggestions were offered for a lengthier program, adapt the knowledge to their mindsets, give opportunity to expand their knowledge, demonstrate relevance of personal attributes in startups, obtain feedback and engagement. The perception of the trainers about the participants was that they were very enthusiastic, motivated, passionate and interested about the training, in a context of a comprehensive and dynamic training course, where participants had the opportunity to open their mind towards being able to start a business and improve skills in a professional way in order to become entrepreneurs.

#### *Internship Results*

The internships were perceived positively by the majority of the participants and the hosting companies. Both mentioned that the overall quality of the internships has fulfilled the target values set

in the evaluation concept and they highlighted that they will stay in touch after the end of the project. Participants mentioned that they had the opportunity to develop further their networking skills and be exposed on foreign business cultures having insights in new technologies. Hosting companies highlighted their readiness to assist and mentor promising young graduates as well as networking and expanding their company's network. While the duration of the internships has been limited, many of those companies who made suggestions for future internships stated that longer internships and a more detailed structure could further enhance the value for both company and intern. It can be concluded that the internships have been implemented with success at this point from the perspective of the hosting companies and interns.

In general, through the internship period the participants had the opportunity to discuss and develop further their ideas, to network, to meet other people having the same interest with them, to develop their skills and their knowledge. The organisation of the internships for the participants was the most challenging activity of the whole project as the majority of the PhD students and graduates were facing difficulties to participate in this activity either at local level or at EU level. It was really difficult for them to dedicate time from their studies or from their work for an internship activity.

#### *Mentoring Results*

Each country conducted the mentoring activity more or less in its own way, with either the trainers of the course or with outside dedicated business people, each team benefiting of its own mentor or team of mentors.

One of the major challenge was to keep the mentees interested, despite a tight working schedule, while another was to deliver the actual business case via a final pitching.

The topics covered were in a way a review of the training material in the course, but filling in the gaps, especially related to the soft skills, business canvas, the pitching training, the marketing and commercialization part, the company registration and IPR, and the financial skills, while some even simulated the business case competition.

Despite the described idea generation and refinement efforts, it seemed most students didn't progress to a degree of readiness for commercialization. They were either entrenched in their ideas, or remained too far away from ideas they could trust to take to market. However, several groups considered seriously starting a company and presented in the Local competition and then at the European level competition, which is to be held in September 2017 in Cyprus.

Gaps from the in-class and internship training were filled to a good degree, i.e. more was done on marketing, more on idea generation, actual brainstorming, company registration steps and documentation, IPR, more on finding investors.

The main challenge was keeping participants enthusiastic and participative and to attend the regular mentoring hours.

## CONCLUSIONS

The programme was very well received by the participants and this is an important conclusion in itself, as it reveals that there is indeed an untapped high quality entrepreneurial resource in PhD STEM students and graduates. Although many of these individuals had little knowledge of business matters, they appreciated its usefulness and the opportunities it provides. The participants affirmed the merit of the programme in all of the dimensions covered. Indicatively, participants assessed it as useful, comprehensive, interactive and engaging. All individual programme modules received evaluations of more than 8 out of 10 points in all countries.

The qualitative element of this project (verbal comments in free format) validated the positive quantitative ratings. There were just a few clear points for improvement, however there were a number of suggestions that some elements should be expanded in order to further the involvement of business practitioners, and to provide time for practicing and training in pitching skills. Suggestions for alternative structuring of the programme (some suggested using shorter modules over a longer period, while others appreciate the compact format) show that delivering the course in various *customised formats* could further increase the outreach.

Other general conclusions included:

- The best way to attract participation is through a blitz of communication techniques, including social media and traditional means. Moreover, contacting key influencers (e.g. professors, Deans) helps as well. Most important is personal communication with candidates.
- Scheduling and other organisational details (e.g. breaks, duration of each session etc.) must be *customised*, according to the audience's preferences.
- The strengths of the trainers, guest speakers and the participants must be taken into consideration and utilised in the whole process.
- Local variations (e.g. specific industrial emphases) must not be ignored. In fact they should be used to strengthen the training programmes.
- The stage of development of participants' business ideas is very important and ideally similar; however, training, as it has been structured, can actually combine varying entry level development stages. Nonetheless, the resultant final outcome (i.e. how far each individual's or group's idea has progressed) will be affected.
- Group work should be encouraged further.

- The theory-practice combination is very important. Generally, students prefer the hands-on this-is-how-it's-done approach.
- Though mentoring and internships are key, it is a challenge to arrange scheduling and to find participating companies and individuals. Possibly the best way to approach this is to find tangible benefits for both sides. The team also concluded that internships, due to regulations, even legalities, need to be separate from such programmes. Mentoring should be embodied *within* the training sessions, even though there is an argument that mentoring needs to follow an incubation period, during which participants can better absorb taught material.
- A key objective must be to coordinate the theoretical class with the practical one and the visit of the guest speaker. This way, they all had a major impact in the attendees' comprehension of the project. But this is not always easy.
- The pitching unit needs a more solid foundation, with training in marketing, promotional and selling skills.
- PhD students in non-business areas can get excited about entrepreneurial projects, given the right training.
- Given the amount and diversity of new material, it is a challenge for the participants to absorb and then assimilate it all. Ideally, there should be an incubation period somewhere within the course.
- All modules should have the feel of workshops, with a very real result at the end.
- More incentives, or tangible benefits, are required to ensure an increase in registration demand. A learner's contract of some sort is necessary, to ensure participation throughout. A certificate of participation is, of course, also necessary.

A final key conclusion was the need for close integration between industry and academia. Trainers and guest speakers from the field of entrepreneurship need to work together to plan and carry out the best learning experience for the participants.

## REFERENCES

- Baumol, W. J., (2005), 'Education for innovation: entrepreneurial breakthroughs versus corporate incremental improvements' NBER Innovation Policy and the Economy, Vol. 5. Bi 1 pp 33-58.
- Boocock, G., and Frank, R., (2006). Technology evaluation and commercialization at Loughborough University, Proceedings of Internationalizing Entrepreneurship Education and Training Conference, Sao Paulo.
- Maas, G. and Herrington, M. (2006),! e Global Entrepreneurship Monitor. (GEM) South African Report, Global Entrepreneurship Monitor.
- Markham, S. K., Kingon, A. I., Lewis R. J., and Zapada, M (2002). 'The university's role in creating radically new products', International Journal of Technology Transfer and Commercialisation, Vol 1. pp.163-172.
- Mihai Yiannaki, S. (2012) "Creativity in business schools- post financial crisis implications", International Journal of Organizational Analysis, Vol. 20 (2).



- Mihai Yiannaki, S. (2011) MANAGING CHANGE: THE PRIVATE UNIVERSITY SECTOR IN CYPRUS, OPERATIONS WITHIN THE EUROPEAN CONTEXT. A CASE STUDY. *Lex et scientia* XVIII(1): pp.191-207 · August 2011.
- Orford, J., Herrington, M. and Wood, E. (2003), *Global Entrepreneurship Monitor, South African Report, GEM*, [http://www.gsb.uct.ac.za/\\$les/GEM2004.pdf](http://www.gsb.uct.ac.za/$les/GEM2004.pdf).
- Schoof, U. (2006), *Stimulating Youth Entrepreneurship: Barriers and Incentives to Enterprise Start-Ups by Young People*, ILO, Geneva, International Labour
- Shepherd, D. A. (2004). Educating Entrepreneurship Students About Emotion and Learning From Failure. *Academy of Management Learning & Education*, 3(3), pp. 274 –287.
- Vesper, K. H., & Gartner, W. B. (1997). Measuring progress in entrepreneurship education. *Journal of Business Venturing*, 12, pp.403–421.

## LOCAL LIABILITIES AND INTERACTION BETWEEN NATIVE AND IMMIGRANT FIRMS

Milanesi, Matilde; Guercini, Simone

Department of Economics and Management, University of Florence, Florence, Italy

### ABSTRACT

The aim of the paper is to analyze the interaction between native and immigrant firms in local systems focusing on the case of Chinese immigrant firms as a business community settled in a specific territory, that of an Italian industrial district. The coexistence of native and immigrant entrepreneurship may represent a fertile ground for the emergence of liabilities, namely the liability of outsidership, defined as the difficulties that must be addressed by those who are external to the most effective and important international networks, distinguishing outsiders from insider actors (Johanson and Vahlne, 2009; Schweizer, 2013).

The paper proposes a twofold perspective: on one hand, immigrant Chinese firms, despite being insider to global networks, can perceive a liability of outsidership in the local network; on the other hand, native entrepreneurs can perceive a liability of outsidership in the global network in which immigrant entrepreneurs are embedded. Interacting in business networks can offer an important perspective to explain the possible exploitation of opportunities as a result of interacting and facing local liabilities.

The paper adopts a qualitative methodology proposing a case study approach in which the empirical setting is represented by an Italian industrial district that has experienced huge immigration flows and the establishment of a large Chinese community of people and companies active in the textile industry. The study allows the authors to highlight the liabilities that may emerge locally, where a transnational oriented business network established by Chinese immigrants and local business networks established by native entrepreneurs coexist.

*Keywords: Liabilities, interaction, network, outsidership, immigrant entrepreneurship, Chinese, industrial districts*

### INTRODUCTION

Industrial districts (IDs) have remained a focus of the economic debate in Italy and still play a central role in the Italian industrial system, although it is evident that they are suffering under the pressure of globalization. An emerging strand of literature is looking at whether industrial districts are in fact

reacting to the new challenges of globalization and investigating the directions in which they are evolving within today's rapidly changing international context. Challenges that IDs are facing today are due to several factors such as globalization and its effects on the firm population of IDs and their fabric of inter-organizational relationships, the emergence of a multi-ethnic society within the local manufacturing area as a result of the phenomenon of worker immigration, the sociocultural discontinuity induced by generational turnover, and greater industry heterogeneity within the production structure of the local territories (De Marchi & Grandinetti, 2014). The workforce in industrial districts became increasingly multi-ethnic and heterogeneous from one district to another. The textile district in Prato, Tuscany, represents a particular case (Dei Ottati, 2009): alongside the original district, a second one has developed consisting of businesses founded by Chinese immigrants, and there are no connections worthy of note between the two districts, or sub-districts. Prato is specialized in textile production and is characterized by a production model based on small businesses with a strong division of work processes: in brief, the Prato industrial district has long been a workhorse of the Italian fashion industry.

Anyone who visits the industrial district of Prato today will however come face to face with a substantial number of Chinese owned companies. When the first immigrant workers arrived in Prato from the eastern province of Zhejiang in the early 1990s, they represented a tiny exception to the district's overwhelmingly Italian population: some hundreds of people vs. the almost 50,000 already engaged in various textile-related activities throughout the area. In 2015, the Prato Chamber of Commerce registered more than 4.000 Chinese-owned companies, that represent more than 50% of companies in textile and clothing activities based in the district. Thus, the industrial district of Prato sees the coexistence of native and immigrant firms, the latter forming a "parallel district" and the integration and interaction between the two communities are still far from a satisfactory level.

Within this framework, the paper focuses on the interaction, where this exists, between native and immigrant firms, based on the case of Chinese immigrant firms as a business community settled in a specific territory, that of the Italian industrial district of Prato in which native and immigrant entrepreneurs coexist. Such coexistence may generate liabilities, namely foreignness and outsidership, concepts borrowed from the literature of management and international business and defined as the difficulties that must be addressed by those who are external to the most effective and important international networks, distinguishing outsiders from insider actors (Johanson & Vahlne, 2009; Schweizer, 2013). In cases like that of Prato immigrant entrepreneurs can perceive a liability of outsidership in the local networks, but at the same time are insider to global networks dominant in specific industries and markets. Native culture entrepreneurs can experience a relative outsidership, and suffer from elements attributable to foreignness, with reference to the new global networks

dominated by the immigrant entrepreneurs settled in the same territory. In other words, in the paper it is discussed that when two communities of persons and companies coexist within the same context, liabilities such as foreignness and outsidership are produced locally by the forces of globalization. The interaction approach (Håkansson *et al.*, 2009), can offer an important perspective to explain the possible exploitation of opportunities as a result of interacting and facing local liabilities.

The paper employs a qualitative methodology, that of case study, analysing the case of a family business founded in 1987, in Prato, focused upon womenswear manufacturing and able to produce up to 500.000 items per year. Such company can be considered a virtuous case of interaction with locally settled immigrant firms, mainly Chinese suppliers of manufacturing activities. The case analysis shows that facing (and possibly overcoming) liabilities in interactions between companies embedded into a local context can boost the development of new combinations of local and transnational business relationships; the interactive perspective adopted in the paper highlights that opportunities, and liabilities, stem from the creation of interactions among migrants and natives actors with specific resources combinations and activity structures at a local and transnational level.

## **THEORETICAL BACKGROUND**

Liability of foreignness and liability of outsidership are concepts that originate from the literature of management and international business. Much attention has been given to the liability of foreignness (Johansson & Vahlne, 1977; Zaheer, 1995), defined as as costs of doing business abroad (Hymer, 1976), in the sense that foreign firms incur additional costs when operating internationally, compared to local firms that have better information about their country, economy, laws, culture, politics etc.. More recently the literature of international business has stressed the growing importance of the liability of outsidership (Johansson & Valhne 2009) from business networks in internationalization, defined as the difficulties that must be addressed by those who are external to the most effective and important (social and business) international networks, distinguishing outsiders by insiders actors. There can be a liability of outsidership both in the internationalization process of the firm and in the domestic market in the presence of problems of information constraints and uncertainties regarding network developments and opportunities that emerge in networks and business relationships (Hilmersson,

2013). The liability of outsidership (LOO) is a situation when a firm enters a business environment without knowing who the business actors are, or how they are related to each other.

While liability of foreignness can be broadly defined to include all additional costs for the foreign entrant, such costs can be distinguished into two types (Calhoun, 2002): costs that may be easily identified and quantified and costs that may not be as easily identified. The majority of the work on liability of foreignness has focused on the former, while only few papers have focused on culturally driven aspects of the liability of foreignness. The question becomes how cultural differences manifest and impact on foreign firms differently from native firms and differently in the several countries in which the foreign firm is operating. The attention given to the less identifiable sources of liability of foreignness generally refers to the fact that firms enter countries that are culturally similar as measured by concepts such as psychic distance or institutional distance. Johanson and Vahlne (2009) maintain that the larger the psychic distance - defined as factors, such as language and culture, that make it difficult to understand foreign environments – the larger is the liability of foreignness. And the larger the psychic distance, the more difficult it is to build new relationships, thus there can be a liability of outsidership as an effect of the liability of foreignness.

In other words, foreignness and outsidership show the role of culture and cultural differences in building new relationships and knowing who the business actors are, or how they are related to each other, with consequences on the development of business opportunities. When discussing the Industrial Marketing and Purchasing (IMP) paradigm on interaction, relationships and networks, (Håkansson, 1982; Ford, 1997; Håkansson *et al.*, 2009), Fang and Kriz (2000) argue that if the focus is on relationships and interaction, the reality is that culture always exists in the background through its fundamental impact on the behavior of people who are at the center of business relationships, and “[...] no account of business relationship is complete if culture is not sufficiently studied” (Fang & Kriz, 2000, p.3). Research focusing on the importance of culture in managing cross-cultural business relationships within the IMP Group is relatively limited (see Fang & Kriz 2000; Amelingmeyer & Moehringer 2002; Lowe *et al.*, 2002).

When dealing with the Chinese culture – which views concepts such as connections i.e. *guanxi* and connected networks i.e. *guanxiwang* as key success factors for business - many Western managers are still failing to manage business relationships in the Chinese-culture dominated markets (Björkman & Kock, 1995; Itthipassagul & Blois, 2000), and intercultural differences have been identified as one of the main reasons of failure in business relationships with Chinese companies (Ghauri & Fang, 2001; Battaglia *et al.*, 2004).

Following this line of reasoning, when two communities of persons and companies coexist within the same context, such as the above mentioned area of Prato, the result is a cross-cultural business setting

where culture has an impact on the formation, success/failure of business relationships and on interaction processes among native and immigrant firms. A cross-cultural business setting thus becomes relevant object of research on liabilities, namely foreignness and outsidership, when immigrant entrepreneurs can perceive a liability of outsidership in the local networks, and native culture entrepreneurs can experience a relative outsidership, and suffer from elements attributable to foreignness, with reference to the new global networks dominated by the immigrant entrepreneurs settled in the same territory. Interacting in business networks, according to the IMP approach (Håkansson *et al.*, 2009), can offer an important perspective to explain the possible exploitation of opportunities as a result of interacting and facing local liabilities. Following this line of reasoning, the paper addresses the following research question: *what are the liabilities emerging locally from a cross-cultural business setting and how are they related to interaction among business actors?*

## METHODOLOGY

Our objective is to apply a case-study method in order to analyze in depth liabilities in relation to interaction between native and immigrant firms settled in a specific territory. Recent literature in management research has stressed the importance of case research to generate and test theory (Eisenhardt & Graebner, 2007). Case studies can be useful when investigating a specific phenomenon and there is a need to better understand processes (Easton, 2010); we selected the case study for the learning potential it offers and the approach at this level is mainly descriptive and interpretative and in this sense we include some parts of the systematic combining process (Dubois and Gadde, 2002).

In particular, we present a single case study of a manufacturer located in the Prato textile district: Alpha, which was followed over the last four years. The case is the result of data collected mainly through interviews, supplemented by preliminary case study data (documents and records collected in the same period). The paper presents the findings emerging from semi-structured interviews organized in order to collect a large amount and variety of information on interaction between a native firm, Alpha, and immigrant firms, more specifically Chinese-owned companies settled in Prato from the beginning of the 90s. In a preliminary step, we analysed data collected from interviews with local textile associations representatives conducted by the authors in 2016 to ensure a more fine-grained analysis of the issues addressed. In particular, the Director and a manager from the local CNA (National Confederation of Crafts and Small and Medium Sized Enterprises) were interviewed as expert informants since their efforts over the years in studying Chinese entrepreneurship in the textile district and facilitating integration and the development of business relationships between Chinese and native firms. The interview lasted 2 hours and was recorded and transcribed.

The study of Alpha started in 2012 with two semi-structured interviews with the CEO, a third interview was done in 2016 with the CEO, after the suggestions that we were given by the Director of CNA, as Alpha is considered in the textile district a case of virtuous interaction with Chinese companies. Secondary data from the company annual report and website, and other documents, such as press articles, textile association literature/records, and so forth, were also collected to ensure data robustness and triangulation.

## EMPIRICAL CONTEXT

The presence of Chinese immigrant firms in the industrial district of Prato is only the most visible component of a more complex phenomenon that has affected many Italian industrial districts in the late '80s and in the '90s, with migration flows from many different countries, but with relevant specific aspects of entrepreneurship when these flows have been from China. The area of Prato has therefore experienced this phenomenon since the late '80s, when Chinese migrants began arriving in the district giving rise to the birth of Chinese firms specialized mainly in goods typical of the fashion industry (knitwear, garments, leather products), with typical positions of sub-contractor. In an area, that of Prato, specialized in textile manufacturing – yarns and fabrics – Chinese immigrant firms focused on the apparel sector operating as subcontractors and garment makers (Guercini 2002; Milanesi *et al.* 2016).

Chinese migrants have resulted in the start up of new firms, typically Small and Medium sized Enterprise (SME), with specific characteristics of family business, entrepreneurial and self-employment dynamics. The Chinese working capability, mainly in the field of sewing, and generally as garment maker, has been an essential element in the development of ready-to-wear apparel, especially fast fashion for women, in the context of what had been until then a traditional wool textile district. The characteristics of Chinese immigrants, their manufacturing skills, the propensity to develop their own independent business, flexible and cheap access to workforce through family and community relations, were compatible with the characteristics and needs of the industrial district.

This situation of coexistence of Chinese and native firms within the same territory has resulted in the creation of a “parallel district” and the integration and interaction between the two communities are still far from a satisfactory level. Reasons are twofold. On one hand, many Chinese immigrant firms still operate under conditions of illegality (clandestine work, tax evasion to cite few), that led native entrepreneurs to have attitudes of discrimination and lack of trust. On the other hand, some typical cultural traits of Chinese entrepreneurship, profit-oriented in the short term, and generally suspicious of members not belonging to the community of origin, have disadvantaged the creation of long-lasting

and stable relationships with native firms. Moreover, most Chinese immigrant firms import fabrics from abroad (China and Turkey for example) and don't rely on local producers.

Despite these difficulties, the case of Prato is different from that of other Italian fashion districts, since only in the Tuscan city at a later stage the condition of subcontractor of Chinese immigrant firms is exceeded and there is the development of manufacturing firms operating as "final" firms, which integrate design and have, as direct customers, other firms that control distribution channels and brands. This evolution concerns only a minority of Chinese immigrant firms, most of which continues to work as subcontractor for other Chinese garment makers or other Italian companies located outside the area of Prato.

## CASE DESCRIPTION

Alpha is a family business, founded in 1987, in Prato, Tuscany. It is surrounded by a number of highly specialised companies dealing with the whole fashion design and production process. The company is focused upon womenswear manufacturing and it is able to produce up to 500.000 items per year. The high level of manufacturing standards and quality control are pillars to the company aiming to lift the quality control system up to 100% of items. The supply chain policy guarantees the full Made in Italy (from fabrics to craftsmanship).

In 1987, the year of its foundation, Alpha worked as a wholesaler in womenswear. Aware on one hand of the next crisis of wholesalers in fashion, and on the other hand on the potential of investments in retail, the company started to open in a few years six stores, supported by the production of garments in house. In the early 2000s Alpha decided to focus primarily on manufacturing activities and in 2005 the last store was sold. Between 2004 and 2011 the creative department and the logistics are created and consolidated within the company. In 2011 the cutting department is introduced, with 2 cutting lines and four employees: the decision and the corresponding investment in the purchase of ad hoc machinery are undertaken mainly because the cutting phase is the most exposed to the risk of imitation - having to provide contractors all specifications of a clothing model - and therefore it is preferable to carry it out in house.

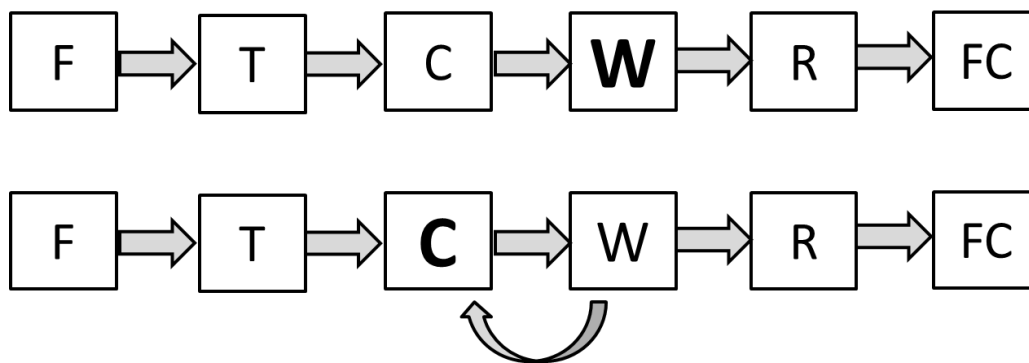

**Figure 1. The evolution of Alpha in the textile and apparel supply chain**

**Key:** Fiber manufacturer (F); Textile manufacturer (T); Clothing manufacturer (C); Wholesaler (W); Retail (R); Final customer (FC).

Source: Author's elaboration

To date, the company has 18 employees and a turnover of 9 million euro (data updated to 2014), up 25% over the previous year.

**Table 1. Company profile 2010-2014**

	2014	2013	2012	2011	2010
Turnover	8.976.736	7.071.245	6.538.456	7.521.701	5732089
Total Assets	6.001.252	5.665.767	5.131.223	7.159.085	6.251.293
Net Profit	95.230	37.700	45.498	91.982	77.126
Employees	18	18	17	15	13

Source: Alpha annual report

The business model adopted by Alpha has changed over the years. From a production of garments primarily for street vendors, shopkeepers and small chains of wholesalers, to a planned – or semi-planned – model following the timing of major customers (2 annual seasons, spring-summer and autumn-winter, in addition to flash collections to be delivered in less than a month). Thus, the company is also able to

provide seasonal capsule collections thanks to the organization of manufacturing process flow and to the short production cycle.

Customers have been reduced over the years, from around 150 to just over 30, according to a precise choice of qualified and well-positioned retailers as preferred customers that would guarantee orders for large quantities. Relationships with these customers are stable and with a strong fiduciary component, and involve a high level of customization. To this end, a fundamental role is that of the creative department, which offers every year to customers 500/600 models. The innovative and creative capacity characterize Alpha and widely different from other competitors in the area, especially from locally settled Chinese garment makers mainly characterized by the ability to imitate and not to create. In summary, design, collection development and production are core services offered to high level fashion brands as well as to the most prestigious retail companies. Alpha has maintained stable relationships for the past 12 years with Chinese subcontractors located in the Prato district. In particular, compared to a reduction of the number of customers, there has been a reduction in the number of suppliers. To date, Chinese immigrant firms with which Alpha works stably are four, all family businesses founded in Prato in the early 2000s; among these, one is a large company with 120 employees. Exclusive contracts imply that the Chinese suppliers can't work for other companies similar to Alpha for positioning, type of products offered and customers served. The supplies mainly concern complex manufacturing and ironing. Other processes such as sewing buttonholes and buttons are done by Italian subcontractors.

Alpha is characterized by strong ethical principles that have resulted in an ethical supply chain involving also Chinese companies, which have had to adapt over the years to high quality standards, the regularization of employees and respect of safety laws at the workplace. These elements are related to problems among Chinese enterprises in the district in terms of illegal labour, exploitation of workers and tax evasion, to name a few.

Alpha's effort in this regard assumes that at the basis of integration between native and immigrant companies there must be a “cultural revolution” of Chinese immigrant firms, with a view not only to comply with regulations, but also to fully enter in district dynamics and strengthen relationships with native companies and local institutions, rather than develop a parallel district. The profit orientation regardless of compliance with the rules, the orientation to transaction rather than lasting relationship, the instability of labour relations are just some typical features and cultural traits of the way of doing business for many Chinese entrepreneurs. The interaction with Alpha brought major changes in terms of: changing the approach to the stability of labour relations between employees and employers as a result of the continuity of work guaranteed by Alpha; qualification of Chinese companies as suppliers of native companies from the Made in Italy tradition; dissemination of legality.

## **DISCUSSION OF RESULTS**

The case under study allows to put forward some considerations about our research question concerning the liabilities emerging locally from a cross-cultural business setting and how such liabilities are they related to interaction among business actors. The case analysed shows the interaction between a family business located in the area of Prato, and locally settled immigrant firms, mainly Chinese suppliers of manufacturing activities. The case confirms the existence of transactions between native and immigrant firms, mainly in the clothing sector than in the textile sector. The proposed case is not representative of what currently happens in the area of Prato in terms of interactions between native Chinese immigrant and native firms, which are limited especially in the textile sector, but it is a case, as confirmed by representatives of local institutions, of positive business relationships established over the years with Chinese suppliers.

Chinese companies with which Alpha has significant relationships, namely the four subcontractors mentioned, by the very fact of having business relationships with Alpha, have embarked on a process that will differentiate them from other immigrant Chinese firms in the Prato area. This path takes the form of interaction, in which the main changes concern the Chinese suppliers that are placed in a learning position with respect to Alpha that in a first observation keeps a role of teaching. However, even Alpha has implemented a process of learning about cultural and relational specificities of Chinese actors. If on one hand Chinese suppliers start interactive processes with Alpha, on the other hand the same suppliers differ, as a result of the changes put in place, from the other Chinese immigrant firms. In addition, the four Chinese suppliers have implemented organizational and cultural changes that make them non-representative of the totality of the Chinese immigrant firms settled in Prato.

Interaction with native firms requires an adaptation of organizational processes, but also of the business culture and lifestyle (for example, stabilization of labor relationships and the achievement of a good level of quality of the workplace). Such adaptation is required by the native firm itself, in line with company policy, and according to a principle of consistency between buyers, suppliers and positioning of the entire supply chain, in a long-term policy aimed at influencing suppliers sometimes at the expense of profit. Interaction with some actors, however, doesn't result in a reduction of liability of outsidership. While it is active the mechanism of teaching and learning, this does not seem sufficient to give a real insidership nor to the Chinese immigrant firms in the local network, or to native firms in Chinese business networks. Relationships appear as weak ties (Granovetter, 1973) which have a bearing on the level of individual actors, but the overlap between networks of different actors remain weak. Therefore a persistent psychic distance, related to the liability of foreignness, remains, in addition to a lack of familiarity, which is acquired in the relationship with the individual supplier but does not imply the achievement of an insidership position, and discriminatory attitudes (see Eden & Miller, 2001).

Thus, elements of foreignness and outsidership still remain locally and act as “local liabilities” that emerge when two (or more) separate communities (of persons and firms) exist in the same place (Guercini *et al.*, 2017). The case seems to show an intermediate position between the lack of interaction and the achievement of insidership. It could therefore be assumed that the process is underway, but since relationships have existed for a long time, it’s more reasonable to imagine that it is a non-temporary condition.

## **FINAL REMARKS**

The paper focused on liabilities traceable to elements of foreignness and outsidership that emerge locally. Such local liabilities imply that on one hand immigrant entrepreneurs can experience a liability of outsidership from local networks, yet may be insiders to the global networks that are dominant in specific markets. On the other hand, native entrepreneurs can experience a relative outsidership from the global networks dominated by immigrant entrepreneurs. Facing (and possibly overcoming) such liabilities that emerge in interaction processes between companies embedded into a local context can boost the development of new combinations of local and transnational business relationships; opportunities, and liabilities, stem from the creation of interactions among migrants and natives actors with specific resources combinations and activity structures at a local and transnational level.

The contribution of the paper is twofold. First of all, the paper stresses the importance of culture in managing cross-cultural business relationships, which is still an under-investigated topic in streams of literature following and IMP perspective. Secondly, the paper contributes to the literature on liabilities in the international business domain by considering the emergence of local liabilities as a result of the coexistence within the same territory of two (or more) separate communities of people and firms.

The methodology adopted in the paper is that of case study. A limit is the use of single key informants (the owner/entrepreneur of the selected company) as the main source of information could limit our understanding of the cases study. However, as the decision making activities and management of business relationships with suppliers tend to be conducted by a few key individuals, this method can be considered appropriate in studies such as this. In addition, an interactive perspective requires the inclusion of all actors involved in interaction processes. Future research may take into consideration the Chinese counterparts of the focal firm. Finally, that of Alpha is an emblematic case of fruitful interaction among native and immigrant entrepreneurship within a local context. A multiple case study might be conducted with the aim of providing some external validity for our findings so as to increase their generalizability.

## REFERENCES

- Amelingmeyer, J. and Moehringer, S. (2002). International networks of small and medium sized enterprises - The role of culture and competence. In IMP Conference Proceedings, Dijon.
- Battaglia, L., Nadin, G., & Gobbin, L. (2004). The role of cultural differences in the dynamic of a relationship. The case of Italian and Chinese companies. In Proceedings of the 20th IMP Conference.
- Björkman, I., & Kock, S. (1995). Social relationships and business networks: The case of Western companies in China. *International business review*, 4(4), 519-535.
- Calhoun, M. A. (2002). Unpacking liability of foreignness: identifying culturally driven external and internal sources of liability for the foreign subsidiary. *Journal of International Management*, 8(3), 301-321.
- Dei Ottati, G. (2009). An industrial district facing the challenges of globalization: Prato today. *European Planning Studies*, 17(12), 1817-1835.
- De Marchi, V., & Grandinetti, R. (2014). Industrial districts and the collapse of the Marshallian model: looking at the Italian experience. *Competition & Change*, 18(1), 70-87.
- Dubois, A., & Gadde, L. E. (2002). Systematic combining: an abductive approach to case research. *Journal of business research*, 55(7), 553-560.
- Easton, G. (2010). Critical realism in case study research. *Industrial Marketing Management*, 39(1), 118-128.
- Eden, L., & Miller, S. (2001). Opening the black box: multinationals and the costs of doing business abroad. In *Academy of Management Proceedings* (Vol. 2001, No. 1, pp. C1-C6). Academy of Management.
- Eisenhardt, K. M., & Graebner, M. E. (2007). Theory building from cases: Opportunities and challenges. *Academy of management journal*, 50(1), 25.
- Fang, T., & Kriz, A. (2000). Cross-cultural challenges to the IMP paradigm: evidence from Chinese markets. In *IMP 16th Annual International Conference Bath, UK*.
- Ford, D. (1997). *Understanding Business Markets: Interaction, Relationships and Networks*, Dryden Press, London.
- Ghuri, P., & Fang, T. (2001). Negotiating with the Chinese: A socio-cultural analysis. *Journal of World Business*, 36(3), 303-325.
- Granovetter, M. S. (1973). The strength of weak ties. *American journal of sociology*, 1360-1380.
- Guercini, S. (2002). Profilo del vertice, processi di sviluppo e politiche di mercato dell'impresa cinese a Prato. In Colombi, M. *L'imprenditorialità cinese nel distretto industriale di Prato*, Firenze, Olschki, 35-70.

- Guercini, S., Dei Ottati, G., Baldassar, L., & Johanson G. (Eds.) (2017). Native and immigrant entrepreneurship. Lessons for local liabilities in globalization from the Prato case study. Springer.
- Håkansson, H. (1982). International marketing and purchasing of industrial goods: An interaction approach. Chichester: Wiley.
- Håkansson, H., Ford, D., Gadde, L. E., Snehota, I., & Waluszewski, A. (2009). Business in networks. John Wiley & Sons.
- Hilmersson, M. (2013). The effect of international experience on the degree of SME insidership in newly opened business networks. *Baltic Journal of Management*, 8(4), 397-415.
- Itthipassagul, P. & Blois, K. (2000). Managing business relationships in Thailand. *Journal of Asian Business*, 16(2), 71-85.
- Johanson, J., & Vahlne, J. E. (2009). The Uppsala internationalization process model revisited: From liability of foreignness to liability of outsidership. *Journal of international business studies*, 40(9), 1411-1431.
- Johanson, J., & Vahlne, J. E. (1977). The internationalization process of the firm-a model of knowledge development and increasing foreign market commitments. *Journal of international business studies*, 23-32.
- Lowe, S., Purchase, S., & de Lurdes Veludo, M. (2002). Business relationships: cross-cultural analysis. *Power*, 25(37), 27.
- Milanesi, M., Guercini, S., Waluszewski, A. (2016). A Black Swan in the district? An IMP perspective on immigrant entrepreneurship and changes in industrial districts. *IMP Journal*, forthcoming.
- Schweizer, R. (2013). SMEs and networks: Overcoming the liability of outsidership. *Journal of International Entrepreneurship*, 11(1), 80-103
- Zaheer, S. (1995). Overcoming the liability of foreignness. *Academy of Management journal*, 38(2), 341-363.

# SERVICE QUALITY, CUSTOMER SATISFACTION AND CORPORATE IMAGE AS A KEY DRIVER OF CUSTOMER LOYALTY IN TRADITIONAL RETAIL

Miranda Veloso, Cláudia<sup>1</sup>; Magueta, Daniel Margaça<sup>2</sup>; Fernandes, Paula Odete<sup>3</sup>; Rito-  
Ribeiro, Humberto Nuno<sup>4</sup>

<sup>1</sup>ESTGA; UNIAG; Polytechnic Institute of Bragança, University of Aveiro, Aveiro, Portugal

<sup>2</sup>ESTGA; University of Aveiro, Aveiro, Portugal

<sup>3</sup>UNIAG; Polytechnic Institute of Bragança; NECE; Bragança, Portugal

<sup>4</sup>ESTGA, GOVCOPP, University of Aveiro; Aveiro, Portugal

## ABSTRACT

Currently one of the main challenges for managers in the retail industry is to provide and maintain customer satisfaction. While the reasons for an initial purchase in a retail store may be due to factors partially outside the control of retail managers, the ability to create a satisfactory experience for the consumer remains, to a considerable degree, in the hands of both the management and the retail staff. It is crucial for managers of traditional retail stores to have a good and clear understanding of exactly what customers are wishing to obtain. The main purpose of this research is to identify the dimensions of service quality and examining the interrelationships among customer satisfaction, image and customer loyalty and service quality in the traditional retail. A multi-level and hierarchical model is used as a framework to synthesize the impacts of customer satisfaction, service quality and corporate image on loyalty of customers in the traditional retail. The results revealed that service quality is the main determinant of customer satisfaction and corporate image. Also corporate image significantly influences customer satisfaction. Furthermore, customer satisfaction, corporate image and service quality significantly affect customer loyalty. This research is of particular significance to the literature in retail and to practitioners as well, since there are few studies in this field applied to the Portuguese traditional retail market.

*Keywords: Customer Satisfaction, Corporate Image, Retail Service Quality, Customer Loyalty, Portugal.*

## INTRODUCTION

The replacement of small family owned traditional stores with modern retailing is a universal phenomenon. However, traditional retail systems still exist both in less developed countries as in



developed economies where traditional retail formats often operate alongside modern retailing. In recent years, the retail industry has drastically changed, with consumers increasingly informed and varying their route to purchase between in traditional store, online and modern retailing. Therefore, it is crucial for traditional retailers to offer an experience to someone going into their store that they could not receive thru another channel or in modern retailing. Some of the fastest growing sectors of global economy are related to the consumption of experiences. Despite the increasing variety of ways in which we can purchase merchandises, the in-store experience is still the first thing that springs to mind for the majority of people when thinking about a retailer; so whether it be through great customer service, a nice shopping atmosphere, cutting advantage in-store technology or a pleasant checkout experience, retailers are looking to create an in-store environment which will offer something different to their customers. During this evolution, quality has acquired a very important weight in all industries of the economy and has become a key factor of business survival. Undoubtedly, the term quality is very present in the retailing industry, where all organizations aim to provide quality to their customers. But it's not as simple as it sounds, because to benefit from quality, organizations must be ready to meet the expectations of their customers. With this, we can define that, in order to remain in the market increasingly competitive, companies from traditional retailing have already adhered to quality.

Numerous authors have studied the relationship between perceived service quality and customer satisfaction, confirming that service quality is an important antecedent of satisfaction. In this regard, Dabholkar, et al. (2000) argue that traditionally, most researchers conclude that customer satisfaction resulting from a particular experience of consumption, leads to an evaluation about the quality of service over a period of time. Although the quality of service in the retail industry has been extensively researched internationally (e.g., Al Khattab & Aldehayyat, 2012; Zaibaf, et al., 2013) there has been little research done in Portugal to examine service quality as an antecedent of satisfaction and behavioural intention of customers in the Portuguese traditional trade. The choice of this topic is due to the need for traditional retailers to properly understand whether the service meets customer perceptions in the different dimensions of SERVQUAL, contribute to their satisfaction and customer loyalty (intention to return and recommend services), since they are determinant variables in maximizing profit, market share, and return on investment.

In this context, the main objective of this paper is to propose and apply a multi-level model that allows for the examination of the antecedents and consequences of customer satisfaction, in traditional trade in North of Portugal. We specifically intend to present a conceptual model is used as a framework to identify the dimensions of service quality and examining the interrelationships among customer satisfaction, corporate image and customer loyalty and service quality in the traditional retail industry. In this paper, after this present introduction, a review of the main literature on corporate image,

customer satisfaction and their customer loyalty is made, then we propose the conceptual model and research hypotheses, after presented the findings and discussion, ending with the presentation of the discussion and the conclusion of the research. This study is particularly important for retail managers (survival and growth of retail companies), politicians (wealth creation, economic growth, etc.) and for the development of the literature in the Portuguese traditional retail industry.

## **THEORETICAL BACKGROUND AND HYPOTHESES**

### *Service Quality*

In these last decades there has been several research in the area of service quality and it is discussed lots for the aim that no consensus has been reached thus far on its definition and measurement. Early studies on service quality defined it as a measure to which a service provides customer needs, and implicates a comparison of customer expectations with their perceptions of actual service performance (Parasuraman, et al., 1985; Parasuraman, et al., 1988). Service quality has assumed a major role both in public and private institutions, as an indispensable requirement to customer satisfaction. There are two basic ways to define quality: one from the viewpoint of the service provider and the other from the client's perspective. Firstly, it should be noted that the measurement of service quality is an important area of academic and scientific interest, which has assumed special prominence after the contribution of various authors (Parasuraman, et al., 1985). These authors, who represent the American school, have designed an instrument for measuring quality of service, called SERVQUAL. Initially, the proposed model incorporated 10 dimensions of quality (tangibility, reliability, responsiveness, professionalism, courtesy, credibility, security, access, communication and customer understanding). However, these dimensions were revised and subsequently reduced to five. Parasuraman, et al. (1988) suggested the following definitions for the five dimensions: Tangibles, Reliability, Responsiveness, Assurance and Empathy.

Cronin and Taylor (1992) observed that the validity of the use of expectations in the SERVQUAL model was called into question when consumers had no well- formed expectations and developed the SERVPERF scale which consists of the same 22 "items" of SERVQUAL, although centred only in measuring consumer perceptions regarding the quality of service. Despite the diversity of studies in many fields, in this study, SERVPERF will be applied to the traditional trade in the North of Portugal in a similar manner as that of other studies realized at an international level, in the area of the trade industry (Abd-El-Salam, et al., 2013; Durvasula & Lysonski, 2010; Khare, et al., 2010; Martinelli & Balboni, 2012; Tang, et al., 2015; Yu & Ramanathan, 2012; Yuen & Chan, 2010). According to Nadiri and Hussain (2005) service quality increases customer satisfaction, stimulus's intention to return, and

inspires recommendations. In line with this studies, and based on SERVQUAL and SERVPERF, the following hypotheses are proposed in the present study:

**H<sub>1</sub>:** The perceived service quality by clients been a multidimensional construct.

**H<sub>2</sub>:** The perceived service quality by the customers has a positive influence on their satisfaction.

**H<sub>3</sub>:** The perceived service quality by the customers has a positive influence on corporate image.

**H<sub>4</sub>:** Perceived service quality has positive relationship with customer loyalty.

### *Customer satisfaction*

Customer satisfaction is the outcome of the customer's perception of the value received in a transaction or relationships, where value equals perceived service quality, compared to the value expected from transactions or relationships with competing vendors (Zeithaml, et al., 1990). Customer satisfaction is a mighty immaterial asset like to service quality and can be attained through the compliance of customer expectations (Oliver, 1980; Jayasankaraprasad & Kumar, 2012). Also, customer satisfaction is a function of the disagreement between a customer's expectations previous to buying and their perception of the same service subsequently Anderson and Sullivan (1993) and Oliver (1980) will be significant if the perception is placed at a higher level than the expectation. More value for customer incomes great satisfaction, which can benefit the retail enterprise in the long term (Cronin, et al., 2000) and generate higher profits. Customer satisfaction is found to be dependent on the quality of service presented to the customer and is one of the instruments to enhanced value for customers. The major challenges for service industry are service quality and customer satisfaction. According to Gundersen, et al. (1996) the central point of customer satisfaction is to identify the crucial attributes, considered by customers as their needs and expectations. The key to customer satisfaction lies in identifying and anticipating customer needs and especially in being able to satisfy them. Enterprises which are able to rapidly understand and to satisfy customers' needs, make greater profits than those which fail to understand and satisfy them (Dominici & Guzzo, 2010). On the another hand, Bennett and Rundle-Thiele (2002), argued that for customers to escalate their loyalty, their perceived value of the good or service presented need be at par with reality, forming an integral part of the corporate aims of the organization. Additionally, Sirdeshmukh, et al. (2002), reported that customers' satisfaction has close relationship to brand loyalty as well as service quality. Analogous claim is presented by Hoq and Amin (2010) who postulated that customer satisfaction is the emotional tendency of a customer towards repurchase of products and services offered by a retail store. In order to be successful, especially in the retail industry, managers must concentrate on retaining existing customers by implementing effective strategies towards customer satisfaction and loyalty, since the cost of attracting new customers is

higher than the cost of retaining existing ones (Yuen & Chan, 2010). Based on these findings, it is proposed that:

**H<sub>5</sub>:** Customer satisfaction positively influences intention to return.

**H<sub>6</sub>:** Customer satisfaction positively influences on customer loyalty to the staff.

**H<sub>7</sub>:** Customer satisfaction positively influences word of mouth recommendations.

### *Corporate image*

The concept of brand image has been widely studied by researchers in the area of marketing (Abd-El-Salam, et al., 2013; Kim & Kim, 2005; Kim & Lee, 2010; Sahin & Baloglu, 2011; Yu & Ramanathan, 2012). For Kim and Kim (2005) a brand represents the essence of the customers' perceptions of the organizations. Also, Keller (1993) defined corporate image as perceptions of an organization reflected in the associations held in consumers' memory. Corporate image is defined as the "general impression" left in the customers' mind as a result of accumulative impressions or feelings, attitudes, ideas and experiences with the firm, saved in memory, transformed into a positive/negative sense, retrieved to rebuilding image and recalled when the name of the firm is heard or brought to ones' mind (Bravo, et al., 2009). According to Sahin and Baloglu (2011) brand image is defined as the perception of customers about a brand or a product labelled with that brand. Different authors consider brand image as an important component of strong brands and a determinant in the obtainment of competitive advantages (Lim & O'Cass, 2001).

An overall assumption is that a promising corporate image will have a positive impact on consumers' behaviour towards the brand, such as the opportunity to command premium prices, buyers who are more loyal, and more positive word-of-mouth reputation (Martenson, 2007). Some researchers developed in last years, have tested the effect of corporate image on customer satisfaction and loyalty (Kim & Lee, 2010; Yu & Ramanathan, 2012). Their empirical findings showed that corporate image plays the important role in founding and retaining customer loyalty in the markets. Additionally, these authors found that customer satisfaction and corporate image perceptions positively influence service loyalty, with satisfaction having a greater influence on loyalty than image.

Thus, corporate image is believed to create a positive effect on customers' satisfaction. When customers are satisfied with the service provided of company, their attitude toward the company is enhanced (Srivastava & Sharma, 2013). Based on the reported research, it is proposed:

**H<sub>8</sub>:** Corporate image has positive relationship with customer satisfaction.

**H<sub>9</sub>:** Corporate image has positive relationship with customer loyalty.

### *Customer Loyalty*

The literature suggests behavioural intentions as a construct which permits the evaluation of customer loyalty. These are behaviours related to the intention to repurchase and even to the intention of recommending the product/service (Zeithaml, et al., 1996; Sumaedi, et al., 2012; Yuen & Chan, 2010). Some studies developed in service industry have found the positive relationship between perceived service quality and loyalty. Customers frequently develop an attitude toward purchasing based on a prior service experience or, still, this attitude can also be influenced by previous information, based on the image of the retail in the market and even by word of mouth (WOM recommendation). With reference to the previous conception, customer loyalty has been usually defined as occurring when customers repetitively buying goods or services over time and retain positive attitudes towards the enterprise delivering the goods or services (Yuen & Chan, 2010). Service providers are increasingly developing loyalty, as they consider that it helps to rise income, and leads to largest market share, effectiveness and profitability. In this sense, behavioural intentions can be defining as the customer's judgment about the likeliness to repurchase in this firm or the willingness to recommend the firm to others. We conceptualize behavioural intentions as a higher-order construct consisting of (1) positive word of mouth, (2) willingness to recommend, and (3) intentions to continue buying from a particular service provider. Based on previous definition, behavioural intention in this study can be described as a stated likelihood to repurchase in the traditional trade in the North of Portugal, setting loyalty to the staff of the traditional retail store and to recommend this store to family, friends and others in the future. Research has established the many benefits of behavioural intention, such as making it a tendency for retailers to follow, as well as developing and maintaining a loyal customer base (Yuen & Chan, 2010). There is also ample evidence of the influence of service quality on behavioural intentions, a huge body of research has demonstrated the significant relationship between service quality and customers' behavioural intentions (Parasuraman, et al., 2005). It was expecting customers who perceive the quality of the service as high to be more likely to demonstrate intentions, and we again believe that this relationship will hold regardless of the buyers' collectivist orientation. Loyal customers are main assets to firms, they make proportionally more purchases at their' first choice' store than customers who shift. Usually, great service quality leads to customer loyalty, as it increases customer confidence towards and satisfaction with the company. It is supposed that positive perceptions of service quality enhance the possibility of customers being dedicated in supporting the company and developing and strengthening loyalty behaviour (Yuen & Chan, 2010). The customer loyalty is perceived like as behavioural intention and several scholars consent it is a construct of three levels, namely person-to-person loyalty and person-to-firm loyalty (intention return) and recommendation (WOM). Yuen and Chan (2010) approved the relationship between salesperson loyalty and firm loyalty and they

confirmed that the former will carry the latter. Additionally, Oh (1999) found a positive and significant relationship between intention to return and WOM recommendations. Based on these findings, it is proposed that:

**H<sub>10</sub>:** Intention to return positively influences WOM recommendations.

**H<sub>11</sub>:** Staff Loyalty positively influences Intention to return

According to this theoretical background, the aim of this study is to propose a model that consists of evaluating the impact of, as Figure 1 shows: (1) perceived service quality directly contribute to customer satisfaction, corporate image and customer loyalty; (2) corporate image and customer satisfaction directly contribute to customer satisfaction; (3) corporate image directly contribute to customer satisfaction; (4) customer satisfaction directly influences the intention to return, the loyalty to staff and WOM recommendation (Word-of-Mouth communication intention) and (5) the loyalty to staff has a direct influence on the intention to return and this has a direct impact on WOM recommendation.

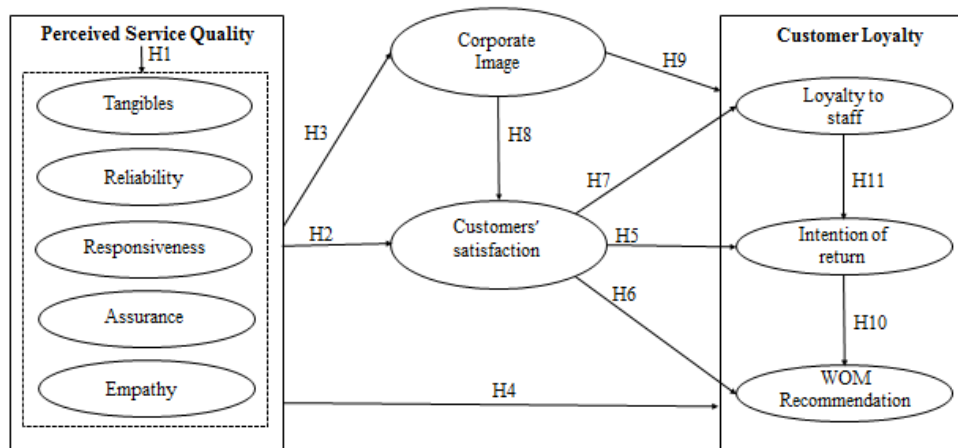

Figure 1. Research model.

## DATA COLLECTION AND ANALYSIS

A questionnaire was designed as the survey instrument, which were included all the constructs of the proposed model. The questions in the questionnaire were based on a review of the literature in the area of the trade industry, described above in the theoretical background. This study was applied to customers from traditional retail stores in the north of Portugal during the month of February, 2017. It was used a non-probabilistic sampling using convenience technique. The questionnaires were distributed online, in order to facilitate a quick distribution and collection of questionnaires in all cities in Northern Portugal, and the answers came from the several cities and places of the north of Portugal. In this study, respondents were required to fill out a three-page three sections. The first section

consisted of a standard demographic profile of respondents. The second section contained the characterization of purchase process. The last section includes the statements of dimensions and their sub dimensions. The measurement items to measure primary and sub-dimensions of service quality were adapted from several researchers (Cronin & Taylor, 1992; Dabholkar, et al., 1996; Wu, et al., 2011) and a series of items focusing on the behavioural intentions, customer satisfaction, corporate image and service quality, which were adapted on the basis of several researchers' results (Wu, 2013; Yuen & Chan, 2010; Yu & Ramanathan, 2012; Zeithaml, et al., 1996). Respondents were asked to use a five-point Likert-type scale (between 1 = 'strongly disagree' and 5 = 'strongly agree') to record their perceptions. Construct reliability was assessed by using the Cronbach's alpha coefficient. Reliabilities ranged from 0.832 to 0.965, suggesting that the construct could be used with confidence.

For the descriptive analysis it was used absolute and relative frequency tables. The Spearman correlation coefficient it was used to measure the intensity of the linear correlation between variables. Multiple linear regression was used in order to estimate models that could identify the determinants of the behaviour of the variables under analysis. The significance level of 5% was assumed in all analysis.

## **FINDINGS, RESULTS AND ANALYSIS**

### *Demographic Profile*

The sample of the North of Portugal was composed of total 211 respondents which 58.3% (123) were females and 41.7% (88) were males. The maximum number of responses was obtained from 35 - 44 years old with 43.1% (91) and the second age group from 45 - 54 years, with 28% (59) responses. Most respondents 66.8% (141), were married or in an unmarried partner, 23.2% (49) were single. It is verified most of respondents had higher education qualifications, as 33.2% (70) were graduates; 10.4% (30) had postgraduate degrees; 14.2% (30) had a master's degree and 12.3% (26) were PhDs. As for the professional occupation mostly, 78.2% (165) were employed. In the activity sector, banking stood out with 34.1% (72) of the respondents, followed by education sector with 17.1% (36) of the individuals. Regarding the average annual income, it is observed that 28% (59) of the respondents earned between 7001€ to 20000€; 29.9% (51) earned between 20001€ to 40000€ and 21.3% (45) received annually between 40001€ to 80000€.

### *Purchase Process*

The obtained results show that 98.1% (207) of the respondents purchases in traditional trade. It was verified that 74.4% (157) of the individuals had made purchases in traditional commerce there is more than 12 months. The most popular frequency of purchases registered was monthly, 33.6% (71) of the respondents go to the traditional trade once a month and 32.2% (68) do it weekly. As for the average

annual spending on purchases in the traditional commerce, it was found that 30.3% (64) of the respondents spend under 100€ and that 39.8% spend more than 400€ annually.

#### *Correlation and regression analyses*

Analysing the 0 shows that the sub-dimensions that constitute Service Quality (SQ) present strong and direct correlations with the SQ, namely reliability, responsiveness and empathy sub-dimensions with very strong correlation coefficients. These findings corroborate hypothesis 1.

Dimensions	Service Quality
Tangibles	0,828
Reliability	0,938
Assurance	0,895
Responsiveness	0,939
Empathy	0,935

Table 1. Spearman correlation between SQ and its constituent dimensions.

The 0 shows that the dimensions that constitute Customer Loyalty present strong and direct correlations with the same, namely the dimensions: WOM and intention to return. The staff loyal contributes least to the behavioural intentions (customer loyalty). All values are statistically significant at a significance level of 5%.

Dimensions	Customer Loyalty
WOM	0,891
Intention to Return	0,943
Loyalty to Staff	0,787

Table 2. Spearman's correlation between Customer Loyalty and its constituent dimensions.

In the **Σφάλμα! Το αρχείο προέλευσης της αναφοράς δεν βρέθηκε.** it is verified that all scale dimensions have positive statistically significant correlation coefficients. The correlation between Service Quality and Customer Satisfaction is strong; as well as between customer loyalty and service quality and customer satisfaction. However, the correlations of the corporate image dimension with the other dimensions were of moderate intensity. All values are statistically significant at a significance level of 5%.

	Service Quality	Customer Satisfaction	Customer Loyalty	Corporate Image
Service Quality	1	0,807	0,740	0,607
Customer Satisfaction		1	0,792	0,545
Customer Loyalty			1	0,635
Corporate Image				1

Table 3. Spearman correlation between dimensions of scale.

Ordinary least squares regression was used to analyse each path in the conceptual model. Statistical assumption tests were assessed for each of the six regression models prior to the analysis in order to ensure a robust result.



The results of the hypotheses tests are presented in Table 4. The application of the multiple linear regression model allowed us to obtain a parsimonious model that makes it possible to predict the dependent variable from a set of regressors (independent variables).

In the first regression model which tests the influence of service quality and corporate value on the variation of customer satisfaction is tested. The model obtained is at a statistically significant level of significance of 1% ( $F = 263,672$ ;  $p\text{-value} < 0,001$ ), that is, the variation of customer satisfaction is explained significantly by the estimated model. By the application of the test  $t$ , we conclude that service quality ( $\beta = 0,783$ ;  $p\text{-value} < 0,001$ ) and corporate image ( $\beta = 0,097$ ;  $p\text{-value} = 0,046 < 0,05$ ) determine significantly the behaviour of customer satisfaction. The adjusted coefficient of determination reveals that the model presented explains, on average, about 71,8% of the variation of customer satisfaction. Consequently, this model supports the octave hypothesis.

The second regression model that relates WOM with the regressors: customer satisfaction, retail service quality, corporate image and intention to return is at a significance level of 1% statistically significant. The determinants of the model influenced significantly the variation of WOM, as the test  $t$ , customer satisfaction with coefficient  $\beta = 0,286$  and  $p\text{-value} < 0,001$ ; service quality ( $\beta = 0,286$ ;  $p\text{-value} < 0,001$ ); intention to return with coefficient  $\beta = 0,534$  and  $p\text{-value} < 0,01$ ; corporate image with coefficient  $\beta = -0,209$  and  $p\text{-value} < 0,001$ ; are statistically significant. The estimated model explains, on average, about 77,3% of the WOM variation. The Image presents negative and significant influence in the WOM, this can be explained given that Image alone does not lead to recommendation, however when associated with service quality and the customer satisfaction presents positive influence in the customer loyalty. Thus, this model supports the sixth and the tenth hypothesis.

In the third regression model that relates intention to return with the regressors: customer satisfaction, service quality and corporate image is at a significance level of 1% statistically significant. The followings determinants of the model influenced significantly the variation of intention to return, as the test  $t$ , customer satisfaction with coefficient  $\beta = 0,451$  and  $p\text{-value} < 0,001$  and corporate image with coefficient  $\beta = 0,268$  and  $p\text{-value} < 0,001$ ; are statistically significant. The estimated model explains, on average, about 70,9% of the intention to return. The service quality regressor is not presented significantly in the variation of intention to return. Thus, this model supports the fifth and the seventh hypothesis.

The fourth regression model that relates loyalty to staff with the regressors: customer satisfaction, service quality, corporate image and intention to return is at a significance level of 1% statistically significant. The estimated model explains, on average, about 43,1% of the loyalty to staff. The followings determinants of the model influenced significantly the variation of loyalty to staff, as the test  $t$ , customer satisfaction with coefficient  $\beta = 0,254$  and  $p\text{-value} = 0,021 < 0,05$  and intention to return with

coefficient  $\beta = 0,447$  and p-value  $<0,001$ ; are statistically significant. The service quality and corporate image regressors are not presented significantly in the variation of loyalty to staff. Thus, this model supports the eleventh hypothesis.

The fifth regression model that relates customer loyalty with the regressors: customer satisfaction, service quality and corporate image is at a significance level of 1% statistically significant. The determinants of the model influence significantly the variation of customer loyalty, because by the test t customer satisfaction with coefficient  $\beta = 0,536$  and p-value  $<0,001$ ; service quality with coefficient  $\beta = 0,173$  and p-value =  $0,013 <0,05$ ; corporate image with coefficient  $\beta = 0,248$  and p-value  $<0,001$ ; are statistically significant. The estimated model explains, on average, about 74,9% of the customer loyalty variation. Therefore, this model supports the second, fourth and ninth hypothesis.

The sixth regression model that relates corporate image to the service quality regressor, is at a significance level of 1% statistically significant. The estimated model explains, on average, about 41,6% of the corporate image variation. By the application of the test t, the service quality with coefficient  $\beta = 0,648$  and p-value  $<0,001$ , can be conclude that, determines significantly corporate image behaviour. Therefore, this model supports the third hypothesis.

Dependent variable	Independent variables	Adjusted R2	F value (p value)	Standardized coefficients	t value (p value)
Customer Satisfaction	Service Quality	0,718	263,672 (<0,001)	0,783	16,135(<0,001)
	Image			0,097	2,005(0,046)
WOM	Customer Satisfaction	0,773	176,030 (<0,001)	0,286	4,157(<0,001)
	Service Quality			0,286	4,324(<0,001)
	Image			-0,209	-4,138(<0,001)
Intention to Return	Intention to Return	0,709	168,609 (<0,001)	0,534	8,601(<0,001)
	Customer Satisfaction			0,451	6,340(<0,001)
	Service Quality			0,094	1,265(0,207)
Loyalty to Staff	Image	0,431	39,946 (<0,001)	0,402	8,078(<0,001)
	Customer Satisfaction			0,254	2,335(0,021)
	Service Quality			-0,098	-0,935(0,351)
Customer Loyalty	Image	0,749	206,451 (<0,001)	0,104	1,300(0,195)
	Customer Satisfaction			0,447	4,549(<0,001)
	Service Quality			0,536	8,123(<0,001)
Corporate Image	Image	0,416	148,001 (<0,001)	0,173	2,509(0,013)
	Service Quality			0,248	5,374(<0,001)
	Service Quality			0,648	12,166(<0,001)

Table 4. A summary of regression models.

## DISCUSSION AND CONCLUSION

The objective of this study was to identify the dimensions of service quality and examining the interrelationships among customer satisfaction, corporate image and customer loyalty and service quality in the traditional trade, in addition to investigate the customer satisfaction, service quality and corporate image as a key activator of the customer loyalty in the traditional trade in the North of

Portugal. The results from exploratory factor analysis indicate that service quality consists of five dimensions (tangibles, reliability, responsiveness, assurance and empathy). For traditional trade in the North of Portugal, reliability; responsiveness and empathy play an important role in determining service quality, and are followed by assurance and tangibles, which confirms the H1.

The results of this study demonstrate that service quality has a direct influence on corporate image, which in turn, influence customer loyalty. The positive relationship between service quality and corporate image suggests that customers who received high service quality during service delivery would form a favourable image of the traditional retail store. Additionally, service quality was also found to have direct effects on corporate image, supporting the H3. Furthermore, the relationship between customer satisfaction and corporate image is significant, thus, H8 is supported. Increased service quality then results in greater corporate image that results indirectly in greater customer loyalty, based on the positive relationship between image and customer loyalty, since the H9 was supported.

A positive relation between service quality and customer loyalty was expected, in this study also is confirmed, the relationship between service quality and customer loyalty is significant, though in this study the service quality does not have a positive influence on intention to return and on loyalty staff, however the service quality influences directly the customer loyalty overall, thus, H4 is supported. The results nonetheless show that service quality has an indirect effect on behavioural intentions, customer satisfaction and corporate image, since the H2 and H3 was supported.

Moreover, the findings showed that the service quality is an antecedent of customer satisfaction and this is indirectly influence customer loyalty. The level of satisfaction of the customers positively affects their word of communication about traditional stores retail of the north of Portugal and the customers' intentions to revisit these stores. Findings found have supported the H5, H6 and H7, are also consistent with the literature. In other researches such as this, satisfied customers have higher levels of intention for revisiting traditional stores of the north of Portugal and their satisfaction levels induce them to provide positive word of mouth communication.

Both customer satisfaction as corporate image directly influences customer loyalty. In general, satisfied customers form their favourable behavioural intentions to return or recommend the traditional retail store while experiencing a high level of service quality that produces a favourable corporate image. Customer satisfaction has a positive influence on behavioural intentions, suggesting that satisfied customers will return or revisit traditional retail store to repurchase again and may recommend their favourite traditional store to friends or relatives. Corporate image has been found to have a positive effect on behavioural intentions, implying that customers forming their positive overall impressions of the image of traditional store retail are more likely to return or revisit the similar store in the future.

This study identified five primary dimensions of service quality in the traditional trade in the North of Portugal. For example, management can use the information from this study to improve their understanding of the factors that create a pleasant purchasing experience and act to increase customers' positive customers' loyalty. Furthermore, the customers who return or revisit the traditional retail stores can help management to establish a good reputation through the positive word-of-mouth. In addition, retail management should know and resource the customer-important sub-dimensions to improve traditional trade' competitiveness. This information will enable management to accurately measure customers' perceptions of their overall experiences in the traditional trade. Therefore, management should realize that service quality in the trade industry definitely influences customers' future favourable behavioural intentions through satisfaction and corporate image.

As observed in this research, the main purpose was studied the relationships among higher order constructs such as customers' loyalty, customer satisfaction, corporate image, and service quality in traditional trade in the north of Portugal. Nevertheless, the interrelationships among these constructs and their supporting dimensional structures have not attracted a lot of attention in the retailing literature of Portugal. The results of this research provide retail management with a better understanding of the effect of service quality on corporate image, which then influence customer satisfaction.

The study results aid traditional trade stores owners and managers to recognize and prioritize the primary and sub-dimensions of service quality. Trade management should realize that the significance customers accentuate is based on each of the primary and sub-dimension of service quality. Moreover, traditional trade management should structure their infrastructure, processes, operations and resource allocation in terms of the relative importance of the service quality dimensions to their target at specific customers. Simultaneously, the retail managers should dedicate special attention to the corporate image that gives to the market, whether through communication actions or interaction with society where operate. The main limitation of the research is the convenience sampling technique, the study would obtain a greater meaning and general importance if it would have been conducted by random sampling method.

## **ACKNOWLEDGEMENTS**

*This work was financially supported by the research unit on Governance, Competitiveness and Public Policy (project POCI-01-0145-FEDER-006939), funded by FEDER funds through COMPETE2020 - Programa Operacional Competitividade e Internacionalização (POCI) – and by national funds through FCT - Fundação para a Ciência e a Tecnologia.*



## REFERENCES

- Abd-El-Salam, E. M., Shawky, A. Y. & El-Nahas, T., 2013. The impact of corporate image and reputation on service quality, customer satisfaction and customer loyalty: testing the mediating role. Case analysis in an international service company. *Journal of Business and Retail Management Research*, Volume 8(1), pp. 130-153.
- Al Khattab, S. A. & Aldehayyat, J. S., 2012. Perceptions of Service Quality in Jordanian Hotels. *International Journal of Business and Management*, Volume 6(7), pp. 226-233.
- Anderson, E. W. & Sullivan, M. W., 1993. The antecedents and consequences of customer satisfaction for firms. *Marketing Science*, Volume 12(2), pp. 125-143.
- Bennett, R. & Rundle-Thiele, S., 2002. A comparison of attitudinal loyalty measurement approaches. *The Journal of Brand Management*, Volume 9(3), pp. 193-209.
- Bravo, R., Montaner, T. & Pina, J., 2009. The role of bank image for customers versus non-customers. *International Journal of Bank Marketing*, Volume 27(4), pp. 315-334.
- Cronin, J. J., Brady, M. K. & Hult, G. T. M., 2000. Assessing the effects of quality, value, and customer satisfaction on consumer behavioral intentions in service environments. *Journal of Retailing*, Volume 76(2), pp. 193-218.
- Cronin, J. & Taylor, S., 1992. Measuring service quality: a reexamination and extension. *Journal of Marketing*, Volume 56(3), pp. 55-68.
- Dabholkar, P., Shepherd, C. & Thorpe, D., 2000. A comprehensive framework for service quality: An investigation of critical conceptual and measurement issues through a longitudinal study. *Journal of Retailing*, Volume 76(2), pp. 139-173.
- Dabholkar, P., Thorpe, D. I. & Rentz, J. O., 1996. A measure of service quality for retail stores: Scale development and validation. *Journal of the Academy of Marketing Science*, Volume 24(1), pp. 3-16.
- Dominici, G. & Guzzo, R., 2010. Customer satisfaction in the hotel industry: a case study from Sicily. *International Journal of Marketing Studies*, Volume 2(2), pp. 3-12.
- Durvasula, S. & Lysonski, S., 2010. Diagnosing service quality in retailing: the case of Singapore. *Journal International Business and Entrepreneurship Development*, Volume 5 (1), pp. 2-17.
- Gundersen, M., Heide, M. & Olsson, U., 1996. Hotel guest satisfaction among business travelers: what are the important factors?. *The Cornell Hotel and Restaurant Administration Quarterly*, Volume 37(2), pp. 72-81.
- Hoq, M. Z. & Amin, M., 2010. The role of customer satisfaction to enhance customer loyalty. *African Journal of Business Management*, Volume 4(12), pp. 2385-2392.
- Jayasankaraprasad, C. & Kumar, P. V. V., 2012. Antecedents and consequences of customer satisfaction in food & grocery retailing: An empirical analysis. *Decision*, Volume 39(3), pp. 101-140.
- Keller, K., 1993. 1993. Conceptualizing, measuring, and managing customer-based equity. *Journal of Marketing* 57, no. 1: 1-22., Volume 57(1), pp. 1-22.
- Khare, A., Parveen, C. & Rai, R., 2010. Retailer behavior as determinant of service quality in Indian retailing. *Journal of Retail & Leisure Property*, Volume 9 (4), pp. 303-317.
- Kim, H.-B. & Kim, W., 2005. The relationship between brand equity and firms performance in luxury hotels and chain restaurants. *Tourism Management*, Volume 26, pp. 549-560.
- Kim, Y.-E. & Lee, J.-W., 2010. Relationship between corporate image and customer loyalty in mobile communications service markets. *Africa Journal of Business Management*, Volume 4(18), pp. 4035-4100.
- Knox, S. D. & Denison, T. J., 2000. Store loyalty: Its impact on retail revenue. An empirical study of purchasing behaviour in the UK. *Journal of Retailing and Consumer Services*, Volume 7(1), pp. 33-45.
- Lim, K. & O'Cass, A., 2001. Consumer brand classifications: an assessment of culture-of-origin versus country-of-origin. *Journal of Product & Brand Management*, Vol. 10, No. 2, pp. 120-136. , Volume 10(2), pp. 120-136.
- Martenson, R., 2007. Corporate brand image, satisfaction and store loyalty: A study of the store as a brand, store brands and manufacturer brands. *International Journal of Retail & Distribution Management* 35, no. 7: 544-55., Volume 35(7), pp. 544-555.

- Nadiri, H. & Hussain, K., 2005. Perceptions of service quality in North Cyprus hotels. *International Journal of Contemporary Hospitality Management*, Volume 17(6/7), pp. 469-480.
- Oh, H., 1999. Service quality, customer satisfaction, and customer value: A holistic perspective. *International Journal of Hospitality Management*, Volume 18(1), pp. 67-82.
- Oliver, R. L., 1980. A cognitive model of the antecedents and consequences of satisfaction decisions. *Journal of Marketing Research*, Volume 17, pp. 460-469, p. 16.
- Parasuraman, A., Zeithaml, V. & Berry, L., 1985. A conceptual model of service quality and its implications for future research. *Journal of Marketing*, Volume 49(1), pp. 41-50.
- Parasuraman, A., Zeithaml, V. & Berry, L., 1988. SERVQUAL: A multiple-item scale for measuring consumer perceptions of service quality. *Journal of Retailing*, Volume 64(1), pp. 12-40.
- Parasuraman, A., Zeithaml, V. & Malhorta, A., 2005. E-S-QUAL: a multiple-item scale for assessing electronic service quality. *Journal of Retailing*, Volume 64(1), pp. 12-40.
- Sahin, S. & Baloglu, S., 2011. Brand personality and destination image of Istanbul. *An International of Tourism and Hospitality Research*, Volume 22(1), pp. 69-88.
- Sirdeshmukh, D., Singh, J. & B., S., 2002. Consumer trust, value, and loyalty in relational exchanges. *The Journal of Marketing*, Volume 66(January), pp. 15-37.
- Srivastava, K. & Sharma, N., 2013. Service Quality, Corporate Brand Image, and Switching Behavior: The Mediating Role of Customer Satisfaction and Repurchase Intention. *Services Marketing Quarterly*, Volume 13, p. 274-291.
- Sumaedi, S., Bakti, I. & Yarmen, M., 2012. The empirical study of public transport passengers' behavioral intentions: the roles of service quality, perceived sacrifice, perceived value, and satisfaction (case study: paratransit passengers in jakarta, indonesia). *International Journal for Traffic and Transport Engineering*, Volume 2(1), pp. 83-97.
- Tang, Y. et al., 2015. Toward a measure of Chinese hypermarkt retail service quality. *Total Quality Management*, Volume 26 (3), pp. 327-338.
- Wu, H., 2013. An empirical study of the effects of service quality, perceived value, corporate image and customer satisfaction on behavioral intentions in the Taiwan quick service restaurant industry. *Journal of Quality Assurance in Hospitality & Tourism*, Volume 14(4), pp. 364-390.
- Wu, J., Lin, Y. & Hsu, 2011. An empirical analysis of synthesizing the effects of service quality, perceived value, corporate image and customer satisfaction on behavioral intentions in the transport industry: a case of Taiwan high-speed rail. *Innovative Marketing*, Volume 7(3), pp. 83-100.
- Yuen, E. F. & Chan, S. S., 2010. The Effect of Retail Service Quality and Product Quality on Customer. *Journal of Database Marketing & Customer Strategy Management*, Volume 17(3), pp. 222-240.
- Yu, W. & Ramanathan, R., 2012. (2012) Retail service quality, corporate image and behavioural intentions: the mediating effects of customer satisfaction. *The International Review of Retail, Distribution and Consumer Research*, Volume 22(5), pp. 485-505.
- Zaibaf, M., Taherikia, F. & Fakharian, M., 2013. Effect of perceived service quality on costumer satisfaction in hospitality industry: Gronroos' service quality model development. *Journal of Hospitality Marketing & Management*, Volume 22(5), pp. 409-504.
- Zeithaml, V., Berry, L. & Parasurama, A., 1996. The behavioral consequences of service quality. *Journal of Marketing*, Volume 60(2), pp. 31-46.
- Zeithaml, V., Parasuraman, A. & Berry, L., 1990. *Delivering Quality Service*, New York: The Free Press.

## IMPORTANCE OF CULTURAL INTELLIGENCE IN INDIAN MANAGEMENT EDUCATION

Naik, Kasturi<sup>1</sup>; Bobade, Anita<sup>2</sup>

<sup>1</sup>MMS, Mumbai University's DES NMITD, SCSVMV University, India,

<sup>2</sup>MMS, Mumbai University's DES NMITD, India

### ABSTRACT

Advent of globalization, workforce mobility, and international projects are generating demands for culturally proficient employees. Education, training and development of these employees begin in the classroom (Van Dyne, Ang, Livermore, 2010).

The major purpose of this paper is to investigate whether management education plays an important role in developing cultural intelligence and the importance of cultural intelligence as a separate subject in final year (Master of Management Studies) MMS curriculum. Non parametric chi square test analysis is used to determine whether management education plays an important role in developing cultural intelligence with the respondents being 150 (Master of Management Studies) MMS final year students. For testing reliability of the questionnaire, Cron Bach  $\alpha$  is used followed by factor analysis to determine prominent factors to decide content of the syllabus of cultural intelligence. The respondents for the same are 50 (Human Resources) HR recruiters dealing with international recruitment. These results, coupled with the formal and informal discussions with institute faculties and global corporate managers, suggest that in general the (Master of Management Studies) MMS students have a strong understanding on why cultural intelligence is essential in an increasingly globalized business world, as well as an earnest desire to interact with other cultures. Though, students seem extremely driven to study about other cultures, the results indicate that many of the (Master of Management Studies) MMS students lack an in-depth knowledge of the values, beliefs, and practices of other cultures due to lack of a well defined curriculum on the subject of "Cultural Intelligence" (Rich, Lepine, & Crawford, 2010).

*Keywords: Cultural intelligence, Knowledge, Globalization, Training and Development, Education*

### INTRODUCTION

Thomas, Elron, Stahl, et. al (2008) outline Cultural Intelligence as a system of interacting knowledge and skills, coupled by cultural metacognition, that permits individual to adapt to, select, and form the

cultural aspects of their environment. Cultural intelligence is a multidimensional concept comprising mental (metacognitive and cognitive), motivational, and behavioral dimensions.

Interaction between any two individuals is an intercultural intelligence as culture is a pattern of learned behavior. Cultural intelligence refers to the flexibility to adapt effectively to new cultural settings (Imai, 2010). Researchers of cultural intelligence make an attempt of investigating the construct of cultural intelligence and why some individuals are more capable than others when they have to adapt to new cultural settings (Imai, 2010).

Though previous research perceived intelligence narrowly as the ability to resolve issues in educational context, there's currently increasing agreement that intelligence may be exhibited in places apart from the classroom (Sternberg and Detterman, 1986). This rapidly increasing interest in 'real world' intelligence includes intelligence that focuses on specific content domains such as social intelligence, emotional intelligence and practical intelligence (MacNab, B., Brislin, R., and Worthley, R., 2012). Cultural intelligence takes into account the sensible realities of globalization (Earley and Ang, 2003) and focuses on a selected domain – intercultural context. Thus, following Schmidt and Hunter's (2000) definition of general intelligence, cultural intelligence could be a specific style of intelligence centered on capabilities to understand reason and behave effectively in context characterized by cultural diversity. In current international economy, human resource professionals, managers and staff operate with individuals from a range of cultural backgrounds daily. Several employees witness uncomfortable and ambiguous situations on a frequent basis. For example: You're conversing with an individual from a different culture, and he doesn't have an eye contact with you. Is it a cultural difference or a personal whim? How do you know, and how do you tackle it? (McCray, 2012).

Success in such context needs a novel set of abilities known as cultural proficiency. Organizations and managers generally dismiss cultural proficiency as a combination of indefinable soft skills that cannot be quantified or instructed. However that's not the scenario (Livermore, 2010). These proficiencies can be developed, and variety of intercultural models and inventories exist that may facilitate the learning (Smith, 2014). This research is centered on *cultural intelligence (CQ)*, a novel, research-based approach for operating effectively globally.

The major objective of this paper is to investigate the importance of cultural intelligence as a separate subject in final year MMS curriculum. This paper has utilized the Cultural Intelligence Scale (CQS) – metacognitive, cognitive, motivational, and behavioral – to capture data from MMS students and HR managers dealing with international recruitment with reference to need of developing a new subject of Cultural Intelligence with respect to final year. Overall, there are four Cultural intelligence capabilities: Drive, Knowledge, Strategy and Action. Cultural Intelligence drive is the motivational



dimension of cultural intelligence, measuring the level of interest, drive and energy required to adapt cross-culturally. Cultural Intelligence Knowledge is the cognitive dimension of cultural intelligence, with reference to knowledge about culture and its role in shaping interactions and work. Cultural Intelligence Strategy is the metacognitive facet of cultural intelligence, quantifying a person's ability to strategize throughout the process of operating globally (Livermore, 2010). Cultural Intelligence Action, the behavioral dimension of cultural intelligence, is the ability to *act* appropriately in a variety of intercultural context and effectively accomplish goals.

## LITERATURE REVIEW

Cultural intelligence (CQ) is a blend of cultural, social, and individual undercurrents that takes place in cross-cultural context (Ang, Livermore, & Van Dyne, 2010). Cultural intelligence is widely mentioned these days particularly in those global corporates which are engaged in international projects and expatriation as expatriate act and cross-cultural adaptation are identified as challenging areas for such organizations (Ng, Van Dyne, & Ang, 2009).

### *The concept of cultural intelligence*

Cultural intelligence is comprised of many dimensions and made up of four components; meta-cognitive, cognitive, motivational, and behavioural component (Ang et al, 2007).

Meta-cognitive dimension of CQ represents cognition part, i.e. gaining and understanding of awareness about other culture (Ang et al., 2007). It basically includes the cognitive strategies that are used to obtain and create coping strategies (Ng & Earley, 2006). It enables in structuring and strategizing plans for culturally diverse situations (Van Dyne, & Livermore, 2010). It takes into account whether an individual can utilize his/her cultural awareness to make strategic decisions, it also considers how cultural differences influence individual's behavior. It emphasizes on deciding on how to prepare groundwork for cross-cultural meetings by approaching people, situation, topic (Van Dyne, Ang, Livermore, 2010, pp. 7). This dimension enables to adapt and adjust activities of communication strategy from understanding cultural issues to estimating the actions taken and improving strategy in a long-time perspective (Earley, Peterson, 2004).

Cognitive factor is composed of knowledge regarding norms, practices, and conventions of other cultures, which can be acquired through educational and personal experiences (Ang et al., 2004; Ang et al., 2007). It is one of the important dimensions as individual's thought processes are highly influenced by the knowledge they gain about the other culture. Thus individual with high level of cognitive CQ are generally able to understand the similarities and differences exist in other cultures.

The Motivational (Drive) factor is based on showing the interest, confidence and *drive* to adapt to cross-cultural environment. It does not consider the premise that individuals are all naturally motivated to learn about cultural issues (there's always the risk of resistance). There are different levels of motivation: Intrinsic where individual is motivated from within and has a natural inclination to learn about cross cultural components. Extrinsic means motivation of the individual is linked to external events or tangible benefits like praise, appreciation etc. Both are important to achieve success at international front. Self-Efficacy is the self-reliance that individual is able to perform effectively in cross-cultural encounters (Van Dyne, Ang, Livermore, 2010, pp. 4-5).

The Behavioral (Action) factor exemplifies *action component* as the ability to appropriately adapt verbal and non-verbal communication to a cross-cultural context. It takes into consideration individual's knowledge when these actions need to be taken and when not so it shows the flexibility and the highest level of cultural awareness (Van Dyne, Ang, Livermore 2010, pp. 8). In other words, behavioral intelligence focuses on what individuals do rather than what their thought process is or what they feel. It is vital because it exposes the primary attributes of maintaining a relationship (Earley, Mosakowski, 2004).

#### *Management education and cultural intelligence*

Experiential Learning Theory pronounces learning as a process and highlights the importance of experiential learning rather than focusing only on knowledge acquisition. As per experiential learning theory, learning comprises of four stages, experiencing, reflecting, thinking and acting. When an individual's attempt fail, s/he uses the feedback to formulate new strategies to correct behavior. According to Knight (2003), individuals differ in the extent to which they translate experience into positive outcomes. It is acknowledged that individuals who more effectively utilize the four stages of experiential learning will process more insightful experience from their international assignments. The individuals with higher Cultural intelligence dimension are more effective learners and in turn produce more positive outcomes from global assignments. Ng et al. (2009) proposed all-inclusive model incorporating the four dimensions of Cultural intelligence and the four stages of Experiential Learning Theory. Based on this integration as a base model this research paper aims to investigate by means of factor analysis the components which can form the part of the subject of "Cultural intelligence" proposed to be introduced for MMS final year students to introduce the students to cross cultural norms, values etc.

*Management education in India*

In India multiple committees on management education have recommended areas of improvements. Significant change is not reflected in management education yet except in the top ranking B-schools. It is essential to investigate and address the important components related to management education in India which will enable the corporate to optimally utilize the demographic dividend provided by our country. The important components include focus on quality of faculties, promotion of faculty development programs, facilitating research, developing evaluation systems based on individual and team appraisals, strict corporate governance of all the management institutes, focus on institute-industry interface and developing global mindset. This paper focuses on using management education to develop cultural intelligence a means to create global mindset by means of internationalization of management education.

*Emotional intelligence*

Although globalization has made the world seem smaller and 'flat' in many ways (Friedman, 2005), increasing cultural diversity creates challenges for individuals and organizations, making the world 'not so flat' after all. Earley and Ang (2003) developed the construct of cultural intelligence and Cultural Quotient(CQ). CQ is a multidimensional construct targeted at situations involving cross-cultural interactions arising from differences in race, ethnicity and nationality. (Earley and Ang, 2003; Ang and Earley, 2006). Cultural intelligence primarily examines individual's capability to adapt effectively in new and unfamiliar cultural settings and perform effectively in such culturally diverse situations (Earley, 2002; Ang et al., 2007). This cross-cultural competence construct is analogous in comparison to the emotional intelligence construct (Earley&Mosakowski, 2004). It is a new corresponding type of intelligence, which explains variability in coping and functioning with culturally diverse scenarios.

Salovey and Mayer coined the term "emotional intelligence" in 1990 (Salovey and Mayer, 1990). They were cognizant of the preceding studies on non-cognitive parameters of intelligence and they described emotional intelligence as "a form of social intelligence that involves the ability to monitor one's own and others' feelings and emotions, to discriminate among them, and to use this information to guide one's thinking and action" (Salovey and Mayer, 1990). Emotional intelligence can be seen to be a pre-requisite for cultural intelligence.

*Role of management education in developing cultural intelligence*

In today's fast paced world, management students seldom withstand one 'job for life' and are progressively employed by, global organizations while competing in a world job market (Koster, 2010,

pp. 8). On the same terms, competition for positions in India requires management students to not solely be competitive against international candidates but to be able to work effectively and achieve success in a multi-cultural environment (Brünnemann, 2013, pp. 4). The management students therefore need the knowledge, skills, attitudes, and professional networks to undertake a successful career; together with the ability to work across cultures and nations. In short, the management students need the ability to be global citizens that can influence the world for the better.

Cultural intelligence (CQ), outlined as an individual's capability to operate and manage effectively in culturally diverse settings, is according to Schmidt and Hunter's (2000, p. 3) definition of general intelligence as 'the ability to grasp and reason correctly with abstractions (concepts) and solve problems.' Though previous research perceived intelligence narrowly as the ability to resolve issues in educational context, there's currently increasing agreement that intelligence may be exhibited in places apart from the classroom (Sternberg and Detterman, 1986). This rapidly increasing interest in 'real world' intelligence includes intelligence that focuses on specific content domains such as social intelligence, emotional intelligence and practical intelligence (MacNab, B., Brislin, R., and Worthley, R., 2012). Cultural intelligence takes into account the sensible realities of globalization (Earley and Ang, 2003) and focuses on a selected domain – intercultural context. Thus, following Schmidt and Hunter's (2000) definition of general intelligence, cultural intelligence could be a specific style of intelligence centered on capabilities to understand reason and behave effectively in context characterized by cultural diversity. In current international economy, human resource professionals, managers and staff operate with individuals from a range of cultural backgrounds daily. Several employees witness uncomfortable and ambiguous situations on a frequent basis. For example: You're conversing with an individual from a different culture, and he doesn't have an eye contact with you. Is it a cultural difference or a personal whim? How do you know, and how do you tackle it? (McCray, 2012).

Success in such context needs a novel set of abilities known as cultural proficiency. Organizations and managers generally dismiss cultural proficiency as a combination of indefinable soft skills that cannot be quantified or instructed. However that's not the scenario (Livermore, 2010). These proficiencies can be developed, and variety of intercultural models and inventories exist that may facilitate the learning (Smith, 2014). This research is centered on *cultural intelligence (CQ)*, a novel, research-based approach for operating effectively globally.

Advent of globalization, workforce mobility, and international projects are generating demands for culturally proficient employees. Education, training and development of these employees begin in the classroom (Van Dyne, Ang, Livermore, 2010). Thus this research focuses on survey of 150 students pursuing final year MMS course from management institutes located in Mumbai, financial capital of

India and 50 HR managers dealing with international recruitment with two major objectives. The first one being investigation of the significance of management education in developing cultural intelligence and second one focusing on development of contents with respect to introduction of Cultural intelligence subject in final year of MMS course.

### *Research Gap*

After taking into consideration the above mentioned literature highlights on cultural intelligence (Ang et al, 2007), this research focusses on two dimensions important for cultural intelligence –emotional intelligence and physical endurance as essential components. Limited research is done in India with respect to introduction cultural intelligence as a subject in MMS final year curriculum. The research paper makes an attempt to fill in above mentioned research gap.

## RESEARCH HYPOTHESIS AND MODEL

### *Research Models related to Cultural Intelligence and Management Education*

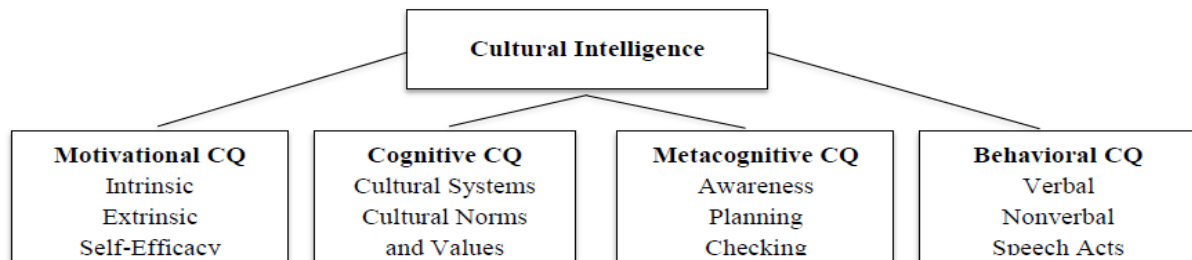

Source: Ang, Van Dyne, et. all, 2012

*Figure 1: Four Factor Model of Cultural Intelligence*

Ang, Van Dyne and Livermore (2012) provide some insight into how cultural intelligence develops. They suggest that metacognitive factor is important to strategize the development of cultural intelligence. Cognitive factor enables to imbibe the knowledge with regards to norms, values, rules, regulations etc. with respect to cultural intelligence domain. Motivational Cultural intelligence provides blend of intrinsic and extrinsic motivation required along with the essence of self-efficacy to learn about cultural differences. Behavioral factor focusses on activities involved while dealing in cross cultural context. Questionnaire development for the research paper is based on this model (Ang, Van Dyne and Livermore, 2012) with addition of two important dimensions from the researcher end physical endurance and emotional intelligence.

Following table gives insight into research questions, objectives, hypothesis and tools used

Sr.No	Research questions	Research Objectives	Hypothesis	Tools Used
1	Do management education play significant role in developing cultural intelligence among MMS students	To investigate the significance of role of management education in developing cultural intelligence among MMS students	Hypothesis 1 H <sub>0</sub> :Management education does not play significant role in developing cultural intelligence among MMS students	Non parametric chi square test
2	Which factors are prominent to describe contents of the syllabus of cultural intelligence?	To investigate the factors that are prominent to describe contents of the syllabus of cultural intelligence	Hypothesis 2 H <sub>0</sub> : There is no internal consistency and reliability among the variables selected in the study for conducting factor analysis focusing on contents of the syllabus of cultural intelligence	Factor Analysis

Table 1: *Research questions, objectives, hypothesis and tools used*

## RESEARCH METHODOLOGY

Research is an academic activity and as such the term should be used in a technical sense. According to Clifford Woody (1927 pp172), research comprises defining and redefining problems, formulating hypothesis or suggested solutions; collecting, organizing and evaluating data; making deductions and reaching conclusions; and at last carefully testing the conclusions to determine whether they fit the formulating hypothesis. Further, D. Slesinger and M. Stephenson in the Encyclopedia of Social Sciences, ( 1930 page 54), define research as “the manipulation of things, concepts or symbols for the purpose of generalising to extend, correct or verify knowledge, whether that knowledge aids in construction of theory or in the practice of an art.” Thus, research is, an original contribution to the existing stock of knowledge making for its advancement. It is the pursuit of truth with the help of study, observation, comparison and experiment. In short, the search for knowledge through objective and systematic method of finding solution to a problem is research. The systematic approach concerning generalization and the formulation of a theory is also research.

### *Research Philosophy*

A research philosophy is a belief about the way in which data about a phenomenon should be gathered, analyzed and used. The term epistemology (what is known to be true) as opposed to doxology (what is believed to be true) encompasses the various philosophies of research approach.

The purpose of science, then, is the process of transforming things *believed* into things *known*: doxa to episteme. Two major research philosophies have been identified in the Western tradition of science, namely positivist (sometimes called scientific) and interpretivist (also known as antipositivist) (Galliers, 1991).

A large number of research methodologies have been identified, Galliers (1991) for example listed fourteen, while Alavi and Carlson (1992), reported in Pervan (1994), use a hierarchical taxonomy with three levels and eighteen categories. In Table 5.1 below, there is a list of methodologies identified by Galliers (1991, p.149), indicating whether they typically conform to the positivist or interpretivist paradigms. This research uses a positivist approach focusing on survey.

SCIENTIFIC/ POSITIVIST	INTERPREVITIST /ANTI POSITIVIST
Laboratory Experiments	Subjective/ Argumentative
Field Experiments	Reviews
Surveys	Action Research
Case Studies	Case Study
Theorem Proof	Descriptive / Interpretative
Forecasting	Future Research
Simulation	Role Play

Table 2. *Various research methodologies*

Source: Galliers(1991)

#### *Research Design*

The type of research conducted is quantitative and explanatory in approach. Explanatory studies look for explanations of the nature of certain relationships. Hypothesis testing provides an understanding of the relationships that exist between variables.

#### *Data collection method*

The 1<sup>st</sup> questionnaire focusing on understanding the significance of management education on developing cultural intelligence comprises of 10 items (Van Dyne, 2010).

The 2<sup>nd</sup> questionnaire consisted of CQS (Ang et al. (2007), with 10 items covering the four dimensions of CQ: metacognitive CQ items, cognitive CQ items, motivational CQ items and behavioral CQ focusing on syllabus components of cultural intelligence. All CQS items were measured on seven-point Likert scales, ranging from 1 (“strongly disagree”) to 7 (“strongly agree”).

#### *Sample design*

Participants included 150 MMS students of final year and 50 HR managers dealing with international recruitment selected by means of convenience sampling from Mumbai financial capital of Mumbai. Questionnaires were distributed, accompanied by a letter emphasizing the confidentiality and anonymity of responses. The study was conducted during 2016-2017

#### *Tools for data collection*

Non parametric chi square test analysis is used to determine the significance of role of management education in developing cultural intelligence.

For testing reliability of the questionnaire Cron Bach  $\alpha$  is used followed by factor analysis to determine prominent factors to decide content of the syllabus of cultural intelligence.

#### *Data Analysis and Interpretation*

The results of the statistical analysis, coupled with the formal and informal discussions with institute faculties and global corporate managers, suggest that in general the MMS students have a firm understanding on why cultural intelligence is essential in an increasingly globalized business world, as well as a strong desire to interact with other cultures. However, although students seem extremely driven to study about other cultures, the results indicate that many of the MMS students lack an in-depth knowledge of the values, beliefs, and practices of other cultures due to lack of a well defined curriculum on the subject of "Cultural Intelligence"( Van Dyne et.al 2010).

#### *Role of Management education in developing cultural intelligence*

	Awareness	Adapt	Norms	Legal	Motivation	Verbal	Nonverbal	Physical	Exposure	SM
Chi-Square	33.307a	36.853a	35.547a	32.840a	29.573a	39.933a	25.373a	60.160b	38.067a	43.573a
Df	6	6	6	6	6	6	6	5	6	6
Asymp. Sig.	.000	.000	.000	.000	.000	.000	.000	.000	.000	.000

Table 3. Management education and cultural intelligence

#### *Interpretation (table 3)*

I can be seen from the table 3 that the significance (0.00) is less than the assumed value (0.05). So  $H_0$  is rejected and alternate hypothesis is accepted. This means that management education play a significant role in developing cultural intelligence.

#### *Components of Cultural intelligence*

#### *Cronbach Alpha ( $\alpha$ ) (Cultural Intelligence)*



Cronbach Alpha ( $\alpha$ ) is calculated as a measure of internal consistency. Alpha is calculated on the same scale as a Pearson (r) correlation coefficient which varies between 0 and 1. The closer the value of  $\alpha$  to 1, the greater the internal consistency of items in the instrument being assessed.

Cronbach's Alpha	N of Items
.718	10

Table 4 . *Reliability Statistics*

It can be observed from the Table 4, the value of Alpha ( $\alpha$ ) is 0.718. We can conclude that the variables are having high internal consistency and hence these variables are considered to be suitable for conducting factor analysis

	Initial	Extraction
Physical	1.000	.943
EI	1.000	.935
Motivational	1.000	.890
Cognitive	1.000	.832
Meta	1.000	.943
Behavioral	1.000	.935
Legal	1.000	.408
Verbal	1.000	.636
Nonverbal	1.000	.897
SM	1.000	.821

Based on the table graph which is Plot is plotted to of factors which is analysis.

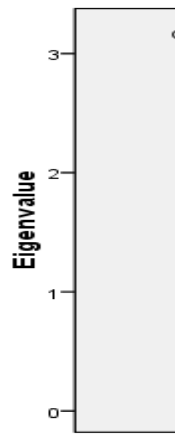

Extraction Method: Principal Component Analysis.  
Table 5. Communalities

	Component		
	1	2	3
Physical	.149	.880	.149
EI	.855	.067	.168
Motivational	.608	-.265	-.497
Cognitive	.378	-.455	.525
Meta	.149	.880	.149
Behavioral	.855	.067	.168
Legal	.343	.528	.045
Verbal	.667	.040	-.053
Nonverbal	.671	-.082	-.548
SM	.359	-.546	.445

Extraction Method: Principal Component Analysis.

a. 3 components extracted.

Table 6. Component Matrixa

6, the following called as Scree know the number available in the

Graph 1. Scree plot for cultural intelligence

From the above graph of Scree plot 1, it can be concluded that the factors having the Eigen values more than 1 have to be considered. This study determines 3 factors.

Interpretation (From Table 6)

**From the Table 6 of Component Matrix, it can be seen that the three factors can be classified as follows:**

**Factor 1:**

Emotional Intelligence

Motivational Dimension

Behavioral Dimension

Verbal Communication

Non verbal Communication

**Factor 2:**

Physical Endurance

Metacognitive dimension

Legal and Economic Knowledge

**Factor 3:**

Cognitive dimension

So the cultural intelligence syllabus can focus on the above mentioned factors devised by factor analysis method as these factors are highly significant for developing cultural intelligence.

The interpretation of the analyzed data for successful implementation of development of cultural intelligence among students is as follows:

The students' evaluation must items align with concepts, issues and events from the curriculum that are relevant to the development of cultural competency

It is essential to actively acknowledge the cultural heritage and home languages of international and Indian students and stimulate discussion, on-campus and/or virtually, of each other's culture and practice in connection to discipline and to exchange of knowledge and ideas;

Due importance should be given to both verbal and non-verbal communication.

It is essential to respect and understand the importance and significance of sacred days or religious holidays relative to Indian as well as international students on campus

Encouraging students and faculties to learn a second language to enable improved communication and to develop an awareness of the challenges of self-expression in languages other than English is essential for successful exchange programs

Providing motivation for students to complete a subject or short course in cross-cultural communication or perhaps an international studies subject is essential

Teaching practices encompassed should be culturally sensitive and actively discourage language or behavior that is racist or involves cultural stereotyping

Attention should be given first to the development of emotional intelligence and physical endurance of the students as a pre-requisite for the development of cultural intelligence.

## **FINDINGS, DISCUSSIONS AND IMPLICATIONS**

This is an era of globalization. Corporates needs managers with world-class talent. The issue is how to inculcate a global mindset through the managers who act locally. The survey Conducted by Andrews & Tyson brought out some issues like - In the ever evolving economic context at international level the important issue is to develop individuals with management & leadership capabilities on a world wide scale. The study shows that there has been a shift in Companies while recruiting from knowledge to skills attributes. In the current market scenario as the business is getting international, day by day there is an increasing need for the management institutions (B-schools) to focus on generating global

managers by means of internationalization of education. Taking this into consideration following are the implications of the study.

*Student exchange program should be promoted*

The business schools must admit international students and provide opportunities to their own students for international education exposure to the program. The Indian management institutes have limited international participation. Indian B-schools should collaborate with some well-known foreign B-schools by which Indian students can do part of their education in those institutes. Students who have exposure to an international short term program or exchange program usually improve their grades and are more likely to progress to further higher qualifications. Such students often describe the experience as 'lifechanging' and report an increase in their own soft skills, personal maturity and commitment to their chosen field of study. Hosting incoming exchange students contributes to campus culture and internationalization of the student body while inspiring the student community. The availability of a good international student exchange program, with participation strongly supported by the institution, has been shown to be a major factor in creating a brand name for the institute and students choice of university. Also participation in student's exchange program schemes increases the employability of students, a major reputational gain for any university, its students and the teaching faculties. Physical endurance dimension along with the other dimensions of cross cultural intelligence can be practically tested in the short term exchange programs of the students to get an perspective on support of physical health of the student in different climatic conditions and precautionary measures to be taken in case of emergency conditions.

*Faculty exchange program culture should be instilled*

The management institutes interested in developing culturally competent students should induct a few international faculties & provide an opportunity to the students to listen about other country's business culture & systems. The management institutions should also groom and provide opportunities to their faculties for exploring teaching assignments internationally. The presence of 'visiting' or exchange faculty program raises the global profile of the institutes, leading to enhanced international engagement which, in turn, assists in building a reputation and presence in international student recruitment markets. Teaching faculties accompanying students on an short term exchange program have the opportunity to build networks with international colleagues which can lead to the formation of research linkages and improved cross cultural networking opportunities.

*Introduction of cultural intelligence as a subject in curriculum*

To ensure success of student exchange program it is essential to add cultural intelligence as a subject in curriculum with focus on international economics, International Marketing, International Financial Management or international Business Management, emotional intelligence etc.

*Provide placement opportunities internationally*

Management institutes can also collaborate with some foreign placement consultancies to make sure at least some competent students can obtain jobs abroad (Saha, 2012). • Employers value the skills developed by participation in international exchange programs, including cross-cultural communication skills, personal maturity, the ability to adapt to cross cultural context and deal constructively with cultural differences in procedure and practice.

## **LIMITATION OF RESEARCH**

Limitation of this study is it is necessary to examine the caliber and aptitude of the faculties teaching cultural intelligence competencies to the MMS students. To deal with this limitation, future scope of this research can be to screen the faculty development programmes and investigate their significance with respect to increasing cultural intelligence of faculties.

## **SCOPE OF FUTURE RESEARCH**

Future scope of this research can be to screen the faculty development programs and investigate their significance with respect to increasing cultural intelligence of faculties. Longitudinal time series studies can also be conducted on different implications suggested by the researcher. Future research can also investigate the role of emotional intelligence in developing cultural intelligence. Future research can also focus on financial dimension of the exchange programs to be initiated for students and faculties.

## **CONCLUSION**

In the current globalized economy, where business is transnational, there is an increasing need for the management institutions (B-schools) to focus on generating global managers by means of internationalization of education. This includes providing students with international viewpoint of their discipline, providing the students with a cross-cultural understanding; information focusing on meta-cognitive, cognitive, motivational, behavioral, emotional and physical level for their future careers with respect to being successfully in diverse cultural context.”

Knowledge of cultures provides students with insights, skills and capabilities to deal with multi-cultural context and behave effectively in culturally diverse settings. Cultural intelligence (CQ) is an

capability to progress effectively and efficiently in culturally diverse settings when the main focus is differences in cross-cultural behaviors (Crawford, LePine and Rich et al., 2010). This skill is increasingly becoming beneficial for MMS students, as those who have high cultural intelligence can quickly adapt their management style in order to handle issues raised from multicultural background (concerning customers, suppliers, associates, etc.) (Kanfer et al., 2008).

## REFERENCES

- Ang S & Van Dyne L & Koh C & Ng KY & Templer KJ & Tay C & Chandrasekar NA 2007, 'Cultural intelligence: its measurement and effects on cultural judgment and decision making, cultural adaptation, and task performance', *Management and Organization Review*, vol.3, no.3, pp. 335-371.
- Ang S & Van Dyne L & Koh C & Ng KY & Templer KJ & Tay C & Chandrasekar NA 2007, 'Cultural intelligence: its measurement and effects on cultural judgment and decision making, cultural adaptation, and task performance', *Management and Organization Review*, vol.3, no.3, pp. 335-371.
- Ang, S, Livermore, D & Van Dyne, L 2010, 'Cultural intelligence: A pathway for leading in a rapidly globalising world, in M. Hannun, *Leading across Differences*, Pfeiffer, San Francisco.
- Ang, S, Van Dyne, L, Koh, C & Ng, KY 2004, 'The measurement of cultural intelligence', Paper presented at the 2004 Academy of Management Meetings Symposium on Cultural Intelligence in the 21st Century, New Orleans, LA, 23-24 August.
- Brislin, R., Worthley, R., & MacNab, B. 2006. Cultural intelligence: Understanding behaviors that serve people's goals. *Group and Organization Management*, 31: 40-55.
- Brünnemann, K., 2013. Thee Strategic Importance of Intercultural Competency for Project Managers in the 21st Century. Working Paper Series, University of Applied Sciences bfi Vienna, No 79.
- Crawford, ER, LePine, JA, and Rich, BL 2010, 'Linking job demands and resources to employee engagement and burnout: A theoretical extension and meta-analytic test', *Journal of Applied Psychology*, vol. 95, no.5, pp.834-848.
- Crawford, ER, LePine, JA, and Rich, BL 2010, 'Linking job demands and resources to employee engagement and burnout: A theoretical extension and meta-analytic test', *Journal of Applied Psychology*, vol. 95, no.5, pp.834-848
- Earley, E. C., Mosakowski, E., 2004. Cultural Intelligence, *Harvard Business Review* October, , pp. 139-146.
- Earley, P. C., Peterson, R. S., 2004. The Elusive Cultural Chameleon: Cultural Intelligence as a New Approach to Intercultural Training for the Global Manager. *Academy of Management Learning and Education*, 3(1), pp. 100-115.
- Earley, PC, & Ang, S 2003, 'Cultural intelligence: Individual interactions across cultures, Stanford University Press, Palo Alto.
- Earley, PC, & Ang, S 2003, 'Cultural intelligence: Individual interactions across cultures, Stanford University Press, Palo Alto.
- Goutam Saha, 2012 *Management Education in India: Issues & Concerns*, *Journal Information knowledge and research in business management and administration*, Volume 2, Issue 1, pp.35 to 40
- Imai L., Gelfand M. J., 2010. The Culturally Intelligent Negotiator: The Impact of Cultural Intelligence (CQ) on Negotiation Sequences and Outcomes, *Organizational Behavior and Human Decision Processes*, pp. 112.
- Kanfer, R, Chen, G and Pritchard, RD 2008, *Work motivation: Past, present, and future*, Lawrence Erlbaum, New York.
- Kanfer, R, Chen, G and Pritchard, RD 2008, *Work motivation: Past, present, and future*, Lawrence Erlbaum, New York.
- Knight, J. (2003). Updated internationalization definition. *International Higher Education*, 33, 2-3.
- Knight, J. (2004). Internationalization Remodelled: Definition, Approaches, and Rationales. *Journal of Studies in International Education*, 8, 5-31.
- Köster K., 2010. *International Project Management*. Heilbronn University: SAGE Publications Ltd.
- Livermore, D. 2010. *Leading with cultural intelligence: The new secret to success*. AMACOM Div American Mgmt Assn. Business book review.
- Livermore, D. 2010. *Leading with cultural intelligence: The new secret to success*. AMACOM Div American Mgmt Assn. Business book review.
- MacNab, B., Brislin, R., and Worthley, R. (2012), 'Experiential cultural intelligence development: context and individual attributes, *International Journal of Human Resource Management*, 23, 1320-1341.

- McCray, S. (2012). The Top 10 Problems with Outsourcing Implementation (and how to overcome them).
- Ng, KY, & Dyne, LV, Ang, S 2009, 'From experience to experimental learning: Cultural intelligence as a learning capability for global leader development', *Academy of Management Learning and Education*, vol.8, no. 4, pp: 511-526.
- Ng, KY, & Dyne, LV, Ang, S 2009, 'From experience to experimental learning: Cultural intelligence as a learning capability for global leader development', *Academy of Management Learning and Education*, vol.8, no. 4, pp: 511-526
- Ng, KY, & Earley, CP 2006, 'Culture and intelligence: Old constructs, new frontiers', *Group and Organization Management*, vol.31, no.1, pp. 4-19.
- Ng, KY, & Earley, CP 2006, 'Culture and intelligence: Old constructs, new frontiers', *Group and Organization Management*, vol.31, no.1, pp. 4-19.
- Ramalu, SS, Rose, RC, Kumar, N, and Uli, J 2010, 'Doing business in global arena: An examination of the relationship between cultural intelligence and cross-cultural adjustment', *Asian Academy of Management Journal*, vol.15, no.1, pp.79-97.
- Ramalu, SS, Rose, RC, Kumar, N, and Uli, J 2010, 'Doing business in global arena: An examination of the relationship between cultural intelligence and cross-cultural adjustment', *Asian Academy of Management Journal*, vol.15, no.1, pp.79-97.
- Rich, BL, Lepine, JA, Crawford. ER (2011), 'Job engagement: antecedents and effects on job performance', *Academy of Management Journal*, vol.53, no.3, pp.617-635.
- Salovey, P., & Mayer, J. (1990). Emotional intelligence. *Imagination, cognition, and personality*, 9(3), 185-211.
- Salovey, P., Mayer, J. D., Goldman, S. L., Turvey, C., & Palfai, T. P. (1995). Emotional attention, clarity, and repair: Exploring emotional intelligence using the Trait Meta-Mood Scale. In J. W. Pennebaker (Ed.), *Emotion, disclosure, and health* (pp. 125-154). Washington, DC: American Psychological Association.
- Schmidt, F. L., Hunter, J. E., 2000. Select on intelligence. E.A. Locke (Ed.), *Handbook of principles of organizational behavior*. Oxford, UK: Blackwell.
- Schmidt, F. L., Hunter, J. E., 2000. Select on intelligence. E.A. Locke (Ed.), *Handbook of principles of organizational behavior*. Oxford, UK: Blackwell.
- Sternberg, R.J., and Detterman, D.K. (1986), *What is intelligence? Contemporary viewpoints on its nature and definition*, Norwood, NJ: Ablex.
- Thomas, D. C., Elron, E., Stahl, G., Ekelund, B. Z., Ravlin, E. C., Cerdin, J. L., Lazarova, M. B., 2008. Cultural intelligence domain and assessment. *International Journal of Cross Cultural Management*, 8(2), pp. 123-143.
- Thomas, D. C., Elron, E., Stahl, G., Ekelund, B. Z., Ravlin, E. C., Cerdin, J. L., Lazarova, M. B., 2008. Cultural intelligence domain and assessment. *International Journal of Cross Cultural Management*, 8(2), pp. 123-143.
- Van Dyne, L., Ang, S., & Livermore, D., 2010. Cultural intelligence: A pathway for leading in a rapidly globalizing world. *Leading across differences*.

## RELATIONSHIP BETWEEN WORKFORCE DIVERSITY AND EFFECTIVENESS OF INDIAN BPO ORGANIZATION

Naik, Kasturi<sup>1</sup>; Bobade, Anita<sup>2</sup>

<sup>1</sup> University of Mumbai's DES NMITD, SCSVMV University, India

<sup>2</sup> University of Mumbai's DES NMITD, India

### ABSTRACT

Managing workforce diversity adds value and augments organization's effectiveness. The magnitude of diversity differs from country to country. While designing strategies for managing diversity, one has to study country-specific aspects and the socio-cultural landscape of the country. While studying the HR systems in India, one must appreciate that India is home to almost all religions of the world and presents in its people and races one of the most diverse congregations of cultures, dialects, castes, ethnicities and customs rarely matched by any other nation. This mystic and diverse culture has generated a set of challenges, which also makes its HR system unique (Rao and Verghese, 2009).

India is a very diverse country demographically as well as in terms of social and economic development. There is a significant difference in view of the social, cultural, economic and ecological diversity that is pervasive in India (Chaurasia A R, 2012). Constructed on Harrison, Price and Bell categorization of diversity dimensions, the demographic and socio-cultural diversity dimensions of India are categorized as visible, partially visible, partially deep and deep (Harrison et al; 2015). This paper contributes to existing knowledge on diversity management and strategic HRM in the Indian ITes sector. The purpose of this paper is to discuss vital diversity dimensions of India, and its implications for various organizational challenge with focus on ITes sector by means of case study approach.

This research paper focuses on multiculturalism and workforce diversity management with focus on ITes sector in India. In conducting the research, it quickly became clear that ITes sector took diversity and inclusion very seriously and that this was not limited to surface level diversity, but focused upon deep level diversity issues also like leadership skills, interpersonal skills, organizational commitment etc. and the connectivity between surface level and deep level diversity.

*Keywords: Diversity, Multiculturalism, Strategic HRM, India, commitment,*

### INTRODUCTION



India is a very diverse country demographically as well as in terms of social and economic development. There is a significant difference in view of the social, cultural, economic and ecological diversity that is pervasive in India (Chaurasia A R, 2012). Constructed on Harrison, Price and Bell categorization of diversity dimensions, the demographic and socio-cultural diversity dimensions of India are categorized as visible, partially visible, partially deep and deep (Harrison et al; 2015). This paper contributes to existing knowledge on diversity management and strategic HRM in the Indian ITes sector. The purpose of this paper is to discuss vital diversity dimensions of India, and its implications for various organizational challenges with focus on ITes sector by means of case study approach.

*Multiculturalism in India and its influence on Indian society*

Multicultural concerns have long informed India's history, traditions, constitution and political arrangements. Many writings on Indian history, culture and politics are marked by some kind of multicultural consideration. Even the recommendations of the successive Finance Commissions of India, to take an unusual example, show that the changing criteria for allocating resources to states accommodates the country's social and cultural diversity (Bhattacharyya 2001). India's constitution can be said to be a multicultural document in the sense of providing for political and institutional measures for the recognition and accommodation of the country's diversity. But multiculturalism as a term of scholarly discourse of society and politics in India is of a very recent vintage, originating in the 1990s when some scholars felt the need to respond with Indian experience to the global debate on the subject. The central question in any discussion of multiculturalism in contemporary India is how a vast, multi-ethnic country – in terms of religion, language, community, cast and tribe – has survived as a state in conditions of under development, mass poverty, illiteracy and extreme regional disparities. Given that many less diverse and plural postcolonial states have failed, what is the secret of India's success? Kohli (2001) argues that the question assumed added significance after the disintegration of the multiethnic former Soviet Union and its European empire in the early 1990s.

India and China are socially and culturally the most diverse in the world. Formed over thousands of years as a country of immigrants who brought their own cultures and traditions, India's diversity is huge. According to Kohli (2001) India, though predominantly inhabited by Hindus (over 82% of the population) who are regionally rooted, plural in beliefs and practices and divided by castes and languages, its population also includes a large proportion of Muslims (about 12%), Sikhs, Buddhists, Christians and Jains (Kohli, 2001). India is also linguistically diverse, being the home of some hundred languages and dialects – so far eighteen languages have been 'officially' recognised and placed under the eighth schedule of its constitution. However sizeable sections of the population, most notably in

the North-East, are yet share the privilege, despite their language comprising a majority in their locality (Kohli, 2001).

#### *Workforce Diversity*

India's diverse workforce largely depends on how well it is tactically managed for the effectiveness of organization. India is one of the diverse countries in the world. Its diversity aspects are rooted in the socio-cultural factors and emerging trends in demography. The diversity dimensions are discussed under two heads: socio-cultural dimensions and demographic dimension. Plurality and multiplicity characterize Indian society and culture. India has accommodated and assimilated various outside elements into its growing culture. However, it has never been a 'melting pot' in which all differences got dissolved and a uniform identity was created. India is a shining example of a 'salad bowl' in which different elements retain their individual identities and yet, together, they form a distinct recipe (Sharma, 2012).

## **LITERATURE REVIEW**

#### *Multiculturalism in India and its influence on Indian society*

In India most of the states have some dominant ethno-linguistic and ethno-religious groups (Punjab, Jammu and Kashmir in the North-East), although within each of them there are religious and linguistic minorities (Pandharipande, 2002). The fact that today most of the states of India correspond, by and large, to ethno-linguistic or ethno-religious groups has been achieved through a major reorganisation of territories in the 1950s and 1960s. Given that some kind of ethno-linguistic factor is the prime contributor in according statehood, scholars have tended to see the reorganisation as part of a multicultural state-building process in India (Pandharipande, 2002). This does not mean that each of the reorganised states is unilingual. On the contrary, states are multilingual and diverse. To a great extent the reorganisation process only simplifies the reality. But even throughout India today, linguistic minorities live under a state dominated, not just demographically but in other ways too, by a majority linguistic group. For example Tamil Nadu, one of the early major successes of linguistic (Tamil) sub-nationalism in independent India, had 3,975,561 Telegu speakers (representing 7.1% of the population) in 1991 and 1,208,296 Kannada speakers (2.2%) (Pandharipande 2002). Occasionally minorities speaking unrecognised languages have, with different degrees of success, demanded statehood (Weiner 1989: 45). Such demands have often been made by those linguistic groups mainly concentrated in a particular region of a state where the group has a strong sense of its distinctive identity. The success of such movements has depended on the strength of, amongst other factors, the political formulation of their demands in the eyes of the elites (Mitra and Lewis, 1998).

Given the wide range of variation as already described, it should be impossible to generalise about society, organisations and leaders in India, as it should for organisational and leadership practices in Indian organisations (Singh, 1990). Through his empirical research Singh studied Hofstede's five dimensions and concluded that they vary with age, level of education, size and level of organisation, industrial and economic sectors and the nature of job, location, etc.

A key finding of the study was the lesser use of power in highly industrialised locations. Another major finding was related to economic sector influences. On the power distance measure the scores for PSU, Indian private (Family Managed and Professional) and MNCs were 9, 22 and 0 respectively. On the uncertainty avoidance measure the scores for PSU, FMP and MNCs were 27, 57 and 39 respectively. On the individualism measure the scores for PSU, FMP and MNCs were 19, 6 and 31 respectively. On the masculinity measure the scores for PSU, FMP and MNCs were 33, 31 and 77 respectively. Decisions based on these findings can have a varying impact on the culture of a region. Singh opines that India, as a highly populous democracy and an important emerging economy, is seeking to modernise and transform its institutions without sacrificing its commitment to economic progress, socio-cultural heterogeneity and traditional social hierarchical values. Implicit to the concept of cultural effect is the notion that societies are considered to vary in terms of the arrangements which their institutions and organisations are composed of, and that these variations reflect their distinctive traditions, values, attitudes and historical experiences. In this regard, culture can be defined as the "crystallisation of history in the thinking, feeling and acting of the present generation" (Hofstede, 1993: 5). Bartlett and Ghoshal (1998) also suggest that the history, infrastructure, resources and culture of a nation state permeate all aspects of life within a given country, including the behaviour of managers in its national organizations.

#### *Workforce Diversity and Implications for effectiveness of HRM*

In spite of growing educational interest in diversity management, it has been taken into consideration that "diversity management" is a poorly understood, increasingly slippery, and controversial concept that is used "in an all-embracing fashion to include not just the social categories of AA [affirmative action] such as race and sex but a wide range of personal characteristics" (Ferner et al., 2005, p. 309). For this paper, we adopt the broad definition of diversity management Arredondo (1996) suggested and Wentling (2000) adopted: "diversity initiatives are defined as specific activities, programmes, policies, and any other formal processes or efforts designed to promote organizational culture change related to diversity"

It has been instructed that the aim of diversity management is for organizations to be aware of cultural differences; incorporate the ability to acknowledge, accept, and value diversity through organizational intervention to reduce configurations of inequality felt by those not in the majority; and transform

organizational culture and leadership practices so that “members of all socio-cultural backgrounds can contribute and achieve their full potential” (Cox, 1993, p. 225). Diversity management is treated as a better approach than equal opportunity (EO) as it “focuses on valuing people as unique individuals rather than on group-related issues covered by legislation” (CIPD, 2007, p. 6). In congruence with advocates of the importance of strategic HRM to organizational effectiveness, proponents of DM have justified that organizations committed to DM perform better than those that are not (Konrad et al., 2006). Indeed, existing studies have provided some proof to support the idea that strategic diversity management can result in increased HR productivity, such as attracting talent, retention (e.g., Ng & Burke, 2005).

Recent studies conjointly reveal a powerful correlation between diversity and monetary performance. Increasing diversity inclusion in organizations leads to win high talent and improve their client orientation, worker satisfaction, and decision making ability, resulting in a virtuous cycle of accelerating returns. As a result, ITes sector operational within India have long appreciated the requirement to secure these advantages for his or her staff and therefore the future success of their business.

There are many different types and meanings ascribed to the term diversity. Within the broadest sense, diversity is solely the visible variations between staff in age, gender, race, religion, sexual orientation and incapacity. However it's conjointly the variability of experiences and outlooks every individual worker can have. In this sense, diversity describes the popularity of those variations and, in doing therefore, celebrates them (Nishii et.al 2008).

## RESEARCH MODEL

*Harrison, Price and Bell Model and its implications on effectiveness of ITes Sector in India*

Harrison, Price and Bell model (1998) concentrates on two major types of diversities noteworthy in an organizational context, which every manager should take into account –

**Surface level diversity** is the differences that are easily evident such as age, gender, ethnicity/race, culture, language, disability etc. Surface level diversity is easy to be noted and managers/recruiters can fall into the malpractice of discrimination based

on these factors. For example, thinking that efficiency reduces with age, they might prefer younger employees. Surface level diversity is commonly tough to vary. For e.g. racial differences cannot be scaled down to zero (Harrison et al 1998)

**Deep level diversity** on the other hand, is not easily noticeable and noted since they are communicated through verbal and non-verbal behaviors over a period of time. Examples are individual variations in attitudes, value system, beliefs and personality. Deep level diversity usually starts with identifying surface level differences and when people gets to know each other, they starts noticing the deep level individual differences and have a tendency just to accept or dislike it. Many a times the surface level diversity like educational qualification may give clue to the deep level diversity also like organizational commitment or employee engagement etc. This paper is focusing on exploring this connectivity by the basis of case study model in ITes sector.

Diversity can have both negative and positive impact on work environment in the organization. Negative effects can include miscommunication, creation of barriers, and dysfunctional adaptation behaviors. Positive effects can include building a sound knowledge base with in-house talent, which can make for smoother integration of the organization into foreign cultures.

Diversity management provides strategic competitive advantage. Effectiveness which demands doing things right is an organizational performance factor (Unyimadu, 2006). Therefore, to effectively manage workforce diversity will enable to lower costs and improve employees' attitudes (Kreitner and Kinichi, 2004). Effectively managed employee diversity has a positive effect on corporate share and profits.

This is because employee diversity reflects consumer diversity (Kreitner and Kinichi, 2004). Researchers such as Richard, 2000 have revealed that workforce diversity promotes creativity, new ways of problem solving and productivity. Similarly, effective education whether full or part time enhances exposure, training and development.

#### *Kaleidoscope Perspective of the Individual*

Maier (2005) made a point that prior researchers on diversity have focused on limited dimensions and out of these, a few, such as ethnicity, race and gender, are over-emphasized. According to him, an individual can be modeled by a kaleidoscope. Just as a kaleidoscope contains definite amounts of

particles of varied shapes and colors, an individual is composed of various diverse attributes. The individual kaleido-scope can be characterized as a multi-colored pie chart, with each pie reflecting a unique attribute, and size of the pie illustrating the prominence that an individual gives to a particular attribute. On the basis of this viewpoint, Maier defines diversity as, “the variety of kaleido-scope.”

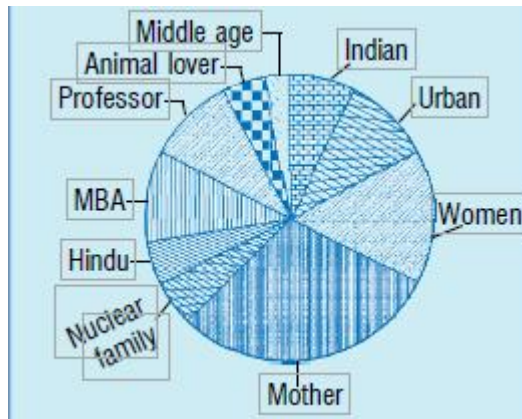

Figure 1: Example of Kaleidoscope compositions of an individual

Source: *Diversity at Workplace, HRM Review*

*Connectivity between Harrison, Price and Bell model and Kaleidoscope model*

Harrison, Price and Bell Model talks about surface level and deep level diversity on the other hand Kaleidoscope model talks about the individual kaleido-scope which can be represented as a multi-colored pie chart, with each pie reflecting a unique attribute, and size of the pie focusing the importance that an individual gives to a particular attribute.

One of the major aspects of the kaleidoscope is the surface level diversity which can be connected to the deep level diversity for example with respect to our case study educational qualification and organizational commitment.

According to Ferner et al. 2005, there is a strong relationship between educational level and organizational commitment. This research paper by means of case study model wants to examine if employees with high educational qualifications occupy higher ranks and therefore have more responsibilities which consistently require more commitment to the organization and that educational level may lead to high level of commitment. The employees with professional degrees can also enable to provide their expertise to process management and also enable ITes industries to have a positive brand image in the eyes of potential candidates.

## RESEARCH METHODOLOGY

Research philosophy is a belief about the way in which data about a phenomenon should be gathered, analysed and used. The term epistemology (what is known to be true) as opposed to doxology (what

is believed to be true) encompasses the various philosophies of research approach. The purpose of science, then, is the process of transforming things believed into things known: doxa to episteme.

There are two types of research methods – quantitative and qualitative. In contrast to the qualitative, quantitative research focuses on measurement and the analysis of causal relationships between variables rather than processes (Denzin and Lincoln, 2003). Quantitative research has five main methods, such as social surveys, experiment, official statistics, structured observations and content analysis (Silverman 2000). Both quantitative and qualitative methods are evaluated from different perspectives: quantitative research has been described as superior because it is considered objective and value-free, whereas the qualitative is claimed to be influenced by the researcher's subjectivity (Silverman, 2000). In certain cases researchers might share a sense of belonging to the ethno-national community and consider him/her to be an insider (Coffey et al.,1996), such as in the case of this research. Quantitative research has also been considered reliable, while in its crisis period qualitative research has been thought of as unscientific and explanatory (Denzin and Lincoln, 1994).

### *Research Methodology*

Researcher Robert K. Yin defines the case study research method, “ as an empirical inquiry that investigates a contemporary phenomenon within its real-life context; when the boundaries between phenomenon and context are not clearly evident; and in which multiple sources of evidence are used”. (Yin, 1984, p. 23).of complex issues. It can be considered a strong research method particularly when a holistic, in-depth investigation is required. It is also considered suitable in social sciences, when research deals with community based problems like poverty, illiteracy etc. It is one of the standard and accepted tool in many social science studies. (Gulsecen&Kubat, 2006). The paper uses case study as a research method to illustrate the diversity management in Business Process Outsourcing (BPO) MNC in India.

Case study research, through reports of past studies, allows the exploration and understanding of complex issues in a developing country like India. Qualitative case study is rich source of data and is an appropriate technique especially to answer “how” and “why” research questions. The data documented in the case study, has been collected using multiple sources and techniques namely research reports, newspaper articles, observation in various SISSO centers. SISSO is not just an organization, but a social movement and a revolution in India.

## **CASE STUDY**

Workforce diversity has become an important topic in today's organizations, as they are becoming increasingly diverse with respect to their workforce. Diversity exists in an organization when its

members differ from one another along one or more important dimensions (Thomas and Ely, 2001). Diversity should be thought of in terms of degree or level of diversity along relevant dimensions (Dora and Keith, 1998). In business terms, diversity can be defined as a set of differences of individual traits including socio- economic and demographic variables which are noticed both at the surface and deep level in an organization's various levels (Cox, 1991; Thomas, 1991). Surface level dimensions of diversity include age, ethnicity and culture, gender, race, religion, sexual orientation, and capabilities (Das, and Wagar, 2007). Deeper level dimensions include values, attitudes, leadership styles and adaptability of employees to changing business environment and business challenges. education, status, language, income levels, etc. Diverse workforce (diversity) refers to the co-existence of people from various socio-cultural backgrounds within the company. Diversity includes factors such as race, gender, age, colour, physical ability, ethnicity, etc. (Kundu and Turan, 1999).

The Indian information technology industry is playing a key role in putting India on the global map. The merits of the workforce diversity has been debated everywhere throughout the world. Workforce diversity and management is on the emerging trend in Indian organizations. Diversity Management has already begun in the Indian IT industry and numerous companies have multiple locations abroad and are realizing the need to develop a global workforce. The need of the talent mix pressurizing the employers of IT companies to attract and to retain diverse workforce. Employers are being urged to embrace diversity and advised against neglecting it. Management scholars warn that while organizations may run the risk of losing their competitive advantage and innovativeness by failing to effectively utilize and manage diversity. The projected changes in organizational demographics combined with employers' concerns about motivating and obtaining satisfactory levels of performance from a diverse group of employees has created an urgency to understand and recognize the value of diversity in all organizations. IT industry is one of the major industries in India, which has embraced workforce diversity as a strategy to remain competitive, innovative and productive in the face of changing demographics and the rapid globalization of business.

#### *Syntel Mumbai - Empowering Diverse Human Assets – Case Study*

Syntel has been defined by evolution and innovation, since 1980. From pioneering the global delivery model to implementing the latest digital solutions, Syntel has expanded its geographic footprint, adapted our services, and evolved our core business model to stay ahead of industry and technology trend. Syntel, is headquartered in Michigan, USA having over 30 offices abroad including India and a staff strength of over 22,000 employees and the Mumbai office has about 4,500 employees.

Mumbai is experiencing rapid growth and is one of the financial capital of India. By the fiscal year 2020-21, its GDP per-capita at PPP is expected to reach US \$23,000, making it south Asia's richest city.



Regarding its IT and ITeS-BPO firms and hubs, Mumbai ranks as the second most favoured destination globally for ITeS-BPO services, next only to Bengaluru or the Silicon Valley of India, according to 'Tholons Top 100 Outsourcing Destinations 2013'. It enjoys a cosmopolitan culture and is home to all the religions and regions of the world. Hinglish is a colloquial spoken English language and the 1750 year old University of Mumbai – and over 0.1 million graduates graduating every year and equal amount of engineers, graduating each year from this coveted Indian university.

Syntel has employed 30% of its workforce in Mumbai is in the age group 18-25 years. Further, 40% are female employees. More than 5% of employees are from economically backward sector of society and 58% of the employees are from Tier II and Tier III cities (This classification is based on population less than 1 million. Also the company of employing about 5% differently abled employees, as their corporate social responsibility.

The main talent management challenge for a BPO career includes, negative employment image and social stigma attached to this industry. Suggested below mentioned model documents diversity management and inclusion of professionals in Indian BPO industry.

## PROPOSED MODEL, FINDINGS, DISCUSSIONS AND IMPLICATIONS

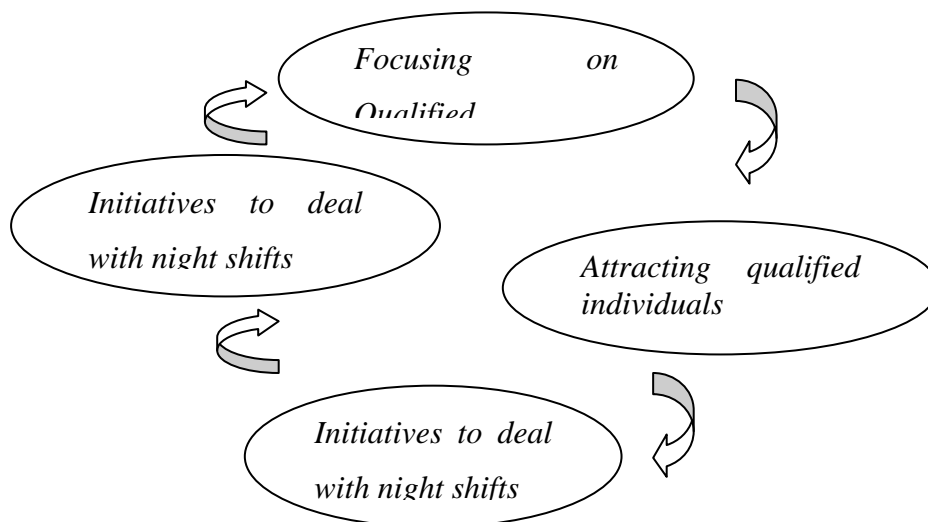

Figure 2: Steps to include diversity in organization

*Steps to include diversity at the workplace*

*Focusing on qualified individuals*

The perception of the employee about the BPO has to change from being a life style to a career option and diversity inclusion by means of establishing connectivity between educational qualification and organizational commitment can enable the same. One way of doing this is to re-construct the organization structure. The chances to climb the corporate ladder should be made to look bright. Some modification done to this corporate ladder in increasing the number of levels, can give a prospective

picture to the path ahead for a call center agent, and also will aid to change the perception from life style to career, which will control attrition to a reasonable extent.

The BPO industry can work in tandem with the government so that it can start educational institutions on the line of BPO requirement and ensure steady and uninterrupted skilled manpower that will not only keep attrition at bay, but also keep the Indian BPO industry far ahead of its competitors.

*Attracting qualified individuals and designing individual career paths*

Organizations should concentrate on individual career growth of employees and succession planning in the organization. Planning for growth both vertically and horizontally can bring a little reprieve to the employees. For eg. Horizontal growth can be in the form of promoting the employee from simple to more complex processes within the organization. This will enhance the learning of the employee and make him "feel-good". A proper career graph should be charted out with the due consideration to the growth and development of an employee. Promotion with enriched and new title to a job should be laid down in the HR Practices of Industry. So that he/she thinks twice and thrice before switching.

*Build brand name by streamlining corporate culture*

BPO is not considered as a career option by professionals as there is a social stigma attached to it. BPO career includes late night shifts, unhealthy lifestyle, burnout syndrome, and vices, hence there is a need for brand building. BPO firms would do well by defining a concrete corporate hierarchy thereby setting the tone for a proper career path for every employee in the organization. Empowering qualified individuals and creating job diversity is essential to retaining staff in a BPO firm for as long as possible. A career-oriented, valued employee must experience growth opportunities within the organization. This will also lead to process improvement and provide brand name to the BPO which is much required in ITes sector. B

*Initiatives to deal with Night Shifts*

Different initiatives that can be taken by BPO'S to deal with night shifts include -

Have people from other walks of life to talk about their experiences. Other professions like Army, Medicine, and shop floor workers also have to work in night shifts. Have doctors to advise & guide them about their biological clocks and ways & means to deal with them. Dietary advice with regards to do's and don'ts can be given. Create the passion that they are doing a yeomen service to the nation by bringing the much-required Foreign Exchange. They are helping people (clients) to make their life easier. Special lights in the office/workplace to ensure their bodies get sufficient vitamin D. One distinct disadvantage of night shifts is the sense of disorientation with friends and family members. Concentrate on this problem and develop innovative solutions and ways to deal with it.

## LIMITATION OF RESEARCH

The study is limited to the Metro City of Mumbai the Financial Capital of India. Quantitative study can be done on predicting the relationship between surface level and deep level diversity of the individual followed by comparing it with the longitudinal studies to check the validity.

## SCOPE OF FUTURE RESEARCH

Quantitative study can be done on predicting the relationship between surface level and deep level diversity of the individual followed by comparing it with the longitudinal studies to check the validity. The study can be carried out in other sectors also to generalize the findings.

## IMPLICATIONS FOR EFFECTIVENESS OF HRM

With the dynamic demographics in today's employee base, employers are currently featured with new challenges in the workplace. The difficulty of recruiting and retaining a diverse workforce has become a dilemma for Human Resource departments. The composition of the labor force is changing with increasing numbers of women and individuals of diverse race, religion, caste entering the labor market.

Training and development is one of the HR functions that have seen the most impact through magnified levels of diversity in organizations. By means of development of diversity coaching and mentoring programs, Human Resource departments will be able to influence corporate culture, recruitment, compensation, and the performance of the organization's diverse workforce. Organization's that considers the ever-changing demographics of their labor force will remain competitive in today's market. With respect to diversity management the main role of HR should be to train and develop the diverse workforce with focus on employer and employee growth. The key mantra to successful diversity management is dedication by the HR department to create and foster a work environment which reflects respect and growth for all employees. *Strategically handling employee diversity is a value-adding HR function that augments organizational effectiveness.*

Increasing number of studies have developed in the last decade that examine diversity management practices at country and organizational levels (e.g., Dameron & Joffre, 2007; Sowell, 2002). These studies, though, often concentrate on Western countries. Limited studies have examined systematically the degree to which diversity management has been positioned as part of planned HRM across various ownership forms in a less developed country, where the approach to HRM may be less subtle and the diversity management framework may differ considerably from that in the West.

This research paper focuses on multiculturalism and workforce diversity management with focus on IT sector in India. In conducting the research, it quickly became clear that IT sector took diversity and inclusion very seriously and that this was not limited to surface level diversity, but focused upon deep level diversity issues also like leadership skills, interpersonal skills, organizational commitment etc. and the connectivity between surface level and deep level diversity.

## CONCLUSION

IT sector should develop a healthy long run relation with the possible stake holders which will be helping it uplift the image of industry. This will also enable brand building for the sector as it lacks the same. Diversity management provides strategic competitive advantage. This competence and advantage is generated from the process in which the management of diversity positively affects organizational behavior and effectiveness. So the IT industry can make use of diversity inclusion in terms of employing qualified individuals as shortfall of talented workforce coupled with a high attrition rate may have a crippling effect on the industry. Ability to arrest attrition, therefore, assumes strategic significance and can be used as a competitive advantage for long-term survival in the industry otherwise industry will be captured with shortage of human capital in coming years

## REFERENCES

- Arredondo P. (1996). *Successful diversity management initiatives: A blueprint for planning and implementation*. Thousand Oaks, CA: Sage.
- Barney, J., Wright, M., Ketchen, D.J. (2001), "The resource-based view of the firm: Ten years after 1991", *Journal of Management*, Special issue, Vol 27, pp. 625–641.
- Bhargava, R., Bagchi, A. and Sudharshan, R. (eds.) (1999) *Multiculturalism, Liberalism and Democracy*, Delhi: Oxford University Press.
- Bhattacharyya, H. (2001) *Federalism and Regionalism in India: Institutional Strategies and Political Accommodation of Identity*, <http://www.ub.uni-heidelberg.de/archiv/5500>.
- Chaurasia Aalok Ranjan. (2012). "Demographic diversity in India: Evidence from the provisional results of 2011 population census". *Journal of Geography and Regional Planning* Vol. 5(12), pp. 314-327, 30 June, 2012. Available online at <http://www.academicjournals.org/JGRP>. DOI: 10.5897/JGRP11.078
- CIPD (2007). *Diversity in business: A focus for progress*. London: CIPD.
- Cox, T. (1991), "Managing Cultural Diversity: Implications for Organizational Competitiveness", *Academy of Management*, Vol. 5 (3), pp. 45-56.
- Cox, T. (1993). *Cultural diversity in organizations: Theory, research and practice*. San Francisco: Barrett-Koehler.
- Dameron, S., & Joffe, O. (2007). The good and the bad: The impact of diversity management on co-operative relationships. *International Journal of Human Resource Management*, 18(11), 2037–2056.
- Diversity at Workplace (2009), *HRM Review*, pp. 37 - 39
- Ferner, A., Almond, P., & Colling, T. (2005). Institutional theory and the cross-national transfer of employment policy: The case of "workforce diversity" in US multinationals. *Journal of International Business Studies*, 36(3), 304–321.
- Harrison, D. A., Price, K. H., & Bell, M. P. 1998. Beyond relational demography: Time and the effects of surface- and deep-level diversity on work group cohesion. *Academy of Management Journal*, 41: 96 –107.
- Kohli A (2001) *The Successes of India's Democracy*, (ed.), Cambridge: University of Cambridge, (2001).
- Konrad, A., Prasad, P., & Pringle, J. (Eds.). (2006). *Handbook of work place diversity*. Thousand Oaks, CA: Sage.

- Kreitner, R., and Kinichi, A. (2004) *Organizational Behaviour*, Boston: McGraw-Hill.
- Kulik, A.M., C.T., Metz, I. (2011), "The gender diversity performance relationship in services and manufacturing organizations", *The International Journal of Human Resource Management*, Vol 22,(7), pp.1464-1482.
- Kundu, S C and Turan, M S, (1999). "Managing Cultural Diversity in Future Organizations", *The Journal of Indian Management and Strategy*, Vol. 4 (1), pp. 61-72.
- Meena Kavita (2015) "Diversity Dimensions of India and Their Organization Challenges: An Analysis". *IOSR Journal of Business and Management (IOSR-JBM)* e-ISSN: 2278-487X, p-ISSN: 2319-7668. Volume 17, Issue 7. Ver. II (July. 2015), PP 77.
- Maier Christoph (2005), "A Conceptual Framework for Leading Diversity", *Int.J. Human Resource development and Management*, Vol.5, No.4, pp.412-424.
- McKinsey & Company, *Diversity Matters*, November 2014
- Milliken, F. J., Martins, L.L. (1996), "Searching for common threads: Understanding the multiple effects of diversity in organizational groups", *Academy of Management Review*, 21, pp. 402-403.
- Ng, E., & Burke, R. (2005). Person organization fit and the war for talent: Does diversity management make difference? *International Journal of Human Resource Management*, 16(7), 1195-1210.
- Nishii, L., Lepak, D., & Schneider, B. (2008). Employee attributions of the "why" of HR practices: Their effects on employee attitudes and behaviors, and customer satisfaction. *Personnel Psychology*, 61(3), 503-545.
- Pandharipande, R.V. (2002) *Minority Matters: Issues in Minority Languages in India*, in *International Journal on Multicultural Societies* 4 (2).
- Rao, T. and Verghese, S. (2009) "Trends and Challenges of Developing Human Capital in India" in *Human Resource Development International* Vol. 12, No. 1, February 2009, pp.15-34
- Richard, O.C. (2000) *Racial Diversity, Business Strategy, and Firm Performance; A Resource Based View*, *Academy of Management Journal* Vol.43(2), pp.164-177
- Singh, J. (1990) *Managerial Culture and Work-related Values in India* in *Organization Studies* 1990 vol. 11 no. 1, pp. 75-101.
- Sowell, T. (2002, March 11). Those who gush about "diversity" never want to put their beliefs to the test. *The Enterprise*.
- Unyimadu, S.O. (2006). *Business Strategy*. Benin City: Harmony Publishers.
- Wentling, R. (2000). Evaluation of diversity initiatives in multinational corporations. *Human Resource Development International*, 3(4).

## LEAN INTERNATIONALIZATION OF BORN GLOBAL FIRMS

Neubert, Michael<sup>1</sup>; Van Der Krogt, Stijn<sup>2</sup>

<sup>1</sup>International School of Management (ISM), Paris, France

<sup>2</sup>Universidad Paraguaya Alemana (UPA), Asuncion, Paraguay

### ABSTRACT

This study examines the internationalization of high-tech start-up firms (HSF) from small and open economies (SMOPEC). It explores how HSF may differ in their speed of internationalization relying on information collected via interviews with the CEOs or founders of 32 HSF that operate internationally. It uses a comparative cross-national multiple case study research design to answer the research questions. The findings provide the basis for developing propositions for further comparative analyses of the early and fast internationalization of HSF based in emerging and developed markets. The study contributes to the literature on networks, internationalization and international entrepreneurship.

*Keywords: High-tech, start-up, small and open economy, early internationalization, fast internationalization, speed of internationalization, born global firm, Uppsala model, Lean internationalization, Paraguay, Switzerland*

### 1 INTRODUCTION

Early and rapid internationalization of high-tech start-up firms (HSF), particularly in the sense of born global firms (BGF) (Cavusgil & Knight, 2015; Coviello, 2015), is one of the topics that has attracted most attention in international entrepreneurship (e.g. Bailetti, 2012), yet is among the least researched.

One of the most important characteristics of the BGF is the rapidity and speed of internationalization soon after their incorporation (Acedo & Jones, 2007) and the development of their products and services (Neubert, 2015). So far, the international entrepreneurship field has placed more interest on the process of internationalization and in particular, on the distinct characteristics of firms that internationalize rather rapidly (Acedo & Jones, 2007) and not so much on the reasons for early and fast internationalization (Neubert, 2015).

Early and fast internationalization of BGF is considered as entrepreneurial and risk-seeking (Oviatt & McDougall, 2005). It is often associated with the ability, experience, and willingness of the entrepreneur (Hennart, 2013). Bacq & Coeurderoy (2011) and Verbeke, Amin Zargarzadeh, & Osiyevskyy (2014) found evidence that the entrepreneur went through the first phases of the Uppsala internationalization process model (Johanson & Valhne, 2009) before founding the new HSF.

BGF that internationalize early and fast are often HSF with innovative products and services, which operate in a small global market niche (Zucchella, Hagen, Denicolai, & Masucci, 2016; Andersson, Danilovic, & Huang, 2015). They have a higher probability to be located in a small and open economy (SMOPEC) (Luostarinen & Gabrielsson, 2006) with a limited home market potential (Andersson et al., 2015; Cannone & Ughetto, 2014). Due to its small size, HSF are often forced to internationalize early and fast to become profitable (Trudgen & Freeman, 2014). Hence, fast and early internationalization is highly significant (Neubert, 2016b), necessary for survival, and complex. The BGF has to manage innovation processes parallel to international market development with limited resources (Cavusgil & Knight, 2015; D'Angelo, Majocchi, Zucchella, & Buck, 2013; Lemminger, Limkilde Svendsen, Zijdemans, Stavnsager Rasmussen, & Tanev, 2014).

The notion of early and fast internationalization is still not well understood and requires additional research (Acedo and Jones, 2007). Neubert (2016b) and Ciravegna, Lopez, & Kundu (2014) called for research about location effects of HSF based in different economies of Europe and Latin America. In a comparative cross-national multiple case study research design, the results of a previous study about Swiss HSF (Neubert, 2016a) are compared with a sample of Paraguayan HSF. Even though both countries are landlocked SMOPEC with almost no natural resources and a similar population (seven respectively eight million), Paraguay is an emerging and Switzerland a developed economy.

## 2 LITERATURE REVIEW AND THEORETICAL FRAMEWORK

### 2.1. *The Uppsala internationalization process model*

In 1977, Johanson & Vahlne (2009) developed the Uppsala internationalization process model. Their first finding was that firms enter new foreign markets using a so-called *establishment chain* (Verbeke et al., 2014). In the first step of this gradual internationalization process, firms enter geographically and culturally closer markets (Cavusgil & Knight, 2015; Coviello, 2006; De Villa et al., 2015) with low-risk market entry modes, such as 'export', 'licensing' or 'franchising' in collaboration with a local partner (Neubert, 2016b). With growing international success and market knowledge, they increase their investments establishing for example a wholly owned subsidiary and gradually start to enter more distant foreign markets. Obviously, the level of resources dedicated to a foreign market might also decrease leading for example to a market exit (Neubert, 2011) or a disinvestment, if the market attractiveness is decreasing. Based on this framework, Paraguayan firms are expected to enter foreign markets like Bolivia and Brazil before they export to the European Union, and Swiss firms predominately export to neighboring EU member states like Germany, Austria, France, or Italy.

The second finding is the concept of liability of foreignness. Firms need a firm-specific advantage (FSA) in every new foreign market, which compensates at least for the liability of being a new foreign firm

without significant client relationships or sufficient market knowledge. The larger the geographical, administrative, economical, and cultural distance between the home and the foreign market, the larger is the liability of foreignness (Johanson & Vahlne, 2009) and the bigger the FSA needs to be. Local partners like distributors or resellers help to bridge these differences. The speed of internationalization depends on the speed of learning (Johanson & Vahlne, 2009) about every new foreign market. This means that the firm must be able to transfer its FSA to a sustainable and relevant competitive advantage in every new foreign market to cover the cost or the liability of foreignness (Johanson & Vahlne, 2009).

In 2009, Johanson & Vahlne (2009) revised the Uppsala internationalization process model and introduced the concept of liability of outsidership. This concept reflects the increasing importance of networks (Johanson & Vahlne, 2009; Coviello, 2006) and tries to explain the internationalization of BGF. As the main market entry barrier for BGF is the access to client networks and to market opportunities. Thus, the speed of internationalization depends on their ability to develop these local networks and market opportunities into a new client relationship.

According to Johanson & Vahlne (2009), the Uppsala model can also be applied to firms that start to internationalize soon after their birth like BGF (Cavusgil & Knight, 2015). A BGF, as defined by Cavusgil & Knight (2015), is a young firm that is active through early export sales (Cavusgil & Knight, 2015; Coviello, 2015). The market entry mode 'export' is also the first step in the establishment chain of the Uppsala model (Johanson & Vahlne, 2009).

### *2.2 A new type of firm – The born global firm*

Most empirical research on early and fast internationalization focus on HSF in the sense of BGF (Servantie, Cabrol, Guieu, & Boissin, 2016). A BGF (Cavusgil & Knight, 2015; Knight & Liesch, 2016) is a young firm that is active through early export sales (Coviello, 2015). Thus, the BGF concept focuses on a market-seeking internationalization strategy using for example a global exporter internationalization model (Neubert, 2013a). This is the link with the establishment chain of the Uppsala internationalization process model (Johanson & Vahlne, 2009). Both concepts focus on the market entry mode 'export' as a first step to enter a new foreign market. Further, the word 'global' in BGF should not be understood in the sense that BGF export immediately to all global markets. Often, BGF start to export to a limited number of the most attractive markets or to a region like for example a free-trade area (Coviello, 2015).

### *2.3 Early and fast internationalization*

In 2015, Cavusgil & Knight wrote that the internationalization of BGF might challenge the traditional Uppsala internationalization process model. According to Johanson & Vahlne (2009), the Uppsala



model can also be applied to firms that start to internationalize soon after their birth like INV (Oviatt & McDougall, 2005), LGS (Rasmussen & Tanev, 2015) and BGF (Cavusgil & Knight, 2015), because the speed of internationalization depends on the firms' ability to learn about new foreign markets and to adapt its FSA to the respective market needs. Due to advances in communication and transportation technologies and the emergence of global social networks (Coviello, 2015) even firms from traditional industries might internationalize faster and earlier.

Cavusgil & Knight (2015) developed a list with a number of drivers for fast and early internationalization. First, there are internal characteristics, which drive internationalization. Agile and adaptable HSF with profitable high quality products and services, and strong marketing and sales capabilities internationalize earlier and faster. Further, Cavusgil & Knight (2015) mention the abilities of the entrepreneur like international experience, the existence of a global vision, innovativeness (Casillas & Moreno-Menendez, 2014), or entrepreneurial and market orientation. Romanello & Chiarvesio (2016a; 2016b) point out the entrepreneurial capabilities like networking, opportunity creation (Zucchella et al. 2016), and product promotion play an important role during the early market entry stage (Neubert, 2016b). Thus, the ability to acquire new clients in new foreign markets is a required key competence for an international entrepreneur. Depending on the personality of the decision-maker and market conditions, the respective processes are well structured or rather unplanned (Nummela, Saarenketo, Jovela, & Loane, 2014).

#### *2.4 Influence of the location on the speed of internationalization*

Multiple authors call for further research about the effect of BGF's home country on the speed of internationalization (Knight & Liesch, 2016; Hitt, Li, & Xu, 2016), because findings from studies, which analyze the fast and early internationalization of high-tech firms from developed economies, are not necessarily transferable to emerging economies (Zander, McDougall-Covin, & Rose, 2015). So far, there is still little research focusing on BGF from EE (Gonzalez-Perez, Manotas, & Ciravegna, 2016). The existing studies of for example Musteen, Datta, & Butts (2014) and Ciravegna, Lopez, & Kundu (2014) emphasized the importance of social networks respectively the networking ability of the entrepreneur as driver for the speed of internationalization. Hitt et al. (2016) and Zucchella, et al. (2016) found out that the reputation of the home country and the quality of institutions also influence early and fast internationalization.

### **3 RESEARCH METHOD**

### 3.1 Research questions

The statement of the research problem has led to the following two research questions:

- *Research question 1.* What are the perceptions of subject matter experts about the significance of early and fast internationalization for high-tech firms?
- *Research question 2.* What are the perceptions of subject matter experts about how high-tech firms may differ in their speed of internationalization?

### 3.2 Method

The choice of the research method is based on the purpose of this study. This study uses a comparative cross-national multiple case study research design to answer the explanatory (= how/why) research questions (Yin, 2014). According to Hennart (2013), a qualitative comparative case study research would help to answer the research question. In contrast to an experimental design or a survey, a multiple case study has more flexibility (Stake, 2010), allows an in-depth analysis of a complex research problem (Yin, 2014) within a highly contextualized environment (Rosenberg & Yates, 2007), and a comparison between different cases and countries (Baxter & Jack, 2008). The primary source for data collection is qualitative, semi-structured, in-depth, face-to-face interviews with SMEs (Yin, 2014). The data of the Swiss sample was collected in July and August 2015. The data of the Paraguayan sample was collected in October and November 2016 using the same research design.

### 3.3 Sample

The choice of the sampling strategy is based on the purpose of this study. This study uses a purposive case selection strategy (Seawright & Gerring, 2008), because it produces a representative sample (Seawright & Gerring, 2008) with typical and successful examples of the total population. After a random sample (= probability sampling) is drawn from a database of Swiss and Paraguayan HSF (Zikmund, Babin, & Carr, 2012), the typical cases of the sample are selected (Seawright & Gerring, 2008). According to Eisenhardt (1989) and Yin (2014), this sampling strategy produces a statistically representative sample, if at least six to ten cases are selected. This study uses a sample size of twenty Swiss and twelve Paraguayan cases to allow a better triangulation of data and to strengthen the results of the whole study (Yin, 2014).

## 4 FINDINGS

The results of this comparative cross-national multiple case study are presented in this chapter to answer the research questions individually. First, the findings of the survey from Switzerland are presented. Second, the findings of the survey from Paraguay are presented.

### 4.1 RQ1: Significance of early and fast internationalization

The analysis of the data collected from the SME interviews revealed the following themes. These themes individually and together will answer the research question one.

#### 4.1.1 Findings from Switzerland

Early and fast internationalization is considered essential for the survival of HSF from SMOPECs like Switzerland due to the small size of its home market (Neubert, 2016a; Zander et al., 2015).

Consequently, early and fast internationalization is part of the business model as well as the strategic and financial plan (Neubert, 2016a; Andersson et al., 2015; Cannone and Ughetto, 2014). Investors use these documents to calculate the corporate value, to invest, and to hold the founders accountable, if they are not reaching the planned and agreed goals (Neubert, 2016a).

The study of Neubert (2016a) revealed that Swiss HSF face significant delays of in average two and more years in the execution of their international market development activities in comparison to the time originally planned in their business plans. This comparison is based on the business plan, which the SME have used to calculate the valuation of their HSF for their last external capital increase before internationalization. The reasons are an often unstructured and unplanned internationalization process (Neubert, 2016a), unexpected long sales cycles (Neubert, 2016a), and missing resources.

Despite of these delays HSF couldn't benefit from government programs like for example export guarantees and export support due to program restrictions and missing expertise (Neubert, 2016a). This information is highly important because many SMOPEC invest significant resources in the development of a national HSF sector (Trudgen and Freeman, 2014; Almor, 2013). While policy makers have a national perspective, and support the local creation of new jobs and economic growth (Gerschewski et al., 2014), SME have a global perspective on their HSF.

#### 4.1.2 Findings from Paraguay

Early and fast internationalization is considered essential for the survival of HSF from SMOPEC: Especially younger HSF with internationally experienced and educated founders and investors and above the average size consider early and fast internationalization as essential for the survival of HSF from SMOPEC like Paraguay.

Immediate internationalization is part of the business plan of 58% of all SME: Due to an less developed professional private equity and venture capital market, Paraguayan HSF rely on their family, friends, and founders to finance their start-ups. Especially friends and business angels are quite conservative,

risk averse, and lack international experience. Consequently, they don't push hard for early and fast internationalization.

Paraguayan HSF don't ask for financial support from the government or from government agencies: However, they would appreciate (indirect) support in the sense of a better technical training and international promotion.

Paraguayan HSF face significant delays in the execution of their international market development activities in comparison to the time planned in their business plans: The majority of the SME indicate that a lack of resources like for example specialized human resources, and higher required quality standards abroad are the main reasons for delays.

Paraguayan HSF are starting to internationalize in neighboring markets like Bolivia and Brazil using low risk market entry modes like export in combination with strong local distribution partners and/ or they are following their existing clients. This research finding confirms the Uppsala internationalization process model (Johansen & Vahlne, 2009).

Paraguayan HSF are born regionals, because they internationalize within their home continent (Gabrielsson, Gabrielsson, & Dimitratos, 2014). There are some younger HSF with internationally experienced founders, which might also be considered as born global (Cavusgil & Knight, 2015).

#### *4.2 RQ2: Difference in the speed of internationalization*

The analysis of the data collected from the SME interviews revealed the following themes. These themes individually and together will answer the research question two.

##### *4.2.1 Findings from Switzerland*

Swiss HSF differ in their speed of internationalization due to the timing of the recruitment of international sales managers (Neubert, 2016b), because they bring in a market perspective, experience, and a network of potential clients. International sales managers acquire the first clients and distributors, and maintain long-term relationships with them (Kumar & Yakhlef, 2015). This is especially important, if the founders have no sales background.

Another driver of the speed of internationalization is the existence of market opportunities (Neubert, 2016b). These market opportunities (Coviello, 2006; Gabrielsson et al., 2014) are created based on the existing network of the management team, investors, or the sales management team. In a quite unstructured process, the existing networks are leveraged to grab low hanging fruits and to generate quick wins in the sense of showcase projects or lead users (Neubert, 2016b).

The size of their home market (Zander et al., 2015) is the third driver for the speed of internationalization. A small home market increases the pressure to internationalize early and fast (Neubert, 2016b). Therefore, founders from SMOPECs only use business models with IP protected and innovative products, which are globally scalable respectively focus on value chain activities with lower

market entry barriers (Neubert, 2016b), and implement structured internationalization processes soon after incorporation (Neubert, 2011; 2013a; 2013b; Zander et al., 2015).

Based on a first mover niche market strategy (Neubert, 2016b), Swiss HSF use less resource-intensive market entry modes like export, licensing, and franchising (Neubert, 2016b; Almor, 2013), because they allow for a faster global market penetration and the simultaneous entry in several markets (Neubert, 2015).

#### *4.2.2 Findings from Paraguay*

Paraguayan HSF differ in their speed of internationalization due to the following reasons. They acknowledge the importance of an international strategy and a well-structured market development process before going abroad. However, in practice they often follow their clients, use their network, and exploit market opportunities without analyzing the market attractiveness. This unplanned internationalization often results in reduced speed of internationalization.

Second, Paraguayan HSF prefer to cooperate with local distributors instead of developing their own network or depending on market opportunities abroad. Thus, the access to competent local partners is a key driver for the speed of internationalization.

More than 75% of all SME are aware that a Paraguayan HSF needs to offer a unique, innovative, and high quality niche market product at attractive prices to be competitive abroad. They understand that the FSA must be higher than the liability of outsidership in the foreign market.

The availability and the access to qualified human resources in the product development and client service department is also crucial. Thus, most SME call for government support to increase the quality and quantity of graduates with technical degrees.

The fifth and final reason for a difference in speed of internationalization are product characteristics. One example is the IT industry. Paraguayan HSF, which develop high quality cloud based applications as plug-in of an ERP system internationalize earlier and faster than developers of fully integrated, stand-alone software products.

## **5 CONCLUSIONS**

This study provides new evidence on the speed of internationalization of HSF from emerging and developed SMOPEC. It analyses how these BGF differ in their speed of internationalization using a comparative cross-national multiple case study research design with 32 SME interviews as primary source for data collection.

Switzerland is a developed economy. The brand “Swiss made” has an excellent reputation for high technology products, quality, and reliability. The access to capital and the existence of powerful research institutions has led to a diverse start-up ecosystem with HSF from different industries (e.g.

medtech, biotech, IT). The reputation and the framework conditions of a location is one important driver for the speed of internationalization. HSF from emerging economies are mainly from the IT industry focusing on application research based on technologies from developed countries. Chen, Saarenketo, & Puumalainen (2016) call it the liability of their country of origin in comparison to developed markets.

In spite of the differences that distinguish both countries-of-origin, the vast majority of both Swiss and Paraguayan SME consider early and fast internationalization as important for the enduring survival of their HSF. It would be interesting to expand this finding to other emerging and developed economies.

Both, Paraguayan and Swiss HSF face significant delays in the execution of their international market development activities in comparison to the time estimated in their business plans. The main reason is an often unstructured and unplanned internationalization behavior. HSF often enter new markets based on their networks, use market opportunities or follow existing clients without analyzing the attractiveness of foreign markets.

Most SME understand that this unstructured internationalization behavior reduces the speed of internationalization. They acknowledge the importance of a structured market development process starting from a detailed evaluation and selection of foreign markets before they actually enter them. While Paraguayan HSF start their internationalization primarily in neighboring countries, Swiss HSF have a global approach.

HSF from both samples apply an establishment chain using low risk and low cost market entry modes like 'licensing' or 'export with local distributors' to increase the speed of internationalization. They adapt their products and pricing strategies to local market needs, focus on market niches to speed up internationalization and to create a FSA, which compensates for the liability of foreignness and outsidership.

The findings of this study contribute to the field of research of international entrepreneurship, because researchers will gain a better understanding of how and why HSF from SMOPEC differ in their speed of internationalization. The findings of this study contribute to managerial practice, because they will help managers to increase the efficiency of international market development.

## REFERENCES

- Acedo, F.J. and Jones, M.V. (2007) 'Speed of internationalization and entrepreneurial cognition: insights and a comparison between international new ventures, exporters and domestic firms', *Journal of World Business*, Vol. 42, No. 8, pp.236–252.
- Amorós, J. E., Basco, R., & Romani, G. (2016). Determinants of early internationalization of new firms: the case of Chile. *International Entrepreneurship and Management Journal*, 12(1), 283-307.
- Andersson, S., Danilovic, M. and Huang, H.J. (2015) 'Success factors in western and Chinese born global companies', *iBusiness*, Vol. 7, No. 1, pp.25–38.
- Bacq, S. and Coeurderoy, R. (2011) 'Inception' in international new ventures: do empirics solve definitional ambiguity?', Paper presented at Academy of Management Annual Meeting, 12–16 August, San Antonio, TX.
- Bailetti, T. (2012) 'What technology startups must get right to globalize early and rapidly', *Technology Innovation Management Review*, Vol. 2, No. 7, pp.5–12.
- Baxter, P. and Jack, S. (2008) 'Qualitative case study methodology: study design and implementation for novice researchers', *The Qualitative Report*, Vol. 13, No. 4, pp.544–559.
- Cannone, G. and Ughetto, E. (2014) 'Born globals: a cross-country survey on high-tech startups', *International Business Review*, Vol. 23, No. 1, pp.272–283.
- Casillas, J. C., & Moreno-Menendez, A. M. (2014). Speed of the internationalization process: The role of diversity and depth in experiential learning. *Journal of International Business Studies*, 45: 85–101.
- Cavusgil, S. T., & Knight, G. (2015). The born global firm: An entrepreneurial and capabilities perspective on early and rapid internationalization. *Journal of International Business Studies*, 46(1): 3-16.
- Coviello, N. (2015) 'Re-thinking research on born globals', *Journal of International Business Studies*, Vol. 46, No. 1, pp.17–26.
- Coviello, N. (2006) 'The network dynamics of international new ventures', *Journal of International Business Studies*, Vol. 37, No. 5, pp.713–731.
- Chen, J., Saarenketo, S., & Puumalainen, K. (2016). Internationalization and value orientation of entrepreneurial ventures—a Latin American perspective. *Journal of International Entrepreneurship*, 14(1), 32-51.
- Ciravegna, L., Lopez, L., & Kundu, S. (2014). Country of origin and network effects on internationalization: A comparative study of SMEs from an emerging and developed economy. *Journal of Business Research*, 67(5), 916-923.
- D'Angelo, A., Majocchi, A., Zucchella, A. and Buck, T. (2013) 'Geographical pathways for SME internationalization: insights from an Italian sample', *International Marketing Review*, Vol. 30, No. 2, pp.80–105.
- De Villa, M.A., Rajwani, T. and Lawton, T. (2015) 'Market entry modes in a multipolar world: untangling the moderating effect of the political environment', *International Business Review*, Vol. 24, No. 3, pp.419–429.
- Eisenhardt, K.M. (1989) 'Building theories from case study research', *Academy of Management Review*, Vol. 14, No. 4, pp.532–550.
- Gabrielsson, M., Gabrielsson, P. and Dimitratos, P. (2014) 'International entrepreneurial culture and growth of international new ventures', *Management International Review*, Vol. 54, No. 4, pp.445–471.
- Gonzalez-Perez, M. A., Manotas, E. C., & Ciravegna, L. 2016. International SMEs from emerging markets—Insights from the Colombian textile and apparel industry. *Journal of International Entrepreneurship*, 14(1): 9-31.
- Hennart, J.F. (2013) 'The accidental internationalists: a theory of born globals', *Entrepreneurship Theory and Practice*, Vol. 38, No. 1, pp.117–135.
- Hitt, M. A., Li, D., & Xu, K. (2016). International strategy: From local to global and beyond. *Journal of World Business*, 51(1), 58-73.
- Johanson, J. and Valhne, J.E. (2009) 'The Uppsala internationalization process model revisited: from liability of foreignness to liability of outsidership', *Journal of International Business Studies*, Vol. 40, No. 9, pp.1411–1431.
- Knight, G. 2015. Born global firms: Evolution of a contemporary phenomenon. *Entrepreneurship in International Marketing*, 25: 3-19.
- Knight, G. A., & Liesch, P. W. 2016. Internationalization: From incremental to born global. *Journal of World Business*, 51(1): 93-102.
- Lemminger, R., Limkilde Svendsen, L., Zijdemans, E., Stavnsager Rasmussen, E. and Tanev, S. (2014) 'Lean and global technology start-ups: linking the two research streams', Paper presented at The ISPIM Americas Innovation Forum 2014, Montreal, Canada, 5–8 October.
- Lin, S., Mercier-Suissa, C., & Salloum, C. 2016. The Chinese born globals of the Zhejiang Province: A study on the key factors for their rapid internationalization. *Journal of International Entrepreneurship*, 14(1): 75-95.
- Luostarinen, R. and Gabrielsson, M. (2006) 'Globalisation and marketing strategies of born globals in SMOPECs', *Thunderbird International Business Review*, Vol. 48, No. 6, pp.773–801.

- Musteen, M., Datta, D. K., & Butts, M. M. 2014. Do international networks and foreign market knowledge facilitate SME internationalization? Evidence from the Czech Republic. *Entrepreneurship Theory and Practice*, 38(4): 749-774.
- Neubert, M. (2011) *Internationale Markterschließung: Vier Schritte zum Aufbau neuer Auslandsmärkte*, MI Wirtschaftsbuch, München.
- Neubert, M. (2013a) *Global Market Strategies: How to turn your company in a successful international enterprise*, Campus, Frankfurt am Main, New York.
- Neubert, M. (2013b) *Globale Marktstrategien: Das Handbuch für risikofreie Internationalisierung*, Frankfurt am Main: Campus Verlag.
- Neubert, M. (2015) 'Early internationalization of high-tech firms: past accomplishments and future directions', *Int. J. Teaching and Case Studies*, Vol. 6, No. 4, pp.353-369.
- Neubert, M. (2016a) 'Significance of the speed of internationalization for born global firms - a multiple case study approach', *Int. J. Teaching and Case Studies*, Vol. 7, No. 1, pp.66-81.
- Neubert, M. (2016b) 'How and why born global firms differ in their speed of internationalization - a multiple case study approach', *Int. J. Teaching and Case Studies*, Vol. 7, No. 2, pp.118-134.
- Nummela, N., Saarenketo, S., Jokela, P., & Loane, S. (2014). Strategic decision-making of a born global: a comparative study from three small open economies. *Management International Review*, 54(4), 527-550.
- Oviatt, B.M. and McDougall, P.P. (2005) 'Toward a theory of international new ventures', *Journal of International Business Studies*, Vol. 36, No. 1, pp.29-41.
- Rasmussen, E. S., & Tanev, S. (2015). The Emergence of the Lean Global Startup as a New Type of Firm. *Technology Innovation Management Review*, 5(11): 12-19.
- Romanello, R. & Chiarvesio, M. 2016a. The creation of foreign market knowledge across the growth phases of born globals. *MERCATI & COMPETITIVITÀ* 3/2016, pp. 69-85, DOI:10.3280/MC2016-003005
- Romanello, R. & Chiarvesio, M. 2016b. Turning point: when born globals enter post-entry stage. *Journal of International Entrepreneurship*, doi:10.1007/s10843-016-0192-x.
- Rosenberg, J. and Yates, P. (2007) 'Schematic representation of case study research designs', *Journal of Advanced Nursing*, Vol. 60, No. 4, pp.447-452.
- Seawright, J. and Gerring, J. (2008) 'Case selection techniques in case study research a menu of qualitative and quantitative options', *Political Research Quarterly*, Vol. 61, No. 2, pp.294-308.
- Servantie, V., Cabrol, M., Guieu, G., & Boissin, J. P. 2016. Is international entrepreneurship a field? A bibliometric analysis of the literature (1989-2015). *Journal of International Entrepreneurship*, 14(2): 168-212.
- Stake, R.E. (2010) *Qualitative Research: Studying How Things Work*, Guilford Press, New York City, USA.
- Trudgen, R. and Freeman, S. (2014) 'Measuring the performance of born-global firms throughout their development process: the roles of initial market selection and internationalization speed', *Management International Review*, Vol. 54, No. 4, pp.551-579.
- Verbeke, A., Amin Zargazadeh, M. and Osiyevskyy, O. (2014) 'Internationalization theory, entrepreneurship and international new ventures', *Multinational Business Review*, Vol. 22, No. 3, pp.246-269.
- Yin, R.K. (2014) *Case Study Research: Design and Methods*; 5th ed., Sage Publication, Thousand Oaks, USA.
- Zander, I., McDougall-Covin, P., & Rose, E. L. 2015. Born globals and international business: Evolution of a field of research. *Journal of International Business Studies*, 46(1): 27-35.
- Zikmund, W.J., Babin, B.J. and Carr, J.C. (2012) *Business Research Methods*, 9th international ed., Cengage Learning Emea, Boston, USA.
- Zucchella, A., Hagen, B., Denicolai, S. and Masucci, M. (2016) 'Early and accelerated internationalization: the role of the niche strategy in a new generation of exporters', *Int. J. Export Marketing*, Vol. 1, No. 1, pp.27-47.



## THE ROLE OF BUSINESS MODELS IN THE INTERNATIONAL GROWTH PATH OF STARTUPS

Onetti, Alberto <sup>1</sup>; Pisoni, Alessia <sup>1</sup>; Riva, Giada<sup>2</sup>

<sup>1</sup>Department of Economics, University of Insubria, Varese, Italy

<sup>2</sup>CrESIT, University of Insubria, Varese, Italy

### ABSTRACT

Despite a significant body of research focused on the variances of startup growth rate, the aspect of analysis related to *how* - i.e. the unique way to maximize the resource base of the startup (core activities organization) - and "*where*" international growth occurs has been insofar largely overlooked by scholars. Startups creation through the implementation of new innovative value propositions and business models that enable the company growth at global level need to be further investigated. Business models design and implementation appear to be of crucial importance in startups survival and growth. The present study is based on a single case-study analysis and follows an exploratory and qualitative methodology. The paper aims at analysing the business model of a new venture operating in the ICT industry that showed a fast and praecox internationalization. We thus interview the CEO/founder, who plays a crucial role in defining the international approach of the company, especially for startups. In this respect, the analysis of the business model of an innovative technology-based startup showing fast and praecox internationalization could be particularly useful in shed new light on *how* and *where* startups growth occurs. In doing so, it is also possible to investigate how company's day-by-day decisions affect business model evolution. Managerial implications, limitations and future research directions conclude the article.

*Keywords: business model; international growth; startup; web-based company; CEO.*

### 1. INTRODUCTION

In recent years, there has been a growing interest towards startups. As pointed out by different scholars (Stangler and Kedrosky, 2010; Kane, 2010) startups are accountable for almost all the new jobs created in the United States (about 63%). However, to contribute to economic growth, startups are supposed to survive, break the early stage barrier and scale-up at international level (Pisoni and Onetti, 2016). Scholars involved in the field of Entrepreneurship - and specifically International Entrepreneurship (IE) - have studied companies' international growth paths for many years (Coviello and Jones, 2004; Rialp et al., 2005; Gupta et al., 2013). Despite a significant body of research focused on

the variances of startup growth rate, the aspect of analysis related to *how* and *where* growth occurs has been insofar largely overlooked by scholars (Gilbert et al., 2006). In this respect, startups creation through the implementation of new innovative value propositions and business models (Onetti et al., 2012) that enable the company growth at global level need to be further investigated. Business models design and implementation appear to be of crucial importance in startups survival and growth (Onetti et al., 2012; Onetti and Zucchella, 2014). Recent researches approach the study of startups international growth path by adopting the business models framework (Bouncken et al., 2015; Rasmussen, 2016; Rask, 2014). The business model approach focuses on the holistic view of the firm's core activities and argues that the ability and speed of the firm to adapt to foreign markets relies on effective business model design and implementation.

In this respect, the analysis of startups business model could be particularly useful in understanding *how*, i.e. the unique way to maximize the resource base of the startup (core activities organization), and *where* international startup growth occurs. The framework we have developed for the business model analysis also represents a basis on which further debate and case studies may be built.

The remainder of the paper is structured as follows. The first section introduces the theoretical framework and provides a comprehensively review of the relevant literature on business model. Following this theoretical context, the research framework and methodology is presented. The discussion and conclusion summarize the results and conclude with managerial/research implications and future research directions.

## 2. THEORETICAL FRAMEWORK

### 2.1 Business Model Definition: State of the Art

Notwithstanding the increasing adoption of the business model concept, in the academic literature there is no agreement about a general framework definition. This problem is not new. Over the years, various authors have tried to address this problem by comparing different definitions and mapping business model components in order to provide an attempt of common framework. In this respect, Shafer et al. (2005) reviewed the relevant literature, covering 12 publications from the years 1998-2002. Analysing these definitions, the authors mapped 42 different elements that represent the substrate of the business model definition. The output of this article is an affinity diagram which groups the 20 components cited two or more times into four categories: "strategic choices", "value network", "create value" and "capture value". Later on, Morris et al. (2005) carried out a content analysis on 30 definitions, identifying three major categories of definitions, i.e. economic, strategic and operational. The authors mapped 24 items; of these ones, 15 were cited in the literature two or more times. From the analysis arises a general framework, composed of six factors, "factors related to the offering",

“market factors”, “internal capabilities factors”, “competitive strategy factors”, “economic factors” and “personal/investor factors”.

More recently, Wirtz (2011) proposed a new attempt to systematize the existing business model literature. In particular the investigated dimensions are: the business model concept (definitions & scope); the business model structure (forms & components, value system, actors & interaction, innovation); and the business model management process (design, implementation, operation, change & evolution, performance & controlling). Later on, to test the above-presented framework, a survey was submitted to scientists involved with business model (Wirtz et al., 2015). As a result, business model innovation, evolution and design appear to be the three more important areas of study for the future development of the business model research field.

Notwithstanding the significant amount of research insofar carried out on business models, scholars are still debating about the relationship between business model and strategy as well as between business model and corporate processes. On the one hand, some authors consider the business model as the goal of the strategy: concrete choices design the operational logics of a company and its ability to create value (Casadesus-Masanell and Ricart, 2010). On the other hand, other scholars clearly mark the difference between the business model and company’s strategy. Under this point of view, strategy has a more static valence. While the traditional concept of strategy tends to describe strategic positioning, the business model represents a dynamic and radical transformation in the market position (Yip, 2004). By contrast, according to George and Bock (2011) strategy is a dynamic set of activities, initiatives and processes, while a business model is a static configuration of organizational elements and activities. Implementing a business model may change the organization itself, but it is worth noting that business models are opportunity-centric, while strategy is competitor or environment centric.

As regards the relationship between business model and strategy, Osterwalder (2004) theorizes the business model concept recurring to a three layers framework. The first layer - the strategy - considers all planning activities. In this layer, companies deal with vision, goals and objectives. The second layer - the business model - is an architectural layer, in which companies schematize their value architecture and the logics to earn money. The last layer - the processes - represents the implementation level, in which companies organize the workflow. In the above-described framework proposed by Osterwalder, the business model represents the connection among business strategy, business organization and ICT. This triangle is influenced by external forces, such as social environment, legal environment, competitive forces, customer demand and technological change. It follows that is of key importance for managers to design and rapidly adapt the business model to the above mentioned external forces.

Along the years, scholars have also considered the business model concept as a systemic and holistic activity system able to connect individual actions and organizational activities to company performance (Zott and Amit, 2010). Also Chesbrough (2010) pointed out the barriers to business model innovation and the importance of attitude toward business model experimentation. In this respect, businesses face significant barriers to business model experimentation. The business model concept has been adopted trying to explain companies' performance, in terms of value creation and competitive advantage. The topic has been addressed also by operations management scholars. Among the others, Lee (2004) underlined how radical changes in some parts of a firm's business model could improve company's performance.

Another interesting issue addressed by scholars is the business model sustainability. Teece (2010) considers the implementation of a successful business model as a contingency competitive advantage, since it could be copied and shared among competitors. In this perspective, the business model is a more generic concept than strategy and it is more difficult to protect. Therefore, business models must be highly differentiated and difficult to replicate. In doing so, it is possible to avoid or limit copycat behaviours by creating a business model that requires systems, processes and assets hard to replicate and by maintaining a level of opacity that makes it difficult for outsiders to understand in detail how a business model works.

As shown above, business model is a useful tool to link opportunities to organizational changes, and to analyse the development of routines. In this perspective, it could be interesting to study company growth by adopting the business model framework.

### *2.2 Company Growth: The Stages Model Approach*

Similarly to stages models and life-cycle theories, business models could be used to represent the growth path of companies. Enterprise growth has been studied by scholars for many years (Gupta et al., 2013). Among the others, the well-known five stages model proposed by Churchill and Lewis (1983) affirmed that all companies pass through five stages of development, growing gradually in terms of sales (or failing in the attempt). Each stage is characterized by five managerial factors: extent of formal systems, major strategic goals, managerial style, organizational structure and the owner's involvement in the business, that change in importance in relation to the company's growth. Furthermore, Christensen and Scott (1964) theorized a three stages model in which companies evolve from a one-unit management with no specialized organizational parts to multiple operating units, passing through a one-unit management with some functional parts. Later on, Lawrence (1969) presented a four stages model based on direct supervision, supervised supervision, indirect control and divisional organization. A different five stages framework was theorized by Greiner (1972), who

linked each stage of the company's lifecycle to the management style and related managerial problems.

Furthermore, Cardon et al. (2005) propose to analyse the stages in the entrepreneurial procreation process by applying parenthood as a metaphor for entrepreneurship, i.e. comparing the founding of a new firm to the birth of a child. Through this metaphor, they explore a preliminary stage of conception and gestation followed by infancy, toddlerhood, childhood, adolescence - growth and maturity. Focusing on entrepreneurial exit as a critical component of the entrepreneurial process, DeTienne (2010) expanded the model proposed by Cardon et al. (2005) by including also entrepreneurial exit. For high-growth ventures, exit is often considered as the ultimate goal of building a profitable venture aiming at a successful exit to satisfy liquidity demand of both entrepreneur(s) and investors. He analyses the entrepreneurial process in different phases conception and gestation, infancy, adolescence and maturity, acknowledging that entrepreneurial exit may occur at any time during the entrepreneurial process.

All these models are based on the assumption that companies are similar to organisms, characterized by a sort of genetic code embedded in them that drives the development, as a pre-established path to be achieved. This assumption is not coherent with the current competitive scenario, in which companies often anticipate their environment or contribute to modify it, and eventually could represent a barrier to managerial research (Pfeffer, 1993). A step forward in the research of companies growth and performance - in particular of entrepreneurial ones - has been addressed by Levie and Lichtenstein (2010) who introduced a dynamic states model. According to them, stages model may evolve towards the analysis of viable business models, able to convert environmental threats and opportunities into value.

### *2.3 Company Growth: The Business Models Perspective*

As previously mentioned, one of the key aspects of a business model is dynamism. In this respect, business model connects strategy with value creation and market changes to gain competitive advantage. Business model dynamism has been studied by scholars under different perspectives. According to Nicholls-Nixon et al. (2000), business model is a tool helping entrepreneurs in continuously matching internal competencies and capabilities with external opportunities and threats. Svejnova et al. (2010) study the dynamic nature of business models and the mechanisms associated with their changes over time. Furthermore, business models are tools that can drive innovation and change within organizations, as point out by Demil and Lecocq (2010). The focus is more internal and takes into consideration a company's portfolio of resources and competences. The ability of an entrepreneur to manage business model innovation is strictly linked with the exploration and

exploitation processes (Mason and Leek, 2008) and dynamic capabilities (Achtenhagen et al., 2013; Bock et al., 2012).

By managing internal resources, companies are able to modify and evolve their business model, while offering new value propositions to their customers. The evolutionary vision of the business model is related to its ability to recognize the continuous state of disequilibrium in a company's lifecycle. In this perspective, business model can be considered as the general framework, which does not evolve following a pre-defined path. A recent contribution of Achtenhagen et al. (2013) points out the need of business models to change over time, continuously adapting to the uncertain competitive scenario and strengthening the relationships among strategic actions and critical capabilities. It follows that managers need to take into consideration the diagnosis and feedback loops in order to achieve sustainable value creation. Effective business models generate virtuous cycle, in which feedback loops are self-reinforcing and creating a dynamic similar to that of network effects (Casadesus-Masanell and Ricart, 2011). The feedback loops pull managers to reorient the company's business model, or to dramatically change the strategy (at business or corporate level).

From the business model perspective, company survival and growth depend on effective design, implementation and re-orientation. Business model related decisions encompass core activities organization and resources allocation, but also decisions about location of activities. By including the latter aspect – location choices – in the business model framework, it is possible to study also the international growth path of innovative technology-based startups. A business model framework – centered on company activities, in terms of “focus”, “modus” and “locus” – is proposed by Onetti, Zucchella, Jones and McDougall-Covin (2012). By adopting this framework it is possible to study ‘how’ and ‘where’ startups growth (Onetti and Zucchella, 2014).

Specifically, Onetti, Zucchella, Jones and McDougall-Covin (2012) developed a framework that groups business model components into four different levels. The authors included in their analysis 48 definitions identified in the literature, shrinking the 42 components identified down to a shorter list of 26. At the top level there are mission and objectives, which define the long-term direction of a company. Strategy belongs to the upper level of the business decision process, since it selects the businesses (corporate strategy) with which to compete and defines how to position for each of them (business strategy). Although, for successful execution, a business model is required, to support/design the comprehensive set of decisions that jointly determines and shapes the company's activities architecture. A business model defines otherwise how to execute the strategy, representing the firm's strategic choices in terms of “focus”, “modus” and “locus” (Onetti and Zucchella, 2014). While *focus* considers the allocation of resources among activities, *modus* performs the related integration-outsourcing decisions. According to this framework, *locus* represents the critical aspect

involved in any business model decision, due to the growing importance of clustering and spillovers phenomena. In this respect, location decisions can open up new business opportunities or develop new partnerships. Business model may change over time. Company's day-by-day decisions affect focus, modus and locus. Each decision, separately considered is not necessarily a radical change, they are often just a fine-tuning of prior decisions. The sum of these decisions may radically change the way the company works and its business model.

### 3. RESEARCH METHODOLOGY

In order to analyse the international growth path of new ventures adopting the business model perspective, we focus our research on a single-case study. In doing so, we follow an exploratory and qualitative methodology (Corbin and Strauss, 1990; Eisenhard, 1989; Yin, 1989, 1998, 2003; Maxwell, 1996, 1998). In order to assure the validity and reliability of the research, design and analytical requirements were followed (Yin, 1994). First, we defined a protocol according to the theoretical framework to be tested prior to the interview phase; the target company was then interviewed following the same defined structure specifically built for the research.

By adopting the above-described business model framework developed by Onetti, Zucchella, Jones and McDougall-Covin (2012) - namely "focus", "locus", "modus" approach - we developed a semi-structured questionnaire for interviewing the CEO. Accordingly, we asked the interviewee to prioritize activities, which are critical to create value. We decided to interview the Chief Executive Officer (CEO), who is usually the founder of the startup and, in the early stages, the key figure and decision maker for the company (Papadakis and Barwise, 2002). Furthermore, strategy and strategic orientations are strictly linked to the mindset and individual-related characteristics of the CEO, that represent usually the most important and compelling person of the founders' team (Papadakis and Barwise, 2002; Miller and Toulouse, 1986; Kisfalvi, 2002). It follows that business model decisions resides in the mind of the CEO/founder, who can choose among alternative business model configurations on the basis of his/her perception of external competitive scenario.

We conducted an open-ended and semi-structured interview at the executive level (founder/CEO). The interview was recorded and then transcribed into a text format, resulting in 32 pages of textual material. We then integrated the interview with multiple sources of secondary information, e.g., corporate documents, websites and press releases, which provide more accurate and unbiased information. Moreover, several data about the industry and the market in which the firm operates were collected from articles, websites and other sources of information. Relying on different sources of information allows data triangulation to ensure the validity of the study and to obtain a more comprehensive and accurate view of the topic analysed.

To provide an insightful picture of the company along the crucial stages of its international growth path, we analysed the business model during two different period of the startup's life: at the foundation phase in 2011, and in 2014, when the startup was characterized by systematic international growth.

#### 4. CASE STUDY DESCRIPTION AND DISCUSSION

The startup selected for the business model analysis is Spreaker. The company provides a web and mobile app to broadcast live audio content. It enables users to create tracks, podcasts and playlists, upload files, and distribute them to social networks such as iTunes, YouTube, Facebook, and more. Furthermore, all the podcasters can participate in and interact with a rich community of audio creators and listeners. Currently, the company is continuously looking for new business opportunities and it aims at taking advantage from the crisis of old technologies in the audio online market.

Spreaker was founded in 2009 in Bologna (Italy) by three Italian entrepreneurs, but shortly thereafter, in 2011, the cofounders established a new company in San Francisco, namely Spreaker Inc. The main reasons for headquarters relocation concern the local market opportunities, as well as the exploitation of the American legislations in term of music royalties licensing and stock option compensation. The Italian branch has absorbed all the initial costs for setting up a company and has enabled the founders to collect the financing for further growth, while the US-based company, has carried out the commercial activities.

At the moment of foundation, the entrepreneurial team was composed by three founders, who are serial entrepreneurs, since they have previously founded other companies, in which they are no more involved. At the moment of the interview, there are only two out the three original founders, i.e. the CEO and the CTO. One founder of the original team left the company.

Table 1 provides a brief description of the activities initially performed by Spreaker, in the very early-stage of the company. As previously mentioned, the framework adopted to analyse Spreaker's business model is the one proposed by Onetti and Zucchella (2012; 2014). The business model analysis is of crucial importance to study company survival and growth (Onetti et al., 2012) and is therefore particularly suitable to understand *how* and *where* company's growth occurs (Bouncken et al., 2015; Rasmussen, 2016). In this respect, *how* and *where* have been explored by analysing *focus/modus* and *locus* decisions implemented by the company under investigation. According to the business model framework proposed by Onetti and Zucchella (2012, 2014), the interviewee has been asked to evaluate on a "1 (low) to 10 (high)" scale the importance of each activity performed, also considering the resources allocated in each different business activity and location.



Activity list	Focus	Locus	Modus			
				Brain intensive	Technology intensive	Labour intensive
Product and software development	10	Italy, Germany	In	10	10	5
Engineering and design	10	Italy, Germany	In	10	10	0
Marketing	5	Italy, Germany, US	In	10	10	0
Administration and performance audit	1	Germany	In	-	0	0
Funding activity	10	Italy, US	In/Out	-	0	0

Table 1 – Spreaker’s business model in 2011

The aforementioned activities are those related to the execution of the company’s business model. Since funding at the initial stage of a startup is usually a scarce resource, the management has to evaluate the activities’ priority according to an order of importance. In this respect, at the beginning of Spreaker’s life cycle, the firm’s focus was on the development of a valuable product. Activities such as product development and product design had the highest priority, as well as seeking external funding since the company was not profitable yet; efforts on marketing activity were marginal.

The international-oriented mindset of the founders, push them to look for investments either in Italy or in the US, although the main investors of Spreaker were Italian business angels.

#### 4.1 Business model evolution

The analysis of the company’s business model under a dynamic point of view, i.e. focusing on its changes over time, has been stressed by scholars as being crucial to understand the way entrepreneurs match internal competencies and capabilities with external opportunities and changes (Svejenova et al., 2010; Nicholls-Nixon et al., 2000; Achtenhagen, 2013). The business model framework we adopted for our analysis is particularly helpful to study the company “evolution” over time, since it clearly shows how companies modify their business model by continuously adapting their activities’ *focus/modus* and *locus* decisions to the competitive scenario (Onetti and Zucchella, 2014; Bouncken et al., 2015).

The product developed by Spreaker is able to serve the global market since the beginning. However, along the years, the business model has slightly changed. The strategic importance of the marketing activity has increased, and new operations such as the so-called “fletcher list” and external communication have been introduced starting from 2014.

Activity list	Focus	Locus	Modus			
				Brain intensive	Technology intensive	Labour intensive
Product development	10	Italy, Germany	In	10	10	0
Flitcher list	8	Italy, Germany	In	10	10	0
Engineering and design	10	Italy, Germany	In	10	10	0
Marketing	8	Italy, Germany, US	In	10	10	0
External relations/communication	8	Italy, Germany, US	In	10	10	0
Administration	1	Germany	In	-	0	0
Performance audit	1	Germany	In	-	0	0

Table 2 – Spreaker’s business model in 2014

At this stage, the company has decided to focus on activities such as marketing and external communications, as well as on further service’s development in order to increase the users base and consequently the profits’ margins. The acquisition of new clients is pursued by strengthening external relations rather than through the offering of new services. Moreover, as regards Spreaker’s future activities, the interviewee point out that company’s plans are to focus on marketing and commercialization, rather than on technology development, by only adding marginal incremental innovation to the existing product.

As previously mentioned, business model related decisions encompass activities organization and resources allocation, but also decisions about activities localization. By analysing also the latter aspect, it is possible to study the company’s international growth path, i.e. the “*where*” question.

As regards Spreaker’s location choices, the headquarters have been moved to the United States early after company’s inception, and at the same time an office in Berlin was also established. The main reasons for headquarters relocation in the US concern the fact that the American audio online market was wider and homogeneous, and the service offered by Spreaker has more chance to exponentially grow. In this respect, in Italy – in 2011 - there were few instruments for the online payments that allowed the monthly subscription. The reasons behind the choice of opening a German-based office were mainly due to the search of high-qualified employees with software development skills. Notwithstanding the relocation of the headquarters, Spreaker is still performing some operational activities from its Italian office.

Graph 1 and 2 summarize the main activities performed by Spreaker at the time of foundation (2011) and at the time of the interview (2014). In doing so, we focus the analysis on the “locus” and “focus” aspects, since as regards “modus”, the vast majority of activities are performed by the company itself

without partnerships. According to the proposed business model framework of analysis (Onetti et al., 2012; Onetti and Zucchella, 2014), as previously mentioned, the interviewee has been asked to evaluate on a “1 to 10” - scale the importance of each activity performed, in terms of resources allocated in each different business activity and location.

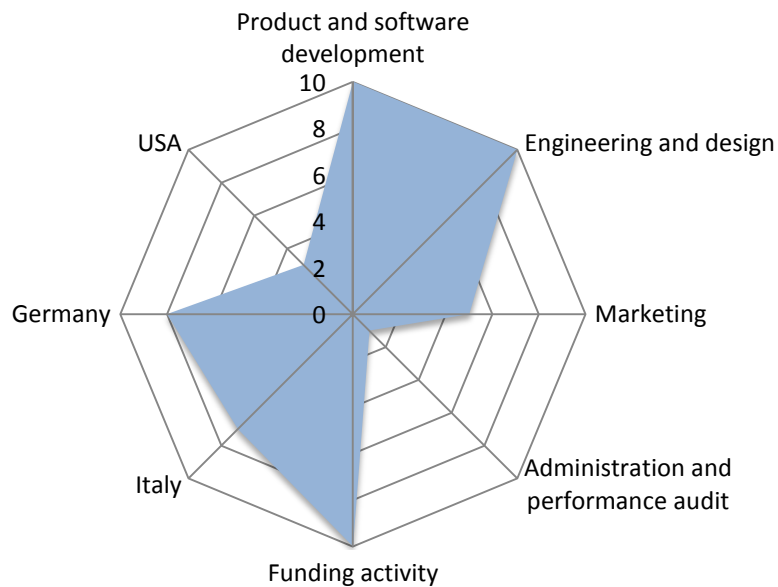

Graph 1 – Business model “focus” and “locus” perspective in 2011

As a consequence of the above-mentioned company’s development, in 2014, Spreaker’s main focus shifted towards marketing and communication activities. The outcome of such a decision is an increase of resource allocation - and attention - towards the US location, representing the US also the main market of the company.

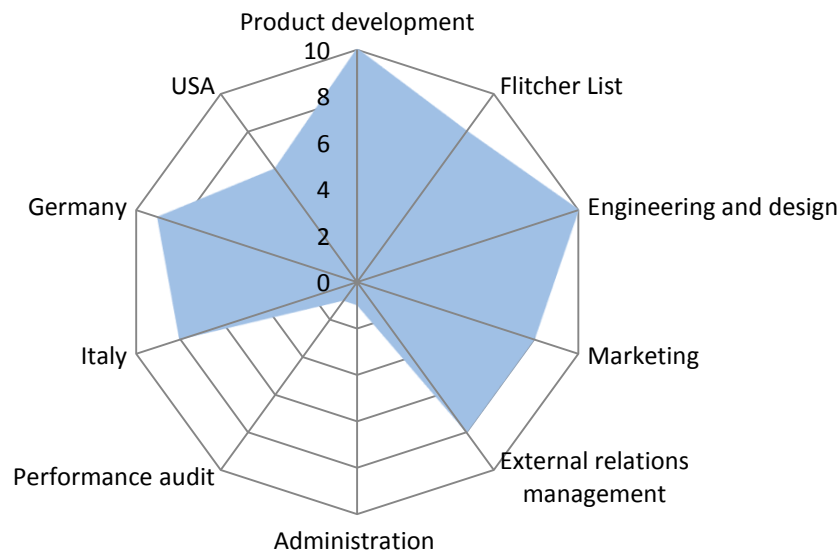

Graph 2 – Business model “focus” and “locus” perspective in 2014

## 5. CONCLUSIONS

Despite a significant body of research focused on the variances of startup growth rate, the aspect of analysis related to *how* and *where* growth occurs has been so far largely overlooked by scholars (Gilbert et al., 2006). In this respect, the study of the business model architecture could help in filling this gap by identifying which are the critical aspects/business model decisions that influence the company growth at global level. In doing so, we adopted the business model framework developed by Onetti and Zucchella (2012; 2014), which specifically analyses company activities in terms of “focus”, “modus” and “locus” decisions.

The startup selected for our conceptualization, namely Spreaker, shows how “focus/modus” and “locus” decisions are strictly intertwined. Activity location decisions at the early stage of development of company life cycle appear to be crucial to boost the company’s scale-up at international level. Spreaker started the business in Italy in 2009 (stand-up phase) when the founders showed their willingness to build a scalable business and started to raise initial financing from business angels. However, as previously said, the main commercial operations started in 2011 (start-up phase) when the company moved the headquarters to San Francisco and focused its efforts and resources to enter that market. In addition to this, also a Berlin-based office was established to carry out mainly operational and administrative activities. As time goes by, the number and the complexity of the companies’ activities at international level have increased, as well as the company’s revenues, to the extent that, today, Spreaker is profitable and does not require any financial contribution to run its business (scale-up phase/international growth).

Furthermore, the case study analysis clearly shows how important is the dynamism of the business model, thus supporting previous research findings (Achtenhagen et al. 2013; Nicholls-Nixon, 2000; Svejenova et al., 2010). Spreaker's business model changed along the years to adapt to the specificities of the competitive scenario and, being the company in its early stage of development, also to finalize their offer to the final customers.

Some limitations of the study should be remarked. Specifically, we cannot check the influence of the company's international growth path on company performance, since these data are undisclosed, due the presence of external investors in the equity capital of the company. Nevertheless, results have important implications for entrepreneurs and managers of startups at an early stage of development. The case study analysis shows how properly implementing and continuously adapting the business model to the competitive scenario is of crucial importance for startups survival and international growth.

Moreover, stated the importance of business model architecture and specifically the localization choice decisions of startups, we encourage future research to focus on cross-case business model analysis to shed new light on the specificities of the international growth path of startups.

## REFERENCES

- Achtenhagen, L., Melin, L. and Naldi, L. (2013), "Dynamics of Business Models – Strategizing, Critical Capabilities and Activities for Sustained Value Creation", *Long Range Planning*, Vol. 46 No. 6, pp. 427-442.
- Bock, A.J., Opsahl, T., George, G. and Gann, D.M. (2012), "The Effect of Culture and Structure on Strategist Flexibility During Business Model Innovation", *Journal of Management Studies*, Vol. 49 No. 2, pp. 279-305.
- Bouncken, R.B., Muench, M. and Kraus, S. (2015), "Born Globals: Investing the Influence of their Business Models on Rapid Internationalization", *International Business & Economics Research Journal*, Vol. 14 No. 2, pp. 247-255.
- Cardon, M.S., Zietsma, C., Saporito, P., Matherne, B.P. and Davis, C. (2005), "A Tale of Passion: New Insights into Entrepreneurship from a Parenthood Metaphor", *Journal of Business Venturing*, Vol. 20 No. 1, pp. 23-45.
- Casadesus-Masanell, R. and Ricart, J.E. (2010), "From Strategy to Business Models and onto Tactics", *Long Range Planning*, Vol. 43, pp. 195-215.
- Casadesus-Masanell, R. and Ricart J.E. (2011), "How to Design a Winning Business Model", *Harvard Business Review*, Vo.89 No. 1-2, pp.100-107.
- Chesbrough, H. (2010), "Business Model Innovation: Opportunities and Barriers", *Long Range Planning*, Vol. 43, pp. 354-363.
- Christensen, C.R. and Scott, B.R. (1964), "Review of Course Activities", IMEDE, Lousanne.
- Churchill, N.C. and Lewis, V. (1983), "The Five Stages of Small Business Growth", *Harvard Business Review*, Vol. 61 No. 3, pp. 30-50.
- Coviello, N.E. and Jones, M.V. (2004), "Methodological Issues in International Entrepreneurship Research", *Journal of Business Venturing*, Vol. 19 No. 4, pp. 485-508.
- Demil, B. and Lecocq, X. (2010), "Business Model Evolution: In Search of Dynamic Consistency", *Long Range Planning*, Vol. 43, pp. 227-246.
- DeTienne, D. R. (2010), "Entrepreneurial Exit as a Critical Component of the Entrepreneurial Process: Theoretical Development", *Journal of Business Venturing*, Vol. 25 No. 2, pp. 203-215.
- George, G. and Bock, A.J. (2011), "The Business Model in Practice and its Implications for Entrepreneurship Research", *Entrepreneurship Theory and Practice*, Vol. 35 No. 1, pp. 83-111.
- Gilbert, B.A., McDougall, P.P. and Audretsch, D.B. (2008), "Clusters, knowledge spillovers and new venture performance: An empirical examination", *Journal of Business Venturing*, Vol. 23 No. 4, pp. 405-422.

- Greiner, L.E. (1972), "Evolution and Revolution as Organizations Growth", *Harvard Business Review*, Vol. 50 No. 4, pp. 37-46.
- Gupta, P.D., Guha, S. and Krishnaswami, S.S. (2013), "Firm growth and its determinants", *Journal of Innovation and Entrepreneurship*, Vol. 2 No. 15, pp. 1-15.
- Kane, T. (2010), *The Importance of Startups in Job Creation and Job Destruction*, Kauffman Foundation Research Series: Firm Formation and Economic Growth, Ewing Marion Kauffman Foundation.
- Kisfalvi, V. (2002), "The entrepreneur's character, life issues, and strategy making: a field study", *Journal of Business Venturing*, Vol. 17, pp. 489-518.
- Lawrence, L.S. (1969), "Critical Stages of Small Business Growth: When They Occur and How to Survive Them", *Business Horizons*, Vol. 12 No. 1, pp. 29-36.
- Lechner, C. and Dowling, M. (2003), "Firm networks: External Relations as Sources for the Growth and Competitiveness of Entrepreneurial Firms", *Journal of Entrepreneurship and Regional Development*, Vol. 1, 1-26.
- Lee, H.L. (2004), "The Triple-A Supply Chain", *Harvard Business Review*, pp. 2-12.
- Levie, J. and Lichtenstein, B.B. (2010), "A Terminal Assessment of Stages Theory: Introducing a Dynamic States Approach to Entrepreneurship", *Entrepreneurship Theory and Practice*, Vol. 34 No. 2, pp. 317-350.
- Mason, K.J. and Leek S. (2008), "Learning to Build a Supply Network: An Exploration of Dynamic Business Models", *Journal of Management Studies*, Vol. 45 No.4, pp. 774-799.
- Miller, D. and Toulouse, J.M. (1986), "Strategy, structure, CEO personality and performance in small firms", *American Journal of Small Business*, Vol. 10, pp. 47-62.
- Morris, M., Schindehutte, M. and Allen J. (2005), "The Entrepreneur's Business Model: Toward a Unified Perspective", *Journal of Business Research*, Vol. 58, pp. 726-735.
- Nicholls-Nixon, C.L., Cooper, A.C. and Woo, C.Y. (2000), "Strategic Experimentation: Understanding Change and Performance in startups", *Journal of Business Venturing*, Vol.15, pp. 493-521.
- Onetti, A., Zucchella, A., Jones, M.V. and McDougall-Covin, P. (2012), "Internationalization, Innovation and Entrepreneurship: Business Models for New Technology-based Firms", *Journal of Management and Governance*, Special Issue: Entrepreneurship and strategic management in Life sciences. Business Models for High-Tech Companies", first online 2010, Vol.16 No. 3, pp. 337-368.
- Osterwalder, A. (2004), *The Business Model Ontology – A Proposition in a Design Science Approach*, PhD thesis, University of Lausanne.
- Papadakis, V.M. and Barwise, P. (2002), "How Much Do CEO and Top Managers Matter in Strategic Decision-Making?", *British Journal of Management*, Vol. 13, pp. 83-95.
- Pfeffer, J. (1993), "Barriers to the Advance of Organizational Science: Paradigm Development as a Dependent Variable", *The Academy of Management Review*, Vol. 18 No. 4, pp. 599-620.
- Pisoni, A. and Onetti, A. (2016), *New Venture Growth from Start-up to Scale-up*, in Vrontis D., Bresciani S. and Rossi M., "Managing Globalization. New Business Models, Strategies and Innovation of Firms", Cambridge Scholars Publishing, pp. 156-181.
- Rask, M. (2014), "Internationalization through business model innovation: In search of relevant design dimensions and elements", *Journal of International Entrepreneurship*, Vol. 12, No. 2, pp. 146-161.
- Rasmussen, E. S. (2016), "Innovation and Internationalization: two sides of the same coin?", *The Second Odense Workshop on International Entrepreneurship*, University of Southern Denmark, Odense, 20-21 May 2016.
- Rialp, A., Rialp, J. and Knight, G.A., (2005), "The Phenomenon of Early Internationalizing Firms: What Do We Know After a Decade (1993–2003) of scientific inquiry?", *International Business Review*, Vol. 14 No. 2, pp. 147-166.
- SEP Monitor (2015), *From Unicorns to Reality, A Five-Country Comparison of European ICT Scaleups*, July 2015, No. 2, published by Startup Europe Partnership (SEP) and Mind the Bridge Foundation.
- Shafer, S.M., Smith, H.J. and Linder, J.C. (2005), "The Power of Business Models", *Business Horizons*, Vol. 48, pp. 199-207.
- Stangler, D. and Kedrosky, P. (2010), *Neutrality and Entrepreneurship: The Structural Dynamics of Startups, Young Firms, and Job Creation*, Kauffman Foundation Research Series: Firm Formation and Economic Growth, Ewing Marion Kauffman Foundation.
- Svejenova, S., Planellas, M. and Vives, L. (2010), "An Individual Business Model in the Making: a Chef's Quest for Creative Freedom", *Long Range Planning*, Vol. 43, pp. 408-430.
- Teece, D.J. (2010), "Business Models, Business Strategy and Innovation", *Long Range Planning*, Vol. 43, pp. 172-194.
- Wirtz, B.W. (2011), *Business Model Management: Design – Instruments – Success Factors*, Gabler, Wiesbaden.
- Wirtz, B.W., Pistoia, A., Ullrich, S. and Göttel, V. (2015), "Business Models: Origin, Development and Future Research", *Long Range Planning*.

- Yip, G.S. (2004), "Using Strategy to Change Your Business Model", *Business Strategy Review*, Vol. 15 No. 2, pp. 17-24.
- Zott, C. and Amit, R. (2010), "Business Model Design: An Activity System Perspective", *Long Range Planning*, Vol. 43, pp. 216-226.

## NETWORK PERSPECTIVE ON ESTABLISHMENT PROCESS IN TRANSITION ECONOMIES

Osarenkhoe, Aihie<sup>1</sup>; Fjellström, Daniella<sup>1</sup>; Abraha, Desalegn<sup>2</sup>; Awuah, Gabriel Baffour<sup>3</sup>

<sup>1</sup>University of Gävle, SWEDEN

<sup>2</sup>University of Skövde, SWEDEN,

<sup>3</sup>University of Halmstad, SWEDEN

### ABSTRACT

*This paper contributes to extant literature on market entry strategies in several ways. First, while previous literature focuses either on entry modes or entry timing, comparatively little efforts are made to illuminate the establishment process. Secondly, it addresses emanating impediments and development of supporting relationships with significant actors during the processes of establishment in transition economies. Establishment model, developed from network approach, facilitated the capturing of various supporting relationships that enabled the focal relationships to function properly during the establishment processes in less-structured markets. In-depth interviews were held with key informants in two Scandinavian firms. Findings show that Statoil's ability to leverage a number of significant actors in its network for support during its establishment in Estonia makes the process less cumbersome and less resource consuming. Lack of home and host country support for Scania resulted in an arduous and costly process, with the firm's position changing several times as different problems cropped up. In conclusion, relationship orientation requires adaptation by an organization, but more critically by its managers. Lack of cross-cultural relationship skills and orientation could impede a company's growth in international markets. We call for more research efforts in the area of cultural dimensions of market establishment processes.*

*Keywords: relationships, networks, establishment processes, actors, resource exchanges, transition economies.*

### INTRODUCTION

There is a need for more studies on entry modes (Hennart & Slangen, 2015) in international business. A focus on the particular entry mode a firm uses to enter a new market, rather than on the process of establishment, dominates in extant literature. While earlier research (Wheeler et al., 1996; Williams, 1997; Sun, 1999; Koch, 2001; Kim et al., 2002; Floyd, 2002; Blomstermo et al., 2006; Hennart, 2009; Hennart & Slangen, 2015) focuses on the entry modes firms use to enter foreign markets, we focus on



managerial problems associated with the establishment and development of supporting relationships with significant actors during the processes of establishment in transition economies.

This paper aims to address the extent to which firms utilize a number of significant actors in their network of exchange relationships for support in their establishment processes. The two Scandinavian companies studied have both established business operations in markets endowed with features that are different from those that prevail in their domestic markets. The network model (Axelsson and Easton, 1992; Chetty, S. and D. Blankenburg-Holm, 2000; Mattsson and Johanson, 2006) could not be adopted in its entirety to illuminate the establishment processes of the firms (Scania and Statoil) in transition economies. Because the network perspective (Tikkanen, 1998; Ashton, 2006; Blankenburg-Holm, 1996; Johanson and Vahlne, 2003) takes a more general approach to market establishments as a process of development, we argue that, without some modification, the network approach is not always appropriate for all types of economies. One of focus areas suggested by Hennart and Slangen (2015) is how the entry decision process is structured. Hence, the establishment model, (a modified version of the network model) (Abraham 1994, 2002), enables us to illuminate the establishment processes of two Scandinavian firms (Scania and Statoil) in less developed and loosely structured markets (Croatia and Estonia). Manolova, Manev and Gyoshev (2010) note that inter-firm networks are important and calls for more research in particular on transition economies. Their study was limited to Bulgaria measuring the network effect on internationalization. Dikova and Brouthers (2015) discuss that few theoretical lenses have been used in their review of establishment mode and that there is a lack of research from 2010 onwards.

The establishment model applied in this paper facilitated the capturing of, among others, the various supporting relationships that enabled the focal relationships to function properly during the establishment processes in these markets. According to Fallon (2004), transition economies such as those in Central and Eastern Europe are a complex environment for investment in which firms are subject to institutional and governmental pressures and where significant differences in business culture and practices are a product of past economic and political systems based on communism. This may increase uncertainty and risk for firms.

The network model draws on the theories of social exchange and focuses on firm behaviour in the context of inter-organizational and interpersonal relationships. It emphasizes the role and influence of social relationships in business transactions (Johanson & Vahlne, 1990). Companies are connected by networks, which develops the interaction between them. The usefulness of applying a network perspective to study international business has long been emphasized in the literature (Turnbull and Valla, 1986; Johanson and Mattsson, 1988; Keeble et al., 1998).

According to Root (1994:23), “traditional presentations on foreign market establishment represent the following set of decisions: assessing products in foreign markets; choosing the target product/market; setting objectives and goals; choosing the entry mode; designing the marketing plan; and controlling for performance”. In our view, the approaches do not sufficiently emphasize the relationship dynamics of international market establishments. This view is also supported by Donaldson and O’Toole, (2007) when he writes that: “firms operate as independent actors making rational analytical choices about which markets to enter, the optional method of market entry, and modes of operation in particular countries” (p. 213). Such an approach, which is the focus of attention in extant literature (Wheeler et al., 1996; Williams, 1997; Sun, 1999; Koch, 2001; Kim et al., 2002; Floyd, 2002; Blomstermo et al., 2006), leads companies to focus on a particular entry mode. Moreover, we are conversant with the notion that *market entry* refers to what a firm does in the introductory phase of entering foreign countries, while *market establishment* refers to how the firm builds a position once it has entered the foreign market. In this paper, we aim to fill this void by concentrating our efforts on the latter, namely, the processes of establishment in a loosely structured market.

**RQ1:** How did Scania and Statoil establish their operations in the Croatian and Estonian markets, respectively, by developing a web of relationships and ties with various actors to enhance the processes of establishment? To answer this question, we conducted two in-depth case studies to capture the essence of the establishment processes of these two Scandinavian firms in Croatia and Estonia. Consequently, a modified network model that facilitates an understanding of the web of relationship forms embedded in the establishment process of firms in transition economies is operationalized in this paper. It is our view that this perspective leads companies to focus on the process rather than on the particular entry mode to add more research on perspectives on entry modes (Hennart & Slangen, 2015).

The remainder of the paper is divided in the theoretical framework. We then discuss the methodology, followed by presentation of two rich and descriptive case studies. Thereafter follows the analysis and the establishment process model. Finally, the conclusions and implications are discussed.

## **THEORETICAL FRAMEWORK**

### *The network approach*

Networks are important for the establishment process (Greve, 1995) where contacts and resources are essential to support the establishment in a new market. Furthermore, Yu, et al (2011) advanced the network perspective on new venture internationalization by examining the role of networks in accelerating new venture sales into foreign markets. Consequently, market establishments are

facilitated through interactions between a number of identifiable and significant actors operating within a specific network (Blankenburg-Holm, 1996; Axelsson and Easton, 1992). Unlike the FDI (foreign direct investment) perspective of management's planning of the establishment process (Hennart, 1982; Dunning, 1980, 1993) the focus lies on understanding the managerial problems associated with the establishment and development of business relationships (Johanson and Vahlne, 2003) with actors such as customers, suppliers, intermediaries and local authorities. What is happening in one relationship affects the interaction and activities in others (Håkansson and Snehota, 1995). Hence, the establishment process of a firm cannot be seen as a development solely under the influence of the firm that is entering certain foreign markets.

Actors in interaction possess specific resources and perform specific activities that create the exchange that make them interdependent on each other (Hägg and Johanson, 1982; Johanson and Mattsson, 1988; Håkansson, 1987, 1989; Håkansson and Snehota, 1995; Ford, 1980). Once the relationships are interconnected, a development in one relationship can affect others, positively or negatively. Hence, faced with some establishment opportunities and/or challenges, an actor will draw on certain significant actors for certain complementary capabilities that will enhance the solution to the emerged situation. For Axelsson and Easton (1992), for example, one actor's action must be viewed in the context of those of other actors in a network and relationships between the actors in the network. Hence, a firm's establishment processes in foreign markets should be seen in how well it exploits networks of exchange relationships that not only enhance the establishment processes but also the building and sustenance of a strong position, which gives the firm a competitive edge.

The interdependence between actors thrives best when there is a mutual relation; thus, the interacting parties give and take from each other and are mutually committed (Hägg and Johanson, 1982). The interacting parties strive after openness, understanding, patience, and trust (Håkansson, 1982; Morgan and Hunt, 1994). They also engage in mutual learning (Ford et al., 1986). Being committed to and willing to adapt in the mutually beneficial relationships allows the interacting actors to strengthen the bonds – knowledge, technical, commercial, social and administrative – between them (Håkansson, 1982; Hägg and Johanson, 1982; Ford, 1997). A firm's position in its network becomes crucial (Johanson and Mattsson, 1988). This position gives the firm direct control over its own resources and activities and indirect control over those of others. All this enables the firm to draw on others in its network for support in the establishment process.

#### *The establishment process model*

The establishment process model (Abraham 1994, 2002), as a modification of the network model, enables us to understand the establishment processes of firms in less developed and loosely structured

markets. It consists of four stages: (1) the historical development of the establishment process, (2) the identification and the discussion of the focal relationship(s), (3) the various supporting relationships developed by the establishing firm that enable the focal relationship(s) to function properly, and (4) the general or macro-environment.

**Figure 1: The model of establishment processes**

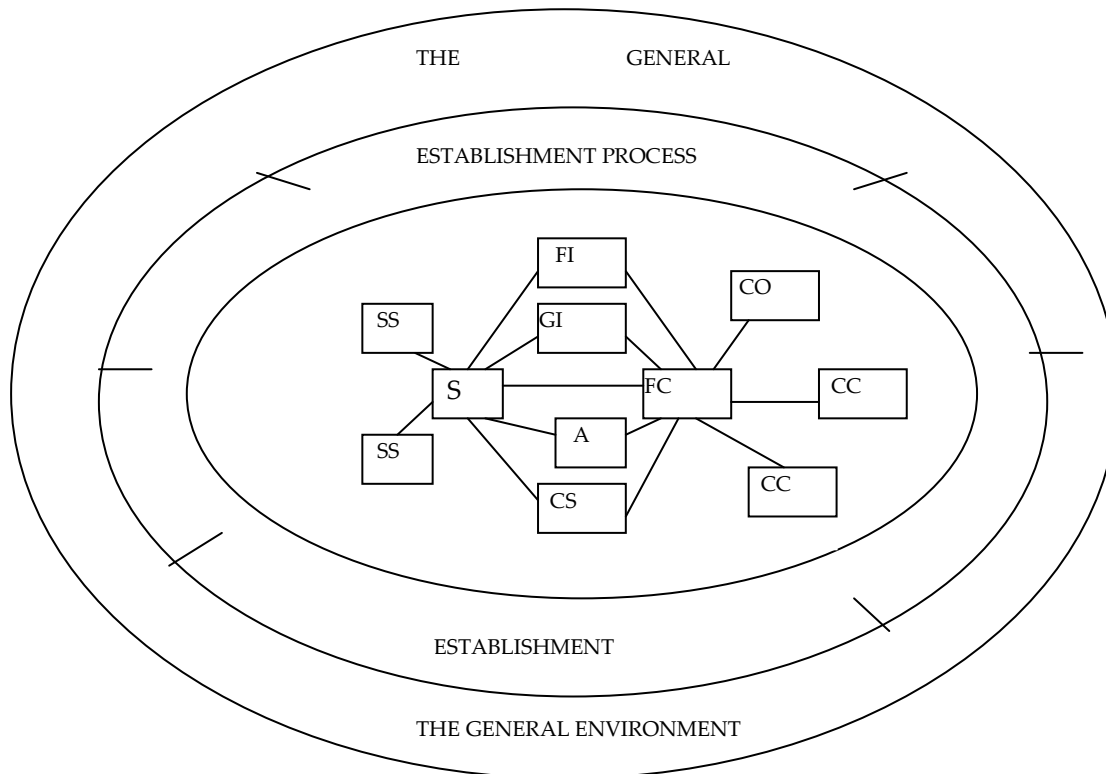

#### Variable definitions

A =Agent      Co=Consultant    CC=Customer's Customer

CS=Complementary Supplier    FC=Focal Customer    FI=Financial Institutions

GI=Government Institutions    S =Supplier    SS=Supplier's Supplier

The historical development variable of the establishment process focuses on the actors that were involved (Abraha, 2002) in initiating the establishment process itself and influenced its course of direction, as well as resource allocation within the local market. In view of the availability of, and the access to these resources, actors and industrial activities, a judgment would have to be made on the part of the establishing firm regarding whether or not there exists a potential network in the local market. Hence, an actor, in search of other actors that can complement the former's efforts, can abandon old relationships and/or add a relationship to already existing ones (Johanson et al., 1994; Axelsson and Easton, 1992).

The second variable relates to the focal customer relationships and assesses these relationships in terms of their stability and strength. It also deals with the identification of resources that are to be exchanged between the establishing firm and its main customer(s). These resource exchanges are grouped under products, services, and human- and financial resources. In order to strengthen their relationships, the actors in interaction may make several adaptations (Håkansson, 1982). It is therefore crucial that the parties mutually undertake technical, financial, organizational, logistical, social and economic adaptations.

The supporting relationships, as encompassed by the third variable, are the relationships of the establishing firm to other actors. The other actors help to ensure that the focal relationship functions properly. Evidence suggests that the establishing firms often have to build these supporting relationships (Abraha, 1994; Johanson et al., 1994) because a well-developed network of industrial actors' is unlikely to exist in the local market at the time of entry.

The fourth variable constitutes the general operating environment within which the process of establishment takes place. Here, issues such as the availability of qualified manpower, financial institutions, government rules, regulations and policies, political factors, infrastructure conditions and culture are considered.

The following additional information can broaden our understanding of Figure 1: (1) *the historical development* of the establishment process is the one next to the general environment, what we call the "establishment process", (2) *the focal relationship* is the one indicating the connection among the supplier (S) and the focal customer (FC), (3) *the supporting relationships* are all the other relationships surrounding the focal relationship, and (4) *the general environment* is the outer part of the figure immediately adjacent to the establishment process variable.

## METHODOLOGY

A qualitative (Marshall and Rossman, 1995) case study approach was appropriate since "case studies are the preferred strategy when *how* or *why* questions are being posed, when the investigator has little control over events, and when the focus is on a contemporary phenomenon within some real-life context" (Yin, 1994, p. 1). Selecting the researchers as the "instrument" for data collection and analysis enabled the researchers to get "close" (Lincoln and Guba, 1986, p. 210) to the respondents and develop trusting relationships. This allowed the researchers to understand the realities of the respondents and uncover issues of relevance in understanding the substantive issues regarding the adopted establishment model, which in turn facilitate understanding of the establishment processes of firms in less developed and loosely structured markets.

*Data collection process*

The cases were selected according to the criteria's: (1) companies that established in Croatia and Estonia during 1990s, (2) actively participated in the establishment companies' interest in the research problem and (3) their willingness to provide information for the study (Fjellström & Guttormsen, 2015). The interview guide covered: the history of the establishment process and how it evolved over time; the main actors (company and non-company actors), and, vital relationships and ties (economic and non-economic) between the various actors that facilitated the processes of establishment. Interviews were conducted with key informants at Statoil's subsidiary office in Stockholm, Sweden, in the autumn of 2004 with duration of each interview between 90 minutes and two hours.

After the interviews with managers at Statoil, it was deemed necessary to seek additional information from other significant actors by the managers as having played an active role in the process. Additional sources of information on the macro-environment were therefore collected from the following: officials at the Swedish and Norwegian Trade Councils, and Norwegian and Swedish Embassies in Estonia: and press attachés responsible for cultural, trade and commercial activities. Data was collected from them through telephone conversations and complemented by e-mail contacts to elaborate on issues not properly dealt with during the telephone conversations. Everyone interviewed participated actively in the establishment process.

In the second case, most of the interviews were conducted through telephone and follow-up emails due to limited resources and geographical distance. The interview guide was sent electronically to the respondent in advance in order for the interviewees to prepare for the interview. The telephone interview was taped and the interviewer also took notes.

According to Maxwell (1996), "the main threat to valid description, in the sense of describing what you saw and heard, is the inaccuracy or incompleteness of the data. The audio or video recording of observations and interviews, and verbatim transcription of these recordings, largely solves this problem..." (p. 89). In compliance with Maxwell's observation, audio recording of the interviews enabled us to be attentive during the conversations with the respondents. To avoid potential challenges during the interview, the respondents were informed about how the interviews were going to be conducted and the purpose of recording the interviews. For ethical reasons all respondents remain anonymous.

*Data analysis*

The data collected was analysed in three steps: data reduction, data display, and conclusion drawing and verification (Miles and Huberman, 1994). Data reduction entails selecting and excluding/filtering data in order to focus, discard and organize the data in such a way that conclusions can be drawn and

verified (ibid.). As for the tape-recorded interviews, this analysis process began while transcribing the interviews. The aim of data display is to organize the data into a compressed assembly of information to elucidate appropriate conclusions and action. Accordingly, main themes were extracted by using the various main parts of the analytical framework as a framework to give the research findings an appropriate structure. Conclusion drawing and verification focuses on reflecting and understanding the data chosen for display.

Although the process was initiated already at the initial stage, this step was more dominant during the later stages of this research. Despite the fact that these three steps are viewed as separate processes of analysis, it is important to note that the processes were going on simultaneously in this study. The findings that emerged have been analysed on a case by case basis to look for convergence and divergence with the theoretical framework. This approach reduces the introduction of bias into the interviews and results by a particular researcher, and conforms to recommendations regarding source, interviewer and analytical triangulation in qualitative research (see Yin, 1994).

## **THE CASE OF SCANIA IN CROATIA**

### *The Historical Development of the Establishment Process*

Scania operated in the former state of Yugoslavia in the 1960s. The firm was represented by an agent for nearly 30 years, Auto Makedonija (AM), who mainly sold heavy trucks since foreign firms were not allowed to import or to set up fully owned business entity. AM mediated deals between Scania and local customers. Contracts were signed directly between Scania and its customers. Scania's personnel visited AM several times and transferred necessary marketing knowledge. Market share was about 30% of then. AM was located in Macedonia, south of the six republics that made up Yugoslavia. Geographical distance was the main problem. It was difficult to interact with customers in northern Yugoslavia, where the largest volume of the transportation market was located. While AM was successful and acquired a market share of over 50% in the south, it was less successful at gaining market shares in the north.

In the 1980s, it opened several representation offices in Sarajevo, Belgrade, Zagreb and Ljubljana to sell Scania trucks in the northern part of the country. Customers in Macedonia, i.e. the state-owned transport company, Vardar, were satisfied with the services. However, some customers located in Zagreb and Belgrade complained about the distance, technical support and spare parts delivered by Skopje. Despite its efforts, it was unable to achieve a meaningful market share in the north. Consequently, in 1991, it terminated the agency contract and to work with an exclusive agent following the independence of Slovenia and Croatia.

From 1991 until 1998, Scanadria SC, a private Croatian firm, was appointed as Scania's agent, located in the north. Various problems were encountered during that time. Geographical distance was again a problem since they were unable to achieve a large market share in other parts of the country. Secondly, Scanadria other activities comprised about 90% of its sales volume and could not specialize in Scania's operations. Furthermore, Scanadria was not prepared to make the necessary investment in Scania's program (garages and after service). Customers had to travel to Italy to get services. Consequently, the contract was terminated and Scania took on full responsibility of its operations by opening a fully owned sister company.

In 1997 our key informant was assigned Managing Director (MD) to form and lead Scania East Adriatic Region SC (SEARSC) the company located in Slovenia. A market research showed GDP growth potential to grow five times in the coming five-years period. Scania Hrvatska SC, was established 1998 to serve the Croatian market. The demand for trucks was high. An 'entrepreneurial spirit' who had developed two sales centres in East Germany with competence to build and manage Scania's local sales company in Croatia was employed. Sales people, technicians and economists with a Croatian background and the necessary qualifications were also employed. All goods were imported from Scania's plants in Sweden, Holland and France with both sales and after-sales service since trucks require both repairs as well as maintenance services.

#### *The Focal Relationships.*

Repair services could now be executed in the garage in Zagreb instead of travelling to Italy. These service opportunities enabled Scania Hrvatska to inherit the old circle of customers. Potential new customers were identified in Northern and Eastern Croatia, after about two years, it managed to develop a network of customers in those areas. Customers who bought Scania's trucks and services at the initial stage were companies that dealt with international transport. Later, Scania started to sell to state-owned companies like Hrvatske Autoceste, a road construction company, and Hrvatske Sume, a timber exporter, and PAN a paper industry firm.

Due to the lack of domestic production in Croatia, "Scania Hrvatska's main duty [was] to sell trucks, perform repairs, and provide other related services." Its products are the most expensive ones in the market and that is because Scania's trucks are of a higher quality than those sold by its competitors. According to the customer relations manager, "in less developed markets such as the one that existed in Croatia when the sales office was first established, much emphasis was put on pricing, as the customers did not have the financial capacity to buy such expensive trucks."

However, as the market became more developed and demanding, customers started to value other things in addition to price, such as high quality services and better equipped garages, as well as



availability and accessibility of the garages, i.e. the opening hours of service centres, and financial solutions (credit sales, leasing and rental) since there was a lack of well-developed banking services. One problem was that customers could not pay in time and had no liquidity although payment period was extended from 30 to 60 days or from 60 to 90 days. According to the MD, Scania was aware of the prevailing economic conditions adapted to the situation so that customers could make partial payments and offering other financial benefits.

“The social adaptations made by Scania are also of major significance, as Croatian customers expect to have strong social relationships with sales representatives.” Because most of Scania’s salespeople were Croats, the social issues did not pose a problem. Customers like to establish a personal relationship with a senior manager in the company, and thus the MD was expected to learn the local language. The technical adaptation made by Scania involved adapting their trucks according to the customers’ technical preferences and demands.

The organizational adaptation made after the transformation of the country from a planned- to a market economy was extremely significant for the company’s continued operations, according to the Croatian manager. Scania’s strategy was to appoint a West European MD in CEE, who could transfer the market economy perspective to the local employees. “Scania’s principle is to be a local Croatian company with foreign ownership. It endeavours to follow all local rules and regulations, as well as traditions, and to act as a Croatian company,” according to the regional manager. “During the early stages of its operations, Scania had problems with transferring the market economy approach to its employees, as the planned economy perspective was deeply rooted in their ways of managing a company and doing business,” said the regional manager. Searching for customers was not considered important. The Croatians maintained a belief that, as a foreign firm, Scania should invest in Croatia and, as it was financed from Sweden, it should not receive any profit. According to the Croatian manager, Scania Hrvatska’s goal, on the other hand, was to be self-financing and to operate at a loss during the initial years of its operations if necessary, but to generate revenues as soon as possible that can be reinvested in its operations.

#### *Supporting relationships*

There was a demand from the market to open more garages with financing and equipment from the head office in Sweden. Potential partners were primarily small family businesses, who were interested in being trained and authorized by Scania. A local branch office and service centre opened in Split since no partners were found in the South. Scania quickly learned how important it was to develop good relationships with the authorities. The authorities were very willing to cooperate, especially with foreign firms. However, although they welcomed foreign investment, the bureaucracy was difficult to

deal with and has a serious effect on a firm's operations. The certification of all documents, import documents and contracts must be performed personally by a notary public. So a back office was established in Zagreb to provide administrative assistance in connection with imports. The bureaucratic set-up was complicated and made operations time-consuming with additional costs.

The local competition was very strong. Seven strong European truck producers were represented; Volvo, Mercedes, MAN and Iveco had a market shares between 15-20%, while Renault and DAF had a relatively small share. Croatian competition law was very strict and did not allow extensive cooperation among competitors. Scania's local contacts with the other truck producers (competitors), never discussed prices or marketing issues.

Scania's prices were higher than its competitors, while it offered the most reliable product with less time spent in garages and service centres, consume less fuel, and have a lower repair frequency. Another advantage of Scania was the organizational structure with a network of garages and service centres for after-sales services. If a certain spare part is missing in one garage/service centre, it can be delivered within 24 hours from another garage or service centre in the country. In cooperation with MAN, Scania has succeeded to build the best and most widely spread distribution net in the country, an edge over its competitors. According to our key informant, "the company's weak point was purely geographical distances, and its location in Southern Croatia where Scania Hrvatska has a lower market share than in other parts of the country". It attempted to address this problem by opening a branch office in Split and attract more (state-owned) customers. The company expects the situation to improve, as the ideological (friendship) corruption of the old system has slowly started to disappear, making it easier to get closer to and develop intimate relationships with the state-owned transport companies, according to the same source. Scania does its best to develop social contacts with other significant actors in the market so that it can get the state-owned companies as customers.

Scania Hrvatska SC increased its market share from 5% (1998) to 17% (2003). To achieve 20% market share level several measures were initiated. First was active marketing by identifying potential customers, developing personal contacts, visibility on exhibitions, trade fairs and sales representatives. Parallel to this they built up a national service network.

#### *The General or Macro-Environmental Factors.*

Corruption was not as widespread in Croatia as in other countries in the region, but bribes were required in order to facilitate speedy service. A 'friendship corruption' of a non-economic character (also known as 'ideological corruption') was common in state-owned companies and was practised mainly from 1991-1999 (during transition from a planned- to a market economy). A typical example involves that of the German firm MAN that was represented in the market for several years. The

government ordered all state-owned companies (e.g. Hrvatske Autoceste and Hrvatske Sume) to buy 'Croatian' products, i.e. trucks from MAN, which were sold by a Croatian agent. Although Scania won state contracts on several occasions, showing that it could offer the best products at the most attractive prices, the government stepped in and stopped the purchases. The MDs of these state-owned firms, which are inherited from the old regime, are still in power and have personal contacts with certain individuals in high positions in the government apparatus. Both the MDs and the government bureaucrats favour each other and do business according to the same old style.

Concerning the social environment, business is often done with people you know. Having the right personal contacts is considered extremely important in business deals. If it lacks these personal contacts, a new company in the market is seen with scepticism. Croatian business deals are less formal so, before one does business with other actors, the parties must know each other. These personal relations have a significant influence on business deals between companies and the building of social networks," according to our main source.

## **A CASE STUDY OF STATOIL IN ESTONIA**

*The historical development of the establishment process.*

Estonia was no longer a part of the former Soviet Union when Statoil entered the market. But since the legislation was still part of the old Soviet system, Statoil needed Soviet approval to enter the market. Negotiations and relationships were initiated with the Estonian and Soviet authorities responsible for international establishments, i.e. key officials in the foreign trade department. An appropriate strategy was to let the Estonian authorities act as mediators and translators in the process.

According to a key informant, during the final phase of the establishment process, Statoil management presented its Corporate Social Responsibility (CSR) strategy. The strategy covered perspectives from society, health, safety and environmental protection, to conditions of employment, industry and labour standards, social development and human rights. This strengthened the level of trust and commitment for both parties. Statoil was able to gain an understanding and new insights into the Estonian market and society as whole. Statoil would be better prepared for potential risks and be regarded as a contributor to the wellbeing of the society at large. Statoil's market involvement was on a long-term basis since they offer a necessary and important product for society. While, one informant considered it risky for Statoil to enter the Estonian market because the culture was different, the technological level was low, and business legislation was poor. Statoil managed to gain the support from influential organizations and authorities, which reduced the risk of investment. Estonian authorities were very risk-averse. Statoil arranged information meetings where plans and problems

were discussed to that contributed to a more open communication between the parties and reduced the risk for misunderstandings during the establishment process.

#### *The focal relationships*

A network of relationships was developed with different actors in the industry, i.e. the supply chain. The objectives for forming the relationships with the actors were twofold: “firstly, to increase the probability of success of the establishment of Statoil in Estonia; and secondly, the quality of the relationships formed with various actors that constitute the supporting relationships would facilitate proper functioning of the focal relationships between Statoil and its ultimate (business) customers.” Furthermore, the key informant stressed that the company knows that availability of the company’s products is of utmost importance in the oil industry. It was necessary for the company to be present in Tallinn for its brand name to have adequate exposure for domestic and international communities. One informant expressed: “We therefore claim that branding is vital for every company in the oil industry. Lack of familiarity can have negative consequences in a business such as this and the enormous job done during the establishment process may be jeopardized if our relationships with our customers are not maintained. This means that it is very important to develop strong bonds with different local actors in the supply chain, including all categories of customers throughout the value creation process”.

#### *Supporting relationships*

Relationships proved to be important, “...(they) played a decisive role in facilitating proper functioning of relationships with the focal actors.” The Swedish Ambassador and the Swedish Foreign Minister helped Statoil develop contacts with the Estonian Foreign Trade Department. The Norwegian ambassador was involved in negotiating sites to establish service stations.

Another informant explained: “The relationship network was of utmost importance for the establishment, but the managerial approach, which was characterized by great respect, was also a part of the winning concept. To avoid problems and discuss plans, information meetings were arranged. Service management was taught by Swedish employees, who at the same time facilitated the transfer of market knowledge back to the company”.

Contacts were established with International Monetary Fund, the World Bank and the European Union. Statoil management was aware of the fact that these financial partners were ready to assist firms based in market economies, with the financial resources necessary to facilitate establishment in a

transition economy. This facilitated the establishment of the institutional framework necessary for gradual introduction of a full-scale market economy.

One of our informants pointed out that “the Nordic countries had in place the Baltic Investment Programme, a program financed by the Nordic governments and the European Bank for Reconstruction and Development. Furthermore, to improve regional co-operation, the Council for the Baltic Sea States was established 1992. Companies that were able to bring these sources of finance together and establish a local contact base had a competitive advantage in entering the market. Consequently, Statoil was able to do this and use its home nationality and ownership to its edge in assembling a contact and finance network to establish operations in the Estonian market. The Norwegian government has also established trading agreements with the Baltic States, as other Nordic countries would have.

The role of the Swedish Trade Council was to assist Statoil’s management in securing all of the services required to establish a company and its products, services or ideas in the new market. Knowledge was acquired through, among other things, feasibility studies, marketing plans, export strategies, market surveys, and competition analysis carried out and supplied by the Swedish Trade Council. The Swedish Trade Council’s Information Centre also provided advice and information about regulations and trade practices in Estonia. These tasks were accomplished through close collaboration with the Swedish Embassy, Consulate and Chamber of Commerce in Estonia.

#### *The General or Macro-Environmental Factors*

The administrative system was rigid and centralized, business legislation was defective and a general suspicion against Western investments existed; trust was totally decisive. Government and local actors compromised. Prior to the establishment decision “Statoil management was informed by reliable sources such as the Baltic Investment Programme, the chambers of commerce in Sweden and Norway, as well as the trade councils in both countries, that many Western-based companies had failed in their attempt to enter Eastern markets at that time.” Statoil possessed a “respectful negotiation manner” in which parties were very culturally sensitive during its encounters with authorities. Our source explained: “Statoil tends to show respect for the local culture and traditions and in doing so avoids misconceptions that might otherwise arise when foreign investors enter a market. Statoil tries to anticipate potential problem areas through political, environmental and social impact studies. Cultural differences influence attitudes towards information, openness, communication patterns, flexibility, adaptability and risk.”

Statoil management discovered at the inception of the establishment plans that data available was inaccurate and sources inadequate. To overcome the lack of market knowledge, was through the use

of network of relationships with industrial actors, institutional actors (Baltic Investment Programme) and NGOs provided Statoil with crucial market knowledge. Statoil could supplement the available data with its own market research. According to one key informant, "Estonian authorities were willing to cooperate, since the country was then negotiating its membership in the European Union. Letting foreign companies invest is contributing to an open economy. Consequently, Statoil takes advantage of this quest by developing relationships with the appropriate government and state agencies in Estonia as well. "Such actors are key players when it comes to national interests. The establishment also created vacant jobs for the Estonian society."

## ANALYSIS

In the case of Scania in Croatia, developing market position was successful in a certain region but difficult and less successful in other areas during the early stages of the establishment. In most of the areas, two main reasons led to unsuccessful operations: one was the geographical distance between the agent and the customers with large market shares, and the second was the government regulation preventing foreign firms from operating with fully owned subsidiaries. These two reasons provide practical confirmation of what is theoretically discussed in Ford (2002), Abraha (1994) and Johanson et al. (1994). Ford specifically indicates that geographical distances can have a major impact on the development of buyer-seller relationships.

Abraha (1994) has also demonstrated that government policies and regulations have a major impact on the development of buyer-seller relationships in particular, and on the establishment process in general, which the case of Scania in Croatia confirms. Both of these factors, which create obstacles to establishment, are due to the absence of a market economy model being applied in the region (see also Dikova & Brouthers, 2015). In one area, success was achieved, but can be attributed to the economic system applied there, as it was the state that used to determine the location of where firms could operate. This study shows that there is a network in the market and that how and to what extent a firm can utilize the network depends on the form of operations/establishment allowed and where a firm is located. This in turn demonstrates the importance of interacting intimately with customers and positioning oneself in market networks, one of the central concepts of the network approach (Axelsson and Easton, 1992; Blankenburg-Holm, 1996; and Håkansson and Snehota, 1995). Some customers were very satisfied, whereas those in the major portion of the market were not, the main reason being that there was no direct relationship between Scania and the customers, and a second being the distance between the agent and the customers. This led to Scania taking the decision to terminate the contract with its agent and look for an exclusive agent.

Due to the reasons mentioned above, and others, the appointment of a new agent did not improve Scania's position. The other related reasons were that the agent, which also represented a number of other companies, neither assigned priority to Scania's establishment, nor wanted to make the necessary investments to improve the situation, indicating a clear lack of market commitment. ABB faced the same problem in its Kenyan establishment (see Abraha, 1994), which affected its position. It can thus be argued that the second agent was not able to function in a way that enabled it to manage the relationships with the focal customers properly either. In other words, it could not develop the necessary network to successfully establish Scania and its products. With the establishment of the subsidiary, Scania developed necessary spare parts and services network that enabled the focal relationships, called the building of supporting relationships to facilitate the establishment process (Abraha, 1994; Hånell & Ghauri, 2015).

Moreover, Scania acquired manpower with adequate knowledge and experience of how to operate in a state-controlled economy. It also made several significant adaptations, one of the main ones being financial. In the absence of this adaptation, it would have been difficult for the customers to meet their financial obligations and for Scania to make sales. In brief, Scania supplied all the necessary resources and made the necessary adaptations. Resource exchange and adaptation are at the very heart of the network approach and market establishment, as argued and confirmed by Axelsson and Easton (1992), Ford (2002), and Abraha (1994, 2002).

However, two significant environmental factors were also observed to affect the establishment process. One was the achievement of prior social/personal contacts in the market in order to make a successful business deal, which was not exactly easy for Scania as it had not operated in the market for long (Donaldson & O'Toole, 2007). The second was what we have called "ideological corruption", i.e. a reliance on supplier-customer relationships developed during the former socialist regime. Scania lacked these connections and relationships, which affected its establishments to a certain extent. However, the impact of ideological corruption is gradually decreasing, even though it can not yet be completely ignored as a potential obstacle in the establishment process. These market realities both confirmed and deviated from Abraha's model (1994, 2002). Confirmation is drawn from the fact that the same problems were also observed to be typical in the Kenyan market, while deviation is found in that, in the Croatian case, the problems were substantial and dealing with them very resource-consuming.

The establishment of Statoil in Estonia can be said to have been smooth as it received the support of the various domestic and international actors and their respective networks. These included Swedish and Norwegian authorities, as well as other authorities in the Nordic countries, the Estonian authorities, and several regional and international financial institutions, i.e. the World Bank, the IMF

and the European Bank for Reconstruction and Development. Statoil received the support of these actors in the domestic market and abroad. It can thus be argued that Statoil combined the various types of resources it received from these institutions in providing its products and services to the customers in the local market and in developing the networks necessary to manage its relationships adequately. In sum, Statoil combined domestic, regional and international networks of relationships, and was thereby able to establish itself successfully in the Estonian market. The network approach calls this the “centrality” of a certain market position (see Ford, 1997, 2002; Hägg and Johanson, 1982; Blankenburg-Holm, 1996; Ford et al., 1986).

Statoil can be said to have developed a central position that connects to several significant actors in many directions. In Abraha (1994), these relationships are called “supporting relationships”, as they support and facilitate the concerned firm’s establishment in the market in focus. Once it has developed a successful market network, it will also continue to utilize those networks of relationships in the management of the network developed in Estonia. For example, when it needed its entry permit approved, it followed this process. It first approached the Estonian authorities, which were positive to the initiative. However, it was also necessary to negotiate and gain the approval of former Soviet Union authorities. To do this, Statoil involved the Estonian authorities, who were prepared to get involved and helped to facilitate the permit approval. The Swedish Trade Council also did its part in helping Statoil to become established as a company and to establish its products and services, which can be a real push towards successful establishments. The connections of these authorities also lend further support and confirmation of Abraha’s model and findings (1994, 2002), which suggest that relationships with government agencies are a prerequisite to building a network and managing the network once built.

Major problem that Statoil was confronted with in Estonia was the cultural difference. This is because there was some degree of suspicion of Western investment. In parity with our findings, one of the main concerns of Hennart and Slangen (2015) is how the entry decision process is structured. For example, we could not adopt the network model in its entirety because it takes a more general approach to market establishments as a process of development, and therefore not always appropriate for all types of economies without some modification. As discussed earlier in this paper, firms are exposed to irrecoverable entry costs or transaction costs in international markets (Osarenkhoe, 2009). However, the magnitude of the market entry costs and managerial problems associated with the establishment to leverage a number of significant actors in its network for support during its establishment invariably makes the process less cumbersome and less resource consuming (Johanson & Vahlne, 2003). In a similar vein, Tseng & Kuo, (2008) also suggested two kinds of network strategies: business and social. And that, compared to firms with FDI in the USA, firms investing in



China rely more on co-operative production systems and are more likely to utilize social relationships with the local community and government authorities. Furthermore, internal social and economic cohesion (Buckley et al. 2005) maintained is likely to exert a greater impact on market entry costs and its efficacy.

However, Statoil also makes careful pre-preparations of all possible and potential problems and takes whatever measures are necessary to handle the actual problems. The typical strategy Statoil applies to handle such problems is their Corporate Social Responsibility strategy. This is in agreement with the study conducted by Sankar et al (2006). This clearly indicates that Statoil cares about the society where it operates and that it is not only interested in making money. It also helps the company to show how committed it is and to gain the necessary trust from the authorities and the society.

## CONCLUSIONS

The main objective of this paper has been to provide insights into the extent to which firms draw on a number of significant actors in their network of exchange relationships for support in their establishment processes in foreign markets. The companies studied in this paper have all entered markets that are relatively different from their own domestic markets. Croatia and Estonia are economies in transition, which still exhibit traits of a lack of essential resources, state interventions, and a high level of bureaucracy from their planned economy period. Of importance is a firm's ability to address problems associated with the establishment and development of relationships (Johanson and Vahlne, 2003; Axelsson and Easton, 1992) with significant actors such as customers, intermediaries, local authorities and foreign authorities, because they facilitate a firm's establishment process.

In this study, it has been crucial for Scania (having Sweden as its domestic market) and Statoil (having Norway as its domestic market) to identify and develop exchange relationships with significant actors such as customers, agents, local authorities, embassies, banks and trade councils. As a result of the complementary resources and activities (Yu et al, 2011; Hånell & Ghauri, 2015) which have emanated from the focal and supporting relationships (Abraha & Mukhtar, 2002) that the establishing firms had to develop and maintain, Scania's or Statoil's establishment processes have been both positively and negatively influenced. The positive impact from the various relationships and the environmental conditions are manifest in areas where Scania and Statoil gain a satisfactory market position in their respective markets: the market share seems to grow, access to critical resources does not pose a problem, and bureaucratic obstacles are virtually negligible. Statoil has enjoyed a smooth establishment process due to network access to resourceful actors such as central and local

authorities, industry actors, the World Bank, IMF and EU, Swedish Trade Council, Swedish and Norwegian ambassadors.

However, the negative influences on the firm's (Scania's) establishment processes are manifest in poor market position in large areas of Croatia due to difficulties in reaching end customers, lack of mutual orientation and commitment between the agent and Scania (supporting relationship), and, of course, bureaucratic impediments. The lack of mutual orientation, commitment and trust between the establishing firms and various local actors is attributed to different developmental levels between the domestic markets of the establishing firms and their respective host markets. These have even led to a breakdown of some exchange relationships (Scania versus an agent) and re-creation of others and/or greater commitment to the market by opening the firm's own sales subsidiaries (Scania). All in all, for survival and consolidation of their relative positions, the interacting actors (local actors versus the foreign companies, for example) have to undertake mutual adaptations in a number of areas, for example, finance, business practices and managerial attitude. The study also shows that mutual learning, on the part of the interacting actors, is constantly taking place.

## **IMPLICATIONS FOR THEORY AND PRACTICE**

The context in which this study was conducted further illustrates that a fundamental shift is occurring in the world economy. We are moving progressively further away from a world where national economies were relatively isolated from each other: by barriers to cross-border trade and investment; by distance, time zones, and language; and by national differences in governments, culture and business systems (Hewett et al 2006). This study takes a relationship and network perspective to international business decisions made by international business managers. Specific decisions evaluated from a relation and network perspective include market entry and the establishment process. Earlier we mentioned that traditional approaches to market entry do not emphasize a firm's embeddedness in a social structure and, moreover, that such interdependence is fundamental to a network approach.

The relationship-centred approach demonstrated through the cases that emphasis should be placed on the need for cultural learning to aim, in a close relationship, to know and treat the international partner in the same way as a domestic one. Gaining an international relationship orientation requires adaptation by an organization, but more critically by its managers. Lack of cross-cultural relationship skills and orientation could impede a company's growth in international markets (Osarenkhoe, 2009). Socio-cultural differences between a firm's home country and its host country can create internal

uncertainty for the firm, which influences its establishment processes. The two cases show the importance of the role of culture in international business relationships (Fjellström & Zander, 2016). Culture represents an added dimension to what may be more complex relationships to start with. This type of relational embeddedness requires sensitivity and probably gives companies that try to use a relational approach to understanding international business barriers an added edge.

The question, then, is: What does this imply for managerial decisions in international relationships? Firstly, a need to understand the cultural context of foreign relational partners (see also Hewett et al, 2006 and Fjellström & Zander, 2016). Secondly, managerial skills, for example, the ability to negotiate and integrate socially across cultures, are important. Consequently, to operate in a company's external environment, its managers must have not only knowledge of business operations, but also a working knowledge of the basic social sciences: political science, law, anthropology, sociology, psychology, economics and geography (Kodama, 2006). This assertion or implication is further legitimized in part by the cases presented in this paper, and in part by the theoretical framework, the network approach, which has its roots in sociology rather than economics and takes a contrasting view of the firm's links with its environment (Johanson and Mattsson, 1988; Axelsson and Johanson, 1992).

Cultural differences influence relational processes and attitudes such as openness, the propensity of trust and commitment, communication patterns, attitudes toward risk, adaptability and flexibility, and business ethics (Hunt & Morgan, 1994; Fallon, 2004). This paper shows that in order for these differences to be incorporated into strategy, when managing relationships across cultures, they need to be examined in depth, and thus subjected to more scientific scrutiny in future research of similar scope and context (Donaldson and O'Toole, 2007). We therefore call for more research efforts in the area of cultural dimensions with regard to market establishment processes. Once entry has been considered, attention then turns to the growth and development of the firm or the internationalization of the firm. In future research, the void can be filled by investigating how markets can be expanded using a relationship approach. Moreover, future studies might consider providing questionnaire study with a comparison from other countries, especially CEE, and put more attention on economic data than on historical story.

Against this background, it is apparent from this paper that one of the principal challenges of entering a new international market is that developing network connections may involve restructuring the firm's network: To become established in a new market, that is, a network that is new to the firm, the firm has to build relationships that are new both to itself and to its counterparts (Hollensen, 2001; Osarenkhoe, 2009). Aharoni (1966) argues that, because each decision influences later decisions, international investment decisions should not be viewed in isolation. If a firm enters a country using a

distributor, but then disagrees over the terms of the contract, it may not make any further investment in the country. A manifestation of this can be found in the Scania case, in which Scania terminated its relationship with Scandria in Croatia because of its lack of trust and commitment. Kinch (1992) highlights the difficulties of breaking into advanced economies where the actors tend to have long-established and stable relationships. A new entrant might find it difficult to form links with a distributor who does not supply products for one of his competitors. At the opposite end of the continuum, if the network of relationships in the host market is changing rapidly, as in emerging markets, there may appear to be greater opportunities, but it may be difficult to identify appropriate partners and attractive investments.

## REFERENCES

- Abraha, D. (1994), Establishment processes in an underdeveloped country: The case of Swedish firms in Kenya, PhD Dissertation, Uppsala University, Sweden.
- Abraha, D. and Mukhtar, S-M. (2002), The process of firm establishment in less developed and loosely structured markets: A case study of two Swedish firms in Kenya, *Journal of International Business and Entrepreneurship*, Vol. 9, No. 1, pp. 85-108.
- Aharoni, Y. (1966), *The Foreign Investment Decision Process*, Boston, MA: Harvard University Press.
- Ashton, P. (2006), Fashion occupational communities – a market-as-network approach, *Journal of Fashion Marketing and Management*, Vol. 10 Issue 2, pp. 181 – 194.
- Axelsson, B. and Easton, G. (1992), *Industrial Networks - A new view of reality*, London: Routledge.
- Axelsson, B. and Johanson, J. (1992), Foreign market entry - The textbook versus the network view, in Axelsson, B. and Easton, G. (Eds.), *Industrial Networks - A new view of reality*, London: Routledge.
- Blankenburg-Holm, D. (1996), *Business Network Connections and International Business Relationships*, Dissertation, Uppsala: Uppsala University, Sweden.
- Blomstermo, A, Sharma, D.D. and Sallis, J. (2006), Choice of foreign market entry mode in service firms, *International Marketing Review*, Vol. 23, Issue 2, pp. 211 – 229.
- Buckley, P.J., Clegg, J., Cross, A.R. & Tan, H. (2005) "China's Inward Foreign Direct Investment Success: Southeast Asia in the Shadow of the Dragon", *Multinational Business Review*, 13(1), 3 – 31
- Chetty, S. and Blankenburg-Holm D. (2000), Internationalisation of Small to Medium-Sized Manufacturing Firms – a network approach, *International Business Review*, 9, pp. 77-93.
- Chi-Hsing Tseng, Hsin-Chih Kuo, (2008) "Internationalization and Network Strategies: Taiwanese Firms' Foreign Direct Investment in China and the USA", *Journal of Asia Business Studies*, Vol. 3 Iss: 1, pp.23 – 32
- Dikova, D., & Brouthers, K. (2015). International Establishment Mode Choice: Past, Present and Future. *Management International Review*, 1-42.
- Donaldson, B. and O'Toole, T. (2007), *Strategic Market Relationships: From strategy to implementation*, Chichester: John Wiley & Sons Ltd.
- Dunning, J. (1980), Towards an eclectic theory of international production: Some empirical tests, *Journal of International Business Studies*, 11 (1), pp. 1-13.
- Dunning, J. (1993), *Multinational Enterprises and the Global Economy*, Wokingham: Addison-Wesley.
- Dunning, J.H. (2002), *Global Capitalism, Foreign Direct Investment and Competitiveness*, Cheltenham, UK: Edward Elgar, pp. 146-169.
- Fallon, G., Cook, M. and Jones, A. (2004), The determinants of foreign direct investment in Central and Eastern Europe, *Proceedings Academy of International Business conference*, University of Ulster, Ireland, April 2004.
- Fjellström, D. and Guttormsen, D. S. A. (2016) "A critical exploration of "access" in qualitative international business field research: Towards a concept of socio-cultural and multidimensional research practice", *Qualitative Research in Organizations and Management: An International Journal*, 11(2), 110 – 126
- Floyd, D. (2002), Investment decisions in Eastern Europe: choosing the optimum investment – the case of Poland, *European Business Review*, Vol. 14 Issue 2, pp. 98-103.

- Ford, D. (1997), *Understanding Business Markets*, 2nd edition, London: The Dryden Press, Harcourt Brace & Company.
- Ford, D., Håkansson, H. and Johanson, J. (1986), How do companies interact? *Industrial Marketing and Purchasing*, No. 1, pp. 26-41.
- Greve, Argent (1995) Networks and entrepreneurship – an analysis of social relations, occupational background, and use of contacts during the establishment process, *Scandinavian Journal of Management*, 11(1), 1-24.
- Hennart, J-F. (1982), *A Theory of Multinational Enterprise*, Ann Arbor: University of Michigan Press.
- Hennart, J. F., & Slangen, A. H. (2015). Yes, we really do need more entry mode studies! A commentary on Shaver. *Journal of International Business Studies*, 46(1), 114-122.
- Hewett, K. Money, R.B. & Sharma, S. (2006), National Culture and Industrial Buyer-Seller Relationships in the United States and Latin America, *Journal of the Academy of Marketing Science*, Vol. 34, pp 386-402
- Hunt, S.D. and Morgan, R.M. (1994), The commitment-trust theory of relationship marketing, *Journal of Marketing*, 58, pp. 20-38.
- Håkansson, H. (Ed.) (1987), *Industrial Technological Development- A network approach*, London: Croom Helm.
- Håkansson, H. and Snehota, I. (1995), *Developing Relationships in Business Networks*, London: Routledge.
- Hånell, S. M. and Ghauri, P. N. (2015), Internationalization of Smaller Firms: Opportunity Development through Networks. *Thunderbird Int'l Bus Rev.* doi: 10.1002/tie.21763
- Johanson, J. and Vahlne, J-E. (2003), Business relationships learning and commitment in the internationalisation process, *Journal of International Entrepreneurship*, Vol. 1, pp. 83-101.
- Johanson, J. and Associates (1994), *Internationalization, Relationships and Networks*, Acta Universitatis Upsaliensis. *Studia Oeconomiae Negotiorum*, 36, Uppsala University, Sweden.
- Johanson, J. and Mattsson, L-G. (1988), Internationalisation in industrial networks – A network approach, in Hood, N. and Vahlne J-E. (Eds.), *Strategies in Global Competition*, London: Croom Helm, pp. 287-314.
- Johanson, J. and Vahlne, J-E. (1977), The internationalisation process of the firm - A model of knowledge development and increasing foreign market commitments, *Journal of International Business Studies*, Vol. 8, pp. 23-32.
- Johanson, J. and Vahlne, L-E. (1990), The mechanism of internationalisation, *International Business Review*, Vol. 7, No. 4, pp.11-24.
- Johanson, J. and Wiedersheim-Paul, F. (1975), The internationalisation of the firm – Four Swedish cases, *Journal of Management Studies*, 3 (October), pp. 305-322.
- Johanson, J. and Mattsson, L-G. (1988), Internationalisation in industrial systems – a network approach, In Hood, N. & Vahlne, J-E. (Eds.), *Strategies in Global Competition*, London: Croom Helm: pp. 287-314.
- Kim, B., Kim, H. and Lee, Y. (2002), Modes of foreign market entry by Korean SI firms, *Asia Pacific Journal of Marketing and Logistics*, Vol. 14 Issue 4, pp.13-35.
- Kinch, N. (1992), Entering a tightly structured network – Strategic visions or network realities, In Koch, A.J. (2001), *Factors influencing market and entry mode selection: developing the MEMS model*, *Marketing Intelligence & Planning*, Vol. 19 Issue 5, pp. 351-361.
- Kodama, M. (2006), Knowledge-based view of corporate strategy, *Technovation*, Vol. 26, Issue 12, pp. 1390-1406
- Lincoln, Y.S. and Guba, G. (1986), *Naturalist Inquiry*, London: Sage Publications.
- Manolova, T. S., Manev, I. M., & Gyoshev, B. S. (2010). In good company: The role of personal and inter-firm networks for new-venture internationalization in a transition economy. *Journal of World Business*, 45(3), 257-265.
- Marshall, C. and Rossman, G. B. (1995), *Designing Qualitative Research*, California: London: Sage Publications.
- Mattsson, L-G. and J. Johanson (2006), *Discovering Market Networks*, *European Journal of Marketing*, 40 (3/4), pp. 259-74.
- Maxwell, J.A. (1996), *Qualitative Research Design*, London: Sage Publications.
- Miles, M.B. and Huberman, A.M. (1994), *Qualitative Data Analysis*, London: Sage Publications.
- Osarenkhoe, A. (2009), “An Integrated Framework for Understanding the Driving Forces behind Non-sequential Process of Internationalisation among Firms”, *Business Process Management Journal*, 15(2), 286-316.
- Root, F.R. (1994), *Entry Strategies for International Markets*, New York: Lexington Books.
- Sankar S., Bhattacharya, C. B and Korschun, D. (2006), The Role of Corporate Social Responsibility in Strengthening Multiple Stakeholder Relationships: A Field Experiment, *Journal of the Academy of Marketing Science*, Vol. 34, pp 158-166.
- Sun, H. (1999), Entry modes of multinational corporations into China’s market: a socioeconomic analysis, *International Journal of Social Economics*, Vol. 26 Issue 5, pp. 642- 660.
- Tikkanen, H. (1998), The network approach in analyzing international marketing and purchasing operations: a case study of a European SME’s focal net 1992-95, *Journal of Business & Industrial Marketing*, Vol. 13 Issue 2, pp. 109-131.

- Turnbull, P. and Valla, J-P. (1986), *Strategies for International Industrial Marketing: The Management of Customer Relationships in European Industrial Markets*, London: Croom Helm.
- Wheeler, C., Jones, M. and Young, S. (1996), Market entry modes and channels of distribution in the UK machine tool industry, *European Journal of Marketing*, Vol. 30 Issue: 4, pp. 40-57.
- Williams, D. (1997), Strategies of multinational enterprises and the development of the Central and Eastern European economies, *European Business Review*, Vol. 97 Issue 3, pp. 134-138
- Yin, R.K. (2002), *Case Study Research, Design and Methods*, Newbury Park: Sage Publication.
- Yu, J., Gilbert, B.A. & Oviatt, B. (2011), Effects of alliances, time, and network cohesion on the initiation of foreign sales by new ventures, *Strategic Management Journal*, Volume 32, Issue 4, pages 424–446.

## CLUSTERING AND NETWORKING AS A SINE QUA NON FOR SMES AND REGIONAL INTERNATIONAL COMPETITIVE ADVANTAGE

Osarenkhoe, Aihie; Fjellström, Daniella

University of Gävle, Department of Business & Economic Studies, Gävle, SWEDEN

### ABSTRACT

*Extant literature gives the impression that formulation of a firm's strategic intent is a unilateral process solely confined to a single firm. This study respond to calls to expand inter-firm relationships study beyond the narrow dyadic relationship focus and not solely conceptualize collaborations as one of firms' strategic intent to implement mechanistic growth strategy. Hence the following **research question**: How are the collaborative networks of private and public partnership organized to enhance competitiveness for actors in a cluster? And what are the perceptions of the actors in the cluster on the usefulness of clustering and networking? **The objective** is to map the salient features of existing clusters and networks and unveil firms' perceptions of benefits accrued from clustering. **Theoretical lens** builds on clustering as an interactive learning process, and happens in the interaction between actors as open innovation postulates and that innovation is born out of reshuffling resources inside and outside of the firm and considers the mutual value creation between the involved. **Methodology** draws on focus group interviews, semi-structured and open-ended survey in cluster initiatives and strategic networks in Kronoberg region. **Findings** show that networking, dialogue, and experience exchange were the recurrent themes when firms expressed the benefits of collaboration in a cluster/network setting. **Conclude** that unveiling the salient features of existing clusters and networks and perceptions of the actors on gains accrued from clustering and networking, accomplished in this study, is the first step in a cluster development process. **The implications** are that relationships of firm in a domestic network are critical avenues for acquisition of resources and knowledge for enhancement of competitiveness, and as bridges to other networks in other countries. We present an explanatory model of cluster and regional competitiveness which emerged from our findings.*

*Keywords: Clusters, Networking, International competitiveness, Strategic network*

### INTRODUCTION

The extant literature stresses that having foreign market presence is imperative for most firms these days (Awuah, Osarenkhoe and Abraha, 2011). This is particularly vital for Small and Medium Enterprises (SMEs) which are increasingly considered an important, though neglected, research field

despite the fact that SMEs are considered the engine of a country's economic growth (Sawers et al., 2008; Zeng et al., 2010; Suhail, 2014; Resnick et al, 2016). SMEs attract interest of policy makers, since they represent the majority of the economic structures and they are the main employers of a country (Tödtling & Trippel, 2008; Solleiro & Gaona, 2012). According to Hossain & Kauranen (2016), SMEs have the ability to react and adapt faster to the changing needs and environment, and argue that the successful development of these enterprises enhances the competitiveness of a country.

Against this background, it is paradoxical that "little is known about the conditions under which SMEs may be able to achieve growth when facing specific constraints. For example, it has been argued that SMEs could enter into coalitions with external organizations in order to obtain resources and information" (Hessels and Parker, 2013, p.1). Furthermore, Costa et al. (2016, p 1) argue that "the current literature is unclear about the way SMEs can access information and assimilate knowledge in a collaborative network context, to support decision-making". And they continue "in the current literature, it is not clear how SMEs assimilate information from their networks and collaboration activities for making better decisions in terms of internationalization" (ibid). Thus firms are reeling from discontinuities created by a growing level of globalization, heightened volatility, hypercompetition, demographic changes, and the explosion of knowledge (Tödtling& Trippel, 2008; Ter Wal & Boschma, 2011). Ever faster means of communication alter today's business climate and it is becoming more evident every day that we cannot anticipate the environment of tomorrow. The paradox highlights the importance of SMEs in the global economy, while current researches discuss the shortcomings of in-depth and detailed knowledge into how SMEs interact with their surroundings.

It is evident from this scenario that globalization process and benefits accrued from global market opportunities, and "pushing the companies to develop and adopt a proactive international approach in order to take advantage of the new situation" (Portero, Hervás-Oliver & Puig, 2012, p. 266) have given rise to two main challenges currently being faced by SMEs: first, to transform themselves and increase their individual competitiveness (Fassoula, 2006 cited in Karaev et al. 2007), and second, due to their limited size to take advantage of synergy effects created by entering into cooperative relations with other SMEs and related partner institutions. Hence increased interest in regional development among policy-makers is spurred by an upsurge in interest in regional issues on the part of researcher, which is manifested in greater attention to the cluster concept and the somewhat overlapping concept of industrial districts (Johanson & Lundberg (2011).

A perspective that has gained a great impact in recent years is that which is based on the so called open innovation (Chesbrough, 2003). Chesbrough et al., (2006, p. 1) define open innovation as the use of purposive inflows and outflows of knowledge to accelerate internal innovation, and to expand the



markets for external use of innovation, respectively.' Open innovation requires much more interactions between different actors with different organizational cultures: large firms and SMEs (i.e. industry), universities and research institutions (i.e. academia), as well as national and regional authorities for building the legal or incentive framework of innovation (i.e. government) (Lecler et al, 2015).

There are calls in extant literature (e.g. de Vrande et al. 2006) that Open innovation should not be solely studied from the perspectives of large, high-tech multinational enterprises (MNEs), as most commonly done (e.g. Chesbrough, 2003), rather the scope should be broadened to capture SMEs in general and services industries in particular. Even though flexibility of SMEs is seen as an advantage for accelerating their innovation, only few of them achieve to manage the whole innovation process on their own in order to turn their inventions into products or services. They often lack resources and capabilities (Antoldi et al 2011; Cerrato & Depperu, 2011; Coviello & McAuley, 1999; Crick and Spence, 2005) at the stages of manufacturing, distribution, promotion and research funding, and this leads them to cooperate with other firms, in order to reduce risk, cost and time required for innovation, as well as to gain access to sales and marketing networks during the last stages of innovation process.

To answer to some of the calls and shortcomings discussed, we suggest cluster analysis as a tool for meeting and understanding these challenges, as there is mounting evidence that clustering and networking help SMEs to raise their competitiveness (Venkataramanaiah and Parashar, 2007). However, while networking is viewed as vital for enterprises of all sizes (Ojala, 2009; Kontinen & Ojala, 2011), clusters alone cannot solve the complex problems and constraints encountered by SMEs and break the vicious circle of SMEs competitiveness (Dasanayaka and Sardana, 2010). Clusters, unlike networks, are not based on membership.

Lamentably enough, although it is apparent in extant literature that the cluster concept has been shown to be an efficient instrument for strengthening regional and national economies, its applicability for improving the competitiveness of participating SMEs has yet to be fully examined. However, extant literature gives the impression that formulation of a firm's strategic intent is a unilateral process solely confined to a single firm (Driffield & Love, 2007). This study is a response to calls made in Osarenkhoe (2010) and Awuah et al (2011), Hessels and Parker (2013) and Costa et al., (2016), to expand inter-firm relationships study beyond the narrow dyadic relationship focus and not solely conceptualize collaborations as one of companies' strategic intent to implement mechanistic growth strategy.

This paper aims to highlight the importance of interaction within and between society's stakeholders and how different forms of clustering/networking can contribute to long-term value creation that

strengthens the competitiveness of companies at the domestic level as well as in international contexts. Succinctly, mapping the salient features of existing clusters and networks and unveiling firms' perceptions of benefits accrued from regional cluster, to be accomplished in this study, is the first step in a cluster development process. To address the overarching objective, the following research question is formulated:

RQ 1: How are the collaborative networks of private and public partnership organized to enhance competitiveness for all stakeholders in the cluster? And what are the perceptions of the actors in the cluster initiatives on the usefulness of clustering and networking?

Consequently, this paper extends our earlier works and existing literature by illuminating the complementarity-based and the continuum nature of actor bonds, resources ties and activity link of hybrid level of inter-organizational relationship prevailing in strategic networks and its impact on collective strategies for value generation among actors in network setting. An epitome of this is the increasing interest in regional development among policy-makers spurred by an upsurge in interest in regional issues on the part of researcher, which is manifested in greater attention to the cluster concept and the somewhat overlapping concept of industrial districts (Johanson & Lundberg (2011).

The rest of this paper proceeds as follows: First is the theoretical underpinnings, which consists of a review of literature that views markets as organized behaviour systems, manifesting network structures and clusters, as complex adaptive systems (Martin & Sunley, 2011; Menzel & Fornahl, 2010), made up of components with varying characteristics, that interact with each other in a systemic way. This is followed by the Methodology section includes data collection strategy and process that facilitated the mapping of the salient features of clusters and strategic networks in a specific region in Sweden. Thereafter, a presentation and discussion of the case study are carried out. We present an explanatory model of cluster and regional competitiveness which emerged from our findings. The paper ends with concluding remarks and a discussion of the implications of the study.

## **THEORETICAL UNDERPINNINGS**

A great deal has been written about the new role of the state in what is described as a more globalized, more competitive world (e.g. Birkinshaw & Hood, 2000). Arguments have been advanced that the state has lost power upwards to supranational actors like the EU, the World Bank and the OECD, and downwards to increasingly active regions, and that public policy is more often being formed in complex interaction between actors in the public, private and education/academic sectors (Keating, 2006; Säll, 2012). The transformation from industrial society to information and service society accompanied by great economic, political and social globalization constitute an important platform for the ideas of new regionalism. It has thus become a central tenet of politics for regional growth to

create new kinds of arrangements, mobilize local and regional actors and interest in horizontal network constellations and utilize information and knowledge assets by means of partnerships (Lovering, 1999; Hudson, 2005; Hessels & Parker, 2013).

### **Strategizing in networks**

Our knowledge on business relationships and networks as well as business strategies devoted to them has progressed substantially since 1970s, when the Industrial Marketing and Purchasing (IMP) Group were formed. Corresponding with IMP tradition, we define networking broadly as all of the actions of a company or an individual in business relationships and networks (Ford, Gadde, Hakansson, & Snehota, 2003). Such networking is embedded within specific institutional contexts. Thus sizable efficiency gains can be achieved by actors in strategic collaborative networks of exchange relationships (Awuah, Abraha & Osarenkhoe, 2011; Ojala, 2009; Kontinen & Ojala, 2011) through their activity links, resource ties and actor bonds to other actors in the network.

Early IMP research contributed to the understanding of companies' internationalization processes, by the interaction model of international seller-buyer relationships (Håkansson, 1982) and the network model of internationalization (Johanson & Mattsson, 1988; Johanson & Vahlne, 1977). However for some time internationalization has not been in the forefront of IMP research. Meanwhile, the companies' international business environment and perception of processes associated with foreign activities have changed and the importance of network relationships for internationalization has received more and more attention in business practice, government policies and in academic research. Kalinic and Forza (2012) discuss how SMEs use strategic focus rather than the gradual approach of building experience. They further argue that the internationalization of SMEs is taking place without sufficient experience or specific market knowledge. Against previous research, the SMEs can often do rapid internationalization (Osarenkhoe, 2009). Building on this, Hessels and Parker (2013) highlight the importance of interfirm collaboration strategies. Collaboration, in particular when it unfolds in the context of networks, is an important facilitator in the internationalization of SMEs (Johanson & Lundberg, 2011; Ter Wal & Boschma, 2011; Kontinen & Ojala 2011). By taking part of collaborative networks, SMEs' internationalization processes can benefit (Hessels & Parker, 2013) by providing decision-makers with channels of information and knowledge; introducing partners, influence decisions on foreign market selection and entry mode.

The past twenty years have, however, seen a shift in the economic policies pursued in many countries. Networks and networking have become buzz words in business, academia, as well as regional and national governments as the traditional macro-perspective on economic conditions has increasingly been superseded by a greater interest in the micro-economic business environment (Zeng et al 2010).

The focus is no longer on specific companies or on the market in general; instead, specific relationships and networks between companies in a region are the object of policy-makers priorities (Ciravegna et al., 2014). As a result, vast (public) resources are now being poured into projects and programs that are aimed to support the development of relationships between various companies in a specific region in order to achieve growth. It is therefore not surprising that in recent years, various research disciplines have increasingly showed interest in the collaboration among various stakeholders.

### **Utilization of joint innovation and clustering**

A basic assumption about the nature of the innovation process is usually taken as the starting point of modern innovation studies. And that innovation process interactive in nature. Very few innovations arise from single isolated source (Håkansson & Snedhota, 1990). Rather, most innovations are created through complex, interactive, iterative and cumulative learning processes in which a variety of actors (individuals as well as organizations) are involved in different ways (Curran et al. 1993; Dasanayaka & Sardana, 2010). The embryo of an innovation (or radical renewal process) are not always created at development department and then passed on to other units. Instead, the development department is, in many cases, integrated in all parts of the chain. Thus innovation process is considered also as a socially embedded process where the user perspective is often put in focus (von Hippel, 2001).

Building on innovation as an interactive learning process, and happens in the interaction between firms as open innovation postulate (von Hippel, 2001; Chesbrough, 2003), it is of importance to study how the innovation generates value for the involved parties (Håkansson & Waluszewski, 2002 & 2007; Van de Ven et al., 1999. Van de Ven's (1999) definition of innovation suggests that innovation is born out of reshuffling resources inside and outside of the firm. Thus it is virtually impossible for a single company to reprocess and accommodate all the necessary skills within organizations. Instead, organizations rely on various forms of cooperation with external actors, companies and other organizations (such as universities).

De Vrande et al. (2006) discuss that SMEs pursue open innovation primarily for market-related motives such as meeting customer demands, or keeping up with competitors. Their most important challenges relate to organizational and cultural issues as a consequence of dealing with increased external contacts. Thus, clusters as a network can provide a common platform to help SMEs overcome these barriers. The values resulting from the presence in a specific local area of firms with similar or complementary skills and expertise is widely analyzed in the literature (Porter, 1990 & 1998; Martin & Sunley, 2011). According to Porter (1990), national clusters are formed by firms and industries linked through vertical (buyer/supplier) and/or horizontal (common customers, technology, etc.)

relationships with the main players located in a single nation/state. This definition was modified by Porter (1998) to encompass institutions (formal organizations) such as universities.

It has long been recognized that related firms and industries tend to locate in certain geographical proximity but they will concentrate in a location only if that agglomeration brings benefits to them, which are greater than the costs of locating in the area (Martin & Sunley, 2011; Menzel & Fornahl, 2010). Some authors have distinguished between various geographical benefits from agglomeration economies, and found that geographical benefits are related to a certain geographical location (e.g. specialized labour, infrastructure, etc.), whereas agglomeration economies (benefits) describe how these and other factors are created by increasing the number of firms (Martin & Sunley, 2011; Menzel & Fornahl, 2010).

Consequently, geographical proximity is regarded as a vehicle to enhance the dissemination of knowledge and the development of institutions, which in turn may enhance cluster effectiveness. Geographical proximity creates competitive advantages to SMEs which closely cooperate and compete, since a host of linkages among cluster members results in a whole greater than the sum of its parts (Porter, 1998). Competitors within the cluster will benefit from agglomeration effects in a way that they will gain cost advantages and have access to resources that are not available to competitors not located in the cluster (Valdaliso et al, 2011; Maskel, 2001). The geographic concentration of clusters contributes to developing additional financial benefits and technological externalities (Niu et al 2012). Technological externalities are defined as those consequences of activity which directly influence the production function in ways other than through the market (Ter Wal & Boschma, 2011; Martin and Sunley, 2011). As a result of geographical proximity, communication between cluster members is strengthened and the exchange of knowledge is intensified. Besides, the codified knowledge, which can be easily transferred through different communication media, informal, or so-called tacit knowledge, is exchanged rather accidentally because the senders and the receivers are not aware of its relevance before they are involved in the communication process (Gomes & Hurmelinna-Laukkanen, 2013).

Karaev et al. (2007) addressed effects of cluster on competitiveness, and conclude that belonging to a cluster has a strong positive effect on the SME policy in industrialized countries. This invariably reinforces the notion that geographical clustering of economic activity can impact on the creativity and competitiveness of firms in a number of different ways (Suhail, 2014; Zaheer and Manrakhan, 2001; Malecki, 2012). It is expected that firms in a cluster can benefit from productivity improvements due to reduced transaction costs, access to a common pool of labour (skilled or unskilled), benefits associated with collective intelligence, technology spillovers and increased competitive pressure. Against this background, local contexts and clusters become an important source of international competitive

advantage, where companies (SMEs, MNEs, etc.) can interact effectively among them and with other institutions so as to cooperate and learn.

A way to conceptualize clusters is to view them as complex adaptive systems (Martin and Sunley, 2011) which consists of various stakeholders (large firms and SMEs, universities and research institutions, national and regional authorities, etc.) with different characteristics, that interact with each other in a systemic way (Menzel and Fornahl, 2010, cf Valdaliso et al. 2016). Firms in cluster setting are heterogeneous in nature and, therefore, endowed with different organizational cultures, knowledge and capabilities (Ter Wal and Boschma, 2011) and, hence, cluster “do not develop evenly and as a whole” (Menzel & Fornahl, 2010, p. 224; Valdaliso et al. 2016, p. 68). However, Social capital, in particular, is widely understood as conducive to the promotion of intellectual capital, collective learning and the creation and transfer of knowledge both inside and outside the firm’s and cluster’s borders (Kuah, 2002; Maskell, 2001; Malecki, 2012; Valdaliso et al 2011).

According to Birkinshaw & Hood (2000, p. 12), “it is not just cluster membership but the specific characteristics of the cluster in question that impacts the likely subsidiary role”. Ceglie (2003), on the other hand, argued that the geographical concentrations of SMEs that operate in the same sector are not sufficient for producing “external economies”. According to him other factors, such as trust building and constructive dialogue (Niu et al 2011; Malecki & Fornahl, 2012) among cluster actors, exchanging of information, identifying common strategic objectives, agreeing on a joint development strategy and its systematic and coherent implementation are of paramount importance for building an efficient cluster.

### **Reflections on the theoretical underpinnings**

For the purpose of this study, it is pertinent to mention that innovations in various types of enterprises tend to be defined as creative ideas put into practice, by management seeking to resolve persistent problems faced while pursuing the goals of the enterprise. The decision for SMEs in a cluster/collaborative strategic network or industrial district settings to internationalize their business operations in markets with varying magnitudes of physical and psychological distance is an example of innovative business practices. Inter-organizational collaboration covers lasting and well-structured relationships, resource flow and other interactions between specific organizations seeking to attain both common as well as individual targets. With reference to the review above, it seems that cluster-based strategies could really improve the competitiveness of SMEs and a cluster approach among SMEs may be used as a tool for meeting their challenges related to globalization and trade liberalization.

Companies' strategic partnerships with other companies and organizations create synergies for the parties involved, which increases the potential for positive regional development. To achieve this requires a strategic collaboration between various actors from various settings - businesses, private and public organizations and academic institutions. Thus epitomizing the notion that innovation entails new ways of configuring the resources of many actors, where the goal is to generate value for all of the parties involved. This places high demands on both internal coordination in existing supplier chains as well as the ability to work together across industry and institutional boundaries.

Finally, it is pertinent to mention that innovating in networks can result to a scenario of oxymoron because, business relationships have been described as the enabler of firms and their strategic intentions, in how resources are provided by business partners. At the same time, literature refers to how present relationships disable firms from conducting their strategies independent of others. This is explained by how companies act and react to strategies performed by other companies in the network-context. Parallel to this, strategy research emphasizing strategic flexibility point to how companies need to be adjustable to their environment, and focuses on the actual strategic practice.

## **METHODOLOGY**

Findings reported in this study constitute the second paper from a longitudinal study. The first paper, which is published elsewhere, highlights the complementarity-based nature of co-competition strategy and its impact on collective strategies for value generation among actors in three network settings in Sweden. In this study, a qualitative and, to some extent, a quantitative research strategy was adopted. Qualitative research methods were believed to be most appropriate to facilitate the mapping of the salient features of clusters and strategic networks and perceptions of actors in a specific region (Yin, 2002). This allowed the researchers to uncover issues of relevance in understanding the substantive research question: RQ 1: How are the collaborative networks of private and public partnership organized to enhance competitiveness for all stakeholders in the cluster? Mapping of existing clusters and networks, as accomplished in this study, is the first step in a cluster development process.

Data collection process entails two steps: The first phase started in conjunction with workshops carried out in a network created by the researchers. The network includes researchers from three Swedish universities and representatives of clusters from five regions in Sweden. Joint cooperation on research on sustainable innovation driven clusters and network configurations has been initiated through six workshops organized in this network between 2013 and 2015. The first part of data collection entails all clusters initiatives and networks in Kronoberg County. Process leaders were identified in collaboration with Heads of Business Enterprise in the municipalities. Thereafter, all

cluster initiatives were subsequently contacted for in-depth interviews. 25 clusters, regional and local networks from all municipalities in the county were included.

**Focus Group discussion** with process leaders of cluster initiatives, regional and local networks was conducted. A total of ten groups were formed. There were six members in each group, and a session with each group lasted for two hours. A moderator guided the group through a discussion that probed: How are the collaborative networks of private and public partnership organized to enhance competitiveness for all stakeholders in the cluster? In compliance with requirements in which focus group interview should be conducted, the discussion was observed from behind a one-way mirror. Participants could not see out, but the researchers could see in. A video camera recorded each of the discussions carried in each group. Transcripts were created from the ten video tapes from the ten separate sessions. Questions were asked in an interactive group setting where participants were free to talk with other group members. The discussion was loosely structured, and the moderator encouraged the free flow of viewpoints on the main theme for discussion which were solely based on the research questions. "Having key themes and sub-questions in advance lies in giving the moderator or researcher a sense of order from which to draw questions from unplanned encounters (David & Sutton, 2004).

The second part of the data collection process aims to unveil the how firms in the clusters and networks perceive benefits or gains from collaboration in clusters, a loosely structured questionnaire which consists of semi-structured and open-ended questions were used. The survey was sent to 53 companies and other actors in the Aluminium Works, the Energy Agency, the Furniture Works, and Heavy-Duty Vehicles cluster initiatives. The survey was conducted through a combination e-mail and telephone questionnaire, with a response rate of 81 %. The open-ended part of the questionnaire enhanced the possibility for the respondents to provide additional in-depth comments. Both semi-structured and open-ended questionnaire focused on benefits of collaboration in clusters were identified from literature. They include the following: Benefits accrued in conjunction with strategic collaborations in the region manifest themselves in different forms: Advanced dialogue and consensus between companies and other significant actors; Potential to pool resources between companies, e.g. at production peaks; Collaboration with the school and the education system to safeguard workforce supply; Potential for common marketing and profiling; Potential to establish collaboration with various universities and academic and research institutions; and level of satisfaction with the work form used by the clusters.

**Data analysis:** Analysis consists of three steps: data reduction, data display, and conclusion drawing (Miles and Huberman, 1994). Data reduction entails selecting and filtering data in order to focus, discard and organize the data in such a way that conclusions can be drawn and verified (ibid.). As for



the tape- and video-recorded interviews, this analysis process began while transcribing the interviews. The aim of data display is to organize the data into a compressed assembly of information to elucidate appropriate conclusions. The main themes, in our case the *focus, objectives, activities and organization of the clusters and networks and perceptions*, were extracted so as to provide succinct insight on the salient features of the cluster initiatives, regional and local networks in the region studied. Conclusion drawing and verification focuses on reflecting and understanding the data chosen for display. Although the process began at the initial stage, this step became more dominant during the later stages of the research. Despite the fact that the three steps are viewed as separate processes of analysis, it is important to note that the processes were going on simultaneously in this study.

## **PRESENTATION OF THE CASE STUDY ON CLUSTERING AND NETWORKING**

The case study draws on cluster initiatives and strategic networks in Kronoberg County - a region where there are a number of examples of strategic collaborations between companies, academia and public institutions both at regional and local levels. These collaborative arrangements, according to our respondents, together contribute to strengthening and reinforcing the fertile conditions for SMEs and regional competitiveness and growth. Firms in Kronoberg County have, in comparison to Swedish peers, fewer bankruptcies - only 2.6 per 1,000. Kronoberg has during the last years been holding the top position in terms of its capability of running gazelle or fast-growing companies, approximately 300 gazelle companies per million employees. Gazelle are vital for growth, as these are the ones creating most new jobs. Kronoberg County's share of exports is very high. In 2010, Kronoberg had the highest export value in the country per capita. When looking at the different forms of internationalization, a regional pattern emerges. In most counties, the number of importing and exporting companies is relatively similar. Kronoberg county show a higher share of exporting companies. It is otherwise more common that counties have a larger share of importing than exporting businesses.

### **Mapping of the salient features of strategic collaborations platform**

The strategic collaborations identified consist of three categories: Cluster initiatives: A cluster initiative is an organised development process, associated with a common area of business activities. The purpose of such collaboration projects between companies and authorities, and/or research- and educational institutes, is to fortify the growth and competitiveness of a cluster. Development processes running solely in conjunction with authorities or other companies are not considered as cluster initiatives, since they do not constitute a collaboration that intersects industry, administration, and academy.

Table 1 consists of five cluster initiatives in Kronoberg County. These are linked to established sectors in the county - in traditional manufacturing industry as well as in new areas of growth: The Aluminium Works – comprises regional and national companies in which aluminium is a strategic material; Bioenergy Cluster Småland – generating support to companies' and organisations' marketing of bioenergy technology; The Glassworks – collaboration in marketing and selling of experiences and activities around the glass manufacturing in the region; The Furniture Works – includes design- and furniture companies in Småland, and aims at developing a strong trade region; Heavy-Duty Vehicles – comprises manufacturers of heavy-duty vehicles and their subcontractors, facilitating collaboration between the companies.

The table sets forth selected financial data for five cluster initiatives (Swedish krona amounts in thousands)

Cluster initiatives	No. of firms	No. of employees	Sales Volume	Turnover/employee	Gross Profit
The Aluminium Works	48	4 214	11 292 808	2 680	798 314
Bioenergy Cluster Småland	12	1 264	4 924 379	3 896	10 975
The Glassworks	8	695	624 852	899	11 749
The Furniture Works	25	445	846 578	1 902	78 336
Heavy-Duty Vehicles	15	7 936	28 085 183	3 539	880 338
TOTAL	108	14 554	45 773 800	3 145	1 779 712

Table 1: Cluster initiatives in Kronoberg county

The main purpose of the cluster initiatives identified in this study is to stimulate economic growth in various business sectors, and through collaboration reinforce the competitiveness of the firms and the cluster. This is achieved through, for instance, promoting innovations and entrepreneurship within a branch/business sector and facilitating increased research input and collaboration with academic institutions. According to the respondents, activities in the cluster initiatives consist, among other things, of common marketing, business profiling, and lobbying. They furthermore include collaboration with universities and university colleges as well as cooperation around shared projects, e.g. development of competence, production processes, and products. The cluster initiatives encompass over 150 companies, the municipalities in the region, and more than 24 other collaborative partners, like universities and university colleges. The companies consist of over 21,000 employees in and outside the region (based on information from 114 of the companies), and recruiting members to the clusters is conducted from branch perspective rather than a geographic. Number of members

range from one-man enterprises to large global corporations. Operations of the firms cover trading as well as manufacturing and services on both local and regional and international markets. Most of the cluster initiatives receive financial support from the region, and several of these are participating in national programs and ventures towards cluster development.

### **Regional networks**

Entail interactions between actors at a regional level having an interest in collaborating around a common matter. Regional networks are not necessarily geographic; nor do they promptly represent a specific cluster or innovation system. The following regional networks were identified in this study. They include initiatives focusing on mobilizing individuals and actors in their work on regional future issues, but also initiatives with a focus on supporting branch development: CIL – Centre of Information Logistics – pursues efforts towards education in information logistics, based on the needs and priorities in the business sector; Delta Garden – aims at strengthening the competitiveness of companies by developing new forms for communication and dialogue, based on interaction and a participatory perspective; Destination Småland – promotes tourism and the visitor industry in the region by collaboration between the region, the municipalities, and companies in the visitor industry; Energy Efficient Buildings in Southeast – GodaHus – aims at developing the work on energy efficient buildings in the region by collaboration between public actors, universities, and companies; The Governor’s Ambassador Network – a relatively newly established network that mobilizes actors and resources for the future development in Kronoberg. The assignment of the regional networks is to support the development of the regional business sector, collaborate around education for the business sector, and to strengthen the attractiveness and competitiveness of the region. The work entails generating strategies for joint efforts, coordination of projects, and communal education.

### **Local networks in the municipalities**

Primarily focus is on interactions between actors at a municipal level having a mutual interest in collaboration. Business networks are present in all municipalities in the county, and municipalities often have more than one. In Ljungby municipality, five business networks were identified, three of which are presented below. However, in other municipalities there are more networks than those presented below: There is a long history behind several of the networks; they were initiated and operated on the initiative of the local companies. One of the networks, *Lagan Products*, started under the name *The Thursday Club* already during the 1960s, while others have been active since the end of 1990s, like *Vi företagare* in Tingsryd and *Growing Älmhult*. Some networks started relatively recently and have established themselves with the purpose of finding a form for promoting development of

the industry and local companies through collaboration. Other local networks include: Alvesta municipality: The Business Sector Council; Lessebo municipality: Hovmantorp Business society Abbakuse; Ljungby municipality: Ljungby Partnership group, Ryssby Business society, the Thursday Club Lagan; Markaryd municipality: Tillväxt Markaryd AB; Tingsryd: The Private Health/Welfare network, Vi företagare; Uppvidinge municipality: Alstermo Utvecklings AB, Vilda Uppvidinge; Växjö municipality: BNI, Expansive Växjö, Ingelstad Business pool, The Network SIP; Älmhult municipality: Growing Älmhult.

The local networks primarily focus on support and development of the local business sector. Promoting attractiveness of the municipality, subsequently promoting companies and the industry there, is however also important. Interaction between companies, and between companies and the municipality, is the core of the network activity. The fifteen local networks encompassed in this study have more than 700 members. The members of local networks range from micro/one-man-enterprises with primarily a local market, to global companies acting on an international market. Thus, IKEA is a member of the network Growing Älmhult. All kinds of business sectors are represented in the networks.

Several local networks arrange recurring breakfast meetings on several occasions per season to exchange experiences, and to learn more about each other's businesses. Other kinds of shared activities are common marketing, participation in trade fairs, educational initiatives for future competence supply, and collaboration with the municipality around pupils' practical work orientation. The local networks have developed substantial collaborations with their municipalities, with well-established forms for continuous dialogue with the municipal government. Collaboration with the university is also high up on several of the network agendas, but is still in the process of development. The project "Student in the region" has contributed to establishing a framework for such a partnership.

### **Collaborations in clusters and gains accrued from Clustering and Networking**

Viewpoints commonly expressed by all respondents, which are also in line with extant literature (Osarenkhoe, 2010; Suhail, 2014), were that collaboration holds no value in itself. It is hence crucial to substantiate any benefits derived from collaboration. Benefits must be palpable to all actors involved – collaboration is not viable in the end if not all partners can recognize their gain. There is consensus among actors included in this study that benefits are what motivate actors to continue to collaborate and to contribute to jointly created preconditions for growth, locally as well as regionally. Benefits accrued in conjunction with strategic collaborations in the region manifest themselves in different forms: Advanced dialogue and consensus between companies and other significant actors; Potential to

pool resources between companies, e.g. at production peaks; Collaboration with the school and the education system to safeguard workforce supply; Potential for common marketing and profiling; Potential to establish collaboration with various universities and academic and research institutions; and level of satisfaction with the work form used by the clusters.

In Table 2 below, we present findings showing firms' perceptions of the actors in the cluster initiatives on the usefulness of clustering and networking. Benefits accrued from clustering and networking were extracted from extant literature (Martin & Sunley, 2011; Menze & Fornahl, 2010; Osarenkhoe, 2010; Antoldi et al 2011; Cerrato & Depperu, 2011) and operationalized as: advanced dialogue and consensus between companies and other significant actors; Potential to pool resources between companies, e.g. at production peaks; Collaboration with the school and the education system to safeguard workforce supply; Potential for common marketing and profiling; Potential to establish collaboration with various universities and academic and research institutions; and level of satisfaction with the work form used by the clusters. The findings from the survey which consisted of a combination of semi-structured and open-ended questionnaire sent to 53 companies and other actors in the Aluminium Works, the Energy Agency, the Furniture Works, and Heavy-Duty Vehicles cluster initiatives are presented below. The survey was conducted through a combined e-mail and telephone questionnaire, with a response rate of 81 %.

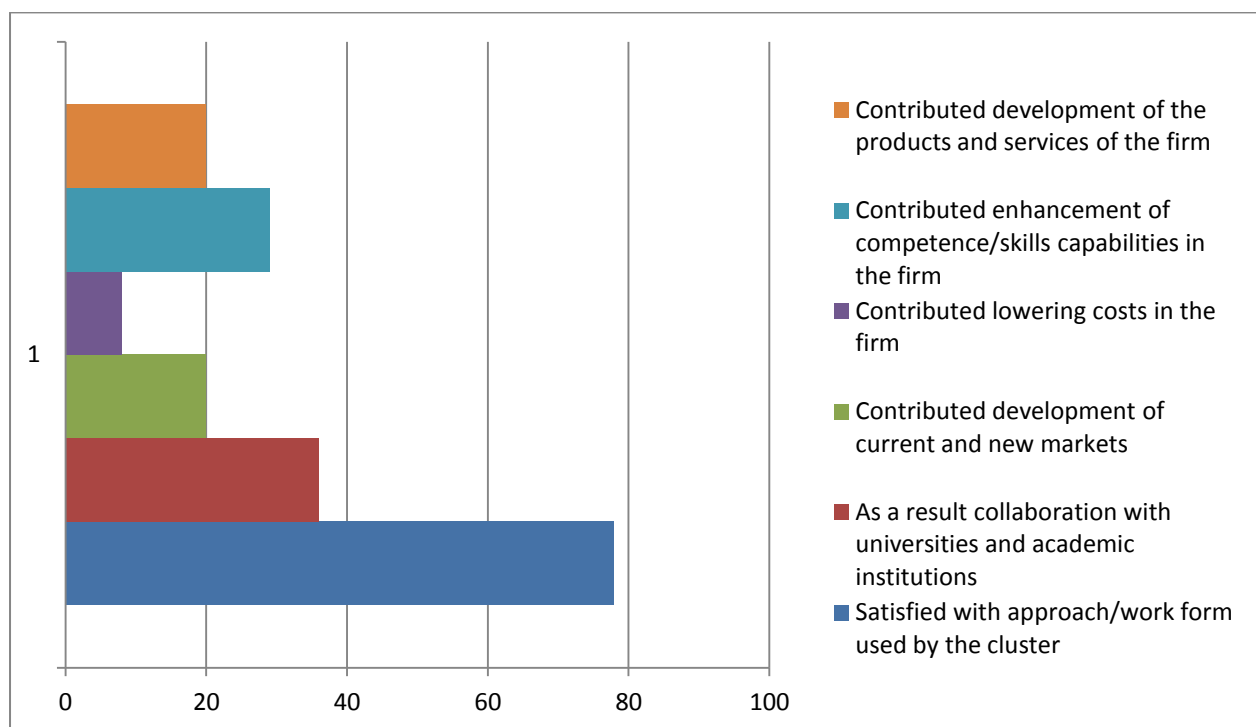

TABLE 2: A summary of firms' views on collaborations in clusters and gains accrued from Clustering and Networking

In a nutshell, networking, dialogue, and experience exchange were the recurrent themes when the companies expressed the benefits of collaboration in a cluster initiative setting. Here are some examples of their opinions:

*“Seminars and dialogue groups offer a good exchange of experiences, and increase the competence of the participating co-workers. Collaboration with the university provides an opportunity for specific, need-based competence development activities and special education. In certain R&D-areas, collaboration opens up for external co-creation and finances. The largest benefit of the cluster for my company, are the recurring meetings and the exchange of information. This information is sharper and more relevant than the general reviews of the market situation in various countries (like conferences, seminars, workshops, etc)”.*

Other benefits of cluster collaboration are the strengthening and development of the position of the business sector and that the cluster, as a lobbyist, is able to pursue common matters. The collaboration in the cluster is also viewed as a way to market the region and make it visible, and as a means to increase the attractiveness, which might contribute to entice new companies and entrepreneurs to the branch and the region. The respondents expressed their views on these as follows:

*“The branch is seen and heard in a better way, and arrangements and meetings have gained a greater weight and a higher quality (The Cluster initiative is) a means to market the region. Many more are attracted when companies come together. Sales volume increases, and by increasing the visibility, so does the possibility of attracting more to the branch... It is however up to each company how to utilize the resource”.*

One of the firms described the different aspects of benefit to firms, and what collaborating in clusters may be about: *“We are subcontractors. Dialogue is of utmost importance to us, not just with our current customers, but also with potential customers from segments where we are not represented today. Similarly, holding the same kind of dialogue with the university and other research institutes is vital. Running joint projects, product- as well as knowledge-related, where staff from different companies and actors within the cluster are participating, offer considerable more-values to everyone, since the shared knowledge foundation in the projects is growing considerably larger and in particular, wider. We are furthermore running projects and activities that each actor would not be able to carry out on their own. The society being present in the cluster is also very valuable. The companies, the education-/research-sector, and the society all have the same goals, and it requires collaboration and understanding if we are to reach these goals. My company must have access to manpower with the right competences. Beside adequate education opportunities, this calls for a region where people want to live; a region one wants to move to with the whole family, and where one wants to stay on. This involves housing, work availability, schools, communications, health care, after school-activities, and much more. I am convinced that cluster initiatives are incredibly important and efficient when creating relevant common goals”.*

The companies' descriptions of the benefit of cluster collaboration convey a multifaceted picture of the needs and underlying rationale that motivate the firms to allocate time for collaboration with others. This picture is important in order to comprehend the dynamics of cluster collaborations, and that a number of different questions and aspects are involved in how the collaboration benefits are experienced by various actors. These may include issues that will not directly or within a short time make an impact on the company revenue or economic viability. As is illustrated by the viewpoints in Table 2 above, 78 % of the 53 companies and other actors in the Aluminium Works, the Energy Agency, the Furniture Works, and Heavy-Duty Vehicles cluster initiatives were very happy or exceptionally complacent with the work forms in the cluster. The companies believe that collaboration in the cluster to a limited degree has been beneficial to these matters. Regarding the development of the company markets and of products and services, 20 % of the companies maintain that collaboration, to a large/very large degree, has contributed to this. It is furthermore believed that collaboration to a large/very large degree has safeguarded the future supply of manpower and competence. In terms of collaboration with universities/university colleges, 36 % are of the opinion that this is accomplished to a large/very large degree. Only 8 % of the companies agree however to a large/very large degree that collaboration has led to reduced costs, e.g. by joint purchases or increased productivity.

## DISCUSSION OF FINDINGS

### *"Soft and "Hard" Benefits Accrued from Collaborations in Clusters and Networks*

The foremost benefit of collaboration in clusters is, according to the companies, "soft". It concerns experience exchange, networking, and dialogue between companies and between companies, academic institutions and public sector. The benefit has not encompassed "hard" results, like reduced costs, product- and service-development, or development of new markets, in equal measure. Nonetheless, the companies are largely pleased with the work forms in the cluster initiative. As a matter of fact, the most remarkable of the findings is that only 8 % of the companies agree that collaboration in clusters has led to reduced costs, e.g. by joint purchases or increased productivity. This is a far cry from other findings in extant literature (Porter, 2000; Curran et al, 1993; Martin & Sunley, 2011; Menzel & Fornahl, 2010; Karaev et al 2007; Venkataramanaiah & Parashar, 2007), that geographical proximity brings so-called agglomeration effects in terms of higher specialization, innovation and knowledge transfer, which results in costs reduction and improving the competitiveness of industrial sectors, regions and nations.

The above-mentioned anomaly seems to be in contrast to the basic assumption of open innovation model (von Hippel, 2001; Chesbrough, 2003) that much of useful knowledge to develop new products and services lies outside the boundaries of the company. This is particularly vital for SMEs as they often lack resources and capabilities (Antoldi et al 2011; Cerrato & Depperu, 2011) to manage the whole innovation process on their own in order to turn their inventions into products or services. We, therefore, suggest cluster as a tool for alleviating these challenges, as there is mounting evidence that clustering and networking help SMEs to raise their competitiveness (Venkataramanaiah and Parashar, 2007).

However, firms perceptions of benefits accrued from regional cluster, illustrate the complexity of the underlying motives for the companies' participation in clusters. A number of different aspects of long-term sustainable growth of the companies and of the region are involved. In the literature review section, we mentioned that clusters alone cannot solve the complex problems and constraints encountered by SMEs and break the vicious circle of SMEs to reach the next level of growth (Dasanayaka & Sardana, 2010). However, clusters, unlike networks, are not based on membership. They are simply geographic concentrations of interrelated companies and institutions of sufficient scale to generate externalities. The minimum number of firms with common or overlapping needs to be acknowledged as a "cluster" is the number that attracts suppliers and specialized services and resources.

Figure 1, which emerged from our findings, aptly depicts an explanatory model of cluster and regional growth. It shows that successful regions base their growth and development on established areas of strength; they do not seek to develop completely new activities, but rather build on tradition, history, and competence in the region. Success does however not come from acting in the same way as always. It is rather the capability of renewing and developing existing assets in a region that creates the preconditions for competitiveness and growth in companies and regions. Renewal and development of existing assets place focus on the capability of innovation and entrepreneurship in the region, and need individuals that (in collaboration) engage in development, renewal, and enhancement of these assets into new products, services, and production processes that can compete on a global market.

Innovation capability and entrepreneurship at an individual level do however not sufficiently explain why certain regions are more successful than other regions in terms of creating the necessary preconditions for growth in companies and in the region. In prosperous regions, there is a contexture, a regional innovative environment founded on a common consensus, and a capability of interaction between actors from different sectors of society. This is about cultures and values, attitudes towards change and development, along with a framework for interaction between various actors. The



regional leadership decisively affects the capability of a region to cultivate common values and joint actions. A regional leadership, capable of creating a common consensus and establishing different forms of interaction, where different actors in the region are moving in the same direction, is imperative for building a regional innovative environment that promotes competitiveness and growth.

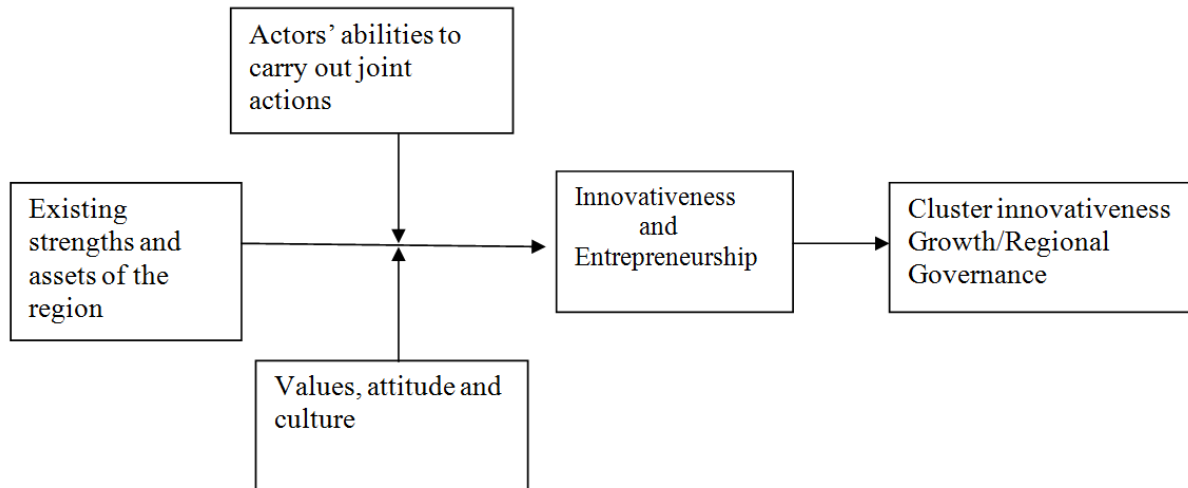

Figure 1: Towards an Explanatory Model of Cluster and Regional Growth

In a nutshell, it can be deduced from the model (Figure 1) that interaction can be viewed as a four-phase process. It starts with dialogue (to mobilize actors and resources) (Håkansson & Waluszewski, 2002; Van de Ven et al., 1999) and consensus (the forming of a common strategic idea around the present level and the should-be level). The process continues with collaboration (the forming of common action plans for implementation) followed by joint action (implementation of the commitments and activities within the developed common frame and strategy). Partnership may also be regarded as a process over time, where the actors gradually acquire a shared view, with faith and trust simultaneously maturing between the actors, thus facilitating joint commitments and inputs (Ciravegna et al., 2014; Johanson & Lundberg, 2011; Ter Wal & Boschma, 2011; Zeng et al 2010; Kontinen & Ojala 2011). The process calls for, and denotes, developing a social capital that connects actors (see findings above on salient features of strategic collaborations platform). This is particularly important when the setting consists of actors with different organizational cultures: large firms and SMEs (i.e. industry), universities and research institutions (i.e. academia), as well as national and regional authorities for building the legal or incentive framework of innovation (i.e. government) (Lecler et al, 2015).

These observations are in line with the basic assumption of open innovation model (von Hippel, 2001; Chesbrough, 2003) that much of useful knowledge to develop new products and services lies outside the boundaries of the company. This is particularly vital for SMEs as they often lack resources and capabilities (Antoldi et al 2011; Cerrato & Depperu, 2011) to manage the whole innovation process on

their own in order to turn their inventions into products or services. We, therefore, suggest cluster as a tool for alleviating these challenges, as there is mounting evidence that clustering and networking help SMEs to raise their competitiveness (Venkataramanaiah and Parashar, 2007). Consequently, despite the great success and interest that the topic has stimulated in both academics and practitioners in the past decade, several areas such as open innovation in small medium enterprises, open social innovation and outbound open innovation need further investigation.

## **CONCLUDING REMARKS AND IMPLICATIONS OF THE STUDY**

Mapping the salient features of existing clusters and networks and unveiling firms' perceptions of benefits accrued from regional cluster, as accomplished in this study, is the first step in a cluster development process. We mentioned earlier in this paper that we aim to highlight the importance of interaction within and between society's stakeholders and how clustering and networking can contribute to long-term value creation that strengthens the competitiveness of companies at the domestic level as well as in international contexts. This study takes its point of departure in complex and interactive learning processes being able to help to create positive synergies in which actors with different goals, perspectives and expertise are involved in the work and contribute their respective views on how to work toward common goals. The basic premise is that companies and organizations can no longer rely solely on their own core competence and innovation capabilities but must work together across organizational boundaries to manage a dynamic environment. This is particularly vital for SMEs because they are seldom able on an individual basis to produce the competence development, technology coverage, marketing skills, etc. that are required for meeting all demands from the environment (Antoldi et al 2011; Cerrato & Depperu (2011). However, these functions may well be developed by the companies if they collaborate (Carbonara, 2002; Osarenkhoe, 2010). They will hereby be able to acquire strategically crucial knowledge that can be converted into new products and services, realizing the dynamic potential of small enterprises, and in the end, this contributes to economic growth.

Although many countries all over the world have developed cluster policies and programmes to enhance the impact of their research and innovation policies (Porter, 1990; Säll, 2012), and clusters provide governments with an excellent opportunity to address social and economic challenges through business development and innovation support programmes, clusters have to be considered as a tool not as an objective in itself. Findings from this study which led to the identification of "Soft and "Hard" benefits accrued from collaborations in clusters invariably strengthen our understanding of the prerequisites for regional growth and competitiveness. In addition to these, "soft factors" such as regional leadership/governance, interaction- and joint action capabilities, the importance of a

consensus and a social capital, an increased impact are also identified. These critical factors are summarized in a model which unveils the factors relevant to cluster development and regional growth and how they interact with each other. Some implications of this study are outlined below:

Lessons learned from the preceding sections aptly depict that innovation capacity in companies, clusters and regions is an increasingly important factor in the development of competitiveness and growth. In order to establish a long-term competitiveness, continuous development of new products, services, and production processes is crucial. Innovation capacity is, along with entrepreneurship, decisive for sustainable development of companies and regions. In other words, efforts made to stimulate growth and competitiveness amongst companies and regions is increasingly being focused on developing and renewing the resources available in the region. To achieve this requires a strategic collaboration between various actors from various settings - businesses, private and public organizations and academic institutions. Thus epitomizing the notion that innovation entails new ways of configuring the resources of many actors, where the goal is to generate value for all of the parties involved. This places high demands on both internal coordination in existing supplier chains as well as the ability to work together across industry and institutional boundaries.

The dynamics between short-term and long-term goals cannot be overemphasized in this case study. It is crucial to show results and tangible benefits early. As a matter of fact, the most remarkable of the findings is that only 8 % of the companies agree that collaboration in clusters has led to lowering costs, e.g. by joint purchases or increased productivity. This is a far cry from other findings in extant literature. Indeed an anomaly that requires further scientific enquiries. It seems that short term goals are important in order to attain driving force in the process. This creates the necessary conditions for a more strategic and long-term effort (e.g. firms establishment in cultural distance markets). Processes of this kind demand perseverance and trust between the actors in order to succeed (Niu et al 2011; Malecki & Fornahl, 2012). In the world of clusters, much of the public funding is founded on a project perspective. Since the definition of a project, according to respondents, in all simplicity comprises start-end and budget, and a process really do not have an ending, distorted expectations might rise among the stakeholders. It must be made clear to actors in the clusters right from start that the process is one thing, and the projects within the process are another. Achieving tangible results from a cluster initiative often takes years. The perseverance and trust among the stakeholders are by that time put to test.

More research is needed on how SME clusters could be significantly upgraded to enhance the levels of cluster productivity and participation in international markets. However, mapping of existing clusters and networks, as accomplished in this study, is the first step in a cluster development process. Since cluster concept has been shown to be an efficient instrument for strengthening regional and national

economies (Johanson and Lundberg, 2011; Venkataramanaiah and Parashar, 2007)), future studies should focus on its applicability for improving the competitiveness of participating SME, by conducting a thorough analysis of cluster. Such analysis can help diagnose a region's economic strengths and challenges and identify realistic ways to shape the region's economic future. Future research directions in clustering should also include the constraints associated with innovative capacity. Constraints are due to the variables related to firms' innovativeness in a specific territory, such as the rate of labour mobility, technological development, and the consideration of dynamic effects of spillover issues together with specific characteristics of the environment. Unique regionalization effects of the business environment on firm's innovativeness (e.g. legal, supplier, and customer profiles) as well as the actors (e.g. government's role) are also supplementary issues that ought to be emphasized in future research.

## REFERENCES

- Antoldi, F., Cerrato, D. & Depperu, D. (2013). SMEs export consortia and the development of intangible resources, *Journal of Small Business and Enterprise Development*, 20(3), 567 – 583
- Awuah, G. B, Abraha Gebrekidan, D, & Osarenkhoe, A (2011). Interactive (Networked) Internationalization- the case of Swedish firms, *European Journal of Marketing*, 45(7/8), 1112-1129.
- Birkinshaw, J., & Hood, N. (2000). Characteristics of foreign subsidiaries in industry clusters. *Journal of international business studies*, 31(1), 141-154.
- Carbonara, N. (2002). New models of inter-firm networks within industrial districts, *Entrepreneurship and Regional Development*, 14, 229-246.
- Cerrato, D. & Depperu, D. (2011). Unbundling the construct of firm-level international competitiveness, *Multinational Business Review*, 19(4), 311 – 331.
- Cerrato, D., Crosato, L., & Depperu, D. (2016). Archetypes of SME internationalization: A configurational approach. *International Business Review*, 25(1), 286-295.
- Chesbrough, H. (2003). The era of open innovation, *MIT Sloan Management Review*, 44 (3), 35- 41.
- Chesbrough, H., Vanhaverbeke, W., West, J.(2006). *Open Innovation: Researching a New Paradigm*, London: Oxford University Press.
- Ciravegna, L, Majano, S.B. & Zhan, G. (2014). The inception of internationalization of small and medium enterprises: The role of activeness and networks, *Journal of Business Research*, 67(6),1081–1089
- Corbetta, P. (2003). *Social Research Theory, Methods and Techniques*. London: Sage Publications.
- Costa, E., Soares, A. L., & de Sousa, J. P. (2016). Information, knowledge and collaboration management in the internationalisation of SMEs: A systematic literature review. *International Journal of Information Management*, 36(4), 557-569.
- Coviello, N.E. & McAuley, A. (1999). Internationalisation and the Smaller Firm: A Review of Contemporary Empirical Research, *Management International Review*, 39(3), 223-256
- Crick, D. and Spence, M. (2005). The internationalisation of 'high performing' UK high-tech SMEs: a study of planned and unplanned strategies, *International Business Review*, 14(2), 167-185.
- Curran, J., Jarvis, R., Blackburn, R.A. and Black, S. (1993). Networks and small firms: constructs, methodological strategies and some findings, *International Small Business Journal*, 11(2), 13-25.
- Dasanayaka, S. and Sardana, G. (2010), "Development of small and medium enterprises through clusters and networking: a comparative study of India, Pakistan and Sri Lanka", *World Review of Entrepreneurship, Management and Sustainable Development*, 6(1), 50-72.
- David, M. & Sutton C.D. (2004). *Social Research the Basics*, London: SAGE Publications.
- Denzin, N. (1978). *The Research Act*, New York: McGraw Hill.
- Driffield, N. & Love, J.H. (2007). Linking FDI Motivation and Host Economy Productivity Effects: Conceptual and Empirical Analysis, *Journal of International Business Studies*, 38(3), 460-473.

- Fassoula, E.D. (2006). Transforming the supply chain, *Journal of Manufacturing Technology Management*, 17(6), 848-60.
- Ford, D., Gadde, L. E., Hakansson, H., & Snehota, I. (2003). *Managing Business Relationships*, Chichester, England: Wiley & Sons Ltd.
- Gomes, J. & Hurmelinna-Laukkanen, P. (2013). Behind Innovation Clusters: Individual, Cultural, and Strategic Linkages, *International Journal of Innovation Science*, 5(2),89-102
- Hessels, J., Parker, S.C., (2013). Constraints, Internationalization and Growth: A Cross-Country Analysis of European SMEs, *Journal of World Business*, 48(1), 137 - 148.
- Hossain, M. & Kauranen, I. (2016). Open innovation in SMEs: a systematic literature review, *Journal of Strategy and Management*, 9(1), 58 - 73
- Hudson, C. (2005). Regional Development Partnerships in Sweden: Putting the Government back in the governance?, *Regional and Federal Studies*, 15(3), 311-327.
- Håkansson, H. & Waluszewski, A. (Eds.). (2007). *Knowledge and Innovation in Business and Industry. The importance of using others*, London, New York: Routledge.
- Håkansson, H. and Snehota, I. (1990). No business is an island, *Scandinavian Journal of Management*, 5(3), 187-200
- Håkansson, H., & Waluszewski, A. (2002). *Managing Technological Development. IKEA, the environment and technology*, London: Routledge.
- Håkansson, Håkan, (Editor) (1982). *International Marketing and Purchasing of Industrial Goods: An Interaction Approach*, IMP Project Group, Chichester: John Wiley & Sons.
- Johanson, J. and Mattsson, L-G. (1988). Internationalisation in Industrial Systems – A Network Approach. In N. Hood and J-E. Vahlne (eds.), *Strategies in Global Competition*, London: Croom Helm, 287-314.
- Johanson, J. and Vahlne, J-E. (1977). The internationalization process of the firm – a model of knowledge development and increasing foreign market commitments, *Journal of International Business Studies*, 8(1), 23-32.
- Johanson, M. & Lundberg, H. (2011). *Network Strategies for Regional Growth*, New York: Palgrave Macmillan
- Kalinic, I. & Forza, C. (2012). Rapid Internationalization of Traditional SMEs: Between gradualist models and born globals, *International Business Review*. 21(4), 694-707.
- Karaev, A., Lenny Koh, S.C. & Szamosi, L.T. (2007). The cluster approach and SME competitiveness: a review, *Journal of Manufacturing Technology Management*, 18(7), 818 – 835.
- Keating, M. (1998). *The New Regionalism in Western Europe: Territorial Restructuring and Political Change*, Cheltenham, Northampton: Edward Elgar
- Kontinen, T. & Ojala, A. (2011). Network ties in the international opportunity recognition of family SMEs, *International Business Review*, 20 (4), 440-453.
- Kuah, A.T.H. (2002). Cluster Theory and Practice: Advantages for the Small Business Locating in a Vibrant Cluster, *Journal of Research in Marketing and Entrepreneurship*, 4(3), 206 – 228.
- Lecler, Y., Yoshimoto, T. & Fujimoto, T. (2015). *The Dynamics of Regional Innovation: Policy Challenges in Europe and Japan*, London: World Scientific Publishing Co. Ltd.
- Lovering, J. (1999). Theory Led By Policy: `The Inadequacies of the New Regionalism` (Illustrated by the case of Wales), *International Journal of Urban and Regional Research*, 23(2), 379-395.
- Malecki, E.J. (2012). Regional social capital: why it matters, *Regional Studies*, 46(8),1023-1039.
- Martin, R. & Sunley, P. (2011). Conceptualizing cluster evolution: beyond the life cycle model? *Regional Studies*, 45(10),1299-1318.
- Martin, R. (2010). Rethinking regional path dependence: beyond lock-in to evolution, *Economic Geography*, 86(1), pp. 1-27.
- Maskell, P. & Malmberg, A. (2007). Myopia, knowledge development and cluster evolution, *Journal of Economic Geography*, 7, 603-618.
- Maskell, P. (2001). Towards and knowledge-based theory of the geographical cluster, *Industrial and Corporate Change*, 19(1), 921-943.
- Menzel, P. & Fornahl, D. (2010). Cluster life cycles – dimensions and rationales of cluster evolution, *Industrial and Corporate Change*, 19(1), 205-238.
- Nefke, F., Henning, M. & Boschma, R. (2011). How do regions diversify over time? Industry relatedness and the development of new growth paths in regions, *Economic Geography*, 87, 237-265.
- Niu, K-H., Miles, G., Bach, S. and Chinen, K. (2012). Trust, learning and a firm's involvement in industrial clusters: a conceptual framework, *Competitiveness Review*, 22(2), 133-146.
- Ojala, A. (2009). Internationalization of knowledge-intensive SMEs: The role of network relationships in the entry to a psychically distant market, *International Business Review*, 18(1), 50-59.

- Osarenkhoe, A. (2010). A Co-opetition strategy- A Study of Inter-firm Dynamics between competition and Cooperation, *Journal of Database Marketing & Customer Strategy Management*, 17(3/4), 201-221.
- Osarenkhoe, A. (2009). An Integrated Framework for Understanding the Driving Forces behind Non-sequential Process of Internationalisation among Firms", *Business Process Management Journal*, 15(2), 286-316.
- Porter, M. (1990). *The Competitive Advantage of Nations*, New York: Free Press.
- Porter, M. (1998), "Clusters and the new economy of competition", *Harvard Business Review*, Vol. 76 No. 6, pp. 77-91
- Porter, M. (2000). Location, competition, and economic development: local clusters in a global economy, *Economic Development Quarterly*, 14(1), 15-34.
- Portero, B., Hervás-Oliver, J.L. & Puig, F. (2012). Critical intangible factors for SME multi-location strategy in China, *International Journal of Transitions and Innovation Systems*, 2(3/4), 266-282
- Resnick, S.M., Ranis Cheng; R., Simpson, M. & Lourenço, F. (2016). Marketing in SMEs: a "4Ps" self-branding model, *International Journal of Entrepreneurial Behavior & Research*, 22(1), 155 – 174
- Sawers, J. L., Pretorius, M. W. and Oerlemans, L. G. (2008). Safeguarding SMEs dynamic capabilities in technology innovative SME-large company partnerships in South Africa, *Technovation*, 28(5), 171-182.
- Solleiro, J. L. and Gaona, C. (2012). Promotion of a Regional Innovation System: The Case of the State of Mexico, *Procedia - Social and Behavioral Sciences*, 52, 110-119.
- Suhail Sami Sultan , (2014). Enhancing the competitiveness of Palestinian SMEs through clustering, *EuroMed Journal of Business*, 9(2),164 – 174
- Säll, L. (2012). *Clusters as Theory and Politics – The Discursive Practices of Regional Growth Policy*, Karlstad, Sweden: Karlstad University Press
- Ter Wal, A. & Boschma, R. (2011). Co-evolution of firms, industries and networks in space, *Regional Studies*, 45(7), 919-933.
- Tödting, F & Trippel, M. (2008). Cluster renewal in old industrial regions: continuity or radical change?" in Karlsson, C. (Ed.), *Handbook of Research on Cluster Theory*, Cheltenham: Edward Elgar.
- Valdaliso, J.M., Elola, A., Aranguren, M.J. & López, S. (2011). Social capital, internationalization and absorptive capacity: the electronics and ICT cluster of the Basque country, *Entrepreneurship and Regional Development*, 23(9/10), 707-733.
- Van de Ven, A., Polley, D., Garud, R. & Venkataraman, S. (1999). *The innovation journey*, New York: Oxford University Press.
- Van de Vrande, V., de Jong, J.P.J., Vanhaverbeke, W & de Rochemont, M. (2006). Open innovation in SMEs: Trends, motives and management challenges, *Technovation*, 29, 423–437.
- Venkataramanaiah, S. and Parashar, S.P. (2007). Enhancing the Competitiveness of SMEs Through Industrial Clusters: the Indian Experience, *International Journal of Technology Management and Sustainable Development*, 6(3), 227-243.
- Von Hippel, E. (2001). Learning from open-source software. *MIT Sloan management review*, 42(4), 82-86.
- Yin, R.K. (2002). *Case Study Research, Design and Methods*, Newbury Park: Sage Publication.
- Zaheer, S. & Manrakhan, S. (2001). Concentration and dispersion in global industries: remote electronic access and the location of economic activities, *Journal of International Business Studies*, 32(4), 667-87.
- Zeng, S.X., Xie, X. M. & Tam, C. M. (2010). Relationship between cooperation networks and innovation performance of SMEs, *Technovation*, 30(3), 181-194.

## CYBER RISK MANAGEMENT IN CREDIT COOPERATIVE BANKS: A CASE STUDY

**Ossola, Giovanni; Giovando, Guido; Crovini, Chiara**

Department of Management, University of Turin, Turin, Italy, giovanni.ossola@unito.it

### ABSTRACT

Our research explores the Italian banking sector. In particular it focuses on the analysis of the cyber risk management in Bene Banca, a Credit Cooperative Bank (BCC) in the North-West of Italy.

This research represents a case study that can help us understand the context and the main characteristics of the methodology implied by Bene Banca in managing cyber risk. Data were collected through semi-structured interviews of an open-ended nature and questionnaires to directors, members of the audit committee, risk managers, compliance managers, internal audit function and anti-money laundering responsible.

We decided to concentrate on this small bank because of its size and its role on the local territory and because the cyber risk management is outsourced.

Furthermore we focus on the topic of cyber crime because IT attacks have increased drastically in recent years, both in terms of complexity and resources, and they cannot be stopped by single organizations, because they need a response at country level.

Consequently this paper has been motivated by the gaps in the understanding and in considering cyber risk and cyber risk management as an integral part of the business management.

*Keywords: cyber risk management, credit cooperative bank, cybercrime, threats, IT, case study*

### INTRODUCTION

Companies with the constant need to adapt to the needs of the surrounding environment have increasingly developed information and communication technologies (ICTs), leading companies to be heavily dependent on cyberspace.

In the banking system in particular, nowadays in order to be competitive, each bank must be increasingly connected to the technological world. However, cyberspace and its components are influenced by a high number of potential hazards. First of all, since they are complex and rapidly evolving systems, their vulnerability is always present. One or more of these vulnerabilities can be exploited by hackers that illegally might have access to an organization's IT systems, allowing them to

read, steal or delete critical information, or even take control of their IT or physical resources. These vulnerabilities make cyber risk very relevant from the point of view of both financial and reputational risks.

In this paper we want to analyze how a small banking reality addresses this issue.

The bank is Banca Credito Cooperativo di Bene Vagienna - BeneBanca an Italian credit cooperative bank in the North-West of Italy.

The banking system of the Credit Cooperative in Italy finds its origins in the last quarter of 1800. Since their inception these institutions were closely linked to the local communities in which they were established, in fact thanks to the deep knowledge and mutual members of the community, their family situation, their personal reputation were singled out to creditworthy people. Since then, Rural and Artisan banks have maintained a very close relationship with the territory of reference, weaving their own story with that of the communities, as to be "local banks call". The rural banks were able to grow in number and spread over time, supporting the socio-economic development of their local areas.

In 1993, the Banking Act lays down a radical change since the naming ranging from "Rural and Artisan banks" to the current "mutual banks". By means of this decree are not operating limitations of BCCs that can offer so all the products and services of other banks.

The system of mutual banks in Italy today includes 364 banks for a total of over 4,400 branches throughout the Italian territory. The employees of the banks are over 37,000.

In total there are more than one million and two hundred thousand members of the mutual banks and mutual banks are more than 6 million customers.

In December 2016, total managed amounts on behalf of customers - consisting of direct deposits and indirect deposits - amounted to EUR 977.2 million. Direct collection amounts to 599.3 million euro. Cash receivables with customers net of value adjustments (asset item 70) amount to euro 460.3 million.

Our research, as it is a case study, fits into this framework. In fact we concentrate on the topic of cyber risk management in a credit cooperative bank.

The remainder of the study is organised as follows: in paragraph 1 a brief literature review is presented, in section 2 methodology and research design are described, paragraph 3 instead presents findings, while comments and discussion follow this section and finally we present the conclusions.

## **1. LITERATURE REVIEW**

With reference to the topic of credit unions and credit cooperative banks, Smith et al. (1981) discussed about the economic theory of these businesses and Labie and Perilleux (2008) studied the Corporate Governance in Microfinance. Several researchers concentrated on this kind of banks, in terms of characteristics and role within the Italian banking sector (Bonfante, 2010; Agostini, 2009; Costa, 2007;



Capriglione 2005; Vella, 2004; Appio, 1996). Zago and Dongili (2014) examined in depth the impact of the financial crisis on the Italian credit cooperative banks and the technical efficiency of the Italian BCCs for the period 2003 to 2012, discussing and testing different specifications and objective functions for BCCs. The importance of local small banks, such as BCCs, was emphasized in few studies. Ferri and Messori (2000) stressed that close and long lasting customer relationship between small banks and firms can promote a favourable allocation of credit for economic growth. Usai and Vannini (2005) distinguished among various types of banks while studying the finance-growth nexus in Italian regions. Good capitalisation, stable funds availability and liquidity give BCCs the ability to provide credit even during the recent financial crisis, replacing other banks suffering more from the credit crunch. These elements positively affect the local community in which the BCC operates, by supporting families and the development of businesses. In 2007-2008, the financial crisis caused significant new problems in risk assessment and management. As a consequence, some researchers tried to locate the perimeter within which identify the financial risk and study methods for good management, in accordance with the requirements of Basel (Álvarez and Rossignolo 2015; Angelini et al. 2011).

This research is a contribution in the field of cyber risk management and cybercrime in the banking system.

There are several works using different methodologies that focus on cyber risk. They concentrate on cyber security as a tool to manage exposure to IT risk and protect an organization against a new form of business loss (Biener et al., 2015; Mukhopadaya et al., 2013; Mukhopadaya et al., 2005; Laurence et al., 2003). Others focus on specific tools to mitigate this risk (Hoffman and Ramay, 2011; Hieb, 2007). There are some professional guidelines that underlines the importance of building cyber resilience (PwC, 2015; MMC, 2016).

They all stress the importance of developing sound risk management and an appropriate approach, without mentioning a possible solution for companies. In particular, in the business literature, little has been studied in the subject of the banking world and its problems in dealing with cyber risk.

## 2. METHODOLOGY

### *Research design*

A case study design using multiple levels of analysis was employed for this study. This approach was necessary to 'get close' to the actors' perspectives on the complex processes of network interaction (Blackburn and Kovalainen, 2009; Curran and Blackburn, 2001). Data sources included interviews with directors, members of the audit committee, risk managers, compliance managers, internal audit function and anti-money laundering responsible. The case reported here is represented by Bene Banca, a small credit cooperative bank in Piedmont, North-West of Italy. It was founded in November, 14 in

1897. We decided to concentrate on this small bank because of its size, its role on the local territory and because one of the authors is a member of the audit committee. Furthermore this is the second step of a far deeper analysis that would involve other realities, by elaborating a multiple case study. In addition, it is interesting to analyse how a small financial institution assesses and manages cyber risk.

#### *Data collection and procedure*

The case study research was conducted by the authors over a period of six months from September 2016 to February 2017, during which time the main method for data collection was through semi-structured interviews of an open-ended nature. Thirty-five interviews were conducted in total, from which eleven interviews were carried out in the case study reported here. The major data collection was accompanied by a brief questionnaire. The purpose of the questionnaire was to collect information regarding the risk methodology employed to manage cyber risk and to build RM capability.

The study has the aim to formulate research questions by problematizing some dominant assumptions in existing research (Davis, 1971). In particular, the main research questions are the following:

- *Research question 1:* How do a small financial institution manage cyber risk?
- *Research problem 2:* How effective is the methodology pursued?

This approach would support a more reflective-scholarly attitude (Abbott, 2004) and consider a different epistemological approach.

In this case the epistemological approach is that of induction because it finally helps reach a verdict on the hypotheses, previously analysed in the phase of abduction, and the nature of the verdict is dependent on the number of testable consequences that have been verified.

Furthermore, we decided to focus on the topic of cyber crime because IT attacks have increased drastically in recent years, both in terms of complexity and resources, and they cannot be stopped by single organizations, because they need a response at country level, as they tend to diminish its economic prosperity and independence.

Consequently this paper has been motivated by the gaps in the understanding and in considering cyber risk and cyber risk management as an integral part of the business management. And the attention here is on a critical infrastructure (as defined by the NIST Framework, elaborated by the FSSCC), which is also a small company.

### **3. FINDINGS**

Thanks to the interviews and questionnaires, we found that Bene Banca applies a methodology common to all banks in the consortium. The consortium carries out an outsourced function to the bank in relation to IT risk management. This function complies with:

- Banca d'Italia - Circolare n. 263, of 27 December 2006 15° update of 2 July 2013 ;
- Provisions provided by applicable privacy laws (D. Lgs. 196/2003 "Codice in materia di protezione dei dati personali", and subsequent measures of 10.13.2008 and 11.27.2008);
- "Linee guida per la definizione di una metodologia di analisi del rischio informatico e di un processo di gestione del rischio informatico" - Support Project adjustment to the 15th update of 263/06 - new information technology and business continuity - September 2014 ;
- "Policy di Metodologia di analisi del rischio Informatico" Risk Analysis methodology - Support Project adjustment to the 15th update of 263/06 - new information technology and business continuity - in January 2014;
- Recommendations for the Security of Internet payments - European Central Bank - in January 2013.

In addition this function follows international best practices, such as: ISACA Cobit 5 for Risk; ISO/IEC 27001:2005 Information technology - Security techniques - Information security management systems - Requirements; ISO/IEC 27005:2011 Information technology - Security techniques - Information security risk management; and ISO 31000 Risk management - Principles and guidelines.

The Cyber Risk Model contains a representation of the elements and scenarios that must be considered in the field of Cyber Risk, defined on the basis of best practices in the industry.

The Cyber Risk Model consists of:

- business processes of banks;
- the representation of the main elements IT (risk factors);
- the relevant relations between elements and processes;
- threats that insist on such elements;
- the related impact on the business of the banks.

In particular, in the IT environment it is important to identify all the IT Application on which may insist Threats of IT; relationships between IT resources and the ways in which banks perform integration of IT risk with Enterprise Risks, especially reputational, strategic and operational.

It is illustrated a representation of the elements and of the scenarios that characterize the Model, and which therefore must be considered in context Risk Computer.

#### *a) Business Processes*

They are a component of the IT risk model since they contribute, through the hazards to which they are subject, to:

- assessment of impacts associated with the Risk Scenarios relating to the components of the information system that support them;
- Identification of critical components of the computer system.

*b) Business Organizational Units*

The contact people of the organizational business units of banks in the consortium are the reference actors for the evaluation of impacts. Among them, the Banks of the Consortium identify Users Officers representing end-user systems and IT applications and in dealing with internal ICT Department to the Bank.

*c) IT Elements*

The complexity of IT elements that must be analyzed and evaluated within the model, using a proportional approach to the analysis dimensions, is described below.

- IT services: consist of one or more IT applications, whose purpose is to support the delivery of the functionality required by business processes to achieve its strategic and operational objectives.
- IT Applications: a group of components in support of one or more IT Services.
- IT Processes: the management and governance of IT operational machine common to all IT applications.
- Infrastructure: elements of the model constituted by the technological and infrastructure components that support the operation of the other IT elements.

*d) IT Threats*

The IT threat is any event or circumstance that may lead to negative consequences (impact) on information systems. Any threat can be characterized in terms of vulnerability of the components of the computer system, exposure of the components to the threat and types of consequences, whereas some threats can be realized according to different modes.

The IT Threats are declined according to a hierarchical structure (Threats of I, Level II, Level III, ...) depending on the granularity of the same. This organization supports the Risk Analysis implementation at different levels of detail, depending on the availability and quality of information available on the elements to be analyzed.

*e) Risk Scenarios Computer*

It defines "Cyber Risk Scenario", or simply "Scenario IT Risk ", a homogeneous set of IT threats that can cause a certain type of impact for the business.

The main features of the IT risk scenario are:

- identification of a type of consequences for business and, accordingly, the association or one or more IT threats that have the character to generate the sort of consequences identified by the scenery or

one or more types of operational, reputational, strategic and compliance defined by the methodology in place at the individual bank of the Consortium;

- Association, through threats, to one or more elements of the IT model;
- definition, for banks, the rules of distribution of impacts from the Enterprise Risks on IT Threats;
- definition of the rules of distribution of probability values associated with threats;
- Identification of security measures to mitigate the risk associated Threats to the scenario.

The outsourcer for the portion of outsourced resources by the Bank is in charge of preparing, updating of IT Risk Scenarios and related documentation.

*f) Probability of occurrence*

The probability of occurrence of one or more IT threats is the frequency with which they may occur on one or more IT elements in a given period of time causing an impact on the consortium that will result in a negative impact for the Bank.

The estimated probability of occurrence, as well as the characterization of the associated risks, requires specific skills and knowledge of the IT environment, as well as the availability of appropriate time series.

*g) Impact of IT*

The impact of IT is the negative consequence for each bank of the Consortium, caused by the realization of one or more IT Threats. A IT Impact can be assessed qualitatively or quantitatively and includes economic damage, operating costs, violations of regulatory compliance and can be evaluated as part of the risk management process.

*h) Measurements of IT Security*

A IT security measure, whose main purpose is to reduce the risk that hangs over a computer IT element where it is applied, may act by reducing the exposure of a certain element to a IT Threat or limiting the impact of a threat. A security measure may act with respect to the various threats with a different degree of effectiveness which is defined as the level of risk that the measure helps smooth.

The set of security measures, called "IT Security Measures Library", is defined by identifying all the measures that have the ability to mitigate the impact or likelihood of occurrence of the threats contained in the "IT Threats Library". The library may take into account the fact that different security measures can act alternately in order to mitigate the risk associated with a threat to an appropriate level. In the identification of Security Measures to counter the IT Threats must be taken into account all the policies, procedures, regulations and guidelines in order to identify easily organizational security measures and procedural.

The methodology therefore identifies the essential safety measures for the mitigation of risks related to IT Threats associated with a scene.

The principles that have guided the definition of the Technological Risk analysis methodology are: the consideration of the impacts of ICT on the corporate operation risks; the desired level of granularity for analysis; compliance with general principles such as repeatability of the methodology, compliance and consistency with regulatory, and feasibility.

The prerequisites including the main stages of analysis and IT risk management are:

- *Defining the Context*: establish the main parameters of the process, collect all the key elements of the IT risk management process, define the scope of analysis and prepare a work plan;
- *IT risk identification*: identify the risk scenarios applicable to IT resources object of analysis. For the correct identification of the applicable scenarios it is necessary to consider the consequences defined by each scenario and determine whether such impact may occur on the Application IT under examination;
- *Census of IT applications*: identify IT Applications in the scope of analysis to provide sufficient information for risk analysis. This level can be redefined in successive sessions of application of the methodology;
- *Identification of IT Risk Scenarios and Threats*: such as Total Unavailability of information systems, Degradation of service quality, Breach of data privacy, Compromised data integrity, Loss of Data Quality. The association between each scenario of IT Risk and Threats IT is contained in the "IT Threats Library".
- *Definition of metrics for the evaluation of the probability of occurrence*: the evaluation of the probability of occurrence of one or more IT threats is calculated on the basis of certain assumptions criteria and the subsequent evaluation of the likelihood is represented using a qualitative scale of increasing levels of probability assessment: "Very Low", "Low", "Medium", "High", "Criticism". It is defined: a) Very Low: probability that an event will occur 1 once every three years; b) Low: probability that an event will occur 1 once a year; c) Media: probability that an event will occur 1 time every 6 months; d) High: probability that an event will occur 1 once every 3 months; e) Criticism: probability that an event will occur 1 time per month.
- *Definition of metrics for impact assessment*: the impact assessment is performed taking into account at least the aspects regarding a) the economic impact resulting from reduced or absent in the Bank's ability to generate profits through its business processes, arising from destruction or damage to physical or logical assets, of any penalties arising from non-compliance with contracted, connected service levels impossibility to comply with a legal obligation due to the occurrence of the adverse event; b) operating cost related to staff that is employed in the resolution of adverse event that occurred phases, supported by the Bank to compensate for the failure to support IT; c) the risk of non-compliance for compliance violations that may occur as a result of the occurrence of the adverse

event; d) reputational damage to the bank, generated by the event and its adverse package delivery and the modes reputational damage to the bank, generated adverse event and its consequences; e) strategic damage to the bank, generated by the event and its adverse consequences.

- *Definition of thresholds for acceptance of the risk Computer:* the bank defines the correlation to operational risk, as well as their thresholds of risk acceptance, in relation to the Risk Appetite Framework (RAF).
- *Definition of IT risk calculation model.*

In this context, there is the annual production of "synthetic report on IT risk situation."

The process of analysis and management of Computer Risks must be repeated, at least every three years and in any case in the following cases:

- for all new projects related to the development of new IT Services / IT Applications, with particular urgency for the most critical areas;
- for all infrastructural projects that may alter the level of risk previously assessed on infrastructure;
- in the event of serious accidents or deficiencies in the controls carried out;
- in the event of new threats or the dissemination of news regarding new vulnerabilities in IT applications, if either of them is of such magnitude as to be able to significantly change the threat and risk scenarios previously defined;
- In the case of new legal provisions, regulations, standards and industry standards imposed by contract that have effects on the IT and that modify the reference scenarios and may entail risks of non-compliance and, therefore, restrictive measures, sanctions or other measures that can affect the business;
- occurrence of events or threats that may affect the effectiveness of data quality assurance measures and controls covered by the Data Governance perimeter.

#### **4. CRITICAL COMMENTS AND DISCUSSION**

We have noticed the importance and significance of this risk for the bank. In fact, although it is a small reality, the issue of cyber risk is particularly monitored. This topic is dealt with by Bene Banca in a compliant manner with the rules of the Bank of Italy and has established all the procedures necessary to detect and limit this risk.

We recommend modifying the procedures when specifying that the Computer Risk Analysis and Management process should be repeated at least every three years unless clearly identified in the document. This time frame seems too broad and we propose to see it again as well as the underlying risk is constantly evolving. That because cyber risk requires a prompt reaction when a threat

materialises, while with this long time frame in updating the evaluation model, the bank risks to undergo too heavy damages.

We also suggest to analyze the NIST Framework for Improving Critical Infrastructure Cybersecurity, elaborated from the FSSC, in 2014, which is a conceptual theoretical framework that focuses on the internal organisation of financial institutions and has the fundamental aim to clarify the understanding of the organisation's business drivers and security procedures. The Framework refers to the risk management process to enable organizations to inform and prioritize decisions regarding cybersecurity. It supports recurring risk assessments and validation of business drivers to help organizations select target states for cybersecurity activities that reflect desired outcomes. From this document there may be some interesting steps in implementing the procedure.

Furthermore, in 2015, CIS Sapienza in cooperation with CINI Cyber Security National Laboratory National Interuniversity Consortium for Informatics translated and adapted the NIST Framework to the Italian context, considering both listed companies and small- and medium-sized enterprises, underlying the differences and the specific problems in implementing the framework.

## 5. CONCLUSIONS

Our research is a case study, in which we studied in depth the cyber risk management mechanisms of one Italian credit cooperative bank, by delineating the key characteristics of the model implied.

There emerged the difficulties of this small reality to sustain costs related to the management of cyber risk, in fact the elaboration of the methodology is outsourced.

However the topic of cyber crime and threats cannot be underestimate because of the potential impact on reputation, image and market share.

Therefore it is essential, despite laws and regulations, to develop, spread and communicate the right culture at every level of the organisation because every company bases its own activity on people and their values. The proper organisational behaviour impacts on growth and value-creation, not only of the bank itself, but in particular on the local community in which the BCC operates because sound corporate governance and internal controls have become the determinant elements for the stability of every single institution and of the overall financial system.

This last element can help us underline that this study represents the second step of a far deeper analysis regarding the risk management process in credit cooperative banks. In the following analyses we would like to compare and contrast other realities, elaborating a multiple case-study. It would be interesting to evaluate the impact of cyber risk on the overall performance and on the efficiency of these banks.



## REFERENCES

- Abbott, A. (2004). *Methods of Discovery: Heuristics for the Social Sciences*. New York: W.W. Norton
- Agostini S., (2009), *Le banche di credito cooperativo, Cooperativa e consorzi*, n.10, Ipsoa, Milano
- Álvarez, V. A., and Rossignolo A.F., (2015), *Análisis Comparativo De Técnicas (IMA) Para Determinar Capitales Mínimos Regulados Por Basilea, Ante Crisis En Mercados Emergentes (Comparative Analysis of Techniques (IMA) for Determining Minimum Capital Regulated by Basel, Facing Crises in Emerging Markets*, Social Science Research Network. ODEON (8),13-14. Available at SSRN: <http://ssrn.com/abstract=2566754>.
- Angelini, P., L. Clerc, V. Cúrdia, L. Gambacorta, A. Gerali, A. Locarno, R. Motto, W. Roeger, S. Van den Heuvel, and J. Vlček, (2011), *Basel III: Long-Term Impact on Economic Performance and Fluctuations*, Federal Reserve Bank of New York Staff Report, 485.
- Appio, C.L., (1996), *Le banche di credito cooperativo tra Testo Unico e disciplina del diritto comune*, in *Dir. banc. merc. Fin.*
- Banca d'Italia, Circolare n. 263 del 27 novembre 2006, *Nuove disposizioni di vigilanza prudenziale per le banche*, [www.bancaditalia.it](http://www.bancaditalia.it)
- Banca d'Italia, *Linee guida per la definizione di una metodologia di analisi del rischio informatico e di un processo di gestione del rischio informatico - Support Project adjustment to the 15th update of 263/06 - new information technology and business continuity - September 2014*, [www.bancaditalia.it](http://www.bancaditalia.it)
- Banca d'Italia, *Policy di Metodologia di analisi del rischio Informatico, Risk Analysis methodology - Support Project adjustment to the 15th update of 263/06 - new information technology and business continuity - in January 2014*, [www.bancaditalia.it](http://www.bancaditalia.it)
- Biener, C., Eling, M., Wirfs, J.H. (2015). *Insurability of Cyber Risk: An Empirical Analysis*, Working Paper of Finance, Universit of St.Gallen, no. 2015/3, 31 pp.
- Blackburn, R. and Kovalainen, A. (2009). *Researching small firms and entrepreneurship: Past, present and future*. *International Journal of Management Reviews*, 11(2), 127–148.
- Bonfante, G.,(2010), *La nuova società cooperativa*, Zanichelli, Bologna
- Capriglione, F., (2005), *Le banche cooperative e il nuovo diritto societario. Problematiche e prospettive*, in *Banca borsa tit. cred.*
- CIS Sapienza and CINI (2015) *Italian Cyber Security Report. Un report nazionale per la cyber security.*, [www.cybersecurityreport.com](http://www.cybersecurityreport.com) [Last accessed: February, 2017]
- Costa, C., (2007), *La riforma delle società e le banche cooperative*, in *Il nuovo diritto delle società: Liber amicorum Gian Franco Campobasso*, Torino
- Curran, J. and Blackburn, R. (2001). *Researching the Small Enterprise*. London: Sage.
- Davis, M. S. (1971). *That's interesting! Towards a phenomenology of sociology and a sociology of phenomenology*. *Philosophy of Social Sciences*, 1, 309–44.
- D.Lgs. 196/2003 “Codice in materia di protezione dei dati personali”, and subsequent measures of 10.13.2008 and 11.27.2008
- European Central Bank, *Recommendations for the Security of Internet payments*, January 2013, [www.ecb.europa.eu](http://www.ecb.europa.eu)
- Ferri, G. and M. Messori (2000), *Bank–firm relationships and allocative efficiency in Northeastern and Central Italy and in the South*, *Journal of Banking and Finance* 24, 1067–1095.
- Hieb, J.L. (2007). *Cyber security risk assessment for SCADA and DCS networks*, *ISA Transactions*, 46(2007), 583-594
- Hoffmann, A., and Ramaj H. (2011). *Interdependent risk networks: the threat of cyber attack*, *International Journal of Management and Decision Making*, 11(5/6), 312-323
- ISACA Cobit 5 for Risk, [www.isaca.org](http://www.isaca.org)
- ISO/IEC 27001:2005 *Information technology - Security techniques - Information security management systems - Requirements*, [www.iso.org](http://www.iso.org)
- ISO/IEC 27005:2011 *Information technology - Security techniques - Information security risk management*, [www.iso.org](http://www.iso.org)
- ISO 31000 *Risk management - Principles and guidelines*, [www.iso.org](http://www.iso.org)
- Labie M., Perilleux, A., (2008) *Corporate Governance in Microfinance: Credit Unions*, CEB Working Paper n. 08/003
- Laurence, A.G., Loeb, M.P., and Sohail, T. (2003). *A Framework for Using Insurance for Cyber-risk Management*, *Communications of the ACM*, 46(3), 81-85
- MMC Cyber Handbook (2016). *Increasing Resilience in the digital economy*, Global Risk Center, [www.mmc.com](http://www.mmc.com) [Last accessed: February, 2017]

- Mukhopadhyay, A., Chatterjee, S., Saha, D., Mahanti, A., and Sadhukan, S.K. (2013). Cyber-risk decision models: To insure IT or not?, *Decision Support Systems*, 56, 11-26
- Mukhopadhyay, A., Saha, D., Chakrabarti, B.B., Mahanti, A., and Podder, A. (2005). Insurance for Cyber-risk: A Utility Model, *Decision*, 32(1), 153-169
- National Institute of Standards and Technology. (2017). Framework for Improving Critical Infrastructure Cybersecurity, [www.nist.gov/cyberframework](http://www.nist.gov/cyberframework) [Last accessed: February, 2017]
- PricewaterHouseCoopers, Enhancing business resilience: Transforming Cyber risk management through the role of the Chief Risk Officer (CRO), December 2015, [www.pwc.com/financialservices](http://www.pwc.com/financialservices)
- Smith, D.J., Cargill, T.F. and Meyer, R.A. (1981) Credit unions: an economic theory of credit unions, *The Journal of Finance*, Vol. 36, Number 2, Pages 519–528
- Usai, S. and M. Vannini (2005), Banking structure and regional economic growth: lessons from Italy, *Annals of Regional Science* 39, 691–714.
- Vella, F., (2004). La governance delle società cooperative, in *La riforma delle società cooperative*, a cura di Borzaga – Fici, Trento
- Zago, A., Dongili, P., (2014), Financial Crisis, Business Model and the Technical Efficiency of Italian Banche di Credito Cooperativo, *Quaderni di ricerca del credito cooperativo*, n.4, [www.creditocooperativo.com](http://www.creditocooperativo.com)

## **AN EXPLORATORY STUDY ON CONSUMERS ATTITUDES TOWARDS ETHICAL FASHION CONSUMPTION: MOTIVATORS AND BARRIERS**

**Öztürk, Selen; Engizek, Nil**

Marketing Department, School of Business, Istanbul University, Istanbul, Turkey

### **ABSTRACT**

This study aims to identify how generation Y consumers approach to ethical fashion, the main factors that motive them for having this kind of a lifestyle and factors which act as a barrier in ethical consumption. In order to find out the answers to these questions, an exploratory study was carried out with three focus groups in Turkey. Through focus group discussions it became apparent that participants find these products unfashionable and expensive and also see it as a luxury lifestyle. People generally approach with skepticism. They perceive financial and performance risk for organic and fair trade products or products made of recycled materials. Consumer's spendable budget for fashion, lack of awareness and trust are mentioned as the most effective barriers, while beliefs on the health, emotional and social image benefits, environmental and social consciousness are declared to be the motivators behind.

*Keywords: Ethical consumption, ethical fashion, sustainability, fair trade, organic, attitudes, environmental consciousness, social consciousness, apparel, focus group*

### **INTRODUCTION**

Ethical consumption has gained remarkable attention from both businesses and academia over the last decade (Carrigan et al. 2004, 2011; Carter, 2009; Newholm and Shaw, 2007; Pinto et al., 2011; Szmigin et al., 2009). Szmigin et al. (2009) defined ethical consumption as "positive choice behaviors such as the purchase of fairly traded or environmentally friendly products, and can involve avoidance and boycott of certain goods or companies" (p. 224) which also include issues such as animal welfare, human rights, fair wages, and self-interested health concerns (Carrigan et al., 2004). Another definition was given by Jobber (2006, p. 217) as "the taking of purchase decisions not only on the basis of personal interests but also on the basis of the interests of society and the environment" and it is for that reason ethical consumption, social and environmental sustainability are strongly associated with each other. Sustainable and ethical consumption terms are often used interchangeably as they are directly related concepts (Goworek et al., 2012).

Ethical issues have also come to light in fashion industry (Moisander and Personen 2002, Joergens, 2006) due to the “fast fashion” trend (Paulins and Hillery, 2009 cited in Shen et al., 2012; Chan and Wong, 2012; Joy et al., 2012). Fast fashion means that retailers offer fashionable products in a wide variety, at reasonable prices and also they change their offerings in a very short time (the product lifecycle of these products is no longer than weeks – and even days) in order to gain customers’ attention and make them purchase more often (Bruce and Daly, 2006; Cachon and Swinney, 2011; Kim et al., 2013). Fast fashion strategy has been widespread amongst fashion retailers since the turn of the twenty-first century (Caro and Martínez-de-Albéniz, 2015). Stores like H&M and Zara are the examples of global fast fashion retailers (Mo, 2015; Bruce and Daly, 2006). These fast fashion retailers, including brands such as Wal-Mart, Nike, Disney and Gap Inc., may choose to produce apparel items in developing countries such as Indonesia, China and Thailand to lower production costs with cheaper labor compared to developed countries, because they have to offer consumers at affordable prices (Iwanow et al., 2005). As a result, ethical issues have come out such as labor exploitation in the form of low wages, hiring child laborers, and excessive working hours in countries such as India, China, and other Southeast Asian countries (Clark, 2008; Ro, 2010 cited in Kim, et al., 2013) and ethical consumption gained a considerable attention by the industry and academia. Several studies have been made to understand consumers fashion choices and related factors. For example, Joergens (2006) found that when it comes to fashion purchase, consumers are prompted more by personal needs for the most part to buy garments compared to ethical issues. Manchiraju and Sadachar (2014) mentioned that personal values of self-enhancement and openness to experience influence a consumer’s intention to engage in ethical fashion consumption. Also in this study it was found that women are much more into ethical fashion consumption and age is positively correlated with this behavior. Chan and Wong (2012) studied how consumers make ethical consumption decisions in fashion and found that only store-related attributes of eco-fashion positively influence consumers’ eco-fashion consumption decision. Even though there were plentiful academic research in relation to ethical issues in fashion, the bulk of studies are U.S. and European-based. Until this time, only one study (Kipöz and Atalay, 2015) has been published about eco fashion in Turkey. Belk et al. (1997) suggested that ethical consumption is a phenomenon in which culture plays a great role. Thus examining and understanding ethical fashion consumption in Turkey is essential for the growth of the ethical fashion market.

Given the above background, the purpose of this study is to investigate generation Y consumers’ awareness of eco fashion, and to find out the factors that motivate or prevent them buying those products, or behave accordingly. Generation Y consumers, born between 1977 and 1994, have been selected for this study because they tend to be socially concerned, aware of global issues and

interested in purchasing environmentally friendly apparel (Gam, 2011; Hiller Connell, 2010; Nayyar, 2001; Williams and Page, 2011). Moreover, according to Goldsmith and Clarke (2009) because they are more likely to be fashion leaders there is a high likelihood that it can become a fashion trend very quickly when they are targeted (Hill and Lee, 2015).

## DEFINITIONS OF ETHICAL FASHION

Even though as Joergens (2006) mentioned that it is tough to make a definition of ethical fashion because there is no standard in the industry, the author described it as “fashionable clothes that incorporate fair trade principles with sweatshop-free labor conditions while not harming the environment or workers by using biodegradable and organic cotton” (p. 361). The criterias for ethical fashion developed by Eco Fashion World (2011) are: (1) Vegan (2) Ethically Produced (3) Artisan (4) Custom (5) Fair trade certified (6) Organic Locally made (7) Recycle and (8) Vintage. (<http://www.ecofashionworld.com/Search-by-Eco-Criteria.html>) Studies about ethical fashion showed that even though consumers are aware of ethical issues in fashion industry and have positive attitudes towards, when it comes to purchase decision they are not that willful (Birtwistle and Moore, 2007; Joergens, 2006; Niinimaki, 2010). Solomon and Rabolt (2004) declared that there is an attitude-behavior gap in consumers’ ethical attitude and purchasing behavior in apparel industry. There could be several reasons for this gap. According to Joergens (2006) it arises from the idea of their health does not directly influenced by their unethical choice in fashion as opposed to food sector etc. Another reason could be the difficulty to sense and see the impact of ethical product/consumption choices on the environment (Sima, 2014). Besides fashion consumption is symbolic for consumers and people use it to express their selves (Berger and Heath, 2007), “for many consumers drivers to be ‘fashionable’ often outweigh drivers to be ethical or sustainable consumption” (McNeill and Moore, 2015, p.212). Since there is a perception among consumers that eco fashion is unfashionable and the choices in this sector is limited, consumers’ interest in ethical fashion is low (Carey and Cervellon, 2014). In addition, many consumers find eco-friendly apparel and textiles expensive compared to non-eco-fashion products and this lessens their purchase intent (Fletcher, 2008 cited in Fu, 2016; Niinimaki, 2010).

In order to understand which factors affect consumers’ eco fashion purchase decision several research have been conducted (Beard, 2008; Niinimaki, 2010) and attributes of product and retail stores are found to be one of the main reasons.

## **METHODOLOGY**

An exploratory research model was designed in an aim to identify how people approach to ethical fashion, the main factors that motive consumers for pursuing this kind of a lifestyle and factors which act as a barrier in ethical consumption. This approach was considered appropriate for investigating Turkish consumers' beliefs and attitudes towards a relatively new concept "ethical fashion consumption". In first and some of the following studies on the subject, qualitative research techniques were employed to reach a deeper understanding on the consumers attitudes also (Carey and Cervellon, 2014; Hassan et al., 2013; Joergens, 2006; Joy et al., 2012; McNeill and Moore, 2015; Perry and Chung, 2016; Shaw et al., 2016).

### ***Study design***

As a qualitative method, focus group interviews were planned and conducted with the guidelines of Krueger and Casey (2001); Hair et al. (2003: 224-236) and Malhotra and Birks (2007: 188-194). Focus group study is appropriate for this study with its' exploratory nature of searching for themes that occur across a topic (Breen, 2006) about which little is known (Parker and Tritter, 2006) to uncover the main ideas behind. To ensure that all focus group discussions were executed in the same manner and with similar principles, a discussion guide was prepared on the topics with the help of research questions in existing literature. In development of discussion guide, established guidelines for conducting focus groups (Kitzinger, 1995; Krueger and Casey, 2001; Wilson, 2006: 115) were used as a base. Moderators gave proper attention to discussions to develop freely with the participation of research subjects interacting with each other (Kitzinger, 1994) and did not interfere in the discussion unless it is necessary. Focus groups lasted for nearly 2 hours for each. Focus group discussions were audio-recorded with permission, with specific notes on the facial expressions and toning of research participants with regarded statements. In analysis and reporting, important themes with most remarkable quotes and interesting findings are presented (Breen, 2006; Folch-Lyon and Trost, 1981; Onwuegbuzie et al., 2009; Rabiee, 2004).

### ***Sample characteristics***

The participants were selected based on convenience sampling. Three focus groups were conducted with five to seven people participated in each. These numbers are appropriate according to existing literature on focus group sizes and the number of focus groups to be conducted (Krueger, 1994 cited in McLafferty, 2004; Morgan, 1997 cited in Cameron, 2005). Ages of participants differ between 23 and 35 by an average of 29. This recruitment was to represent generation Y. Ensuring group homogeneity is recommended in focus groups (Grudens-Schuck et al., 2004; Parker and Tritter, 2006; Zikmund and

Babin, 2010:105). There was an equal gender mix in one group, while two groups mainly constitute of men or women intentionally to be able to gain a deeper understanding in a more synergic atmosphere. First group consisted of mostly male, with an age range of 23-28. They are all single and have undergraduate degree. Fashion spend was declared as low to moderate and have low fashion watch in general. Second group contained both males and females, aged between 29-34, who are single and/or married people, and have a relatively higher education degree than the first group. Their fashion involvement was declared as medium - high and spendable budget for fashion clothing is moderate in average. Last group consisted of only women, between the ages of 25-34, all married and have one or two children, with a high school and/or an undergraduate degree. Their fashion involvement was very high and fashion spend was higher than the others also. Before centering on the ethical side of fashion consumption, participants were asked to define themselves as a shopper for apparel products. First group described themselves mainly as who are quality conscious but sensitive to discounts, shop both offline and online, collect product-related information on the internet, social media, from close friends and family. They stated that brand name is important for outwear, shoes, coats etc. They pay attention to quality they can reach within their budget. Second group consisted of quality and brand conscious consumers who are skeptical about price discounts because they do not believe that they are in advantage even with the reduced prices. Social-image is important for their decisions in apparel as well as financial and health issues. Last group was more brand conscious (mostly for shoes, bags and accessories) who shop mostly from traditional stores. They generally declared that if they attach to a specific brand or clothing, they buy it anyway without considering the price tag.

## RESULTS

Five major themes were identified from the focus group studies are as follows: familiarity with ethical fashion as a concept, product and consumer characteristics, motivators of ethical fashion consumption and perceived barriers (see Table 1).

Table 1. Research themes and key concepts

Themes	Key concepts
Familiarity with ethical fashion as a concept	Do not buy genuine leather or fur, tend to talk good things about ethical brands they know, generally avoid buying or using second hand clothing except from close family, buy organic clothes in specific categories such as underwear, sleepwear, shoes etc. Skeptic about current implementations: working ethics, social campaigns and eco-certificates The overall familiarity with the concept is moderate Ethical consumption is not a priority for fashion choices
Product characteristics	Consumers are skeptic about the prices Ethical fashion consumption is seemed as luxury lifestyle choice
Consumer characteristics	An average consumer following this trend is pictured as environmentally and socially conscious, highly educated, female, single or married (have children), between the ages of 25-

	35, have moderate to high income, a social media user, an activist, and an experienced shopper.
Motivators	Health issues Consumer conscience Contributing to future generations Spending for a good cause Self-expression
Barriers	Lack of trust Price- possibility of overpayment Results are not clearly identifiable Inadequate informative work Inaccessibility Culture

### *Familiarity with ethical fashion as a concept and ethical fashion consumption*

On the concept of ethical fashion consumption, organic consumption and its' effect on personal health was the most frequently mentioned theme. The concept of fair trade and sustainability issues are less known. Most participants mentioned that they are interested in the materials used in clothing production and working conditions/ terms of employees time to time. A participant stated: "I don't intentionally buy a clothing brand that does manufacturing on bad terms and use harmful materials and dyes for human body. It is important for me that a brand do not employ child labor. Companies must be more conscientious." (Group 1)

Huge amount of focus group participants mentioned that they don't prefer to buy genuine leather or fur. A small portion stated they buy organic clothes in specific categories such as underwear, sleepwear etc. (for their children especially). In general, they tend to talk good things about ethical brands they know and boycott unethical acts. They occasionally check for the country a product was manufactured in. On the other hand, people approach the term ethical fashion with skepticism. First of all, they don't see it as a priority for fashion choices. There is an overall understanding that even ethical fashion consumption is a favorable thing, they do not strictly follow the ethical principles sometimes knowingly and willfully. One female participant mentioned the following on the case: "I am concerned about jeans especially. I am aware of the dying processes and denim sandblasting. I know most firms manufacture in developing or under-developed countries where production is still not under the control of the authorities and employees have less or no legal rights. But to be fair, it does not affect our buying decision for most of us. However I don't want my child to wear jeans. First for her health. I don't buy any clothes for her which are produced from that material for now, even if I wear jeans occasionally." (Group 2) Another participant mentioned the following because she desires to see the same attention from legal authorities: "Eco-Labels or information on the tags sometimes seem to me not convincing. I approach them with doubt." (Group 3)



People are generally skeptical about current implementations on fair trade principles. They don't believe in corporations about working ethics in practice and their activities/campaigns on social responsibility. One participant expressed her feelings on the issue with the following sentences: "Today's fashion industry killed local tastes and local production. Everybody wear the same things on, we look very much alike. Fashion may lead people to overconsumption, we buy more than we need. I see it as hypocrisy when brands communicate that they give too much attention to it, to us. I do not find it sincere." (Group 1) There is a general understanding that they are not adequately informed about the results of these campaigns also.

Sustainability is another issue that need to be addressed. Recycling behavior was the first thing participants generally mentioned. They stated that they are careful in electricity and water use, use of plastic materials, etc. Bu for fashion choices, it is not likely for people to consider the operations of brands in terms of sustainability, at least for now. While exchanging used/old clothes between close family members and friends is a common thing, buying second hand or vintage clothing is not preferable. When asked if there are any brands that they associate with the concept of ethical fashion, brands such as TOMS, PUMA, H&M and as local brands, LCW and PENTİ had been mentioned. H&M was mentioned by three of the respondents for recycling campaign and sustainability concerns. Some declared that they have seen the informative green tags in H&M. While discussion evolved on the ongoing recycling campaign of the brand which is called "conscious", some participants mentioned that they are skeptical about a sales coupon in return of recycling behavior. They found it unattractive and not credible because of corporate benefits. They stated that they desire to see the results and the reports of these kinds of campaigns.

### *Product characteristics*

In ethical fashion, as already mentioned, it is necessary to pay attention to the use of organic raw materials and the efficient use of scarce environmental resources, taking into account the health and environment of all living things in order to produce products that are not harmful to the environment. It refers that both products and manufacturing conditions may better be harmless for individuals and public health in general, keeping future generations in mind. In terms of organic products and production, people tend to judge the producers and/or retailers by pricing much higher than the market average, even sometimes unduly. Most of the participants expressed that 'organic means expensive' to them. Also, most participants describe clothing with organic materials as colorless, boring, not so useful, not fashionable etc. They expressed their opinion on the topic by relating it to the past experiences and people around who wear. Organic clothing lines generally cover child wear and underwear/sleepwear categories in adult fashion in Turkey. They mentioned them as colorless

and boring because they generally see clothing by organic cotton in lighter colors, white, beige, light green etc. Besides they tend to judge the usefulness of the product. There is such an idea in their minds that it is not a material that can be worn for a long time because it may not withstand too many washes or machine wash. For following the acts of ethical fashion consumption behavior (buying second hand clothing, pay attention to recycling, donating or making use of old clothes, boycotting unethical actions, supporting fair working conditions etc.), consumers are less motivated also. There is a general belief that in daily life pursuing these behaviors can be very expensive in terms of money and time and exhausting by physical effort.

### *Consumer characteristics*

Participants were asked to describe a consumer that follow out or would follow ethical fashion consumption behavior. First of all, nearly all of them define it in close relation to environmental-social consciousness and education level of a person. A specific group with slightly higher education degree noted that: "This type of consciousness has nothing to do with a school education actually, it is up to self-educating and social and cultural environment in which a person lived and grew up." (Group 2) According to them it is just not enough to say that a person is conscious and sensitive to environment and society, that person should be able to demonstrate this through every act of daily life. A participant exemplified this by saying that: "Educated or not, someone who uses a jeep can't claim to be environmentalist or that someone who helps the needy rarely can't be socially conscious." (Group 2)

While one participant mentioned that he finds himself environmentally conscious because he never wears genuine leather, another one criticized herself by: "We know much on the subject (recycling, use of scarce resources, use of plastic etc.), but we don't imply with the rules of a sustainable environment. We don't act proactively, caring for the future." (Group 1)

Also age, gender and marital status were often mentioned. The role and involvement of women in fashion consumption differ from men. Participants generally claim that they would be more careful in choices of clothing for their children in the future. According to participants, having a moderate-high income is crucial for shopping from organic clothing brands. Also social responsibility comes with some expenses. Consumer involvement in the concept is needed. For recycling, donating or making use of old clothes or boycotting unethical actions, people may spend from their leisure time. These activities also require cognitive effort. Social media has been a trendsetter nowadays. People associated ethical fashion consumption to being active and demanding as a consumer in real life and also online via social media. If a person faces a problem with a product, s/he can reach the brand in various platforms if the brand has a social media presence. So social media will provide a unique

environment for an activist to communicate own ideas in this regard. In summary, an average consumer following this trend is pictured as environmentally and socially conscious, highly educated, female, single or married (have children), between the ages of 25-35, have moderate to high income, a social media user, an activist, and an experienced shopper.

### *Motivators / perceived benefits*

Consumer involvement in the concept of ethical fashion consumption, beliefs on the health, emotional and social image benefits and environmental - social consciousness are found to be the motivators behind. Health issues was the most stated motivator for the consumption of organic products. People are primarily concerned with the health of themselves and their close family members. According to participants, clothes made of organic cotton are more likely to be comfortable, healthy and functional for underwear/sleepwear category especially. For child wear, it is more favorable to wear organic in all kinds of clothes. On social responsibility activities and fair trade topic, the conscience of the consumer is the foreground. Focus group studies revealed the common idea of internal relief by spending for a good cause. Participants generally mentioned that they are emotionally into the subject when they genuinely believe in the acts of the brand. Transparency is important for them as one participant expressed: "I support social responsibility activities of companies. I know brands that communicate their support for local production and producers. I know some fashion brands that donate goods or money to some underdeveloped countries in exchange for a product we buy. I can contribute to those campaigns by paying even an extra price charged for this product. But I need to see the results to be sure whether that brand fulfilled its promise or not. I prefer that brand only if there is a good message on the benefits." (Group 1)

When brands communicate on sustainability (recycling etc.), people may also approach with suspicion. It is a favorable thing to be able to contribute to future generations by paying attention to such activities. One participant stated: "I don't have a child. But I care for this issue for my future children and grandchildren. Because I want them to be proud of me, as I am of mine." (Group 1) But they need to trust this brand and see the effects they make. There is a consensus on the demand of consumers to be informed more clearly and correctly. Brands need to be more honest and transparent in their claims. When asked to describe their overall sensitivity to the environment and social events and whether it affects their consumption behavior or not, one male respondent stated: "It is very essential in my brand choice, especially recently and from now on. We need to be given much more information on the issue" (Group 2)

On the other hand one female respondent answered the following: "I don't think it will change my brand choice but I will consider it in my mind for further. I think myself as a conscious consumer

anyway" (Group 1) According to another view, brands' favorable approach to environment and the society is good but again not enough: "To be honest, we don't prefer a brand only because it is environmentally or socially conscientious but if a brand I like do it so, I may think of buying it again instead of others in the near future."(Group 1)

Another emotional benefit is self-expression. By purchasing eco-fashion brands and exhibiting behaviors in this way, people can find a way to reflect their thoughts on others. Most participants approached the behavior as an expression of status and lifestyle.

### *Barriers / perceived risks*

Even people generally declared that they are conscious consumers for especially health and environmental issues, they are aware that it is not very much the same for their fashion choices. Price can be both a motivation tool and a barrier for consumers. Focus group discussions revealed that for pricing of organic and fair trade products, companies need to consider the value they transfer to the end users. If price is low (lower than or equal to the similar other which are not organic or fair trade), consumers can be skeptical about it based on personal expectations on quality, performance, etc. If price is too high, they may not buy because it is over their budget even they trust the brand. Besides, nearly half of the respondents agreed to buy the ethical fashion brand when it has the same prices or slightly above the non-ethical competitor. The other half supported their decision with justifications on their personal budgets. Some people declared that environment and social issues are not a priority for them. There are many different ideas on the issue. Some of them are as follows: "Am I the only one to save the world?"(Group 3), "I consider buying it for my child, not for myself"(Group 2), "If it is a huge trend, I may follow or buy an ethical fashion brand" (Group 3), "I need to be able to shop whenever I want. I don't know many fashion brands offering this kinds of products especially near my neighborhood"(Group 1), "They are limited in number and in product variety I think."(Group 1) Participants discussed the amount that they must earn to continue living on the same standards, and all the other things they need to buy. They think there will be no end in it when it comes to pursuing an ecological lifestyle in metropolis, as one participant mentioned: "We have to buy so many products for several needs in our life. Neither our money nor time is enough."(Group 3) Another participant declared her view by: "I am not a social or environmental activist. I try to comply but there is so much to do, so..."(Group 3) With a different perspective, a participant stated this based on his past experiences: "Most ethical fashion brands are of foreign origin. We don't buy it so overpriced if our local producers do launch ethical fashion brands."(Group 2)

There were several ideas on consumers' lack of trust in organic brands. Some ideas presented by two different participants are as follows: "I trust a brand more if it sells organic products only. I need to be

sure of the organic production terms.", "I buy an organic brand with the recommendation of people to whom I trust"(Group 2). People are generally skeptical about ethical fashion. They perceive some level of financial and performance risk for organic and fair trade products or products made of recycled materials. Consumer's spendable budget for fashion, education-based consumer awareness and lack of trust are mentioned as the most effective barriers by all groups. A respondent interpreted the fact as: "Perhaps such an approach is caused by culture and our current living standards. Speaking for our country, previous generations were more conscious about using clothes properly and they made the longer use of them. But even we have more information around, we don't pay attention to it and consume so fast and in the wrong way."(Group 2) Also on the topic, he made a suggestion that brands can make informative campaigns targeting older consumers. Because he find them more conscientious.

## DISCUSSION AND CONCLUSIONS

The aim of this research was to understand generation Y consumers' ethical fashion consumption knowledge, motivators and barriers which affect their purchase decisions for these products in an emerging country, Turkey. When asked, possibility of overpayment due to higher prices was appeared to be the one of main barriers. As Carrigan and Attalla (2001, p.571) mentioned ethical purchase behavior will occur if consumers perceive that buying these products do not cost them in terms of higher price, loss of quality or having to "shop around". In this study a similar result was found: all participants wish for ethical fashion products were affordable. Turkish Y generation consumers also believe that purchasing ethical fashion products as luxury consumption due to higher prices and lack of availability. Another barrier mentioned in the study was the lack of knowledge of the participants about ethical fashion products. Throughout the discussions, a specific H&M example was given (a fast fashion retailer following organic production and sustainability principles in specific apparel products), but they were not aware of it. For this reason marketing managers of fashion brands should create awareness first regarding ethical products, sustainability and its' effect on environment and society as a whole. They can use public service broadcasting, social media and trustworthy famous people in their campaigns. As Hill and Lee (2012) stated in their study; educational providers, companies, and public service sector should work together in order to give a correct description of the general principles of eco fashion and to offer a practical and essential base of knowledge in consumers' mind.

Participants mentioned that they are skeptical and do not believe in the acts of these firms. This is consistent with past studies as Yan (2003) mentioned that young consumers have high levels of skepticism. For this reason, consumers need to be informed about the ethical fashion products, why

they should prefer and the negative effects of unethical fashion consumption. Moreover, companies should convince customers about the sincerity of ethical concerns in production. To convince and gain the trust of consumers, fashion companies may use corporate social responsibility as a tool. As Hartmann et al. (2005) declared that consumers' general and sustainable buying intentions are considerably affected by perceived corporate social responsibility of firms. This means that if consumers recognize a company as making CSR campaigns they are more likely to make sustainable purchases from it. At this point, it is worth to mention 'attribution theory'. The attribution theory in the context of CSR is that "favorability towards a social program is likely contingent on certain attributions consumers make concerning the motives behind an organization's actions" (Du et al., 2007; Ellen et al., 2006; Klein and Dawar, 2004; Menon and Kahn, 2003; Sen et al., 2006; Webb and Mohr, 1998 cited in Walker et al., 2010, p. 663). An attribution (or corporate association) is about feeling or belief of a person about a specific organization (Brown and Dacin, 1997). Past studies have found that these attributions can directly have an effect on consumers' purchase intent (Ellen et al., 2006). To sum up, understanding what a consumer attributes about firm's sustainable behaviors is important in terms of affecting their ethical buying behavior. Another barrier mentioned was that ethical products are not fashionable, similar to Joergens's study (2006). This perception regarding ethical fashion products is opposite of the nature of the fashion. Fashion and trends are the main purchase motivators in the clothing industry (Solomon and Rabolt, 2004) and marketing managers of fashion brands must take this into consideration. Producing aesthetic and fashionable products while taking sustainability issues into consideration is the best thing to do, although it is not easy. Firms should create awareness and need for the category by taking into account the several motivators mentioned before. This study is the start of ethical fashion consumer research in Turkey and can develop into various directions in the future. However this study has an important limitation: it is not representative of all generation Y in Turkey as it was a qualitative study with three focus groups. Further research may examine a broader range of consumer typology, different characteristics and drivers by several ethical consumption behavior respectively. Theoretical models can be applied on the subject with the help of conclusions made on exploratory studies with Turkish consumers.

## REFERENCES

- Beard, N.D. (2008). "The branding of ethical fashion and the consumer: a luxury niche or massmarket reality?", *Fashion Theory: The Journal of Dress, Body & Culture*, 12(4), pp. 447-468.
- Belk, R.W., Ger, G. and Askegaard, S. (1997), "Consumer desire in three cultures: results from projective research", *Advances in Consumer Research*, 24, pp. 24-28.
- Berger, J. and Heath. C. (2007), "Where consumers diverge from others: identity signalling and product domains", *Journal of Consumer Research*, 34, pp. 121-134.
- Birtwistle, G. and Moore, C.M. (2007), "Fashion clothing—where does it all end up?", *International Journal of Retail & Distribution Management*, 35, pp. 210-216.

- Breen, R.L. (2006), "A practical guide to focus-group research", *Journal of Geography in Higher Education*, 30(3), pp. 463-475.
- Brown, T., and Dacin, P. (1997), "The company and the product: Corporate associations and consumer product responses", *Journal of Marketing*, 61(1), pp. 68-84.
- Bruce, M. and Daly, L. (2006), "Buyer behavior for fast fashion", *Journal of Fashion Marketing and Management*, 10(3), pp. 329-344.
- Cachon, G.P., and Swinney, R. (2011), "The value of fast fashion: Quick response, enhanced design, and strategic consumer behavior", *Management Science*, 57(4), pp. 778-795.
- Cameron, J. (2005), "Focussing on the Focus Group", in Iain Hay (ed.), *Qualitative Research Methods in Human Geography*, 2nd ed., Oxford University Press, Melbourne, Chapter 8, pp. 156-182.
- Carey, L., and Cervellon, M.C. (2014), "Ethical fashion dimensions: pictorial and auditory depictions through three cultural perspectives", *Journal of Fashion Marketing and Management*, 18(4), pp. 483-506.
- Caro, F. and Martínez-de-Albéniz, V. (2015), "Fast fashion: business model overview and research opportunities", in Agrawal, N. and Smith, S.A. (Eds), *Retail Supply Chain Management: Quantitative Models and Empirical Studies*, 2nd ed., Springer, New York, NY, pp. 237-264.
- Carrigan, M., and Attalla, A. (2001), "The myth of the ethical consumer—do ethics matter in purchase behaviour?", *Journal of Consumer Marketing*, 18(7), pp. 560-578.
- Carrigan, M., Moraes, C., and Leek, S. (2011), "Fostering responsible communities: A community social marketing approach to sustainable living", *Journal of Business Ethics*, 100(3), pp. 515-534.
- Carrigan, M., Szmigin, I., and Wright, J. (2004), "Shopping for a better world? An interpretive study of the potential for ethical consumption within the older market", *Journal of Consumer Marketing*, 21(6), pp. 401-417.
- Carter, R.E. (2009), "Will consumers pay a premium for ethical information?", *Social Responsibility Journal*, 5(4), pp. 464-477.
- Chan, T.Y. and Wong, W.Y. (2012), "The consumption side of sustainable fashion supply chain: understanding fashion consumer eco-fashion consumption decision", *Journal of Fashion Marketing and Management*, 16(2), pp. 193-215.
- Clark, H. (2008), "Slowfashion – an oxymoron – or a promise for the future?", *Fashion Theory*, 12(4), pp. 427-446.
- Du, S., Bhattacharya, C. B. and S. Sen (2007), "Reaping Relational Rewards from Corporate Social Responsibility: The Role of Competitive Positioning", *International Journal in Research Marketing*, 24(3), pp. 224-241.
- Ellen, P.S., Webb, D.J. and Mohr, L.A. (2006), "Building Corporate Associations: Consumer Attributions for Corporate Socially Responsible Programs", *Journal of the Academy of Marketing Science*, 34(2), pp. 147-157.
- Fletcher, K. (2008), "Sustainable fashion and clothing", *Design Journeys*, Earthscan, Malta.
- Folch-Lyon, E., and Trost, J.F. (1981), "Conducting focus group sessions", *Studies in Family Planning*, pp. 443-449.
- Fu, W. (2016), "Eco-Fashion Consumption: Cognitive-Experiential Self-Theory", Doctoral dissertation, University of Tennessee, [http://trace.tennessee.edu/utk\\_graddiss/3914](http://trace.tennessee.edu/utk_graddiss/3914)
- Gam, H.J. (2011), "Are fashion-conscious consumers more likely to adopt eco-friendly clothing?", *Journal of Fashion Marketing and Management*, 15(2), pp. 178-193.
- Goldsmith, R.E. and Clarke, R.A. (2009), "An analysis of factors affecting fashion opinion leadership and fashion opinion seeking", *Journal of Fashion Marketing and Management*, 12(3), pp. 308-322.
- Goworek, H., Fisher, T., Cooper, T., Woodward, S., and Hiller, A. (2012), "The sustainable clothing market: an evaluation of potential strategies for UK retailers", *International Journal of Retail & Distribution Management*, 40(12), pp. 935-955.
- Grudens-Schuck, N., Allen, B.L., and Larson, K. (2004), "Methodology brief: focus group Fundamentals", *Extension Community and Economic Development Publications*, Book 12, [http://lib.dr.iastate.edu/extension\\_communities\\_pubs/12](http://lib.dr.iastate.edu/extension_communities_pubs/12)
- Hair, J., Bush, R.P. and Ortinau, D.J. (2003), *Marketing Research: Within a Changing Information Environment*, McGraw-Hill/Irwin.
- Hartmann, P., Ibanez, V.A. and Sainz, F.J.F. (2005), "Green branding effects on attitude: functional versus emotional positioning strategies", *Marketing Intelligence & Planning*, 23(1), pp. 9-29.
- Hassan, L., Shaw, D., Shiu, E., Walsh, G., and Parry, S. (2013), "Uncertainty in ethical consumer choice: a conceptual model", *Journal of Consumer Behaviour*, 12(3), pp. 182-193.
- Hill, J., and Lee, H.H. (2012), "Young Generation Y consumers' perceptions of sustainability in the apparel industry", *Journal of Fashion Marketing and Management*, 16(4), pp. 477-491.
- Hill, J., and Lee, H.H. (2015), "Sustainable brand extensions of fast fashion retailers", *Journal of Fashion Marketing and Management*, 19(2), pp. 205-222.
- Hiller Connell, K.Y. (2010), "Internal and external barriers to eco-conscious apparel acquisition", *International Journal of Consumer Studies*, 34(1), pp. 279-86.

- Iwanow, H., McEachern, M.G., and Jeffrey, A. (2005), "The influence of ethical trading policies on consumer apparel purchase decisions: A focus on The Gap Inc.", *International Journal of Retail & Distribution Management*, 33(5), pp. 371-387.
- Jobber, D. (2006), *Principles and Practice of Marketing*, 5th edition, McGraw-Hill, Maidenhead
- Joergens, C. (2006), "Ethical fashion: myth or future trend?", *Journal of Fashion Marketing and Management*, 10(3), pp. 360-371.
- Joy, A., Sherry Jr, J.F., Venkatesh, A., Wang, J., and Chan, R. (2012), "Fast fashion, sustainability, and the ethical appeal of luxury brands", *Fashion Theory*, 16(3), pp. 273-295.
- Kim, H., Jung Choo, H., and Yoon, N. (2013), "The motivational drivers of fast fashion avoidance", *Journal of Fashion Marketing and Management*, 17(2), pp. 243-260.
- Kipöz, Ş., and Atalay, D. (2015), "Etik Modanın Temsiliyeti Bağlamında Vaatleri ve Çelişkileri: 'Etik Moda'Ne Kadar Etik Sunuluyor?", *Dokuz Eylül Üniversitesi Yaşadıkça Eğitim Dergisi*, 14, pp. 101-115.
- Kitzinger, J. (1994), "The methodology of focus groups: the importance of interaction between research participants", *Sociology of health & illness*, 16(1), pp. 103-121.
- Kitzinger, J. (1995), "Qualitative research. Introducing focus groups", *British medical journal*, 311(7000), pp. 299.
- Klein, J. and Dawar, N. (2004), "Corporate Social Responsibility and Consumers' Attributions and Brand Evaluations in a Product – Harm Crisis", *International Journal of Research in Marketing*, 21(3), pp. 203-217
- Krueger R. (1994), *Focus Groups, A Practical Guide for Applied Research*, 2nd edition, Sage Publications, Thousand Oaks, pp. 36-45.
- Krueger, R.A. and M.A. Casey (2001), "Designing and Conducting Focus Group Interviews", in R.A. Krueger et al. (eds) *Social Analysis, Selected Tools and Techniques*, pp.10-23. Social Development Paper No. 36. Washington, DC: World Bank, Social Development Department.
- Malhotra, N.K., and Birks, D.F. (2007), *Marketing research: An applied approach*, Pearson education.
- Manchiraju, S., and Sadachar, A. (2014), "Personal values and ethical fashion consumption", *Journal of Fashion Marketing and Management*, 18(3), pp. 357-374.
- McLafferty, I. (2004), "Focus group interviews as a data collecting strategy", *Journal of advanced nursing*, 48(2), pp. 187-194.
- McNeill, L., and Moore, R. (2015), "Sustainable fashion consumption and the fast fashion conundrum: fashionable consumers and attitudes to sustainability in clothing choice", *International Journal of Consumer Studies*, 39(3), pp. 212-222.
- Menon, S. and Kahn, B. E. (2003), "Corporate Sponsorships of Philanthropic Activities: When Do They Impact Perception of Sponsor Brand?", *Journal of Consumer Psychology*, 13(3), pp. 316-327.
- Mo, Z. (2015), "Internationalization Process of Fast Fashion Retailers: Evidence of H&M and Zara", *International Journal of Business and Management*, 10(3), pp. 217-236.
- Moisander, J. and Personen S., (2002), "Narratives of Sustainable Ways of Living: Constructing the Self and Others as a Green Consumer", *Management Decision*, 40(4): 329-342.
- Morgan, D.L. (1997), *Focus Groups as Qualitative Research*, Newbury Park, Cal.: Sage.
- Nayyar, S. (2001), "Inside the mind of Gen Y", *American Demographics*, 23(9), pp. 6.
- Newholm, T. and Shaw, D. (2007), "Studying the ethical consumer: a review of research", *Journal of Consumer Behaviour*, 6(5), pp. 253-270.
- Niinimäki, K. (2010), "Eco-clothing, consumer identity and ideology", *Sustainable Development*, 18(3), pp. 150-62.
- Onwuegbuzie, A.J., Dickinson, W.B., Leech, N.L., and Zoran, A G. (2009), "A qualitative framework for collecting and analyzing data in focus group research", *International journal of qualitative methods*, 8(3), pp. 1-21.
- Parker, A., and Tritter, J. (2006), "Focus group method and methodology: current practice and recent debate", *International Journal of Research & Method in Education*, 29(1), pp. 23-37.
- Paulins, V.A. and Hillery, J.L. (2009), *Ethics in the Fashion Industry*, Fairchild Books, New York, NY.
- Perry, A., and Chung, T. (2016), "Understand attitude-behavior gaps and benefit-behavior connections in Eco-Apparel", *Journal of Fashion Marketing and Management*, 20(1), pp. 105-119.
- Pinto, D.C., Nique, W.M., Anana, E.D.S. and Herter, M.M. (2011), "Green consumer values: how do personal values influence environmentally responsible water consumption?", *International Journal of Consumer Studies*, 35(2), pp. 122-131.
- Rabiee, F. (2004), "Focus-group interview and data analysis", *Proceedings of the nutrition society*, 63(04), pp. 655-660.
- Ro, J. (2010), "The aesthetic values of slow fashion from an ecological and social viewpoint", unpublished PhD thesis, Seoul National University, Seoul.



- Sen, S., Bhattacharya, C. B. and Korschun, D. (2006), "The Role of Corporate Social Responsibility in Strengthening Multiple Stakeholder Relationship: A Field Experiment", *Journal of the Academy of Marketing Science*, 34(2), pp. 158-166.
- Shaw, D., McMaster, R., and Newholm, T. (2016), "Care and commitment in ethical consumption: An exploration of the 'attitude-behaviour gap'", *Journal of Business Ethics*, 136(2), pp. 251-265.
- Shen, B., Wang, Y., Lo, C. K., and Shum, M. (2012), "The impact of ethical fashion on consumer purchase behavior", *Journal of Fashion Marketing and Management*, 16(2), pp. 234-245.
- Sima, V. (2014), "Green Behaviour of the Romanian Consumers", *Economic Insights-Trends & Challenges*, 66(3), pp. 77-89.
- Solomon M and Rabolt N. (2004), *Consumer Behaviour in Fashion*, Prentice-Hall: Englewood Cliffs, NJ.
- Szmigin, I., Carrigan, M. and McEachern, M.G. (2009), "The conscious consumer: taking a flexible approach to ethical behaviour", *International Journal of Consumer Studies*, 33(2), pp. 224-231.
- Walker, M., Heere, B., Parent, M.M. and Drane D., (2010), "Social Responsibility and the Olympic Games: The Mediating Role of Consumer Attributions", *Journal of Business Ethics*, 95(4), pp. 659-680.
- Webb, D. J. and Mohr, L. A. (1998), "A Typology of Consumer Responses to Cause-Related Marketing: From Skeptics to Socially Concerned", *Journal of Public Policy and Marketing*, 17(2), pp. 226-238.
- Williams, K.C. and Page, R.A. (2011), "Marketing to the generations", *Journal of Behavioral Studies in Business*, 5(1), pp. 1-17.
- Wilson A. (2006), *Marketing Research: An Integrated Approach*, Second Edition, Pearson Education Limited.
- Yan, J. (2003), "Corporate responsibility and the brands of tomorrow", *Brand Management*, 10(4/5), pp. 290-302.
- Zikmund, W.G. and Babin B.J. (2010), *Essentials of Marketing Research*, 4th Edition, South-Western Cengage Learning.

## CORPORATE CRISIS IN ITALY: YOMO SPA

**Pavone, Pietro<sup>1</sup>; Migliaccio, Guido<sup>2</sup>**

<sup>1</sup>Italian Ministry of Economy and Finance, Tax Police - Special Unit, Milan, Italy

<sup>2</sup>Department of Law, Economics, Management and Quantitative Methods, University of Sannio, Benevento, Italy

### ABSTRACT

This paper presents the most relevant Italian scientific teachings and an itemized analysis of the crisis of an important company: Yomo spa which, despite the fact that it first introduced yogurt in Italy, mismanaged strategies, marketing plans and production choices. The objectives of this paper will be achieved with some theoretical considerations based on a qualitative approach including an updated conceptualization of the literature review and references to one case study (Yomo spa). This paper describes some possible mismanagement of a medium-sized company and offers useful reflections to prevent new corporate crises.

There are some practical and social implications: prevention of new corporate crises in Italy and other countries and prevention of depletion of economies, unemployment, the reduction of the gross domestic product and the lowering of the living standards of the people.

*Keywords: Causes of Enterprise Crises, Mismanagement, Crisis Enterprise System, Imbalances System Enterprise, Case Study Method.*

### 1. INTRODUCTION, HYPOTHESES AND RESEARCH QUESTIONS: AIMS AND STRUCTURE OF THE PAPER

For many years the dramatic international crisis has been affecting the major economic powers and perhaps Italy is slowly emerging; this event revives the theme of corporate instabilities. As a result of globalization, the current years are involved in the reorganization of the production sector because of the implications of the vast international crisis.

The article points out the importance of economic and financial balance and, at the same time, specifies the possible causes of the looming decline that sometimes in the initial stages escapes the attention of top management bodies, but then appears suddenly when the crisis is already deep and has already caused irreparable damage.

---

The paper is the result of a collaborative work. However it is possible to attribute to Pietro Pavone: Yomo Spa: the company and its history, the crisis and strategies for the redevelopment and relaunch. The other sections are of Guido Migliaccio.

This paper investigates the Italian situation: first, there are references to thoughts of the best international and national doctrine, and then it focuses on a specific case which stimulates reflections.

This paper aims to answer the following questions:

- What are the most frequent causes of a corporate crisis?
- Has the external environment any impact on the balance of a company?
- What function can be due to a disruption?
- What are the most significant measures derived from the experience of Yomo spa?

In particular, the objectives of this paper are:

- to emphasize the importance of a proper and balanced production of a productive, economic and financial management;
- to highlight how the environment can have a relevant impact on corporate goals;
- to stress that the information system can constantly monitor the operating trends to predict and prevent imbalances, decline and crisis;
- to propose the control of individual business functions that prevent malfunctions which can spread throughout the productive organism.

In the first section, this paper discusses the International and the Italian literature and some notes relating to the most important scientific theories which build the basis for the interpretation of the company crisis.

Subsequently, it will highlight the methodology used inside this article: the explanation of a real Italian company case useful for learning some crisis factors. Furthermore, it will explain the importance of the informative system crisis prevention. Finally, the paper will reach its conclusion: with an efficient informative system, constantly updated and with an expert staff inspired by ethical values, honest and devoted to the company you can identify imbalances and solve the situation before the decline becomes critical.

## **2. RESEARCH APPROACH**

The objectives of this paper will be achieved with some theoretical considerations based on a qualitative approach (Maylor and Blackmon 2005; Yin 1994 and 2003), including an updated conceptualization of the literature review and references to one case study (Yomo spa).

Case study is an ideal methodology when a holistic, in-depth investigation is needed (*Djurić et al.* 2010) A case is an instance of a more general category. To conduct a case study is therefore to investigate something, which has significance beyond its boundaries. Case studies provide intellectual gearing, making a contribution to a wider debate as well as offering a rounded account of a particular subject. They offer a double return on the research investment. Economics scholars do not have a single theoretical model to underpin their research. They must proceed by inspecting cases rather than by making deductions from first principles. In the absence of overarching theory, case studies are the building blocks from which economic science constructs understanding of the managerial world (Yin 2012, Gerring 2007, Naumes and Naumes 2006).

In this paper the case study is linked to qualitative research. One of the key benefits of qualitative research is that it allows an understanding of the context in which all decisions and actions take place (Myers 2013). It is often the case that human decisions and actions can only be understood in context because the context helps to 'explain' why someone acted as they did. This context (or multiple contexts) is best understood by observing the evolution of technology, the economy and culture, which greatly influence people's behavior.

This paper, therefore, offers results from a specific case study and instead proposes a number of critical considerations taking into account the latest developments, as described by the best International and Italian bibliography. This work offers interdisciplinary value because it originates from the combination of technical, general economic, managerial, ethical, and other fields.

### **3. LITERATURE REVIEW**

#### **3.1 Causes of enterprise crises in international literature (notes)**

A large number of studies are devoted to the general economic crisis and its implications on companies. Giesecke et al. (2014) using an extensive data set on corporate bond defaults in the US from 1866 to 2010, study the macroeconomic effects of bond market crises and contrast them with those resulting from banking crises: corporate default crises have far fewer real effects than do banking crises. Even Gonzalez (2015) analyses the influence of the financial crisis on corporate debt maturity for 39 countries during the period 1995-2012. The financial crisis had a stronger negative effect on corporate debt maturity in countries with less bank concentration, while the debt maturity of

larger firms decreased less as a result of the financial crisis than the debt maturity of smaller firms in countries where banks play an important role in the financing of the private sector.

De Fiore and Uhlig (2015) show that the flexibility offered by banks on the terms of their loans and firms' ability to substitute among alternative instruments of debt finance are important to shield the economy from adverse real effects of a financial crisis.

The serious crisis in the international financial system has also stimulated new depth studies on the causes of the crisis are attributable to management errors.

Pirson and Turnbull (2015), for example, focus the responsibility of corporate governance. Contrary to popular opinion the principal cause of the crisis was not sub-prime mortgage defaults but a failure of corporate governance.

In the international literature there are also specialized studies on crisis management. Morel and Chauvin (2016) identify four methodological challenges: modelling and analyzing the crisis management activity of a collective, capturing the flows of information and interactions between actors; identifying the deficiencies in information management; and choosing between on-site and simulated analysis. Topper and Lagadec (2013) aim to clarify why the crisis management world has profoundly changed and how the current understanding of crises and theoretical frameworks is becoming increasingly less adequate. They therefore propose a fractal approach.

The topic of corporate crisis demands the need for an ethics of the economy (Janssen et al. 2015) that must be taught to future managers (Simola 2014).

The theme of relations between crisis management and planning is also widely developed in Pang et al., (2006).

Even corporate communications and advertising, and thus the reputation and image of a company, may have an important role before and during corporate crises, as shown by the studies Ho et al. (2016) and Coombs and Holladay (2006).

Finally, it is necessary to remember that there are numerous studies concerning specific sectors of the economy and also publications related to situations of some States.

### **3.2 Causes of enterprise crises in Italian literature (notes)**

The causes can be divided into external and internal.

Among the internal causes: the possible problems of each business function and especially the information system that did not show malfunctions promptly.

The Italian theories considering the crisis caused by imbalances of the entire company system are numerous (Migliaccio 2012 and 2015).

A first theory (Riparbelli 1950) attributes the crisis to insufficient adaptation of the company to the economic and social environment that leads to the alteration of internal co-ordinations and external relations. This may be due to errors in the perspective of future phenomena, and / or the low elasticity of the company.

A second approach (Prosperi 2003) completes the previous theory, with further considerations: the business purposes are achieved more easily if you get an optimum degree of order dynamic internal and external, closely related, favouring a financial and economic balance sheet. Dysfunctions, which are often in preparation for the crisis, are the effects of a disorder caused by lack of cohesion between inputs, by badly systematized operations or by disharmony between internal and external forces.

A third hypothesis (Vergara 1987) arises from an interpretation of the system company-according to which two groups of factors can be identified: the first consists of goals, decisions and actions; the second, however, structures, procedures and institutionalized relationships, processes and flows. This system interacts with the surrounding environment. The crisis could arise from failure of the balances in these reports.

Another hypothesis (Canziani 1986) study the origins of the crisis: the companies taking excessive global profile of risk than management skills. Another theory (Vergara 1988) is developed by identifying the first business purposes: they cannot be limited only to economic dimensions, but must extend to the competitive and social dimensions that are distinct, even if they are closely related to the first. The synergies between the objectives may operate in the opposite direction, starting a company motion representing the descending imbalances, decline, crisis and instability.

You must also consider the argument (Sorci 1987, Viganò 1996, Confalonieri 1995, Poddighe 2006), that the origin of every crisis is man's responsibility and, therefore above all, the responsibility of the entrepreneur. The entrepreneur is responsible in large and small companies, even if the property is distributed among a large number of members.

The crisis can be generated by the alteration of the relationship between the logical categories in constant osmosis that characterize the dynamic business (Paolone 2008): the crisis originated in the possible discrepancies that jeopardize the beneficial relationship transforming, in severe cases, in a vicious circle.

The company consists of three structures: the owner, the business summit and the operating system (Moliterni 1999, Passeri 2011).

A) The ownership structure consists of shareholders who hold venture capital. They take the main decisions and perform functions guidance and control.

B) The entrepreneurial attitude, however, centralized decision-making power, choosing the formula management and strategies to implement it. The entrepreneurial attitude must also organize and govern the operating system.

In order for the enterprise, complex system, to be able to last it is necessary that the interdependence between its different elements are coherent to achieve the goals.

However it can happen that some mutations, especially if unexpected, can generate situations of inconsistency, physiological (if temporary and solvable); pathological (if sustained). Because of inconsistencies the crisis begins (Moliterni 1999). The permanent inconsistencies denote the inability of the company to adapt to the new situation: the company is stiffened on previous consistencies that are inadequate to deal with the current situation, or it is crystallized on new consistencies unsuitable changing situation.

The theory of Vital Systemic Approach (SVA) (Golinelli 2002, 2006, 2010) delivers the business crisis in a different light (Piciocchi 2005): it interprets reality with a business model of the anatomy (as is done) and physiology (how it works).

The crisis would then be due to the decrease in the time of the vitality of the enterprise as a result of low efficiency and effectiveness of government (systemic crisis) and/or operational structure (structural crisis). The Italian theories considering the crisis caused by errors of each corporate department identify crises arising out of errors in strategy, marketing, finance, production, organization, function research and development, in the information system.

#### **4. YOMO SPA: THE COMPANY AND ITS HISTORY**

Owned by the Vesely family, Sitia Yomo Spa was the company that created the yogurt market in Italy. It has operated since its establishment, mainly in manufacturing and marketing of yogurt to which, later, were added productions and tradings of milk, cheese and other dairy products distributed throughout the national territory.

Yomo was born in 1947 when Leo Vesely created the homogenous yogurt (hence the name Yomo), after several attempts and laboratory experiments on the properties of lactic acid bacteria. Following several acquisitions, which made it possible to incorporate key brands and to extend the offer, which was originally not including cheese and dairy products, the industrial activities of the group came to be "detected" from Sitia Yomo spa, from subsidiaries "Torre in Pietra spa", "Istituto Italiano Fermenti

spa", "Centro Sperimentale del Latte spa", "Caseificio Pasquale Pettinicchio spa", "Caseificio F.lli Merlo spa" and the subsidiary in fact "Leo Marven System Spa".

By judgment of the Court of Pavia, filed on May 31, 2004, the company was admitted to the agreed group estimate procedure which involved, in addition to Sitia Yomo, the subsidiaries "Caseificio Pasquale Pettinicchio spa" and "Leo Marven System spa". Simultaneously, the Court authorized the lease of Yomo companies, Pettinicchio, Merlo and Leo Marven System to the vehicle Yogolat, specifically established by the Granarolo Group to manage the operation. Therefore, in 2006, the company took part in the transfer of receivables, relating to investments and properties of Granarolo, and then Yomo Group, was sold on the 22nd of July 2008.

With the acquisition of Yomo, even Centro Sperimentale del Latte spa became part of Granarolo group. The table and chart provided below shows the amounts (in thousands of euro) of Yomo turnover from 1996 to 2004. It is represented in the charts how the Yomo Group has always made most of its turnover in the mass distribution channel; the least share of turnover resulting from the catering and restaurant sector.

1996	1997	1998	1999	2000	2001	2002	2003	2004
159.035	162.221	172.076	196.390	206.720	208.044	180.809	183.857	29.781

Table 1. *Sitia Yomo Spa turnover from 1996 to 2004 (values in thousands of euros)*

## 5. YOMO SPA: THE CRISIS

To understand the crisis of YOMO it is necessary first to understand the competitive dynamics of the industry of yogurt in the years preceding the crisis.

The following chart sets a comparison in terms of market share between the four main players in the yogurt market from 1994 to 2000.



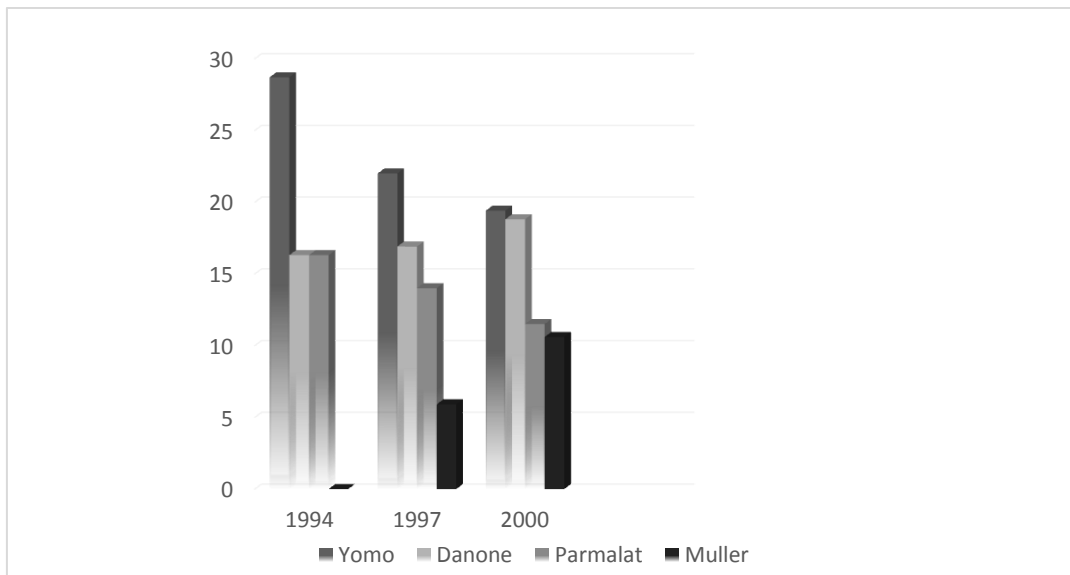

In particular, the yogurt market in Italy during 2000, had a value of over 750 million Euros and cooperated with about sixty manufacturers of yogurt, the majority of which were multi-product companies, constituting the yogurt just one of multiple managed business. 60.3% of this value was achieved by the first four companies: Yomo, Danone, Parmalat and Muller, with the market share referred to in the above diagram.

The loss of market share of Yomo is clear; the graph draws attention to the growth of Danone, the stability of Parmalat and the rise of Muller, which emerged in the late nineties.

The Italian yogurt market set entry barriers in order to protect itself from new possible competitors. This belief was confirmed by the failure of the attack in 1992 by one of the most important worldwide companies: Yoplait, part of the French Kraft Group.

In 1996 there was a second attack by Muller, a German company very strong in the field of yogurt and dairy products in Germany and Britain. This time the experiment was successful (table n. 2): as a consequence, the market became sensitive to a specialized market niche.

During the same years, Yomo invested economic efforts in terms of marketing and advertising, without reaching the desired effects. A significant example is the Yomo advertising campaign of the late nineties, "as Yomo you can find only Yomo": while Danone communicated the importance of a health-conscious yogurt, Parmalat a quality yogurt and Muller considered yogurt as a hedonistic pleasure, the slogan of Yomo was an empty message: apparently the company had nothing to communicate.

The crisis that Yomo has gone through has thus been a crisis of economic and industrial nature, revealing the financial imbalances that led to negative economic results.

2000 was the most critical year for Yomo and marked a clear break with the past. In spite of very adverse balance sheet data Yomo, still remained the company holding the largest share of the yogurt market. The turnover, although declining, was still in line with the principal direct competitor: Danone Italia.

The sales volume in 2000 was accounted for by approximately 81% of sales of yogurt and 19% for cheese sales. This explains why Yomo has suffered the rise of Muller in more than its competitors: because their offer was more vast and so they were less exposed to the only yogurt market risk. This difference played a crucial role: the preponderance of the business “Yogurt” that has always been the main source of revenue for Yomo, became one of the major causes of decline.

The management wasn't able to read the competition strategy implemented in the market where Yomo operated. Guatri (1986) states that the methods based on intuition “are based on the recognition of the external factors of crisis”. Working in declining sectors, progressive loss of market share, production or sales inefficiencies are external elements indicating a state of decline of the company. As shown by Muller, Yomo has not been able to interpret the evolution of the market or innovate in a market where product innovation meant success.

The brand still enjoyed absolute prestige in 2000 and decisions about Pettinicchio and Yomo made by Granarolo were a proof. Dairy products preserved Pettinicchio brand and yogurts kept the Yomo brand even after the control acquired by Granarolo. These choices can be identified in a strategy of maintaining a strong market position, which the two companies already enjoyed before the acquisition and so before the crisis.

However, from the quantitative point of view, the data resulting from the balance sheet, recorded discontinuity precisely since 2000. The following table n. 2 shows the data of the fiscal year closed on the 31st of December 2000 compared with those of 1999.

	1999	2000
Current assets	40.763	77.365
Net fixed assets	105.111	93.591
Current liabilities	70.828	131.741
Long/short term liabilities	51.760	27.629
Net capital	23.286	11.586

Table 2. *Main balance sheet items in 1999 and 2000*

In 2000 a prompt action was required to reduce the debt of the company by injecting capital and the reorganization of several cost components was necessary, already constantly monitored by management. Current liabilities within a year had almost doubled: in 2000 the amount of assets was not sufficient to cover maturing liabilities. This constituted an important first alert of lack of liquidity.

The net working capital deficit of -40.861, an increase compared to 1999 when it amounted to 37.881, showed a clear short-term financial imbalance, indicative of a precarious enterprise solvency; in 2001 the net working capital deficit widened further and stood at -47.877.

	Yomo	Danone	Parmalat
Return On Sales	-3,48%	10,08%	9,82%
Return On Investment	-4,93%	25,94%	2,35%
Return On Equity	-50,24%	56,24%	6,33%

Table 3. Comparative analysis of the main financial indicators in 2000

Table n. 3 is extremely significant because the comparison with similar entities underlines the economic difficulties. If it is true that in 2000 the yogurt market showed a decrease compared to the previous year by 3.4% in value and by 0.3% in volume (Data source: Nielsen), the data for the indicators ROS, ROI and ROI, in a comparison between the main competitors, it doesn't seem to leave room for assumptions of merely cyclical crisis, confirming, however, an internal inefficiency.

The following table summarizes the main balance sheet items of Yomo 1999-2000.

	1999	2000	2001
Current assets	40.763	77.365	65.252
Net fixed assets	105.111	93.591	93.822
Total assets	145.874	170.956	159.074
Current liabilities	70.828	131.741	120.679
Long/short term liabilities	51.760	27.629	29.162
Total liabilities	122.588	159.370	149.841
Net capital	23.286	11.586	9.233
Balance	145.874	170.956	159.074
Return On Sales	1,12%	-3,48%	-3,52%
Return On Investment	1,42%	-4,93%	-4,28%
Return On Equity	0,03%	-50,24%	-19,45%

Table 4. Main items and financial ratios 1999-2001 (Data source: Aida)

A progressive growth in debt is obtained:

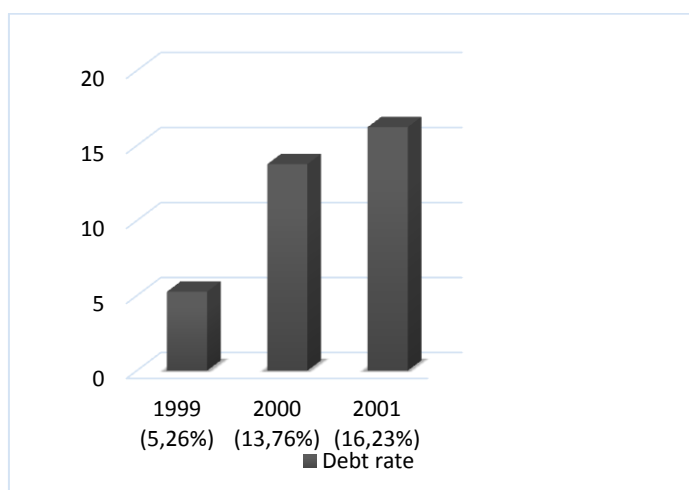

Especially from 2000, the negative trend of Yomo determined financial consequences: as reinforcing the debt in respect of credit institutions and extending the term of payment with suppliers. In 2003 the company's ability to recover a convenient management and the inability to obtain new equity in the company structure, resulted in the further stiffening of the main financing institution of society and this led to block the activity and sales. In 2000, Yomo had to dramatically increase the rate of borrowing but the economic trend was negative even before.

	1996	1997	1998	1999	2000	2001	2002	2003	2004
Net result	124	-3.490	-10.765	8	-11.700	-2.353	-10.921	-76.899	-4.717
Operating result	5.410	2.384	-17.027	2.198	-7.190	-7.319	-8.946	-42.248	-11.168

Table 5. *Evolution of net and operating result from 1996 to 2004 (in thousands euros)*

1996	1997	1998	1999	2000	2001	2002	2003	2004
3,4%	1,46%	-9,89%	1,12%	-3,48%	-3,51%	-4,95%	-22,98%	-37,5%

Table 6. *Return On Sales from 1996 to 2004*

It is clear that the painful economic dysfunction of Yomo, which started in 1998 and became permanent in 2000, is another confirmation of a crisis that has its causes in persisting income gaps. Since 2000 we continuously evidence a lack of support for sales combined with an increase in production costs, both productive and commercial. In 2001 the decrease in the total volumes of sales of the products of Yomo Group, caused a logistic activity superstructure with costs not covered, and in 2002 a further reduction in sales volumes and turnover.

1999	2000	2001
4.595	-4.309	-3.920

Table 7. *EBITDA from 1999 to 2001 (in thousands of euros)*

The productive inefficiency is made evident by the collapse of the gross operating margin and has affected several areas of management: first of all the trading one. The advertising investments, which characterized the action of Yomo, have gradually reduced trade margins, only in 2000, they fell by about 3 percentage points from the previous year. In detail, the costs for advertising and other promotional activities amounted during 2000, to 65.7 billion (old Lira) compared with 54 billion during the previous year.

## 6. YOMO SPA: STRATEGIES FOR THE REDEVELOPMENT AND RELAUNCH

The crisis of Yomo was known as “stiffness crisis” and had commercial and industrial nature features with financial consequences. In an evolving and dynamic market, with rules and structures far from the original ones, Yomo was forced to pay for its mistakes.

This paper highlights the rigidity of structures and the processes that brought “the inability to adapt, quickly and timely, the company in times of crisis or to the market change (Sirleo 2009)”.

The delay and the inability of the management to oppose the economic decline, allowed the control to fall “in the hands of external actors” - funding agencies in this specific case – “often carriers of partial objectives (the debt rescheduling) (Danovi and Quagli 2012)”.

The gradual decline in total sales volumes of Yomo Group's products caused a superstructure of the logistics which involved only Yomo, without revealing other events in the sectoral level. In such situations - declares Sirleo - «the only chance to avoid the crisis is a cost adjustment process (Sirleo 2009)». Yomo started to adjust its costs from 2000.

As mentioned, the operating model of the company was totally inefficient; therefore, in addition to the need to offset the negative net financial position, it was necessary to undertake a reorganization of cost components.

The analysis of consolidation strategies implemented by Yomo management for the revitalization of the company was carried out from the fiscal year closed on the 31 of December 2000. Since 2000, the income statement presents settings which are not directly comparable with those of the previous years. Moreover, it is since 2000 that it was possible to notice a change, not just in the management but also in the whole cultural group, with the renewal of different positions.

Yomo and its subsidiaries modified the structure of the entire supply chain by introducing financial and economic recovery plans. In particular, in order to create opportunities for the development it was decided to generate strategic plans aimed at achieving operational synergies (for example, by centralizing non-specialized activities of its subsidiaries to their attention). From the start of the organizational process, Yomo and its tradition always maintained the leadership.

During 2000, the company maintained the levels of advertising investments chosen in the past and subsequently made new and expensive advertising campaigns. In 2001 new lines of products were planned but were put into effect just in 2002: the increase in advertising and promotional expenditure was one of the points provided for in the business plan pursued.

In order to implement the restructuring plan, in the end of 2002, Yomo became assisted by a consulting firm, but the execution of the Business Plan had disastrous effects on the company's results, with a further increase in costs.

The reorganization also concerned the logistics and distribution system, in the direction of achieving distribution and commercial synergies and seeking economies of scale: with the advent of large retailers, Yomo decided to keep following its own distribution network. Therefore, in 2002 the company decided to entrust the distribution and logistics of the entire Group to Leo Marven System, specialized in refrigerated distribution, which was really necessary for daily consumer goods with reduced shelf life such as yogurt.

During 2002, the reduction of variable costs, the lowering of the break-even point in the industrial and manufacturing costs and the change of managing director were not sufficient for saving the position of the company. In conclusion "the most attractive company, thanks to the power of its brand, had the only chance to agree its output» as stated in Balance sheet at 31.12.2003, Board of statutory auditors' Report.

## 7. CONCLUSIONS

The dramatic evolution of Yomo, main protagonist of the establishment of the yogurt market, is a significant case study, whereas the undoubted initial competitive advantage was gradually eroded by its competitors.

Considering the Italian culture and departing from the description of the evolution of Yomo, there are different interpretative schemes that can be illustrated to answer the initial research questions: What are the most frequent causes of a corporate crisis? Has the external environment any impact on the balance of a company? What function can be due to a disruption?

The main error regards the inability to understand the evolution of the external environment and the competitors supply and demand. There are consequent marketing and strategy mistakes that led to a progressive loss of market share.

The missing element was an adequate information system which could promptly understand mutations and also a capacity to innovate gradually adapting to the changed economic reality.

There were also errors in communication that was weaker than that of the competitors. Therefore there was a mistaken strategy, because the advertising was just focused on one product (yogurt) instead of being differentiated on other dairy products.

Obviously, the progressive decline in revenue and profitability was translated into the requirement for cash flow resulting in lacking report sources/uses that gradually generated financial insolvency. In response to the crisis Yomo took inadequate financial measures, reduced sales support and relied too late on inadequate consultation.

Unfortunately, all the strategies to solve the various problems that were first described were inadequate: the company was assimilated by another company. The Yomo brand continues to exist, but production is carried out by another industry.

The limit of this study is the analysis of a single case. It contributes less to building theory than studies with more cases. In order to have a more detailed analysis, it would be necessary to compare the Yomo case to other Italian company crisis cases. This could help to focus on the frequent errors and causes that happen in different sectors. It may be a future development of this study. The development of corporate crisis cases is useful in the scientific sphere to improve the theoretical framework for crisis management. It also helps managers to prevent crises: they must understand the importance of a proper and balanced production of a productive, economic and financial management. They should also always monitor the environment to prevent imbalances, decline and crises, using an appropriate information system.

Every company crisis has its prerogatives! However it's easy to understand and predict that, in many situations, professional shortcomings and ethical values are the basis of the errors that lead to the closure of business activities.

## REFERENCES

- Cattaneo, M., Cesarini, F., Provasoli, A. and Quatraro, B. (1986), "Le circostanze di crisi nelle recenti esperienze delle imprese industriali italiane", in Canziani, A., *Crisi di impresa e amministrazione controllata*, Giuffrè, Milano, pp. 22 and ss.
- Coda, V. (1977), "Crisi d'impresa e comportamento direzionale", *L'impresa*, No. 2.
- Confalonieri, M. (1995), "Le cause dei dissesti aziendali", *Finanza, marketing e produzione*, Vol. 13 No. 1, pp. 33-49.
- Coombs, W.T. and Holladay, S.J., (2006), "Unpacking the halo effect: reputation and crisis management", *Journal of Communication Management*, Vol. 10 No 2, pp. 123-137.
- Danovi, A. and Quagli, A. (2012), *Crisi aziendali e processi di risanamento*, Ipsoa, Milano.
- De Fiore, F. and Uhlig, H. (2015), "Corporate Debt Structure and the Financial Crisis", *Journal of money credit and banking*, Vol. 47 No 8, pp. 1571-1598.
- De Sarno, M. (1997), *Economia dell'impresa in liquidazione*, Cedam, Padova.
- Djurić, I., Nikolić, Đ, and Vuković, M. (2010), "The role of case study method in management research", *Serbian Journal of Management*, Vol. 5 No. 1, pp. 175-185.
- Fontana, F. and Caroli, M. (2006), *Economia e gestione delle imprese*, McGraw-Hill, Milano.
- Fontana, F. and Caroli, M., (2003), *Strategie competitive di crescita*", in Caroli, M., *Economia e gestione delle imprese*, McGraw-Hill, Milano.
- Gerring, J. (2007), *Case study research: principles and practices*, Cambridge University Press.
- Giesecke, K., Longstaff, F.A., Schaefer, S. and Strebulaev, I.A. (2014), "Macroeconomic effects of corporate default crisis: A long-term perspective", *Journal of Financial Economics*, Vol. 111 No 2, pp. 297-310.

- Golinelli, G. M. (2002), "Valorizzazione delle capacità, rapporti intersistemici e rischio nell'azione di governo", *L'approccio sistemico al governo dell'impresa*, Vol. 3, Cedam, Padova.
- Golinelli, G. M. (2006), *Approccio sistemico al governo dell'impresa*, Vol. 1, Cedam, Padova.
- Golinelli, G. M. (2010), "Verso la scientificazione dell'azione di governo", *L'approccio Sistemico Vitale (Asv) al governo dell'impresa*, Vol. 2, Cedam, Padova.
- Gonzalez, V.M. (2015), "The financial crisis and corporate debt maturity: The role of banking structure", *Journal of corporate finance*, Vol. 35, pp. 310-328.
- Guatri, L. (1986), *Crisi e risanamento delle imprese*, Giuffrè, Milano.
- Guatri, L. (1995) "Turnaround", *Turnaround. Declino, crisi e ritorno al valore*, Egea, Milano.
- Ho, B., Shin, W. and Pang, A. (2016), "Corporate crisis advertising: A framework examining the use and effects of corporate advertising before and after crises", *Journal of Marketing Communications*, pp. 1-15.
- Janssen, C., Sen, S. and Bhattacharya, C. B., (2015), "Corporate crises in the age of corporate social responsibility", *Business horizons*, Vol. 58 No 2, pp. 183-192.
- Kyriakou, M.I. and Iatridis, G. (2015), "Financial crisis, GDP variation and earnings management in Europe", *Research in International Business and Finance*, Vol. 34, pp. 338-354.
- Maylor, H. and Blackmon, K. (2005), *Researching Business and Management*, Palgrave MacMillan, New York.
- Migliaccio, G. (2012), *Squilibri e crisi nelle determinazioni quantitative d'azienda. Il contributo della dottrina italiana*, Angeli, Milano.
- Migliaccio, G. (2015), "Imbalances System Enterprise: Reflections From Italian Doctrine", *Review of international comparative management*, Vol. 16 No. 2, pp. 159-171.
- Moliterni, R. (1999), *Dalla fisiologia alla crisi d'impresa. Diagnosi dei processi degenerativi e misure di prevenzione*, Cedam, Padova, pp. 55 and ss.
- Morel, G. and Chauvin, C. (2016), "Crisis management: What are the methodological challenges for ergonomics?", *Travail Humain*, Vol. 79 No 1, pp. 71-92.
- Myers, M. D. (2013), *Qualitative Research in Business & Management*, Thousand Oaks, London, New Delhi.
- Naumes, W. and Naumes, M.J. (2006), *The art & craft of case writing*, M.E. Sharpe, Armonk.
- Pang, A., Fritz, C. and Cameron G.T. (2006), "Corporate crisis planning: tensions Nos, and contradictions", *Journal of Communication Management*, Vol. 10 No 4, pp. 371-389.
- Paolone, G. (2008), *Gli istituti della cessazione aziendale. Cause originatrici e forme di manifestazione*, Angeli, Milano, pp. 19 and ss.
- Passeri, R. (2011), *Finanza straordinaria per la crisi d'impresa. Il ruolo della gestione straordinaria negli stati patologici d'impresa*, Angeli, Milano, pp. 85 and ss.
- Piciocchi, P. (2005), *Crisi d'impresa e monitoraggio di vitalità. L'approccio sistemico vitale per l'analisi dei processi di crisi*, Giappichelli, Torino.
- Pirson, M. and Turnbull, S. (2015), "The future of corporate governance: Network governance - A lesson from the financial crisis", *Human Systems Management*, Vol. 34 No 1, pp. 81-89.
- Poddighe, F. and Madonna, S. (Eds) (2006), "I modelli di previsione delle crisi aziendali. possibilità e limiti", *I modelli di previsione delle crisi*, Giuffrè, Milano.
- Poddighe, F. and Madonna, S. (Eds) (2006), "Presentazione", *I modelli di previsione delle crisi*, Giuffrè, Milano, pp. 17 and ss.
- Prosperi, S. (2003), *Il governo economico della crisi aziendale*, Giuffrè, Milano.
- Riparbelli, A. (1950), *Il contributo della Ragioneria nell'analisi dei dissesti aziendali*, Vallecchi, Firenze.
- Simola, S. (2014), "Teaching corporate crisis management through business ethics education", *European Journal of Training and Development*, Vol. 38 No 5, pp. 483-503.
- Sirleo, G. (2009), *La crisi d'impresa e i piani di ristrutturazione. Profili economico-aziendali*, Aracne, Roma.
- Sorci, C. (1987), "Gli interventi imprenditoriali esterni nel superamento delle crisi d'impresa", *Different Authors, Crisi d'impresa e strategie di superamento*, Giuffrè, Milano, pp. 59 and ss.
- Tennert, F. (2014), "An attributional analysis of corporate reporting in crisis situations", *Journal of Communication Management*, Vol. 18 No 4, pp. 422 - 435.
- Topper, B. and Lagadec, P. (2013), "Fractal Crises A New Path for Crisis Theory and Management", *Journal of contingencies and crisis management*, Vol. 21 No 1, pp. 4-16.
- Vergara, C. (1987), "Note metodologiche sulla ricerca delle cause delle crisi aziendali", *Different Authors, Crisi d'impresa e strategie di superamento*, Giuffrè, Milano, pp. 10 and ss.
- Vergara, C. (1988), *Disfunzioni e crisi d'impresa. Introduzione ai processi di diagnosi, risanamento e prevenzione*, Giuffrè, Milano, pp. 50 and ss.
- Viganò, E. (1996), *L'economia aziendale e la ragioneria. Evoluzione - Prospettive internazionali*, Cedam, Padova, pp. 204 and ss.



Yin, R. K. (1994), *Case Study Research, Applied Social Research Methods Series, Vol. 5*, Sage, Thousand Oaks.

Yin, R. K. (2009), *Case Study Research: Design and Methods*, Sage, Los Angeles.

Yin, R.K. (2012), *Applications of case study research*, Sage, Thousand Oaks.

## THE QUALITY OF MISSION STATEMENTS IN THE TOURISM INDUSTRY: AN EMPIRICAL ASSESSMENT

**Penco, Lara; Profumo, Giorgia; Scarsi, Roberta**

Department of Economics and Business Studies, DIEC; Centre of Excellence for Integrated Logistics, CIELI; University of Genoa, Genoa, Italy

### ABSTRACT

The present paper tries to advance knowledge on the quality of mission statements in the tourism industry. Despite the importance that strategic management literature have already recognized to a high quality mission statement for formulating, implementing and evaluating firms' strategy, minimal attention has been given to the understanding of the role and quality of mission statements in tourism firms. Mission statements of cruise companies are, in fact, an under-researched topic, considering that a relevant systematic study does not exist in the literature review. The theoretical analysis is completed by an empirical exploration, where we evaluate, using a content analysis technique, the mission statements of 44 cruise lines operating in the standard/ocean market and in the luxury/niche segments. We employ, in particular, three measure of "quality" derived from academic literature: (1) inclusion of stakeholder groups; (2) mention of specific "mission" components (Target/Customers/Segments; Products; Location; Technology; Concern For Survival; Philosophy; Self Concept; Concern For Public Image; Concern For Employees); (3) reference to four goals assigned to mission statement: disclosure of the sense of future direction, definition of control mechanism, decision making guide, and a motivation tool for employees. . The results suggest that the statements fall short of meeting the quality criteria suggested by the strategic management literature and provides useful insights both for academics and practitioners. Variations from the "ideal" and high quality missions are discussed, together with the differences between the two market segments.

*Keywords: Keywords: Mission statement, mission statement quality, stakeholders, goals, cruise companies*

## INTRODUCTION

The cruise industry has been considered as one of the fastest growing segments of the global travel and leisure business since the late 1980s (Cruise Market Watch, 2016; Dowling, 2006; Wild and Dearing, 2000), reaching over 24 million passengers worldwide in 2016 (Figure 1).



Figure 1. Evolution of the world cruise industry (Our elaboration on Cruise Market Watch 2016).

Despite this dramatic expansion in the last three decades, the cruise industry has only recently attracted increasing interest from academics and practitioners (Papathanassis and Beckmann 2011). Most managerial and economic contributions dealing with the cruise industry refer to the tourism and service management perspectives or to the maritime economic approach, and are focused on several research domains, such as the evolution of the supply/demand of the industry (Dowling, 2006), the economic impact on cruise port destinations (Satta et al. 2015, Penco and di Vaio, 2014; Brida and Coletti, 2012; Dweyer and Forsith, 1998) or cruiser behavior (Caber et al., 2016; Duman and Mattila, 2004). Following the results of an in-depth systematic review of the cruise research literature, Papathanassis and Beckmann (2011) stated that extant literature is still limited with respect to the wide managerial and economic implications stemming from cruise activities. In particular, few academic contributions have addressed the topics of strategic management (strategy formulation, implementation and evaluation) and business administration (managerial accounting, human resource planning and development, supply chain management and outsourcing) of cruise companies (Vogel, 2009), despite the increasing competition in the industry has stressed the relevance of this research domain's. The present paper tries therefore to bridge this literature gap, focusing on a strategic management issue: the quality of global cruise line mission statements. The relevance of mission statements as a weapon for effective strategic management decisions is highlighted by previous scholars; in particular, the mission statement is the first step in the process of formulation, implementation and evaluation of business strategy (Pearce and David, 1987) and it helps to

communicate the corporate orientation towards different stakeholder groups. In light of this relevance, in the last decade, several managerial studies provided recommendations in order to determine the quality of mission statements (Bart, 1997).

Despite the substantial attention awarded to this matter, a “minimal attention has been reserved to the role and the quality of mission statement in the strategic management of tourism firms” (Kemp and Dwyer, 2003). Cruise company mission statements remain an under-researched topic, given that, to the best of our knowledge, a systematic study on this topic does not exist.

The cruise industry represents an ideal setting to study such issues. First of all, the rapid growth of the cruise industry has brought a significant impact on society at economic, social and environmental level, both positive (i.e. job creation, revenues created by passenger expenditures, capital expenditure for port terminal and office facilities, development of tourism and transport facilities in cruise destinations) and negative (modification of natural and social environment, noise, traffic, increased waste production). Therefore, the relationship with the stakeholder groups and the ability to communicate with them has become more and more critical. Secondly, as the cruise industry is a segment of the global travel and leisure business, a clear definition of the mission may help to better communicate the components of the service management system (package; the role of the personnel; the corporate philosophy). Thirdly, considering that the increasing turbulent environment has forced cruise operators towards growth strategies, a good mission statement can help such companies to meet their strategic objectives in a long term perspective.

In light of these considerations, the aim of the paper is to explore such issues, answering the following research questions (RQ): i) RQ1: What is the quality of cruise line mission statements based on the criteria provided by the mainstream literature? ii) RQ2: Do cruise companies operating in different market segments differ in the quality of their mission statements?

In seeking to answer the aforementioned research questions, the present study contributes to extant tourism management academic literature exploring the role and quality of mission statements of cruise lines companies. The study has also several managerial implications since it clarifies the role of mission statements in accomplishing the strategic direction of cruise lines.

The remainder of this paper is organized as follows. The first section, by addressing the extant literature on the definition and quality of mission statements, provides the theoretical background useful for the analysis in the cruise industry. The second Section proposes instead the followed content analysis method for analyzing the components of the mission statement of the selected cruise lines. The third Section presents the results of the content analysis. The last Section discusses the results as well as the suggested implications for academics and managers, together with the main limitations of the study and presents indications for further research.

## THE QUALITY OF MISSION STATEMENT: A LITERATURE REVIEW

A mission statement “tells two things about a company: who it is and what it does” (Falsey, 1989, p. 3), responding in this way to two basic questions asked by the stakeholders (Levin, 2000, p.93). Other contributions offer a similar definition (Desmidt et al., 2011; Abrahams, 1995; Bart et al., 2001; Collins and Porras, 1991; David, 1989; Drucker, 1973; Ireland and Hitt, 1992). Mission statements contribute to reveal an organization’s products or services, markets, customers and philosophy (Pearce and David, 1987). Sufi and Lyons (2003) consider that mission statements explain the company’s “reason for being”, helping to understand the goals the company is planning to achieve and how it will attain them. Drucker (1974), instead, states that mission statements are the antecedents of the formulation of strategic objectives, because they help to trace a future orientation.

In light of these definitions, mission statements have been considered as tools for the strategic management process. Drucker (1974) recommends firms to define their missions because the definition of a clear and well-designed mission statement makes the company aware of its strategic planning and the feasibility of its strategic objectives. This is the reason why the mission statement should be defined before strategy formulation. Secondly, the mission statement helps the company to translate its strategic objectives into organizational actions and provides a rationale for allocating resources (David, 2007). Mission statements are useful to assert leadership (Klemm et al., 2001) and to inform employees and the entire organization about the corporate strategic direction in order to connect them in the implementation of the strategic objectives. Moreover, a mission statement is an effective public relation tool for communicating with the different stakeholder groups (Falsey, 1989).

Considering all these purposes, Pearce and David (1987) state that high performing firms have a more comprehensive mission than low performing firms. Moreover, previous scholars consider that the quality of a mission statement is generally related to the wealth of its content and the presence of different defined topics (Fitzgerald and Cunningham, 2016, Bartkus et al., 2004; 2006).

In order to evaluate a well-designed mission statement, three criteria have already been used in literature; the first useful method is based on the stakeholder theory (Freeman et al., 2004). While the company has been regarded as an economic entity with the goal of profit maximization and satisfaction of the interests of company owners, Freeman (1994) considers that business objectives should be consistent with the interests of other stakeholder groups. Stakeholders includes both internal stakeholders, i.e. shareholders, managers and employees, as well as external stakeholders, i.e. customers, suppliers, local community, environment. Following this theory, firms are expected to include their relationships with stakeholders in their mission statement (Abrahams, 1995; Amato and Amato, 2002; 2000; Collins and Porras, 1991; Klemm et al., 1991; Williams, 2008). Ireland and Hitt (1992) state that mission statements can help firms to communicate a positive image to stakeholder groups.

Moreover, it is possible to identify the importance of each stakeholder group in mission statements and the firm's willingness to satisfy their specific interests (Bartkus and Glassman, 2008). Bart (1997) analyzes the mission statements of 88 firms in order to detect the number and the typology of stakeholders identified. He found that the primary stakeholders are "customers", as they are included in most of the missions (78%), followed by employees (52%), investors (41%), society (33%), and suppliers (21%). Leuthesser and Kohli (1997) confirmed these results: the analysis of 63 mission statements reveals that 91% of the companies mentioned customers; employees and shareholders are present respectively in 67% and 60% of the total sample. In both the studies, the quality of the mission statement is examined in terms of the presence of specific stakeholder groups, such as customers, employees, investors, suppliers, and society (local community, environment).

The second evaluation method of a mission's statement is related to the attitude of such statement to provide vis-à-vis information about the business "in itself" (i.e. target segments, product, market, philosophy). Pearce and David (1987) consider eight key components of mission statements that have been later extended to nine. An ideal "mission statement" should provide information about a company's customers or clients, employees, products or services, markets, technology, self-concept, desired public image, philosophy, and strategies for growth and survival (David, 1989, 2007). These nine components serve as a tool for evaluating and writing a good mission statement. Following this idea, other contributions have sought to rename, enlarge, narrow, or redefine these components without changing the main meaning (Amato and Amato, 2002; Bart and Baetz, 1998). Typical words or expressions are mentioned in the mission statements: Dermol (2012), for example, identified the most common words used in the mission statements. The last method for evaluating the quality of mission statements is based on the main goals the mission helps to pursue. Considering the literature on the role of mission statements in the strategic management process, Bartkus et al. (2004; 2006) identify the most cited goals. Mission statements should communicate the firm's direction to the different groups of stakeholders (David, 2001). Another goal of the mission statement is to provide the correct definition of the structure of the strategic business area and organization (e.g. description of clients, product, technology) in order to prevent managerial actions that are not coherent with these components. Consistently with Drucker (1974), who considers the mission statement as an antecedent of the definition of the entire strategic process (strategic formulation, implementation, evaluation), a third goal is to guide new or non-routine decisions (i.e. new market, new philosophy, new strategy). Moreover, on the basis of Bartkus et al. (2000) who define the mission statement as a communication tool, mission statements may help to motivate and inspire employees in order to accomplish corporate strategic development. As a minimal attention has been paid to the role of mission statements in the strategic management of tourism companies, and there are not studies focused on the cruise operators,

it is useful to explore the extent of the content of the mission statements in such type of companies. The abovementioned three methods will be employed in order to measure the quality of the mission statements of cruise lines companies. Moreover, it could be interesting to observe the differences in the cruise line companies operating in separate market segments

## **METHODOLOGY AND DATA COLLECTION**

The sample was obtained by selecting the most important cruise lines from the Cruise Lines International Association (CLIA), the world's largest cruise industry trade association, which represents 60 cruise lines. Mission statements were published by 44 cruise companies. Considering that in the cruise industry several cruising markets (bounded geographically and by limitations/substitutability in both supply and demand) coexist (Bull, 1996), the cruise lines belonging to the sample may be classified as: a) standard/ocean market companies (n=15): they offer 7-10 days ocean cruises on large vessels built for mass market cruising and are usually large companies (e.g. Carnival, Royal Caribbean, Costa); b) niche/luxury companies (n=29): they produce river, canal and lake cruises, special interest cruises, such as sailing, education, exploration or luxury cruises, defined as a cruise trip that costs more than \$350 per day and serves upper-class travellers (De la Vina and Ford, 2001). The latter market structure is typically fragmented.

Content analysis technique is used to analyze the quality of mission statements expressed by cruise lines. Content analysis is considered a systematic, objective and quantitative technique for obtaining reliable and valid information from narratives (Krippendorff, 1980; Neuendorf 2002). It is a methodology applied by scholars in the study of company disclosure and corporate communication (Boesso and Kumar, 2007). Content analysis is commonly used in order to analyze mission statements (Kemp and Dwyer, 2003; Bartkus et al., 2004; 2006; Stallworth Williams, 2008; Dermol, 2012).

The mission statements of each cruise company were obtained by accessing official corporate websites. We identified only 44 companies out of 60 that explicitly enunciate their mission statement in the following sections of their website: "Mission"; "Value"; "About us" "Company philosophy". In this study, "mission statement" has been broadly defined, including sentences that describe company goals, purpose, products, markets, culture, philosophy and values. Consistent with Bartkus et al. (2004; 2006), mission statement quality has been assessed by three different measures. The first measure ("Stakeholder groups") is attributed to the main stakeholder groups mentioned by the cruise company. Cruise line stakeholders can be categorized into the following groups: Customers (Cruisers); Shareholders and Financial community; Employees and Labor Unions and Managers; Society (local community, societal interest groups, environment); Suppliers (i.e. local port agents; port service providers; tour operators: shore excursion providers; ground transportation firms; air

transportation/airports; etc.). The second measure (“Components”) derives from the specific components of mission statements defined by Pearce and David (1987): Target/Customers/Segments; Products; Location/Geography; Technology (ships); Concern for Survival; Philosophy; Self Concept; Concern for Public Image; Concern for Employees. The third measure (“Goals”) is consistent with Bartkus et al. (2000) and includes four possible goals pursued by a mission statement: “Sense of direction”; “Control mechanism”; “Non-routine decisions”; “Motivation”. Each mission statement of the selected 44 cruise companies was assessed using the topics inserted in the categories “Stakeholder groups”, “Components” and “Goals”. Three researchers independently recorded whether or not each mission statement is consisting with the topics in the three defined categories. A “1” is assigned if the topic is present, while 0 is assigned if the topic is not present in the mission statement. The results of the content analysis were then compared and doubts were discussed. In order to avoid bias, dictionary meanings and synonyms for the classification of each mission statement were defined “ex ante”. “Customers”, “clients”, “guests”, “cruisers”, “passengers” were employed in order to evaluate the presence of customers in the mission statement. The terms “Employees”, “Crew”, “Members”, “Workforce” determine, instead, the presence of the stakeholder group “Employees”. The operationalization of both the criteria “Components” and “Goals” was more difficult considering that they refer to a broader meaning and can be subjective. In order to avoid bias, for the definition of each topic belonging to “Components”, we closely followed Pearce and David (1987) study. The operationalization of “Goals” followed Bartkus et al. (2004; 2006). In this way, the sense of direction matches the disclosure about the company’s future orientation. When the mission statement pursues the “control mechanism”, it includes at least two of the most significant features of the business area definition (i.e.: industry, customer/segment, geographic scope, technology, distinctive competence). Non-routine decisions concern the definition of values and philosophy, which are useful to meet new strategic objectives. The presence of an evident “competitive or a societal motivational message” could refer to motivation and inspiration for employees.

## MAIN RESULTS AND DISCUSSION

The findings of the content analysis are reported in the following tables. Table 1 shows the frequency with which each stakeholder group is mentioned (Measure 1). The total sample (n=44) quotes on average 1.73 stakeholders. For luxury/niche cruise lines the average is slightly higher (1.79).

Number of Stakeholders in mission statement	Name of cruise companies	Total sample (44 firms)	%	Luxury/Niche (29 firms)	%	Standard/Ocean (15 firms)	%
0	America Cruise Line; Disney; Holland America Line; Hurtigruten;	7	15.9%	3	10.0%	4	28.6%



	Nicko Cruises; Ponant; Swan Cruises						
1	Alaskan Dream Cruise; Amadeus Cruises/Lufner Cruises; Amawaterways Cruise; Azamara; Celestyal Cruises; Hpag-Lloyd; Mariposa Cruise; Msc; Oceania Cruises; Princess Cruise; Pullman Tour; Seabourn; Seadream Yacht Cruise; Silversea; The River Cruise Line; Viking Line; Voyages To Antiquity	17	38.6%	13	43.3%	4	28.6%
2	Calypso Cruises; Capitan Cook Cruises; Costa Crociere; Lindblad Expeditions-Nationalgeographic; Royal Carribbean; Uncruise Adventure; Uniworld Cruise; Windstar Cruise	8	18.2%	6	20.0%	2	14.3%
3	Aida Cruises; Antartic Shipping; Carnival; Celebrity Cruise; Paul Gauguin Cruises; Regent Seven Seas; Transocean	7	15.9%	4	13.3%	3	21.4%
4	Norwegian Cruise Line; Polar Cruise; Windermere Lake Cruise;	3	6.8%	2	6.7%	1	7.1%
5	Crystal Cruise; Star Cruises	2	4.5%	1	3.3%	1	7.1%
Total		44	100.0%	29	96.7%	15	107.1%
Average number of stakeholders mentioned		1,73	n.a.	1.72	n.a.	1.73	n.a.

Table 1. Number of stakeholders included in the mission statement

Table 2 provides, instead, information on the number of mission statements in which each stakeholder group is mentioned. The most cited stakeholders are Customers (84%), followed by Employees (34%) and Society (29%).

Stakeholders	Number of mission statements					
	Total sample (44 firms)	%	Luxury/Niche (29 firms)	%	Standard/Ocean (15 firms)	%
Customer/Cruisers	37	84.1%	26	86.7%	11	78.6%
Shareholders & Financial community	4	9.1%	2	6.7%	2	14.3%
Employees & Labor Unions & Managers	15	34.1%	9	30.0%	6	42.9%
Society: Local community, societal groups of interest, environment	13	29.5%	10	33.3%	3	21.4%
Suppliers (local port agents; port service providers; tour operators, etc.)	7	15.9%	3	10.0%	4	28.6%
Total number of Stakeholders	76	n.a.	50	n.a.	26	n.a.

Table 2. Number of mission statements that include each stakeholders

The predominance of customers is consistent with strategic management literature, considering that a major reason for developing a business mission is to attract customers (David, 2001). Some examples

are: *"We make all efforts to exceed our customers' expectations"* (Royal Caribbean); *"Our objective is to be recognized by our customers"* (P&O Cruises). Luxury/niche companies are more committed to customers (26 companies out of 29) than the Standard/Ocean companies, because their mission statements reflect the willingness to provide exceptional value for customers: *"To put our customers at the heart of everything we do"* (The River Cruise Line); *"Our objective is to provide unsurpassed luxury and service to our guests"* (Paul Gauguin Cruises).

Employees are also frequently mentioned both by Luxury/Niche companies (30%) and by Standard/Ocean companies (42.9%). Different orientation emerged with regard to Society and Suppliers. Society is quoted by 10 of 29 luxury/niche cruise lines (33.3%) and by only 3 of 15 standard/ocean companies (21.4%). Luxury/niche cruise lines tend to operate in unique marine environments (it is the case of exploration cruises) or in river/lake boundaries and offer exclusive destinations (e.g. private island). Thus, the respect for the environment, biodiversity and local community become crucial and this commitment is made explicit in the mission statements. Some examples are: *"We strive to make a difference every day and are dedicated to seeking out eco-friendly practices that are environmentally, socially, and economically sustainable"* (Paul Gauguin Cruise); *"To enable economic, social and environmental advancement in sustainable tourism"* (Amadeus Cruises). On the other hand, the results highlight the limited reference to shareholders and the financial community (9.1%). Considering that the Standard/Ocean companies are typically large-sized firms (often listed), they tend to disclose more about shareholders (14.3%). Moreover, suppliers are not mentioned by the vast majority of firms and this result is consistent with previous studies (Bart, 1997; Leuthesser and Kohli, 1997). For the standard/ocean companies, the frequency is higher (28.6%) because the supply chain is more complex considering the high volume of goods and services necessary to the cruise package.

Regarding the number of components included in the mission statements (Measure 2), the total sample show an average of 3.52 of the nine components (Table 3).

Number of Components in mission statement	Name of cruise companies	Total sample (44 firms)		Luxury/Niche (29 firms)		Standard/Ocean (15 firms)	
			%		%		%
0	None	0	0.0%	0	0.0%	0	0.0%
1	Nicko Cruises; Silversea	2	4.5%	2	6.7%	0	0.0%

2	Amawaterways Cruise; America Cruise Line; Holland America Line; Hurtigruten; Ponant; Pullman Tour; Regent Seven Seas; Seadream Yacht Cruise; The River Cruise Line; Uncruise Adventure; Uniworld Cruise	11	25.0%	8	26.7%	3	10.0%
3	Aida Cruises; Alaskan Dream Cruise; Azamara; Celebrity Cruise; Lindblad Expeditions-Nationalgeographic; Msc; Princess Cruise; Seabourn; Swan Cruises; Viking Line; Windstar Cruise	11	25.0%	5	16.7%	6	20.0%
4	Calypso Cruises; Crystal Cruise; Disney; Hpag-Lloyd; Mariposa Cruise; Oceania Cruises; Royal Caribbean; Voyages To Antiquity; Windermere Lake Cruise	9	20.5%	7	23.3%	2	6.7%
5	Amadeus Cruises/Lufner Cruises; Capitan Cook Cruises; Celestyal Cruises; Costa Crociere; Star Cruises; Transocean	6	13.6%	4	13.3%	2	6.7%
6	Antartic Shipping; Carnival; Norwegian Cruise Line; Polar Cruise	4	9.1%	2	6.7%	2	6.7%
7	None	0	0.0%	0	0.0%	0	0.0%
8	Paul Gauguin Cruises	1	2.3%	1	3.3%	0	0.0%
9	None	0	0.0%	0	0.0%	0	0.0%
Total		44	100.0%	29	96.7%	15	50.0%
Average number of components mentioned		3,52	n.a.	3,52	n.a.	3,53	n.a.

Table 3. Number of components included in the mission statement

The majority of cruise lines include two (25%), or three (25%) or four components (20%). None of them disclose all nine components (0%). As seen in Table 4, most cruise lines quote Customers/target (70%) but in their mission statements, the term customers is often vague and “all-inclusive” (e.g. guest).

Components	Number of mission statements					
	Total sample (44 firms)	%	Luxury/Niche (29 firms)	%	Standard/Ocean (15 firms)	%
Target/Customers/Segments	31	70.5%	20	66.7%	11	78.6%
Products	19	43.2%	11	36.7%	8	57.1%

Location	13	29.5%	11	36.7%	2	14.3%
Technology (ships)	12	27.3%	8	26.7%	4	28.6%
Concern For Survival	9	20.5%	6	20.0%	3	21.4%
Philosophy	30	68.2%	19	63.3%	11	78.6%
Self Concept	16	36.4%	11	36.7%	5	35.7%
Concern For Public Image	9	20.5%	6	20.0%	3	21.4%
Concern For Employees	16	36.4%	10	33.3%	6	42.9%
Total number of Elements	155	n.a.	102	n.a	53	n.a.

Table 4. Number of mission statements that include each component

The typology of “product” contributes to distinguish each company’s style and segments. Moreover, it is relevant for the effectiveness of strategy formulation implementation and evaluation (Kemp and Dweyer, 2003). Despite the relevance of this topic, only 19 cruise companies out of 44 include the definition of their products in their mission statements: Some examples are: “...we create once-in-a-lifetime experiences” (Holland American Line); “This set of behaviour constitutes the “Costa Touch”, a distinctive style which characterizes us and should be applied by all those who have a service relationship with Guests”; “...we provide a wide range of vacation choices that appeal to any taste, interest, lifestyle, or budget” (Carnival Cruise). Regarding the luxury/niche cruise lines, examples are: “...we provide the most authentic and enriching travel experiences, providing unsurpassed luxury” (Paul Gauguin); “we are working to develop and promote the cruise industry” (Cruise Gateway); “AmaWaterways’ mission is to deliver an exceptional vacation experience with everlasting memories onboard their elegant vessel” (AmaWaterways).

The total sample tends to predominantly disclose “philosophy” (68%). Philosophy includes the values, “credo” and ethical principles that express organizational culture. Corporate philosophy is evaluated as crucial in strategic management (Kemp and Dweyer, 2000), especially in the service management approach (Normann, 1984). Moreover, the pressure from Corporate Social Responsibility (CSR) policies holds that social values should be communicated. In the cruise industry, philosophy is connected to values such as excellence, personal services, belief in the importance of people (guests and crew). Some examples are: “Our mission statement is to be recognized and respected” (Regent); “Our objective is to deliver the highest levels of quality and service” (Mariposa); “...to inspire people to explore and care about the planet through expedition travel” (National Geographic); “...we consistently deliver exceptional Seabourn Moments” (Seabourn). For the standard/ocean companies : “Con MSC Crociere il viaggio e la nave sono la vera meta” (MSC); “Through excellence we create once-in-a-lifetime experiences, every time” (Holland American Line). Interestingly, only 20.5% of the cruise lines include “Concern for survival”, i.e the concept of profits, market growth, economic objectives in their mission statement. This result is consistent with the limited reference to shareholders and the financial community highlighted previously.

Table 5 investigates the quality of mission statements in terms of communicating the four generally recommended objectives (Measure 3).

Number of Goals in mission statement	Name of cruise companies	Total sample (44 firms)	%	Luxury/Niche (29firms)	%	Standard/Ocean (15 firms)	%
0	None	0	0.0%	0	0.0%	0	0.0%
1	Amadeus Cruises/Lufner Cruises; America Cruise Line; Holland America Line; Hurtigruten; Lindblad Expeditions-Nationalgeographic; Mariposa Cruise; Msc; Nicko Cruises; Oceania Cruises; Ponant; Pullman Tour; Star Cruises; The River Cruise Line; Viking Line	14	31.8%	9	30.0%	5	35.7%
2	Alaskan Dream Cruise; Amawaterways Cruise; Azamara; Calypso Cruises; Celestyal Cruises; Disney; Hpag-Lloyd; Norwegian Cruise Line; Princess Cruise; Regent Seven Seas; Seabourn; Seadream Yacht Cruise; Silversea; Uncruise Adventure; Uniworld Cruise; Voyages To Antiquity	16	36.4%	12	40.0%	4	28.6%
3	Aida Cruises; Carnival; Celebrity Cruise; Paul Gauguin Cruises; Polar Cruise; Swan Cruises; Transocean; Windermere Lake Cruise; Windstar Cruise	9	20.5%	5	16.7%	4	28.6%
4	Antartic Shipping; Capitan Cook Cruises; Costa Crociere; Crystal Cruise; Royal Caribbean	5	11.4%	3	10.0%	2	14.3%
Total		44	100.0%	29	96.7%	15	107.1%
Average number of goals mentioned		2,11	n.a.	2.14	n.a.	2.07	n.a.

Table 5. Number of goals included in the mission statement

The mission statements of the cruise lines included in the sample present on average 2.11 goals. The results are similar for the two groups. Only five cruise companies (11%) disclose all four goals. Regarding the luxury/niche cruise lines, examples are: "...we provide the most authentic and enriching travel experiences, providing unsurpassed luxury" (Paul Gauguin); "we are working to develop and promote the cruise industry" (Cruise Gateway); "AmaWaterways' mission is to deliver an exceptional vacation experience with everlasting memories onboard their elegant vessel" (AmaWaterways). As reported in Table 6, the results indicate that cruise companies primarily communicate the control mechanism (70%) and the firm's direction (59.1%). Luxury-Niche companies have a disclosure of the control mechanism higher than average (80%): the elements of the cruise packages and the core competences tend to be defined more accurately because they contribute to communicate the differentiation strategy and the segment's boundaries.

Goals	Number of mission statements					
	Total sample	%	Luxury/Niche (29 firms)	%	Standard/Ocean (15)	%

	(44 firms)				firms)	
Sense of direction	26	59.1%	17	56.7%	9	64.3%
Control mechanism	31	70.5%	24	80.0%	7	50.0%
Non-routine decisions	16	36.4%	9	30.0%	7	50.0%
Motivation	20	45.5%	12	40.0%	8	57.1%
Total number of goals	93	n.a.	62	n.a.	31	n.a.

Table 6. Number of mission statements that include each goal

In sum, Figure 1 visualizes the results of the content analysis according to the three methods used to determine the quality of mission statements.

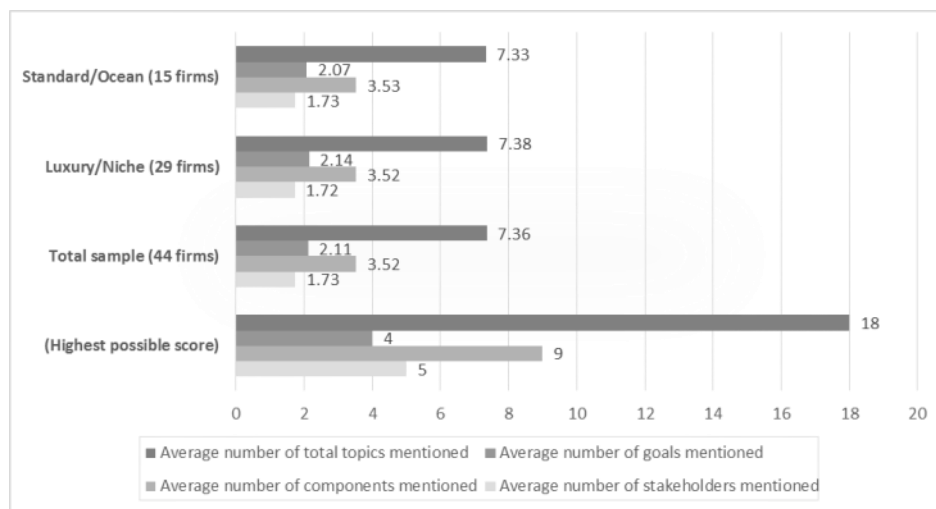

Figure 1. The comparison of the evaluation methods

The number of the total topics disclosed is 7.36. The cruise lines that present the richest cruise mission statements in terms of number of topics mentioned are: Paul Gaugain (N=14); Polar Cruise (N=13); Norwegian Cruise Lines (N=11); Star Cruises (N=11). By contrast, Nicko Cruises (N=2), Ponant and Pullman Tour (N=3), Silversea and The River Cruise Line (N:4) have the lowest scores. To summarise, mission statements may differ a lot in terms of the number of mentioned topics. The two groups do not reveal significant differences in terms of average number of topics. Considering the sum of the three measures, these results show that the studied firms do not meet the criterion for success, considering the low rate of disclosure of the recommended topics.

## CONCLUSION

The study presents the results of an explorative analysis carried out on the mission statements of 44 cruise lines operating in the luxury/niche market (group 1) and in the standard/ocean market (group 2).

We apply the content analysis method employing three different measures of “quality” derived from the academic literature. The results reveal that cruise lines do not disclose a wide range of topics in their mission statements since the average number of mentioned topics is 7,36 (the highest possible score is 18). No significant differences emerged between the two groups of firms. Empirical evidence suggests that Customers (84%), Employees (34%) and Society (29%) are the most cited stakeholders in the scrutinised mission statements. The mission statements provide also information about Customers/Target/Segments (70%), Product (43%) and Philosophy (68%); cruise lines, therefore, tend to “use” mission statements in order to clarify their strategic business area and their corporate values and “credo”. The scrutinized mission statements perform the task of communicating “control mechanism” (70%) and “firm direction” (59%).

The paper provides insights useful for both scholars and practitioners. As concern academic implications, the manuscript develops extant cruise literature on strategic management. Moreover, from a methodological perspective, the paper carries out a broad content analysis on the mission statements of cruise lines and it helps to identify the most relevant topics in their strategy formulation and in their communication policy toward the stakeholders groups. The study has also several managerial implications since it clarifies the role of mission statements in accomplishing the strategic direction of the cruise lines. Cruise managers, therefore, are invited to exploit these preliminary results for bridging the gap between the “ideal” mission and the designed mission. Despite its contribution to extant cruise literature on mission statement, the manuscript still suffers some inherent limitations. Firstly, the results of the content analysis severely depends upon the judgment expressed by the researchers and they could be vulnerable to subjectivity. Secondly, the adoption of content analysis provides information only on the presence/absence of each topic, without evidencing if the statements include the topic in vague or in specific terms. In order to make findings more relevant, further researches are expected. Further studies should study the impact of the quality of mission statements on cruise lines’ competitiveness (e.g. market share) and on financial/organisational performance. Moreover, it should be interesting to evaluate the role of each topic on the strategy formulation. Finally, cultural dimensions and firm size, for example, are expected to be valuable determinants in shaping cruise companies’ attitude towards a high quality of the mission statement and specific topics.

## REFERENCES

Abrahams, J. (1995), *The mission statement book: 301 corporate mission statements from America’s top companies*, Ten Speed Press, Berkeley, CA.

- Amato, C. H., and Amato, L. H. (2002), "Corporate commitment to quality of life: Evidence from company mission statements", *Journal of Marketing Theory and Practice*, Vol. 10 No 4, pp. 69-87.
- Bart, C. K., and Baetz, M. C. (1998), "The relationship between mission statements and firm performance: An exploratory study", *Journal of Management Studies*, Vol. 35 No 6, pp. 823-853.
- Bart, C. K., Bontis, N., and Taggar, S. (2001), "A model of the impact of mission statements on firm performance", *Management Decision*, Vol. 39 No 1, pp. 19-35.
- Bart, K. (1997), "Sex, Lies and Mission Statements", *Business Horizons*, pp. 9-18, November-December 1997. Available at SSRN: <https://ssrn.com/abstract=716542>
- Bartkus, B. R., and Glassman, M. (2008), "Do firms practice what they preach? The relationship between mission statements and stakeholder management", *Journal of business ethics*, Vol. 83 No 2, pp. 207-216.
- Bartkus, B. R., Glassman, M., and McAfee, R. B. (2004), "A comparison of the quality of European, Japanese and US mission statements": A content analysis", *European Management Journal*, Vol. 22 No 4, pp. 393-401.
- Bartkus, B., Glassman, M., and McAfee, B. (2006), "Mission statement quality and financial performance", *European Management Journal*, Vol. 24 No 1, pp. 86-94.
- Bartkus, B., Glassman, M., and McAfee, R. B. (2000), "Mission statements: Are they smoke and mirrors?" *Business Horizons*, Vol. 43 No 6, pp. 23-29.
- Brida, J. G., and Coletti, P. (2012); "Tourists' Intention of Returning to a Visited Destination: Cruise Ship Passengers in Cartagena de Indias, Colombia", *Tourism in Marine Environments*, Vol. 8 No 3, pp. 127-143.
- Bull, A. (1996), "The economics of cruising: An application to the short ocean cruise market", *Journal of Tourism Studies*, Vol. 7 No 2, pp. 28-34.
- Caber, M., Albayrak, T., and Ünal, C. (2016), "Motivation-based Segmentation of Cruise Tourists: A Case Study on International Cruise Tourists Visiting Kuşadası, Turkey", *Tourism in Marine Environments*, Vol. 11 No 2-3, pp. 101-108.
- Collins, J. C., and Porras, J. I. (1991), "Organizational vision and visionary organizations", *California Management Review*, Vol. 34 No 1, pp. 30-52.
- Cruise Market Watch, 2016, *Cruise Market Watch Statistics*, <http://www.cruisemarketwatch.com/growth/>, Date of access: 6/1/2017.
- David, F. R. (1989), "How companies define their mission", *Long Range Planning*, Vol. 22 No 1, pp. 90-97.
- David, F. R. (2007), *Strategic management: Concepts and cases* (11th ed.), Prentice Hall, Englewood Cliffs, NJ.
- De La Viña, L., and Ford, J. (2001), "Logistic regression analysis of cruise vacation market potential: demographic and trip attribute perception factors", *Journal of Travel Research*, Vol. 39 No 4, pp. 406-410.
- Dermol, V. (2012), "Relationship between mission statement and company performance", *Annals of the Alexandru Ioan Cuza University-Economics*, Vol. 59 No 1, pp. 321-336.
- Desmidt, S., Prinzie, A., and Decramer, A. (2011), "Looking for the value of mission statements: a meta-analysis of 20 years of research", *Management Decision*, Vol. 49 No 3, pp. 468-483.
- Dowling R.K., ed. (2006), *Cruise Ship Tourism*, CABI, Wallingford, UK.
- Drucker, P. F. (1973), *Management: Tasks, responsibilities, and practices*, Harper and Row, New York.
- Duman, T., and Mattila, A. S. (2005), "The role of affective factors on perceived cruise vacation value", *Tourism Management*, Vol. 26 No 3, pp. 311-323.
- Dwyer, L., and Forsyth, P. (1998), "Economic significance of cruise tourism", *Annals of Tourism Research*, Vol. 25 No 2, pp. 393-415.
- Falsey, T. A. (1989), *Corporate philosophies and mission statements: A survey and guide for corporate communicators and management*, Greenwood, Westport, CT.
- Fitzgerald, C., and Cunningham, J. A. (2016), "Inside the university technology transfer office: mission statement analysis", *The Journal of Technology Transfer*, Vol. 41 No 5, pp. 1235-1246.
- Freeman, R. E. (1994), "The politics of stakeholder theory: Some future directions", *Business ethics quarterly*, Vol. 4 No 4, pp. 409-421.
- Freeman, R. E., Wicks, A. C., and Parmar, B. (2004), "Stakeholder theory and the corporate objective revisited", *Organization science*, Vol. 15 No 3, pp. 364-369.
- Ireland, R. D., and Hitt, M. A. (1992), "Mission statements: Importance, challenge, and recommendations for development", *Business Horizons*, Vol. 35 No 3, pp. 34-42.
- Kemp, S., and Dwyer, L. (2003), "Mission statements of international airlines: a content analysis", *Tourism Management*, Vol. 24 No 6, pp. 635-653.
- Klemm, M., Sanderson, S., and Luffman, G. (1991), "Mission statements: Selling corporate values to employees", *Long Range Planning*, Vol. 24 No 3, pp. 73-78.
- Krippendorff, K. (1980), *Content analysis*, Sage Publications, Beverly Hills. California.



- Leuthesser, L., and Kohli, C. (1997), "Corporate identity: The role of mission statements", *Business Horizons*, Vol. 40 No 3, pp. 59-66.
- Levin, I.M. (2000), "Vision revisited", *The Journal of Applied Behavioral Science*, Vol. 36 No 1, pp. 91-107.
- Neuendorf, K. A. (2002), *The content analysis guidebook*, Sage Publications.
- Papathanassis, A., and Beckmann, I. (2011), "Assessing the 'poverty of cruise theory hypothesis'", *Annals of Tourism Research*, Vol. 59 No 1, pp., 153-174.
- Pearce, J. A., and David, F. (1987), "Corporate mission statements: The bottom line", *Academy of Management Executive*, Vol. 1 No 2, pp. 109-116.
- Penco, L., and Di Vaio, A. (2014), "Monetary and non-monetary value creation in cruise port destinations: an empirical assessment", *Maritime Policy and Management*, Vol. 41 No 5, pp. 501-513.
- Satta, G., Parola, F., Penco, L., and Persico, L. (2015), "Word of mouth and satisfaction in cruise port destinations", *Tourism Geographies*, Vol. 17 No 1, pp. 54-75.
- Sufi, T., and Lyons, H. (2003), *Mission statements exposed*, *International Journal of Contemporary Hospitality Management*, Vol. 15 No 5, pp. 255-262.
- Vogel, M. P. (2009), "The economics of US cruise companies' European brand strategies", *Tourism Economics*, Vol. 15 No 4, pp. 735-751.
- Williams, L. S. (2008), "The mission statement. A corporate reporting tool with a past, present, and future", *Journal of business communication*, Vol. 45 No 2, pp. 94-119.

## GREEN MARKETING AND ITS PERCEPTION BY YOUNG CONSUMERS OF THE "GENERATION Y"

Průša, Přemysl; Sadílek, Tomáš

Department of Retailing and Commercial Communication, Faculty of International Relations, University of Economics in Prague, Prague, Czech Republic

### ABSTRACT

The aim of this paper is to reveal the perception of Green marketing by young consumers from the "Generation Y", as this generation has already grown into the level of mature consumers and it is still expecting a very long consumer life. The current "Generation Y" builds potentially the biggest customer base in the long term, therefore it is very interesting to see and understand their attitudes towards the "Green marketing" concept as well as the "CSR" concept. As the main method, a questionnaire survey has been used, and the respondents were mainly the students of the University of Economics in Prague, including the international (exchange) students from the whole world, staying in Prague during the execution of the questionnaire survey. The concept of "Green marketing" as well as the methodology and results of the study are described in the following text. The study has been performed twice in two successive years (namely in 2015 and 2016) to see possible changes in the attitudes of consumers.

*Keywords: CSR, Generation Y, Green Marketing.*

### INTRODUCTION

The global economy is facing severe challenges nowadays. Most of them are even called as "global problems", such as the increasing number of the whole population, which goes hand in hand with the increasing industrial production, pollution of the environment and the global warming. Various studies suggest that the current economic development as well as the lifestyles of most people living on the earth are not sustainable anymore. Most companies as well as civic societies in the developed countries are already aware of this situation, trying to reverse the impacts of it. Probably the most important concept and initiative which has emerged from this adverse situation is the concept of Corporate Social Responsibility (CSR). An integral part of this concept is the so called Green marketing, which is defined further in this paper.

### CSR CONCEPT AND GREEN MARKETING

Green marketing can be perceived as an integral part of Corporate Social Responsibility. The term and concept of CSR (Corporate Social Responsibility) have been discussed and developed since the 70's of the last century (Průša, 2007). Since that time until now, various definitions of CSR have been created and the CSR concept has become an integral part of most companies operating in the developed countries, as well as in transnational and multinational companies in the whole world. From the plethora definitions of CSR, we can mention the following:

- (1) CSR is a voluntary integration of social and environmental perspectives into the daily company's operations and interactions with company's stakeholders (European union, The green book 2001);
- (2) CSR is the business philosophy, which complies or goes well beyond the ethical, legal, commercial and social expectations (Non-governmental organization -Business for social responsibility);
- (3) CSR is a continuous commitment of companies to behave ethically and to contribute to the economic growth and to struggle to increase the life quality of the employees and their families as well as the local community and the entire society at the same time (World business council for Sustainable development, 1997).

Most authors divide the topics, which CSR should cover into three pillars/areas: the economic area, the social area and the environmental area (Trnková, 2004). Some approaches to CSR even add the fourth and fifth area, such as stakeholders and voluntarism (Mokrejšová, 2016).

Green marketing is a part of the concept of CSR (Supeková, 2010). Ecological marketing was introduced as a concept already in 1975 when it held the first seminar organized by the American Marketing Association (AMA) (Supeková, 2015). It is understood as a full orientation of marketing and business concepts to ecological aspects (Nízka, 2007).

According to Castenow (1993) the concept of green marketing should cover mainly the following areas: Care about clean air, soil and water, nature conservancy before devastation, rational use of natural resources with an emphasis on recycling, popularization of ecological orientation and a healthy lifestyle, and realization of the interconnection of the environment, hunger and overpopulation.

"The concept of ecological marketing can be named as environmental marketing, green marketing and sustainable marketing. The aim is to carry out a business activity to prevent environmental pollution, or reduce the load on the environment and to preserve the natural living conditions for people, animals, plants or, at least, change the conditions to improve their lives" (Supeková, 2015).

Zhang (1999) offers two meanings of green marketing – the narrower one is constraint mainly to production of green, ecologically friendly products, whereas to broader meaning is referred to the whole company strategy as to protect the environment and make efficient use of natural resources in the long term. According to Dubey (2008) green marketing should include all activities aimed at satisfying human needs and desires with minimal impact on the natural environment.

According to Supeková (2015) the green marketing concept should be aligned with the whole marketing mix.

## **AIMS AND METHODOLOGY OF THE STUDY**

This study is aimed at identifying the prevalent attitudes and perception of green marketing and green products of the so called generation Y.

The generation Y for our purposed can defined as all people who were born between the years 1980 and 1995 (Horovitz, 2012), whereas this study concentrates on the population of students at their early 20s, which means the youngest part of the generation Y will be considered.

To find out the attitudes and perception of generation Y towards green marketing a questionnaire survey was used. The sample consisted of 100 students of the University of Economics in Prague, and the survey has been performed twice, in two waves, with the time span of one year, to identify possible changes in the observed attitudes and perception among students. The questionnaire has been firstly completed in December 2015, followed by the second wave in December 2016. To identify possible differences between Czech and international students a special emphasis had been put on the international character of the groups of respondents, which has been enabled by the presence of international exchange students thanks to the Erasmus program. Thus, in the first sample were 53 international students and in the second sample there were 48 international students (out of 100 respondents in total). About the gender division, in the first sample there were 70 women and 30 men, in the second sample there were 53 women out of 100 respondents in total.

The aim of this questionnaire, as already mentioned, was to identify the attitude and perception of young consumers towards green marketing, namely, if young consumers care about ecology, green marketing and green products, as well as if they are ready to implement this concept into their shopping behaviour.

Thus, the following research questions have been set:

- (1) Do the respondents care about ecology and environment?
- (2) Do respondents care about the approach of companies towards the environment?
- (3) Do respondents prefer products produced by eco-friendly companies?
- (4) Are respondents willing to tolerate higher price or lower quality of green products?

## RESULTS

### 1. *The care about ecology and environment*

Year	Answer	Certainly Yes	Rather Yes	Don't Know	Rather Not	Certainly Not
2015	No. of respondents	27%	46%	18%	9%	0%
2016	No. of respondents	25%	47%	8%	17%	3%

Table 1. Do the respondents care about ecology and environment?

As it can be seen in the Table 1, most respondents are interested in ecology and environment. In total, 73% of respondents expressed that they are certainly or rather interested in these problems. If we compare the results between the two years, there are almost no differences, only the number of people, who are rather not interested increased from 9% to 17%.

A comparison across genders has been performed, but no significant differences identified. The same has been done for the identification of the differences between Czech students and foreign students. In 2015 the foreign students appeared to be more interested in the problems of ecology and environment (only 3% from the total were not interested), whereas this situation did not appear in 2016, when 26% respondents were not interested in the problems of ecology and environment. As regards the nationalities, the foreign students are mixed from the whole group covering European nationalities as well as American or Asian nationalities. Therefore, it is impossible to identify any straight dependence of nationality and the attitude of the respondent to the problems examined.

Thus, the first research question can be answered: The young consumers from the Generation Y care about ecology and environment.

### 2. *Do respondents care about the approach of companies towards the environment?*

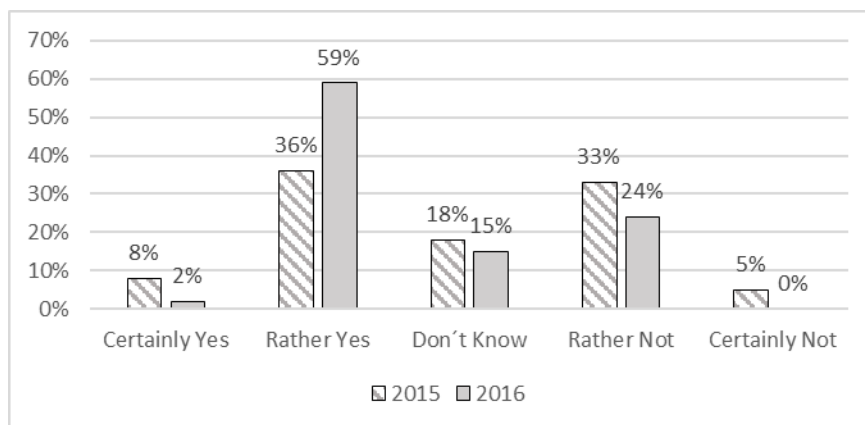

Figure 1. Do respondents care about the approach of companies towards the environment?

As it can be seen in the Figure 1, in 2015 there was an equal proportion of respondents who do care about companies' approach towards the environment and who don't (roughly 40%), in 2016 the

percentage of those who do care accounted for 65% and the was nobody who certainly did not care about this issue.

It was also helpful to see the differences across the nationalities and genders. Whereas there were not substantial changes based on the factor “nationality”, important differences can be observed in the case of gender. It is obvious, that women care more about the problem of companies’ behaviour towards the environment, as illustrate the following Figure 2. Nevertheless, even though in 2016 men still tend to care less than woman about the approach of companies towards the environment, the gap between genders got smaller in 2016, when almost 60% of men and nearly 70% of women do care. (In 2015 60% of men did not care about the behaviour of companies, whereas only 30% of women were not interested in this issue).

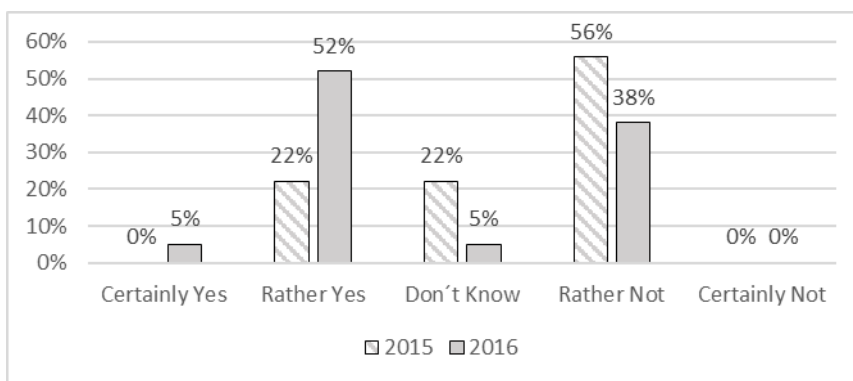

Figure 2. How do men care about the approach of companies towards the environment?

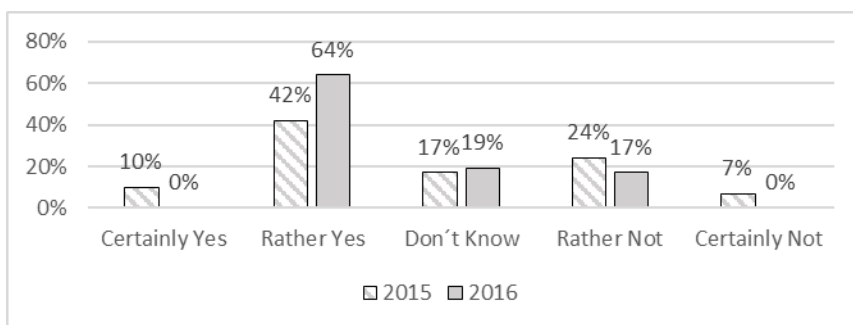

Figure 3. How do women care about the approach of companies towards the environment?

It can thus be summarized, that people already do care about the behaviour of companies towards the environment, even though the attitude appears to be stronger in the case of women.

### 3. Shopping behaviour and consumer preference

In this section, there were two questions used with the aim to find out, if consumers take into consideration “the environmental friendliness” of companies during shopping FMCG/ foodstuffs, and if consumers prefer products, produced by environmentally friendly companies.

Results concerning the first question can be observed in the following tables.

Year	Answer	Quality	Price	Convenience	Brand	Environmental friendliness	Other
2015	No. of respondents	93%	83%	36%	34%	19%	3%
2016	No. of respondents	100%	86%	48%	24%	24%	0%

Table 2. What are your 3 main criteria for shopping of FMCG/ foodstuffs?

It is obvious, that “environmental friendliness” is gaining in importance, if we compare the years 2015 and 2016. Even though it is still not so important for the consumer decisive process as price and quality of products, it has already become a part of consumer criteria for choice, namely for 19% respondents in 2015 and for 24% of respondents in 2016. Thus, this criterion gained even the same importance as the brand.

Year	Czech respondents	Foreign respondents	Male	Female
2015	21%	17%	20%	18%
2016	29%	16%	21%	24%

Table 3. The importance of Environmental friendliness for shopping across genders and nationalities

In 2015 the environmental friendliness during shopping of FMCG/ foodstuffs was slightly more important for Czech male respondents. On the contrary, foreign respondents showed a below the average level preference of this factor.

Almost the same situation appeared in 2016. Again, the environmental friendliness of companies, as a criterion for purchase of FMCG/ foodstuffs was apparently more important for Czech respondents than for the foreign respondents (as we can see in the Table 3), whereas the difference between men and women was rather negligible.

It is rather impossible to explain the fact, why Czechs do put a bigger emphasis on the factor of environmental friendliness, than do the foreign respondents, which also complicated the fact that the foreign respondents represented many nations across the whole world.

Now we can examine the results to the second question – if the respondents prefer products from companies, which behave ecologically friendly. The results are depicted in the Table 4, which also illustrate the comparison of the years 2015 and 2016. It is quite surprising that the trend is declining: In 2015 more than 66% of the total respondents preferred products from ecologically friendly companies, whereas in 2016 only 55% of the total respondents showed this preference. If we look at the figures more in detail, we can see that the preference of products produced by eco-friendly companies is substantially stronger in the case of foreigners as well as women – and this finding can be observed in both years almost equally.

Year	Total	Czechs	Foreigners	Men	Women
2015	66%	58%	75%	60%	69%
2016	55%	52%	58%	47%	62%

Table 4. Number (%) of respondents who prefer products produced by ecologically friendly companies

More than 50% of respondents prefer products produced by environmentally friendly companies, thus it appears that consumers from the generation Y already care about the environmental friendliness of company, while shopping FMCG/ foodstuffs.

4. Are consumers willing to pay more for eco-friendly products/ produced by eco-friendly companies?  
Are consumers ready to tolerate lower quality in case of eco-friendly products?

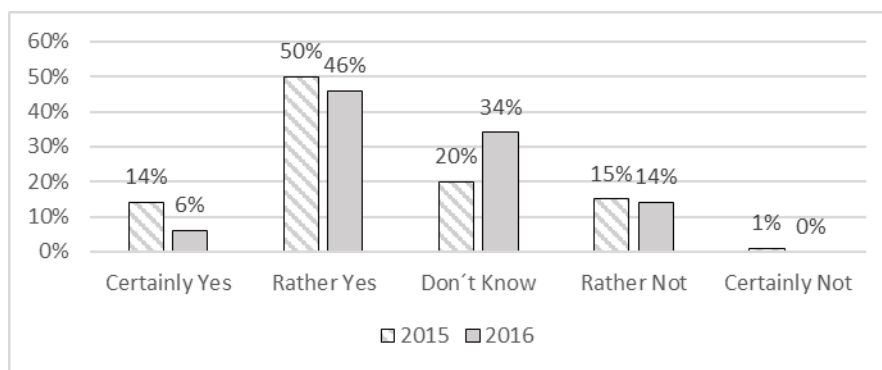

Figure 4. Are consumers willing to pay more for eco-friendly products/ produced by eco-friendly companies?

The Figure 4 shows an evidence, that young consumers from the Generation Y are already environmentally conscious to that extent, that they are ready to pay higher price for eco-friendly products or for products produced by eco-friendly companies. In both years observed there are more than 50% of respondents who are certainly or rather willing to pay more for eco-products. The situation between the years 2015 and 2016 changed only slightly, in 2016 there were less people, who were certainly or rather willing to pay more, whereas more respondents who don't know. On the other hand, in 2016 there were less people than in 2015, who were not willing to pay more for eco-friendly products (only 13% of the total respondents "rather not" willing to pay more in 2016, nobody "certainly not", whereas in 2015 there were 14% "rather not" and 1% "certainly not" willing to pay more) (Own research 2015, 2016).

Possible/ eventual differences between Czech respondents and across genders were examined too. It is rather surprising, but no differences have been detected between the answers of foreign and Czech respondents (Own research 2015, 2016). Only minor differences have been identified across the genders. In 2015 65% of women inquired expressed their willingness to pay more for eco-friendly products (10% certainly yes), whereas the same opinion held only 55% of men (15% certainly yes),



men were also more negative in this regard – 25% of men were either not or rather not willing to pay more for eco-friendly products (5% certainly not), at the same time women were less negative – only 12% expressed, that they were rather not willing to pay more for eco-friendly products (Own research 2015, 2016).

The same situation appeared in 2016 – only 42% of men (5% “certainly yes”), but almost 67% of women (10% “certainly yes”) were willing to pay more for eco-friendly products, whereas almost 16% (nobody “certainly not”) of men, but only 10% of women (and nobody “certainly not”) were not willing to pay more for eco-friendly products (Own research 2015, 2016).

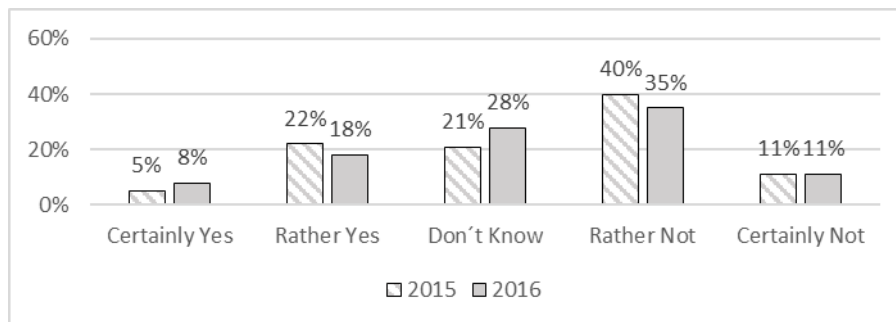

Figure 5. Are consumers ready to tolerate lower quality in case of eco-friendly products?

It is obvious (Figure 5) that most of the young respondents from the Generation Y are not willing to tolerate lower quality in the case of eco-friendly products. However, there are some exceptions: In 2015 27% of the total respondents could tolerate lower quality (4% “certainly yes” and 23% “rather yes”), in 2016 it was 25% of total respondents (7% “certainly yes” and 18% “rather yes”), whereas the percentage of negative answers (intolerance of worse quality in the case of eco-friendly products) in 2015 was 50% (10% “certainly not”) and in 2016 it was 48% (13% “certainly not”) (Own research 2015, 2016). Thus, it can be said, there are no great changes between the years 2015 and 2016.

% of respondents	Certainly Yes	Rather Yes	Don't Know	Rather Not	Certainly Not
Total	4%	23%	23%	40%	10%
Czech resp.	0%	15%	25%	42%	18%
Foreign resp.	8%	31%	19%	39%	3%
Male	15%	15%	10%	45%	15%
Female	0%	27%	27%	39%	7%

Table 5. Are consumers ready to tolerate lower quality in case of eco-friendly products? (2015)

% of respondents	Certainly Yes	Rather Yes	Don't Know	Rather Not	Certainly Not
Total	8%	18%	26%	35%	13%
Czech resp.	0%	14%	29%	38%	19%
Foreign resp.	16%	21%	26%	32%	5%
Male	5%	21%	11%	42%	21%

Female	10%	14%	43%	28%	5%
--------	-----	-----	-----	-----	----

Table 6. Are consumers ready to tolerate lower quality in case of eco-friendly products? (2016)

If we look at the difference given by the nationality and gender (Tables 5 and 6) we can identify the following tendencies:

- (1) The relative tolerance (“certainly yes” or “rather yes”) is higher in the case of foreign respondents and women.
- (2) The absolute tolerance (“certainly yes”) is also higher in the case of foreign respondents and women.
- (3) The relative intolerance (“rather not” or “certainly not”) is higher in the case of Czech respondents and men.
- (4) The absolute intolerance (“certainly not”) is also higher in the case of Czech respondents and men.
- (5) In all groups, there is high level of uncertainty in this area, which was higher in 2016 (26% of the total respondents “did not know”) than in 2015 (23% of the total respondents “did not know”).

The last research questions can be answered now: Young consumers from the Generation Y are likely to pay more for environmentally friendly products/ produced by environmentally friendly companies, however, they are not very likely to tolerate lower quality of environmentally friendly products.

## CONCLUSION

Based on the most important findings from the study we can conclude the following:

The young consumers from the Generation Y do care about ecology and environment, and this care has already become an integral part of their lifestyle.

If we look at the shopping behaviour of the Generation Y, we can say that they already care about environmental friendliness of company even during their shopping (FMCG/ foodstuffs), as more than 50% of respondents prefer products produced by environmentally friendly companies.

Finally, young consumers are even willing to pay more for environmentally friendly products/ produced by environmentally friendly companies, however, they are not very likely to tolerate lower quality of environmentally friendly products.

To conclude, the picture of attitudes of the “Generation Y”, as derived from this study, appears to be rather optimistic, however we must not forget, that this type of research has always its limitations, and it only reveals the attitudes of consumers and not their real actions.

## ACKNOWLEDGEMENT

The article has been supported by project IGA No. F2/50/2017", "Social and sustainable business in the context of international trade".

## REFERENCES

- Baker, M.J. (2003), *The marketing book*, Butterworth-Heinemann, Burlington.
- Castenow, D. (1993), *New Marketing in der Praxis*, ECON Executive Verlags, Düsseldorf.
- Dubey, P. (2008), "Recycling Business: Cases of Strategic Choice for Green Marketing in Japan". *IIMB Management Review*, Vol. 20 No. 3, pp. 263 – 278.
- Horowitz, B. (2012), "After Gen X, Millennials, what should next generation be?", *USA Today*.
- Mokrejšová, V. (2016). *Corporate Social Responsibility* (lecture presentation), University of Economics, Prague.
- Nízka, H. (2007), *Aplikovaný marketing*, Wolters Kluwer, Praha.
- Průša, P. (2007), "Corporate Social Responsibility. How can corporate responsibility be assessed?", *Working Papers Fakulty mezinárodních vztahů*, Vol. 9.
- Sims, R.R., Brinkmann, J. (2003), "Enron Ethics (Or: Culture Matters More than Codes)", *Journal of Business Ethics*, Vol. 45 No. 3, pp. 243-256.
- Supeková, S. (2015), "Aspects of Green Marketing: The Current Situation in the Selected Companies in the Slovak Republic", *Current Issues of Science and Research in the Global World*. pp. 133-141.
- Trnková, J. (2004), *Společenská odpovědnost firem (CSR)*. (<http://www.blf.cz/csr/cz/vyzkum.pdf>)
- Trnková, J. 2005. *Co znamená společenská odpovědnost firem? Napříč společenskou odpovědností firem*. AISIS. Kladno.
- Zhang, X., Zhang T. (1999), "Green Marketing: A Noticeable New Trend Of International Business", *Journal of Zhejiang University*, Vol. 1 No.1, pp.99-104.

## DETERMINANTS OF CREDIT TO SMES - EMPIRICAL EVIDENCE FROM SUPPLY SIDE PERSPECTIVE IN MUMBAI REGION

Raghu, Kumari P.S; Pankaj, Trivedi

K J SIMSR –Finance Department, Mumbai

### ABSTRACT

SME sector has emerged as most important and dynamic sector of Indian Economy. With the latest new initiatives by new government like “Make in India” manufacturing sector has been recognized as the top priority for the development of nation. More than 50 lakh SME units were added from 2006-07 to 2011 period which shows the rapid expansion of SMEs in India. One of the main challenges the sector is facing today is “Lack of financing”. Funds support can be given to SMEs mainly with the support of financial institutions especially by banks along with other sources. Present paper studied the credit granting criteria to SMEs and its impacting factors by applying Binary logit regression model. Research study found that Age of the owner and Net worth are considered to be most important while granting credit to SMEs in the region of Mumbai.

*Keywords: Credit granting, Financing, SME credit.*

### I. INTRODUCTION:

Credit sanctions to small and medium enterprises have two perspectives in decision making: i) human factor model; and ii) credit score model basis (Jain et al. 2011). Credit score approach is system driven and fixed process model whereas human factor model is widely practiced and adopted across the world. Financial institutions appoint dedicated loan officers to scrutinize and assess the loan applications. These loan officers operate based on set of guidelines decided by institutions. Ability of humans to evaluate the worthiness of the loan application is low because of many loopholes in decision making in the form of biasness and psychological factors (Glorfeld and Hardgrave, 1996). In order to remove barriers in this model financial institution should have policy driven credit granting process, proper credit administration, and assessment and reviewing process. Literature available from across the globe indicates the parameters which are emphasized more in SME credit granting. Ayapong et al. (2011) stated that intended purpose of loan, repayment schedule, type of business activity, size of loan, and financial parameters play crucial role in getting SME credit in Ghana. Financial parameters like liquidity, profitability and cash flows are very important in getting credit (Bebczuk, 2004). Apart from these owner reputations, firm size, genders were also considered widely

(Kouser, 2012). The credit score model requires historical financial data to give the output whereas most of SMEs in India are not having well maintained historical and authenticated financial statements with them which becomes a challenge to loan officer to take the decision on credit issuance (Dietsch and Petey, 2004). According to working committee report of MSME 2015, presently most of the banks insist on audited financial statements for lending up to 20 million INR, whereas banks may not ask for audited financial statements whose turnover is less than 6 Million INR. In the absence of financial statements data human factor approach is the most suitable and widely available method for loan officers.

Present paper focuses on understanding the parameters which are emphasized more when loan officers scrutinize the SME applications in Mumbai with human approach model. The study emphasized on understating factors which influence the outcome of loan application of SMEs in Mumbai.

According to MSME report 2013-14, MSME contributes to 40% of exports and employ nearly 100 million people. Despite their enormous contribution to economy they are facing many challenges in their business. One of the major challenges is “lack of financing” and most of the SMEs in India depend more on debt and equity funding with many of them continuing as family owned enterprises. It is stated in RBI D&B Research report 2012 that SMEs increased from 2001 to 2012 to 40% whereas outstanding credit has just increased only 25%. Credit gap in this sector is a huge opportunity for banking sector in India. The most important factor to ensure that the SME sector grows in India is to provide adequate finance to the sector and induce them to employ better management practices. CRISIL conducted a study in 2011 on the financing pattern of 2000 small and medium enterprises and revealed that there is an opportunity for banks to fund up to 500 Billion INR. The funding opportunity is more for smaller SMEs where turnover is less than 50 Million INR. In the past banks have financed only up to 60% whereas the common banking practice of financing is up to 75 per cent of a firm's working capital requirement. This deficit was funded by the SMEs from their own funds. Present research paper focuses on the need to improve the credit flow to SMEs in India and with this intention a primary survey of loan officers was conducted in order to find out the most emphasizing factors for

banks while lending to SME sectors. Binary logit regression analysis was conducted to know the important parameters while lending to SMEs in Mumbai. The study helps SME sector immensely as they can focus more on the required parameters to improve credit flow at the right time. Asia SME Finance Monitor Report 2013 says, SME financing policies should be addressed in a holistic manner that goes beyond already established ways. Policy makers should develop a comprehensive policy options that allow SMEs to select diversified financing models which help them doing business in an easy way

The paper is organized as follows. In section II, literature review was presented which will form as the basis for selection of variables and hypothesis. In section III, Research methodology was presented. In section IV, Data analysis, interpretations and managerial implications were presented and in section V, Conclusion was presented.

## **2. LITERATURE REVIEW**

It is evident from history that loan applications were assessed by human approach by using 5Cs (Character, Capacity, Capital, Collateral and Condition), whereas in current scenario credit score models are widely used by loan officers. Several studies were conducted on the issue of what impacts most when it comes to SME loan approval and rejections. Every loan application submitted by SME is carefully scrutinized by loan officers to take the final decision. The success of loan application depends on various important parameters like financials, firm size and creditability of owner. Fatoki and Asah (2011) observed in South Africa that Older SMEs have a better chance in getting credit sanctions compared to SMEs established five years back. It is found in Ghana that form of business is one of the factors crucially considered for granting loans (Abor, 2008). It is observed that location where SMEs are located is also very important factor when it comes obtaining credit from banks in Nigeria and Fiji (Okpara and Wynn, 2007; Reddy, 2007). Various parameters contribute to acceptance and rejection of loan applications submitted by SMEs. Number of studies have also focused on the parameters which lead to rejection of loans. Read (1998) states that the main reason attributed for rejection of SME loans are lack of collateral, less turnover, poor cash reserves.

Several research studies argued that Demographic factors and Gender are also playing crucial role in getting credit from banks. The study done by Bexley and Neminger (2012) indicated that loan officers

can now easily obtain early indicators of increasing risk by taking a more comprehensive view of the customer's demographic characteristics. According to Gardener and Mills (2000) demographic profile includes items such as age, gender, level of income, level of education, home ownership, employment status and even location. From the study of Berger and Udell (2006) it is concluded that there is relationship between borrower demographics category and assessing loan repayment performance, Hence borrower's demographic factors are important aspects that banks can consider when advancing loans to them. According to the study of Giesecke (2004) demographic factors of borrowers are associated with the creditworthiness of borrowers and these factors are also interrelated. Nguyen (2007) study concluded that demographic profiling as a key factor influencing loan advances and the subsequent performance of the loan as it indicates important clues to loan officers with regard to sanctioning of the loan. The study conducted by Berger and Udell (2006) found that banks are likely to consider comparatively more mature clients for loans relative to young clients. It is observed that male customers tend to receive favourable responses from bank compared to female customers. Blanchflower et al. (2003) concluded that women owned business were about twice as likely to be rejected loans even after fulfilling well in all the required parameters. Kantrowitz (2010) study found that the parents education level, having dependents, the marital status of borrower, the borrower's income have significant relationship with loan performance in banks.

Literature review of many research papers reported differences in the financing patterns of male-owned and female-owned businesses (Coleman, 2000). Women-owned businesses tend to startup with lower levels of overall capitalization (Carter and Rosa, 1998), lower ratios of debt finance (Haines, Orser, and Riding, 1999), and much less likelihood of using private equity or venture capital (Brush et al., 2001). Researchers investigating gender-based differences in debt financing have focused on two related themes. First researchers have tried to find the complex relationship between gender of entrepreneur and bank finance with regard to the volume of finance lent, the terms of loan negotiated, and the perceived attitudes of bank lending officers to female entrepreneurs (Coleman, 2000). Second, researchers have tried to explain whether gender-based differences are a consequence of supply-side discrimination by bank lenders, demand-side aversion to debt or risk by women entrepreneurs, or simply the result of the structural dissimilarities of male-owned and female-owned businesses (Buttner and Rosen, 1989). Overall, the insights of research evidence considering gender, entrepreneurship, and bank lending suggests that while the bank financing profiles of male and female entrepreneurs are distinctly different, much but not all is attributable to structural dissimilarities. The research proof also suggests that while women entrepreneurs feel that they are treated differently by bank lending officers (Fabowale et al. 1995), there is almost no evidence of systematic gender discrimination by banks. Indeed, there is a growing recognition that women

entrepreneurs constitute an important new market for banks, and it is difficult to state that it is within the banks' interest to deliberately, much less systematically, exclude this growing market. The debate has continued largely because of dissatisfaction with existing explanations, coupled with the methodological difficulties facing researchers in providing clear and unequivocal evidence (Haines et al. 1999; Mahot, 1997).

Cliff (1998) and Coleman (2000) explained different preferences of female entrepreneurs such as a tendency to be less likely to use external sources of credit, or to make deliberate choices to limit growth rates and size of their firms. Though, both studies could not provide evidence of change in access to financing, but rather that access is affected by choices made about firm characteristics, with financing being less accessible for smaller businesses than larger ones. It is useful to understand that the perception of bias towards women continues to exist in spite of lack of evidence for this bias in the research literature. With reference to debt financing, Fabowale et al. (1995) state that while their research showed no evidence of differential access to credit between male and female entrepreneurs, women were far more likely to report feelings of being treated disrespectfully by financial institutions. While many studies found no differences in loan rates for comparably qualified male and female applicants, this presses the broader question as to whether women are able to compete equally with their male counterparts. Lack of reach to debt financing is compounded by women-owned businesses having lower sales volumes, less capacity, less capital, less collateral and the owners have less professional experience than male-owned businesses (Fabowale et al., 1995). Research studies focused on various loan impacting parameters to analyze their role in the final outcome as it helps both the parties in improving credit flow.

SMEs are very important to low income countries as they make significant contribution to GDP and employment. SMEs in India contribute to 40% of exports. In spite of SMEs playing crucial role in Economic development their challenges are similar across the world. One of the main challenge faced by SMEs across the world and as well in India is "availability of finance" (oy and Haynes, 2006; cook, 2001). At different stage of firm's growth cycle, different financing support is required (Berger and Udell, 1998). Present study focuses on determinants of SME credit in Mumbai. Variables used in the study are carefully selected from the literature available and are tabulated below.

**Hypotheses developed from above literature:**

H1: "Age of the owner" is not significant factor while granting credit to SMEs

H2: "Net worth" is not significant factor while granting credit to SMEs

H3: "Age of the firm" is not significant factor while granting credit to SMEs

H4: "Gender" is not significant factor while granting credit to SMEs



H5: "Geographic location" is not significant factor while granting credit to SMEs

### 3. RESEARCH METHODOLOGY:

#### 3.1 Sampling Design:

The study focused on Supply side analysis with samples collected from loan officers across Mumbai city. Due to limited availability of these professionals it was decided to approach them through appointments by leveraging the networks in the chosen area. The objective of sampling is to reflect the population by using sample (De vaus, 1996; Miller, 1991; Mies and Huberman, 1984). Convenient sampling technique was used to collect samples from various branches of chosen banks from all corners of Mumbai.

#### Sample size:

Choosing right sample size is the key in statistical analysis involving inferences on population parameters based on sample parameters. Luck and Rubin (1987) study indicated that large sample size is most preferred when using advanced techniques. Krejcie and Morgan (1970) study indicated that a sample size of unknown population of 384 is good. Gerbing and Anderson (1993) recommended that at least 200 responses are required to obtain variable estimates with reasonable degree of confidence. Thus to achieve a minimum of 200 samples total 234 were collected and scrutinized to get the required results.

#### Instrumentation

For effective and error less data collection, survey, and interview methods were extensively used. The questionnaire was intricately designed to gather the information on the factors that affect the credit granting decision from loan officer point of view.

#### Sample Data: Table:1

Banks participated in survey	Loan officers	Percentage
SBI	31	13.5
IDBI	32	16
Thane cooperative bank Ltd.	21	10.5
BOB	15	9.5
PNB	12	6
ICICI	41	20.5
AXIS	14	7
HDFC Bank	20	10
Union bank of India	14	7
Total	200	100

The Cronbach's alpha coefficient was used to assess reliability of the measures (Straub, 1989). As shown in the following table the alpha coefficient for the 45 items is .710, suggesting that the items have relatively good internal consistency

Reliability Statistics

Cronbach's Alpha	N of Items
.710	45

According to Nunnally (1978) alpha value above 0.710 is acceptable for data analysis and interpretations.

### 3.2 Explanatory variables

**Age of the firm:** Rehanakouser et al., (2012) revealed that age of the firm plays crucial role while granting credit to SMEs. David A schauer (2001) concluded that older firms hold more weightage in getting credit sanctions.

**Age of the owner:** Sinha (1996) study concluded that young age entrepreneurs were relatively more successful. Reynolds et al.(2000) found that entrepreneurs aged between 25-44 years tend to be successful in getting credit. It is found that there exists significant correlation between age of the business owner and business success was emphasized (Kristiansen, Funholt, and Wahid, 2003)

**Gender:** Kolverid (1996) found that male business owners had significantly higher business intentions than female business owners. Mazzarol et al. (1999) found that female business owners show less inclination towards setting of new ventures.

**Net Worth:** One of the most important financial parameter bankers study before granting a loan is Net worth. It is calculated using financial information provided by the borrower. It is observed that net income and net worth are highly preferred calculations in getting credit to SMEs.(Berger and Udell, 2006)

**Geographic location:** Burger et al (2006) and David A Schaurez et al (2006) emphasized that location where SMEs are placed plays crucial role in credit sanctions.

**Nature of financial system:** David A Schaurez et al (2006) found that poor quality of financial statements maintained by SMEs proved to be the biggest barrier in credit sanctions.

**Form of ownership:** According to Berger and Udell (2006) study ,the legal structure of the firm whether it is a sole proprietorship or partnership is having less impact in credit sancations.This factor is added in current study in order to test whether it is influenced in Mumbai region or not.

## 4. DATA ANALYSIS

### 4.2 Binary Logit Regression model

The purpose of research is to provide an exhaustive empirical analysis with respect to the factors which influence the outcome of loan application of SMEs in Mumbai. Logistic regression is a statistical analysis tool models that explains the response of relations between the variables that have two or more categories with one or more independent variables or interval scale category (Hosmer and Lameshow, 2004). Logistic regression models explain the relationship between  $X$  and  $\pi(\chi)$  which is not linear, abnormal distribution of  $Y$ , diversity is not constant and cannot be explained by ordinary linear regression model. Data observations has  $p$  independent variables  $\chi_1, \chi_2, \dots, \chi_p$  with the response variable  $Y$  which has two possible values of 0 to indicate that the response does not have criteria and a value of 1 to indicate that the response has criteria. 1) Independent variables used in the model do not have normality assumption. 2) Dependent variable consists of continuous variables, discrete, and nominal with dichotomous nature. 3) Distribution of expected response variable nonlinear. Kinds of logistics are divided into binary logistic regression and multinomial logistic regression. In this study, the response is a binary variable that is a loan application accepted or loan application denied, then the incident at the time of granting credit decisions by potential Small Medium Enterprises (SMEs) borrowers recommended or accepted by the influence of a particular variable. The model used in the logistic regression analysis is  $\text{logit}(\pi) = \beta_0 + \beta_1 * X$  with  $\text{logit}(\pi)$  is the value of the logit transformation to a successful event opportunities,  $\beta_0$  is the regression intercept,  $\beta_1$  is the slope of the regression line models, and  $X$  is the explanatory variables (Nachrowi, 2002: 307):

Thus, the estimation model used in this study is:

$$Li = \ln [p/1+p] = \beta_0 + \beta_1 + \beta_2 + \beta_3 + \beta_4 + \beta_5 + \beta_6$$

Descriptions:

$\ln [p/1+p]$  = Loan application accepted or rejected

$\beta_0$ : Age of the firm

$\beta_1$ : Age of the owner

$\beta_2$ : Gender

$\beta_3$ : Net worth

$\beta_4$ : Geographic location

$\beta_5$ : Nature of Financial system

$\beta_6$ : Form of ownership

The multivariate statistical analysis technique, Binary Logistic Regression is used to identify the individual and collective roles of the following variables concerning their influence on loan approval/denial rates. From the Literature review it is observed that Charlo et al. (2010) and David A.

Schauer et al., (2001) have used binary logistic regression in their research to predict the loan impacting variables.

For the present study "Loan approval status" is considered as Dependent variable and the following were considered as Independent variables and all are recoded into "1" and "0" for the purpose of BLR. Forward likelihood Ratio method was applied in Minitab software for the following variables

1. Loan approval status coded as approved 1 and not approved as 0
2. Nature of financial system coded as sophisticated 1 and conventional system as 0
3. Legal structure of the firm coded as selected and particular type 1 and other category as 0
4. Size of firm based on turnover coded as Large 1 and small 0
5. Age of the firm coded as Young 1 and old 0
6. Gender of the owner coded as Female 1 and Male as 0
7. Geographic area is coded as selected areas as 1 and other area as 0
8. Type of activity is coded as conventional areas as 1 other and new areas 0
9. Net worth up to 30 Lakhs coded as below average net worth. Above 30 Lakhs coded as above average net worth

**Table:2 BLR test results in predicting credit impacting variables**

Predictor	Coefficient	SE Coefficient	Z	P	Odds Ratio	95% CI- Lower	95% CI- Upper
Constant	0.6665	0.7479	0.89	0.373			
Age of firm	0.2380	0.1533	1.55	0.121	1.27	0.94	1.71
Age of owner	-0.3518	0.1700	-2.07	0.038	0.70	0.50	0.98
Gender	-0.1393	0.5569	-0.25	0.802	0.87	0.29	2.59
Net worth	0.31070	0.06739	4.61	0.000	1.36	1.20	1.56
Geographic location	-0.13790	0.09719	-1.42	0.156	0.87	0.72	1.05
Nature of financial system	-0.0363	0.1756	-0.21	0.836	0.96	0.68	1.36
Form of ownership	-0.3142	0.2198	-1.43	0.153	0.73	0.47	1.12

Log-Likelihood = -177.402

Test that all slopes are zero: G=28.213, DF=7. P-Value=0.000

#### Significance testing model and parameters:

Significance test of the model is tested using value of chi square distribution of the Pearson method, Deviance, and Hosmer Lemeshow.

H0: No significant difference between the values of observations with model predicted values

#### Goodness-of-Fit Tests

Method	Chi-Square	DF	P
--------	------------	----	---

Pearson	259.894	230	0.086
Deviance	318.026	230	0.000
Hosmer-Lemeshow	8.192	8	0.415

From the above table it is observed that Hosmer-Lemeshow P-value is 0.415 which is above the significant level of 0.05 which means it is insignificant and this model is perfect fit for the data and proved to be a good fit. Pearson P value 0.086 is above the significant level of 0.05 which indicates our model predicts values not significantly different from what it was observed.

Variable "age of the owner " has got the p value of 0.038 which is below of  $\alpha =0.05$ , hence reject H0 and accept H1 concluding that "age of the owner" is significant variable while granting loan to SME in Mumbai

Variable "net worth "has got the p value of 0.000 which is below of  $\alpha =0.05$ , hence reject H0 and accept H1 concluding that "net worth" is significant variable while granting loan to SME in Mumbai

Variable "age of the firm "has got the p value of 0.121 which is above of  $\alpha =0.05$ , hence accept H0, concluding that "age of the firm" is not a significant variable while granting loan to SME in Mumbai

Variable "gender "has got the p value of 0.087 which is above of  $\alpha =0.05$ , hence accept H0 , concluding that "gender" is not a significant variable while granting loan to SME in Mumbai

Variable "geographical location "has got the p value of 0.156 which is above of  $\alpha =0.05$ , hence accept H0 , concluding that "geographical location" is not a significant variable while granting loan to SME in Mumbai

Variable "nature of financial system" has got the p value of 0.836 which is above of  $\alpha =0.05$ , hence accept H0, concluding that "nature of financial system" is not a significant variable while granting loan to SME in Mumbai

Variable "form of ownership "has got the p value of 0.153 which is above of  $\alpha =0.05$ , hence accept H0, concluding that "age of the firm" is not a significant variable while granting loan to SME in Mumbai

BLR equation for the present study written from the above table is as follows:

**Loan application status = -0.3518 age of the owner + 0.31070 Net worth**

Interpretation: Interpretation of logistic regression models was done using odds ratio from the above table, value of the odds ratio is used to explain the relationship between the dependent variable and the independent variables.

Odds ratio for age of the owner (0.70) of respondents indicate that whose loans are approved belongs to lower age groups than the respondents whose loans are disapproved

Odds ratio for Net worth (1.36) of respondents indicate that one unit change in the Net worth is going to increase the loan acceptance by 1.36 times

**Measures of Association:**

(Between the Response Variable and Predicted Probabilities)

Pairs	Number	Percent	Summary Measures	
Concordant	13227	67.7%	Somers' D	0.36
Discordant	6167	31.6%	Goodman-Kruskal Gamma	0.36
Ties	142	0.7%	Kendall's Tau-a	0.17
Total	19536	100.0%		

These correlations may range from 0 to 1 hence a large value indicates a stronger relationship and thereby indicates the strong predictive validity for the model. In the above model values are ranging from 0.36 to 0.17 which imply a reasonable predictive ability of the model considering the many uncontrolled and subjective parameters controlling the loan acceptance decision in practical scenario

#### 4.3 Managerial Implications

It is observed from study that young age entrepreneurs who are having good net worth are getting credit successfully in Mumbai. This shows that Banks can focus more startup loans and can tap young entrepreneurs who have creative and prospective ideas on business. SME Entrepreneurs should approach for loans early as age increases it becomes difficult to get sanctions and they should focus more on creating net worth by reducing expenses and increasing revenue through various managerial strategies.

## 5. CONCLUSION

Most small business owners are confused and concerned about the parameters which are considered while granting credit to business firms. Loan applications are evaluated on the basis of parameters defined by Banks. It is important now to make this evaluation criteria uniform across all the banks and create awareness on these criteria parameters to improve the credit flow to SMEs. Present research paper has identified through multiple logistic regression that Form of ownership, Size of Business and Geographic location are the most impacting factors in getting credit from Banks in Mumbai. Further research using neural networks and artificial intelligence techniques it is possible to enhance the predictability of factors in SME credit.

## 6. LIMITATIONS

This study relied on primary data which is restricted to Mumbai city-The financial hub of India.

The variables used in this study are taken from literature and no new variables are incorporated in the model chosen.

Limited sample size could influence the results.

Various other parameters which can influence SME loan sanctions like perceptions, credit scores are ignored here.

## REFERENCE

- Abor, J., 2008. Determinants of the capital structure of Ghanaian firms (No. RP\_176). Nairobi: African Economic Research Consortium.
- Agyapong, D., Agyapong, G.K. and Darfor, K.N., 2011. Criteria for Assessing Small and Medium Enterprises' Borrowers in Ghana. *International Business Research*, 4(4), p.132.
- Bebczuk, R.N., 2004. What determines the access to credit by SMEs in Argentina?. *Documentos de Trabajo*.
- Berger, A.N. and Udell, G.F., 1998. The economics of small business finance: The roles of private equity and debt markets in the financial growth cycle. *Journal of banking & finance*, 22(6), pp.613-673.
- Berger, A.N. and Udell, G.F., 2006. A more complete conceptual framework for SME finance. *Journal of Banking & Finance*, 30(11), pp.2945-2966.
- Bexley, J.B. and Nenninger, S., 2012. Financial institutions and the economy. *Journal of Accounting and Finance*, 12(1), p.42.
- Blanchflower, D.G., Levine, P.B. and Zimmerman, D.J., 2003. Discrimination in the small-business credit market. *Review of Economics and Statistics*, 85(4), pp.930-943.
- Brush, C.G., Greene, P.G. and Hart, M.M., 2001. From initial idea to unique advantage: The entrepreneurial challenge of constructing a resource base. *The academy of management executive*, 15(1), pp.64-78.
- Buttner, E.H. and Rosen, B., 1989. Funding new business ventures: Are decision makers biased against women entrepreneurs?. *Journal of Business Venturing*, 4(4), pp.249-261.
- Carter, S. and Rosa, P., 1998. Indigenous rural firms: farm enterprises in the UK. *International Small Business Journal*, 16(4), pp.15-27.
- Charlo, M.J., 2010. The Most Relevant Variables To Support Risk Analysts For Loan Decisions: An Empirical Study. *Regional and Sectoral Economic Studies*, 10(1).
- Cliff, J.E., 1998. Does one size fit all? Exploring the relationship between attitudes towards growth, gender, and business size. *Journal of business venturing*, 13(6), pp.523-542.
- Coleman, S. and Cohn, R., 2000. SMALL FIRMS'USE OF FINANCIAL LEVERAGE: EVIDENCE FROM THE 1993 NATIONAL SURVEY OF SMALL BUSINESS FINANCES. *Journal of Business and Entrepreneurship*, 12(3), p.81.
- Coleman, S., 2000. Access to capital and terms of credit: A comparison of men-and women-owned small businesses. *Journal of Small Business Management*, 38(3), p.37.
- Dietsch, M. and Petey, J., 2004. Should SME exposures be treated as retail or corporate exposures? A comparative analysis of default probabilities and asset correlations in French and German SMEs. *Journal of Banking & Finance*, 28(4), pp.773-788.
- Fabowale, L., Orser, B. and Riding, A., 1995. Gender, structural factors, and credit terms between Canadian small businesses and financial institutions. *Entrepreneurship: Theory and Practice*, 19(4), pp.41-66.
- Gerbing, D.W. and Anderson, J.C., 1993. Monte Carlo evaluations of goodness-of-fit indices for structural equation models. *Sage focus editions*, 154, pp.40-40.
- Giesecke, K., 2004. Credit risk modeling and valuation: An introduction.
- Glorfeld, L.W. and Hardgrave, B.C., 1996. An improved method for developing neural networks: The case of evaluating commercial loan creditworthiness. *Computers & Operations Research*, 23(10), pp.933-944.
- Haines, G.H., Orser, B.J. and Riding, A.L., 1999. Myths and realities: An empirical study of banks and the gender of small business clients. *Canadian Journal of Administrative Sciences/Revue Canadienne des Sciences de l'Administration*, 16(4), pp.291-307.
- Hosmer Jr, D.W., Lemeshow, S. and Sturdivant, R.X., 2013. *Applied logistic regression* (Vol. 398). John Wiley & Sons.
- Jain, K.K., Gupta, P.K. and Mittal, S., 2011. Logistic predictive model for SMEs financing in India. *Vision: The Journal of Business Perspective*, 15(4), pp.331-346.
- Kantrowitz, M., 2007. The financial value of a higher education. *Journal of Student Financial Aid*, 37(1), p.5.
- Kolvereid, L., 1996. Prediction of employment status choice intentions. *Entrepreneurship: Theory and Practice*, 21(1), pp.47-58.
- Kouser, R., Durani, A., Hussain, F.Z. and Hassan, M., 2012. Investigation of Banker's Lending Criteria to SMEs and Assessment Thereof. *International Research Journal of Finance and Economics*, 4(89), pp.158-186.

- Krejcie, R.V. and Morgan, D.W., 1970. Determining sample size for research activities. *Educational and psychological measurement*, 30(3), pp.607-610.
- Kristiansen, S. and Indarti, N., 2004. Entrepreneurial intention among Indonesian and Norwegian students. *Journal of Enterprising Culture*, 12(01), pp.55-78.
- Luck, D.J. and Rubin, R.S., 1987. *Marketing research* 7th ed.
- Mahot, P. (1998). Funding for women entrepreneurs: A real-though disputed-problem. *Women entrepreneurs in small and medium enterprises*, 217.
- Mazzarol, T., Volery, T., Doss, N. and Thein, V., 1999. Factors influencing small business start-ups: a comparison with previous research. *International Journal of Entrepreneurial Behavior & Research*, 5(2), pp.48-63.
- Miles, M.B. and Huberman, A.M., 1994. *Qualitative data analysis: A sourcebook*. Beverly Hills: Sage Publications.
- Nachrowi, N.D. and Usman, H., 2002. *Penggunaan teknik ekonometri: pendekatan populer dan praktis dilengkapi teknik analisis dan pengolahan data dengan menggunakan paket program SPSS*. Radja Grafindo Persada. Jakarta.
- Nguyen, C.H., 2007. Access to credit and borrowing behaviour of rural households in a Transition Economy. Retrieved August, 23, p.2013.
- Nunnally, J., 1978. *Psychometric methods*.
- Okpara, J.O. and Wynn, P., 2007. Determinants of small business growth constraints in a sub-Saharan African economy. *SAM advanced management journal*, 72(2), p.24.
- Olawale, F. and Garwe, D., 2010. Obstacles to the growth of new SMEs in South Africa: A principal component analysis approach. *African journal of Business management*, 4(5), p.729.
- Orser, B.J. and Foster, M.K., 1994. Lending practices and Canadian women in micro-based businesses. *Women in Management Review*, 9(5), pp.11-19.
- Reddy, M., 2007. Small business in small economies: constraints and opportunities for growth. *Social and economic studies*, pp.304-321.
- Reynolds, P.D., Hay, M., Bygrave, W.D., Camp, S.M. and Autio, E., 2000. *Global Entrepreneurship Monitor: 2000 Executive Report* (Kansas City, Kauffman Center for Entrepreneurial Leadership).
- Schauer, D.A. and Soden, D.L., 2001. *Capital Access in El Paso: A Multivariate Analysis of Factors Influencing Loan Approval*.
- Sinha, T.N., 1996. Human factors in entrepreneurship effectiveness. *The Journal of Entrepreneurship*, 5(1), pp.23-39.
- Straub, D.W., 1989. Validating instruments in MIS research. *MIS quarterly*, pp.147-169.



## TEAM PSYCHOLOGICAL SAFETY PREDICTING TEAM CREATIVITY: A CONDITIONAL INDIRECT EFFECT MODEL

Rego, Arménio<sup>1</sup>; Melo, Ana Isabel<sup>2</sup>; Bluhm, Dustin J.<sup>3</sup>; Pina e Cunha, Miguel<sup>3</sup>; Valverde,  
Camilo<sup>5</sup>

<sup>1</sup>Católica Porto Business School, Universidade Católica Portuguesa and Instituto Universitário de Lisboa (ISCTE-IUL), Business Research Unit, Portugal

<sup>2</sup>School of Technology and Management (ESTGA-UA), University of Aveiro, Aveiro, Portugal and Centre for Research in Higher Education Policies (CIPES), Matosinhos, Portugal

<sup>3</sup>College of Business, University of Colorado Colorado Springs, Colorado Springs, CO USA

<sup>4</sup>Nova School of Business and Economics; Universidade Nova de Lisboa, Portugal

<sup>5</sup>Católica Porto Business School, Universidade Católica Portuguesa, Portugal

### ABSTRACT

Through a sample of 79 teams, we test if (a) team psychological safety (PsySafe) predicts team creativity through team learning behaviour, (b) the relationship between team PsySafe and team learning is moderated by the consistency of team PsySafe, and (c) the relationship between team learning behaviour and team creativity is moderated by the consistency of team learning behaviour. The main findings are: (1) team PsySafe predicts team creativity through team learning behaviour; (2) this indirect effect is stronger versus weaker when the consistency of PsySafe and/or team learning behaviour within the team is higher versus lower. The most creative teams are characterized not only by high PsySafe and high team learning behaviour, but also by low within-team variability in the perceptions of team PsySafe and team learning.

*Keywords: team psychological safety; team learning behaviour; team creativity; strength of team psychological safety; strength of team learning*

### INTRODUCTION

A psychologically safe environment is crucial for individual, team, and organizational performance (Edmondson and Lei, 2014; Frazier et al, 2017). One of the ways that psychological safety (PsySafe) contributes to performance is by promoting individual and collective creativity (Frazier et al., 2017). Creativity is “the production of ideas concerning products, practices, services, or procedures that are novel or original and potentially useful to the organization” (Oldham and Baer, 2012, p. 388). In psychologically safe contexts, individuals are more likely to take advantage of opportunities and experiment with novel solutions to problems. This paper relies on the *Input-Process-Output* (IPO)

model of team effectiveness (Ilgen et al., 2005; Kozlowski et al., 2016) and the theory of climate strength (González-Romá et al., 2002, 2009; Schneider et al., 2002) to examine how team PsySafe influences team creativity through team learning behaviour. We argue that team learning behaviour is a team interaction process linking team PsySafe to team creativity (Drach-Zahavy and Somech, 2001; Paulus et al., 2012). Team creativity and individual creativity represent different phenomena and constructs, with research demonstrating that team creativity is not the mere sum of team members' creativity (Paulus et al., 2012; Rego et al., 2014). Team creativity represents an effectiveness criterion (Yammarino et al., 2008), and we treat it as an output (Paulus et al., 2012).

This research makes several important contributions to the literature on organizational creativity. First, as Anderson et al. (2014, p. 1309) observed, research into team creativity and innovation “is particularly valuable as organizations have moved inexorably to more team-based structures and will often be reliant upon teams to develop and implement innovative solutions even where the ideas may have originally been proposed by an individual”. More research on the antecedents of team creativity is necessary (Reiter-Palmon et al., 2012), especially considering that well-functioning teams can foster team creativity that leads to organizational innovation and performance (Amabile et al., 1996; Bechtoldt et al., 2010; Oldham and Cummings, 1996; Reiter-Palmon et al., 2012; Woodman et al., 1993).

Second, we consider that the  $I \rightarrow P$  and the  $P \rightarrow O$  relationships are moderated by the consistency with which the members of the team perceive team PsySafe and team learning behaviour, respectively. We hypothesize that (a) the consistency with which team members experience PsySafe (i.e. Input consistency) moderates the  $I \rightarrow P$  relationship, and (b) the consistency with which team members engage in and experience team learning behaviours (i.e., Process consistency) moderates the  $P \rightarrow O$  relationship. Our conceptual model (Figure 1) therefore suggests a conditional indirect model linking team PsySafe to team creativity. We propose that the  $I \rightarrow P$  and the  $P \rightarrow O$  relationships are stronger versus weaker when the team members perceive PsySafe and team learning behaviour in a more versus less consistent way.

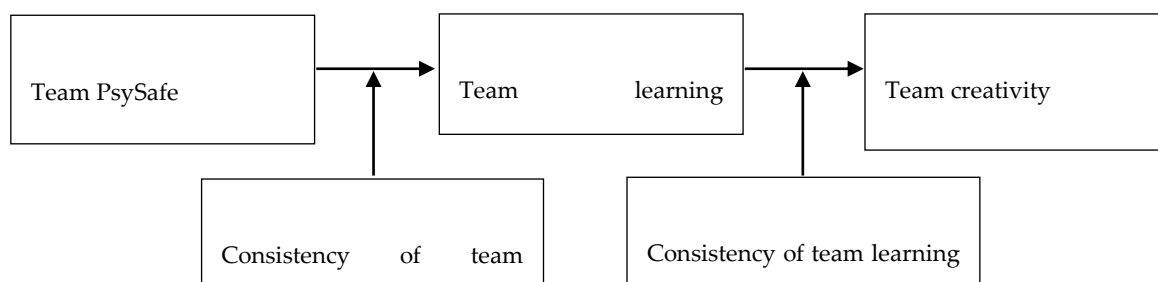

Figure 1. *Hypothesized model.*

Finally, most research on team or group creativity examines teams in controlled laboratory settings (Paulus et al., 2012). Our research contributes to the creativity literature by examining team creativity in a real-world work environment, providing new insights to both scholars and practitioners.

## **THEORY AND HYPOTHESES**

### *Psychological safety and creativity*

Team PsySafe reflects the “shared belief” that it is safe for team members to take interpersonal risks within the team (Edmondson, 1999, 2004; Paulus et al., 2012), and team creativity may emerge as a consequence of such a shared belief. To flourish, team creativity requires a supportive context, which includes an atmosphere of PsySafe in which team members feel free “to engage in some of the risky behaviours involved in creativity” (Paulus et al., 2012, p. 349) and to “propose new ideas and solutions without being judged or criticized” (Anderson et al., 2014, p. 1301). Conversely, when members face psychological threats and experience low PsySafe, they are more likely to develop a defensive orientation and suppress the expression of creativity at work (Paulus et al., 2012; West and Richter, 2008). Several studies have found empirical support for this relationship (e.g., Carmeli et al., 2010; Carmeli, and Spreitzer, 2009; Edmondson, 2004; Paulus et al., 2012; Yoon et al., 2010), but meta-analyses (Frazier et al., 2017; Hulsheger et al., 2009) found relatively weak relationships between PsySafe and team creativity and innovation. One possible reason for such a weak nexus is that the relationship between team PsySafe and team creativity might be both indirect and conditional.

### *Team learning behaviour as a mediator*

We propose team learning behaviour as a mechanism through which team PsySafe influences team creativity. Team learning behaviour represents the extent to which “team members overtly reflect on the team objectives, strategies, and processes for the purpose of creating a team-level intellectual product that initiates change” (Drach-Zahavy, and Somech, 2001, p. 112). Team learning behaviours are encouraged, or facilitated, by a shared feeling that the team is a psychologically safe place. Within psychologically safe environments, team members, both individually and collectively, are more likely to take time to improve the team’s work processes, to ask for help and advice, to seek information from other team members to make important changes, to speak up to test assumptions about issues under discussion, to invite people from outside the team to present information, to share experiences, and to have discussions about improvement issues (Edmondson, 1999; Edmondson and Lei, 2014).

Team learning contributes to team creativity (Drach-Zahavy and Somech, 2001; Edmondson and Lei, 2014) because team learning promotes information sharing and the cross-fertilization of ideas within the team, thereby increasing the knowledge and information available to team members, both

individually and collectively. This atmosphere allows and encourages the development of domain-relevant skills and creativity-relevant skills, which provide crucial background knowledge and serve as the basis for creativity (Amabile, 1996; Edmondson, 2004; Hirst et al., 2009; Sung and Choi, 2012; Yoon et al., 2010). Hence:

Hypothesis 1: *Team PsySafe has a positive indirect effect on team creativity through team learning behaviour.*

#### *Climate Strength as Moderator*

We anticipate that the I→P→O relationship is insufficient (Ilgen et al., 2005) to understand how team PsySafe predicts team creativity. We propose that the indirect relationship is conditionally based on how consistently the team members within the team experience team PsySafe and team learning behaviour. To support our hypotheses, we rely on the theory of climate strength (Schneider et al., 2002). While the climate level represents the *average* of individual perceptions within the team, climate strength (or consistency, which we use interchangeably) reflects a measure of *within-team variability* in climate perceptions (Luria, 2008; Schneider et al., 2013). The impact of team climate on team outcomes is enhanced in strong climates and attenuated in weak (or inconsistent) climates (Meyer et al., 2010). A stronger climate equips team members with clearer and more consistent information about the team (Lee and Dalal, 2016; Meyer et al., 2010) and is more likely to lubricate social and cognitive exchanges between team members. Therefore, as Schneider et al. (2013, p. 368) observed, “the more consistent the experiences of employees, the more likely employees are to behave consistently as a collective such that there should be more positive outcomes on the positive end and more negative outcomes on the low end”. Taking these arguments into account, we assert that the consistency of team PsySafe moderates the relationship between the level of team PsySafe and team learning behaviour.

Hypothesis 2: *The consistency (climate strength) of team PsySafe moderates the relationship between the level of team PsySafe and team learning behaviour, such that the relationship is stronger when the consistency of team PsySafe is higher versus lower.*

We propose a similar pattern for the relationship between team learning and team creativity. A more consistent experience of team learning behaviour within the team means that the exchange of information or ideas (Paulus et al., 2012) is more likely and that all team members, both individually and collectively, are more likely to share and develop knowledge and creative solutions. Hence our final hypothesis:

Hypothesis 3: *The consistency (climate strength) of team learning behaviour moderates the relationship between the level of team learning behaviour and team creativity, such that the relationship is stronger when the consistency of team learning behaviour is higher versus lower.*

## METHOD

### *Sample and Procedures*

We gathered data from a convenience sample of 79 team leaders from 27 organizations. The average team leader in the sample was female (59.5%), 43 years old (SD: 10.16), and had been in a team leader position for 7.24 years (SD: 5.15). The team leaders' educational backgrounds were as follows: 8.9% of leaders had nine or fewer schooling years, 27.8% had twelve schooling years, 55.7% had a university degree, and 7.6% had a graduate degree. We delivered a questionnaire to all team members, who anonymously reported perceptions of team PsySafe and team learning behaviour. Three hundred and seventeen members participated (75.1% female; mean age: 38.80 years, SD: 10.46; mean tenure in the team: 7.83 years, SD: 7.56), with a minimum of 3 responses per team. Team members' educational backgrounds include 19.9% with nine or fewer schooling years, 38.8% with twelve schooling years, 37.9% with a university degree, and 3.5% with a graduate degree. Before proceeding, a brief note on data analysis is necessary: each team was randomly split into two sub-samples, with one sub-sample used to assess team PsySafe and the other to assess team learning behaviour.

### *Measures*

All variables were measured with a 6-point Likert-type scale. Respondents reported the extent to which different statements applied to the team: (1) "the statement does not apply to this team at all"; (...); (6) "the statement applies completely to this team". Leaders reported team creativity. Team members reported team PsySafe and team learning behaviour. In line with a referent-shift composition model (Chan, 1998), the individual ratings were aggregated to the team level to represent team PsySafe and team learning behaviour.

*PsySafe.* Team PsySafe ( $\alpha = 0.74$ ) was measured through seven items (Edmondson, 1999; sample item: "It is safe to take a risk on this team").

*Team learning behaviour.* Team learning behaviour ( $\alpha = 0.93$ ) was measured through seven items (Edmondson, 1999; sample item: "We regularly take time to figure out ways to improve the team's work processes").

*Team creativity.* Team creativity was measured through thirteen items ( $\alpha = 0.96$ ) from Zhou and George (2001), adapted to the team level (sample item: "This team comes up with new and practical ideas to improve performance").

*Consistency of team PsySafe and team learning behaviour.* The standard deviation (SD) of individual scores within each team was calculated to measure the consistency of team PsySafe and team learning behaviour (LeBreton and Senter, 2008). The SD score was reversed. The emerging scores were named

consistency of team PsySafe and consistency of team learning behaviour. Higher scores represent greater consistency.

#### *Preliminary analysis*

The ICC1s for team PsySafe and team learning behaviour were 0.21 and 0.37, respectively. The ICC2s for team PsySafe and team learning behaviour were 0.51 and 0.70, respectively. The  $r_{wg(j)}$  values for team PsySafe (mean: 0.89) and team learning behaviour (mean: 0.86) represent “strong” inter-rater agreement (LeBreton and Senter, 2008, p. 836). Although the ICC2 for team PsySafe is below the recommended cut-off, it does not prevent aggregation (e.g., Bliese, 2000). We thus proceeded to aggregate our data for the two variables.

Considering the sample size, we used parcels (Little et al., 2002) when conducting confirmatory factor analyses to test discriminant validity among the constructs. Three parcels each for team PsySafe and team learning behaviour (data from different team members within each team), and four parcels for team creativity were created. Results indicated that the three-factor model fits the data well ( $\chi^2_{[32]} = 46.45$ ; RMSEA: 0.08; NNFI: 0.97; CFI and IFI = 0.98) and is superior to models in which (1) team PsySafe and team learning behaviour were set to load on a single factor ( $\Delta\chi^2_{[2]} = 44.44$ ,  $p \leq 0.001$ ), (2) team learning behaviour and team creativity were set to load on a single factor ( $\Delta\chi^2_{[2]} = 145.30$ ,  $p \leq 0.001$ ), and (3) all variables/parcels were set to load on a single factor ( $\Delta\chi^2_{[3]} = 212.92$ ,  $p \leq 0.001$ ).

## **FINDINGS**

Table 1 shows that team PsySafe correlates positively with team learning behaviour, which in turn correlates positively with team creativity. The consistency of team PsySafe correlates positively with both team learning behaviour and the consistency of team learning behaviour. The hypothesized model was tested through bias-corrected bootstrap analyses with the PROCESS macros developed by Hayes (2013). We first tested the mediated model without the moderators (template model #4) to assess the indirect effect proposed in H1. The findings show the following: (a) team PsySafe predicts team learning behaviour (effect: 0.51,  $p \leq 0.001$ ; SE: 0.13; LLCI: 0.24, ULCI: 0.78), (b) team learning behaviour, but not team PsySafe, predicts team creativity (effect: 0.26,  $p \leq 0.05$ ; SE: 0.11; LLCI: 0.04, ULCI: 0.48); (c) while the direct effect (effect: 0.13,  $p = 0.36$ ) is not significant (SE: 0.14; LLCI: -0.15, ULCI: 0.41), the indirect effect is (effect: 0.13,  $p \leq 0.05$ ; SE: 0.08; LLCI: 0.02, ULCI: 0.35). Therefore, H1 is supported.

	Mean	SD	1	2	3	4
1. Team PsySafe (a)	4.23	0.71	-			
2. Consistency of team PsySafe	0.75	0.32	0.11	-		
3. Team learning behaviour (a)	3.64	0.91	0.40***	0.24*	-	
4. Consistency of team learning behaviour	0.98	0.37	0.08	0.38***	0.11	-
5. Team creativity	3.99	0.85	0.22	-0.04	0.32**	0.02

Notes: (a). Different raters within the team to rate each variable. \* $p \leq 0.05$ , \*\* $p \leq 0.01$ , \*\*\* $p \leq 0.001$ .

Table 1. Means, standard deviations, and correlations

The interaction between team PsySafe and the consistency of team PsySafe predicts team learning behaviour (effect: 0.80,  $p \leq 0.05$ , SE: 0.32; LLCI: 0.16, ULCI: 1.44), and the interaction between team learning behaviour and the consistency of team learning behaviour predicts team creativity (effect: 0.70,  $p \leq 0.05$ , SE: 0.29; LLCI: 0.13, ULCI: 1.27). Then, we tested the moderated mediation model (template model #21, Hayes, 2013). While the direct effect (0.00,  $p = 0.99$ ) of team PsySafe on team creativity is not significant (SE: 0.15; LLCI: -0.30, ULCI: 0.29), the following conditional indirect effects were found (Table 2): (a) when the consistency of team PsySafe and/or the consistency of team learning behaviour are low, no significant effect is found; (b) as the consistency of team PsySafe and/or the consistency of team learning behaviour increase, the effect also increases; and (c) the indirect effect is the strongest when both the consistency of team PsySafe and the consistency of team learning behaviour are high.

Consistency of team PsySafe (mean and plus/minus one SD from mean)	Consistency of team learning behaviour	Effect	Bootstrap SE	Bias corrected 95% confidence interval [lower, upper]
Low	Low	0.02	0.06	[-.05, 0.19]
Low	Middle	0.11	0.07	[0.00, 0.29]
Low	High	0.20	0.12	[0.01, 0.48]
Middle	Low	0.04	0.10	[-0.11, 0.26]
Middle	Middle	0.20	0.09	[0.05, 0.40]
Middle	High	0.35	0.13	[0.15, 0.66]
High	Low	0.06	0.14	[-0.17, 0.38]
High	Middle	0.28	0.12	[0.07, 0.54]
High	High	0.50	0.18	[0.21, 0.93]

Table 2. Conditional indirect effects

To help interpret the interaction, we split the sample into three levels (mean and plus/minus one SD) of consistency of both moderators. Next, we carried out regression analyses for each level. Figure 2 shows that the effect of team PsySafe on team learning behaviour is stronger versus weaker when the consistency of team PsySafe is higher versus lower.

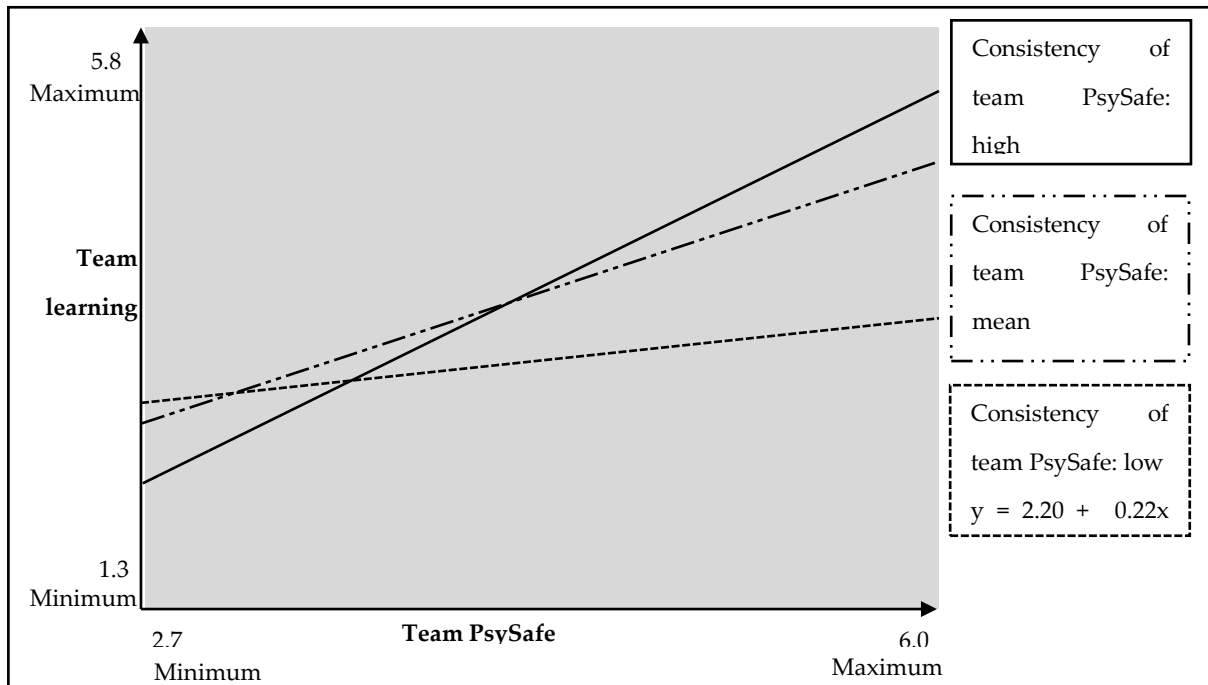

Figure 2. How the level of team PsySafe interacts with the consistency of team PsySafe to predict team learning behaviour.

Figure 3 indicates that the effect of team learning behaviour on team creativity is stronger versus weaker when the consistency of team learning behaviour is stronger versus weaker. The highest level of team learning behaviour emerges when there is *high* consensus within the team about the team PsySafe. The highest level of team creativity emerges when there is *high* consensus within the team regarding the team learning behaviour. Findings support H2 and H3.

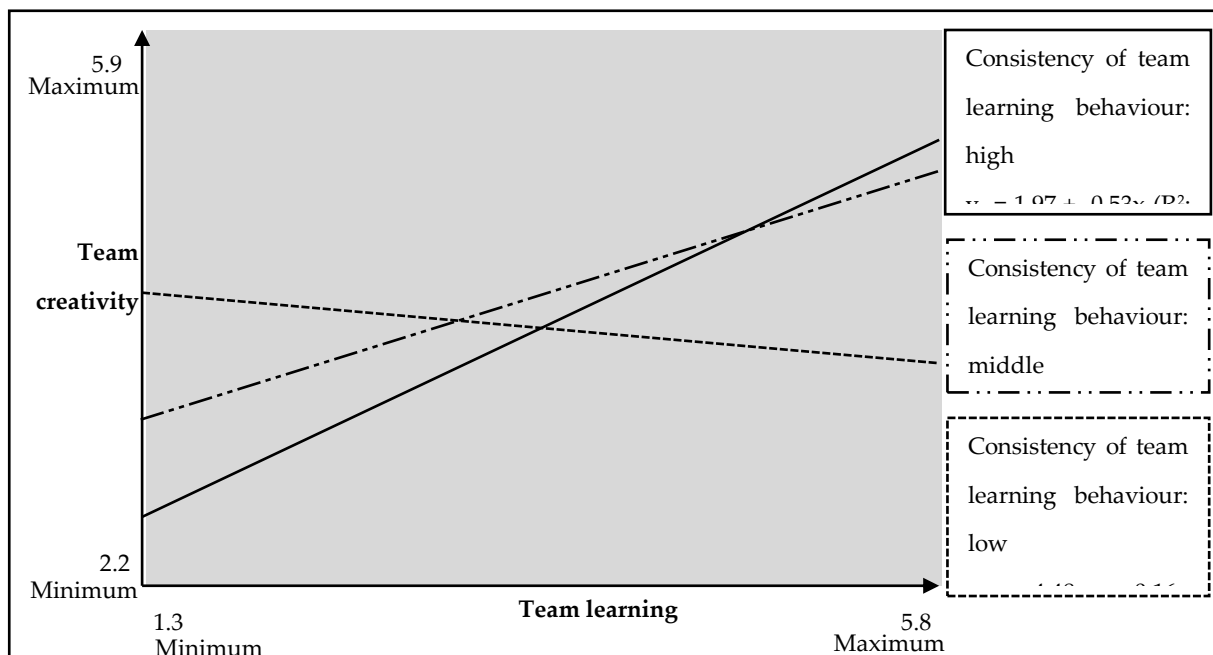

Figure 3. How the level of team learning interacts with the consistency of team learning to predict team creativity.



## DISCUSSION AND CONCLUSION

### *Main Findings and Contributions*

It is fairly well established in the literature that teams with high levels of PsySafe are more creative than teams low in PsySafe (e.g., Edmondson and Lei, 2014; Kark and Carmeli, 2009; Paulus et al., 2012), yet researchers studying this relationship clearly state the need for more research that identifies boundary conditions as well as the mechanisms through which the effect takes place (Paulus et al., 2012). In this research, we make a theoretical case for team learning behaviour as one of those mechanisms, with our results indicating a significant indirect effect. PsySafe facilitates team learning processes that allow individual creativity to expand to the team level, ultimately resulting in higher levels of creativity for the team.

As noted previously, the IPO model of team effectiveness does not fully account for the relationship between team PsySafe and team creativity, especially considering the weak meta-analytic relationship between the two variables (Frazier et al., 2017). Our research relied on climate strength theory to expand the IPO model and demonstrate how the relationships are conditional based on consistency of team PsySafe and team learning behaviour. Specifically, the relationship between team PsySafe and team learning is stronger when team members rate the team PsySafe more consistently. The relationship between team learning and team creativity is also stronger when all team members experience team learning in a consistent way. Research on the climate strength of team PsySafe and team learning is scant in the extant literature, and our empirical evidence helps to fill that gap while addressing the conditional relationship between team PsySafe and team creativity. Our findings also contribute to the climate strength literature, again demonstrating that stronger climates strengthen the relationship between the mean level of the climate and outcome variables (Meyer et al., 2010).

### *Limitations and Future Studies*

The study is not exempt of limitations. First, the sample is small, and some teams were rated by a small number of individuals. Future studies should include a larger sample of teams, ideally with at least six participants. The independent and the mediating variables could then be rated by at least three raters each. Second, the type of teams was not taken into account. Future studies should test if variables related to team complexity (e.g., tasks, goals, roles, process emphasis, performance demands, task environment, and workflow interdependence; Edmondson and Lei, 2014; Kozlowski and Bell, 2003) moderate the indirect relationship studied here. Other moderators may also intervene (e.g., the member's identification with the team may moderate the relationship between team PsySafe and team learning; Edmondson et al., 2007).

Another limitation of this study is that data were collected at a single time point. Future studies should adopt a longitudinal design. Fourth, although the hypothesized model ( $I \rightarrow P \rightarrow O$ ) follows existing theory and intuitively makes sense, other causalities are also plausible. For example, the output (i.e., team creativity) may influence the input (i.e., team PsySafe) (Ilgen et al., 2005; Marks et al., 2001; Paulus et al., 2012), in that team members who operate in creative teams may develop the sense that it is psychologically safe to speak up or share additional ideas. Future research set in a lab can test and confirm the causal nature of the relationships.

For future research, we also recommend the inclusion of antecedents of team PsySafe, of which leadership might be particularly important (Frazier et al., 2017). Finally, our study was conducted in a single culture. Considering that cultural variables may affect the entire process of creativity (Anderson et al., 2014), future studies should also collect data in different cultures and test how the cultural context operates as a boundary condition (Edmondson and Lei, 2014).

### *Conclusion*

Considering that team creativity is crucial for team innovation and effectiveness, our study informs the literature on the antecedents and processes that lead to team effectiveness. This research also suggests that a high level of team PsySafe is not enough to stimulate team creativity through team learning; it is also necessary that the team members have consistent perceptions of team PsySafe and team learning to fully reap the creativity benefits.

## **ACKNOWLEDGEMENTS**

This work was supported by Fundação para a Ciência e a Tecnologia, grant **UID/GES/00315/2013**.

## **REFERENCES**

- Amabile, T. M. (1996), *Creativity in context*. Westview, Boulder, CO.
- Amabile, T. M., Conti, R., Coon, H., Lazenby, J. and Herron, M. (1996), "Assessing the work environment for creativity", *Academy of Management Journal*, Vol. 39 No. 5, pp. 1154–1184.
- Anderson, N., Potocnik, K. and Zhou, J. (2014), "Innovation and creativity in organizations: A state-of-the-science review, prospective commentary, and guiding framework", *Journal of Management*, Vol. 40 No. 5, pp. 1297-1333.
- Bechtoldt, M. N., De Dreu, C. K. W. and Choi, H.-S. (2010), "Motivated information processing, social tuning, and group creativity", *Journal of Personality and Social Psychology*, Vol. 99 No. 4, pp. 622-637.
- Bliese, P. D. (2000), "Within-group agreement, non-independence, and reliability: Implications for data aggregation and analysis", in Klein, K. J. and Kozlowski, S. W. (Eds.), *Multilevel theory, research, and methods in organizations*, Jossey-Bass, San Francisco, pp. 349-381
- Carmeli, A., Reiter-Palmon, R. and Ziv, E. (2010), "Inclusive leadership and employee involvement in creative tasks in the workplace: The mediating role of psychological safety", *Creativity Research Journal*, Vol. 22, pp. 250–260.
- Carmeli, A. and Spreitzer, G. (2009), "Trust, connectivity, and thriving: Implications for innovative behaviors at work", *Journal of Creative Behavior*, Vol. 43 No. 3, 169-191.

- Chan, D. (1998), "Functional relations among constructs in the same content domain at different levels of analysis: A typology of composition models", *Journal of Applied Psychology*, Vol. 83 No. 2, pp. 234-246.
- Drach-Zahavy, A. and Somech, A. (2001), "Understanding team innovation: The role of team processes and structures", *Group Dynamics: Theory, Research, and Practice*, Vol. 5 No. 2, pp. 111-123.
- Edmondson, A. (1999), "Psychological safety and learning behavior in work teams", *Administrative Science Quarterly*, Vol. 44 No. 2, pp. 350-383.
- Edmondson, A. C. and Lei, Z. (2014), "Psychological safety: The history, renaissance, and future of an interpersonal construct", *Annual Review of Organizational Psychology and Organizational Behavior*, Vol.1, pp. 23-43.
- Edmondson, A. C., Dillon, J. R. and Roloff, K. S. (2007), "Three perspectives on team learning: Outcome improvement, task mastery, and group process", *The Academy of Management Annals*, Vol. 1 No. 1, pp. 269-314.
- Edmondson, A.C. (2004), "Psychological safety, trust, and learning in organizations: a group-level lens", in Kramer, R. M. and Cook, K. S. (Eds.), *Trust and distrust in organizations: Dilemmas and approaches*, Russell Sage, New York, NY, pp. 239-272.
- Frazier, M. L., Fainshmidt, S., Klinger, R. L., Pezeshkan, A. and Vracheva, V. (2017), "Psychological safety: A meta-analytic review and extension", *Personnel Psychology*, Vol. 70 No. 1, pp. 113-165.
- González-Romá, V., Fortes-Ferreira, L. and Peiró, J. M. (2009), "Team climate, climate strength and team performance. A longitudinal study", *Journal of Occupational and Organizational Psychology*, Vol. 82, pp. 511-536.
- González-Romá, V., Peiró, J. M. and Tordera, N. (2002), "An examination of the antecedents and moderator influences of climate strength", *Journal of Applied Psychology*, Vol. 87 No. 3, pp. 465 - 473.
- Hayes, A. F. (2013). *Introduction to mediation, moderation, and conditional process analysis*. Guilford Press, New York.
- Hirst, G., van Knippenberg, D. and Zhou, J. (2009), "A cross-level perspective on employee creativity: Goal orientation, team learning behavior, and individual creativity", *Academy of Management Journal*, Vol. 52 No. 2, pp. 280-293.
- Hulsheger, V., Anderson, N. and Salgado, J. (2009), "Team-level predictors of innovation at work: A comprehensive meta-analysis spanning three decades of research", *Journal of Applied Psychology*, Vol. 94 No. 5, pp. 1128-1145.
- Ilgen, D. R., Hollenbeck, J. R., Johnson, M. and Jundt, D. (2005), "Teams in organizations: From input-process-output models to IMO models", *Annual Review of Psychology*, Vol. 56, pp. 517-543.
- Kark, R. and Carmeli, A. (2009), "Alive and creating: The mediating role of vitality and aliveness in the relationship between psychological safety and creative work involvement", *Journal of Organizational Behavior*, Vol. 30 No. 6, pp. 785-804.
- Kozlowski, S. W. J., and Bell, B. S. (2003), "Work groups and teams in organizations", in Borman, W.C., Ilgen, D. R. and Klimoski, R. J. (Eds.), *Handbook of Psychology: Industrial and Organizational Psychology*, Wiley, New York, NY, pp. 333-375.
- Kozlowski, S. W. J., Mak, S. and Chao, G. T. (2016), "Team-centric leadership: An integrative review", *Annual Review of Organizational Psychology and Organizational Behavior*, Vol. 3, pp. 21-54
- LeBreton, J. M. and Senter, J. L. (2008), "Answers to 20 questions about interrater reliability and interrater agreement", *Organizational Research Methods*, Vol. 11 No. 4, pp. 815-852.
- Lee, S. and Dalal, R. S. (2016), "Climate as situational strength: Safety climate strength as a cross-level moderator of the relationship between conscientiousness and safety behaviour", *European Journal of Work and Organizational Psychology*, Vol. 25 No. 1, pp. 120-132.
- Little, T. D., Cunningham, W. A., Shahar, G. and Widaman, K. F. (2002), "To parcel or not to parcel: Exploring the question, weighing the merits", *Structural Equation Modeling*, Vol. 9 No. 2, pp. 151-173.
- Luria, G. (2008), "Climate strength – How leaders form consensus", *The Leadership Quarterly*, Vol. 19 No. 1, pp. 42-53.
- Marks, M.A., Mathieu, J. E. and Zaccaro, S. J. (2001), "A temporally based framework and taxonomy of team processes", *Academy of Management Review*, Vol. 26 No. 3, pp. 356-376.
- Meyer, R. D., Dalal, R. S. and Hermida, R. (2010), "A review and synthesis of situational strength in the organizational sciences", *Journal of Management*, Vol. 36 No. 1, pp. 121-140.
- Oldham, G. R. and Cummings, A. (1996), "Employee creativity: Personal and contextual factors at work", *Academy of Management Journal*, Vol. 39 No. 3, pp. 607-634.
- Oldham, G. R. and Baer, M. (2012), "Creativity and the work context", in Mumford, M. D. (Ed.), *Handbook of Organizational Creativity*, Academic Press London, pp. 387-420.

- Paulus, P. B., Dzindolet, M., and Kohn, N. W. (2012), "Collaborative creativity – Group creativity and team innovation", in Mumford, M. (Ed.), *Handbook of organizational creativity*, Academic Press, London, pp. 295-326.
- Rego, A., Reis Júnior, D., Cunha, M. P., Stallbaum, G. and Neves, P. (2014), "Store creativity mediating the relationship between affective tone and performance", *Managing Service Quality*, Vol. 24 No. 1, pp. 63-85.
- Reiter-Palmon, R., Wigert, B., de Vreede, T. (2012), "Group composition, social processes, and cognitions" in Mumford, M. (Ed.), *Handbook of organizational creativity*, Academic Press, London, pp.327-358.
- Schneider, B., Ehrhart, M. G. and Macey, W. H. (2013), "Organizational climate and culture", *Annual Review of Psychology*, Vol. 64, pp. 361-388.
- Schneider, B., Salvaggio, A. N. and Subirats, M. (2002), "Climate strength: A new direction for climate research", *Journal of Applied Psychology*, Vol. 87 No. 2, pp. 220-229.
- Sung, S. Y. and Choi, J. N. (2012), "Effects of team knowledge management on the creativity and financial performance of organizational teams", *Organizational Behavior and Human Decision Processes*, Vol. 118, pp.4-13.
- West, M.A., and Richter, A. (2008), "Climates and cultures for innovation and creativity at work", in Zhou, J. and Shatley, C. E. (Eds.), *Handbook of organizational creativity*, Erlbaum, New York, NY, pp. 211-237.
- Woodman, R. W., Sawyer, J. E. and Griffin, R. W. (1993), "Toward a theory of organizational creativity", *Academy of Management Review*, Vol. 18 No. 2, pp. 293-321.
- Yammarino, F. J., Dionne, S. D., Schriesheim, C. A. and Dansereau, F. (2008), "Authentic leadership and positive organizational behavior: A meso, multi-level perspective", *The Leadership Quarterly*, Vol. 19 No. 6, pp. 693-707.
- Yoon, S. W., Song, J.H., Lim, D.H. and Joo, B.K. (2010), "Structural determinants of team performance: The mutual influences of learning culture, creativity, and knowledge", *Human Resource Development International*, Vol. 13 No. 3, pp. 249-264.
- Zhou, J. and George, J. M. (2001), "When job dissatisfaction leads to creativity: Encouraging the expression of voice", *Academy of Management Journal*, Vol. 44 No. 4, pp. 682-696.

## **E-COMMERCE STUDIES REVIEW: IMPLICATIONS AND FUTURE AGENDA FOR FIRMS AND CONSUMERS**

**Resciniti, Riccardo<sup>1</sup>; Matarazzo, Michela<sup>2</sup>; De Vanna, Federica<sup>1</sup>**

<sup>1</sup>University of Sannio, Benevento, Italy

<sup>2</sup>Marconi University, Rome, Italy

### **ABSTRACT**

In this paper, we present a literature review and classification scheme for electronic commerce research. The former consists of approximately 130 journal articles published in journals that are inherent marketing researches. The results show that an increasing volume of EC research has been conducted for a diverse range of areas. The articles are presented, based on a scheme that consists of a 2x2 matrix: the application area and the trade-off between the results and the gaps.

Keywords: e-commerce; online shopping; internationalization.

### **INTRODUCTION**

Globalization and information technologies (IT) are radically changing the face of business and organization. IT are being adopted and incorporated into nearly all organizations, which have invested heavily in IT infrastructure for the overall success of their business. There is a growing interest in the use of electronic commerce as a means to perform business transactions. For many businesses, it has become a priority and companies are making large investments in e-commerce applications but are pressed to evaluate the success of their e-commerce systems.

The online opportunities have led firms to consider the Internet as both a replacement of other channels and as an integration of pre-existing ones. The major evidences in literature suggest that small and medium sized enterprises (SMEs) use it as a cheap and effective way to enter new markets and reduce the perceived cultural barriers. In literature, the evidences about the e-commerce and the online channel seem already confused. Another part of the studies focuses on the demand side of the market and tries to analyse the characteristics and the variables that affect consumers' intention to shop online. In particular, researchers want to understand how consumers choose the store where to shop and what affects their decision. These studies combine factors that are found to influence the consumer's purchasing decision in online and offline stores for apparels. It includes the price attractiveness, time saving, perceived risk, enjoyment and excitement, tangibility and high

interactivity. All of these factors will contribute to the study of customer's purchasing intention for apparels on both stores which includes online and offline shopping. Online marketers or retailers should be aware of the problems faced by the consumers and their perceived risk to increase their intention to shop in online.

The purpose of this paper is to examine the literature about these themes and gain a full comprehension of the gaps in research about e-commerce. In order to make this review fruitful, a model is developed.

This review will provide a source for anyone interested in EC research and help simulate further interest. The study wants to make a photograph of the state of the art and create an organic framework of the results that are presented in literature, by providing new tracks and questions for researchers.

## **METHODOLOGY**

The studies considered have been chosen according to these criteria:

- They belong to A journals in marketing and management;
- They are published from 2013 to 2017.

After reading the articles, the studies have been classified basing on a scheme that consists of a 2x2 matrix: the application area and the trade-off between the results and the gaps.

## **CONSUMER RESEARCH**

### *Consumer behaviour*

The advent of electronic commerce has revolutionized the way business is done by providing consumers with a plethora of information sources and convenient shopping methods. It has increased business offerings (i.e., goods and services) and has given online shoppers the option and ability to switch effortlessly from one website to another.

Recent industry trends involve reducing customer acquisition costs and increasing customer retention rates. Yet, several companies still suffer from rising e-commerce customer acquisition costs and falling sales and have failed to reduce operating costs and fulfill online customer needs (Bilgihan and Bujisic, 2015). The continued prosperity of e-commerce markets depends on retaining customers who shop online (Huang and Benyoucef, 2013) and converting a potential customer's initial online encounter into a buying relationship.

Visitors' evaluation and purchase intentions are determined by the fit between the shopping experiences offered (hedonic vs. utilitarian) and visitors' regulatory focus (promotion vs. prevention). Furthermore, engagement, perceived usefulness, and perceived ease of use serve as the underlying

mechanisms that mediate the effect of regulatory fit on visitors' attitudes and purchase intentions. When shoppers are task-focused, they visit online stores for the purpose of product acquisition. When shoppers are experiential, they engage in shopping activities for seeking thrills, adventure, disinhibition, new experiences, fantasies, cognitive or sensory stimulation, and escape from boredom. A recent study by Pappas et al. (2016) reports that strongly positive emotions such as pleasure and enjoyment are core conditions for achieving high level of purchase intention. Task-focused shoppers, compared to experiential shoppers, are more likely to tolerate lower quality products when low acquisition costs can compensate for a reduction in quality. Experiential shoppers are more oriented toward the activity itself and derive gratification from affective experiences.

Panda and Swar (2014) identified four factors, namely anxiety, ease of use, usefulness and price, as the determinants of shopper buying behaviour online. Anxiety is the most important factor in online shopping. Price, though an important factor, does not influence shoppers as the other variables. Motwani (2016) explores the factors affecting consumers' decision to shop online, and how the decision can be affected by product type. Ease of use is an encouraging factor to buy online. It was also found that products such as movies, music and video games are more acceptable items for online shopping. The findings of Safari & Thilenius (2013) analyzed consumers' perceived uncertainty and trust when purchasing from foreign online retailers that occur from the lack of information about the legal system, specific national customer rights, language difficulties, and from complexity of product returns. Web portals can assume the role of an intermediary of trust. They influence the consumer's trust in an online shop in a positive way and present themselves as an effective instrument for building trust in the Internet distribution channel. The positive effect of intermediaries of trust can be generalized and applied to other central constructs of purchase behaviour. The use of an intermediary of trust reduces the perceived risk and improves the consumer's attitude toward the online shop. Similarly, the attitude toward the product and the purchase intention can be significantly increased by the use of an intermediary of trust due to holistic image transfer effects. The stronger the trustworthiness and the brand image of the intermediary, the more positive the effects caused by the existence of the intermediary of trust. The stronger the reputation and trustworthiness of an intermediary of trust, the more positive the transfer effect on the online shop.

#### *Technical aspects: websites*

Research extensively examines the relationship between website elements and their influence on usage intentions, online behavior, and overall system satisfaction (Dickinger & Stangl, 2013). In the

context of online business, website homepages are arguably the “first contact” points between firms and their potential customers, and they offer varying experiences based on their functionality and appeal. Experiences offered online (e.g., easy product search and evaluation, up-to-date information, visually appealing interface, fun and enjoyable, etc.) are not only the primary asset that customers look for while making decisions, but they also shape their initial impressions of a website and subsequent adoption or exploration. Research has shown that online customers’ (unlike offline customers’) acquisition is dependent, at least in part, on their initial impression of the website homepage (Campbell et al., 2013).

Chiu et al. (2014) discuss the term “web atmospherics” to describe the web design elements that constitute the primary drivers of online behavior. Al-Qeisi et al. (2014) examine the key characteristics of website design quality from the user's perspective and propose an influence of the website on attitudes and purchase intentions of web consumers. The first component of this model is the technical dimension, which refers to website characteristics such as security, ease of navigation, search facilities, site availability, valid links, personalization or customization, speed of page loading, interactivity, and ease of access. The second component is the general content, which includes characteristics such as content usefulness, completeness, clarity, currency, conciseness, and accuracy. The third component is the specific content, which entails characteristics such as contact information, general company information, product/service details, consumer policies, and customer support. The final component is the appearance, which refers to characteristics such as attractiveness, organization, proper use of fonts, colors, and proper use of multimedia. Attitude toward website (AST) measures a consumer's predisposition to respond favorably or unfavorably to web content. Important drivers of AST are emotion-based evaluations of website atmospherics, such as entertainment (e.g., fun to browse, exciting) or effectiveness (e.g., convenient, accurate) (Mazaheri et al., 2011). Therefore, higher AST may result from emotions that consumers feel when using a website congruent with their cultural selves. In addition, particularly on the Internet, which lacks physical surroundings or human touch, brands play an important role in the development of site attitudes and trust.

Past researchers have conceptualized websites as hedonic and utilitarian and argued that in order to attract customers e-retailers should incorporate the online shopping entertainment attributes along with functional attributes (Al-Qeisi et al., 2014). E-retailers should use a high level of aesthetic formality when website visitors are pursuing a purchase task, whereas a high aesthetic appeal should be used when website visitors do not have an immediate shopping goal. Websites offering utilitarian experiences facilitate consumers’ information processing and goal-attainment and are positively associated with the effectiveness of the website (Cyr and Head, 2013), whereas websites offering hedonic experiences furnish sensory gratification and are positively associated with enjoyment (Al-



Qeisi et al., 2014). That is, utilitarian websites have been shown to satisfy utilitarian and more pragmatic needs (Chang and Tseng, 2013). In contrast, hedonic websites have been shown to satisfy hedonic and more affective needs. Recently, some scholars have studied the concept of online store image. Chang and Tseng (2013) regarded website image as a collective perception and concluded that website image has a significant influence on consumers' behavior.

## **FIRMS' STUDIES**

### *The benefits of the Internet for firms*

Studies show that the Internet has a positive effect on firm information availability and the development of business networks in international markets, as well as an improvement in firm performance. The Internet allows organizations to establish a direct interface with customers and suppliers and provides export marketers with Internet marketing capabilities by strengthening advertising, sales, market research, service, and procurement. The availability of export information and the development of business network relationships are seen to facilitate the development of organizational capabilities, such as marketing research capacity or customer relationship ability. Glavas and Mathews (2014) suggests that the Internet can substantially improve communication with actual and potential international customers, suppliers, and partners. The Internet generates a wealth of information on worldwide market trends and can also be a very powerful promotion and sales tool. The Internet facilitates conducting export business and supports promotion, information delivery, and export revenue growth. Additionally, the Internet can be an efficient tool to reduce entry costs and provide relevant information, which may help to increase relationship development. However, accumulating valuable resources is not enough to achieve a competitive advantage (Lin and Wu, 2014) and investments in information and communication technology may not necessarily benefit firms. Internet technology as a resource is easily imitable and does not necessarily lead to a competitive advantage for firms. Bianchi and Mathews (2016) examine the value of technology resources and find that the Internet's impact on other complementary firm-level capabilities positively influences firm performance by improving customer retention and satisfaction. Thus, embedding the Internet within organizational processes can generate a competitive advantage, which in turn impacts a firm's performance.

Typical disadvantages of SMEs such as resource constraints, lack of appropriate strategic planning and difficulties in expanding market share could hence be overcome by the Internet. For instance, by building different, inter-organizational systems on the Internet to facilitate and support inter-organizational relationships, small businesses can assist each other to access potential markets which would otherwise require expensive market research and communications campaigns. The Internet

does not only help SMEs to begin to internationalize but in helping to maintain a strong position in foreign markets through such activities as marketing intelligence, global sales promotion and inter-firm R&D. In fact, because it is a gateway to foreign markets, the Internet enables SMEs to become international whether it was planned or not. The Internet provides such activities the same as marketing intelligence, global sales promotion and communications. Unfortunately, the advantages conferred by Internet seldom meet the high expectations. Relatively few foreign markets can be penetrated by SMEs using the Internet alone. Except for standardized products or commodities, the Internet has not been able to replace the person-to-person contact generally required to build the necessary trust for successful international transactions. For many products the Internet cannot replace physical distribution channels. Moreover the Internet exposes SMEs to global and greater competition, particularly regarding price.

#### *The impact of Internet on internationalization*

An increasing number of studies emphasize the importance of the Internet in firms' international activities (Biamchi and Mathews, 2016). Specifically, the Internet supports the international expansion of exporters, and increases international market growth of firms. Reuber and Fischer (2014) find that firm resources such as Internet technology are pivotal in the pursuit of international marketing opportunities. Other ways in which the Internet can help improve export performance is by finding the right overseas agent, gathering market intelligence to aid export planning, and electronic communication to support networks. The Internet also enables firms to reach potential clients around the world, making the Internet a relatively inexpensive form of marketing. Beck and Rigl (2015) argue that firms use the Internet to generate revenue by selling more to existing customers and by attracting new customers because neither location nor time constrains the Internet.

Therefore, internet technology has become an effective tool in conducting successful business particularly in developed country markets. The firms are benefited from the Internet as it significantly helps in developing communications with new and current importers, suppliers and agents in the value chain. As Frackiewicz and Grzesiuk (2013) suggest, the benefits offered by the Internet to small firms include image improvement, cost cutbacks, increased sales and access to market research, eventually making their entry into international markets quick and cost effective. As suggested the use of the Internet in exporting enables firms to leapfrog the traditional stages of internationalisation as it carries the potential to remove all export impediments such as psychic distance, practical export problems, resource constraints, trade restrictions and market risks. The Net reduces the export barriers for small firms. Nevertheless, the owner/managers of the firms play a crucial role in determining the extent of the knowledge that supports the international activities of the firm.

Sinkovics et al. (2013) also suggest the existence of such virtual export channels with the use of creative web sites which interface with existing channels for exporting.

Small firms in the international business need to understand the culturally diverse population since such awareness of the differences can help small firms to adopt appropriate e-commerce dealings. A number of literature highlights that e-commerce among businesses in the world are also challenged by the different legal support systems available for virtual transactions and certification requirements among different countries. The properties of e-commerce are sometimes described in terms of the 'death of distance'. However, the reduction in psychic distance due to online interaction also carries the danger of falling into what we call the 'virtuality trap', that is a perception by the internationalising firm that the learning generated through virtual interactions obviates the need for learning about the target markets through non-virtual means.

## DISCUSSION

According to the studies that we have read, we have developed the following framework:

Unit of analysis	Object of analysis INTERNATIONALIZATION		
<u>Consumers</u>	Evaluate different perceived images for products in store and online	Evaluate the mediating role of COO and Country variable in the store choice	Technology acceptance model for the various cultures
State of the art	Consumers perceive differently products among different retailers (Escobar-Rodriguez and Bonson-Fernandez, 2015; Thakur and Srivastava, 2014)	Customer evaluate in different ways store choice (Escobar-Rodriguez and Bonson-Fernandez, 2015; Thakur and Srivastava, 2014)	Culture influences attitude and purchase intention on websites (Ashraf et al., 2014; Capece et al., 2013)
Future studies	Study on the different perceived images in various cultures	COO as a mediator	There is a need for studies that consider other culture dimensions and in different countries

Unit of analysis	Object of analysis INTERNATIONALIZATION		
<u>Firms</u>	Effects of e-commerce on export performance	Effects of e-commerce on IDE	Effects of e-commerce on foreign relations (alliances and network)
State of the art	The studies confirm that e-commerce firms improve their export performances (Penttinen, 2015; Amarasena, 2010)	E-commerce firms more likely engage in foreign direct investments because of a risk perception reduction (Yadav, 2014; Bianchi and Mathews, 2013)	E-commerce firms improve their relations with foreign partners (Penttinen, 2015; Skudiene et al., 2015; Amarasena, 2010; )
Future studies	Studies on factors antecedents of the performance improvement and comparison countries' studies	Studies on the antecedents of the perceived risk reduction	Request for longitudinal comparative studies and different type of firms

In this framework we can identify the state of the art in the specific issue and the future studies needed. So, there is obviously a major need for studies that consider cultural variables and that involve more countries.

## CONCLUSIONS

Globalization and information technologies (IT) are radically changing the face of business and organization. There is a growing interest in the use of electronic commerce as a means to perform business transactions. For many businesses, it has become a priority and companies are making large investments in e-commerce applications but are pressed to evaluate the success of their e-commerce systems. The online opportunities have led firms to consider the Internet as both a replacement of other channels and as an integration of pre-existing ones. However, in literature, the evidences about the e-commerce and the online channel seem already confused. Another part of the studies focuses on the demand side of the market and tries to analyse the characteristics and the variables that affect consumers' intention to shop online. In particular, researchers want to understand how consumers choose the store where to shop and what affects their decision. These studies combine factors that are found to influence the consumer's purchasing decision in online and offline stores for apparels. It includes the price attractiveness, time saving, perceived risk, enjoyment and excitement, tangibility and high interactivity. All of these factors will contribute to the study of customer's purchasing intention for apparels on both stores which includes online and offline shopping. Online marketers or retailers should be aware of the problems faced by the consumers and their perceived risk to increase their intention to shop in online.

This paper has examined the literature about these themes in order to gain a full comprehension of the gaps in research about e-commerce. In order to make this review fruitful, a model is developed.

This review will provide a source for anyone interested in EC research and help simulate further interest.

## REFERENCES

- Al-Qeisi, K., Dennis, C., Alamanos, E., and Jayawardhena, C. (2014), "Website design quality and usage behavior: Unified Theory of Acceptance and Use of Technology.", *Journal of Business Research*, Vol. 67 No. 11, pp. 2282-2290.
- Beck, N., and Rygl, D. (2015), "Categorization of multiple channel retailing in multi-, cross-, and omni-channel retailing for retailers and retailing.", *Journal of Retailing and Consumer Services*, Vol. 27, pp. 170-178.
- Bianchi, C., and Mathews, S. (2016), "Internet marketing and export market growth in Chile.", *Journal of Business Research*, Vol. 69 No. 2, pp. 426-434.
- Bilgihan, A., and Bujisic, M. (2015), "The effect of website features in online relationship marketing: A case of online hotel booking.", *Electronic Commerce Research and Applications*, Vol. 14 No. 4, pp. 222-232.
- Campbell, D. E., Wells, J. D., and Valacich, J. S. (2013), "Breaking the ice in B2C relationships: Understanding pre-adoption e-commerce attraction.", *Information Systems Research*, Vol. 24 No. 2, pp. 219-238.
- Chang, E. C., and Tseng, Y. F. (2013), "Research note: E-store image, perceived value and perceived risk.", *Journal of Business Research*, Vol. 66 No. 7, pp. 864-870.
- Chiu, C. M., Wang, E. T., Fang, Y. H., and Huang, H. Y. (2014), "Understanding customers' repeat purchase intentions in B2C e-commerce: the roles of utilitarian value, hedonic value and perceived risk.", *Information Systems Journal*, Vol. 24 No. 1, pp. 85-114.
- Cyr, D., and Milena, H. (2013), "The impact of task framing and viewing timing on user website perceptions and viewing behavior.", *International Journal of Human-Computer Studies*, Vol. 71 No. 12, pp. 1089-1102.
- Dickinger, A., and Stangl, B. (2013), "Website performance and behavioral consequences: A formative measurement approach.", *Journal of Business Research*, Vol. 66 No. 6, pp. 771-777.
- Fischer, E., and Reuber, A. R. (2014), "Online entrepreneurial communication: Mitigating uncertainty and increasing differentiation via Twitter.", *Journal of Business Venturing*, Vol. 29 No. 4, pp. 565-583.
- Frackiewicz, E., and Grzesiuk, A. (2013), "Model of the SME's internationalization through e-commerce. Preliminary verification and development of the model.", *International Journal of Management Cases*, Vol. 15 No. 2, pp. 59-76.
- Glavas, C., and Mathews, S. (2014), "How international entrepreneurship characteristics influence Internet capabilities for the international business processes of the firm.", *International Business Review*, Vol. 23 No. 1, pp. 228-245.
- Huang, Z., and Benyoucef, M. (2013), "From e-commerce to social commerce: A close look at design features.", *Electronic Commerce Research and Applications*, Vol. 12 No. 4, pp. 246-259.
- Lin, Y., and Wu, L. Y. (2014), "Exploring the role of dynamic capabilities in firm performance under the resource-based view framework.", *Journal of business research*, Vol. 67 No. 3, pp. 407-413.
- Mazaheri, E., Richard, M. O., Laroche, M., and Ueltschy, L. C. (2014), "The influence of culture, emotions, intangibility, and atmospheric cues on online behavior.", *Journal of Business Research*, Vol. 67 No. 3, pp. 253-259.
- Motwani, B. (2016), "Prediction of Buying Intention for Online Shopping: An Empirical Study.", *IUP Journal of Marketing Management*, Vol. 15 No. 4, pp. 7.
- Panda, R., Swar, B. N., and Mukerjee, K. (2014), "Factors affecting brand trust: An exploratory investigation among Indian retail consumers.", *Indian Journal of Marketing*, Vol. 44 No. 7, pp. 7-17.
- Pappas, I. O., Kourouthanassis, P. E., Giannakos, M. N., and Chrissikopoulos, V. (2016), "Explaining online shopping behavior with fsQCA: The role of cognitive and affective perceptions.", *Journal of Business Research*, Vol. 69 No. 2, pp. 794-803.
- Safari, A., and Thilenius, P. (2013), "Alleviating uncertainty through trust: A narrative approach to consumers' foreign online purchasing behaviour.", *Journal of Customer Behaviour*, Vol. 12 No. 2-3, pp. 211-226.
- Sinkovics, N., Sinkovics, R. R., and "Bryan" Jean, R. J. (2013), "The internet as an alternative path to internationalization?.", *International Marketing Review*, Vol. 30 No. 2, pp. 130-155.

**VENTURE CAPITALIST'S INTERVENTION AND THE  
INTERNATIONALIZATION OF INTERNATIONAL NEW VENTURES  
(INVS) – PORTUGUESE CASE STUDY**

**Ribeiro, Paulo; Meneses, Raquel**

Faculty of Economics of Porto, University of Porto, UP, Porto, Portugal

**ABSTRACT**

The internationalization process is widely believed to be one of the most relevant dimensions in companies across countries. Nevertheless, operate abroad might not be easy for new ventures. This study approached the Venture Capitalists (VC)'s intervention in this kind of firms. It provides empirical data that VCs might take a decisive role, supporting International New Ventures (INVs) in their international path, through their capabilities, resources or international networks. Using a sample of Portuguese VCs, this study's results suggest that industry knowledge, prior international experience, syndicated investments or "social status" are some examples of the VC's important characteristics within foreign markets. VC-backing might be especially useful, in terms of the involvement in the new venture's board, networks and international activities.

*Keywords: internationalization; intervention; VCs; INVs; capabilities; resources; networks;*

**INTRODUCTION**

The financing takes an important role in the economic growth. In fact, in order to be more efficient, economies need a solid financing system. This study intends to present a different approach about one type of financial support: the venture capital. The venture capital market is important all over the world. For example, some American companies were founded by venture capital, such as Intel, Oracle or Sun Microsystems. In the opposite side of the world, it happens in the same way. China and Taiwan are very clear examples of that. Quanta, the well-known notebook producer and Asustek, the motherboards maker, were supported by venture capital funds (Kenney *et al.*, 2004). However, this support is not just about money and this study is focused on the interesting relation between venture capitalists (VCs) and International New Ventures (INVs), in the internationalization process. Actually, it aims to analyze and reach pertinent conclusions about the influence of VC's support in the internationalization of this kind of firms. In other words, it is important to clarify whether that support is effectively relevant and find out which are their main dimensions.

INVs, which are companies developing international activities since their inception (Oviatt and McDougall, 1994), are well-known as “born global” firms because, for them, the internationalization is a short-term plan and is viewed as a priority (Rennie, 1993). Cooper and Daily (1996) stated that “entrepreneurial teams are at the heart of any new venture”. According to this evidence, VCs might take a relevant strategic role in the INV’s management, for example, in terms of their professionalization (Hellmann and Puri, 2002), improving their international competitiveness. However, this study focus on the “early stage”, when already exists a product, ready to be commercialized. Within this first-stage of financing, the INV starts growing and some expenses are coming up (Bachher and Guild, 1996). However, in their first stage, small firm’s managers are worried about the domestic investment and just after some time they start working abroad. This stepwise growth may be the cause to lose interesting opportunities and develop international activities (Rogers, 2004). The success of operate abroad is strongly associated to the managerial expertise and firm networks (Chandler and Hanks, 1994). Actually, VC’s networks and connections are likely to enlarge over time (Sorenson and Stuart, 2001) and INVs might take very important benefits from the venture capital investment.

Within the early stage, there is a high risk level and the investment necessities are crucial (Howell, 2015). This study’s approach will focus on the venture capital investments including INVs and VCs from Portugal. Usually, in Portugal, this process is divided in two types of support: financial and strategic. In fact, VCs may provide both of them, since they might be aware of the INV’s conditions. Further, if the INVs are aware of the performance from previous venture capital investments (and their influence within foreign markets), more partnerships will be successfully developed. Hence, being aware of this type of knowledge might be an important step for this type of new ventures, in terms of the internationalization path, and it can turn this international process into an easier one.

## REVIEW AND SYNTHESIS OF LITERATURE

### *Informational intervention:*

VCs might be able to analyze foreign markets in order to minimize the INV’s informational problems. Guler and Guillén (2010b) gave special attention to the legal protection of investor’s rights. According to this evidence, VCs may be able to anticipate any kind of change in the legal systems within foreign markets (such as the property right’s protection) and analyze the foreign market’s political/regulatory stability (Guler and Guillén, 2010b). However, VCs may be an important partner through another point of view: their experience. Sorenson and Stuart (2001) highlight the VC’s prior international investment experience as an important factor reaching new markets, overcoming obstacles and enlarge their future international scope. Delineate contract’s characteristics or evaluate

business opportunities abroad are some examples of that. Actually, the VC's international networks increase over time, with the internationalization of the venture capital industry. Additionally, syndicated investments abroad also contribute to a raise of international knowledge, which is significant in order to identify new business opportunities abroad (LiPuma, 2014). However, networks within home country deserve some attention, too. Home country partners may possess some relevant information about the firm, which can be useful for foreign market's stakeholders (Guler and Guillén, 2010a). Without that support, the firm could face some problems, in terms of signal its reliability (e.g. showing foreign stakeholders that it is trustworthy). It can reduce the venture's foreignness liabilities. Indeed, the "VC's social status" is an important characteristic and it can easily influence the stakeholder's (e.g. customers or suppliers) perceptions about the new venture's qualities and outputs (Stuart *et al.*, 1999).

According to LiPuma (2014) informational problems are more likely to occur with a greater geographical distance. Thus, if there is a large distance between investors and new ventures, VCs are likely to use more stages of funding with shorter durations between them, in order to develop an efficient monitoring. However, on average, VCs prefer to be near the ventures in which they invest, in order to oversight their activities as well as maintain narrow connections with venture's founders (Sorenson and Stuart, 2001).

Sorenson and Stuart (2001) also approached the VC's networks coming from venture capital environments (from participants in this process). These networks might have a decisive role, accessing the international information, which might be important to reach new markets. Connections can be established with another VCs, experts or new entrepreneurs. Those are commonly established within the same industry. Actually, the VC may be investing in the same industry for a long period, which can bring some important connections, from different parts of the globe (Sorenson and Stuart, 2001). Concerning the networks effects, the VC's type might also be a relevant point, within the internationalization path. According to Schildt *et al.* (2005), corporate venture capital (CVC) is likely to possess more international networks, for example, in terms of potential foreign customers. However, syndicate investments may be another activity, which can bring some important connections between VCs. This type of venture capital investment might also have some advantages, such as the risk diversification or the second opinion in the decision making process (Gompers and Lerner, 2001). Further, VCs with many syndicated investments are likely to possess important networks and they access to a high amount of information, either in terms of industries or geographic regions (Sorenson and Stuart, 2001). Nevertheless, the existence of a local syndicate partner might increase the likelihood of a successful exit (LiPuma, 2014).

*Functional intervention:*



Functional dimension might be also an essential one. Arthurs and Busenitz (2006) found greater dynamic capabilities in backed ventures, in terms of the product and management development. Additionally, Fried *et al.* (1998) showed that backed ventures might have an important advantage, since their boards show a greater involvement in the strategy's development and monitoring, than non-backed ones. Further, Fried *et al.* (1998) found that the board's involvement have a positive influence on the backed-firm's performance.

According to Arthurs and Busenitz (2006), there is a valuable support provided by VCs, in the early stage. At this stage, a competent management team is a crucial necessity. Hellmann and Puri (2002) analyzed this theme and found that VCs develop their activities, in order to "professionalize" the firm, which is likely to be a faster process in venture-backed firms (Hellmann and Puri, 2002). This professionalization might consist in hiring new management teams and some positions may be switched, including the replacement of the CEO (Hellmann and Puri, 2002). However, this changes within the management teams are likely to appear through four main dimensions, which are the recruitment practices, the human resources policies, the stock options planning and the recruitment of vice president of marketing and sales (Hellmann and Puri, 2002). Stock options, "which give the recipient the right to buy a share of stock at a pre-specified exercise price for a pre-specified term" (Hall and Murphy, 2002, p. 1), is an option to manage/retain the human resources and compensate managers. In terms of these stock options, Hellmann and Puri (2002) found a strong relationship between obtaining venture capital and adopting a stock options plan. Actually, backed-firms possess more than twice of the likelihood of having such plan, comparing with non-backed ones. In terms of the vice president of marketing and sales, it happens in the same way: a vice president of marketing and sales is more likely to be appointed with the intervention of VCs. Hellmann and Puri (2002) also found that VCs have a significant role in the human resources planning, defining policies according to their knowledge. Specifically, one dimension was deeper analyzed, which is the recruitment process. Backed-firms are more likely to use (professional) networks, in order to hire some type of human resources, such as the sales, marketing, administrative and managerial personnel. The use of networks within the recruitment process is one indicator about the firm's level of professionalization, in terms of their relationship with its business environment (Hellmann and Puri, 2002).

Some financial aspects were included in the functional ones, in terms of the VC's intervention, such as the shortage of working capital to invest. According to Hellmann and Puri (2000), VCs possess business knowledge and they are aware of industry's conditions, that is why they may be able to choose right firms to invest in, those with high future potential. This evidence brings the idea that VCs are likely to be aware of the right time to execute the rounds of financing, since they possess expertise not only about venture's features but also about their market.

*Marketing intervention:*

Venture's marketing needs are related to some factors, such as the product, price or distribution. In terms of the product ones, VCs possess assets that are likely to reduce the time to market, which is considered the "time from the birth of the company to the date of first product sale" (Hellmann and Puri, 2000, p. 15). According to Hellmann and Puri (2000), venture capital is considered as being decisive to accelerate the venture's product launch. Additionally, adapt the venture's product might be difficult, in order to reach new markets and meet their specific requirements. In fact, this task might be associated to a high level of uncertainty. Arthurs and Busenitz (2006) approached the venture backing importance for the INV's product development. It seems that "the market perceives that venture capitalist-backed ventures are better able to address product-related weaknesses and threats" (Arthurs and Busenitz, 2006, p. 207). This product constraint may be minimized through the right choice about the management. Actually, VCs are likely to have close connections with important managerial expertise, assuring the INV's quality. For example, VCs might convince senior managers with high industry experience to integrate the venture's project (Arthurs and Busenitz, 2006). This type of "dynamic capabilities" might contribute to explain the reason why the markets value VC-backed ventures, comparing with non-backed ones, when there are high product-related risks (Arthurs and Busenitz, 2006).

The inexistence of economies of scale may be an important constraint within foreign markets. According to Fischer and Varga (2002), inter-firms cooperation/networks might have an important role achieving economies of scale, reaching new markets, or accessing new technologies. Those economies of scale may come up through an alliance with R&D and/or producing institutions. Zeng *et al.* (2010) approached the relationship between different types of networks and innovation, which requires scale, of small and medium enterprises (SMEs) in China. Their findings point out a high importance of different types of cooperation: inter-firm cooperation, cooperation with intermediary institutions and cooperation with research institutions. These types of organizations are crucial to the small firm's innovative performance. Furthermore, Zeng *et al.* (2010) found a higher importance of vertical connections with customers, suppliers or other firms, comparing with the horizontal connections with research institutions. Additionally, the literature's review also shows the VC's importance, reaching potential foreign customers and suppliers (Gorman and Sahlman, 1989; Schildt *et al.*, 2005).

**METHODOLOGY***Sample and data collection method:*

Global and national business theories and practice:  
bridging the past with the future

ISSN: 2547-8516  
ISBN: 978-9963-711-56-7

In order to obtain a broader knowledge about the VC's intervention in backed firms, it was chosen a qualitative methodology. This is an approach, which is likely to explore a single or multiple case, through an in-depth data, based on some specific sources of information and it is likely to achieve case-based themes (Creswell *et al.*, 2007). Usually, data collection methods are questionnaires or interviews and the evidence is qualitative (words). One of the objectives of this type of data collection is to provide a description about the subject (Eisenhardt, 1989) and this study intends to be a descriptive analysis.

In line with Yin (2015), institutional responses may be studied through this type of qualitative data. Actually, the collected data were provided by a group (8) of Portuguese VCs (view Table 1). However, twenty-four VCs were contacted, in order to have the opportunity to collect different and complementary perceptions about VC-backing and its importance for the new venture's internationalization. The answer rate was 58.3%. However, just eight of them had a positive feedback, in terms of the availability for meetings and all of these ones were interviewed. In these meetings, VC's members (mainly managing partners and business analysts) were interviewed. The main purpose was to compare the Portuguese VC's intervention with the literature's evidence.

#### *Interview's structure:*

Each interview was supported by a script, in order to approach the most important aspects in the literature's review. Similarly to the literature, the approached aspects, throughout the interviews, were related to the three main dimensions of the venture capital investment: informational, functional and marketing intervention. Specifically, the interview's questions were divided in 4 main parts: i) study's presentation; ii) VC's presentation; iii) VC's standard intervention in their INVs; iv) VC's international intervention in their INVs. However, these interviews had an exploratory direction and the interviewed had the total freedom of add some relevant aspects, in order to illustrate its reality supporting their backed firms, operating abroad. Additionally, outcomes from previous interviews were being questioned in the subsequent interviews, in order to find out their relevance for this study.

#### *Outcome's analysis method:*

Seven of the interviews were recorded and transcribed. Then, all of them were organized, through the software NVIVO. Similarly to Creswell *et al.* (2007), the transcripts from the 7 interviews were analyzed and the most significant statements, sentences or quotes were highlighted. Each of them fitted a specific meaning unit. One of the interviews was analyzed through a note-taking method, but it was also included in the software NVIVO. Actually, the information was analyzed and classified, according to the aforementioned method (literature's evidence and interviews additional information).

With the chosen methodology, the researcher is likely to collect data from a variety of sources and aggregate them to illuminate the case (Baxter and Jack, 2008). Thus, it was possible to identify how many VCs (“sources”) mentioned each item and the content of the emerging information about each one of those items (“references”). In fact, through this analysis, it was possible to develop an overview about the most relevant aspects and the existence or inexistence of any relationship with the literature’s aspects.

Interview’s number	VC’s name	Interviewed	Date	City
1	Vallis Capital Partners, SGPS, S.A.	Francisco Seixas (Analyst)	16/03/2017	Porto
2	Inter-Risco - Sociedade De Capital De Risco, S.A.	João Amaro (Managing Partner)	03/03/2017	Porto
3	x)*	x)*	17/03/2017	Porto
4	2Bpartner - Sociedade de Capital de Risco S.A	Ana Rangel (Business Manager)	23/03/2017	Braga
5	BCP Capital - Sociedade de Capital de Risco S.A	Pedro Pintassilgo (Director)	01/03/2017	Lisbon
6	Change Partners Capital - Sociedade de Capital de Risco S.A	Mário Pinto (Chairman)	27/02/2017	Porto
7	Explorer Investments, Sociedade de Capital de Risco, S.A.	Pedro Valente (Analyst)	07/03/2017	Lisbon
8	Novabase Capital - Sociedade de Capital de Risco, S.A.	Henrique Gomes (Investment Analyst)	01/03/2017	Lisbon

x)\* This VC asked for confidentiality of the provided information.

Table 10. VC’s presentation

## INTERVIEW’S GENERAL OUTCOMES

### *Emerging aspects from interviews*

The interviews provided some additional information, comparing with the approached aspects in the literature’s review. The interview’s number is available in the Table 1.

The VC’s involvement in the backed firm’s board is one of them. Generally, VCs are likely to appoint 1 or 2 members for the backed firm’s board, developing activities as non-executive directors (NEDs) (4<sup>th</sup>, 5<sup>th</sup>, 6<sup>th</sup> and 8<sup>th</sup> interview). This aspect was referred in 4 interviews. However, one of the interviews revealed a different approach about the backed firm’s control, which is the CEO’s appointment for just one year (6<sup>th</sup> interview). Additionally, most of the VCs usually take minor positions, in terms of the share capital (pointed out in 4 interviews – 3<sup>rd</sup>, 4<sup>th</sup>, 5<sup>th</sup> and 6<sup>th</sup> interview).

Another emerging aspect from interviews was the services provided by VCs. In fact, they are likely to improve the internal information/reporting systems, in order to make the backed firm's communication easier and more efficient between their members (1<sup>st</sup> and 5<sup>th</sup> interview). However, the definition of pricing models to reach any specific type of foreign customers was another service, which may be provided by VCs (8<sup>th</sup> interview).

VC's networks are also an important aspect in terms of the venture capital investment. In the interviews, some VCs are likely to recruit venture's members, based on their networks. One of the referred activities were the introduction of industry experts to the backed firms and this members may take a position in the board (8<sup>th</sup> interview).

According to the interviews' information, VCs are likely to invest in industries related to the academic background or professional experience of their members. In fact, according to this aspect, industry knowledge might be strengthened by VC-backing (3<sup>rd</sup> interview).

VCs might also have an important role searching for investors to support the backed firm's project (4<sup>th</sup> and 8<sup>th</sup> interview). New investors can improve the foreign market's approach. National VCs may syndicate investments with foreign VCs from foreign markets, which can bring some advantages in the international path. With this kind of activities, VCs are able to bring not only international funds, but also international knowledge and local important networks (e.g. connections with customers, suppliers, distributors...) (4<sup>th</sup> interview).

Additionally, VCs might find other institutions to syndicate investments, such as banks or private investors (5<sup>th</sup> and 6<sup>th</sup> interview), which might bring several advantages such as the board's heterogeneity or compliance mechanisms, in order to oversight the activities related to the backed firm.

Foreign markets analysis is another activity, in which VCs can be very important. For example, VCs are likely to develop some international activities, such as the international visits to know the main local stakeholders (2<sup>nd</sup> interview) or they might search for the most valuable groups of foreign customers in the market (1<sup>st</sup> interview). However, VC's international experience might turn the international path into an easier one. Actually, prior investments within foreign markets might benefit future investments in the same countries (2<sup>nd</sup>, 3<sup>rd</sup>, 7<sup>th</sup> and 8<sup>th</sup> interview).

Finally, VCs are likely to examine some opportunities to acquire firms, in the national market or abroad. This activity might be a relevant one, since international firms can provide some industry or market knowledge to the backed firm (2<sup>nd</sup> interview).

#### *Literature's aspects supported through the interviews*

Some of the literature's aspects were supported in the empirical data. According to the interview's outcomes, VC's geographic reach is likely to enlarge with syndicated investments (6<sup>th</sup> interview). Sorenson and Stuart (2001) considered the same aspect through a different perspective,

which is that VCs are able to enlarge their social and geographic reach, due to the effects of successive investments. For example, they might establish connections with some actors in the venture capital market (entrepreneurs, other VCs, experts...), from different countries.

Industry knowledge from the ongoing investments in the same industry was also pointed out by the literature's review (Sorenson and Stuart, 2001) and supported by VCs (1<sup>st</sup> interview). Indeed, both sources considered this kind of investments as an important mean to establish some valuable ties within the industry (e.g. suppliers or customers).

In terms of the local connections, it is important to highlight the existence of a local syndicate partner. Although its advantages were recognized by the interviewed VCs (2<sup>nd</sup> interview) and LiPuma (2014), the empirical data deepened this aspect, exploring the usefulness of these local partners.

Concerning the foreign market's analysis, regulatory aspects might be relevant and they were approached either in the literature or the empirical data. Actually, according to Guler and Guillén (2010b), VC's may be able to anticipate any kind of regulatory change within foreign markets, such as the property right's protection. Thus, this kind of foreign market's study might be useful, in terms of its analysis. In the empirical data, the same trend was supported. According to the 3<sup>rd</sup> interview, some industries and markets have stronger regulatory conditions and VCs might be able to analyze it, for example, through a comparison with other backed firms operating within the same markets.

Regarding the board's involvement in the backed firm's strategy and monitoring, there is also a correspondence between empirical data and literature. In fact, Fried et al. (1998) considered that boards from backed firms are likely to present greater involvement in the strategy's development and monitoring. The interviews (4<sup>th</sup>, 5<sup>th</sup>, 6<sup>th</sup> and 8<sup>th</sup> interview) are likely to corroborate this theory, since most of the VCs might appoint 1 or 2 members for the backed firm's board (as NEDs), in order to support the development of the backed firm's strategy as well as its monitoring.

The backed firm's teams are likely to change with the venture capital intervention. This evidence was brought from the literature (Hellmann and Puri, 2002), with the appointment of new management teams. Actually, this evidence was supported by empirical data (2<sup>nd</sup>, 5<sup>th</sup> and 6<sup>th</sup> interview), since there is the possibility of switching the management teams, especially, in "C-level positions" (CEO or CFO, mainly).

Human resources policies were also referred previously in the literature (Hellmann and Puri, 2002) through two main examples: the adoption of a stock options plan or the recruitment process, based on VC's networks. In the empirical data, this evidence was corroborated, since VCs might be important either in the recruitment process (1<sup>st</sup> interview) or in the implementation of some human resources policies, illustrated with an adoption of a stock options plan (8<sup>th</sup> interview).

The recruitment process and changes of management teams deserve some attention, too. In the literature, Arthurs and Busenitz (2006) approached the possibility of VCs bring senior experienced managers (experts) to the venture's board. Actually, this fact was referred in the interviews (8<sup>th</sup>) and it might give some expertise to the venture's board, in terms of the industry knowledge.

Syndicated investments with another VC might also represent a relevant aspect, in terms of the advantages in the decision making process. In fact, firstly, Gompers and Lerner (2001) referred the importance of having a second opinion in the decision making. In reality, the empirical data (6<sup>th</sup> interview) took a position in the same direction and revealed that the information sharing between investors might be important in the backed firm's success.

#### *Interviews' most referred aspects*

Some aspects assumed a higher importance, since they were mentioned more times than the others. Although these points has not been mentioned in the same way, they are likely to present complementary ideas, concerning the same subject. For example, in terms of the backed firm's control and board's involvement, it was possible to conclude that most of the VCs are likely to take a minor position in the share capital (3<sup>rd</sup>, 4<sup>th</sup> 5<sup>th</sup> and 6<sup>th</sup> interview) and appoint 1 or 2 members for the backed firm's board, as NEDs (4<sup>th</sup>, 5<sup>th</sup>, 6<sup>th</sup> and 8<sup>th</sup> interview).

Prior international investments were considered as an important characteristic in the literature. However, the interviews went further and they considered that prior investments within foreign markets are likely to benefit future investments in the same markets (2<sup>nd</sup>, 3<sup>rd</sup>, 7<sup>th</sup> and 8<sup>th</sup> interview).

VC's networks (personal and professional) were deeply analyzed in the interviews, through some different perspectives. Mainly, these connections were approached through 3 main dimensions, which are their usefulness: i) to appoint some industry experts for the backed firm's board, as NEDs (1<sup>st</sup> interview); ii) to support another firms in the same industry (7<sup>th</sup> interview); iii) to reach foreign VCs, in order to syndicate investments with them (4<sup>th</sup> interview). However, VC's personal connections were also one of the most referred points (1<sup>st</sup>, 4<sup>th</sup> and 7<sup>th</sup> interview). Actually, these personal connections are likely to benefit backed firms abroad, essentially, reaching foreign stakeholders.

VCs might be likely to develop activities within foreign markets and they might assume a high importance, with many purposes. For example, VCs are likely to visit foreign markets, in order to explore their opportunities and have a better perspective about the main local stakeholders (2<sup>nd</sup> interview). Additionally, VCs might go along with the management of the backed firms, in order to support them in international meetings (3<sup>rd</sup> and 7<sup>th</sup> interview).

#### *Literature's non-referred aspects (in the interviews)*

One of the non-referred aspects was the influence of Corporate Venture Capitalists (CVCs) in the internationalization of their backed firms. According to Schildt et al. (2005), CVCs are likely to possess more international networks (for example, in terms of potential foreign customers) than IVCs. Nevertheless, CVCs were just approached once in the empirical data (8<sup>th</sup> interview). This interview just approached the CVC's industry-related knowledge, since CVCs are likely to support backed firms within the same industry.

In line with the literature, home country partners might have a high importance in the backed firm's international path, since they may possess relevant information about the backed firm and it can be useful for stakeholders within foreign markets (Guler and Guillén, 2010a). Actually, according to this evidence, home country partners may facilitate the backed firm's international approach through the minimization of informational lacks, but this trend was not referred in the empirical data.

Sorenson and Stuart (2001) considered that VCs are likely to be near the backed firms to oversight their decisions and maintain close connections with their founders, but this point was not supported by the empirical data, since international VCs might be involved in the investments (4<sup>th</sup> interview).

Product development was not deeply approached by empirical data. According to Hellmann and Puri (2000), VCs are likely to reduce the backed firm's time to market, since they might possess assets which can make the product launch faster. Nevertheless, this aspect was not approached in the interviews. In fact, most of the VCs highlighted their influence on strategy-related aspects, instead of product-related aspects.

In the literature's review, the achievement of economies of scale was one of the identified small firm's constraints operating abroad. Zeng et al. (2010) referred that inter-firms might give easier access to the economies of scale, which might come from an alliance with R&D and/or producing institutions. Thus, this type of actions could be taken by VCs but this point was not approached in the empirical data.

## CONCLUSIONS AND DISCUSSION

Concerning the interview's outcomes, VCs are likely to develop some important activities, supporting their backed firms within foreign markets, through some transversal backed firm's dimensions, such as the VC's connections, their international activities or their involvement in the venture's board. In fact, board's involvement was considered a relevant point by this study. Actually, Fried *et al.* (1998) highlight this subject and this investigation's outcomes point out the same direction. According to Fried *et al.* (1998), backed firm's boards are likely to present a greater involvement in the strategy's development and monitoring than non-backed firms. In terms of the approached VCs,



although most of them take a minor position in the share capital, they are likely to appoint 1 or 2 members for the backed firm's board, as NEDs. In line with Hellmann and Puri (2002), with the VC's intervention, the venture's management teams may be switched. This evidence was supported, not only through the appointment of NEDs, but also through the VC's influence (in some cases), appointing some of the "C-level positions" in the backed firm's board (CEO or CFO, mainly).

Prior international investments were another point with an important relevance in this study's results. In the literature, prior international investments are likely to enlarge the VC's networks and scope. Actually, some obstacles may be easier to overcome in foreign markets, such as the negotiation constraints (Sorenson and Stuart, 2001) and the informational lacks may be reduced. Although the empirical data have agreed with this evidence, it went further. Prior investments within foreign markets are likely to benefit future projects in the same markets.

VC's professional and personal networks were also approached through the empirical data in three main dimensions, which were their usefulness: i) supporting firms in the same industry; ii) appointing some industry experts for the backed firm's board, as NEDs; iii) reaching foreign VCs, in order to syndicate investments with them. Arthurs and Busenitz (2006) considered that VCs might be able to bring senior experienced managers to collaborate in the venture's project and these members may be recruited, through the VC's partners networks (personal connections). In fact, according to the 1<sup>st</sup> interview, VC's connections may be useful through this way and they can make the venture's board more valuable, in terms of the industry knowledge. Additionally, industry knowledge might also be improved by VC's backed firms in the same industry. This interaction with other backed firms might be important, in order to share experiences or obstacles and the international path may be easier for new ventures. Syndicated investments were also approached in this study. Actually, the international syndicated investments were highlighted as another example, in which VC's networks may be important, either in terms of industry knowledge or market knowledge. Czinkota and Ronkainen (2001) considered that backed firms must be aware of cultural assumptions within foreign markets, such as the necessity of formal or informal procedures within each stage of negotiation. Indeed, syndicate investments with foreign VCs may be a useful method (coming from VC's networks), in order to be aware of this specificities of foreign markets. Nevertheless, VC's personal connections might also be important through more points of view, such as reaching foreign stakeholders (e.g. customers or suppliers).

With the purpose of reaching a better understanding about foreign market's characteristics, VCs can develop some activities, within those markets, where their backed firms will operate. In the literature, VCs present a high importance reaching foreign potential customers and suppliers (Gorman and Sahlman, 1989; Schildt *et al.*, 2005). Indeed, the empirical data brought some relevant information,

concerning this internationalization process of new ventures. VCs are likely to visit foreign markets, with the purpose of exploring their business opportunities and know the main local stakeholders. Additionally, VCs might be with the management team in international meetings.

In short, VCs are likely to have an important role in the international path of their backed firms, mainly, in terms of the involvement in the new venture's board, networks and international activities. In reality, new ventures might have some important advantages with VC-backing, operating internationally.

This study presents some limitations, which may be referred, in order to obtain a better understanding about the venture capital market, analyzed throughout the study. Actually, the sample (interviewed VCs) was not perfectly homogeneous. Some of these Portuguese VCs have a different scope, in terms of their backed firm's profile. Some of those firms were not within their first stage of development. However, all of the VC's information might be valuable, since the VC's intervention may be useful in different occasions with different backed firms. Additionally, the VCs had different purposes, since their portfolios had different characteristics between each other. In other words, the VCs were likely to invest in different sectors and different type of support may be provided. Indeed, this aspect may be relevant since the sample might be considered as a non-homogeneous one through this way and the VC's intervention and knowledge might be biased by the backed firm's sector. Another limitation is the origin of the VC's funds. Some of them might come from different proveniences and the VC can be "obliged" to develop some specific type of activities, according to the will of those resource providers. In these situations, the VC's intervention (for example, in terms of the international activities) and their decisions may be shared with different players or investors.

## REFERENCES

- Arthurs, J. D., and Busenitz, L. W. (2006), "Dynamic capabilities and venture performance: The effects of venture capitalists", *Journal of Business Venturing*, Vol. 21 No. 2, pp. 195-215.
- Bachher, J. S., and Guild, P. D., "Financing early stage technology based companies: investment criteria used by investors, paper presented at Babson College Entrepreneurship Research Conference (BCERC), 1996, Oklahoma, available at: <http://www.babson.edu/Academics/centers/blank-center/bcerc/Pages/frontiers-of-entrepreneurship-research.aspx>
- Baxter, P., and Jack, S. (2008), "Qualitative case study methodology: Study design and implementation for novice researchers", *The qualitative report*, Vol. 3 No. 4, pp. 544-559.
- Chandler, G. N., and Hanks, S. H. (1994), "Founder competence, the environment, and venture performance", *Entrepreneurship: Theory and Practice*, Vol. 8 No. 3, pp. 77-90.
- Cooper, A. C., and Daily, C. M. (1996), *Entrepreneurial teams*, Krannert Graduate School of Management, Purdue University, Institute for Research in the Behavioral, Economic, and Management Sciences, West Lafayette, IN.
- Creswell, J. W., Hanson, W. E., Clark Plano, V. L., and Morales, A. (2007), "Qualitative research designs: Selection and implementation", *The counseling psychologist*, Vol. 35 No. 2, pp. 236-264.
- Czinkota, M. R., and Ronkainen, I. A. (2001), *Best practices in international business*, Harcourt College, Fort Worth.
- Eisenhardt, K. M. (1989), "Building theories from case study research", *Academy of management review*, Vol. 4 No. 4, pp. 532-550.

- Fischer, M. M., and Varga, A. (2002), "Technological innovation and interfirm cooperation: an exploratory analysis using survey data from manufacturing firms in the metropolitan region of Vienna", *International Journal of Technology Management*, Vol. 24 No. 7-8, pp. 724-742.
- Fried, V. H., Bruton, G. D., and Hisrich R. D. (1998), "Strategy and the board of directors in venture capital-backed firms", *Journal of Business Venturing*, Vol. 13 No. 6, pp. 493-503.
- Gompers, P., and Lerner, J. (2001), "The venture capital revolution", *The journal of economic perspectives*, Vol. 15 No. 2, pp. 145-168.
- Gorman, M., and Sahlman, W. A. (1989), "What do venture capitalists do?", *Journal of Business Venturing*, Vol. 4 No. 4, pp. 231-248.
- Guler, I., and Guillén, M. F. (2010), "Home country networks and foreign expansion: Evidence from the venture capital industry", *Academy of Management journal*, Vol. 53 No. 2, pp. 390-410.
- Guler, I., and Guillén, M. F. (2010), "Institutions and the internationalization of US venture capital firms", *Journal of international business studies*, Vol. 4 No. 2, pp. 185-205.
- Hall, B. J., and Murphy, K. J. (2002), "Stock options for undiversified executives", *Journal of accounting and economics*, Vol. 33 No. 1, pp. 3-42.
- Hellmann, T., and Puri, M. (2000), "The interaction between product market and financing strategy: The role of venture capital", *Review of Financial Studies*, Vol. 13 No. 4, pp. 959-984.
- Hellmann, T., and Puri, M. (2002), "Venture capital and the professionalization of start-up firms: Empirical evidence", *The Journal of Finance*, Vol. 57 No. 1, pp. 169-197.
- Howell, S. T. (2015), "Financing constraints as barriers to innovation: Evidence from R&D grants to energy startups", Harvard University, Massachusetts, 7 January.
- Kenney, M., Han, K., and Tanaka, S. (2004), "Venture Capital Industries", Yusuf, S., *Global change and East Asian policy initiatives*, World Bank, Washington, D.C., pp. 391-427.
- LiPuma, J. A. (2014), "Venture capital and international entrepreneurship". Fernhaber, S.A., & Prashantham, S., *The Routledge Companion to International Entrepreneurship*, Routledge, New York, NY, pp. 186-202.
- Oviatt, B. M., and McDougall, P. P. (1994), "Toward a theory of international new ventures", *Journal of international business studies*, Vol. 25 No. 1, pp. 45-64.
- Rennie, M. W. (1993), "Born global", *The McKinsey Quarterly*, No. 4, pp. 45-53.
- Rogers, M. (2004), "Networks, firm size and innovation", *Small business economics*, Vol. 22 No. 2, pp. 141-153.
- Schildt, H. A., Maula, M. V. and Keil, T. (2005), "Explorative and exploitative learning from external corporate ventures", *Entrepreneurship Theory and Practice*, Vol. 29 No. 4, pp. 493-515.
- Sorenson, O., & Stuart, T. E. (2001), "Syndication networks and the spatial distribution of venture capital investments 1", *American journal of sociology*, Vol. 106 No. 6, pp. 1546-1588.
- Stuart, T. E., Hoang, H. and Hybels, R. C. (1999), "Interorganizational endorsements and the performance of entrepreneurial ventures", *Administrative science quarterly*, Vol. 44 No. 2, pp. 315-349.
- Yin, R. K. (2015), *Qualitative research from start to finish*, Guilford Publications, New York, NY.
- Zeng, S. X., Xie, X., and Tam, C. M. (2010), "Relationship between cooperation networks and innovation performance of SMEs", *Technovation*, Vol. 30 No. 3, pp. 181-194.

## CONCEPTUALIZING PUBLIC VALUE DESTRUCTION

Ricci, Paolo; Esposito, Paolo

University of Sannio, Italy

### ABSTRACT

The research aims to map the different types, configurations and 'constellations' within the Italian galaxy (De Graaf, Nabatchi, Van Der Wal, 2012) or universe (Jorgensen, Bozeman, 2007: 359; Johnson, 2012) of *public (dis)value*, trying to develop a conceptual model based on the notion of public value (PV) and on the processes that allow its generation and 'visualization' (Guthrie, Farnsworth, 2008). PV is a variously definable *abstract quantity*, and not a measure quantity such as income (Onida, 1968: 558), which is used in its various stages of creation, *transformation* and destruction to help define public governance features (Sòstero, 2003) when assessing the sustainability of public policies (Moore, 1995, 2002; Stoker, 2003; Benington, Moore, 2011; Guthrie, et al., 2014).

The capital that generates or compromises PV is not abstract, though: it is the *political capital*, a specific component or sub-configuration of social capital that is behind political action (Birney, 2010) and can be seen as a complex and ever-changing combination of cultural paradigms, ideologies, skills, relations and *ligatures* (Dahrendorf, 1994: 42.193). Not much attention has been devoted in literature, particularly by Italian business science, to *public (dis)value* issues (abstaining from voting, corruption, tax evasion, (ab)use of power, (ab)use of law, State capture), to the difficulties in composing the *frictions* and *tensions* existing between *apparatuses* and *people*, between *buro-cracies* and *demo-cracies* (Aucoin, 1991, 2012; Blaug, 2006) and to the increasing risk of silent *autarkic*, *anarchist*, *revolutionary* tendencies or worse, all potentially subversive of democratic representation.

Further goals of the present work are:

i) to draw logical and conceptual cognitive maps able to identify and codify the distinctive elements that mark most situations of *public (dis)value* (Rutgers, 2008; Nabatchi, 2011), *visualizing* changes in value (either increasing or decreasing), evaluations and (re)evaluations (Masini, 1955). Such mapping process would also highlight hidden reserves resulting from the re-evaluation through co-generation and/or *re-generation* of *new* public value within an initially compromised context/situation (Borgonovi 2007: 606), for example by 'freeing' and converting properties confiscated from the Mafia in public goods available to the community (*Plus-Value*);

ii) to verify the nature of any relationship existing between the degree of accountability that a

public administration can implement and consolidate (Anessi Pessini, Borgonovi, 2000; Ricci, 2005, 2010; Lapsley, Ezzamel, Hyndman, Johansen, 2009; Parker, Guthrie, 2010; Anessi Pessina, Nasi, Steccolini, 2010), and the increasingly frequent depletion phenomena occurring within the Public Administration with relation to value (either tangible or intangible), finance, property and reputation (Birney, 2010: 4,5);

iii) to analyze through a case study an example of the pathological situations compromising public value and integrity that increasingly often occur in the management of public bodies (Bianchi, 2012), and showing how the pursuit of individual happiness is detrimental to the degree of happiness referable to the community as a whole.

*Keywords: cultural paradigms, public value, public (dis) value, methamorphosis, archeo-mafia*

## 1. INTRODUCTION

The research aims to map the different types, configurations and 'constellations' within the Italian galaxy (De Graaf, Nabatchi, Van Der Wal, 2012) or universe (Jorgensen, Bozeman, 2007: 359; Johnson, 2012) of public (dis)value, trying to develop a conceptual model based on the notion of public value (PV) and on the processes that allow its generation and 'visualization' (Guthrie, Farnsworth, 2008). PV is a variously definable abstract quantity, and not a measure quantity such as income (Onida, 1968: 558), which is used in its various stages of creation, transformation and destruction to help define public governance features (Sòstero, 2003) when assessing the sustainability of public policies (Moore, 1995, 2002; Stoker, 2003; Benington, Moore, 2011; Guthrie et al., 2014).

The capital that generates or compromises PV is not abstract, though: it is the political capital, a specific component or sub-configuration of social capital that is behind political action (Birney, 2010) and can be seen as a complex and ever-changing combination of ideologies, skills, relations and ligatures (Dahrendorf, 1994: 42.193).

Not much attention has been devoted in literature, particularly by Italian business science, to public (dis)value issues (abstaining from voting, corruption, tax evasion, (ab)use of power, (ab)use of law, State capture), to the difficulties in composing the frictions and tensions existing between apparatuses and people, between buro-cracies and demo-cracies (Aucoin, 1991, 2012; Blaug, 2006) and to the increasing risk of silent autarkic, anarchist, revolutionary tendencies or worse, all potentially subversive of democratic representation.

Further goals of the present work are:

- i) to draw logical and conceptual cognitive maps able to identify and codify the distinctive elements that mark most situations of public (dis)value (Rutgers, 2008; Nabatchi, 2011; Esposito, Ricci, 2014, 2015, 2016, 2017), visualizing changes in value (either increasing or decreasing), evaluations and (re)evaluations (Masini, 1955). Such mapping process would also highlight hidden reserves resulting from the re-evaluation through co-generation and/or re-generation of new public value within an initially compromised context/situation (Borgonovi 2007: 606), for example by 'freeing' and converting properties confiscated from the Mafia in public goods available to the community (Plus-Value);
- ii) to verify the nature of any relationship existing between the degree of accountability that a public administration can implement and consolidate (Anessi Pessini, Borgonovi, 2000; Ricci, 2005, 2010; Lapsley, Ezzamel, Hyndman, Johansen, 2009; Parker, Guthrie, 2010; Anessi Pessina, Nasi, Steccolini, 2010), and the increasingly frequent depletion phenomena occurring within the Public Administration with relation to value (either tangible or intangible), finance, property and reputation (Birney, 2010: 4,5);
- iii) to analyze through a case study an example of the pathological situations compromising public value and integrity that increasingly often occur in the management of public bodies (Bianchi, 2012), and showing how the pursuit of individual happiness is detrimental to the degree of happiness referable to the community as a whole.

## **2. RELEVANCE OF THE RESEARCH TOPIC IN THE ITALIAN CONTEXT**

The relevance of the research topic for the scientific community in question is provided by different data processed and presented by different national (Corte dei Conti, Istat, Banca d'Italia, CNEL, Alto Commissariato per la prevenzione della corruzione, AVLP) and international (World Bank, OECD, IMF, Asian Development Bank, Transparency International) institutions on the public (dis)value generated by phenomena of corruption, tax evasion, abuse of law and State capture (Edwards, 2010).

As to phenomena of corruption in local public administrations and Italian problems of economic development and growth, the focus on them by national research institutes such as CNEL and Istat and international organizations such as OECD and World Bank is strong.

CNEL in particular, through its socio-economic Observatory on crime, has focused since the mid-90s on the obstinacy of corruption phenomena in public management (1996), also highlighting the risk of infiltration by organized crime in EU funding processes (Law 488/1992), in large public works and also in several local bodies in northern Italy, in what looks like a silent conquest of entire chunks of legal economy. Investigative bodies and DIA have been recently strengthened, also by stipulating

inter-institutional agreements with CNEL and Alto Commissariato per la prevenzione della corruzione (the latter watchdog was subsequently suppressed); clear guidelines have also been provided by organizations such as Confindustria, by expelling those businessmen and industrialists who do not report bribing phenomena, this way fueling the culture of lawlessness and the silence of illegality. Also growing is the production by the national legislator of standards and measures for the prevention, law enforcement and fight against corruption (Anti-Corruption Bill), and to ensure free market standards in procurement procedures and public tenders through the establishment of a legality rating (Law 18/05/2012 n.62; also the regulation issued by Autorità garante della concorrenza e del mercato on 14th November 2012), in order to define a white list of companies able to take part to public procurement procedures.

### 3. SOME EMPIRICAL EVIDENCE OF PUBLIC DIS-VALUE

Below is some empirical evidence that can help visualize the economic and social amount of public dis-value:

#### *Corruption*

Recent data from Corte dei Conti (2012) show that phenomena of 'informal economy' (in the absence of price, tariffs and/or measurement units of the exchange utility) that are erosive of public value, amount in Italy to about € 60 billion a year with regard to corruption, and to € 120 billion a year as a result of tax evasion (Bank of Italy, 2011), thus siphoning off crucial resources which could otherwise be employed to support education, health and social policies.

It should be added that less than 60 million euros - out of the annual 60 billion dis-value, which are recovered each year by Corte dei Conti (Vannucci, 2012).

#### *Tax evasion*

Delays in terms of tax revenue assessment and collection policies compared to other OECD countries (Locarno, Staderini, 2007), have affected the cultural and financial dimension of tax evasion in Italy.

*Figure 1*

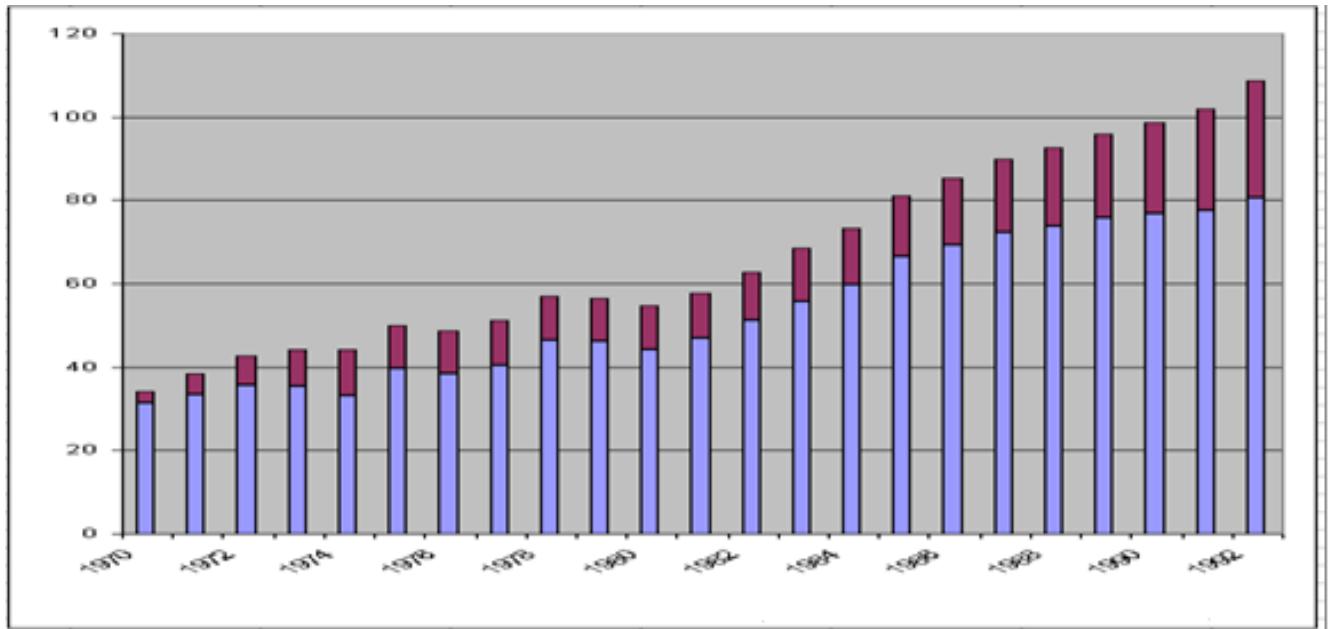

Debt due to tax evasion
  Debt without tax evasion

Recent data from *Corte dei Conti* (2012) show that the erosion of 'public value' by tax evasion amounts to about € 120 billion a year in the Italian economy (Bank of Italy, 2011). Below are 2011 data from *Agenzia delle Entrate*, broken on regional and provincial basis.

Figure 2: Tax Evasion

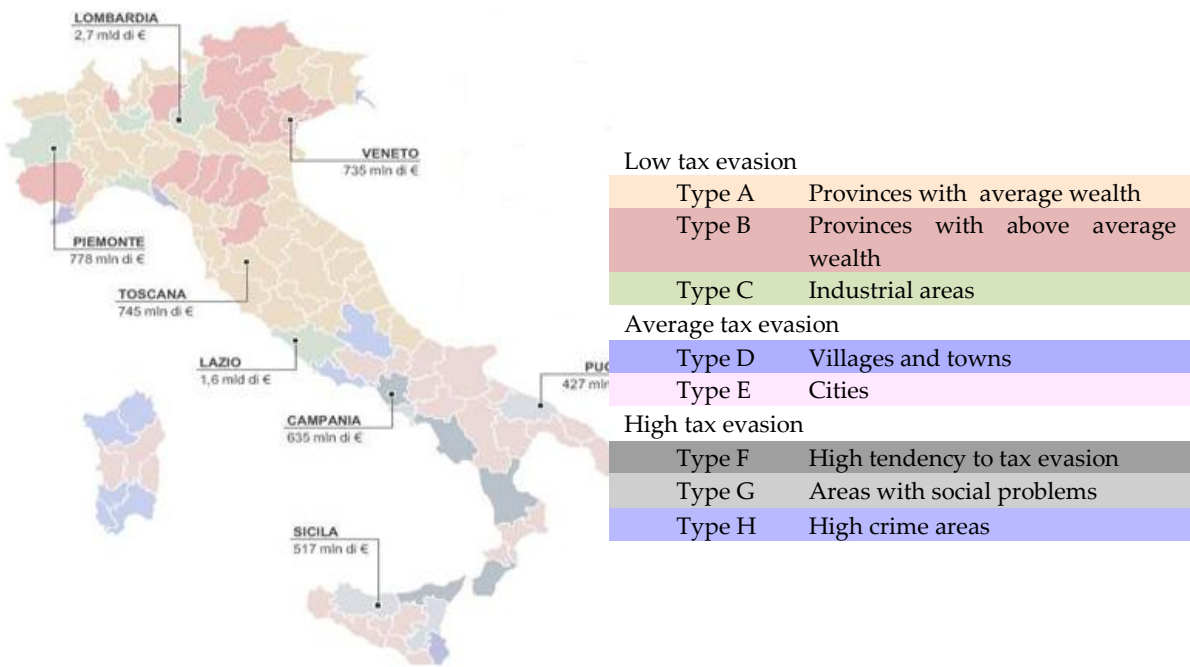

Source: (Agenzia delle Entrate, 2011)



Even more alarming are 2012 *Istat* data regarding tax evasion, whose size is measured in about 275 billion Euros. Italy holds in fact the top position in Europe for the size of its hidden economy and, consequently, for tax evasion. The unpaid amount in taxes amounts to about five annual budgets, almost one third of the total State revenue.

Figure 3: Tax Evasio

	BankItalia (sample survey 2012)		Tax Returns (Sogei data)		Per capita tax evasion	
Geographical Distribution	Taxpayers (million)	Average per capita income (euro)	Taxpayers (million)	Average per capita income (euro)	Difference between Sogei and BanckItalia income per capita	Tax evasion rate
north	19,7	€ 17.068	20,0	€ 14.530	€ 2.532	14,8%
center	8,5	€ 16.850	8,1	€ 13.914	€ 2.936	17,4%
south	12,8	€ 12.030	12,3	€ 11.080	€ 950	7,9%
total	41,0	€ 15.449	40,4	€ 13.356	€ 2.093	13,5%
	BankItalia (sample survey 2012)		Tax returns (Sogei data)			
Taxpayers type	Taxpayers (million)	Average per capita income (euro)	Taxpayers (million)	Average per capita income (euro)	Difference between Sogei and BanckItalia income per capita	Tax evasion rate
Employee	16,5	€ 14.690	17,7	€ 17.931	-€ 240	-1,6%
Pensioner	12,2	€ 10.940	13,6	€ 11.023	-€ 83	-0,8%
Self employer and business man	4,6	€ 27.020	4,3	€ 11.798	€ 15.222	56,3%
Income from buildings (rent)	1,1	€ 21.286	1,1	€ 3.462	€ 17.824	83,7%
Pensioner and employee	1,1	€ 21.065	0,7	€ 22.694	-€ 1.629	-7,7%
Self employer and employee or pensioner	0,9	€ 36.745	1,2	€ 20.372	€ 16.373	44,6%
Other	4,6	€ 11.494	1,9	€ 16.942	-€ 5.447	-47,4%
Total	41	€ 15.449	40,5	€ 13.356	€ 2.093	13,5%

Source: (Agenzia delle Entrate, 2011)

### *Eco-Mafia*

In Italy, the financial dimension of the disposal of waste generated by eco-mafia and the consequent costs sustained to restore the healthiness of the areas involved are remarkable (Legambiente, 2012).

Figures related to environmental lawlessness in Italy grew significantly also in 2011. Reported offences were 33,817, 9.7% more than in 2010, a year when the same figure was already 7.8% up compared to 2009. This means that in two years reported crimes against the environment established by the police, by the Coast Guard and by provincial police forces went up by 17.5%. The number of crimes committed every day exceeded 92, an

average of 3.8 offences per hour. Up were also the figures related to reported offenders (27,969, a 7.8% increase compared to 2010) and especially of those subsequently arrested: 305, 100 more than in the previous Ecomafia report, with a 48.8% increase. The number of seizures was on the other hand stable: 8765, against 8771 operated in 2010 (Legambiente, 2012).

Environmental

crimes:

- In the waste disposal cycle (illegal landfills)

Figure 4

	Region	Crimes 2011	People reported	People arrested	Seizures
1)	Campania	5.327	4.234	97	1.234
2)	Calabria	3.892	2.561	42	980
3)	Sicilia	3.552	2.842	20	900
4)	Puglia	3.345	2.971	57	1.281
5)	Lazio	2.463	1.982	10	597
6)	Sardegna	2.192	2.008	23	564
7)	Toscana	2.187	1.939	12	678
8)	Lombardia	1.607	1.442	4	390
9)	Liguria	1.464	1.340	1	240
10)	Abruzzo	1.054	919	8	222
11)	Emilia Romagna	1.030	1.240	1	347
12)	Basilicata	876	425	4	101
13)	Piemonte	874	693	8	162
14)	Marche	856	872	3	206
15)	Veneto	837	930	0	195
16)	Umbria	783	647	0	175
17)	Friuli Venezia Giulia	627	468	11	313
18)	Molise	413	268	4	84
19)	Trentino Alto Agide	380	129	0	80
20)	Valle D'Aosta	58	59	0	16
	<b>Total</b>	<b>33.817</b>	<b>27.926</b>	<b>305</b>	<b>8.765</b>

Source: (Legambiente, 2012)

- In the concrete and public works cycle (illegal building activities)

Figure 5

<i>Environment crimes in regions with high Mafia density, 2011 data</i>					
	Campania	Puglia	Calabria	Sicilia	Total
Infringements (offences)	5.327	3.345	3.892	3.552	16.116
% of the national total	15,8	9,9	11,5	10,5	47,7
People reported	4.234	2.971	2.561	2.842	12.608
People arrested	97	57	42	20	216

Seizures	1.234	1.281	980	900	4.395
----------	-------	-------	-----	-----	-------

Source: *Legambiente*, based on data provided by the police, provincial police forces and the Coast Guard (2011).

#### *Archeo-Mafia*

*Theft of cultural and archaeological treasures has grown steadily in Italy: 1,112 offences were recorded in 2011, with a 13.1% increase on the previous year. A significant police activity brought to report 1,302 offenders and to the arrest of 53 of them. The amount of the related business estimated by the police is also on the rise at more than € 316 million in 2011, almost a million a day, exactly 100 more than in 2010. Campania is the region with the highest number of thefts (169, 15.2% of the national total) knocking Lazio off the top of the ranking of the most affected areas, now in second place with 150 thefts; third is Lombardy (143), fourth Tuscany (95), and fifth comes Sicily (83). (Legambiente, 2012).*

Again, most thieving is concentrated in churches, museums and public libraries. It is the *theft of public value (dis-value)* related to the national cultural heritage, either artistic (objects and works of art) or regarding manuscript and print (*archeo-mafia*).

It is the archival and library system to suffer the most serious attacks with as many as 9,886 items stolen in a single year, that constitute public goods and value removed from the community. The theft of books, old documents and archival heritage perpetrated to the detriment of institutions, agencies and libraries, either public or private, is indeed a pressing issue (*Legambiente*, 2012). In most cases the shortfalls are ignored by the institutions themselves, due to incomplete and ineffective cataloguing procedures, or the extreme ease of transportation, concealment and fragmentation of the assets stolen.

Figure 6

<b>Archeo-mafia in Italy</b>	<b>National total 2011</b>
Artifact thefts	1.112
People reported	1.302
People arrested	53
Seizures part of protective activities	365

Source: *Legambiente*, based on data provided by the police, provincial police forces and the Coast Guard (2011).

These figures are even more alarming for current and future communities, in view of the growing scale of the crisis and consequent shortage of financial resources that, apart from causing additional effects on the taxation of individuals and businesses, also produce further financial, social and existential inequality.

#### 4. RESEARCH METHOD

This study aims to achieve its research goals through the adoption of an inductive/deductive method (Yin, 1984, 1995). It is the approach followed by Bozeman and Jorgensen in 2007, also the starting point to highlight some obstacles in the advancement of studies and future investigations on PV (De Graaf, Nabatchi, Van Der Wal, 2012; Taylor, Pierce, Blackmar, 2012), using the 'constellation-based' reference model, which nevertheless displays both advantages and disadvantages (Jorgensen, Bozeman, 2007). The advantages are represented in our study by the empirical evidence of re-acquisition of assets seized to the mafia and of ethical re-generation of new public value from previous forms of dis-value by returning freed goods to the reference community. As to the disadvantages, we can mention the 'visualization' and identification of public value by denying the notion of value itself, that is by determining its conceptual inversion: the (dis)value. In other words, the model in question does not measure value or, better, its determination produced by public actions and policies, through the quantitative measurement of value changes brought by such actions (Corte dei Conti, 2010, 2011, 2012).

In the first part of the work, after a thorough analysis of the available literature, we shall try to answer the following research questions (RQs): RQ1: Is it possible to define or display public value through the measurement of public disvalue? RQ2: What is the empirical evidence of public disvalue in Italy? What are its main causes? RQ3: What tools can we reasonably use to fight the causes of public disvalue?

In the second part of the paper we shall analyze the case of re-generation of public value and political capital through the liberation, the conversion and subsequent management of assets seized from the mafia and returned to the community of reference.

#### 5. THE METAMORPHOSIS OF PUBLIC VALUE: A CONCEPTUAL PREMISE

Speaking of public value is not easy. Before trying to define it, we are supposed to tackle fundamental philosophical issues relating to its existence, its nature and the conditions necessary to individuate this aspect of human action. Through their social action, in fact, men more or less consciously create or destroy value for themselves or for others. Also, such value should not be exclusively considered in terms of economic utility. It: 1) exists, as it constitutes one of the main purposes of human action; 2) has a hybrid nature, as it can be observed for different aims and from different points of view; 3) changes and can be measured, albeit in a complex way, with relation to social, cultural, environmental and anthropological factors affecting its very origin.

Let us proceed with more order. First of all, we can say that public value can be pursued by each individual, either considered on his/her own or organized with other individuals. It is quite clear that, if each individual is able to pursue it, such value should only be considered public if the effects of human choice or action involve other individuals, under any (social, economic, psychological, etc.) profile. It is worth pointing out, however, that it is very difficult to think about individual choices that are not able to affect, in one way or another, other people's lives. Bearing this in mind, we could get one day to a full and comprehensive assessment regarding the relevance and significance of all individual choices, taking into account the fact that a social person is always a political person, i.e. someone called to participate in - and contribute to - the life of any form of human association (Tronti, 2010).

The present study aims to address the issue of individual political action and of the political capital consequently produced in favour of the community. More in detail, it will examine the actions taken by an individual who has been specifically appointed to run public affairs, that is to choose priorities, lead towards certain targets, implement plans, control the action, produce or take part to the production of a public service that could benefit the reference community (welfare community). Even the exercise of voting rights is a necessary condition for good political governance and as such it is of crucial importance to the community (Brennan, 2011), but this is a topic we shall not be addressing here.

Value is created and destroyed whenever an individual is called upon to perform any of these activities in relation to a public service (Denhardt J. and Denhardt R., 2003; Kelly, Mulgan and Meurs, 2002). In theory, these actions produce disvalue when their actual target becomes different from the one they were supposed to reach when they originated. This means we are able to understand whether a certain behaviour - or an omission - by a politician are such as not to create or even destroy value, when we are able first to measure and then evaluate the effects of such variance. It is therefore paramount to understand what the good pursued by political action is, what originates and motivates political action, that ultimately is any action carried out in the society and for the society. In order to better understand the significance of this statement, it seems extremely useful referring to Aristotle (Natali, 2003; Laurenti, 2009) and going back to over 2300 years ago. The great philosopher addresses the question as follows: "(...) all knowledge and every pursuit aims at some good, what it is that we say political science aims at and what is the highest of all goods achievable by action. Verbally there is very general agreement: (...) it is happiness" (Nicomachean Ethics, Book 1). Happiness should therefore be the good to be pursued through politics. From what is considered happiness depends therefore whether and how public value is created or destroyed after meeting an ever changing (Dahrendorf, 1981, 1995) social desirability (Dahrendorf, 1994: 30). Everything seems to balance if we

stay away from the relevant moral and religious considerations which we are not going to address here. However, it is almost impossible to reach a univocal definition of happiness: philosophical inquiry is as wide as uncertain and complex, and above all endless. Many questions come to one's mind, including: is happiness the same for everyone? Is it accessible to all? Does it coincide with the material well-being of all or at least most of the individuals belonging to a community? Again, can it be taught or become a habit? "(...) For if what was said in the Ethics is true, that the happy life is the life according to virtue lived without impediment, and that virtue is a mean, then the life which is in a mean, and in a mean attainable by every one, must be the best" (Aristotle, Politics, Book 4). But how can Aristotelian happiness, either individual or collective (of the polis) actually be found? How can it be achieved? These are truly complex questions. This paper therefore only aims at studying the metamorphoses of public value, trying to understand what kind of political action public sector companies should take in order not to overlook the general end, creating the conditions necessary for each individual to gain in terms of current benefits or future opportunities, either directly or indirectly. Following this approach, public sector companies and administrations are the means by which a community solves practical problems regarding political action, which aims to make community members 'happy' (simplifying, today we would just say satisfied). By replicating Bozeman and Jorgensen's model (Bozeman, Jorgensen, 2007: 361) of 'visualization' of logical-cognitive 'constellations' and conceptual maps of the public value universe, we can say that:

1. each individual, as a member of his/her community, is a political person;
2. human action, and particularly political action, affects other people's lives;
3. political action also involves the government of public affairs;
4. the good pursued by political action is individual and collective happiness;
5. happiness implies the satisfaction of material and immaterial needs;
6. some material and immaterial needs can be met through the government of public affairs;
7. public value is one of the expressions of collective happiness;
8. public value can increase or decrease as a result of political action;
9. metamorphoses of happiness result from changes of complex and different (sociological, institutional, political, etc.) nature;
10. metamorphoses of happiness involve metamorphoses of public value.

It seems therefore totally impossible to talk about public value and especially to consider its whole multidimensional nature without tackling, at least in part, some issues about its meaning. What concerns us here is to show how political action can create disvalue whenever it moves away from the common good, that is whenever collective happiness is jeopardized, as we can reasonably associate the latter with the common good and the general interest: essential rights, development of personal

skills, recognition of human dignity. What makes a family or a worker happy with relation to the conduct of a public administration? What does one expect and what gives satisfaction to a patient with relation to public healthcare? What are the effects of widespread corruption among public officials? What public policies tend to maximize the pathological behaviour of officials and politicians? The 'strategic triangle' approach to public value by Moore (1995), despite being an important tool for the study of public action success, does not thoroughly cover the issues regarding how to visualize and determine value, and how to prevent harmful behaviour. Experience from the world of professional consulting (Accenture, 2004), however useful to understand the empirical relevance of public value, does not seem to account for all the different notions of it and for its metamorphoses (Cole, Parston, 2006). On the one hand, theoretical approaches tend to confine research on public value within a paradigmatic debate, or one which is too often about the abstract identification of conditions at the basis of public administration activities (NPM), while on the other hand more practical approaches risk to restrain the notion of public value within economic and financial determinations that are often too narrow. The real challenge of the coming years will be entirely about intellectual capital, in its most important form: the political capital. It is the set of ideologies, relations, skills and combinations of those, expressed by public sector companies and the relevant ruling class, either political or managerial, that contributes to the creation of public value. Such capital can combine and coordinate appropriate levels of equality and collective utility (Borgonovi, 2004: 344). The political capital can be visualized in terms of trust or reliability the community ascribes to public entities. Such attributes are based on different parameters: detail and incisiveness of rules, transparency of information, degree of corruption and of technological innovation, state of the culture etc. (Morin, 2012). They also change as the notion of public value changes. Following this approach, public value should not be calculated as a mere difference between the value of the utility produced for the community and the value of the costs borne by the latter to reach it. Such differential factor would be very difficult if not impossible to determine, as utility produced is not always measurable being it of cultural, historical, legal or social nature. Even if it was, it would still be of no real significance, as its relationship with time is not univocal. Public value may be, however, identified in a set of factors that constitute both the goal and the mean of political activity, and still express human action potential that can lead to good administration and collective happiness. Overcoming some long-established ideological positions, or in some cases their exclusive strengthening, do not imply – respectively – that those positions no longer exist or instead that they are paramount in the process of creation of public value, which should be eventually seen – with Aristotle – as the decisive factor in the removal of all obstacles to the expression of human virtues. Public value is created when the community promotes and enables the realization of all human

capabilities (Nussbaum, 2011), while the same is destroyed when the community is prevented from doing so.

There is a further issue, though, one which is not at all secondary: how does public value, as generated by political capital, change following the apparent cultural and anthropological transformation of happiness?

In other words how does a better quality of life, in terms of material and immaterial well-being, affect both the creation and destruction of public value? Are changes of political action, determined in turn by a transformation of the factors that shape a community (religious sense, education, value system, but also skills and sense of civic duty), able to affect public value or not?

## 6. PUBLIC VALUE (PV) AND PUBLIC VALUES (PVS).

The theme of public value has long been the subject of attention in academic community. In recent years it has become also known among a non-specialist audience, this way becoming part of what we can call a new 'management frenzy' (Abrahamson, 1991, 1996). From a theoretical point of view, the research work was inspired by the debate that, according to some authoritative authors, began in 1995 with Moore, who was at that time dealing with the subject of quality in PA (Jorgensen, Bozeman, 2007: 361). Through further elaboration, clarification and contextualization, it has then developed into a model that features the theory of public value as a new paradigm – integrative or even alternative to NPM – that was named Public Value Management (Stoker, 2006; O'Flynn, 2007; Alford and O'Flynn, 2009). The rationale behind our research lies therefore in the multidimensionality of the notion of public value and in its obvious implications for public governance, following a path that has led us to focus, both theoretically and empirically, on the study of public value measuring methods and on their application to the case of Italian public administration.

### TRENDS

During the 80s and the 90s the scientific debate on public sector reforms was marked by theories, notions and values then constituting the framework of the new public management (NPM), an approach that undoubtedly broke with the traditional bureaucratic paradigm of public administration. Within the rich literature on NPM we find key notions and ideas such as the transition to a professional management, the use of standards and performance indicators, the emphasis placed on the control system, organizational decentralization, the establishment of competitive procedures and processes, the adoption of management styles typically used in the private sector, a more effective and efficient use of resources, the equalization of the citizen to the customer (Savas, 1982; Hood, 1991; Broadbent and Guthrie, 1992; Osborne and Gaebler, 1993; Kelly, 1998; Pollitt and Bouckaert, 2004). By



the mid-90s the NPM approach, seen as a synthesis of managerial innovation experiences carried out in the public administrations of the most advanced countries, but also as the philosophy behind the role of the public administration as a key player in the quasi-market, started to be reviewed and reconsidered. Scholars have gradually become aware of the fact that certain principles stated by NPM cannot support the need of the community for a government able to ensure the creation of public value that, by its very nature, is radically different from any value generated by companies operating within the free market (Moore, 1995; cfr. Bozeman, 2002; Blaug et al, 2006; Spano, 2009). The basic idea is that the creation of public value (Rebora, 1999; Valotti, 2000; Borgonovi, 2007) should be paramount not only in policy makers' choices, but also in public managers' actions, in exactly the same way private value is crucial to private managers' decisions (Moore, 1995; Stoker, 2006; Flynn 2007).

#### CHALLENGES

Scientific literature has shown how public managers are given a much more demanding task, which is to combine purely political issues with those of a more technical nature, in order to ensure the creation of public value (Hefetz and Warner, 2004). This re-assessment of changes occurring in public administrations had the effect of reducing the expectations towards the NPM model of a public sector based on free market mechanisms while - perhaps not without critics - has the merit of sorting, at least partially, the logic according to which the public sector works from free market logic, bringing the focus back to values typical of the former. The approach to public value was born at the beginning of the '90s, independently from NPM studies, and it has gradually become an important part of their development and revision, first by highlighting and then by filling and amending their gaps and inconsistencies, respectively. This has led in some cases to significant changes of direction in the process of modernization of public administration compared to ordinary NPM issues. It has been restored, in particular, the notion that policy makers should take into account multiple goals. According to this relatively new approach, the citizen is not seen as a customer, but rather as someone who contributes to shape decisions and public policies that are ultimately taken by managers operating with transparency and providing quality public services, so as to increase not only the effectiveness and efficiency of the action itself, but also the legitimacy and trust placed in politics and institutions (Osborne, 2006, 2010). The theory of public value is based on the need to assess public services and to achieve higher levels of efficiency and effectiveness. This would in turn facilitate the establishment of an accountability culture where the public management should be held responsible as much towards citizens as they are towards politicians, overcoming a static approach based on top-down models where public managers try to reach targets set at central level following performance management criteria. It was argued (Blaug et al., 2006) that the public value model tries to compose the tension between bureaucracy and democracy. The assumption at the basis of the public value

theory is the acknowledgement of needs and preferences of the citizens, who are the recipients of public services, in order to avoid that any decision regarding quantity and quality to be delivered stays only in the hands of politicians, public managers or of the private companies in charge of providing the services in question. Public value should therefore be seen as a key factor in the design and implementation of political decisions and strategies regarding the services to be provided and should involve the entire decision-making process, right up to the final stage when the service is offered/provided to citizens (Lapsley, 1999; Sevic, 2001; Marcon and Russo, 2008). The design of the public value of a service begins therefore from the moment the service is planned according to what is expected by the community and its potential users.

## 7. CONFUSION REGARDING THE DEFINING PERIMETER OF ITALIAN PA

PV and PVs In recent years there has been in Italy a perception and 'visualization' of public value almost on a molecular scale, and at the same time we have witnessed conceptual contradictions originated by growing confusion (De Graaf, Nabatchi, Van Der Wal, 2012), perhaps due to terminological and definitional ambiguity of the following terms (Jorgensen, Bozeman, 2007: 355):

Public Value

Public Values

not acknowledging the importance and influence that public values, defined according to different hierarchical taxonomies (Jorgensen, Bozeman, 2007) and expressed by constitutionally guaranteed rights (Bozeman, 2007; Borgonovi, 2001, 2008), have in determining and affecting the perception, 'visualization' and generation of public value.

### CONTRADICTIONS

In a State where rights, responsibilities, freedoms and democratic boundaries change rapidly over time, where the different dimensions of public value become growingly central to the government of citizens and the life of communities, there may be the risk to confuse cause and effect, returns and investments, ends with means. It is possible to find in scientific literature several definitional and conceptual perimeters regarding the notion of public value, which consider citizens either direct beneficiaries (Dicke, 2006), or direct generators through the manifestation of their preferences (Moore, 1995; Kelly, 2002: 4; Borgonovi, 2004, 2005: 47; Brennan, 2011). We can talk about public value when there is a community of individuals who benefits from such value (DeBrujin, Dicke, 2006: 719). The inadequacy of political capital, caused by poor combinations of ideologies (now diluted), relations, skills, ligatures (Dahrendorf, 1994) generates transformation, dispersion and destruction of public value (dis-value), compromising the quality of administrative decisions, and of political and social choices, with harmful effects brought over time by their financial and economic manifestations.

Our PV is the effect of an investment in a political capital that is at boiling temperature and whose state has been constantly changing. Such metamorphoses have led it to ideological liquefaction and to a confused and chaotic dispersion of ethical behaviour (Brennan, 2011), of ideological orientations, skills and social ligatures in constant contradiction, and to conflictualism (Dahrendorf, 1981) between happiness of the individual and happiness of the community, or between the happiness of a State and the happiness of more States in order to preserve the specific happiness of other single States and interest groups (e.g., Greece and the EU). The public values that can affect and shape a different perception and visualization of happiness, i.e., of the capacity of the Italian Public Administration to detect and meet the needs of our community, are in turn affected by the specific cultural and ideological background (secular and Catholic) where public value originates and grows. In Italy, more than in other countries, dominant religious values have affected the political capital and thus the production of public value being created and/or destroyed, and sometimes regenerated again (plus-value) (Pollitt, 2010). It is precisely due to the strong presence of some dominant religious and cultural values (Catholic Church), such as the centrality of the family with its distortions (Banfield, 1954) that in Italy we can find, still contaminated by other ideological and cultural factors, different public values within which it is possible to visualize PV (Guthrie, Farneti, 2008; Spicer, 2012).

## 8. PV AND P(DIS)V

The Constellation Theory: Public Universe (Value, disValue, PlusValue) The research aims at visualizing the public (dis)value, an abstract quantity in public administration government systems, according to the model describing the 'constellations of the public disvalue universe', proposed by Bozeman with relation to public value (Bozeman, Jorgensen, 2007). It is a conceptual framework based on the abstract character of the public value universe, that mirrors constellation patterns we identify within an observable radius (Galileo, 1609; Kepler, 1599).

*Figure 7 - The constellations of the PV universe*

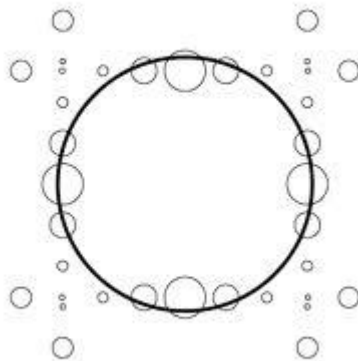

Literature analysis takes into account corruption phenomena within public institutions that led to social, institutional and financial weakness also within part of the private, free-market system (Borgonovi, Fattori, Longo, 2008), which represents a failure of part of the reform process and in general of the *reformitis* trend (Ricci, 2012) that has affected the Italian Public Administration for the past twenty years, also causing:

- a) the failure of NPM implementation in Italy (through the emphasis placed on good governance and on PV measurement);
- b) an identity and financial crisis affecting the whole country;
- c) a weak sense of belonging to the community displayed by citizens, and unwillingness to change/progress on the part of public managers;
- d) an unbalanced system of creation and preservation of electoral support and of *political capital* (essential prerequisite for the production or destruction of value).

From the literature analysis (attached), it is possible to see a whole *universe* of public dis-value and the different *constellations* that form the reticular connective tissue between the structural determinants of corruption and the creation of political support and capital; autonomy, dependability (loyalty), governance (Reichard and Wegener, 1988; Frey and Benz, 2004; Kooiman and Van Vliet 1993; Cassese, 2002, 2004), social forms of self-organization (Kickert 1995; Meneguzzo, 1996), accountability ( Jones, Schedler, Mussari, 2004; Metcalfe, 2000; Jordan, 2005; Osborne, 1995; Pezzani, 2003; Ricci, 2010), all forming a conceptual perimeter where corruption can only represent an acute symptom of the Country's democratic and institutional weakness and probably of the inadequacy of the culture behind the control systems and the management techniques adopted (Von Maravic, 2007). Our approach led us to identify three constellations. The first two are the *political capital* and its generation of *dis-value*, or degeneration (destruction) of value. The third constellation is described in the final part of the case study. In this constellation, accountability (part of the sixth constellation in Jorgensen, Bozeman, 2007: 368) and its various manifestations are useful tools to tackle or prevent the destruction of value (dis-value), and the transformation and re-generation of new value. The figure below shows the reticular pattern according to which political capital, a component of social capital (Putnam, 1993), can be weakened and compromised by the different factors that together are able to destroy public value, as they can either satisfy *social desirability* or cause (un)happiness in the Aristotelian sense of the word among the whole community.

Fig

8:

(Determinants of political capital)

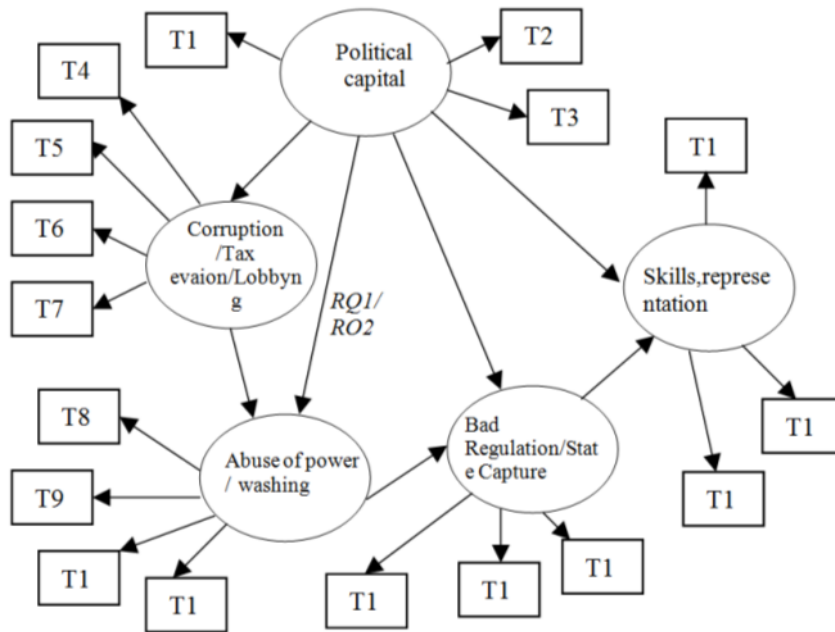

Public Dis-Value = f (political capital);  
 Political capital = f (electoral abstention, ab-use of power, ideological dilution, poor regulation, low competence of representation, dependability, accountability, State Capture, lobbying, nepotism, corruption, tax evasion, control and transparency).

T1 = the determinants of political capital = f (Ab-use of power, ideological dilution, poor regulation, low competence of representation, lobbying, nepotism, corruption, tax evasion, control, transparency)

T2 = individual and existential damage

T3 = weakening of the State

T4 = weakening of the market

T5 = weakening of control

T6 = reputational damage

T7 = damage to public integrity

T8 = damage to public integrity over time - future generations

T9 = dependability and lack of autonomy

In literature, given the already mentioned limitations regarding the use of economic goods compared to the collective needs to be met (such discrepancy determines in fact the condition otherwise known as *scarcity of resources*), corruption within the public administration contributes to distort reality and

public policies in Italy (RQ1, RQ2), where the public disvalue, i.e., the destruction of value, is caused and created by the loss of *political capital* (through the different determinants involved, and their possible combinations). They can be summarized here as follows:

- electoral abstention, renunciation to voting* and to adequate levels of democratic representation;
- disruption of the financial balance of public finances (*tax evasion*);
- diminished capacity of affecting reality by planning and control systems, now mere bureaucratic tools set by the respective internal stability pacts;
- inequality of taxation with relation to citizens living in areas with a lower fiscal capacity per inhabitant, due to the implementation of an incomplete and confused federal system (*(ab) use of power*);
- unpopular tax planning decisions (*tax amnesty*) with increased levels of local, regional and national taxation sometimes unjustified if compared to the services provided;
- public budget rigidity and financial losses arising from off-balance-sheet management and off-balance-sheet debt (lack of financial coverage);
- existence of asymmetric information between guidance and control activities operated by local authorities.

Fig. 9:

(Constellations of the public dis-value universe)

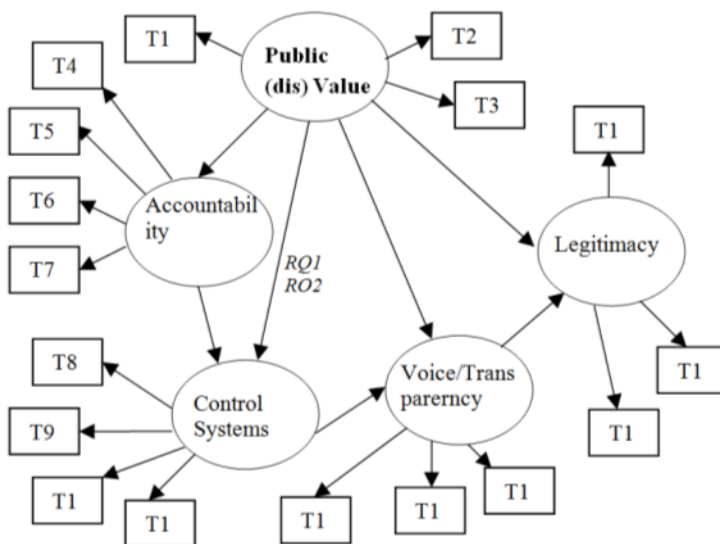

T1 = lack of revenue to fund public policies for citizens

T2 = individual and existential damage

T3 = weakening of the State

T4 = weakening of the market

T5 = weakening of control

T6 = reputational damage

T7 = damage to public integrity

T8 = damage to public integrity over time - future generations

T9 = dependability and lack of autonomy

Scarce *political capital* resources invested in different representative and democratic processes cause therefore destruction of value, (dis)value, that prevents a sustainable and transparent development of public policies and is marked by persistent decision-making discretion, arbitrariness and abuse of political power, all erosive of public value and of the connective fabric between the systems and the ethical infrastructures of a community on the one hand, and the sense of belonging to it manifested by its citizens on the other (Moore, 1995, 2002; Stoker, 2003; Benington and Moore, 2011). One might wonder where this opportunistic and perverse behaviour (*RQ2*) comes from. The answer to this phenomenon is rather complex: control of the territory can be seen as competing with the state authority up to the point of defining it as a parallel authority that is organized and operates using the same tools of traditional PA, i.e., legitimacy, public resources and authority over all those people who have been co-opted into the vicious circle of corruption. The 'grey area' between the two authorities has grown dramatically in recent years, as testified by the growing number of corruption and bribery offences. It is the mismanagement of public affairs that prepares the ground for corruption. Corruption 'is a malignant tumor that surrounds the most vital and active ganglia in the country and does not seem to go away' (*Corte dei Conti*, 2010)

This phenomenon is not even affected by the current financial crisis, as it is exactly this kind of situation that usually boosts the value of assets belonging to criminal organizations. Instability causes a fast and significant wear of the political-institutional system and 'plows the ground' for the growth of groups, lobbies, special interests, either lawful or, in many cases, unlawful (Cavaliere, 2004). Examples of this are healthcare mismanagement, illegitimate appointments, a frequent use of negotiated procedures, an opaque system of public procurement, EU fraud schemes and scams related to local tax collection, appointments related to the performance and delivery of local public services, which have been since the '70s perhaps the most striking case of 'cost of democracy'.

The companies involved, in most cases publicly owned and sponsored by politicians, were plagued by financial scandals and very poor industrial strategies (Gallino, 2005) as their unwritten goal was that of ensuring administrative continuity through the establishment of durable electoral pacts (Ricci, Esposito, Landi, 2010; Esposito, 2010). It is possible to represent this form of corruption as follows (Figure no. 10):

Figure 10 - Visualization of public dis-value: possible forms of corruption in the delivery of a public service

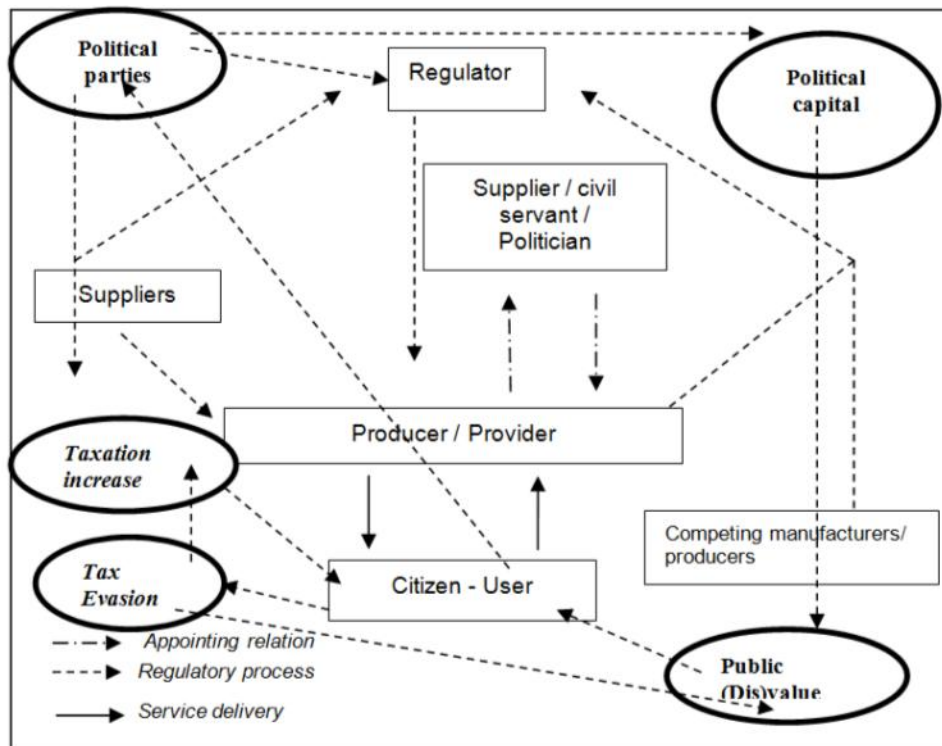

Source: (Adapted from Borgonovi, Fattore, Longo, 2009)

The cases examined by the Italian accounting judiciary (*Corte dei Conti*) are examples of low public and political responsibility, or of *social irresponsibility* (Gallino, 2005), while social responsibility should be one of the most important features required to run public affairs (Borgonovi, 2002, 2005). The growing importance of the system of political parties (electoral laws), leading to the pathological situations described above (public procurement procedures, public service management) has no justification whatsoever in art. 49 of the Italian Constitution which states that all citizens have the right to freely associate in political parties to contribute, within a democratic process, to determine national politics. The constitutional right regarding freedom of association in political parties is the result of a protective idea of the Constitutional legislator aimed at overcoming the objective impossibility for the individual citizen (user/voter) to make him/herself heard (Ricci, 2010). There are currently different studies, drawn especially by general economists, regarding the determinants of corruption which consider it as dependent on the quality of governments and institutions and on the degree of openness to trade of a Country (Broadman, Recanatini, 2001; Cepiku, 2002, 2004; Mussari, Jones, Schedler, 2007; Von Maravic, 2007).



*Formula on corruption*

Corruption = f (quality of governance, quality of political institutions, openness to trade) = B1 + B2 (institutional indicators) + B3 (democracy index) + B4 (trademarks, designs and index systems)

(Source: Broadman and Recanatini, 2001)

International organizations have been trying to monitor and prevent corruption phenomena and the generation of public disvalue. Transparency International<sup>13</sup> presents each year the world ranking according to the corruption perception index (CPI) referred to 180 States, thanks to the work of institutions (World Bank, UN, Asian Development Bank) that systematically carry out investigations regarding corruption levels in certain States or geographical areas. Given the importance of statistical data and indicators of *perceived corruption*, it would be appropriate for such figures to be supported by independent scientific assessments. To give an idea of how corruption is currently widespread in Italy, we report the 2011 ranking below (table no. 1)<sup>14</sup>:

Table 1 – CPI (Corruption Perceptions Index) classification, 2011

56	Jordan	4.5	4.7	5	5.1
57	Saudi Arabia	4.4	4.7	4.3	3.5
57	Czech Republic	4.4	4.6	4.9	5.2
57	Namibia	4.4	4.4	4.5	4.5
60	Malaysia	4.3	4.4	4.5	5.1
61	Turkey	4.2	4.4	4.4	4.6
61	Latvia	4.2	4.3	4.5	5
61	Cuba	4.2	3.7	4.4	4.3
64	South Africa	4.1	4.5	4.7	4.9
64	Georgia	4.1	3.8	4.1	3.9
66	Slovakia	4.0	4.3	4.5	5
66	Croatia	4.0	4.1	4.1	4.4
66	Montenegro	4.0	3.7	3.9	3.4
69	Ghana	3.9	4.1	3.9	3.9
69	Samoa	3.9	4.1	4.5	4.4
69	Macedonia, FYR	3.9	4.1	3.8	3.6
69	Italy	3.9	3.9	4.3	4.8
73	Tunisia	3.8	4.3	4.2	4.4
73	Brazil	3.8	3.7	3.7	3.5
75	Romania	3.6	3.7	3.8	3.8

(Transparency International, 2011)

<sup>13</sup>Non-governmental, non-profit organization founded in 1993 with the specific aim of fighting international corruption by working with international institutions, States and businesses.

<sup>14</sup>For the full table of the index regarding the perception of corruption in the world, see also [www.transparency.org/policy\\_research/surveys\\_indices/cpi/2009/cpi\\_2009\\_table](http://www.transparency.org/policy_research/surveys_indices/cpi/2009/cpi_2009_table)

Some Italian research institutes such as *CNEL* and *ISTAT* have been focusing their attention on corruption phenomena in local public administration and problems regarding development and economic growth in our country. *CNEL*, in particular, through its observatory on socio-economic crime, has been studying since the mid-90s the pervicacity of corruption in public management, which places Italy after developing countries such as Botswana and Namibia in terms of perceived corruption.

## **9. A CASE OF RE-GENERATION OF NEW VALUE (PLUSVALUE). RE-CONVERSION OF SEIZED MAFIA ASSETS**

The case study chosen takes only into account the process of re-generation of new value through the management and restoration to the community of real estate property confiscated from the Mafia (White, 2012), because data referring to businesses seized from organized crime and then re-converted are only available for the past two years and, however interesting, the time frame they refer to is not deemed significant enough to draw conclusive indications on the phenomenon in question. According to data released by the 'Report on the management of assets confiscated from organized crime', presented by the Director of the State Property Agency to the Parliamentary Anti-Mafia Commission, out of 6556 assets seized from the mafia from 1983 to 2005, only 2962 were later restored. Patrimonial prevention measures (L. 31 May 1965 n. 575 and subsequent amendments and additions) aim to ensure not only the seizure of assets from organized crime, but also their return to lawful economic channels, entrusting *Agenzia del Demanio* with the management of those assets after the final seizure in view of their subsequent use. Between 2007 and 2008, 84% of confiscated property was located in Sicily, Calabria, Campania and Puglia. Sicily is the region with the highest number of seized property, with more than 50% of the total. 89% of confiscated property was transferred to the municipalities for institutional or social purposes, while the rest was given to the central State for justice, public order and civil protection purposes.

Figure 11

Comparison of property seized from organized crime and then assigned in 2007 and in the first 10 months of 2008

	Region	Goods assigned from 1.01.2007 to 31.12.2007		Goods assigned from 1.01.2008 to 31.12.2008		Trend %
		Total	Monthly average	Total	Monthly average	
1 )	Sicilia	267	22,5	271	27,10	21,80%
2 )	Campania	81	6,75	143	14,30	111,85%
3 )	Calabria	83	6,92	206	20,60	197,83%
4 )	Puglia	88	7,33	99	9,90	35,00%
5 )	Lombardia	68	5,67	165	16,50	191,18%
6 )	Lazio	62	5,17	38	3,80	-26,45%
7 )	Other regions	35	2,92	44	4,40	50,86%
	<b>Total</b>	<b>684</b>	<b>57,00</b>	<b>966</b>	<b>96,60</b>	<b>69,47%</b>

Source: *Agenzia del Demanio* (State Property Agency)

Despite the simplification of administrative procedures and the expectation of shorter times for the allocation of goods, problems related to the application of complex administrative procedures led first to the creation of a permanent observatory on confiscated property, then to the appointment of a Government Special Commissioner. *Corte dei Conti*, with resolution no. 17/2005/G issued on 1/7/2005 (Implementation of the provisions on the re-use of assets confiscated from organized crime - L. 109/1996), examined the activities carried out by *Agenzia del Demanio* from 1/1/2001 (when it officially assumes the relevant powers) to 31/12/2003 (when the Agency officially becomes an economic public body). While we can say there have been initiatives aimed at streamlining procedures and at monitoring seized goods even before the final judicial seizure, the report showed the long time needed to issue the destination decree (far too long compared to the limits set by law) and in many cases the non-use of the goods in question, due to technicalities pertaining to the judicial phase, or to difficulties in managing the assets (because of the existence, for example, of third-party rights on the assets themselves), or simply because properties had not been physically delivered .

The conclusions reached by *Corte dei Conti* were as follows:

- absence of management planning
- lack of coordination with other inter-institutional bodies

- little use of productivity and profitability criteria
- need for inspection controls on peripheral branches of *Agenzia del Demanio*

*Agenzia del Demanio* keeps track of the 7,875 confiscated properties and their destination.

Figure 12: Percentage of delivered goods

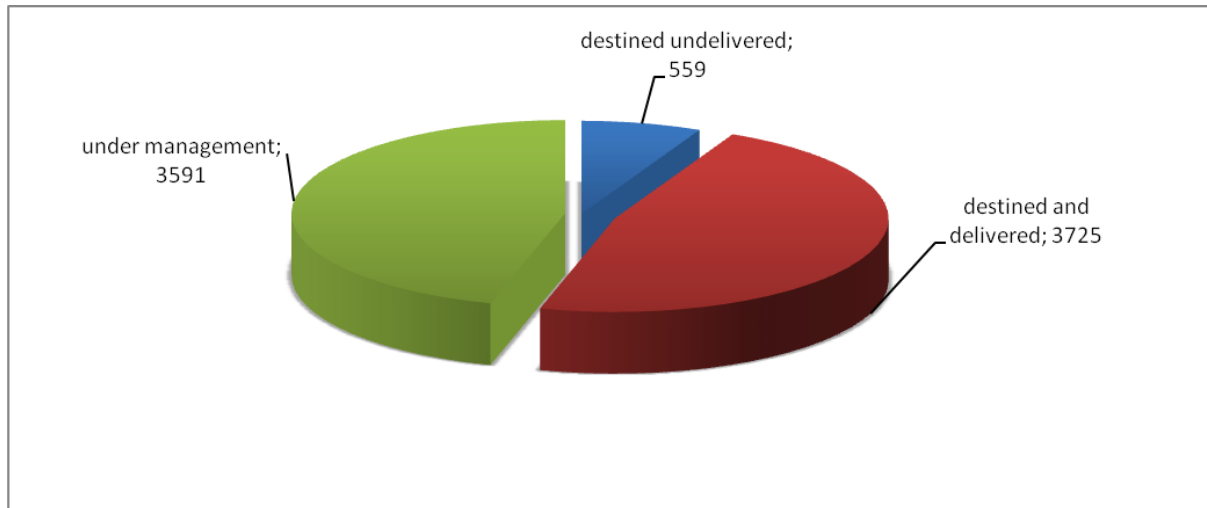

Source: *Agenzia del Demanio* (State Property Agency)

47,30% of the properties seized was allocated to local authorities. According to the analysis carried out by the former Special Commissioner through consultation with local authorities acting as temporary administrators of the properties waiting to be re-converted, some mayors have specifically mentioned the lack of a specific fund to be used for potential transactions. The same source also shows the non-use of 40% of the properties seized due to foreclosures operated by banks as a result of mortgage provision.

The vicious circle of underdevelopment triggered by criminal alliances and joint ventures increases the costs necessary to buy properties, renovate, maintain and re-convert them. Financial needs by local administrations also trigger a rapacious profit-maximizing behavior on the part of lenders, as they often grant – in the *pre-seizure* phase – easy credit to untrustworthy individuals (in many cases without requiring the antimafia certificate issued by the local Chamber of Commerce), while they sell – *post-seizure* – financial products and services to local administrations to be used for the conversion of such facilities (sometimes in blatant conflict of interests – banks are often financial advisors to the same administrations), finding such local bodies *captured* and unprepared with relation to the following activities: - *ex ante* financial assessment; - financial planning of activities; - operating management, either direct or through proxy; - control and supervision; and in the difficult task of

finding possible solutions in a context of persistent lack of financial resources and at the same time of high demand by the communities involved of policies aimed at restoring legality.

The survey also examined the time span going from the moment the goods are assigned to their actual use. Data provided by *Agenzia del Demanio* show that some goods destined to local authorities in 1989 are today still unused.

Table 2 - Companies confiscated from organized crime

Region	Companies under State management	Companies assigned	Companies seized (Total)
Sicilia	129	293	422
Campania	57	153	210
Calabria	18	60	78
Puglia	19	57	76
Lombardia	33	124	157
Lazio	14	85	99
Other regions	14	35	49
<b>Total</b>	<b>284</b>	<b>807</b>	<b>1091</b>

Source: *Agenzia del Demanio* (State Property Agency)

In order to simplify the relevant procedures, local councils have been arguing that they should not only take part in technical workshops in which to determine guidelines and goals of the whole process, but also make sure that all critical issues are not transferred to local authorities which often have to face abnormal problems and challenges, well beyond ordinary local government standards. Local authorities in the South, acting as carers of the properties seized, do not usually have the economic resources necessary to restore them, and therefore try to assign them 'as they are' i.e., in the same condition in which they received them. On the other hand, economically disadvantaged community members who are given use of the good are often not able to access it, as they might not have enough resources to invest on a property they do not fully own. In fact the confiscated property, part of the council's inalienable estate, is assigned to the cooperative or association under a free loan agreement. This means that the property cannot constitute a guarantee for banks wishing to lend money to whoever wants to take care of it, even more so if one considers the 'weakness' of a free loan agreement.

Figure 13 - Real estate confiscated from organized crime

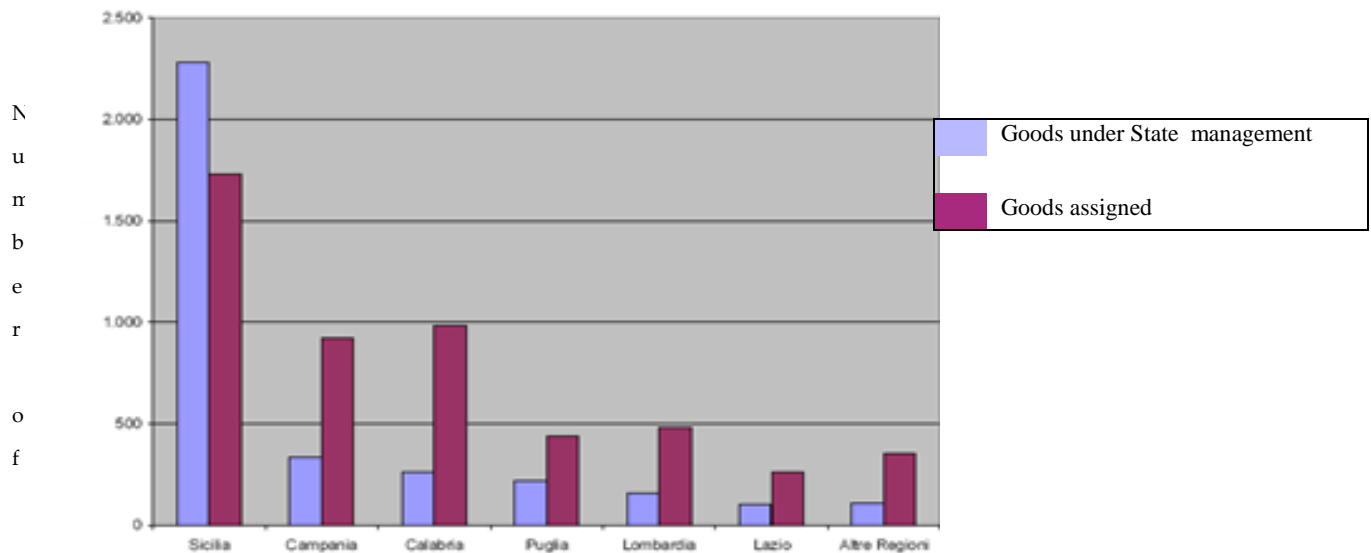

Source: Agenzia del Demanio (State Property Agency)

Data shown highlight the weight of companies and assets seized in northern Italy. Lombardy, for example, turns out to be the fifth in terms of number of confiscated properties. Tables placed above show the *subtraction* and *liberation* of the assets confiscated from the mafia, and their return for social purposes to the reference community, through an important process of *metamorphosis*, transformation and re-generation of new ethical value (from *dis-value* to *value*), which we could define *plus-value*. Public managers and their organizations play a leading role in *creating public value*, not only by producing – efficiently and effectively – goods and services that can add value to the reference community, but also by pursuing goals and targets that are of a purely social and ethical nature. The public subject must be the guarantor and the custodian of the public interest, putting its citizens'/users'/customers' welfare before any personal interest. However, in the current system of Italian Public Administration, the management of the administrative machine is anything but inspired by principles of equity, sociality and ethics (Borgonovi, Giavazzi, 1994; Cavaliere, 2002). Alterations and distortions of political action, transformations, *metamorphoses* and destruction within the *constellations* of the *public (dis)value* universe (Jorgensen, Bozeman, 2007: 355) have arisen due to a lack of *political capital*, caused by an unbalanced and inadequate combination of factors, by ongoing tensions and frictions between the devolvement of greater autonomy and power to local authorities, and the consequent allocation of responsibilities in the management of public resources. Such imbalances have produced in recent years deep lacerations up to the point of seriously compromising planning, administration, management and control processes at any level within the Public Administration. The most common effect of this failure of Public Administration management is

*corruption*, which takes place whenever there is contempt for the common good and some people transform public affairs in private business and public organizations in personal property (from *public value* to *public (dis)value*). Any information requirement and the citizens' right to interact with the Public Administration whenever it is called to account for its activities, comes from the general principle regarding the social responsibility of public sector companies, in which *accountability* can play a significant role in qualitative terms, in addition to standard economic, financial or otherwise quantitative informational channels. The recent trend about seeking greater levels of *accountability* and transparency (Weihe, 2008; Van Der Wal, 2008; Jorgensen, Sorensen, 2010) in the decisions and actions taken, that affects not only public sector companies but also private businesses, can be related to several factors (Ricci, 2010):

- the different meaning given in recent years to accountability, which is no longer based on mere compliance to rules and regulations but it is now seen as an important tool to facilitate the participation of citizens to administrative action and to inform them about the achievement of targets, thus highlighting areas of responsibility (with relation to managers and politicians) in the measurement of results;
  - a clearer definition of models regarding performance measurement and autonomy determination, in order to properly sort areas of activity between different government levels (*internal governance and accountability*);
1. the creation of representation models aimed at increasing the citizens' knowledge of administrative activities, this way sharing the results achieved (*external governance and accountability*);
  2. the improvement of the quality of public services through the definition of qualitative and quantitative standards for an easier and more immediate assessment of satisfaction levels, as expressed by citizens (customer satisfaction);
  3. the improvement of internal and external control systems in order to facilitate an independent evaluation of the performance realized and the results achieved.

It is important to emphasize here the autonomy gained by local administrations (from programming to management and control stages), the responsibility that comes with it and above all the capability to explain what has been achieved (*accountability*), in order to measure the public value created and to prevent distortions within an adequate system of public governance.

Accountability, as described above, makes therefore possible to *prevent, cope with and limit* corruption phenomena (Banerjee, 1997; Lederman, Loyala, Soares, 2004, 2005; Ricci, Esposito, Landi, 2010). It also

allows the measurement of the public value produced for the whole community by monitoring performance (seen not only as the value of the benefits produced for users and recipients of public activity, but also as the activity carried out to achieve a specific target). There are seven key variables that help to identify a proper accountability system (Ricci, 2010):

- a thorough and clear planning process;
- a clear definition of internal and external responsibilities;
- an effective accounting and extra-accounting detection system;
- an effective internal system for control and evaluation;
- periodic PR campaigns regarding the activities carried out;
- a significant benchmarking activity;
- a proper use of technology with relation to communication processes.

The presence of these factors should facilitate a clearer definition of responsibilities and the implementation of a better assessment process.

Figure 14:

(Use of accountability for bringing to light and tackling the determinants of public dis-value)

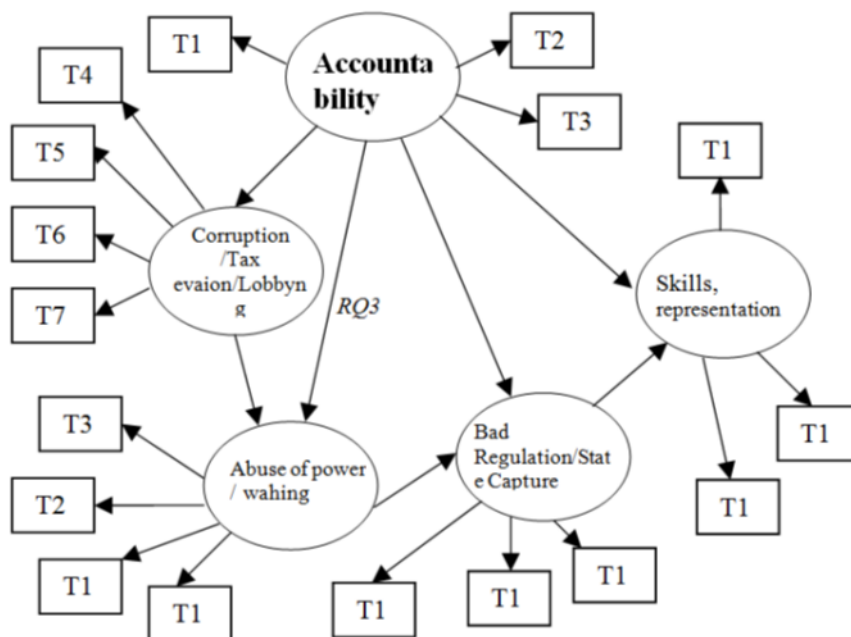



T1 = a thorough and clear planning process

T2 = a clear definition of internal and external responsibilities

T3 = an effective accounting and extra-accounting detection system

T4 = an effective internal system for control and evaluation

T5 = periodic PR campaigns regarding the activities carried out

T6 = a significant benchmarking activity

T7 = a proper use of technology with relation to communication processes

Figure 15:

(Use of accountability for bringing to light and tackling the determinants of public dis-value)

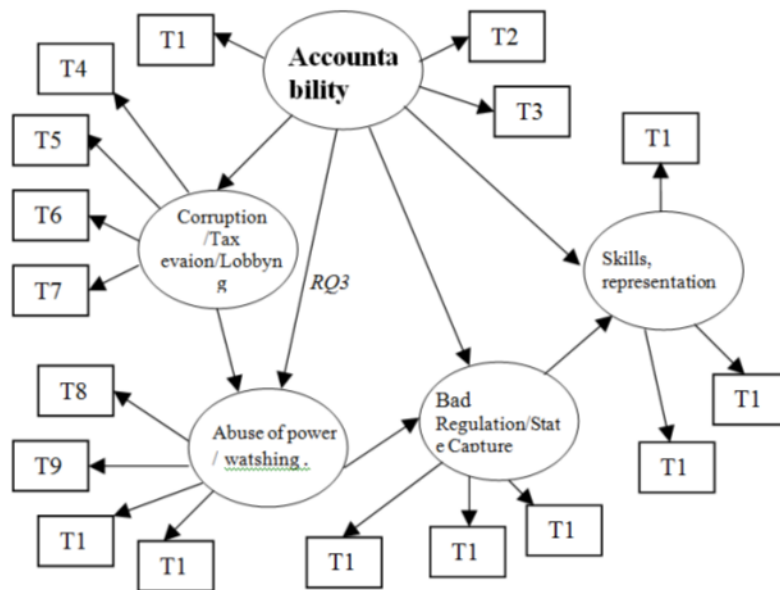

T1 = inadequacy of political capital

T2 = individual and existential damage

T3 = weakening of the State

T4 = weakening of the market

T5 = weakening of control

T6 = reputational damage

T7 = damage to public integrity

T8 = damage to public integrity over time - future generations

T9 = dependability and lack of autonomy

The accountability process (RQ3) put in place by our National Agency with relation to properties confiscated from the Mafia and then released, returned and re-converted in social activities for the community (nurseries, legality laboratories, land to be used for organic food production), has therefore highlighted how *political capital* can transform *public (dis)value* (given by Mafia infiltration of vital business and political ganglia within local authorities, in order to take possession of common

goods and resources). Such (dis)value, through a different and better combination of the factors constituting the *political capital*, undergoes a positive (leading to higher value) *metamorphosis*, through the re-generation of new ethical, reputational, economic values (*plus-value*) to be re-assigned (Onida, 1958) to the whole community.

## REFERENCES

- 't Hart, P.T., (2014), *Understanding public leadership*, Palgrave Macmillan.
- Alford J., O'flynn J., (2009), *Making Sense of Public Value: Concepts, Critiques and Emergent Meanings*, *International Journal of Public Administration*, 32: 171-191.
- Beck Jørgensen, T. & Rutgers, M.R., (2011), *Value dynamics in the public sector: A historical comparative analysis of changes in selection criteria for civil servants*. Paper presented at the 2011 Public Management Research Association Annual Conference, Syracuse University,
- Beck Jørgensen, T., & Bozeman, B., (2007), *Public Values. An Inventory*. *Administration & Society*, 39(3), 354-381, 2007.
- Beck Jørgensen, T., (2006), *Public values, their nature, stability and change: The case of Denmark*. *Public Administration Quarterly*, 30(3): 365-398.
- Benington J., (2015). *Public value as a contested democratic practice*. In Bryson J, Crosby B. and Bloomberg L., *Creating public value in practice*. Boca Raton, Fa: Taylor and Francis.
- Benington, J., Moore M., (2011), *Public value: Theory and practice*. London: Palgrave Macmillan.
- Benington, J. , (2009), *Creating the Public in Order to Create Public Value?*, *International Journal of Public Administration*, 32, 3-4,232-49.
- Benish, A., & Levi-Faur, D., (2012), *New forms of administrative law in the age of third-party government*. *Public Administration*, 90 (4), 886-900.
- Benish, A., & Maron, A., (2016), *Infusing Public Law into Privatized Welfare: Lawyers, Economists, and the Competing Logics of Administrative Reform*. *Law & Society Review*, 50 (4), 953-984.
- Bennington, J. and Moore, M., (2011), *Public value: Theory and Practice*, Basingstoke: MacMillan, 2011.
- Bennister, M, 't Hart, P. and Worthy, B., (2017), *The Leadership Capital Index: A New Perspective on Political Leadership* Oxford: Oxford University Press.
- Bennister, M., (2016), *New approaches to political leadership*. Special Issue of *Politics and Governance* June 2016.
- Black, J., (2008), *Constructing and Contesting Legitimacy and Accountability in Polycentric Regulatory Regimes*. *LSE Law, Society and Economy Working Papers*, 2/2008.
- Boin, A., (2005), *The politics of crisis management: Public leadership under pressure*. Cambridge University Press.
- Boyne G., (1999), *Introduction: processes, performance and best value in local government*, Taylor & Francis, 1999.
- Bozeman, B., Sarewitz D., (2011), *Public Value Mapping and Science Policy Evaluation*. *Springer*, 49: 1-23 2011.
- Bozeman, B., (2002), *Public value failure: When efficient markets may not do*. *Public Administration Review* 62(2): 145-161, 2002.
- Bozeman, B., (2007), *Public values and public interest: Counterbalancing economic individualism*. Washington, D.C.: Georgetown University Press, 2007.
- Broadbent J., Laughlin R., (2003), *Control and legitimation in government accountability processes: the private finance initiative in the UK*, *Critical perspectives on accounting*, Elsevier.
- Broadbent j. and Guthrie J., (2008), *Public sector to public services: 20 years of "contextual accounting research"*, *Accounting, Auditing and Accountability Journal*, 21:2, pp. 129-169.
- Brodkin, E. Z., (2011), *Policy work: Street-level organizations under new managerialism*. *Journal of Public Administration Research and Theory*, 21, 253-277.
- Bryson, J., Sancino, A., Benington, J., Sørensen E., (2016), *Towards a multi-actor theory of public value co-creation*, *Public Management Review*, <http://www.tandfonline.com/doi/full/10.1080/14719037.2016.1192164>
- Byrkjeflot, H., Christensen, T., & Lægred, P. , (2014), *The many faces of accountability: Comparing reforms in welfare, hospitals and migration*. *Scandinavian Political Studies*, 37 (2), 171-195. 4
- Considine, M., (2002), *The end of the line? Accountable governance in the age of networks, partnerships, and joined-up services*. *Governance*, 15(1), 21-40.

- Court Of Auditors, (2011), *Misure e stime della corruzione: una sfida (im)possibile?*, SSPA.
- Craig S. N., (2003), *Corporate Social Responsibility: whether or how*, California Management
- CROSBY B.C., BRYSON J.M., (2005a), *Leadership for the Common Good: Tackling Public Problems in a Shared-Power World*. 2nd ed. San Francisco: Jossey-Bass.
- Crosby B.C., Bryson J.M., (2005b), *A Leadership Framework for CrossSector Collaboration*, *Public Management Review* 7 (2): 177 – 201.
- Crosby, B. and Bryson, J., (2005), *Leadership for the common good: Tackling public problems in a shared-power world*. New York: Wiley.
- Dahrendorf R., (1994), *The condition of Citizenship*, Sage, London.
- Della Porta D., Vannucci A., (2012), *The Hidden Order of Corruption: An Istitutional Approach*, Burlington, VT: Ashgate.
- Denhardt J., Denhardt R., (2003), *The new Public Service – Serving not Steering*, New York: M.E. Sharp.
- Eisenhardt K., (1989), *Building theories from case study research.*, *Academy Management Review*, 14(4):532–50.. 1989): 532-550.
- Esposito P., (2012), *Integrity distorsions and public policies in the local P.A.'s. Theoretical lines, emerging practices, contradictions: a first path of conceptualization*, *Rirea*, 7/8, Roma.
- Esposito P., Ricci P., (2015), *How to turn Public (dis)Value into new Public Value? Evidence from Italy*, *Public Money & Management*, Vol. 1/2015, Taylor & Francis.
- Esposito P., Ricci P., (2014), *Public (dis)Value: A case study*, in *Public Value Management, Measurement and Reporting* (in J. Guthrie, G. Marcon, S. Russo, F. Farneti), Emerald Group Publishing.
- Getha-Taylor, H., M.H. Holmes, W.S. Jacobson, R.S. Morse and J.E. Sowa, (2011), *Focusing the public leadership lens: research propositions and questions in the Minnowbrook tradition*. *Journal of Public Administration Research and Theory*, 21, 1 Supplement, i83–97.
- Heifetz R.A., (1994), *Leadership without easy answers*. Cambridge, Ma: Harvard University Press.
- Hood C., (2000), *The Art of the State: Culture, Rhetoric, and Public Management*
- Huberts, L.W.J.C., (1998), *Blinde vlekken in de politiepraktijk en de politiewetenschap*; Gouda Quint/Vrije Universiteit: Amsterdam, 1998.
- Iengo I., Armiero M., (2017), *The politicization of ill bodies in Campania, Italy*, *Journal of Political Ecology* 24: 44-58.
- Kang, D.C., (2002), *Crony Capitalism: corruption and development in South Korea and the Philippines*, Cambridge University Press, Cambridge.
- Kelly G., Mulgan G. & Meurs S., (2002), *Creating Public Value, An Analitical Framework for Public Service Reform*, Discussion paper prepared by the Cabinet Office Strategy Unit of United Kingdom.
- Kolthoff, E.W., Huberts L.W.J.C., and Van den Heuvel, J.H.J., (2006), *'The Ethics of New Public Management: Is Integrity at Stake?'* *Public Administration Quarterly* 30 (4): pp. 397-435.
- Lodge, M., & Stirton, L., (2010), *Accountability in the regulatory state*, In: Baldwin, Robert and Cave, Martin and Lodge, Martin, (eds.) *The Oxford Handbook of Regulation*. (Oxford University Press).
- Macey, J. R., (2014), *Crony Capitalism: Right Here, Right Now*. Yale Law School. Faculty Scholarship Series. Paper 4829
- Mashaw, J., (2006), *Accountability and institutional design: Some thoughts on the grammar of governance*. In M. W. Dowdle (ed), *Public Accountability, Designs, Dilemmas and Experiences*, Cambridge, UK: Cambridge University Press, pp. 115–156.
- Mattei, P., (2009), *Restructuring welfare organizations in Europe: from democracy to good management?* (Basingstoke: Palgrave MacMillan)
- MCNALLY D., (2016), *Norms, Corruption, and Voting for Berlusconi*, *Politics and Policy*, Volume 55, Issue 44, pp. 817-1008, Wiley.
- MENZEL D., (2003), *State of the Art of Empirical Research on Ethics and Integrity in Governance*, Paper presented at the Annual Conference of The European Group of Public Administration, Oeiras, Portugal, 3-6 September, 2003.
- Moore M., (2013), *Recognising public value*. Cambridge, Ma: Harvard University Press.
- Moore, M., (1995), *Creating public value*. Cambridge, MA: Harvard University Press.
- Morse R., (2010), *Integrative public leadership: Catalyzing collaboration to create public value*. *The Leadership Quarterly*, 21(2), 231–245
- Mulgan, R., (2000), *'Accountability': An Ever-Expanding Concept?*, *Public administration*, 78 (3), 555-573.
- Mulgan, R., (2003), *Holding power to account: accountability in modern democracies*. Springer.
- O'flynn J., (2007), *From New Public Management to Public Value: Paradigmatic Change and Managerial Implications*, *Australian Journal of Public Administration*, 66 (3), 353-366.

- OECD, Recommendation on Improving Ethical Conduct in the Public Service, 1997.
- Pedersen D., Hartley J., (2008), The changing context of public leadership and management: Implications for roles and dynamics. *International Journal of Public Sector Management*, 21, (4) 327-339
- Putnam R., (1993), *Making Democracy Work: Civic Traditions in Modern Italy*, Princeton (NJ), Princeton University Press.
- Putnam R., (1995), *Bowling Alone: America's Declining Social Capital*, in «*Journal of Democracy*», vol. 6, pp. 65-78.
- Rhodes, R. A. W and 't Hart, P., (2014), *The Oxford handbook of political leadership* Oxford: Oxford University Press.
- Ricci P., (2011), Article 41 of the Italian Constitution and the Italian Model of Corporate Social Responsibility, in *Review of International Comparative Management*, Academy of Economic Studies Bucharest, Volume 12, Issue 3, July 2011.
- Saviano, R., (2007), *Gomorra: a personal journey into the violent international empire of Naples' organized crime system*. Translated by V. Jewiss. New York: Picador.
- Saviano, R., (2015), *Stili di vita nella Terra dei fuochi*, L'Espresso 20 Feb. [Accessed October 5, 2015]. <http://espresso.repubblica.it/opinioni/l-antitaliano/2015/02/17/news/stili-di-vita-nella-terra-dei-fuochi-1.199783>.
- Scott, C., (2000), Accountability in the regulatory state, *Journal of Law and Society* 27, 1: 38–60. 5 .
- SCOTT, C., (2006), Spontaneous accountability, In M. W. Dowdle (ed), *Public Accountability, Designs, Dilemmas and Experiences*, Cambridge, UK: Cambridge University Press, pp. 174–191.
- Shah A., (2007), *Performance accountability and combating corruption*, The Work Bank, Washington DC, 2007.
- Smith, R.F.I., (2004), Focusing on Public Value: Something New and Something Old, *Australian Journal of Public Administration*, 63, 4, 68–79.
- STIRTON, L., LODGE, M., (2001), Transparency mechanisms: Building publicness into public services. *Journal of Law and Society*, 28(4), 471-489.
- Stoker, G., (2006), *Public Value Management: A New Narrative for Networked Governance?*, American Review of Public Administration, 36. Sage Publications.
- Storey J, Hartley J, Denis J-L, 't Hart P and Ulrich D., (2017), *The Routledge companion to leadership*. New York: Routledge.
- TERRY, L. D., (1998), "Administrative Leadership, New Managerialism, and the Public Management Movement," *Public Administration Review* 58(3): 194–200.
- Thompson F., (1991), Management control and the pentagon: The organizational strategy-structure mismatch, *Public Administration Review*, 1991.
- Uhl-Bien, M., Marion, R., & McKelvey, B., (2007), Complexity leadership theory: Shifting leadership from the industrial age to the knowledge era, *The Leadership Quarterly*, 18(4), 298-318.
- Van Der Wal Z., Nabatchi T. & De Graaf G., (2013), From Galaxy to Universe. A Cross-Disciplinary Review and Analysis of Public Values Publications from 1969 to 2012. *The American Review of Public Administration*.
- Van der Wal, Z., L.W.J.C. Huberts, J.H.J. van den Heuvel & E.W. Kolthoff., (2006), Central Values of Government and Business: differences, similarities, and conflicts. *Public Administration Quarterly* 30 (3): 314-364, 2006.
- Van Wart, M., (2003), Public-sector leadership theory: An assessment, *Public Administration Review*, 63:214–28.
- Wal, Z. & L.W.J.C. Huberts, (2008), Value Solidity in Government and Business. Results of an Empirical Study on Public and Private Sector Organizational Values. *American Review of Public Administration* 38 (3): 264-285, 2008.
- Yin R.K., (1995), *Case study research. Design and methods*, 2<sup>nd</sup> eds, Sage, US.
- Yin R.K., (1989), *Case study research. Design and methods*, London, Sage.

## ANNEXES

Table - Definitions of corruption in national and international literature

SOURCE	DEFINITION
Friedrich (1966)	Public-interest centered: The pattern of corruption can be said exist whenever a power holder who is charged with doing certain things, i.e., who is a responsible functionary or officeholder, is by monetary or other rewards not legally provided for, induced to take actions which favour whoever provides the rewards and thereby does damage to the public and its interests
Nye (1967)	Public-office-centred category: Corruption is behaviour which deviates from the formal duties of a public role because of private-regarding (close family, personal, private clique) pecuniary or status gains
Rose-Ackerman (1978)	Illegal or unauthorized transfer of money or an in-kind substitute. If we consider both the supply side and demand side of the phenomenon, from the supply side, the person bribed for any service must necessarily be acting as an agent for another individual or organization since the purpose of the bribe is to induce him to place his own interests ahead of the objectives of the organization for which he works
Klitgaard (1988)	The divergence between the principal's or the public's interests and those of the agent or civil servant: corruption occurs when an agent betrays the principal's interest in pursuit of her own...: [Corruption = Monopoly + Discretion – Accountability]
Heidenheimer et al (1989)	Market centered: A corrupt civil servant regards his public office as a business, the income of which he will seek to maximize. The office then becomes a 'maximizing unit'. The size of his income depends upon the market situation and his talents for finding the point of maximal gain on the public's demand curve
Tarkowski (1989)	Any activity motivated by interest, violating the binding rules of distribution, the application of which is within one's responsibility. Rules of distribution . . . refer not only to the letter of the law, but also to norms recognized as binding by society and/or to the system's 'official' norms and operational codes. Also 'corrupt' are those activities regarded by society as illegitimate or seen by the power elite as contradictory to the logic of the system
Thompson (1993)	Includes the three main elements of the general concept of corruption: a public official gains, a private citizen receives a benefit, and the connection between the gain and the benefit is improper
Johnston and Hao (1995)	The abuse, according to the legal or social standards constituting a society's system of public order, of a public role or resource for private benefit
Bardhan (1997)	The use of public office for private gains
Hellman, Jones, Kaufmann, Schankerman (2000)	The search for effective methods of combating corruption has led to an increasingly wide recognition that corruption is fundamentally a problem of governance. Corruption thrives where states are too weak to control their own bureaucrats, to protect property and contract rights, and to provide the institutions that underpin an effective rule of law. Consequently, recent studies of corruption have tended to focus on key characteristics and policies of the state, especially the extent of state intervention in the economy and the degree of discretionary power of bureaucrats.... The opportunity for officials to engage in corruption depends in part on the discretionary power they hold and the degree of accountability they face within the state apparatus
Argandona (2001)	Non-performance of a duty, mandate, law, regulation, rule, contract or (explicit or implicit) commitment to act always in accordance with the interests of the public office or company in which the corrupt person renders his service

Broadman and Recanatini (2001)	I Formula on Corruption: Corruption = f (quality of governance, the quality of institutions, policies)
Amundsen (2002)	Everything from paying bribes to civil servants and simple theft of public purses, to a wide range of dubious economic and political practices in which business people, politicians and bureaucrats enrich themselves
Huber (2002)	... a deterioration in the decision-making process in which the decision maker (in a private enterprise or public sector) or allow the diversion request to deviate from the criteria that should guide decision-making in exchange for a reward, or promise of the expectations of it, while these reasons in its decision-making influence cannot be part of the justification for the decision
Ian Senior (2006)	Corruption is a cancer. Where a briber does so as a favor to a corrupt secret or any person referred to influence actions that may benefit the corruptor or the person named and which has bribed the authorities
Manzetti and Wilson (2007)	An illegal transaction where public officials and private actors exchange goods for their own enrichment at the expense of society at large
Apaza, C. R. ,(2007)	Preventing corruption is as complex as the phenomenon of corruption itself and a combination of accountability mechanisms and effective law enforcement mechanisms are needed for success. Public organizations need to be effective and accountable to the public. This means that there must be proper mechanisms of control as a way of assuring accountability and preventing corruption
Borgonovi (2002)	The term "corruption" implies the existence of objective factors (the damage to their institution or external parties) of formal elements (the existence of rules that prohibit certain behaviors), the subjective elements (knowledge assuming that certain choices will cause harm and the willingness to do so). This analysis should focus on the concept of behavior (actions and decisions) consistent with the purposes of an institution (public or private) and the factors that facilitate the search for consistency this or that contribute to, encourage or make it easier inconsistency. These three factors, namely: a) quality of the rules; b) detailed rules; c) individual and social values prevailing at certain times in certain societies
Borgonovi (2006, 2008)	Corruption are the consequences of attitudes that have privileged interest of the individual to the detriment of "intergate economic institutions and firms from which to hang the work, and welfare of thousands of people
Meneguzzo (2006)	... corruption (the "use of" public authority to private interests)

*Reference: Our illustration*

**Table – National and International Institutions’ interventions in fighting corruption**

SOURCE	DEFINITION
Pope Pio X (1905)	Ignorance of religion depends on the corruption of morals today
Oxford English Dictionary (1989)	Perversion or destruction of integrity in the discharge of public duties by bribery or favour; the use or existence of corrupt practices, especially in a State, public corporation, etc.
PUMA (Rowney, 1997)	As far as public-sector ethics are concerned, corruption is a management problem... corruption is therefore not a cause, but a symptom of breakdown... corruption in systemic failure
World Bank (1999)	The abuse of public office for private gain
World Bank (2000)	The tendency by some elite firms and conglomerates to shape illicitly the formation of the state laws, policies and regulations
OECD (2000)	As far as public-sector ethics are concerned, corruption is a management problem. Corruption is therefore not a cause, but a symptom of breakdown
OECD (2004)	Corruption is the tip of the iceberg
UN (2006)	Article. 15 of the United Nations Convention against corruption: .. a crime, when committed intentionally, promise, offer or grant to a public official, directly or indirectly, of an undue benefit to the officer himself or for another person or entity, to ensure that the officer performs certain acts or refrain from acting in the exercise of its functions officers, and the solicitation or acceptance by a public official, directly or indirectly, of an undue advantage,for the official himself or another person or authority to make the officer carrying out certain acts or refrain from acting in the exercise of their official duties. The UN Convention against Corruption which shows well the word 107 times and never call it corruption and instead defines a bribe
Trasparency International (2007)	The misuse of entrusted power for private gain
Catholic Church -Encyclical Pope Benedetto XVI (2009)	Also weigh corruption, lawlessness and irresponsibility of the poor countries where social norms and cultural patterns persist that hinder the development process.....going against justice and the free market

*Reference: Our illustration*

# IS THERE A MEDITERRANEAN CORPORATE GOVERNANCE SYSTEM? EVIDENCE FROM LITERATURE

Ricci, Paolo; Esposito, Paolo; Fusco, Floriana

Department of Law, Economics, Management and Quantitative Methods, University of Sannio, Benevento, Italy

## ABSTRACT

This paper aims to describe and explain corporate governance in Italy and, secondly, to provide an overview of corporate governance in the other main Mediterranean countries in order to verify whether a common model exists. Although there are contact points in terms of industrial structure, ownership structure and poor contestability of capital, the findings of the review does not confirm the hypothesis. Indeed, the Italian system shares only with the Portuguese one the presence of the three options and the prevalence of the horizontal two-tier model. However, it is characterized by both lesser specificity of alternative systems and less convergence towards the Anglo-Saxon system.

*Keywords: corporate governance, Mediterranean countries, Italy, Corporate ownership*

## 1. INTRODUCTION

Starting from the beginning of the new century, the creation of a corporate governance system more focused on the needs of controls and efficiency has found a strong and growing interest on lawmakers, academic scholars and experts. The markets globalization and the international capital mobility have made crucial to increase investor confidence and therefore a deep rethinking of rules system available to "consumers of legal rules" for coordination, government and control of the factors of production (Ghezzi and Bianchi, 2006; Aguilera and Cuervo-Cazurra, 2009; Martinez-Blasco et al., 2017).

Hence, the typical and clear distinction between the two main and dichotomous systems - the Anglo-American, characterized by short-term equity finance, dispersed ownership and strong shareholder rights, active capital market and flexible labor markets; and the Continental European, marked out long-term debt financing, concentrated ownership, weak shareholder rights, underutilized capital markets and rigid labor markets (Aguilera and Jackson, 2010) - are abandoned in favor of mixed models, which took into account how different institutional systems responded to global pressures. This has only changed and does not reduce comparative corporate governance studies, which focus on research questions such as: what is the corporate governance models in different countries? What



aspects are similar and what dissimilar? In which countries and why? Is it possible to identify international best practices of corporate governance? Is it really possible to adapt these systems to different contexts?

What factors explain the stability, change, or convergence of corporate governance practices over time and space? The findings are not consistent.

The present study, fitting in this field and basing on a qualitative approach, aims to describe and explain corporate governance in Italy and verify whether a Mediterranean corporate governance model exists. At this end, it reviews the existing literature and the current legal system in order to give an overview of the state of art in the three main Mediterranean Countries and deduce some conclusions about the possibility of a specific kind of a corporate governance system. It is necessary to underline that the prior focus is on Italy, from which it starts to highlight common or divergent aspects with the other countries analyzed.

## 2. LITERATURE REVIEW

The expression "Corporate Governance" came to be associated in the 1990s with concern over many ethical issues in business, and high profile corporate scandals in many countries. The subject has been stressed by scholars from a different perspectives, including economics, management, law, political science, culture, and sociology. This multidisciplinary approach has caused numerous definitions to be proliferated, each aiming to highlight some specific aspects. For instance, in a managerial and sociological approach, Aguilera and Jackson (2010, p.487) argue that "*corporate governance may be defined broadly as the study of power and influence over decision making within the corporation*". A more legal aspect is highlighted by Aoki (2000, p. 11), according to which it concerns "*the structure of rights and responsibilities among the parties with a stake in the firm*"

In a relationship perspective, some definitions focus on the interaction between the various actors involved in the process. Monks and Minow (1995) consider it as the "*relationship among various participants (chief executive officer, management, shareholders, employees) in determining the direction and performance of corporations*". Many scholars emphasized the agency theory aspects, for example, Shleifer & Vishny (1997) describe it as the way in which "*investors get the managers to give them back their money*". So, corporate governance is the answer to the demand of accountability to providers of capital. Moreover, the most traditional framework within researchers has studied corporate governance is the agency theory (Shleifer & Vishny, 1997; Dalton et al., 2007; Schmidt and Fahlenbrach, 2017), viewing the modern corporation as a nexus of contracts between principals (risk-bearing shareholders) and agents (managers with specialized expertise). However, different theories are increasingly used, such as the stakeholder theory and institutional theory. In a stakeholder

perspective, it is the process by which companies response to the right and wishes of stakeholders (Demb and Neubauer, 1992). Referring to the stakeholder theory, inevitably, bring up to the CSR construct, and, in fact, there are many studies on the relationship between corporate governance and social responsibility (Hong et al., 2016). In this direction, interesting is the definition of Adrian Cadbury (1992), according to which *“Corporate Governance is concerned with holding the balance between economic and social goals and between individual and communal goals. The corporate governance framework is there to encourage the efficient use of resources and equally to require accountability for the stewardship of those resources. The aim is to align as nearly as possible the interests of individuals, corporations and society”*. However, some authors argued that the exclusive link to a very specific micro-economic or managerial problem setting is a strong limitation for the understanding of the issue, especially in the comparative corporate governance field. For these reason, they have embraced the institutional theory, considering the institutional, legal, and cultural environment (Esposito, 2012, 2014, 2015), in which organizations and decisions are embedded as a decisive element (i.e. Cosset et al., 2016). In this sense, corporate governance is *“the whole set of legal, cultural, and institutional arrangements that determine what public corporations can do, who controls them, how that control is exercised, and how the risks and return from the activities they undertake are allocated.”* (Blair, 1995). A medium perspective has been embraced by Aguilera and Jackson (2003), that applied the actor-centered institutionalism, in stressing the interplay of institutions and firm-level actors. The authors consider this model the “bridge” to close the gap between undersocialized agency theory approaches and oversocialized views of institutional theory (see also Aguilera et al., 2008). In other words, the way to have a perspective not too short-sighted or too abstract and to take into account both the institutional and the microeconomic environment (Ducassy and Guyot, 2017). The institutional perspective has also been embraced by most scholars interested in cross-nationally comparative corporate governance, since the different national corporate governance models can hardly be analyzed without considering the diversity of wider institutional environment (i.e. country-system) in which they are inserted. Not by chance, in fact, it can be defined as *“the study of relationships between parties with a stake in the firm and how their influence on strategic corporate decision making is shaped by institutions in different countries.”* (Aguilera and Jackson, 2010)

### 3. CORPORATE GOVERNANCE IN ITALY

The pressure to change, above mentioned, have led to a rewriting of company law, with the approval of the Legge Delega 366/2001 and, then, Decreto Legislativo 6/2003, whose rules were included in Italian Civil Code. Scholars of commercial law identified the guiding general principles of reform, which were, among others:

- to encourage the development of a *regulatory competition*, namely a market for competition between national legislators to increase levels of competitiveness and entrepreneurial attractiveness;
- to adapt the scope of statutory autonomy, safeguarding the need for the protection of economic subjects (Ricci, 2012) and their different interests involved;
- to clearly define the tasks and responsibilities of the corporate bodies;
- to develop a non-monodirectional process of creating and circulating information (Article 2392 of the Italian Civil Code), providing that each administrator may request delegated bodies to provide information on the management of the company to the Board - Article 2381 of the Italian Civil Code - diligently fulfilling the duty to act in an informed manner - Article 2392, paragraph 1 - to make the decisions in the maximum corporate interest (Angelici, Ferri, 2011; Di Sabato, 2011);
- to improve a circular system for collecting and disseminating information between the administrative and control bodies (Article 2409-septies c.c.).

The entire Section VI-bis of the Civil Code dedicated to corporate governance and controls was fully revised with the introduction of twenty-three new provisions.

Thus, the reform, as foreseen by the principles established in Legge Delega 366/2001, has radically modified composition and responsibilities (Graziani et al., 2011) of the administration and supervisory boards in joint stock companies.

Specifically, it aimed at

- a) increasing the statutory autonomy with reference to the internal articulation of the administrative body, its operation, the circulation of information between its members and the bodies responsible for control; as well as to specify the contents and limits of delegation to administrators or executive boards;
- b) recognizing the possibility, when not already required by law, of introducing specific requirements of integrity, professionalism and independence for the assignment;
- c) defining more clearly the competences and responsibilities of the administrative body, as well as the role of independence of the board of statutory auditors;
- d) providing the choice from three corporate governance system, instead of one as before;
- e) regulating the duties of administrative body, in particular with reference to situations of conflict of interest.
- f) strengthening the administrative body by increasing its centrality rather than the shareholders' meeting.

Some clarifications are needed about the introduction of two systems of corporate governance alternative to the "traditional Italian model": the dualistic model of German inspiration and the monistic model typical of Anglo-Saxon countries. First of all, it should be noted that the traditional system is also applied without the express statutory provision, instead the others two must be explicitly adopted when the company was formed or with a subsequent statutory revision.

I) The traditional system is based on the presence of two bodies appointed by the shareholders' meeting: the Board of Directors and the Board of Statutory Auditors, with functions limited to administrative control. Accounting auditing is instead entrusted to an external body. Specifically, in joint-stock companies not listed, the supervisory board (or Boards of Statutory Auditors) can carry out both management-administrative and accounting auditing; while in listed companies, there is the obligation to confer the accounting audit to an external audit company.

Anyway, there is a strong separation between administration and auditing bodies, as their members are separately elected from the shareholders' meeting.

The administrative body may have a single body (single director) or a collegial body (board of directors) with the exclusive tasks of:

- representing the company towards third parties;
- managing in compliance with the statutory aims for the pursuit of the corporate purposes.

The presence of the "*simul stabunt simul cadent*" clause is frequent, which states that the entire board of directors should resign when the majority, the minority or even one director comes down.

Given the centrality of the traditional model, the lawmaker wanted to offer the opportunity to access a "market of rules" with flexible, different and alternative models, which, as said, must be explicitly chosen.

II) The dualistic system (inspired on European continental model), that in Germany has accompanied the experience of codetermination, with a strong presence of workers in supervisory bodies in companies), involves the presence of a Supervisory Board, elected by shareholder's meeting and a Management Board, from the first appointed.

The supervisory board have the competences that in the traditional system are on shareholders' meeting responsibilities. So, dualistic system realizes a real "dissociation between property (of members) and power (of social bodies)", since all the competences of the ordinary shareholders' meeting are attributed to the supervisory board. These bodies are joined by relying on accounting control, the individual auditor or the auditing company.

The Supervisory Board, unless otherwise provided, consists of three members who may be or not shareholders and shall remain in office for three years. The authority of this body is to appoint and

remove the members of the board of directors, the application of the responsibility action, the approval of the financial statements, and the exercise of the control functions on management that in the traditional system are in charge of Board of Auditors. The Management Board, on the other hand, consists of at least two components which may be or not to be shareholders, and which remain in office for a period not exceeding three years. Its task concerns the management of the company.

III) The monistic system inspired by the Anglo-Saxon models is characterized by the abolition of the board of Auditors (or Supervisory Board). Some authors considered it less revolutionary and innovative than the dualistic system (Di Sabato, 2011). To the board of directors, elected by the shareholders' meeting, are applied the same provisions as the traditional system.

It is necessary that at least one-third of the members of the board of directors are in possession of the impartiality requirements established for the advisory board and those others eventually provided in the specific conduct code of conduct. The members of the Management Control Committee are appointed by the same Board of Directors between those who hold these independence requirements, as well as the requirements of integrity and professionalism provided for in the By-Laws (Campobasso, 2011). At least one component must be selected among the subjects entered in the register of auditors. They cannot be members of the executive committee, not even in parent companies or subsidiaries.

Despite the wide diffusion, this system suffers from a severe weakness, namely the controllers (the auditors) are appointed by and among the controlled (the directors), they sitting and voting together (Ricci, 2012).

The main features of three systems are summarized in table 1.

Recent researches have shown that corporations in Italy continue to prefer the traditional model (about 99%), while little use is the monistic and dualistic system, which is almost nil in the Southern Regions. Lombardy (Milan, in particular) is the region characterized by the largest number of companies applying the alternative models (Bellavite Pellegrini et al., 2010; Chamber of Commerce of Milan, 2013).

Among the alternative, the monistic model is more used, while the dualistic one, after having registered a certain diffusion in the immediate aftermath of the reform, it has sharply declined (Chamber of Commerce of Milan, 2013; Alvaro et al., 2015).

The scenario does not change much if it narrows the scope to only listed companies (Bellavite Pellegrini et al., 2010; Consob 2016).

*Table 1 – The italian alternative CG system*

	Nomination	Composition	Responsibilities
--	------------	-------------	------------------

Traditional system			
Single administrator or Board of Directors	Shareholders' meeting	Number established by shareholders' meeting or by-law. Also no shareholders	Management competences.
Board of Statutory Auditors	Shareholders' meeting	Three or five members.	Management and/or accounting control.
Dualistic system			
Management Board	Supervisory Board	At least two members, also no shareholder.	Management competences.
Supervisory Board	Shareholders' meeting	At least three members.	Supervisory functions and the responsibilities of the Board of Statutory Auditors, as well as a large part of the functions of the ordinary Shareholders' Meeting.
Monistic system			
Board of Directors	Shareholders' meeting	Number established by shareholders' meeting, but at least 1/3 with independence requirements	Management competences.
Management Control Committee	Board of Directors	Number established by the Board of Directors.	Management and/or accounting control.

Source: Our elaboration from Esposito P., 2012.

The Consob Report 2016 on the corporate governance of listed companies in the Italian Stock Exchange reports that by the end of 2015, in substantial continuity with the data for the previous years, 228 companies out of 234 adopt the traditional model, two the monist and the other four the dualist. The poor diffusion of the alternative models can be attributed to a number of factors. One of

these is surely the typical prudence - or cultural resistance to change - of entrepreneurs, and in general of the Italian capitalist and legal systems. However, what seems to be the main reason for not adopting the alternative models is that the legislative provisions contained do not constitute an autonomous and well-articulated corpus, but it is characterized by the “referral technique” to the traditional system.

In this way it has been reduced the differentiation between models and hence the perception of the utility and innovation of those newly introduced (Alvaro et al., 2015).

Regarding the Italy's capitalist structure, it comprises a large number of small and medium-sized enterprises, with a market of capital little developed not only compared to the American market, but also to some of the European ones (UK and Continental countries).

The ownership of the majority of companies is strictly owned by a small number of people and is almost always in the hands of a single family. The 84% of listed Italian companies are controlled by one or more shareholders. On 234 companies, 115 are controlled with a quota higher than 51%, 52 through a quota lower than 50% and 30 through a shareholders' agreement. Only 15 are classified as public company, without a controlling shareholder and with a float exceeding 70% of the share ordinary capital (Consob, 2016). Although the traditional features of the Italian system are confirmed, in terms, these data attest a little decrease of high proprietary concentration and limited contestability of the control.

## 4. CORPORATE GOVERNANCE IN MEDITERRANEAN AREA

### 4.1 Evidence from Spain

The structure of *Sociedades anónimas* (SA) under Spanish law finds its main characterizations in the *Código de Comercio* of 1885 and in law n. 24/1988 of *Mercado de Valores* (LMV). On the other hand, the Franco dictatorship has considerably delayed the process of modernizing Spanish company law (started from 1978), which in fact cannot be said yet concluded. However, the reform process has not affected the corporate governance system – traced back to the monistic model - that companies are required to adopt.

The system, in fact, provides a Shareholders' Meeting, which appoints external auditors and the Board of Directors. The latter has competences of management and oversight and establishes an Internal Control Committee. Therefore, although the Shareholders' Meeting has the power to appoint and revoke the Board of Directors and the external auditors, it hold a little control over management, which mainly competes with the non-executive component of the Board of Directors, in accordance with the monistic model (Alvaro et al., 2015). The Spanish Board of Directors is in office for six years and it is composed of a number ranging from 5 to 15. The company is called to ensure an efficient

balance between administrators with and without any delegation (Martinez-Blasco et al., 2017) , provided that the majority component should be non-executive and formed for at least 1/3 by independent members (anyway, at least two).

There are four different categories of directors:

- executive or internal directors with administrative functions;
- Non-executive or external directors representing the property,
- Independent and non-executive directors;
- "gray" directors who have lost the previous qualification of independent or executive directors but who remain in the company on the basis of their experiences and competences.

External Auditors are selected from professionals registered in the register set up at the Ministry of Economy and Programming and are in office from 3 to 9 years. Their appointment has been made compulsory for companies that exceed the limits for budget preparation in shortened form by the transposition of the 4th European Directive.

The industrial system is based on small and medium-sized enterprises, in fact the Spanish Stock Exchange only counts 35 companies. Among these, the average float was at the end of 2013 at 60.4%, specifically 28 companies had a float higher than 40%, including 8 higher than 80%. The average capital held by significant shareholders decreased to 28.4% of the capital; in 17.1% of the Ibox companies, any individual or legal entity held the majority of voting rights or exercised or could exercise control (CNMV, 2013). The stock market, albeit small and underdeveloped, reveals interesting trends.

#### *4.2 Evidence from Greece*

Greek companies are governed by Law 2190/1920. In addition, listed companies are governed by Law 3016/2002. The corporate governance system is a monistic type, because there are a shareholders' meeting, a Board of Directors and an Internal Audit Committee, composed by non-executive members of the Board of Directors whose power and duties are clearly described during the approval of their appointment by the general shareholders' meeting. At least 1/3 of the total directors must be non-executive, of which at least two must be independent. The liability of the managing director (equivalent to a chief executive officer) is much stricter than that of other senior managers of board members. (Spanos, 2005). The compulsory of an supervisory board is provided only by the new law for listed company (3016/2002), while the basic law does not expect it. As in Italy, the Greek structure is based on family owned, or anyway, small and medium size, companies.

#### *4.3 Evidence from Portugal*



The Portuguese Stock Exchange is small and characterized by many family companies (Oliveira et al, 2010). Traditionally, ownership of Portuguese companies is highly concentrated, so there is a low level of free-float (Rodrigues et al., 2017). The main legal source of corporate governance rules are the Portuguese Commercial Companies Code, enacted by Decree-Law No. 262/86 and the Portuguese Securities Code, enacted by Decree-Law No. 486/99. Significant changes were also made by the new Corporate Governance Code, approved in 2013. Starting from 2006, Portuguese companies may choose between three corporate governance structures: i) the horizontal two-tier model or “latin model” that is the most popular system and involves the presence of a Shareholders' Meeting appointing the Board of Directors and a Supervisory body, whose members are chosen from a list; ii) the vertical two-tier model or “German model” where the Shareholders' Meeting appoints a Supervisory board, which - subject to statutory derogation - in turn appoints an executive management board; iii) the monistic or anglo-saxon model, where the board of directors, chosen by Shareholders' meeting, is divided into an executive committee and an audit committee.

## DISCUSSION AND CONCLUSION

The study provides an overview of the corporate governance system in Italy, from a comparative point of view with the Mediterranean countries, at the end to verify the existence of a common model. According to an institutionalist approach, the hypothesis is that countries with similar cultural, geographic and institutional features have found similar solutions to respond to corporate governance issues. Indeed, it is undeniable the similarity of the capitalist systems of the Mediterranean countries, which the literature defined “family/state capitalism” (Tylecote, 2007) or also “compensating state” (Hancké et al., 2007). They are characterized from small and medium-sized enterprises - predominantly family owned -, a low number of big companies with a high concentrated ownership and a little free-float, a consequent centrality of banks in financing and, last but not least, an important role of State. However, despite these similarities, a common corporate governance model is not recognizable. It doesn't exist a Mediterranean model. With a different awareness of internal controls issue - due also to a greater or lesser development of the economy - Spain and Greece adopt comparable monistic (or one-tier) models, that, along the imaginary line with the stylized dichotomy Anglo-Saxon vs. Continental at the extremes, seems to tend to an Anglo-Saxon system. As well as Italy, Portugal has the threefold option, however, although with a clear prevalence of the horizontal dualistic system, companies with greater capitalization seem to go towards convergence with the monistic system. The Italian system constitutes a separate case, not only for the formal coexistent of three different options, but mainly for the peculiarity of its “traditional model”, which, as said, remains almost the only model and for two orders of reason:

- it is adopted by about 90% of joint stock companies;
- the legislative discipline of alternative models is lacking and often refers to the traditional model, thus reducing the diversity of systems.

More generally, it should highlight, therefore, two opposing thrusts: on the one hand, there is a process of convergence towards the Anglo-Saxon model, on the other hand overall these changes are occurring in such a way that the diversity across and within countries remains a key feature (Edwards, 2004). The paper points to an original overview of the state of the art, since there are no a rich literature dealing with all these countries of Mediterranean area (Portugal has been included as part of the Iberian peninsula), but it suffers from some limitations. Firstly, it needs to be implemented and deepened, also with the introduction of France and a more systematic analysis. Moreover, it would be interesting to test the findings with an cross-country and empirical research.

## REFERENCES

- Aguilera, R. V. (2003a). Are Italy and Spain mediterranean sisters? A comparison of corporate governance systems. In *Corporate Governance in a Changing Economic and Political Environment* (pp. 23-70). Palgrave Macmillan UK.
- Aguilera, R. V. and Jackson, G. (2003b). The Cross-National Diversity of Corporate Governance: Dimensions and Determinants. *The Academy of Management Review*, 28(3), pp. 447-465
- Aguilera, R. V., & Jackson, G. (2010). Comparative and international corporate governance. *Academy of Management annals*, 4(1), 485-556.
- Aguilera, R. V., Filatotchev, I., Gospel, H., & Jackson, G. (2008). An organizational approach to comparative corporate governance: Costs, contingencies, and complementarities. *Organization science*, 19(3), 475-492.
- Aguilera, R.V., & Cuervo-Cazurra, A. (2009). Codes of good governance. *Corporate Governance: An international review*, 17(3), 376-387.
- Alvaro, S., D'Eramo, D., & Gasparri, G. (2015). Modelli di amministrazione e controllo nelle società quotate. *Aspetti comparatistici e linee evolutive. Quaderni Giuridici, Consob*.
- Aoki, M. (2000). *Information, corporate governance and institutional diversity: Competitiveness in Japan, the USA, and the transitional economies*. Oxford University Press, Inc..
- Bellavite Pellegrini, C., & Sironi, E. (2017). Does a one-tier board affect firms' performances? Evidences from Italian unlisted enterprises. *Small Business Economics*, 48(1), 213-224.
- Bellavite Pellegrini, C., Pellegrini, L., & Sironi, E. (2010). Alternative vs traditional corporate governance systems in Italy: An empirical analysis. *Problems and Perspectives in Management*, 8(3), 1-15
- Blair, M. M. (1995). Rethinking assumptions behind corporate governance. *Challenge*, 38(6), 12-17.
- Campobasso, G.F. (2011), *Diritto commerciale 2. Diritto delle società*. Utet giuridica, Milano
- Comisión Nacional del Mercado de Valores – CNMV (2013). Informe anual de Gobierno Corporativo de las compañías del IBEX 35. <http://www.cnmv.es/portal/publicaciones/publicacionesgn.aspx?id=22>
- Commissione Nazionale per le Società e la Borsa – CONSOB (2016). Report on corporate governance of Italian listed companies. <http://www.consob.it/web/area-pubblica/rcg2016>
- Cosset, J. C., Somé, H. Y., & Valéry, P. (2016). Does Competition Matter for Corporate Governance? The Role of Country Characteristics. *Journal of Financial and Quantitative Analysis*, 51(4), 1231-1267.
- Dalton, D.R., Hitt, M.A., Certo, S.T., & Dalton, C.M. (2007). The fundamental agency problem and its mitigation: Independence, equity, and the market for corporate control. *Academy of Management Annals*, 1, 1-64.
- Demb, A., & Neubauer, F. F. (1992). The corporate board: Confronting the paradoxes. *Long range planning*, 25(3), 9-20.
- Denis, D. K., & McConnell, J. J. (2003). International corporate governance. *Journal of financial and quantitative analysis*, 38(01), 1-36.
- Di Sabato, F. (2011), *Diritto delle società*, Giuffré, Milano.

- Ducassy, I., & Guyot, A. (2017). Complex ownership structures, corporate governance and firm performance: The French context. *Research in International Business and Finance*, 39, 291-306.
- Edwards, T. (2004). Corporate governance, industrial relations and trends in company-level restructuring in Europe: convergence towards the Anglo-American model?. *Industrial Relations Journal*, 35(6), 518-535.
- Esposito P., (2012), Integrity distortions and public policies in the local P.A.s. Theoretical lines, emerging practices, contradictions: a first path of conceptualization. *Rirea*, 7/8.
- Esposito P., Ricci P., (2014), Public (dis)Value: A case study, in *Public Value Management, Measurement and Reporting* (in J. Guthrie, G. Marcon, S. Russo, F. Farneti), Emerald Group Publishing.
- Esposito P., Ricci P., (2015) . "How to transform the Public (dis)Value in Public Value?. Evidence from Italy", *Public Money & Management*, Routledge – Taylor & Francis Group, UK
- Esposito, P. (2012). La corporate governance nelle società di capitali. In Ricci, P. (edited by), *L'economia d'azienda. Paradigmi e declinazioni*, Giuffrè, Milano.
- Graziani, C. A., Minervini, G. and Belviso, U. (2011). *Manuale di diritto commerciale*. CEDAM, Padova.
- Hancké, B., Rhodes, M., & Thatcher, M. (Eds.). (2007). *Beyond varieties of capitalism: Conflict, contradictions, and complementarities in the European economy*. Oxford University Press.
- Hong, B., Li, Z., & Minor, D. (2016). Corporate governance and executive compensation for corporate social responsibility. *Journal of Business Ethics*, 136(1), 199-213.
- Hopt, K. J., & Leyens, P. C. (2004). Board models in Europe—recent developments of internal corporate governance structures in Germany, the United Kingdom, France, and Italy. *European Company and Financial Law Review*, 1(2), 135-168.
- Lannoo, K. (1999). A European perspective on corporate governance. *JCMS: Journal of Common Market Studies*, 37(2), 269-294.
- Loukas J. Spanos, (2005). Corporate governance in Greece: developments and policy implications. *Corporate Governance: The international journal of business in society*, 5(1) pp. 15 – 30.
- Martinez-Blasco, M., Garcia-Blandon, J., & Castillo-Merino, D. (2017). Are Investors Concerned by Annual Corporate Governance Reports? Some Evidence from the Spanish Stock Market. *European Management Review*.
- Mertzanis, H. (2001). Principles of corporate governance in Greece. *Corporate Governance: An International Review*, 9(2), 89-100.
- Oliveira, L., Rodrigues, L. L., & Craig, R. (2010). Intangible assets and value relevance: Evidence from the Portuguese stock exchange. *The British Accounting Review*, 42(4), 241-252.
- Ricci, P. (2012). *L'economia dell'azienda: paradigmi e declinazioni*. Giuffrè, Milano.
- Rodrigues, L. L., Tejedo-Romero, F., & Craig, R. (2017). Corporate governance and intellectual capital reporting in a period of financial crisis: Evidence from Portugal. *International Journal of Disclosure and Governance*, 14(1), 1-29.
- Rodrigues, L. L., Tejedo-Romero, F., & Craig, R. (2017). Corporate governance and intellectual capital reporting in a period of financial crisis: Evidence from Portugal. *International Journal of Disclosure and Governance*, 14(1), 1-29.
- Schmidt, C., & Fahlenbrach, R. (2017). Do exogenous changes in passive institutional ownership affect corporate governance and firm value?. *Journal of Financial Economics*.
- Shleifer, A. and Vishny, R. (1997), "A survey of corporate governance", *Journal of Finance*, No. 52, pp. 737-84.
- Spanos, L. J. (2005). Corporate governance in Greece: developments and policy implications. *Corporate Governance: The international journal of business in society*, 5(1), 15-30.
- Tylecote, Andrew. "The role of finance and corporate governance in national systems of innovation." *Organization Studies* 28.10 (2007): 1461-1481.

# ENERGY MANAGEMENT IN ITALIAN MUNICIPAL PUBLIC ADMINISTRATIONS: AN ORGANIZATIONAL CULTURAL PERSPECTIVE

Rizzi, Francesco<sup>1</sup>; Annunziata, Eleonora<sup>2</sup>

<sup>1</sup>University of Perugia, Department of Economics, and Scuola Superiore Sant'Anna, Institute of Management

<sup>2</sup>Scuola Superiore Sant'Anna, Institute of Management

## ABSTRACT

Public administrations play a fundamental role for sustainable development. They do not only set and facilitate the implementation of relevant policies in the field, but also influence markets leveraging on green public procurement and being first in adopting behaviours that are expected to have a positive social and cultural impact on local communities. Despite that, unfortunately, the lack of human and financial resources, combined with the struggle between different planning priorities, is often reported as the main reason for public administration achieving poor environmental performances. In this framework, a strong fit between employees and their organization might help enabling those extra role performances that might help mitigating this shortage of resources. This paper draws from the literature on person-organization fit to adapt and test the hypothesis that organizational dimensions are strong predictors of managerial and technical energy performance. Data from 729 valid questionnaires responses from environmental managers of Italian Municipalities show that energy managers might alternatively act as task managers or business partners. The main results indicate that formalization, team orientation, innovation, centralization and reward system are the key elements to control energy performance. Causal relations are discussed and presented along with theoretical and policy implications.

*Keywords: Environmental performance, Organizational fit, Reward system, Green human resource management, Energy manager*

## 1. INTRODUCTION

Since sustainable development discourses have pointed a spotlight on resource efficiency, energy efficiency (EE) has attracted a strong interest from public and private industries. If compared with other resource efficiency initiatives, EE is often easy to delineate, measure, communicate and replicate (IEA, 2014). EE is thus seldom neglected when pursuing sustainability. Energy service companies,

energy managers, energy audits, guidelines for EE, sustainable energy action plans, renewables and energy savings to carbon emissions converters are among the recurring elements in policies and policy tools that reflect the legitimacy and desirability of EE among sustainable performances.

To the date, research in field technical sciences has much more increased together with the relevance for business of EE than research in the organizational and managerial dimensions (Martin, Muuls, de Preux & Wagner, 2012). Despite that, the latter is far from being irrelevant. In fact, in times of scarcity of economic and financial resources, organizational resources determine competitive advantage (Carmeli & Tishler, 2004). Pertinent examples come from large multinational corporations, which pursue EE by re-designing their organizations for open innovation, as well as from smaller enterprises, which increasingly recognize energy managers as new professionals that operate as business partners across traditional functions (i.e. *in primis*, supply chain, procurement and R&D).

Organizational determinants of EE are a novel but still largely unexplored research field (Schulze, Nehler, Ottosson, & Thollander, 2016). The black box that mediates organizational dimensions ranging from internal culture to person-organization fit (P-O fit) and EE is a promising field of studies (Chai & Yeo, 2012). A major difficulty in investigating these relations because of the high heterogeneity of boundary conditions that might affect the observed relations, which means difficulties in isolating causal relations between variables among different cases. In such framework, this work attempts to provide a first investigation on the links between organizational dimensions and EE performances by analysing a highly regulated setting, which allows the assumption of reduced heterogeneity of boundary conditions, namely public administrations. These actors are highly committed toward EE not just because they cover a multifunctional role as regulators, building owners, tenants and developers and, lastly, boosters for market suppliers of energy-efficient products and services (Annunziata, Rizzi, & Frey, 2014), but also because of their need to adsorb best managerial practices from the private sector to cope with budget constraints (Carmeli & Tishler, 2004).

In the reminder of the paper, we present a grounded-in-theory conceptual model that links organizational dimensions and EE. The method section provides a theoretical justification of Italian municipalities as a meaningful research setting as well as details on the research design, data collection and measurement models. Results from ordered logic regressions are then discussed to distil theoretical and managerial implications that shed light on the relevance that such organizational elements as vision, goals, trust, social networking, centralization, formalization, rewards, openness to innovation, attention to detail, outcome orientation, team orientation and corporate social responsibility have on EE performance.

## 2. THEORETICAL BACKGROUND

### *2.1 Internal factors influencing energy efficiency*

EE is a key resource to achieve economic growth and social development, competitiveness and environmental sustainability (IEA, 2014). Unfortunately, cost-effective EE potential remains untapped due to the existence of “energy efficiency gap” in all sectors of society (Jaffe & Stavins, 1994). Energy management is widely recognized as a primary means to achieve EE targets within organizations. Indeed, literature has shown the effectiveness of both energy management practices and investments in energy-efficient technologies (Thollander, Backlund, Trianni & Cagno, 2013). Accordingly, organizations aiming to improve their EE performance by implementing energy management practices need qualified staff dealing with energy issues (Sucic, Lah & Petelin Visocnik, 2017). In particular, the role of energy manager is crucial for successfully integrating energy management practices into the daily operations of organizations (ISO, 2011).

Martin, Muuls, de Preux & Wagner (2012) show that energy managers are likely to affect differently EE management practices and performance depending on their degree of power and authority, but also their competences that come with their position within organization. Indeed, energy managers who are at the lower level of management hierarchy contribute to EE practices by implementing technical measures at operational level, whereas energy managers being at the top of hierarchy can develop a vision of future energy strategy within their organizations (Martin, Muuls, de Preux & Wagner, 2012; Sucic, Lah & Petelin Visocnik, 2017). Moreover, energy managers can work in isolation or cooperate with other departments/function within organization (Martin, Muuls, de Preux & Wagner, 2012). Therefore, energy managers as key actors in the implementation of EE practices within organizations should be involved in the investigation to explore the relationship between organizational dimension and EE performance.

### *2.2 Energy efficiency and organizational environment*

Thollander, Backlund, Trianni & Cagno (2013) recognize organizational elements as a fundamental dimension for implementing EE practices and improving related performance within organizations. Therefore, the identification of organizational elements associated with EE performance becomes a priority for organizations pursuing EE targets (Martin, Muuls, de Preux & Wagner, 2012). Previous research has identified organizational structure as influencing factor in the improvement of EE (DeCanio & Watkins, 1998; DeCanio, Dibble & Amir-Atefi, 2000). In particular, scholars have identified the effectiveness of connectedness and communication cost, and hierarchy of functions as components of organizational structure (DeCanio & Watkins, 1998; Martin, Muuls, de Preux & Wagner, 2012), but

have neglected other components of organizational structure such as performance-based reward systems that foster the sharing of best practices within organizations (Szulanski, 1996).

Another aspect representing the deep framework of organizations is the organizational culture. Organizational culture is rooted in the values, beliefs and assumptions shared by organizational members (Denison, 1996). This organizational dimension plays an important role in organizations because it produces a collective identity of organization's members (Hofstede, 1998), prescribes norms of behavior (Schein, 1990), helps employees to cooperate and communicate (Schneider & Bowen, 1995), and provides structure and control without relying on an authoritative management (O'Reilly & Chatman, 1996).

Since all abovementioned organizational elements are strictly connected to organizational members such as employees, the process of identification of organizational elements affecting EE performance can be supported by P-O fit concept that can be defined as "the congruence between the norms and values of organizations and the values of persons" (Chatman, 1989). Santos and Domenico (2015) recognize the multidimensionality and several organizational elements characterizing P-O fit. These organizational elements can include cultural aspects (i.e. organizational vision and goals, trust, social networks, innovation, attention to details, outcome orientation, etc.) (Tepeci, 2001; O'Reilly, Chatman & Caldwell, 1991; Kim & Lee, 2006) and structural ones (i.e. formalization, centralization performance-based reward systems, etc.) (Kim & Lee, 2006; Martin, Muuls, de Preux & Wagner, 2012). Therefore, P-O fit can provide organizational elements which energy managers as organizational members are able to perceive as crucial for improving EE performance within organizations.

### **2.3 Hypothesis and research question**

Pursuing the improvement of EE performance is a challenge that requires relevant efforts within organizations. Therefore, it is necessary to identify organizational elements affecting EE performance. EE performance can be split into two: managerial and technical. Managerial performance identifies all practices that address EE from an overall organizational perspective to the level of business groups, functional area and facility through formalization of responsibilities and controls (Schulze, Nehler, Ottosson & Thollander, 2016). Technical performance regards the implementation energy-saving technologies and technical measures that reduce energy consumptions and related costs (Abdelaziz, Saidur & Mekhilef, 2011). Therefore, the following hypotheses will take into account the relationship between organizational elements and (managerial and technical) EE performance. Figure 1 shows the conceptual model to be tested.

### 2.3.1 *Vision and goals*

Kanter, Stein and Jock (1992) state that organizational vision determines clear organizational purpose supporting the achievement of goal. Moreover, clear organizational vision and goals engage employees in contributing to organizational goals and activities (Davenport, Javenpaa & Beers, 1996). Therefore, a clear organizational vision and goal have a positive impact on managerial and technical EE performance.

**H1a:** Clear organizational vision and goals exert a positive effect on managerial EE performance.

**H1b:** Clear organizational vision and goals exert a positive effect on technical EE performance.

### 2.3.2 *Trust*

Organizational trust is functional in achieving goals, because contexts promoting trust create a clear and predictable environment in which employees take risks and involve themselves in organizational goals (Kahn, 1990). Moreover, loyalty and trusting relationships avoid deception and the tendency to blame other for organizational failure (Nonaka, 1990). Another study finds that high levels of trust within organizations facilitate knowledge sharing, shared goals and lower transaction costs (Andrews & Delahaye, 2000). Therefore, EE as specific organizational goal can be positively influenced by the presence of trust within organizations.

**H2a:** Organizational trust within organizations exerts a positive effect on managerial EE performance.

**H2b:** Organizational trust within organizations exerts a positive effect on technical EE performance.

### 2.3.3 *Social networks*

Social networks consisting in communication, dialogue, individual or group interactions can support and foster knowledge-related organizational members activities (Leonard & Sensiper, 1998). O'Dell and Grayson (1998) show that both formal and informal relationships between employees are important for sharing vision and knowledge within organizations. In particular, organizational members very often prefer informal networks for communication (Stevenson & Gilly, 1991) and practices communities as knowledge-sharing networks (Constant, Sproull & Kiesler, 1996). Hence, EE performance can be supported and strengthened sharing knowledge and practices through informal and formal network within organization.

**H3a:** Effective social networks within organizations exert a positive effect on managerial EE performance.

**H3b:** Effective social networks within organizations exert a positive effect on technical EE performance.



#### 2.3.4 Centralization

Some studies recognize the importance of hierarchical structure for sharing knowledge and goals within organizations (Creed, Douglas & Miles, 1996). In particular, the centralization of power and authority at higher level can reduce the inclination to exchange knowledge within organization (Tsai, 2002). Accordingly, some scholars claim that organizational structure should be developed to foster collaboration and sharing within and outside organizations (O'Dell and Grayson, 1998). Martin, Muuls, de Preux & Wagner (2012) highlight the importance of organizational structure in the implementation of EE. In some cases the effect of organizational structure and in particular the degree of centralization produces controversial effects depending on the kind of investigated performance (Zeng, Zhang, Matsui & Zhao, 2017). Then, a decentralization within organizations hinders EE performance.

**H4a:** The decentralization is negatively associated with managerial EE performance.

**H4b:** The decentralization is negatively associated with technical EE performance.

#### 2.3.5 Formalization

Formalization consisting in the use of procedures, roles and regulations within organizations is controversial (Hempel, Zang & Han, 2012). Indeed, it is often viewed as a “red tape” limiting the ability to exercise authority and operate effectively (Tata & Prasad, 2004), but it can be also considered as a mechanism to provide strategic direction (Segars, Grover & Teng, 1998) and goal clarity (Organ & Greene, 1981). These contradictory interpretations can be solved if we analyze how formalization is applied. Indeed, formalization is positive if it clarifies goals, procedures, and areas of responsibility and enables employees to exercise their mastery (Blanchard, Carlos, & Randolph, 1996). Accordingly, formalization clarifying roles, procedures and responsibilities fosters the implementation of EE.

**H5a:** The good formalization is positively associated with managerial EE performance.

**H5b:** The good formalization is positively associated with technical EE performance.

#### 2.3.6 Performance-based reward systems

Reward and compensation systems aim to motivate and increase the performance of individuals and groups within organizations. These systems are based on the achievement of congruence between their goals and activities and those of the organization (Bonner and Sprinkle, 2002). Reward systems that foster employees to pursue the sustainability strategy through the improvement of organization's social and environmental impacts are difficult to design and often fail to align with organization's mission and strategy (Virtanena, Tuomaala & Pentti, 2013). Since some jobs (e.g. energy managers)

require multiple tasks and decisions based on several factors, the implementation of reward systems focused on narrow and specific performance measures will motivate behavior toward excelling in those particular measures. Accordingly, these systems incentivize performance that is incomplete or conflicting with the organization's overall strategy (Epstein, 2009). Hence, incomplete performance-based reward systems hinder EE performance belonging to organization's overall strategy.

**H6a:** An incomplete performance-based reward system is negatively associated with managerial EE performance.

**H6b:** An incomplete performance-based reward system is negatively associated with technical EE performance.

### *2.3.7 Innovation*

Several studies highlight the importance of innovation for organizational effectiveness (Janssen, Van De Vliert, & West, 2004; Van de Ven, 1986; Woodman, Sawyer, & Griffin, 1993). Therefore, some organizations put efforts to create an innovation-oriented culture. Indeed, an innovation-oriented culture pursues both the will to be innovative and the development of supportive context for innovation (Dobni, 1998; Laegreid, Roness & Verhoest, 2011). Accordingly, innovative behavior consists in the identification and implementation of new and useful ideas, process, products, services and procedures (Farr & Ford, 1990). Some studies show that innovation-oriented culture supports organizations moving from its current state to a desired future state by fostering organizational change (Goh, 2002; Huang, Wu, Lu & Lin, 2015). Hence, innovative organizations are more likely to implement EE.

**H7a:** Innovation-oriented culture within organizations is positively associated with managerial EE performance.

**H7b:** Innovation-oriented culture within organizations is positively associated with technical EE performance.

### *2.3.8 Attention to detail*

Organizations more and more have implemented quality improvement initiatives consisting of management practices intended to provide better quality products and services (Dean and Bowen 1994). The success of these initiatives relies on several reasons, but particularly on organizational culture (Naveh & Erez, 2004). O'Reilly, Chatman & Caldwell (1991) identified that attention to detail defined in terms of precision and accuracy as one of values that comprise the organizational culture. The literature presents a variety of perspectives regarding the integration of attention to detail within quality improvement initiatives. Some scholars claim that attention to detail hinders quality initiatives

as part of the improvement of products, services, and processes and the development of novel values for the organization's stakeholders (Baldrige 2001). Another stream of research argues that the importance of attention to detail reinforces new forms of behavior emphasizing conformity to rules and procedures, precision, and accuracy, which are crucial for quality improvement (Naveh & Erez, 2004). These controversial results foster the investigation of the influence of attention to detail in EE practices. In particular, attention to detail support the implementation of EE within organizations.

**H8a:** The importance of attention to detail within organizations is positively associated with managerial EE performance.

**H8b:** The importance of attention to detail within organizations is positively associated with technical EE performance.

### 2.3.9 *Outcome orientation*

O'Reilly, Chatman & Caldwell (1991) proposed that outcome orientation defined in terms of the achievement of results as one of values that comprise the organizational culture. The link between outcome-oriented culture and culture and performance has mostly been studied, but empirical evidence on this relationship is limited (Wilderom, Glunk & Maslowski, 2000). Garnett Marlowe & Pandey (2008) find a positive mediated relation between an outcome-oriented culture and organizational performance. Verbeeten & Speklé (2015) show that results orientation is positively associated with organizational performance. Accordingly, it is worth investigating the if specific subsets of organizational performances, such as EE performances, are still positively influenced by outcome-oriented culture. Hence, organizations with an outcome orientation are likely to implement EE.

**H9a:** Outcome-oriented culture within organizations is positively associated with managerial EE performance.

**H9b:** Outcome-oriented culture within organizations is positively associated with technical EE performance.

### 2.3.10 *Team orientation*

The literature identifies team orientation as a crucial component of organizational culture (O'Reilly, Chatman & Caldwell, 1991; Dean & Bowen, 1994). Team orientation consists in shared behaviors, attitudes and cognitions that are necessary to accomplish organizational goals (Morgan, Salas, & Glickman, 1994). This value results form a melding process that acknowledges similarities among team members (Earley & Mosakowski, 2000) without forgetting their peculiarities (Mannix & Neale,

2005). Thus, any degree of team orientation facilitates the interactions within organizational members (Salas, Shuffler, Thayer, Bedwell & Lazzara, 2015). Therefore, some scholars find a relationship between team orientation and organizational performance, but this relationship depends on how team orientation and performance are measured (Beal, Cohen, Burke & McLendon, 2003). In this context, team orientation affects positively EE performance within organizations.

**H10a:** Team orientation culture within organizations is positively associated with managerial EE performance.

**H10b:** Team orientation culture within organizations is positively associated with technical EE performance.

Figure 1. Conceptual model

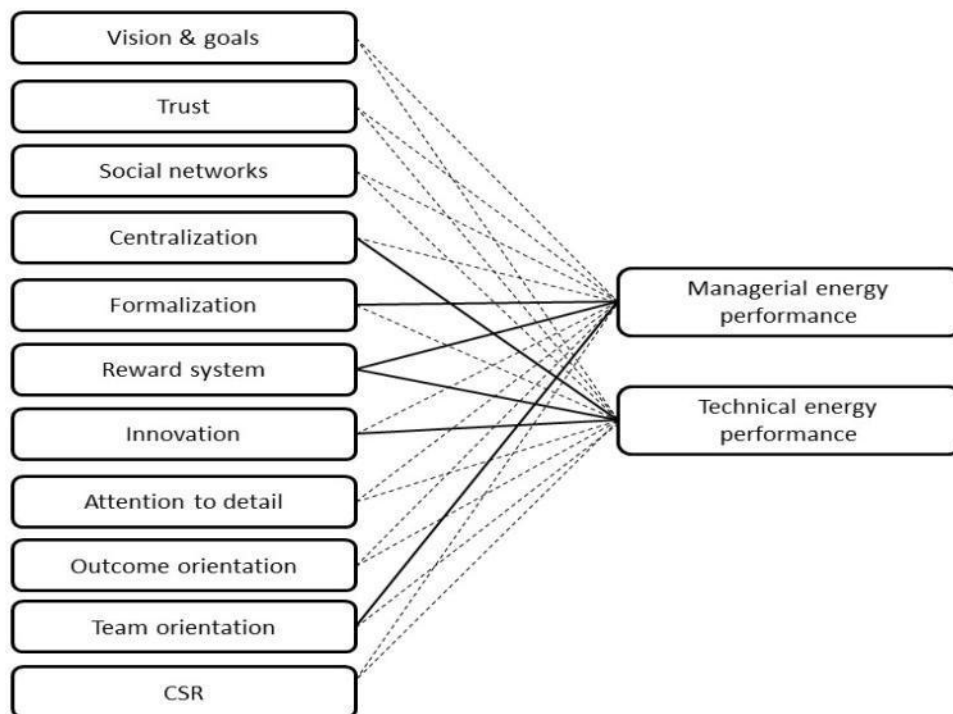

### 2.3.11 Corporate social responsibility

Corporate social responsibility (CSR) practices and programs are more and more common in organizations and are addressed to various stakeholders (e.g. consumers, communities, or employees). Even though Pohl (1996) state that CSR is not the content, but is the tool to implement the values, beliefs, attitudes and norms, namely the organizational culture, various publics consider CSR as one ethical behavior from corporations or organizations that can reflect organizational culture and values (Kim & Park, 2011). Therefore, CSR represents another crucial component of organizational culture. Although many studies have tried to answer if CSR has an effect on organizational performance (Orlitzky et al., 2003; Wu, 2006; Fifka, 2013), the results found have not been totally conclusive. Therefore, the implementation of EE provides another interesting field to test the effect of

CSR on organizational culture. Since Miras-Rodríguez, Carrasco-Gallego & Escobar-Pérezs (2015) find that CSR practices are carried out because organizations looking for performance rewards (e.g. profits or cost savings), CSR culture can foster organizations to pursue EE performance.

**H11a:** CSR culture within organizations is positively associated with managerial EE performance.

**H11b:** CSR culture within organizations is positively associated with technical EE performance.

### 3. METHOD

#### 3.1 *Experimental design*

Public administrations are suitable to identify organizational elements influencing EE performance due to the following motivations. First, public administration are affected by constant pressures to become more market and performance-oriented organizations (Swan, 2016). Therefore, these organizations put managerial practices in place to deal with private sector's typical concerns and in particular budget constraints (Carmeli & Tishler, 2004). Another crucial aspect is the multifunctional role covered by public administrations, as regulators, but also as boosters for market suppliers of energy-efficient products and services (Annunziata, Rizzi & Frey, 2014; Testa, Annunziata, Iraldo & Frey, 2016). Moreover, public administrations allow to focus on organizational elements, because they traditionally operate in standardized contexts with rigid rules and strict hierarchy (Swan, 2016).

Here we choose to investigate Italian municipalities because Italian government has given a strong authority in local energy planning to municipalities and because Italy is the first European country for number of signatory municipalities within Covenant of Mayors initiative<sup>15</sup> that aims to foster actions and policies for the implementation of sustainable energy at local level.

Since there were no previous data available on organizational dimensions and EE performance of municipal administrations, we used primary data from a questionnaire survey conducted among the Italian municipalities. The data were collected by an online questionnaire, from November 2015 to February 2016. The respondents were assisted in filling-in the questionnaire by phone. The questionnaire and the cover letters were sent to 4500 municipalities by e-mail. In order to reduce potential response bias, we used some procedural remedies. First, the questionnaire has been tested and validated by ten municipal energy managers already involved in energy efficiency projects. Second, we guaranteed complete anonymity of respondents and then we committed to providing an executive summary containing the main findings of the study after completion. Third, we avoided use of ambiguous or unfamiliar terms, vague concepts or complicated syntax in order to make simple,

---

<sup>15</sup> 3180 out of 6400 are Italian municipalities (03/02/2016). See:

[http://www.covenantofmayors.eu/about/signatories\\_en.html?q=Search+for+a+Signatory...&country\\_search=it&population=&date\\_of\\_adhesion=&status=](http://www.covenantofmayors.eu/about/signatories_en.html?q=Search+for+a+Signatory...&country_search=it&population=&date_of_adhesion=&status=)

specific, and concise questions. Moreover, we avoided bipolar numerical scale values (e.g. -3 to 3) providing verbal labels for the midpoints of scales.

The survey collected 729 responses with a response rate of 16.2%. The respondents were municipal environmental and energy managers.

### 3.2 Estimation model and measures

The organizational elements influencing managerial and technical EE performance were analysed by means of an ordinal logistic econometric model using STATA 12. To test our hypotheses, we proposed the following equations:

$$\text{Managerial EE performance} = \alpha_0 + \beta_{\text{Vision\&Goals}} + \beta_{\text{Trust}} + \beta_{\text{Social networks}} + \beta_{\text{Centralization}} + \beta_{\text{Formalization}} + \beta_{\text{Performance-based-reward-systems}} + \beta_{\text{Attention-to-detail}} + \beta_{\text{Innovation}} + \beta_{\text{Outcome orientation}} + \beta_{\text{Team orientation}} + \beta_{\text{Corporate social responsibility}} + \varepsilon$$

(1)

$$\text{Technical EE performance} = \alpha_0 + \beta_{\text{Vision\&Goals}} + \beta_{\text{Trust}} + \beta_{\text{Social networks}} + \beta_{\text{Centralization}} + \beta_{\text{Formalization}} + \beta_{\text{Performance-based-reward-systems}} + \beta_{\text{Attention-to-detail}} + \beta_{\text{Innovation}} + \beta_{\text{Outcome orientation}} + \beta_{\text{Team orientation}} + \beta_{\text{Corporate social responsibility}} + \varepsilon$$

(2)

#### Dependent variables

*Managerial EE performance* was measured by a categorical variable considering the integration of following managerial practices within municipality: presence of an energy manager and periodic monitoring of energy consumption for support decision-making process (Schulze, Nehler, Ottosson & Thollander, 2016).

*Technical EE performance* was measured by a categorical variable considering the integration of the following technical energy-saving technologies and technical measures: installation of smart meter in municipal buildings, implementation of EE measures in municipal buildings, installation of renewable energy source plants, installation of smart public lighting systems and implementation of electric mobility solutions (Abdelaziz, Saidur & Mekhilef, 2011).

#### Independent variables

We have adapted most of the selected constructs from scales used by other scholars. All items were measured on a seven-point Likert scale ranging from 1 ("not important") to 7 ("the most important").

*Vision and goals* were measured by four items gauging the extent of which an organization is able to support the development of clear organizational vision, the presentation of a clear organizational vision by top management leaders, a clear transposition of vision into goals and a clear communication of goals (Davenport, Javenpaa & Beers, 1996; Kim & Lee, 2006).

*Trust* was measured by three items gauging the extent to which an organization is able to promote full confidence in the skills of coworkers, empathy among employees and collaboration among employees (Andrews & Delahaye, 2000; Kim & Lee, 2006).

*Social networks* were measured by four items gauging the extent to which an organization is able to facilitate external collaboration, external sharing of information, informal communication networks among employees and participation in communities of practice (Constant, Sproull & Kiesler, 1996; O'Dell and Grayson 1998; Kim & Lee, 2006).

*Centralization* was measured by three items gauging the extent to which an organization is able to promote organizational member's initiatives, decision autonomy at operational level and strict monitoring of operational decision (O'Dell and Grayson, 1998 ; Tepeci, 2001; Kim & Lee, 2006).

*Formalization* was measured by three items gauging the extent of which an organization is able to facilitate the implementation of clear roles and procedures, strict surveillance of internal commitment and high internal compliance (Blanchard, Carlos, & Randolph, 1996; Kim & Lee, 2006; Hempel, Zang & Han, 2012).

*Performance-based reward systems* were measured by four items gauging the extent of which an organization is able to promote opportunities for advancement, rewards based on performance, fair amount of pay, promotion based on competencies and performance (Bonner and Sprinkle, 2002; Kim & Lee, 2006; Virtanena, Tuomaala & Pentti, 2013).

*Innovation* was measured by three items gauging the extent of which an organization is able to facilitate innovation, willingness to experiment and creativity (Tepeci, 2001; Laegreid, Roness & Verhoest, 2011)

*Attention to detail* was measured by three items gauging the extent of which an organization is able to promote attention to quality service, precision and accuracy (O'Reilly, Chatman & Caldwell, 1991; Dean and Bowen 1994; Tepeci, 2001).

*Outcome orientation* was measured by four items gauging the extent of which an organization is able to promote attention to citizen's expectation, outcome orientation, success orientation and actual achievement of operational objectives (O'Reilly, Chatman & Caldwell, 1991; Tepeci, 2001; Garnett Marlowe & Pandey; 2008).

*Team orientation* was measured by three items gauging the extent of which an organization is able to promote attention to employees, team orientation and concentration (O'Reilly, Chatman & Caldwell, 1991; Tepeci, 2001; Salas, Shuffler, Thayer, Bedwell & Lazzara, 2015).

*Corporate social responsibility* was measured by three items gauging the extent of which an organization is able to encourage respect for individual rights, ethical integrity and honesty (Kim & Park, 2011; Carrasco-Gallego & Escobar-Pérezs, 2015).

The descriptive statistics and correlation matrix of variables analyzed in the study are shown in Table 1. Cronbach's  $\alpha$  values for the constructs ranged from 0.78-0.95, suggesting high levels of measurement reliability. With respect to the quality of the measurement model, the loadings ( $\lambda$ ) of all items of the eleven constructs listed in Table 2 are significant.

#### 4. RESULTS AND DISCUSSION

The results of our model provide new and valuable information on how organizational dimensions determine EE performance. In Table 3, higher values of the response variables, i.e. managerial and technical performance, indicate respectively higher levels of formalization of responsibilities and controls on EE and higher levels of adoption of technical solutions for EE. Performance is treated as ordinal under the assumption that it has a natural ordering (low to high), but the distances between adjacent levels are unknown.

In both the estimations, the number of observations used in the ordered logistic regression (729) is lower than the number of respondents because of missing values for some variables in the equation, which are thus described only by observed data.

The probability to accept the error of incorrectly rejecting the null hypothesis (i.e. all of the regression coefficients in the model are equal to zero) is in both cases lower than a 0.001 level of willingness to accept it.

The ordered log-odds regression coefficients highlight the significance of formalization and team orientation as predictors of managerial performance, and of centralization and innovation as predictors of technical performance. Notably, performance based reward is an excellent predictor of both the performance.

A clear distribution of roles and responsibilities for EE and periodic control on direct EE performance are achieved in organizations that are broadly inclined to clearly define roles, rules and surveillance processes. In fact, for one unit of increase of perceived formalization, respondents report a 0.34 increase of EE managerial performance given the other variables are held constant in the model. The probability for organizations with a perceived formalization to have EE managerial practices is 1.41 times higher than the probability to have unclear roles, responsibilities and surveillance practices for EE.

Similar evidence emerges also for team orientation. Having a higher attention towards employees, working in a more team-oriented environment and keeping high the concentration on shared goals have a 0.49 positive relation with EE managerial performance. The probability for organizations with a strong team orientation to have poor EE managerial performance is 0,61 times lower (i.e. 1/1.64) than the probability of having clear roles, responsibilities and surveillance practices for EE.



Both formalization and team orientation do not have a statistically significant influence on EE technical performance, which instead is influenced by innovation and centralization.

EE monitoring systems, EE measures, renewable energy technologies, high-efficiency public street lighting and electric mobility are more largely implemented in organizations that are more open to innovation and high in creativity and willingness to experiment. In fact, for one unit of increase of perceived innovation in the organization, respondents report a 0.51 increase of EE technical performance given the other variables are held constant in the model.

Table 1 – Summary statistics and bivariate correlations.

	1	2	3	4	5	6	7	8	9	10	11	12	13
1 Man. EE perf.	1.0	0											
2 Tech. EE perf.	0.3	1.0											
3 Vision& goals	0.0	0.0	1.00										
4 Trust	0.0	-	0.735	1.00									
5 Social Net.	0.0	0.0	0.823	0.678	1.00								
6 Centrali zation	-	-	0.725	0.668	0.719	1.00							
7 Formali zation	0.0	0.0	0.681	0.604	0.670	0.701	1.00						
8 Perf.Re ward	-	-	0.731	0.779	0.696	0.706	0.627	1.00					
9 Innovati on	0.0	0.0	0.777	0.691	0.796	0.776	0.658	0.727	1.00				
10 Attent- to-detail	0.0	0.0	0.803	0.759	0.785	0.784	0.750	0.753	0.819	1.00			
11 Outcom e Or.	0.0	0.0	0.866	0.732	0.808	0.761	0.689	0.704	0.827	0.838	1.00		
12 Team Or.	0.0	-	0.824	0.850	0.792	0.733	0.683	0.837	0.788	0.845	0.804	1.00	
13 Or.	0.0	0.0	0.824	0.850	0.792	0.733	0.683	0.837	0.788	0.845	0.804	0.804	1.00

1	CSR	0.0	-	0.705	0.766	0.686	0.657	0.675	0.646	0.652	0.768	0.722	0.750	1.00
3		580	0.0	4	2	6	4	3	8	4	6	5	8	
			21											
	Mean	0.8	2.1	-	-	-	-	7.34e	1.36e	-	-	-	-	7.81e
		899	21	4.13e	4.59e	5.22e	3.24e	-09	-09	5.23e	1.36e	1.82e	6.02e	-10
				-09	-09	-09	-09			-09	-09	-09	-09	
	Stand.	.59	1.1	.9726	.9171	.9378	.8424	.9629	.9594	.8946	.9333	.9049	.9181	.9072
	Dev.	452	21	506	856	239	89	892	242	432	324	883	324	96
	Min	0	0	-	-	-	-	-	-	-	-	-	-	-
				3.263	3.471	3.568	3.207	3.221	2.502	3.195	3.391	3.861	3.135	4.616
				237	268	35	87	6	23	27	25	73	96	3
	Max	2	5	1.252	1.040	1.430	1.322	1.312	1.257	1.257	1.172	1.271	1.091	.7903
				567	42	979	738	033	969	032	801	044	649	659

Measure	Item	Factor Loadings ( $\lambda$ )	$\alpha$
Vision and goals	vg1	0.89	0.95
	vg2	0.86	
	vg3	0.95	
	vg4	0.92	
Trust	tr1	0.79	0.88
	tr2	0.83	
	tr3	0.86	
Social networks	sn1	0.77	0.89
	sn2	0.74	
	sn3	0.89	
	sn4	0.84	
Centralization	ce1	0.71	0.78
	ce2	0.75	
	ce3	0.65	
Formalization	fo1	0.70	0.89
	fo2	0.94	
	fo3	0.94	
Performance-based reward systems	perf1	0.89	0.93
	perf2	0.91	
	perf3	0.84	
	perf4	0.86	
Innovation	in1	0.66	0.83
	in2	0.83	
	in3	0.81	
Attention to detail	at1	0.84	0.91
	at2	0.87	
	at3	0.86	
Outcome orientation	oo1	0.56	0.82
	oo2	0.83	
	oo3	0.69	
	oo4	0.81	
Team orientation	to1	0.84	0.84
	to1	0.88	
	to1	0.64	
Corporate social responsibility	csr1	0.72	0.85
	csr2	0.83	
	csr3	0.85	

Table 2 - The items' loadings (k) and the constructs' Cronbach's a coefficients

Table 3. Estimation result of OLRs

	Model 1		Model 2	
	Dependent variable: managerial performance		Dependent variable: technical performance	
	Coefficient	Odds Ratio	Coefficient	Odds Ratio
Vision and goals	.2696093	1.309453	.1059151	1.111727
Trust	-.1897548	.8271619	.1340043	1.143398
Social networks	-.1705419	.8432078	.0658807	1.068099
Centralization	-.2564816	.7737692	-.2543319 *	.7754344 *
Formalization	.3446621***	1.411513 ***	.1050669	1.110785
Perf. based reward	-.506806 ***	.6024166 ***	-.4905035 ***	.612318 ***
Innovation	.1109598	1.11735	.5159978 ***	1.675309 ***
Attention to details	-.2551452	.774804	.0764526	1.079451
Outcome orientation	.0765599	1.079567	-.1939211	.8237229
Team orientation	.4970592 **	1.64388 **	.0662901	1.068537
CSR	.176011	1.192451	-.1485789	.861932
<i>n° observations</i>	729		729	
<i>LR chi2</i>	30.33		26.17	
<i>Prob&gt;chi2</i>	0.0014		0.0061	
<i>PseudoR2</i>	0.0232		0.0118	

\*, \*\*, and \*\*\* indicate the significance at the 10%, 5%, and 1% levels, respectively

The probability for organizations with a perceived innovation to implement EE technical solutions is 1.67 times higher than the probability to fall short in translating EE objectives into hard interventions on their assets.

Interesting evidence emerges also for centralization. Having a higher autonomy in decisions and taking more initiative without losing the control from organization hierarchies have a 0.25 negative relation with EE technical performance. This means that the more organizations implement EE solutions, the more energy managers are the task managers and direct responsible for the achievement of EE. The probability for organizations with strict tasks and responsibilities directly assigned to energy managers to implement EE monitoring systems, EE measures, renewable energy technologies, high-efficiency public street lighting and electric mobility is 1,29 times higher (i.e. 1/0,77) than the probability of allocating competencies to other activities than the development of technical investments.

A combined interpretation of these findings brings new insights on what drives the implementation of hard and soft initiatives for EE in budget-constrained organizations. Sharing of competencies in highly formalized environments comes with procedures that easily cover soft aspects related to EE like the identification of the energy manager and the circulation of information from periodical reporting. This allows organizations to pick some low hanging fruits from different areas of the organization that do

not necessarily refer to hard interventions. The latter, in contrast, require EE process owners to have a certain degree of autonomy in planning the implementation of innovative solutions. This suggests that budget-constrained organizations typically implement either soft or hard EE measures, and that organizational dimensions related to the autonomy of EE managers serve as discriminants between the two.

Particularly relevant is the relation that meritocracy has on the achievement of both the above mentioned managerial and technical performance.

In details, organizations that are perceived by their energy managers as workplaces offering high opportunities for career and having fair and satisfactory reward systems score low in both managerial and technical performance. These findings, that are apparently in contradiction with current literature on the relationships between reward systems and organizational performance, have a straightforward interpretation that has been supported in the follow-up of the study with a selection of respondents.

In details, for one unit of increase of perceived meritocracy and effectiveness of the reward system, respondents report a 0.50 and 0.49 decrease respectively of EE managerial performance and EE technical performance given the other variables are held constant in the model. The probability for organizations with a valuable performance-based reward system to have EE managerial practices is 1.66 (i.e. 1/0.60) times lower than the probability to have unclear roles, responsibilities and surveillance practices for EE. Similarly, the same organizations have a probability to implement EE technical solutions 1.64 (i.e. 1/0.61) times lower than the probability to fall short in translating EE objectives in hard interventions on their assets. This means that current organizations with effective and meritocratic reward systems do not explicitly encompass EE among the key dimensions of performance management. In such organization, the elements of the performance-based reward system that are addressed are thus not aligned with the corporate strategies on EE. This has two typical impacts on energy managers. Energy managers who help their organizations achieving high managerial and technical performance, e.g. those who strive for identifying adequate suppliers, to monitor and review energy consumption, to promote structural and infrastructural projects to improve EE, perceive their role as the one of “alone heroes” and do not feel that current reward systems ensure adequate recognition and appreciation of their efforts. On the contrary, energy managers that interpret such role as a secondary assignment focus their attention to other core objectives of the organization, i.e. those that are clearly addressed in the performance-based reward system, and –thus– do not push for mainstreaming EE performance within the organization. Such interpretation is supported by the words of two energy managers engaged in follow-up of the study. EM#3, who works for a municipal administration that has invested in both high-efficiency public lighting and a biomass fuelled trigeneration plant, reported “*I am proud of my work, given that we are a*

*small mountain municipality. Sadly, being mentioned in newspaper is the higher satisfaction that I can have from it. [...] Cost pressures have limited or stopped pay increases. [...] Several new jobs are much more specific than our performance indicators, which have a macro perspective on the wealth of the organization". EM#6, who works in a bigger municipality, reported "Since the Mayor decided to sign for the Covenant of Mayors, I have coordinated the collection of information from other colleagues who have responsibilities on projects that have some aspects of relevance for energy efficiency. [...] This task cumulates with my other duties. [...] Despite these difficulties, I am happy because up to now I have never failed achieving a positive evaluation from my director".*

Finally, it is worth noting that six of the eleven organizational dimensions that we have investigated, namely vision and goals, trust, social networks, attention to details, outcome orientation and CSR, have not statistically significant relations with managerial or technical EE performance. This means that our data just show a high heterogeneity of links between these independent variables and the dependent variables of the models, with hybrids that depend on local circumstances that might be explored in future research.

## 5. CONCLUSIONS

The trade-off between resource efficiency and financial crisis is of great concern for both private and public organizations. On the one hand, resource efficiency might mitigate the shortage of financial resource but, on the other hand, it might require high managerial and technical investments. The capability to benefit from resource efficiency thus reasonably depends on the organizational dimensions that drive organizational performance. Our study present, to the extent of our knowledge, the first empirical attempt to shed light on the relations between organizational dimensions and EE among budget-constrained organization. In particular, based on a unique dataset of responses from 729 energy managers of Italian municipal administrations, we have adapted from current literature measurement models of organizational dimensions that are relevant person-organization fit to measure organizational traits and better understand the drivers of the managerial and technical EE performance. Our research design thus allowed leveraging on current literature on performance management at employee level to explore understudied forms of control on performance at organizational level that reside in management decisions of relevance for EE professionals.

### **Theoretical and managerial implications**

The theoretical contributions of this paper are twofold.

First, since separate groups of organizational dimensions adapted from person-organization fit drive respectively EE managerial and technical performance, it is possible to draw two dominant pathways to align the role of energy managers with strategic goals: task managers in bureaucratic environments

and business partners in value creating environments. The former role comes with EE duties on top of those that are functional to wider strategic objectives, which results in working in teams with shared (broader) goals and being subject to strict hierarchical and non-EE-specific surveillance. The latter comes with a centralized definition of clear strategic goals for each peripheral team, including the one that is specifically focused on EE, with high support for the empowerment of specialized personnel aimed at lowering the hierarchical control during the implementation phases. These pathways are mutually exclusive; thus, hybrid pathways are expected to lead to inconsistent and unpredictable performance.

Second, reward systems are the only organizational element that produces the same effect on EE managerial and technical performance. This means that an explicit inclusion of EE performance among the criteria of meritocracy for EE professionals would be fundamental to mobilize and valorise internal skills and competencies on EE. Such finding helps also identifying some potentially critical aspects in the management of such internal resources. In fact, specificity and relevance of meritocracy criteria might have a potential trade-off with uniformity of judgment among different process owners. This might occur, as an example, if specific criteria that are applied in some areas of the organization make it more easy to achieve the expected rewards than in other areas. In this case, therefore, there is need for highly-skilled top managers who have the ability to mitigate the threats of the creation of a divisive working environment, which might occur when one performance might be rewarded more than others.

### **Limitations and needs for further research**

Despite the originality of the above-mentioned results, the study is not free from limitations. First, we have collected data from only one setting, i.e. energy managers of municipal administrations in Italy. Thus, extending the study to other settings might be useful to further support the external validity and of our findings. Second, our work puts in the spotlight formalization, team orientation, centralization and innovation. We demonstrate that these organizational dimensions influence EE performance, but the deep nature of such influence is still largely unknown. Therefore, future explorative (qualitative) researches might help opening the black box to disentangle causal mechanisms and enrich our theoretical model. Finally, future researches might usefully analyse the effects of different reward systems that explicitly encompass EE on EE performance to gain further understanding of what determines effective relationships.

## **REFERENCES**

Abdelaziz, E.A., Saidur, R., Mekhilef, S., 2011. A review on energy saving strategies in industrial sector. *Renew. Sustain. Energy Rev.* 15 (1), 150-168.

- Andrews, K. M., & Delahaye, B.L.. (2000). Influences on Knowledge Processes in Organizational Learning: The Psychological Filter. *Journal of Management Studies* 37(6), 797 – 810.
- Annunziata, E., Rizzi, F., & Frey, M. (2014). Enhancing energy efficiency in public buildings: The role of local energy audit programmes. *Energy Policy*, 69, 364–373. <http://doi.org/10.1016/j.enpol.2014.02.027>
- Baldrige National Quality Program. (2001). National Institute of Standards and Technology, Gaithersburg, MD.
- Beal, D. J., Cohen, R. R., Burke, M. J., & McLendon, C. L.(2003). Cohesion and performance in groups: A meta analytic clarification of construct relations. *Journal of Applied Psychology*, 88(6), 989–1004.
- Blanchard, K. H., Carlos, J. P., & Randolph, W. A. 1996. *Empowerment takes more than a minute*. San Francisco: Berrett-Koehler.
- Bonner, S.E., Sprinkle, G.B., (2002). The effects of monetary incentives on effort and task performance: theories, evidence, and a framework for research. *Accounting, Organizations and Society* 27 (4/5), 303–345.
- Carmeli, A., & Tishler, A. (2004). The relationships between intangible organizational elements and organizational performance. *Strategic Management Journal*, 25(13), 1257–1278. <http://doi.org/10.1002/smj.428>
- Chai, K., & Yeo, C. (2012). Overcoming energy efficiency barriers through systems approach—A conceptual framework. *Energy Policy*, 46, 460-472.
- Chatman, J.A. (1989). Improving interactional organizational research: a model of person-organization fit. *The Academy of Management Review*, 14(3), 333-349.
- Creed, W., E. Douglas, E., & Miles, R. (1996). Trust in Organizations: A Conceptual Framework Linking Organizational Forms, Managerial Philosophies, and the Opportunity Costs of Controls. In *Trust in Organizations: Frontiers of Theory and Research*, edited by Roderick M. Kramer and Tom R. Tyler, 16 – 38. Thousand Oaks, CA : Sage Publications.
- Dean, J. W., D. E. Bowen. 1994. Management theory and total quality: Improving research and practice through theory development. *Acad. Management Rev.* 19 392–418.
- DeCanio, S. J., Dibble, C., & Amir-Atefi, K. (2000). The Importance of Organizational Structure for the Adoption of Innovations. *Management Science*. 46 (10), 1285-1299
- DeCanio, S. J., & Watkins, W.E. (1998). Information processing and organizational structure. *Journal of Economic Behavior & Organization* 36(3), 275–294.
- Denison, D. R. (1996). What is the difference between organizational culture and organizational climate? A native's point of view on a decade of paradigm wars. *Academy of Management Review*, 21 (3), 619-654.
- Davenport, T. H., Jarvenpaa, S. & Beers, M.C. (1996). Improving Knowledge Work Processes . *Sloan Management Review* 37 ( 4 ): 53 – 65.
- Dobni, C. B. (2008) Measuring Innovation Culture in Organizations: The Development of a Generalized Innovation Culture Construct Using Exploratory Factor Analysis. *European Journal of Innovation Management*, 11(4), 539–559.
- Earley, P. C., & Mosakowski, E. (2000). Creating hybrid team cultures: An empirical test of transnational team functioning. *Academy of Management Journal*, 43(1), 26–49.
- Epstein, M.J., (2009). Aligning, measuring, and rewarding performance in complex organizations. In: Epstein, M.J., Manzoni, J.-F. (Eds.), *Performance Measurement and Management Control: Measuring and Rewarding Performance*. Studies in Managerial and Financial Accounting, vol. 18. Emerald Group Publishing Ltd., pp. 3–17.
- Farr, J. L. and Ford, C. M. (1990) 'Individual Innovation' in M. A. West and J. L. Farr (eds) *Innovation and Creativity at Work*. Chichester: John Wiley & Sons.
- Fernández, E., Junquera, B., & Ordiz, M. (2006). Managers' profile in environmental strategy: a review of the literature, *Corporate Social Responsibility and Environmental Management*, 13(5), 261–274. <http://doi.org/10.1002/csr.109>
- Fifka MS. 2013. Corporate responsibility reporting and its determinants in comparative perspective – a review of the empirical literature and a meta-analysis. *Business Strategy and the Environment*, 22: 1–35. DOI: 10.1002/bse.729
- Garnett, J. L., Marlowe, J., & Pandey, S. K. (2008). Penetrating the performance predicament: Communication as a mediator or moderator of organizational culture's impact on public organizational performance. *Public Administration Review*, 68, 266–281.
- Gillingham, K., Newell, R.G., & Palmer, K. (2009). *Energy Efficiency Economics and Policy*. NBER Working Paper Series.
- Goh, S.C. (2002). Managing effective knowledge transfer: An integrative framework and some practice implications. *Journal of Knowledge Management*, 6, 23–30.
- Hempel, P.S., Zhang Z.H., & Han. Z. (2012). Team Empowerment and the Organizational Context: Decentralization and the Contrasting Effects of Formalization



- Hofstede, G. (1998). Attitudes, values, and organizational culture: disentangling the concepts. *Organization Studies*, 19 (3), 477-492.
- Huang, K.E., Wu, J.H., Lu, S.Y., Lin, Y.C. (2015) Innovation and technology creation effects on organizational performance. *Journal of Business Research*. <http://dx.doi.org/10.1016/j.jbusres.2015.12.028>
- IEA (2014). Capturing the Multiple Benefits of Energy Efficiency. International Energy Agency, Paris.
- ISO, 2011. ISO 50001:2011 Energy Management Systems Standard e Requirements with Guidance for Use. International Organization for Standardization.
- Jaffe, A.B., & Stavins, R.N., (1994).The energy-efficiency gap. What does it mean? *Energy Policy* 22(10), 804–810. [http://dx.doi.org/10.1016/0301-4215\(94\)90138-4](http://dx.doi.org/10.1016/0301-4215(94)90138-4)
- Janssen, O., Van de Vliert, E., & West, M. 2004. The bright and dark sides of individual and group innovation: A special issue introduction. *Journal of Organizational Behavior*, 25: 129–145.
- Kanter, R., Stein, B. A., & Jock, T. D. (1992). *The Challenge of Organizational Change: How Companies Experience It and Leaders Guide It*. New York: Free Press .
- Kim, S.K., Arthurs, J.D., Sahaym, A. and Cullen, J. (2013), “Search behavior of the diversified firm: the impact of fit on innovation”, *Strategic Management Journal*, Vol. 34 No. 8, pp. 999-1009.
- Kim, S., & Lee, H. (2006). The Impact of Organizational Context and Information Technology on Employee Knowledge-Sharing Capabilities, *Public Administration Review*, 66(3), 370–385. <http://doi.org/10.1111/j.1540-6210.2006.00595.x>
- Kim, S., & Park, H., (2011). Corporate Social Responsibility as an Organizational Attractiveness for Prospective Public Relations Practitioners. *Journal of Business Ethics* 103, 639–653.
- Laegreid, P., Roness, P. G. and Verhoest, K. (2011). Explaining the Innovative Culture and Activities of State Agencies. *Organization Studies*, 32:10 pp1321–47.
- Miras-Rodríguez, M., Carrasco-Gallego, A. & Escobar-Pérez, B. (2015). Has the CSR engagement of electrical companies had an effect on their performance? A closer look at the environment. *Business Strategy and the Environment* 24, 819–835.
- Naveh, E., & Erez, M. (2004). Innovation and Attention to Detail in the QI Paradigm *Management Science* 50(11), 1576–1586.
- Nonaka , I. (1990). Redundant, Overlapping Organization: A Japanese Approach to Managing the Innovation Process . *California Management Review* 32 ( 3 ): 27 – 38 .
- Paillé, P., Chen, Y., Boiral, O., & Jin, J. (2014). The Impact of Human Resource Management on Environmental Performance: An Employee-Level Study, *Journal of Business Ethics*, 121(3), 451–466. <http://doi.org/10.1007/s10551-013-1732-0>
- Mannix, E., & Neale, M. A. (2005). What differences make a difference? The promise and reality of diverse teams in organizations. *Psychological Science in the Public Interest*, 6(2), 31–55.
- Martin, R., Muuls, M., de Preux, L. B., & Wagner, U. J. (2012). Anatomy of a paradox: Management practices, organizational structure and energy efficiency. *Journal of Environmental Economics and Management* 63, 208–223. <http://dx.doi.org/10.1016/j.jeem.2011.08.003>
- O’Dell, C., & Grayson, J.C., (1998). If Only We Knew What We Know: Identification and Transfer of Internal Best Practices . *California Management Review* 40 (3), 154–74.
- O’Reilly, C.A., Chatman, J.A., Caldwell, D.F. (1991). People and organizational culture: a profile comparison approach to assessing person–organization fit. *Academy of Management Journal* 34 (3), 487–516.
- O’Reilly, C. A., & Chatman, J. A. (1996). Culture as social control: corporations, cults, and commitment. *Research in Organizational Behavior*, 18, 157-200.
- Organ, D. W., & Greene, C. N. 1981. The effects of formalization on professional involvement: A compensatory process approach. *Administrative Science Quarterly*, 26: 237-252.
- Orlitzky M, Schmidt FL, Rynes SL. 2003. Corporate social and financial performance: a meta-analysis. *Organization Studies* 24: 403–441.
- Pohl, M.: 2006, ‘Corporate Culture and CSR – How They Interrelate and Consequences for Successful Implementation’, in J. Hennigfeld, M. Pohl and N. Tolhurst (eds.), *The ICCA Handbook on Corporate Social Responsibility* (John Wiley & Sons Ltd, West Sussex, UK), pp. 47–59.
- Sarac, M., Efil, I. and Eryilmaz, M. (2014). A study of the relationship between person-organization fit and employee creativity. *Management Research Review*, Vol. 37 No. 5, pp. 1-23.
- Schein, E. H. (1990). Organizational culture. *American Psychologist*, 45 (2), 109-119.
- Schneider, B., & Bowen, D. E. (1995). *Winning the service game*. Boston: Harvard Business School Press.
- Segars, A. H., Grover, V., & Teng, J. T. C. 1998. Strategic information systems planning: Planning system dimensions,internal coalignment, and implications for planning effectiveness. *Decision Science*, 29: 303-345

- Szulanski, G. (1996). Exploring Internal Stickiness: Impediments to the Transfer of Best Practice within the Firm. *Strategic Management Journal* 17 (10): 27 – 43.
- Santos, L. B., & Domenico, S. M. R. (2015). Person-organization fit: bibliometric study and research agenda. *Europena Business Review* 27(6), 7573-592.
- Schulze, M., Nehler, H., Ottosson, M. & Thollander, P. (2016). Energy management in industry e a systematic review of previous findings and an integrative conceptual framework. *Journal of Cleaner Production* 112, 3692-3708.
- Sucic, B., Lah, P., & Petelin Visocnik, B. (2017). An education and training program for energy managers in Slovenia - Current status, lessons learned and future challenges. *Journal of Cleaner Production* 142, 3360-3369.
- Tata, J., & Prasad, S. 2004. Team self-management, organizational structure and judgments of team effectiveness. *Journal of Managerial Issues*, 16: 248-265.
- Testa, F., Annunziata, E., Iraldo, F., & Frey, M. (2016). Drawbacks and opportunities of green public procurement: An effective tool for sustainable production. *Journal of Cleaner Production*, 112, 1893–1900. <http://doi.org/10.1016/j.jclepro.2014.09.092>
- Thollander, P., Backlund, S., Trianni, A., Cagno, E. (2013). Beyond barriers e a case study on driving forces for improved energy efficiency in the foundry industries in Finland, France, Germany, Italy, Poland, Spain, and Sweden. *Applied Energy* 111, 636e643. <http://dx.doi.org/10.1016/j.apenergy.2013.05.036>.
- Tsai, W. P., (2002). Social Structure of “Coopetition ” within a Multiunit Organization: Coordination, Competition, and Interorganizational Knowledge Sharing . *Organization Science* 13 (2): 179 – 90.
- Van de Ven, A. H. 1986. Central problems in the management of innovation. *Management Science*, 32: 590–607.
- Verbeeten, F. H. M., & Speklé, R. F., (2015). Management Control, Results-Oriented Culture and Public Sector Performance: Empirical Evidence on New Public Management. *Organization Studies* 36(7), 953–978.
- Virtanena, T., Tuomaala, M., Pentti, E. (2013). Energy efficiency complexities: A technical and managerial investigation. *Management Accounting Research* 24, 401–416.
- Wilderom, C. P. M., Glunk, U., & Maslowski, R. (2000). Organizational culture as a predictor of organizational performance. In N. M. Ashkanasy, C. P. M. Wilderom, & M. Peterson (Eds.), *Handbook of organizational culture and climate* (pp. 193–209). Thousand Oaks, CA: SAGE Publications.
- Wynen, J., Verhoest, K., Ongaro, E., van Thiel, S., & in cooperation with the COBRA netwo. (2014). Innovation-Oriented Culture in the Public Sector: Do managerial autonomy and result control lead to innovation?, *Public Management Review*, 16(1), 45–66. <http://doi.org/10.1080/14719037.2013.790273>
- Woodman, R. W., Sawyer, J. E., & Griffin, R. W. 1993. Toward a theory of organizational creativity. *Academy of Management Review*, 18, 293–321.
- Wu ML. 2006. Corporate social performance, corporate financial performance and firm size. *Journal of American Academy of Business* 8(1), 163–171.
- Zeng, J., Zhang, W., Matsui, Y. & Zhao, X. 2017. The impact of organizational context on hard and soft quality management and innovation performance. *International Journal of Production Economics* 18, 240-251.

## **HORIZONTAL ORGANIZATION AND LEADERSHIP: A GENERATIVE APPROACH FOR AN ETHIC DEVELOPMENT IN COMPLEX SYSTEMS**

**Rizziato, Erica**

Italian National Research Council, Research Institute for Economic Sustainable growth IRCRES, Rome Italy and IMO Foundation, Frank van Borselenlaan Neatherland ([www.het-imo.net](http://www.het-imo.net))

### **ABSTRACT**

The growing complexity of our time urgently demands management culture to be innovated, as more and more effective solutions to organization problems are not found at the top, with the traditional managerial culture, characterized by systems, procedure and control. Research shows that 80% of change projects fail or do not reach the expected results and that the main obstacle is the lack of motivation. This depends on a rationalistic, reductive vision of people and organization, considered as two independent realities. The paper shows a new way the organization and workers have to be considered, as two realities that keep evolving with synergy, in an evolutionary systemic-complex vision. On the basis of this, an approach is proposed for organizational and people development which create spaces for trasversal connections and within them generate new processes and competences towards a horizontal, client oriented organization, where people can also find a place of self-development, thereby strengthening their responsibility and motivation. It is an action research and action learning approach developed within a CNR and IMO Foundation research project. It integrates a method to create a space for connections to generate horizontal processes and of a IMO methodology for leadership, which permits to generate new more responsible and aware behaviors, adding to the vertical dimension a horizontal one as well, characterized by dialogue, interactions and connections between the inner and outer world. This approach creates a new path for a responsible, ethic and sustainable development: the horizontal organizational and leadership path.

*Keywords: leadership, management, ethics, competences, organization development, social responsibility, complexity, action research, action learning.*

### **INTRODUCTION**

The paper proposes some findings of a CNR (Ircres Institute) research project (started in 2001) proposing to identify effective approaches to organization development and people motivation. The project involved a large group of international stakeholders in focus groups, case studies, literature

analysis, interviews, experimentation of innovations, for around 10 years (Rizziato, 2010a, b, 2007, a,b; Rizziato, Nemmo, 2013, Bekman, 2004, 2010). Among other main partners of the project, particularly relevant were Prof. Francesco Novara, in-charge of the Olivetti company psychology center and Prof. Adrian Bekman, in-charge of the Dutch foundation NPI created by the psychiatrist B.C.J. Lievegoed in 1954 for his research work in teaching Social Pedagogy at Erasmus University. NPI in 2005 was developed in the international Foundation IMO, which became the main partner of the project.

The results of a first phase of the project, focused on reflections about critical aspects of the traditional change programs, highlight the need to rethink the human person and organizational vision and to change the traditional planned change programs towards generative approaches of both competences and processes. Interesting innovations for the challenges the researcher evidenced in that field were then found. Among which, we can see the necessity to involve people in the definition of change processes and to improve the quality of interactions (Pasmore in Reason, Bradbury, 2001) and specifically the quality of dialogue (Argyrys, 2010; Beer, 2011). Moreover, Bradbury, Mirvis, Neilsen, Pasmore, (2008) sustain that many companies concerned with sustainability have not created the conditions for a sustainable culture and that changing behavior is rarely easy, that launching initiatives and maintaining momentum is a great challenge. They identified the largest challenge to the next industrial revolution in three main points: 1. system thinking, working with the whole system, 2. relational know how, engaging people collectively and fully, 3. generativity, defining ourselves through what we wish to create for the future. They evidenced the “deficit assumptions” about human nature and the necessity to involve people beyond mere conceptualization of action. Also Pardo Del Val (2012) suggest that participation of stakeholders show the way to commitment, and commitment keeps away from resistance. Moreover, the proposed approach by the CNR-IMO project is an innovation to overcome what H. Bradbury (2015) calls the “Cartesian Catastrophe”, which separates mind and heart, reflection from action, self from the others which led, for example, to conventional healthcare research that excluded patients, and conventional education research that exclude students. Furthermore, the project proposal is answering to the questions posed at the end of the work of Hazy and Bien (2014) about the *Complex System Leadership Theory*: “what role do identities play in storing, sharing and evolving rules of interaction? How do ethics play into this question?”. The project also contributes to the reflections on transformational leadership and creativity (Alrawi et al 2015) which focus on the necessity for leaders to improve the ability to empowering employees and inspires them to induce a great influence in the organization. The first paragraph of the paper reflects on the critical elements of the traditional approaches to organization development, found in the project, mainly based on rationalistic and reductive image of man and organization. The second explains a way the organization and workers are to be considered to improve change programs, which are two realities

that keep evolving with synergy, with an evolutionary systemic-complex vision, oriented by their “identity”. The third describes the innovative approach of organizational development, which combine a new method to create a space of connections for horizontal processes, that is client oriented (Rizziato 2010b), integrated with a new methodology for leadership, which creates a link between the inner and outer world, the methodology of evidential (Bekman 2004, 2010, 2014).

## **REFLECTIONS ON CRITICAL ELEMENTS OF THE TRADITIONAL APPROACHES TO ORGANIZATION DEVELOPMENT**

The literature analysis on effectiveness of change methodologies (J.J.Boonstra, L. Caluwè 2004, Novara, 2003, Pardo Del Val 2003) have shown that commonly used interventions have led to poor results or have come to a stop. This depends on a reductive vision, where the individual and organization are considered as two independent realities (Hosking, Morley,1991). Organization behavioral interventions and Human Resources focused on the individual, considering the organization as an independent context. Also organization theories focused on designing internal functions and processes without taking into account the peculiarities of human nature within the working environment, thus making rationalistic reductions. In both cases, the result is a negative impact on motivation which becomes the major obstacle to the expected change. The project experts focus groups, literature analysis and several interviews with managers (Rizziato 2010 a) highlighted that, assuming an adequate remuneration, workers’ motivation is based on two main elements: to be able to perceive the social utility of the work and to be able to give a personal contribution to organization development, by holding specific responsibilities in transforming the working reality. Moreover, it emerged that the organization’s dysfunctions cannot be solved only from within, but also need to reconnect people to their social identity, in contributing to the life of the community through products or services (Novara, 2003). Therefore, it is important to connect these elements to activate effective change processes, so that they can bring added value to the core components of the organization such as clients and people, via an efficient economic process. The expert focus group also analyzed the anthropological and organizational models that today inspire the prevailing interventions in the market. The vision of *homo oeconomicus*, as elementary mechanism triggered by the impulse to economic turnover, interested in achieving maximum pleasure with the least effort, is still widespread. Man is seen as “rational” in the sense of maximizing his own well-being. Hence it has been observed that the pyramidal and functional image of the organization prevails, despite attempts to change it with the matrix or project organizations, that have shown many limits over the medium and long term. The idea is that those at the top know more than the ones lying at the bottom and so the decision-making process is handled from the top in a vertical logic of control of the decisions

taken. Attempts to change this reality led, notably in Europe, to unsatisfactory results (Novara in Rizziato 2010a, Bekman 2010), as management's claims of the bottom's empowerment, such as the quality circles, were prevailed by logical and reductive vision of work motivation, which is widely dependent on profit. Even the interesting ideas of lean thinking of Womack and Jones, suggesting the client's process as the center of change, have fallen into technical logic without the involvement of people, thus bringing often unsatisfactory results. Also the vision of the organization as a collective learning community, the learning organization of Senge, which has been transposed into a classical management mentality and applied in the field of work-related training, led to the same unsatisfactory outcome (Bekman, 2010). The expert project focus group observed that lot of new impulses to the life of the organization has not brought the so hoped changes, because it was considered within reductive managerial visions, lacking vital links for effective change. These reflections focused on the necessity to rethink cultural references necessary to promote effective forms of development. The group focused on a systemic-complex vision as also theorized by Moraine (1993) who underlined, like Drucker (1993), that an organization exists to "do", to carry out the task for which it was built, and that gives it its own identity (i.e. enterprise, hospital, public body etc.). In Olivetti the system complex approach was applied by Novara and evidenced that we can only generate the change with a multidisciplinary vision and with an experimental approach, people and client oriented. This was also Lievegoed's proposal, moreover, he saw the organization's relationship with the client and the leadership in an evolutionary perspective. The group then deepened his vision and practical application with studies case from Bekman. Lievegoed introduced the concept and model of development in the organization reality, connected to the development of individuals (Lievegoed, 1973, 1979). His evolutionary vision allows an important cultural breakthrough, considered essential to promote a new level of "organizational culture" and was taken as the basis of the new approach to development, result of CNR-IMO project. Most of the focus was on how to create new spaces of interaction and the type of leadership which could help such "systemic transformations".

## **THE EVOLUTIONARY IMAGE OF ORGANIZATION AND MAN AT WORK**

Lievegoed (1973) highlight the necessity for who manage organizations to learn how to work from a model of development. For him this necessarily comes from two premises: the comprehension of ways to develop social structures and the comprehension of human development processes, to include the human being as a relevant player, for organization development. Therefore, Lievegoed recalls the foundations of Kenneth Boulding's general theory of systems (1956), who distinguishes a hierarchy of 9 levels of systems, where each higher level integrates all the lower ones, adding a

new dimension that was not present at the previous level, larger for differentiation and complexity. To sum up, the 9 levels are briefly described.

1.The first level is that of the static structure. It might be called the level of *frameworks*. This is the geography and anatomy of the universe, for example, the patterns of electrons around a nucleus.

2.The second level is that of the simple dynamic system with predetermined, necessary motions. This might be called the level of *clockworks*. The solar system itself is of course the great clock of the universe from man's point of view, simple machines such as the lever, even quite complicated machines like steam engines and dynamos.

3.The next level is that of the control mechanism or cybernetic system, which might be called the level of the *thermostat*. This differs from the simple stable equilibrium system mainly because the transmission and interpretation of information is an essential part of the system.

4.The fourth level is that of the "open system," or self-maintaining structure. This is the level at which life begins to differentiate itself from not life, it was called the level of the *cell*.

5.The fifth level was called the genetic-societal level. The plant typifies it, and it dominates the empirical world of the botanist.

6.The next is the "animal" level, characterized by increased mobility and self-awareness. Here we have the development of specialized 'information receptors (eyes, ears, etc.) leading to an enormous increase in the intake of information.

7.The next level is the "human" level, that is of the individual human being considered as a system. In addition to the characteristics of animal systems man possesses self-consciousness, which is something different from mere awareness, we can see a self-reflexive quality - he not only knows, but knows that he knows and he can develop himself in a space of freedom.

8.Then we have the social organizations. The unit of such systems is not the person but the "role": social system, as a set of roles tied together with channels of communication. At this level we must concern ourselves with the content and meaning of messages, the nature and dimensions of value systems, the transcription of images into a historical record, the subtle symbolization of art, music, and poetry, and the complex gamut of human emotion. The empirical universe here is human life and society in all its complexity and richness.

9.The last level is that of transcendental systems, which also exhibit systematic structure and relationship. It is a space where to ask questions that do not have any answers.

Lievegoed wonders if it is legitimate to transfer the concept of biological evolution to social system development and growth, according to Boulding's classification. He thinks that the biological object evolves from the simplest shape to the final predetermined one, the adult shape of the species, that is present as information from the beginning. He states that you can see a social organization as a

natural biological organism, if you don't forget the difference: members of social organizations are autonomous social individuals and not the cells of a biological organism. What is at stake in modern social and political conflicts in our human organizations is the so called "adult" shape of the organization. In a biological object the final goal of the evolution is the adult shape of the species, in a social organization the adult shape is the most suitable way to reach a goal outside the system. This goal is what we call the "client process", i.e. the global experience that a client lives from the first moment he gets in touch with the organization. A social organism can evolve into a predetermined goal, if this goal is perceived and pursued by individuals, who, in that social organism, take autonomous initiative to buy in the whole group. Lievegoed believes in an "adult" shape of social organization, as a result of the effort of all its members, who work together to define that shape, regardless of significant differences in personal judgments and ideas. The "adult" shape of social organization can realize what is unique and special in the 8th level according to Boulding, only if adult individuals want to realize a specific goal, self-consciousness, described in the 7th level. This is the challenge of the modern working community, the creation of a connection between human and social system development. *Growth and ripeness* can be used to describe a biological organism, *change and development* are suitable for people. Lievegoed (1973) presents the co-evolution of man and organization, focusing the self-consciousness of the individual in connection with the changing environment. His evolutionary view holds that development is a discontinuous, one-way process. It goes from a starting model, to differentiation, to a final integration in a more complex model. Organizational development follows a three-phase model: the pioneering phase, the differentiation phase and the integration phase. These phases pivot around the client, that is outside the organization and can give sense and meaning to all ongoing relationships in the organization. The "client process" is the on-progress identity of the organization and it is the "client process" that unifies, steers, makes sense in organizations. Let's walk through these three phases, and see how leadership, relationship with clients and internal relationships change. Later, we will see his human being development vision, also in a wider framework, and its connections with organization development.

#### *The development phase of an organization*

##### *The pioneering phase.*

It is the initial phase, when the entrepreneur establishes the opportunity to solve practical problems and offers his solutions to other people. By doing so, he generates an economic flow. In this phase everything is connected with him, processes quickly flow and communication is direct, "everyone knows everything". The organization has the shape of a not-well-differentiated pyramid, governance is authoritarian, leadership style is hierarchical and deeply concerned with the pioneer-entrepreneur. Functions are roughly formalized, internal responsibility is not officially confirmed, communication



among people is informal and direct, working approach is toward improvisation and the organization can react very well to turbulence in an external context. People can shift from several roles and functions, work is considered a “large family”, people are willing to do service, commitment is strong and every worker shares company objectives that are clear and simple.

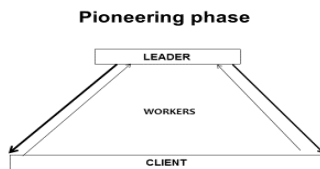

Fig 1 The first phase of an organization (Rizziato, 2010)

In the market, pioneering companies build strong ties with their clients. Mainly the entrepreneur has personal contacts with clients and can solve any critical aspect quickly, there is a sense of “community” based on trust in the pioneer.

*The differentiation phase.*

When business starts growing, the organization cannot work anymore on the basis of naiveté, dysfunctions with clients and not efficient use of resources start to emerge. A step of development need in a different, more differentiated organization. Typically, pyramidal hierarchical organization are created, with separate functions, clear rules and vertical top-down decision processes. For a first period this helps to increase efficiency in a chaotic pioneering situation almost out of control. But in the time, previous vital and smooth interpersonal relationships begin to loosen, fading away into anonymous functions, managers don’t have the pulse of the client anymore and the organization undergoes malfunctioning due to difficulty in feeling the organization as a whole. Often it is the case that managers go one way, following an abstract idea of service leaving their clients alone. Symptoms of organizational crisis are: distance from company values and individual values, carelessness, communication problems, less flexibility, process control problems, lack of motivation.

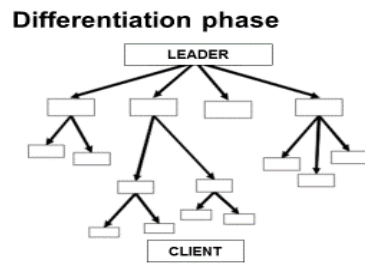

Fig 2 The second phase of an organization (Rizziato, 2010)

These symptoms of crisis ask for a severe re-modeling of the organization and lead to another phase of development. The weakness of this second phase is that the social sub-system of the organization is not taken into consideration, while economic and technical sub-systems thrive notwithstanding a falling motivation.

*The integration phase.*

In the next phase, social, technical and economic systems have to start intertwine. From a competence and function based organization, where focus is on internal processes, to a process based organization, where focus is on the client and workers are proactive. To start this transformation, need a horizontal and shared vision of the client experience, which is traversal to all functions and levels of the organization. A horizontal space has to be created next to the vertical one. Each worker has to be moved by an entrepreneurial spirit to serve the organization, that in this third phase Lievegoed calls “cloverleaf organization” (see Fig.3, how the author re-writes it). Each person in this organization is allowed to act proactively in order to define and reach common objectives. As well as technical and economic sub-systems have strict rules, that worked to permit social progress, social sub-system calls for a road-map to twine together the three sub-systems.

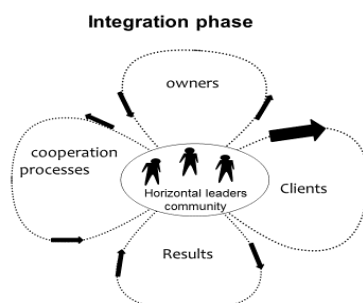

Fig 3 The third phase of an organization (Rizziato, 2010)

Lievegoed underlines the necessity to work for a new leadership style to permit the passage to the third phase. The new leadership has to stimulate individual initiative and entrepreneurial spirit in order to enhance social and organizational awareness.

## LEVELS OF INDIVIDUAL CONNECTION TO THE REALITY

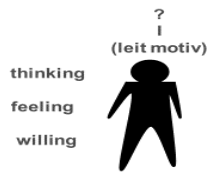

Fig 4 The evolutionary image of the human being and levels of connections to the reality (Rizziato,2010)

*An evolutionary vision of man in the organization*

Since the Homo Oeconomicus concept and the models drawn from it have failed to describe a man able to embrace all the nuances of complexity and continuous change, we need a new paradigm and a new concept. Stanford Research Institute (Campbell et al 1982) and humanistic psychologist like Maslow (1971) define interesting and useful concepts as “individual health”, “self-realization”, full development of talents. Assaggioli’s Psicossintesi is in this framework and integrates different schools and approaches and designs four basic human dimensions: physical, emotional, mental and spiritual (the last being the unifying concept). This model accepts a personal I and a trans personal Self, towards which the I tends to realize himself. Lievegoed’s (1979) evolutionary image of man, derived from Steiner and the personalist stream, is close to this model and presumes the possibility of the I to evolve. Reality is lived considering three levels of the psyche (thinking, feeling, willing) and the I has an ordering function. It is the I that defines the path of development which can be realized in a process of responsible action and reflection and realize what Assaggioli (1977) calls “la meta oltre la porta”, the goal beyond the door and what Lievegoed calls Leitmotiv, that is the biographical direction. In the CNR-IMO project we considered that giving people at work the opportunities to be proactive, able to take decisions about improving their work process is a path toward the realization of the personal I, following their Leitmotiv, and is a very essential issue, an ethic one. On this principle we defined the concept of “ethics of development”. This not only out of respect for the people but also for the enormous value of it can have for the organization, because it can liberate creativity and make people proactive and motivated. This emerged very clearly by analyzing several experiences in the case studies of the CNR-IMO project. It becomes also evident that this type of ethic is effective. As a result, the following evolutionary image of human being was chosen, in order to connect it to organization development. An evolutionary, constructivist, systemic, action research and action learning, generative approach was also chosen to connect people and organization development, as will be illustrated in the next paragraph.

In the constructivist approach the “reality” depends on how we approach, observe, know, and communicate it, comes out from relational processes and from meanings generated by our experience, as the reflexive approach tells us (Weik, 1997). The I is the element who can unify and give sense to the different experience; it has to be considered in the framework of the “leit motiv”, the biographical orientation (Lievegoed 1973). It is important that HR policies consider these factors and make effort to create a suitable environment to enable each worker to pursue self-realization in accord with organizational challenges. The identity of the organization, given by the client service and the individual identity, can be the result of a motivating and evolutionary synergy. Francesco Novara (1996) brilliantly stated: “the “ideal of the organization” picks up the “ideal of the I” and the goals of the organization become the goals of the “ideal I” ...”.

### **THE APPROACH DEVELOPED: A SPACE OF GENERATIVE CONNECTIONS FOR HORIZONTAL PROCESSES AND LEADERSHIP**

As result of CNR-IMO project, a new approach is presented for an efficace and sustainable organization development, based on a method which creates spaces of generative connections for horizontal processes (Training Development in Rizziato 2010b), integrated with a methodology to create a new type of leadership, the horizontal leadership, with the methodology of evidential (Bekman 2004, 2010, 2014). This methodology stimulate changes in behavior, adding to the vertical dimension a horizontal one as well, characterized by dialogue, interactions and connections between the inner and outer world. It considers leadership as a dialogic process, where each individual appeal to the other as a person, not as a role, to explore the possible development step. Horizontal leadership do not guide people, but processes, where people can act responsibly toward a common goal, so strengthening personal motivation. The approach takes as foundation, the individual and organization evolutionary vision explained in the previous paragraph and is characterized by the generation of new processes and behaviors step by step, in a path of action and reflection, with a specific rhythm, depending on the needs of the organization. The proposed approach considers that we move in a systemic complex evolutionary environment and analytical and planning methodologies are of no use. We focused on connections between people and organization, guided by the development of both “identities” in explorative and experimental way. The development of the organization follows the client process improvement, in connection with the steps workers can take toward this goal. In doing so, they can reflect on their development areas and sense making for their I development, in a generative path. The client has to return to being central to the organization strategy and this means rethinking the processes design.

### From the second to the third phase

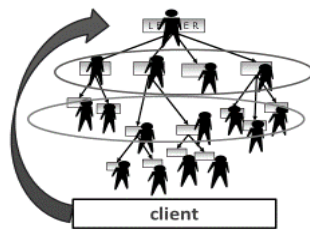

Fig 5 From the second to the third phase of the organization development (Rizziato 2017)

The theoretical basis of the approach is constructivism, action research, action learning, adult learning, neuroscience, humanistic psychology, social psychology, evolutionary theories of man and organization.

*Create a horizontal space of connections for horizontal processes*

To start with, it is important that directors can share a horizontal and evolutionary vision and strategy, connected to the client process improvement, as the identity of the organization and ordinator element of the complexity. They also have to share the view that workers are synthesis elements of complexity, not “human resource to manage” and the importance to identify a selected group of workers, to start a generative process of sustainable change, which will involve, step by step, all the working community. The community of directors will then choose a group of “developers”, activating and connecting them with the horizontal development strategy. The developers will involve the colleagues in the change with a dialogical, explorative and experimental path, using the methodology for horizontal leadership. Directors, working as a community, will sustain the cultural change from the steering principle of vertical working process, that is *how to rationalize processes* to the steering principle of the horizontal working process, that is *how to create added value for the client*.

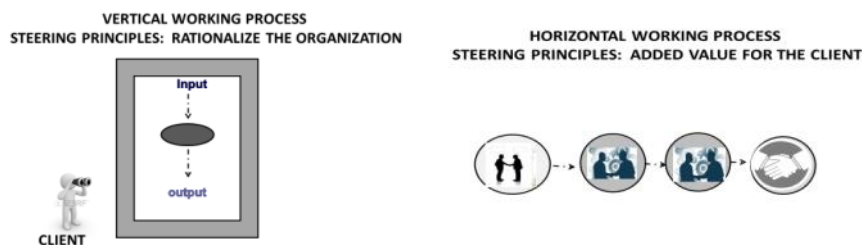

Fig.6 steering principle of processes in the second phase and third phase of the organization (Rizziato2017)

To create fruitful connections for development, a new “development infra-structure” (DIS) will be created, which will represent the space of a new organizational leadership where the issues about change needs, will be shared and oriented in a generative path. A horizontal dimension is added to the vertical one.

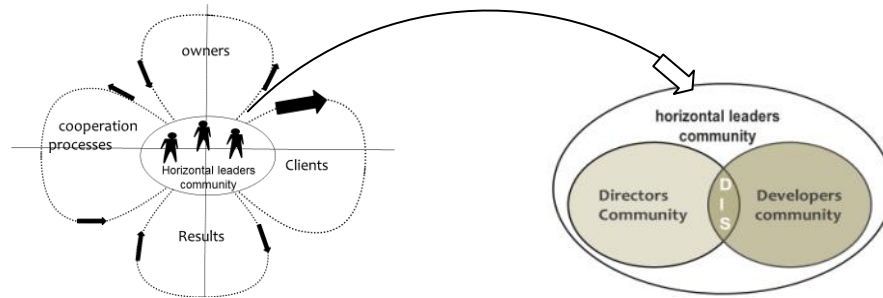

Fig.7 The Development Infra Structure and the horizontal leadership (Rizziato 2017)

*Create an action-reflection, generative, cyclic development and learning path*

The two communities will follow a cyclic development path of action research and action learning. For the directors community it will be a path of defining a horizontal strategy and acquiring horizontal leadership competencies. For the developers it will be a more practical way to explore the questions of change, sharing it with the wider community and collecting ideas, to experiment with new possible ways to change the process, even more horizontally, in order to give added value to the client, while growing in their personal competences. Both the groups will follow an Exploration Macro phase to identify the real issues, share them, collect ideas for improvement and to experiment them. The two groups will meet regularly in DIS, as a space where they can share the exploration and experimentation results, and decide the successive steps, considering the added value for clients, people and capital. Every new process will be issued only after experimentation and “validation” by the whole community.

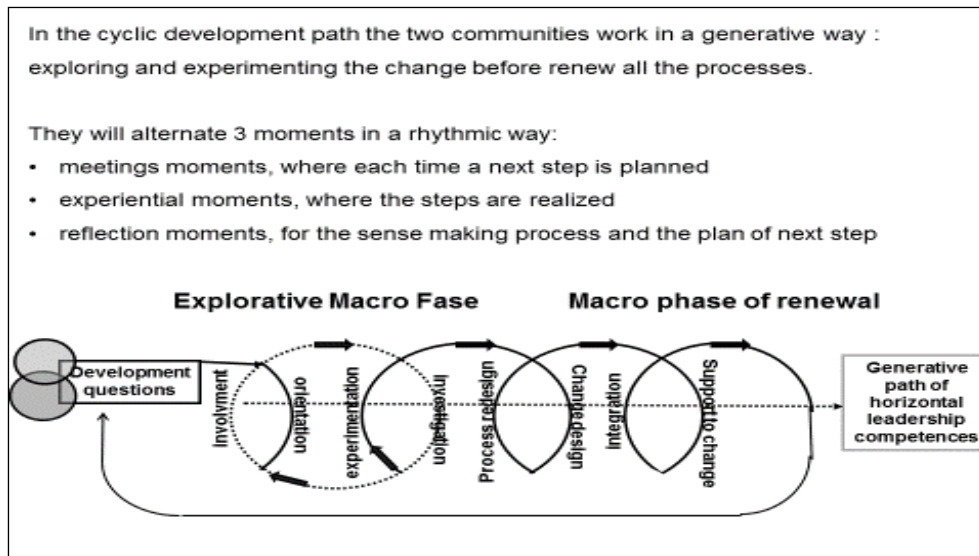

Fig.8 The cyclic development path (Rizziato 2017)

Transversely to the two macro phases, the two communities will reach new competences as horizontal leaders, thanks to the action–reflection paths they will do. It is essential the definition of the next step, which permits to explore the reality behind the abstract ideas people have and then reflect on the findings, both for the processes and for the opportunities for personal change. This synergic way of working is well described in the path called Development Lemniscate of image 9. The start will be the thinking on the critical element for the client and focusing on the steering principle behind it, which will be renewed with the focus on the added value for the client. In the cycle of the Lemniscate, people explore the real chances of change as “acting agents”. They will reorient vertical process into horizontal one step by step, identifying the steering principle lying under processes not effective for the clients, defying the new one and sharing it with the working community, projecting the new step in an explorative way and doing it. In reflecting on the critical aspects of the steps done they can see their behavioral “steering principles” and change them, if need as, with the same approach.

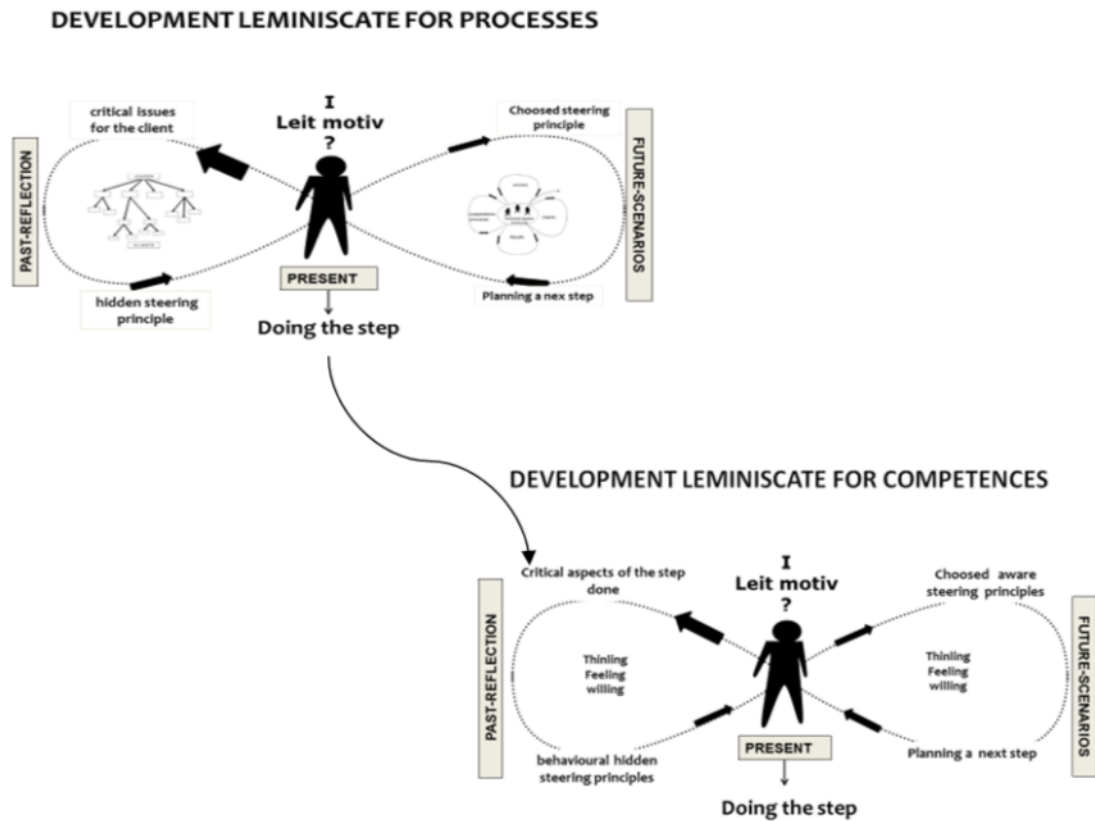

Fig.9 Development Lemniscate for processes and competences (Rizziato 2017)

After each step and reflection, people acquire new perspective to observe the processes and can generate new and better aware steps. They also gain new “developing competences”, becoming step by step horizontal leaders, (Rizziato, Nemmo, 2017, Bekman, 2010).

We already have a good record of successes following this methodology in different type of organizations: profit, nonprofit, public. The proposed approach is a way for the creation of modern communities in the working place, as places of sense.

## REFERENCES

- Alrawi (2015) Transformational leadership and creativity sustainability in the organization, 9th Annual Conference Euromed Academy of Business, Euromed Press
- Argyris (2010) Organizational traps, Oxford University Press, New York
- Assaggioli R. (1977), *L'atto di volontà*, Astrolabio, Roma.
- Beer M. (2011) in Rami A., Woodman R.W., Pasmore A.A. Research on organizational Change, Emerald books, Wagon Lane, UK
- Bekman A. (2004), *The Methodology of Evidential*, in Boonstra J., Caluwè Dynamics of organizational change and learning Chichester, Wiley, New York
- Bekman A. (2010) *The horizontal leadership book*, Alertverlag, Berlin
- Bekman A (2014) *Inside the change*, Alertverlag, Berlin
- Boonstra J.J., Caluwè L. (2007), *Intervening and Changing: Looking for Meaning in Interactions*, Wiley, New York.
- Boulding K. (1956) *General System Theory, the skeleton of science*, New York, Management Science, 1956
- Cabell J. Duane E., Harman W. Hastings et al. Stanford Research Institut (1982), *Chaning image of man*, Pergamon Press, Oxford, New York, Toronto, Sydney, Paris, Frankfurt,



- Drucker P.F. (2002), *Il management, l'individuo, la società*, FrancoAngeli, Milano.
- Hosking D.M., Morley I.E. (1991), *A Social Psychology of Organizing*, Prentice Hall, Harlow.
- Hazy J.K., Uhl-Bien M. (2014) *Changing the rules: the implications of complexity science for leadership research and practice*, Oxford Handbook of Leadership and Organizations, Oxford University Press
- Kotter J.P. (1996), *Leading Change*, Harvard Business School Press, Cambridge
- Lievegoed B.C.J. (1973), *Developing Organisation*, Tavistock, London
- Lievegoed B.C.J. (1979), *Phases, Crisis and Development in the Individual*, Rudolf Steiner Press, London
- Morin H. (1993), *Introduzione al pensiero complesso*, Sperling & Kupfer, Milano.
- Maslow A. (1971) *Verso una psicologia dell'essere*, Astrolabio-Ubaldini, Roma
- Novara F. (2003), *Si può guarire l'organizzazione? Esperienze professionali, pro- poste metodologiche e teoriche*, in *Itinerari d'impresa*, Rubettino, Soveria Mannelli.
- Novara F.(2003), in Rizziato E. *Etica dello sviluppo organizzativo e senso del lavoro: verso un approccio europeo*, FrancoAngeli, Milano.pp. 45-69
- Novara F., Sarchielli G. (1996), *Fondamenti di Psicologia del lavoro*, Il Mulino, Bologna.
- Pardo Del Val M., Fuentes C.M. (2003), "Resistance to change: a literature review and empirical study", *Journal of Management & Strategy*, Vol 41 pp. 148-155
- Pardo Del Val M., Fuentes C.M., Dobon S.R (2012), "Participative management and its influence on organizational change", *Journal of Management & Strategy*, Vol.50 pp.1843-1860
- Reason P. Bradbury H. (2001) *Handbook of action research*, Sage Publications, London
- Bradbury, Mirvis, Neilsen, Pasmore in Reason P., Bradbury H. (2008) *Handbook of action research*, Sage Publication, London
- Bradbury H. (2015) *Handbook of action research*, Sage Publication, London
- Rizziato E. (2010a), *Etica dello sviluppo organizzativo e senso del lavoro: verso un approccio europeo*, FrancoAngeli, Milano.
- Rizziato E. (2010b) "La formazione sviluppo per la creazione di moderne comunità lavorative", Working Paper Ceris CNR n.3/2010, Torino
- Rizziato E. (a cura di) (2007a). "Sviluppo locale e leadership. Una proposta metodologica", Working Paper Ceris-CNR 8/2007, Torino
- Rizziato E. (2007b). "Progetto speciale logistica dell'Ice per il distretto della sedia di Manzano". Rapporto Tecnico CNR-Ceris n.10/2
- Rizziato E., Melone P (2010c). "Progetto E.P.I. per la formazione di Esperti in Processi Innovativi delle Organizzazioni e del Territorio: Sperimentazione di un modello efficiente di transizione Università-Imprese" Rapporto Tecnico Ceris-CNR 32/2010
- Rizziato E., Nemmo E. (2013) "Progetti Orma e Sapil: la formazione-sviluppo per un placement universitario innovativo e la generazione di nuove competenze", Rapporto Tecnico CNR.Ceris n.50/2013, Torino
- Rizziato E., Nemmo E. (2017) "Complessità, competenze per lo sviluppo generativo e sostenibile e leadership orizzontale", Working paper Ircres, in publication
- Weick K.E. (1997), *Senso e significato dell'organizzazione*, Raffaello Cortina, Milano.

## THE BALANCE OF POWER IN THE WORLD MANUFACTURING INDUSTRY

Rodionova, Irina<sup>1</sup>; Shuvalova, Olga<sup>1</sup>; Kokuytseva, Tatiana<sup>2</sup>

<sup>1</sup>Regional Economic and Geographic Department, Peoples' Friendship University of Russia (RUDN University), Moscow, Russia

<sup>2</sup>Institute of Space Technologies, Peoples' Friendship University of Russia (RUDN University), Moscow, Russia

### ABSTRACT

Globalization and innovative development have led to the profound changes in the global industry structure. The rapid character of the industrialization process in developing countries leads to the spatial regrouping in the world. This article analyzes the changes in the spatial organization of the global manufacturing industry.

We define the position of countries and regions in the manufacturing industry and reveal changes in the share of the countries and regions in the world industry in 1999–2014. Under the influence of a complex of factors there is a radical change in proportions between the territories of the "old" and "new" wave of industrial development. The findings prove that there is spatial redistribution of industrial production between the major regions of the world in favor of Asia. In the recent two – three decades the role and importance of Asian countries has been steadily growing in the world economic development. Nowadays we are facing clearly expressed Asian vector of economic and industrial development. The comparative analysis of NAFTA, the EU and BRICS countries positions in the various types of high-tech manufacturing industries captures the growing importance of the BRICS in the global industry. Quite logical that Asia is the leading region and its share has risen from 32.6 to 45.5% of the world high-tech manufacturing industries over the last 15 years, primarily due to the China's share increase (from 3 to 27%). It is shown that China is already the world leader in the manufacturing of most types of industrial products.

*Keywords: world manufacturing industry, structure, high-tech manufacturing, industrial development.*

### INTRODUCTION

A lot of regional and global leaders of the world economy have appeared in recent years. Many developing countries have become significantly integrated into the transnational chains of value added

production. In addition, these countries ensure the growth of competition level in almost all of the global markets. The TOP-10 countries ranked by GDP purchasing power parity of currencies are now headed by China (19,7 trillion dollars, 2015) that is ahead of the United States (18.0 trillion dollars). They are followed by India (8.0 trillion dollars.), Japan (4.8 trillion dollars), Germany (3.9 trillion dollars), Russia (3.7 trillion dollars), Brazil (3.2 trillion dollars), Indonesia, the UK and France (Science and Engineering Indicators 2016).

The positioning of different economic groupings (EU, NAFTA and others), especially a relatively new one – BRICS (Brazil, Russia, India, China and South Africa), in the world economy and the global industry is at the heart of numerous discussions (Lo and Hiscock 2014, Rodionova et al 2015 and others). The BRICS countries have the largest resource potential, huge domestic markets and laborforce; accumulate over 10% of global investment and approximately 20% of the world trade (Heifetz 2015). According to the OECD report, by 2020, the total GDP of the BRICS countries can reach the 1/3 of the global GDP (for comparison: the share of the EU is about 17%, NAFTA – 19%). No doubt, in the next 20-30 years these countries will have a significant impact on the international community processes.

During the years of cooperation, BRICS countries took a huge effort and signed a number of agreements, including those aimed at developing and strengthening financial relations among the member countries as well as at establishing proper financial institutions. At the BRICS summit in Fortaleza (Brazil) in July 2014 the representatives of the member countries signed the Agreement on the New Development Bank and the Cooperation Agreement on Innovation (this agreement means BRICS countries and Development banks' cooperation on co-financing initiatives). The 2016 BRICS summit was the eighth annual BRICS summit (October 2016, Goa, India).

Nowadays BRICS countries have an obvious appeal among scholars. The researchers all over the world examine modernization processes in these countries, study different aspects of their development and cooperation, analyze the importance of internal growth, contribution to the global economy, the expansion of the financial markets and the growing scale of the BRICS countries' interaction with other developing countries (Busygina I.M. et al 2015, Rodionova et al 2015, Prozorovsky 2015).

The relations between the BRICS and leading industrialized states are investigated by Jonathan Luckhurst (2013) who analyzes the former's mutual relations, focusing on how the ideational construct presented by Jim O'Neill in his "BRIC hypothesis" became formalized as a leader-level diplomatic group at the summit in Yekaterinburg, Russia, in 2009. Jonathan Luckhurst evaluates how the BRICS have influenced international issues and takes an effort to identify whether "cooperation" or "conflict" characterizes their relations with the key industrialized states, concluding that there has been a greater multilateral cooperation since 2008, especially through world forums. The author underlines that the BRICS is one of the unparalleled significant partnerships in the international economic relations

especially due to China. This has had important consequences as the Chinese government has prioritized economic cooperation with leading industrialized states.

Speaking about China it is worth mentioning the report published by the World Bank (Shahid 2012), which points out that by raising the capital/labor ratio and rapidly assimilating technologies across a wide range of activities, China has increased factor productivity manifold since 1980 and joined the ranks of middle income countries and nowadays China has set its sights on becoming a global innovative powerhouse by 2020. By 2030, China is expected to have pulled abreast of the most advanced countries technologically and increasingly its growth will be paced by innovation which pushes outwards the technology frontier in the areas of an acquired comparative advantage. It is innovation that today has actually emerged as one of the most popular economic terms. And the innovativeness and technological performance strongly depends on close interaction between them (Soete 2007; Samburova E.N. (2014)).

The global Information and Communications Technologies industry has experienced a rapid, radical reorganization of the industry leaders (Kenji 2015). Moreover, in recent years, the literature has increasingly articulated the links between information and communications technologies and socio-economic development (Avgerou 2000, Mansell 1998).

The proponents of the ICT for development agenda have claimed that these technologies create new opportunities for economic and social development for developing countries (Shahid 2012, Castello 2013, Kovalyov 2015, Sharova 2015).

This theory is proved by many scientists including the Russian ones. For example, after the VII BRICS summit in 2015 (Ufa, Russia) the group of Russian scientists published a special report "Perspectives and strategic priorities of the BRICS ascendancy". Their report contains the authors' assessment of the BRICS as a civilizational unification of the new format, as well as a comparative analysis and forecast for BRICS and G-7. Nowadays the role of scientific research recently published in Russia is growing due to its characteristics of national innovation systems of BRICS, development of information and communication technologies and technological cooperation of the BRICS countries (Soukup 2013).

## **METHODS OF RESEARCH**

The objectives of the paper are:

to define the main shifts in the territorial structure of the global manufacturing industry;

to define the BRICS countries' position in the global manufacturing industry, (including high-tech industries as the driving force of the economic growth and the development of countries in the post-industrial era);

to analyze the dynamics of BRICS in comparison with NAFTA and the EU indicators of manufacturing industry.

The analysis methodology builds on the principles of the system approach and the method of comparative analysis. The calculations are based on National Science Foundation (USA) statistical database (Science and Engineering Indicators – 2016) in the dynamics of the period 1999-2014. This paper also relies on the authoritative international organizations reports, including: Industrial Development Report (UNIDO); International Yearbook of Industrial Statistics (UNIDO); UNESCO Science Report; Towards 2030; 2014 Global R&D Funding Forecast; World Investment Report; INDSTAT 4 – 2016 and others.

The dynamics of industrial development over the period of 1999-2014 was very significant for BRICS countries. Based on the comparative analysis of statistical data we have repeatedly carried out research into the volumes of this or that industrial production in the countries and regions of the world over the past 60 decades, taking into account the indicators and structural changes of the coefficients (Rodionova 2014, Rodionova et al 2015 and others).

We calculated the proportion of countries and regions in the world manufacturing industry and presented the calculations in the tables highlighting their dynamics for the period 1999-2014. However, it is important to recall that the BRICS is the forum of the five fastest growing countries: Brazil, Russia, India, China, South Africa. Jim O'Neill proposed the term acronym (BRIC) to refer to the four economies in the world with the fastest growing GDP - Brazil, Russia, India and China in 2001. This practical cooperation within BRIC began in September 2006 on the initiative of Russian President Vladimir Putin. South Africa acceded to the BRIC in December 2010, and the group began to be known as BRICS. Therefore, in this article the tables covering the period from 1999 to 2006 we present the arithmetic sum of indicators for the countries belonging to the present time in the BRICS. This was done to facilitate the study of dynamical processes in the global industry with the help of comparative analysis.

## **TRANSFORMATIONAL SHIFTS IN THE WORLD ECONOMY**

Globalization and innovative development have led to profound changes in the branch (sectoral) structure of the world economy because of the increasing role of the service sector. Currently the share of the service sector (tertiary sector) in global GDP amounts to 62.6% (the share of industry is 30.4%, agriculture – 6.4%, 2015). It should be noted that despite the dominance of the service sector in the world's GDP and employment, the main source and measure of civilization progress is the improvement of forms and methods of the industrial production. Deindustrialization as the reduction of employment in the global industry, does not mean "uselessness" character of industrial sector in the

world economy. The development of industrial sector is still crucial to achieve high performance and efficiency of the entire economic mechanism.

However, at least two important aspects should be noted. Firstly, in most developing countries (particularly in China, India, Brazil, etc.) the employment in the secondary (industrial) sector of the economy has been growing quite rapidly since the beginning of the twenty-first century (Sluka 2015, Rodionova 2013, Rodionova 2014). For example, in China it has already exceeded 30% of the economically active population, in India and Brazil – 20%. It should be emphasized that the labor force in China is 800 million people, in India – 500 million people, in Brazil – approximately 110 million people. Secondly, it is significant that the leading countries have already carried out or intend to "let" their strategies on the tracks of reindustrialization after the global financial and economic crisis of 2008-2009. Strategy of reindustrialization means taking measures to revive the role of industrial production, although reindustrialization in the developed countries will happen on the wave of new technology (Gorkin 2012). It will be the high-tech industry of the post-industrial era. Developed countries are less competitive in the traditional industries in comparison with the developing countries. Nevertheless, developed countries are still leading in these industries according to their output.

The manufacturing industry is a powerful driver of the world economic development. Many of its innovations and technologies are successfully used in different industries. The output in the manufacturing industry is growing much faster than in the other sectors of the economy (mining, agriculture, services) due to the wide introduction of information technologies, new materials, and the employees' professional development.

However, the industrial structure development trend has varied greatly in the recent decades. This kind of process is affected by the distribution of production capacity of the largest TNCs that mostly influenced the industrial structure of Asian countries of export-oriented economies. In the most backward countries of the world, significant changes in the industry structure have not been marked in the last decades. Many of them are still at the initial stage of the industrialization process (Rodionova 2011, Rodionova 2014).

## TRANSFORMATIONS OF THE WORLD R&D

Research and development (R&D) is defined as the process of creating new products, processes and technologies that can be used and marketed for mankind's benefit in the future (R&D Magazine. 2016).

R&D investments continue to grow. The spatial unevenness of socio-economic development of the countries has led to the polarization of R&D and has formed a contemporary world scientific landscape (Table 1).

	2014	2015	2016
--	------	------	------

North America (Including U.S.)	29.1	28.5	28.4
U.S.	26.9	26.4	26.4
Central and South America	2.9	2.7	2.7
Asia (Including China)	42.4	43.5	44.1
China	19.1	19.8	20.4
Europe	21.5	21.3	21.0
Russia/CIS	3.1	2.9	2.8
Africa	1.0	1.1	1.1

Table 11. *Table 1. Share of total global R&D spending (%)*

Nowadays the share of R&D expenditure in the structure of the world GDP amounts to about 2%. At the same time, this indicator is different for developed and developing countries at least in two times. In this case, a high concentration of R&D expenses should be noted, especially in the developed countries – 60%. There are three main R&D areas: North American, European and East Asian. However, there are some changes in the world scientific landscape. Nowadays the R&D three-dimensional space (US – EU – Japan) transforms to a four-dimensional one (US – EU – China – Japan) (Antipova, Rodionova 2014).

Asian economies continue to grow faster than other parts of the world, and their investments in R&D are often at rates several times that of American and European countries. It should be noted that the USA and Europe are still leading, but the most significant world scientific transformations occur in the Asian region. It is a result of growing importance of R&D activities there. The share of China in R&D activities is growing steadily (Table 1).

The USA is ranked the first – 26% of global R&D expenditure. For 2015 and 2016, R&D investments in the U.S. continue a series of trends started over the past five years. These include restrictions on total federal government spending on R&D, the resultant decline in federal government support of academic R&D investments (and their struggles to compensate), and the slow increase in industrial R&D spending (and its share of the total R&D “pie”). (R&D Magazine. 2016).

China reached the second position – 20% of global R&D. They are followed by the EU (19%) and Japan (appr. 10%) (UNESCO Science report 2015; R&D Magazine. 2016.). The R&D expenditure in the BRICS countries (over 30% of global R&D expenditure) is growing especially in China. As for R&D expenses per capita, China is still very far behind the leading countries (2014: China – \$243, Japan – \$1260, South Korea – \$1399, USA – \$1428), whereas R&D expenses per capita in Russia are not too high as well as in the other BRICS countries (UNESCO Science report 2015).

## VALUE ADDED OF ALL MANUFACTURING INDUSTRIES: POSITIONS OF REGIONS AND COUNTRIES

Different tempos and vectors of development influence the transformation of the global industry spatial configuration. This transformation could be easily fixed by quantitative and qualitative statistical methods when assessing the output in different industries. Nevertheless, at the global level all of the economic disparities remain on the north-south divide (developed – developing countries). This transformation could be reflected by the indicator of value added production in the manufacturing industry, including per capita indicator. According to the UNIDO data analysis there is a gap between the average per capita industrial indicators in developed and developing countries. Nowadays, this gap is characterized as 10:1 and has not reduced yet. However, the role and importance of developing countries (primarily the leading ones: China, Brazil, India, Indonesia, Mexico, Republic of Korea, etc.) in the manufacture and export of industrial products is steadily growing. Moreover, the reduction of the gap in economic (including industrial) development between the Centre and Periphery, on the one hand, is becoming a prerequisite for further development of the Centre. On the other hand, this reduction is the basis for the deepening globalization process (INDSTAT4 2016, Rodionova 2014).

Country/Economy	2005	2010	2015 a/
China	11.75	18.69	23.84
United States of America	20.43	17.77	16.54
Japan	11.14	10.43	8.93
Germany	7.29	6.55	6.37
Republic of Korea	2.54	2.95	3.09
India	1.74	2.36	2.45
Italy	3.70	2.94	2.42
France	3.13	2.61	2.34
Brazil	3.08	2.89	2.26
Indonesia	1.65	1.70	1.93
United Kingdom	2.66	2.15	1.93
Russian Federation	2.15	1.90	1.77
Mexico	1.91	1.69	1.70
Canada	2.20	1.57	1.45
Spain	2.18	1.69	1.44

Table 12. *Table 2. Leading manufacturing economies share in world MVA (at constant 2010 prices)*

\*Generated according to: World Leading MVA

As for the regional level, there are tangible shifts in the manufacturing industry outputs. In general, these shifts are directed from West to East – to Asia. Meanwhile ex-leading regions (North America and Europe) are losing their positions. Thus, in 1999–2014 the share of North America declined from 31.9 to 21.6%, the European share declined from 30 to 24% (including the EU's share decrease from 28 to 20%). Nowadays according to the world rating, the largest industrial regions are located in Asia. Its share in



the structure of the world manufacturing industry increased from 32 to 46.6% in the analyzed period. Undoubtedly, such progress arises from the Chinese economic phenomenon. In 2014, China ranked first in the world manufacturing industry, increasing its share from 6% (1999) to 25.6% (2014). At the same time, it left behind all the industrial giants like the USA (18.3 %), Japan (7.2 %) and Germany (6.1 %) (Generated according to: Science and Engineering Indicators 2016).

Originality of the industrial development process and the changes in the global leadership of key producing countries logically affect the balance of power within the largest economic groupings in the world hierarchy. This means the significant character of transformations happening nowadays. In 1999 the share of NAFTA amounted to 32% of the world manufacturing output, the EU – 27.8% and BRICS – only 10.1 % in comparison with the 2014 indicators: 21.6%, 20.1% and 33.8% respectively (Table 3).

	1999	2004	2006	2008	2010	2012	2014
NAFTA	31.9	28.2	27.4	23.1	22.2	21.4	21.6
EU	27.8	28.9	27.2	27.0	22.1	19.8	20.1
BRICS			18.0	23.4	27.8	31.0	33.8
World	100	100	100	100	100	100	100

Table 3. NAFTA, the EU and BRICS share of the value added of all manufacturing industries, 1999–2014, %\*

\*Generated according to: Science and Engineering Indicators 2016

In other words, under the influence of a complex of factors there is a radical change in proportions between the territories of the "old" and "new" wave of industrial development. Moreover, we can witness the revolutionary changes of the spatial structure of the global industry.

## **THE RAPID GROWTH OF HIGH-TECH MANUFACTURING INDUSTRIES IS A KEY TREND IN THE DEVELOPMENT AND TRANSFORMATION OF THE SPATIAL STRUCTURE OF THE WORLD MANUFACTURING INDUSTRY IN THE XXI CENTURY**

The value of net material product in that sector has doubled from \$862 billion to \$ 1781 billion over the last 15 years. Such kind of dynamics distinguishes the manufacturing industry as the superior sector of the global economy. However, the development tempos of this sector differ in the regional and country context. On the one hand, there is "extremely negative" pole represented by Japan where value added of HT manufacturing industries fell by one half from 185 billion to \$ 91 billion in 2000–2014.

The EU positions deteriorated noticeably as a result of the global financial and economic crisis of 2008–2009. In general, in 2008 the EU cost indicators amounted to \$325.8 billion (of current dollars), in 2009 fell to \$ 274.9 billion. In 2014 these indicators amounted to \$ 303 billion that is \$9.6 billion less than in 2014. During the crisis the most noticeable decrease in production happened in Germany, France, Italy,

Finland, etc. At the same time high-tech product output increased significantly in Slovakia, the Czech Republic, Romania, Poland, Bulgaria over the last 15 years. It can be explained by the fact that many developed countries of Europe transferred their TNC's branches to these countries. All the mentioned above led to the manufacturing indicator increase in the EU by half.

North America is one of the global centers of high-tech industry. The region increased its value added of HT manufacturing industries from \$ 349 billion to \$ 550 billion in 1999–2014 and production from \$ 349 billion to \$ 550 billion in 1999–2014. Meanwhile the output in high-tech industry in the USA increased from \$ 320 billion to \$ 511 billion. So the USA is a core of high-tech production in this region (Science and Engineering Indicators 2016).

On the other hand, there is an “extremely positive” pole of high-tech manufacturing created by the other regions. However, double or triple growth of indicators in Africa, Central and South America, Australia and Pacific Islands should be regarded in a certain sense as the effect of "zero-base". In Asia the value added of high-tech manufacturing industries increased in 1999-2014 (from \$ 281 billion to \$ 810 billion), although Japanese output in high-tech manufacturing industries declined. Over the last 15 years the highest growth rates of total worth of products in current prices have been typical of Vietnam (42 times growth, the highest growth recorded in recent years), China (16 times growth), Indonesia (6 times growth), India (4 times growth), Singapore, Taiwan and Bangladesh (Generated according to: Science and Engineering Indicators 2016).

Quite logical that Asia is the leading region and its share has risen from 32.6 to 45.5% of the world high-tech manufacturing industries over the last 15 years, primarily due to the China's share increase (from 3 to 27%). The share of the BRICS countries increased from 14% (2006) to 31% (2014). The NAFTA ranked second, decreasing the share of the global value added of high-tech manufacturing industries from 40% (1999) to 35% (2006) and to 31% (2014). The EU ranked third reducing from 22% to 17% (Table 4).

	1999	2000	2006	2008	2010	2012	2014
NAFTA	40.4	41.2	35.2	33.0	33.8	31.3	30.9
EU	22.4	19.8	22.3	22.7	18.1	16.8	17.0
BRICS			14.2	17.9	22.0	27.4	31.1
World	100	100	100	100	100	100	100

Table 4. Share NAFTA, the EU and BRICS of the value added of high-tech manufacturing industries, 1999–2014, %\*

\*Generated according to: Science and Engineering Indicators 2016

## COMPARATIVE ANALYSIS OF NAFTA, THE EU AND BRICS POSITIONS IN THE VARIOUS TYPES OF HT MANUFACTURING INDUSTRIES

Consequently, the share of NAFTA in the global output in high-tech manufacturing decreased over the analyzed period from 40% to 31% and the EU share fell from 22% to 17%. Meanwhile the BRICS countries denoted a rapid growth from 6% to 31% (Tab 4).

It should be noted that the giant countries and leading economic groupings constantly enhance the control over the world high-tech industry market. Nowadays the main vector in this sphere is a growing tendency of monopolization. In 1999–2014 the share of three major economic groupings (NAFTA, the EU and BRICS) in the world high-tech manufacturing increased from 2/3 to 4/5. Some high-tech industries easily reveal a partial limitation of global markets and a lack of competitiveness of other participants of the new international labor division in the field of hi-tech technologies.

Another recent direction of transformations is reformatting shares within the group of high-tech manufacturing leaders. The analysis demonstrates good opportunities for “young” and “aggressive” in pioneering areas and directions of high-tech industries (Table 5).

Economic grouping	1999	2004	2006	2008	2010	2012	2014
Computers and office machinery:							
NAFTA	46,3	38,2	38,3	35,2	28,5	23,0	23,8
the EU	18,4	18,8	17,4	15,4	12,5	11,8	12,4
BRICS	2,6	15,6	23,9	30,0	39,2	47,7	49,9
Communications:							
NAFTA	33,6	25,1	25,3	21,1	21,5	18,4	18,0
the EU	14,3	13,1	11,7	12,2	8,3	7,2	6,7
BRICS	9,2	19,1	24,2	27,6	33,5	40,0	46,8
Semiconductor industry:							
NAFTA	32,1	27,5	25,3	24,0	26,0	25,5	24,8
the EU	17,2	15,3	14,1	14,1	9,4	8,0	7,8
BRICS	5,1	8,7	13,2	18,4	23,2	31,6	36,2
Pharmaceuticals industry:							
NAFTA	34,2	33,8	32,5	28,1	28,4	24,7	23,8
the EU	29,7	31,3	31,4	33,0	26,8	23,5	23,2
BRICS	7,9	9,4	12,8	17,7	21,9	29,3	33,4
Testing, measuring, and control instruments industry:							
NAFTA	46,2	46,0	44,2	42,6	46,8	44,1	43,9
the EU	31,1	31,2	30,5	29,6	22,5	22,6	23,1
BRICS	2,8	5,7	8,1	10,8	13,2	14,1	16,1
Aircraft and spacecraft:							
NAFTA	62,7	59,7	59,7	57,5	57,7	55,3	56,1
the EU	23,6	26,2	26,6	25,5	23,2	23,2	23,2
BRICS	7,3	5,8	5,9	7,9	9,8	11,5	13,3

Table 5. Value added of high-tech manufacturing industries: dynamics of share of NAFTA, the EU and BRICS (%)\*

\*Generated according to: Science and Engineering Indicators 2016

It is important to note that the positioning of all economic groupings (including BRICS) in the world output in the high-tech manufacturing could be measured in different ways. It depends on the methodological point of view. One of them could be based on the assessment of two general indicators : a) rate of “overtaking”/“leading”, b) increase in a specific global market share. On that basis, the BRICS countries position in the global configuration of the high-tech market could be characterized as:

### **BRICS IS LEADING BY DYNAMICS AND SCALE:**

- The share of the BRICS countries in the world output of computers and office machinery increased from 3% (1999) to 50% (2014). At the same time the share of NAFTA decreased from 46 (1999) to 23% (2014), and the share of the EU has fallen from 18 to 12%.
- The share of the BRICS countries in the world communications industry increased from 9% (1999) to 24% (2006) and to 47% (2014). Meanwhile the share of NAFTA reduced from 34% (1999) to 18% (2014), and the share of the EU fallen from 14% (1999) to 7% (2014).
- The share of the BRICS countries in the world semiconductor industry also increased from 13% (2006) to 36% (2014). At the same time the share of NAFTA fell from 25.3 to 24.8%, the EU decreased from 14 to 8%.
- The share of the BRICS countries in the world pharmaceuticals industry increased from 13% (2006) to 33% (2014). Meanwhile, the share of NAFTA and the EU declined in 2014 by 24% and 23%, respectively.

### **BRICS – EXPERIENCE DYNAMIC DEVELOPMENT IN CLAUSES OF THE STIFF EXTERNAL COMPETITION**

In this high-tech industry category the share of NAFTA amounted to 44% (2014), while the share of the USA was still very high – 42%. The share of the EU amounted to 23%. The share of the BRICS countries increased from 3% (1999) to 16% (2014) of the world testing, measuring, and control instruments industry. The main leading countries in this high-tech industry category are primarily developed: the USA, China, Germany, Switzerland, Japan, Italy, the UK, South Korea, France and Russia.

### **BRICS –EXPERIENCING LOW ACTIVITY IN CLAUSES OF THE HIGHLY COMPETITIVE FIELD**

This situation could be illustrated by the world aircraft and spacecraft manufacturing. It should be noted that the lowest share in the world aerospace products and parts manufacturing was revealed in 2000 – 1,5%. The total share of NAFTA (56%) and the EU (23%) now accounts for almost 80% of this high-tech industry category (in the early 2000s, almost 90%). The share of the BRICS countries amounts only to 13% (2014), due to the rapid increase in the share of China from 0.6% (1999) to 7% (2014) and Brazil (Generated according to: Science and Engineering Indicators 2016).

## CONCLUSION

The role of the international component in all mechanisms of social reproduction and economic relations is growing in the globalization of the world economy. The priority goal of development for many countries of the world is the development of a national innovation strategy now. Globalization and innovative development have led to the profound changes in the branch structure and spatial organization of the global industry. The rapid character of the industrialization process in developing countries leads to the spatial regrouping in the world.

In the recent two – three decades the role and importance of Asian countries has been steadily growing in the world economic development. Nowadays we are facing clearly expressed Asian vector of economic and industrial development. At the same time, such leading regions as North America and Europe are losing ground.

China, India, Russia and Brazil are already among the TOP-10 leading countries in the world economy. All of the BRICS countries have set themselves ambitious plans to improve the economy structure and to pursue a transition to the innovative way of development. All said above could be especially noticeable when analyzing the dynamics of production of high-tech industries.

The comparative analysis of NAFTA, the EU and BRICS countries positions in the various types of high-tech manufacturing industries captures the growing importance of the BRICS in the global industry. It is noted that in 1999–2014 the share of BRICS countries in the value added of HT manufacturing industries increased from 6 to 31%. At the same time, the share of NAFTA and the share of the EU decreased.

This paper was financially supported by the Ministry of Education and Science of the Russian Federation on the program to improve the competitiveness of Peoples' Friendship University of Russia (RUDN University) among the world's leading research and education centers in the 2016-2020.

## REFERENCES

- Antipova E., Rodionova I. (2014) Geografiya nauchnoi sfery v usloviyakh globalizatsii mirovoi ekonomiki [Geography of scientific sphere in the context of globalization of the world economy]. Vestnik of the Belarusian State University (BSU), Series 2: Chemistry, Biology, Geography 1: 71-77 (In Russ)
- Avgerou C. and Walsham G. (2000) Introduction: IT in developing countries. In Avgerou C. and Walsham G. Information Technology in Context: Studies from the perspective of developing countries. Ashgate Publishing Limited, Hants: 3-10
- Busygina I.M. et al (2015) Modernizatsiya i demokratizatsiya v stranakh BRIKS: sravnitelnyy analiz [Modernization and democratization in the BRICS countries: comparatively analysis]. Aspekt Press, Moscow (In Russ)
- Castillo M. (2013) The digital economy for structural change and equality. United Nations, Santiago. Available at: <http://www.cepal.org/publicaciones/xml/3/52143/thedigitaleconomyforstructuralchange.pdf>; Accessed 14 June 2016
- Gorkin A.P. (2012) Geografiya postindustrialnoy promyshlennosti (metodologiya i rezultaty issledovaniy, 1973 – 2012 gody) [Geography of industry in postindustrial economy (methodology and research results for 1973 – 2012)]. Oikumena, Smolensk. (In Russ)
- Heifetz B. (2015) Investitsyonnyi razvorot BRIKS [Investment reversal of the BRICS] //BRICS Russia Ufa, 2015. Russian Foreign Ministry. "International Life": 22. Available at: <http://www.consrio.mid.ru/doc/BRICKS-UFA.pdf> (In Russ) Accessed 25 June 2016
- INDSTAT4 (2016) Industrial Statistics Database. Available at: [https://www.unido.org/data1/IndStatBrief/World\\_Leading\\_MVA.cfm?print=no&ttype=W6&Country=&Group=](https://www.unido.org/data1/IndStatBrief/World_Leading_MVA.cfm?print=no&ttype=W6&Country=&Group=) Accessed 25 June 2016.
- Kenji E. Kushida (2015) The Politics of Commoditization in Global ICT Industries: A Political Economy Explanation of the Rise of Apple, Google, and Industry Disruptors. Journal of Industry, Competition and Trade 1(15): 49-67
- Kovalyov Yu. Yu. (2015) Innovatsionnye sistemy stran BRIKS [Innovative systems of the BRICS countries economy]. Izvestiya Rossiiskoi Akademii Nauk. Seriya Geograficheskaya 1: 35 – 47 (In Russ)
- Lo V., Hiscock M. (2014) The rise of the BRICS in the global political economy: changing paradigms? Edward Elgar Publishing. Cheltenham, Northampton
- Luckhurst J. (2013) Building Cooperation between the BRICS and Leading Industrialized States. Latin American Policy. Available at: <http://onlinelibrary.wiley.com/doi/10.1111/lamp.12018/full>. Accessed 14 June 2016.
- Mansell R. and When U. (1998) Knowledge societies: Information Technology for sustainable development. Oxford University Press, Oxford, UK.
- Prasad B.R. (2013) BRICS and The Global Economy. Financial Technologies Knowledge Management Company Limited, Mumbai.
- Prozorovsky A.S. (2015) The 6th BRICS leaders' meeting. Zapad-Vostok-Rossiya (Yearbook): 53 –54 (In Russ)
- Rodionova I.A. (2005) Mirovaya ekonomika: industrialnyi sektor [World economy: industrial sector]. - M.: RUDN (In Russ)
- Rodionova I. (2013) Spatial and time development regularities of the world industry in the conditions of globalization. Moscow University Globalistics and Geopolitics Bulletin 1: 77-83
- Rodionova I. (2014) World industry in post-industrial society: tendencies and regional shifts. Miscellanea Geographica - Regional Studies on Development. Volume 18, Issue 1: 31-37 <https://www.degruyter.com/view/j/mgrsd.ahead-of-print/v10288-012-0044-z/v10288-012-0044-z.xml> ISSN: 2084-6118 • DOI: 10.2478/v10288-012-0044-z
- Rodionova I., Massarova A., Epifantseva A. (2015) BRICS countries in international innovation rankings. Vestnik RUDN Seriya "Ekonomika" 3: 45-52
- Rodionova I.A., Sluka N.A., Kokuytseva T.V. (2016) Proizvodstvo vysoko tekhnologichnoi produktsii: pozitsii stran BRIKS v menyaiushemsya mire. (Production of high-tech products: the position of the BRICS countries in a changing world) // Successes of modern science 3: 190-197. Available at: <http://www.natural-sciences.ru/ru/article/view?id=35847> (In Russ)
- Rodionova I., Kokuytseva T., Semenov A. Features of Migration Processes in Different World Industries in the Second Half of XX Century // Journal of Applied Economic Sciences, Volume XI, Issue 8 (46), Winter 2016
- Science and Engineering Indicators – 2016. Appendix (tables 6). Two volumes. Arlington, VA: 2016. National Science Foundation, USA. Available at: <http://nsf.gov> Accessed 14 January 2017.
- Shahid Y. (2012). From Technological Catch-up to Innovation: The Future of China's GDP Growth. World Bank, Washington. Available at: <https://openknowledge.worldbank.org/bitstream/handle/10986/12781/701780ESW0p1170na008181100for0SIC0.pdf?sequence=1>. Accessed 14 June 2016.

- Sharova E.A. (2015) Perspektivy innovacionno-tekhnologicheskogo sotrudnichestva stran BRIKS [Prospect of the BRICS innovative and technological cooperation. Russian Institute for Strategic Studies]. Available at: <http://riss.ru/smi/7240/> Accessed 14 June 2016 (In Russ)
- Sluka N.A. (2015) Bolshaya strana – bolshie perspektivy [Big country – big projects]. *Valovoy vnutrenniy product* 5 (94): 26-31.
- Soete L. (2007) From Industrial to Innovation Policy. *Journal of Industry, Competition and Trade*. Available at: <http://link.springer.com/article/10.1007/s10842-007-0019-5/fulltext.html>. Accessed 14 June 2016.
- Soukup J. (2013) Knowledge economy and innovation indices: their concordance and diversity. The 7th International Days of Statistics and Economics, Prague, September 19-21: 1295-1303
- The World Factbook. Central Intelligence Agency. USA. Available at: <https://www.cia.gov/library/publications/resources/the-world-factbook/> Accessed 14 January 2016
- UNESCO Science report: towards 2030 (2015). UNESCO Publishing. Paris.
- World Development Indicators: Science and technology (tabl 5.13) Available at: <http://wdi.worldbank.org/table/5.13#> Accessed 14 January 2017
- Measuring the Information Society Report 2015. Executive Summary. International Telecommunication Union. Geneva Switzerland. [DoA: 15.03.2017]. Available from: <http://www.itu.int/en/itu-d/statistics/documents/publications/misr2015/misr2015-es-e.pdf>
- R&D Magazine. 2016. Global R&D Funding Forecast. Winter 2016. A Supplement to R&D Magazine. Industrial Research Institute (IRI). (IRI), Washington, D.C., [DoA: 15.03.2017]. Available from: <http://www.iriweb.org/sites/default/files/2016GlobalRDFundingForecast.pdf>
- Rodionova, I. (2013). Competitiveness of countries in the world innovation economy: East-Central Europe and Russia. *Quaestiones Geographicae* 32(2): 15-24, DOI: 10.2478/quageo-2013-0010. [DoA: 10.08.2014]. Available from: <http://www.degruyter.com/view/j/quageo.2013.32.issue-2/quageo-2013-0010/quageo-2013-0010.xml?format>
- OECD Science, Technology and Industry Scoreboard 2015. Innovation for growth and society. OECD Publishing, Paris [DoA: 15.03.2017]. Available from: <http://www.oecd.org/sti/oecd-science-technology-and-industry-scoreboard-20725345.htm>
- Kholina, V., Mironova M. Russian Economic Space: Evolution during Period of Reforms, Growth and (1990-2010). // *Miscellanea Geographica – Regional Studies on Development*. Issue 1 (Oct. 2012), pp.23-29. ISSN: 2084-6118 Versita, Poland. [DoA: 20.03.2017]. Available from: <http://www.degruyter.com/view/j/mgrsd.2012.16.issue-1/issue-files/mgrsd.2012.16.issue-1.xml>
- Samburova E.N. (2014) Regional disproportions of the modern development of China's economy // *Bulletin of Moscow University. Series 5. Geography*. No. 4, 2014. P. 49-55. [DoA: 10.02.2017]. Available from: <http://www.msu.ru/resources/msu-publ.html#vestnik> (in Russ.).
- Rodionova I., Kokuytseva T., Semenov A. (2016) Features of migration processes in different world industries in the second half of the XX century // *Journal of Applied Economic Sciences*. Volume XI, Issue 8 (46), Winter 2016). P. 1769-1780 [DoA: 10.02.2017]. Available from: [http://www.cesmaa.eu/journals/jaes/files/JAES%20Winter%208\(46\)\\_online\\_last.pdf](http://www.cesmaa.eu/journals/jaes/files/JAES%20Winter%208(46)_online_last.pdf)

## ANTECEDENTS TO BRAND HATE AMONG GENERATION Y: A CONSUMER CROSS-CULTURAL STUDY

Rodrigues, Clarinda<sup>1</sup>; Rodrigues, Paula<sup>2</sup>

<sup>1</sup>School of Business and Economics, Linnaeus University, Kalmar, Sweden

<sup>2</sup>School of Economic and Management, Lusíada University North, Porto, Portugal

### ABSTRACT

Previous research highlights that brand experiences impact on how consumers relate emotionally to brands. Nevertheless, research on negative brand experiences is scarce, particularly in the field of brand hate. In order to fulfill the identified research gap, this paper aims to investigate the negative aspects of brand relationships by focusing on the antecedents of brand hate among Generation Y. Moreover, it explores weak innovativeness, perceived quality, brand social responsibility and brand personality impact on brand hate. More precisely, it attends to the mediating effect of brand experience on brand hate. A survey with Apple and Samsung was conducted among Swedish and Portuguese consumers. The model has been tested using SEM. Our findings show that the effects of the antecedents of brand hate in general vary for both brands and countries.

*Keywords: Brand Hate, Brand Experience, Generation Y, Brand Innovativeness, Brand Perceived Quality, Brand Social Responsibility, Brand Personality, SEM*

### INTRODUCTION

Consumer-brand relationships have been a focus of branding theory over the last two decades (Fetscherin & Heinrich, 2015). The need to connect with consumers emotionally and develop close and long-term relationships has prompted both marketing practitioners and academics to seek innovative ways to create compelling brand experiences. In fact, Generation Y consumers may consider brands as a relationship partner (Fournier, 1998) that brings meaning to their daily life when they are searching for or buying products and services (Brakus, Schmitt, and Zarantonello, 2009). The broad and long-term relationship, which is characterized by multiple interrelated cognitive, affective and behavioral elements (Batra, Ahuvia, and Bagozzi, 2012) will determine the nature of consumer feelings towards the brand. Hence, it can be claimed that brands that do bad may generate negative feelings among Generation Y consumers such as brand hate.

Hate is conceptualized, both in psychology and marketing literature, as an intense and negative feeling (Grégoire, Tripp, and Legoux, 2009; Johnson, Matear, and Thomson, 2011; Alba & Lutz, 2013;



Romani, Grappi, and Dalli, 2012; Bryson, Atwal, and Hultén, 2013). Most recently, Zarantonello, Romani, and Grappi (2016) conceptualized brand hate as a constellation of negative feelings and demonstrated that brand hate is associated to different types of negative behavioral outcomes such as “attack-like” (negative WOM), “avoidance-like” (patronage reduction/cessation) and “approach-like” strategies (consumer complaining and protest behaviors). Another stream of research shows that negative-brand relationships are influenced by poor quality of products, association to undesirable social groups, inconsistency of brand image, moral or values of those consumers (Park, Eisengerich, and Park, 2013).

Despite the anti-consumption research raised the importance of brand hate as an emerging branding concept, there is a growing call to extend the theory on the dark side of brands in order to obtain a more balanced and holistic understanding of negative consumer-brand relationships (Fournier & Alvarez, 2013). Furthermore, little is known about how Generation Y, a generational group that is well-educated, technological adept and knowledgeable about brands (Noble, Haytko and Phillips, 2009), reacts to negative brand experiences as a result of brand failures to deliver the desired functional and experiential values. Hence, the question remains in relation to which antecedents can generate brand hate among Generation Y consumers? And if those effects vary among different cultures?

## CONCEPTUAL BACKGROUND AND HYPOTHESES

According to Brakus *et al.* (1999), brand experience consists of five dimensions, namely sensory, affective, cognitive, behavioral and relational, which all provides consumers with memorable experiences along the consumption process. Hence, any time Generation Y consumers interact directly or indirectly with a brand, evaluative judgments are made in relation to the overall functional and experiential values provided by a branded product or service (Delgado-Ballester & Sabote, 2015). Moreover, branding literature suggests that consumer perceptions of brands are deeply anchored on brand associations that arise from the direct brand experiences (Brakus *et al.*, 1999). If Generation Y consumers are exposed to brand misconducts, they will react negatively to those brands and might manifest feelings of hate, either “active brand hate” (contempt/disgust and anger) or “passive brand hate” (fear, disappointment, shame and dehumanization) (Zarantonello *et al.*, 2016). According to Bryson *et al.* (2013), country of origin of the brand, customer dissatisfaction with the product, corporate social performance and negative stereotypes of users of the brand are predictors of brand hate. The research on brand hate antecedents is however scarce and does not take into account the significance of the overall brand experience. For that reason, the authors departure from marketing and branding literature to identify five antecedents to brand hate, i.e. brand perceived quality, brand

innovativeness, brand social responsibility and brand personality. All these branding constructs account together for the sensory, affective, cognitive, behavioral and relational dimensions of brand experience.

Previous research shows that consumer-brand relationships might be influenced by brands failures to meet consumer sensory or intellectual expectations in relation to quality (Park et al., 2013), when they are searching for or buying branded products or services. As a result, consumers may start manifesting hate feelings towards brands that are no longer able to comply with high standards of quality, especially when quality is perceived by consumers as a key kernel brand value (Kapferer, 2015). Hence, the authors hypothesize:

**H1: Brand perceived quality, mediated by brand experience, has a positive and direct relationship with brand hate.**

Brand innovativeness refers to the degree a consumer perceives a brand to be innovative and serves as a heuristic signal to consumers (Pappu & Quest, 2016) for technology, products and services. Hence, innovative brand experiences have a profound meaning for consumers (Lin, 2015) and if it fails to meet Generation Y consumer expectations it could result in strong negative feelings towards a brand. Hence, it is hypothesized that:

**H2: Brand innovativeness, mediated by brand experience, has a positive and direct relationship with brand hate.**

Brand social responsibility is defined as “consumers’ holistic (or gestalt-like) impressions regarding a brand’s social responsibility” (Grohmann & Bodur, 2014). Moreover, studies show that brand social responsibility’s perceptions are influenced by both products and marketing activities (ibid) and might be a predictor of brand hate (Bryson et al., 2013). Moreover, there is a growing concern about environmental and social issues among Generation Y consumers, which increases consumer attention towards brands that might start behaving badly. Thus, we suggest that consumers tend to manifest hate feelings towards brands that misbehave and are no longer able to address the Generations Y aspirational needs of contributing to a better world. Therefore, the authors hypothesize that:

**H3: Brand social responsibility, mediated by brand experience, has a positive and direct relationship with brand hate.**

Brand personality is defined as “the set of human characteristics associated with a brand” (Aaker, 1997, p. 347). Research in the dynamic construal of brand personality demonstrates that the relationship with brands could result either in signs of reinvigoration or brand suffer in the wake of transgressions (Aaker, Fournier, and Brasel, 2004). Given the importance of relating to brands which are the usually the reflection of the individual’s self-concept (Beck, 1988), we believe that Generation Y

consumers are more prompt to manifest extreme and negative feelings towards brands whose personality is not aligned with their self. Hence, it is hypothesized that:

**H4: Brand personality, mediated by brand experience, has a positive and direct relationship with brand hate**

## METHODOLOGY

In order to examine the postulated hypotheses, an empirical study was conducted in Sweden and Portugal from September to October 2016. A survey on universally known brands – Apple and Samsung – was carried out among Generation Y consumers using a convenient sample. In total, 362 participants aged 18 - 25 years completed the questionnaire (156 in Sweden and 206 in Portugal). Gender is distributed almost equally in both countries: in Sweden 69,2 per cent of the participants are female and 30,1 per cent are male, whereas in Portugal 54,4 per cent of the participants are female and 45,6 per cent are male. A set of validated scales from marketing and branding literature were used and followed the evaluation of the psychometric properties of the scales proposed by Churchill (1979) and Bollen (1989), in order to guarantee that the proposed scales are reliable, have validity and are one-dimensional. All indicators, at the exception of brand-relationship construct, are formulated as to serve a five-point Likert scale ranging from 1 “Not at all” to “Very much”. To measure brand innovativeness (BI) we used four items from Pappu and Quester’s (2016) scale, brand experience (BE) was measured with four items from Brakus et al.’s (2009) scale, brand social responsibility (BSR) was measured with eleven items from Grohmann and Bodur’s scale (2015), we measured brand personality (BP) with ten items from Geuens, Weijters and Wulf’s(2009) scale, and finally brand quality perceived (BQP) was measured with three items from Yoo, Naveen, and Sungho (2000) scale. To operationalize brand hate, we asked the respondents to evaluate their relationship with both brands using a five-point Likert scale. In order to test our hypotheses, we examined our model using structural equation modelling. Moreover, we followed the assumption of Anderson and Gerbing (1982) that the modelling of structural equations must be done through two conceptual distinct models: confirmatory factor analysis and structural model for both countries and for two brands (Apple and Samsung). Finally, we tested our model and our proposed hypotheses by estimating the paths between the constructs and determining their significance.

## MAJOR RESULTS

In total, 206 questionnaires were validated in Portugal and 156 questionnaires in Sweden for both Apple and Samsung. The confirmatory factorial analysis shows a high internal consistency of the constructs for both countries and both brands. Fit indices and scale reliabilities reveal a good overall model fit. In each case, the Cronbach's alphas exceed 0,7 as Nunnally and Bernstein (1994) recommend. The composite reliability of each factor is greater than 0,6 and the average variance extracted (AVE) exceeds 0,5 (Bagozzi & Yi, 1988). As evidence of convergent validity, the CFA results indicate that all relations of the items to their hypothesized factor are significant ( $p < 0,001$ ) and that all standardized loadings are greater than 0,6 (Bagozzi & Yi, 1988). Moreover, results provide support for discriminant validity (Fornell & Larcker, 1981). In particular, for each pair of variables, the squared correlation was always lower than the average variances extracted of each of the two constructs. In order to purify the scales used, some items from brand personality and brand social responsibility were removed. Hence, in Portugal the social brand responsibility scale was reduced to seven items and brand personality to five items. The same procedure was applied in Sweden, resulting in three items for social brand responsibility and six items for brand personality. After the stabilisation of the model of measurement and the analysis of the quality of the adjustment, we verified whether the hypotheses of research were confirmed or not. In the case of the model proposed, estimation was carried by the method of the maximum likelihood (ML), so that the objective of developing and testing the hypotheses could be met. Consequently, results of the estimated models are presented and discussed below (Fig. 1 and Fig. 2).

Overall, the postulated model performs well and most of the paths are significant accounting for the robust effects of the constructs. For Apple, and for Portuguese case, findings show that brand innovativeness (BI) ( $\gamma_{11} = 0,505$ ,  $p = 0,000$ ), brand perceived quality (BPR) ( $\gamma_{12} = 0,165$ ,  $p = 0,000$ ) and brand personality (BP) ( $\gamma_{13} = 0,275$ ,  $p = 0,000$ ) indirectly affects brand hate, through the moderating effect of brand experience (BE). On the other hand, in Sweden BPR (brand perceived quality) is not statically significant to affect brand experience. Instead, brand personality (BP) ( $\gamma_{13} = 0,149$ ,  $p = 0,000$ ) and brand innovativeness (BI) ( $\gamma_{11} = 0,498$ ,  $p = 0,000$ ) directly affects brand experience (BE) in a positive manner. Nevertheless, the path between brand experience and brand hate ( $\beta_{21} = 0,078$ ,  $p = 0,368$ ) is insignificant for Sweden.

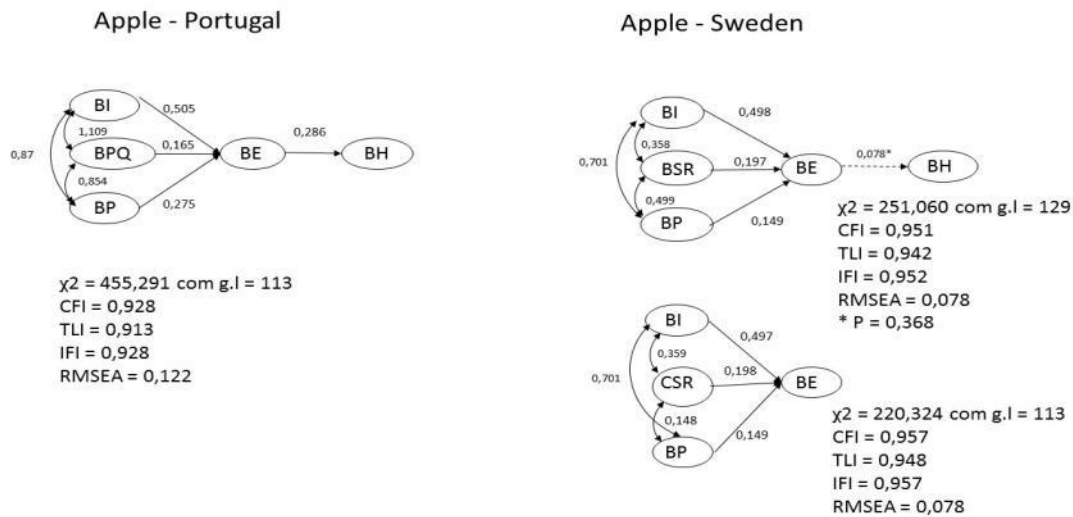

Fig. 1 - Structural Model Estimated for Apple

Regarding Samsung, findings demonstrate that both in Portugal and Sweden brand innovativeness (BI) has a positive and direct effect on brand experience (BE). Furthermore, for Portugal it is demonstrated that brand social responsibility (BSR) also has a positive and direct effect on Brand Experience (BE), whereas in Sweden is brand personality (BP) ( $\gamma_{12} = 0,274, p = 0,000$ ). Interestingly, the path between brand experience (BE) and brand hate (BH) ( $\beta_{21} = 0,181, p = 0,000$ ) is significant only for Portugal.

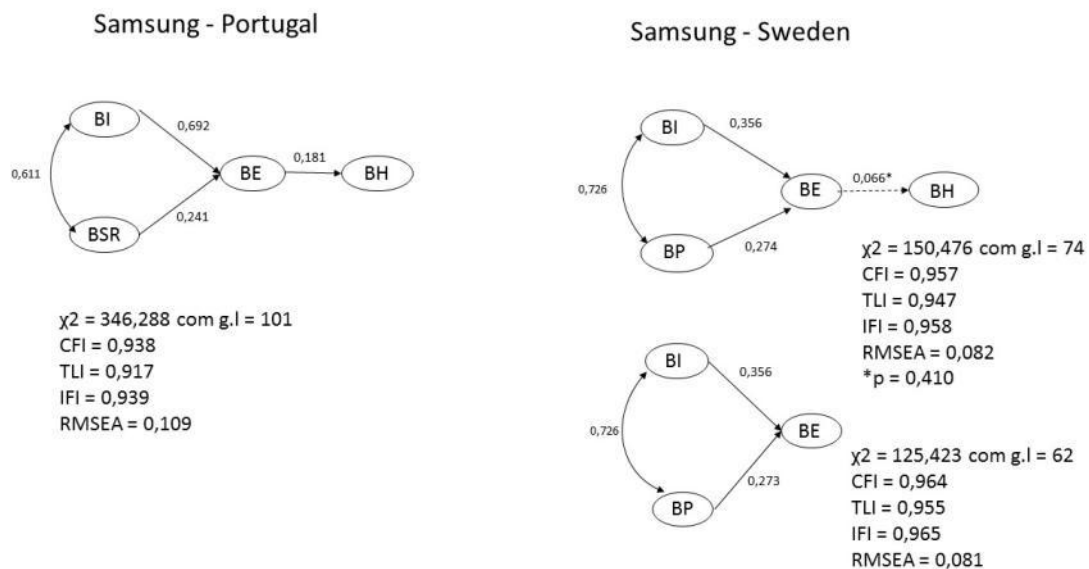

Fig. 2 - Structural Model Estimated for Samsung

## CONCLUSIONS

Research on brand hate remains in its infancy and has offered limited insights into its antecedents and moderators. Our results account for the multidimensionality of brand hate, demonstrating the importance of brand perceived quality, brand innovativeness, brand social responsibility and brand personality for developing brand hate towards brands. The impact of these four constructs on brand hate have been not investigated previously in the marketing and branding literature, though they often appear associated to consumer-brand relationships literature in general. In line with previous studies (Park et al., 2013; Bryson et al., 2013; Aaker et al., 2004) we confirm the importance of all the four constructs in affective relationships with brands by showing how brand misbehaves can generate intense negative feelings towards the brands (Zaratonello et al., 2016) among Generation Y. Nevertheless, our findings demonstrate significant cross-cultural differences regarding antecedents to brand hate for Apple and Samsung brands. In particular, the lack of brand innovativeness drives brand hate for both brands. This could be explained by the fact that Apple and Samsung are technological based and Generation Y consumers might expect those brands to offer them continuous innovation. On the other hand, results show for both countries that brand perceived quality and brand personality are antecedents to brand hate for Apple, whereas antecedents to brand hate for Samsung are different in both countries. In fact, brand hate is positively influenced by brand innovativeness in both countries, but brand social responsibility has a greater influence on brand hate in Portugal and brand personality in Sweden. The antecedents to brand hate of the two brands could be explained at the light of the importance of quality and personality traits associated with premium brands such as Apple, while brand social responsibility might be related to the perception of Asian brands (ex: Samsung) as non-social and environmental responsible.

As another contribution, we demonstrate the relevance of brand experiences as a moderator of brand hate. Collectively, our results account for significant differences between the two countries in relation to how Generation Y consumers tend to manifest extreme negative feelings towards brands, which are not able to create meaningful and compelling brand experiences. As discussed by Fournier (1998) consumers may consider brands as a relationship partner that brings meaning to their lives when they are searching products and services (Brakus et al., 2009). If brands fail to deliver cognitive, affective and behavioural elements within their broad and long-term relationship with Generation Y consumers, it may influence negatively how they relate to those particular brands. Interestingly, however, our findings demonstrate that in Portugal there is a direct and positive relationship between brand experiences and brand hate. This could be explained by the fact that Portuguese consumers are more emotionally driven towards brands than Swedish consumers and, therefore, more prompt to manifest hate feelings towards brands that they consider as bad relationship partners. In fact,

Generation Y consumers might feel deceived if those brands fail to meet their expectations along the overall brand experience. On the other hand, Swedish Generation Y consumers seem to be more tolerant if brands fail to deliver the desired functional and experiential values and therefore do not tend to manifest extreme negative feelings towards brands.

## IMPLICATIONS

From a theoretical perspective, this paper expands on research about negative consumer-brand relationships by proposing brand innovativeness, brand perceived quality, brand social responsibility and brand personality as new antecedents to brand hate. Additionally, it stresses the relevance of brand experiences as a moderator to brand hate. Finally, it explores for the first time how Generation Y consumers reacts upon brand failures when delivering experiences and which are the effects on brand hate. From a managerial perspective, this study sheds light on the importance of understanding the reasons behind brand hate. By identifying them, brand managers could prevent from engaging in misconducting behaviors, which are negatively perceived by consumers. In particular, brands should continuously innovate, enhance its product and quality standards, implement adequate brand social responsibility policies and be selective in the manner they shape their brand personality.

## LIMITATIONS AND FUTURE RESEARCH

One of the limitations of this study relates to the non-probabilistic sample since the surveys were only conducted in two universities. Secondly, being a cross-cultural study it is recommended to include other countries in the data collection. Thirdly, brand experience was used as the only moderator and it could be interesting to explore the mediating effects of other branding constructs. Finally, a future avenue of research relates to the outcomes of brand hate among Generation Y.

## REFERENCES

- Aaker, J. (1997). Dimensions of brand personality. *Journal of Marketing Research*, 24 (August), 347-356.
- Aaker, J., Fournier, S. & Brasel, S.A. (2004). When Good Brands do Bad, *Journal of Consumer Research*, 31, 1-16.
- Alba, J.W. & Lutz, R.J. (2013). Broadening (and narrowing) the scope of brand relationships", *Journal of Consumer Psychology*, 23 (2), 265-268.
- Anderson, J. C. & Gerbing, D. W. (1988). Structural Equation Modelling in Practice: A Review and Recommended Two-Step Approach. *Psychological Bulletin*, 103(3), 411-423.
- Bagozzi, R. P. & Yi, Y. (1988). On the evaluation of Structural Equation Models. *Journal of the Academy of Marketing Science*, 16(Spring), 74-94.
- Batra, R., Ahuvia, A, & Bagozzi, R. (2012). Brand Love. *Journal of Marketing*, 76 (March), 1-16.
- Beck, R.W. (1988), "Possessions and the extended self", *Journal of Consumer Research*, Vol. 15, September, pp. 139-68.
- Bollen, K.A. (1989). *Structural Equations with Latent Variables*, New York: John Wiley & Sons, Inc.

- Brakus, J.J., Schmitt, B.H. & Zarantonello, L. (2009). Brand Experience: What is? How to measure it? Does it affect Loyalty? *Journal of Marketing*, 73 (3), 52-68.
- Bryson, D., Atwal, G. & Hultén, P. (2013). Towards the conceptualization of the antecedents of extreme negative affect towards luxury brands, *Qualitative Market Research: An International Journal*, 16(4) 393-405.
- Churchill, J. R. (1979). A Paradigm for Developing Better Measures of Marketing Constructs. *Journal of Marketing Research*, 16(1), 64-73.
- Delgado-Ballester, E. & Sabote, E.F. (2015). Brand experiential value versus brand functional value: which matters for the brand?. *European Journal of Marketing*, 49 (11/12), 1857-1879.
- Fetscherin, M. & Heinrich, D. (2015). Consumer brand relationships research: A bibliometric citation meta-analysis, *Journal of Business Research*, 68(2), 380-390.
- Fornell, C. & Larcker, D. F. (1981). Evaluating Structural Equation Models With Unobservable Variables And Measurement Error. *Journal of Marketing Research*, 18(1), 382-388.
- Grégoire, Y., Tripp, T.M. & Legoux, R. (2009). When customer love turns into lasting love: the effects of relationship strength and time on customer revenge and avoidance, *Journal of Marketing*, 73(6), 18-32.
- Grohmann, B. & Bodur, H.O. (2014). Brand Social Responsibility: Conceptualization, Measurement and Outcomes, *Journal of Business Ethics*, 131, 375-399.
- Geuens, M., Weijters, B., & De Wulf, K. (2009). A new measure of brand personality. *International Journal of Research in Marketing*, 26, 97-107.
- Geuens, M., Weijters, B., & De Wulf, K. (2009). A new measure of brand personality. *International Journal of Research in Marketing*, 26, 97-107.
- Fournier, S. (1998). Consumers and their brands: developing relationships theory in consumer research. *Journal of Consumer Research*, 24 (4), 343-373.
- Fournier, S. & Alvarez, C. (2013). Relating badly to brands. *Journal of Consumer Psychology*, 23 (2), 253-264.
- Johnson, A.R., Matear, M. & Thomson, M. (2011). A coal in the heart: self-relevance as a post-exit predictor of consumer anti-brand actions, *Journal of Consumer Research*, 38 (1), 108-125.
- Kapferer, J.N. (2015). *The New Strategic Brand Management: Advanced Insights and Strategic Thinking*. Kogan Page Limited.
- Lin, Y.H. (2015). Innovative brand experience's influence on brand equity and brand satisfaction, *Journal of Business Research*, 68, 2254-2259.
- Nunnally, J. C. & Bernstein, I. H. (1994). *Psychometric Theory*, 3rd ed., New York: McGraw-Hill.
- Noble, S.M., Haytko, D.L. & Phillips, J. (2009), What drives college- age Generation Y consumers? *Journal of Business Research*, 62 (6), 617-628.
- Park, C.W., Eisengerich, A.B. & Park, J.W. (2013). Attachment-aversion (AA) model of customer-brand relationships. *Journal of Consumer Psychology*, 23(2), 229-248.
- Pappu, R. & Quest, P.G. (2016). How does brand innovativeness affect brand loyalty? *European Journal of Marketing*, 50(1/2), 2-28.
- Romani, S., Grappi, S. & Dall'Aglio, D. (2012), Emotions that drive consumers away from brands: measuring negative emotions towards brands and their behavioral effects, *International Journal of Research in Marketing*, 29 (1) 55-67.
- Yoo, B., Naveen, D. & Sungho, L. (2000). An Examination of Selected Marketing Mix Elements and Brand Equity. *Journal of the Academy of Marketing Science*, 28(2), 197-213.
- Zarantonello, L., Romani, S., Grappi, S. & Bagozzi, R.P. (2016). Brand Hate. *Journal of Product and Brand Management*, 25 (1), 11-25.



# THE MULTISENSORY EXPERIENCE OF TASTE. THE EFFECTS OF SENSES AND BRAND IN WINE CONSUMPTION

**Romanazzi, Salvatore; Petruzzellis, Luca**

University of Bari, Bari, Italy

*Keywords: wine, sensory branding, branding, multisensory experience, gift giving, self consumption wine experience*

## INTRODUCTION

Consumer preferences are driven not only by functional elements, but also by various specific brand-related stimuli, resulting in a comprehensive experience (Ding and Tseng, 2015). In particular, sensory stimuli impact both cognitive and emotional reactions, which influence consumers' perceptions of products and brands (Krishna, 2012). Previous research has investigated the role of senses in stimulating purchase, retail patronizing and brand preferences (e.g., Chebat et al., 2001; Mattila and Wirtz, 2001). Sensory stimuli have been shown to create positive associations and perceptions in consumers, resulting in positive overall experiences, with these elicited emotions, thoughts and sensations contributing to a positive brand attachment (Brakus et al., 2009). However, only recently studies (e.g., Biswas et al., 2014; Spence, 2012, 2015) are combining more than one sense to understand their combined effect on consumer experience (Schifferstein and Spence, 2008).

Wine consumption provides a valid and interesting context to understand the combination of the senses involved in consumer experience, given that wine is an experience good whose quality cannot be truly assessed until the product has actually been consumed (Jaeger et al., 2009). Therefore, the sensory aspects are seen as an integral part of the consumer's total product experience when consumption takes place (Bruwer et al., 2011; Lee and Lee, 2008). Consumers are also driven by other factors such as product attributes, use situation, product experience and knowledge (Hollebeek et al., 2007; MacDonald et al., 2013). The influence of these factors varies in intensity, according to consumer expertise (Perrouy et al., 2006).

Most of previous wine marketing research (e.g., Camillo, 2012; Martinez et al., 2006) has focused on the importance of intrinsic and extrinsic attributes. The former are those related to physical attributes that cannot be altered in the final product and which cease to exist when it has been consumed (Olson and Jacoby, 1972) such as color, flavor and grape variety (e.g., Jover et al., 2004). The latter are related to the product, but are not physically part of it (Olson, 1977), such as brand, price, label, bottle form and color, and purchase occasion (e.g., Mueller and Szolnoki, 2010).

These studies, however, did not really predict which combinations of factors actually motivate consumer preferences. A few sensory consumer studies (Enneking et al., 2007; Raz et al., 2008) have separated the relative effects of extrinsic and intrinsic attributes on consumer choice through a conjoint analysis approach. However, these studies used only one single intrinsic attribute (i.e., sweetness or aroma) to prevent possible conflict caused by the usage of multiple sensory cues. On the other hand, several studies (e.g., Lockshin et al., 2006; MacDonald et al., 2013) have measured the relative importance of various extrinsic attributes in regards to product choice, without integrating any sensory characteristic into their research design.

Studies that take into account cognitive, emotional and sensory aspects are therefore needed, since these factors contribute to creating a whole experience. The experiential responses stored in a consumer's memory involve cognitive, affective and sensorial systems (Brakus et al., 2009). It is through these interactive experiences that consumers build their preferences and purchasing decisions.

This paper seeks to understand the effect of the combination of more than one sense (sight, olfaction and taste) and of the brand on wine experience. Therefore, wine experience has been defined as a combination of sensations, feelings, cognitions, and behavioral responses stimulated by extrinsic and intrinsic attributes. This depends on when and where consumers experience a specific wine, which have cognitive and emotional aspects. The main idea is that consumers choose wine not only for the experience they get through the sense of taste, but also through other senses that help enhance and reshape the informational role of the intrinsic attributes, shifting wine consumption into a hedonic experience (Chrea et al., 2011). The attention is focused on the unique multisensory aspects of taste perception, thus exploring whether other senses can have an impact on taste perceptions. Taste is a curiously unique sensation as it is composed not only of one sensory input (i.e., from the tongue) but is also created by incorporating multiple sensory inputs (Elder and Krishna, 2010).

One of the main focal points of this article is to explore the interaction of cognition and sensory perception, particularly taste, given that, in addition to a reliance on intrinsic cues from the food itself, taste is susceptible to extrinsic cues such as brand. Moreover, since insights into consumers' perception of the importance of these elements, under specific contextual conditions (i.e., purchase and/or consumption situations), are still rather limited (Martinez et al., 2006), this study examines two main occasions for consumption: self-consumption and gift.

The remainder of this paper is organized as follows: the theoretical background is discussed, followed by hypotheses, as well as an overview of research methods. Results are then presented and discussed, ending with a look at practical implications and a short conclusion.

## THEORETICAL BACKGROUND

Consumers assign their preferences to products according to the relative benefits they obtain from them. The experiential enjoyment is related to the product's sensorial aspects, which encourage a greater brand affect, while practical functionality derives from tangible aspects that generate high levels of brand trust (Babin et al., 1994).

Literature has found intrinsic cues to be more important in assessing quality, since they have greater predictive value than extrinsic cues (Zeithaml, 1988). Therefore, intrinsic cues are particularly important at the time of purchase and upon consumption. However, in the absence of previous experience with a product, consumers often tend to assess its quality on the basis of extrinsic cues (Veale and Quester, 2008). Since in most purchase situations consumers do not have the opportunity to taste a particular wine before buying, extrinsic attributes (i.e., what is outside the bottle) are used to evaluate intrinsic ones (i.e., what is inside the bottle) (Menichelli et al., 2012).

Studies on food consumer behavior have mainly analyzed the processes before the purchase such as information search, exposure to and processing of purchase related cues, which do not involve tasting, while sensory affective studies that involve tasting mainly deal with processes that occur after the purchase (Grunert, 2003).

### *Intrinsic and extrinsic attributes in wine experience*

Consumers form opinions about wine through the evaluation of intrinsic and extrinsic product attributes (Veale and Quester, 2008). Given the high number of factors that influence consumers' decision to purchase wine (Bruwer et al., 2011) and the difficulty in accurately evaluating both extrinsic and intrinsic attributes due to lack of product knowledge or situational circumstances (Martinez et al., 2006), consumers look for proxy indicators to make their decision (e.g., price, brand name, region of origin, winemaker, grape variety, label, awards and recommendations).

Although consumers give more credence to intrinsic attributes than to extrinsic ones (Veale and Quester, 2008), extrinsic attributes play an important role when perceived intrinsic cues are insufficiently predictive or consumers are unable to accurately assess their influence on quality (Srinivasan et al., 2004). Moreover, situational influences, such as the absence of intrinsic cues or the purchase associated with self-image or status (i.e., gift-giving), can increase the reliance on extrinsic cues (Kardes et al., 2004). However, previous research has not clarified the combined effect of these factors on consumer experience.

Consumers select, from a range of products/brands, the one they feel may be suitable for a particular situation (Yang et al., 2002). The purchase situation (Ritchie, 2007) and purchase purpose (Olsen et al., 2007) have been found to strongly influence consumers' motivation to buy and their wine experience.

Two main purchase occasions have been identified (Fennell, 1978; Thach, 2002): the interest opportunity, or self-consumption, in which functional cues are more important, and the sensory pleasure opportunity, exemplified in convivial and gift occasions, in which experiential cues are more important.

In particular, consumers prove to be more cautious when shopping for gift-giving, since they seek to avoid the social cost of an inaccurate delivery and inadequate product quality (Baskin et al., 2014; Gino and Flynn 2011; Steffel and LeBoeuf 2014). Previous research (Garcia-Retamero and Galesic, 2012; Laran, 2010; Polman and Emich 2011) has found that, in the domain of gift-giving, givers are much more aware of the inputs into their gifts than are recipients. This perspective difference can lead givers to invest resources into gifts that fail to have the intended effect on recipients. Indeed, gift givers experience different levels of shopping involvement, which depend on the relationship with the recipient and the gift-giving occasion (Beatty et al., 1991). In fact, if the occasion and the recipient are high task involvement, the gift giver will more likely select a gift that is high in involvement as well. Gift selection is therefore a more involving task than buying for personal use (Melo et al., 2010). Specifically, wine consumption can be explicitly related to the situation and context (Bruwer et al., 2002) and its social aspect is important as a rite of passage or to promote social interaction (Ritchie, 2007). Therefore, it has been hypothesized that:

H1a: Intrinsic attributes influence wine experience more positively than extrinsic attributes in sensory pleasure occasion than in interest opportunity occasion.

The use of intrinsic or extrinsic cues varies depending on the level of a consumer's wine expertise, which derives from the meanings that consumers learn about, and associate with, the wine and its brand (Hussain et al., 2007). These meanings include functional, symbolic and sensory associations (Bruwer and Buller, 2012). The level of expertise plays an important role when a purchase takes place, and has a different effect on sensory evaluation (Frøst and Noble, 2002). Since taste pleasantness cannot usually be experienced during the decision moment, only an experienced consumer can undertake a more reasoned decision (MacDonald et al., 2013). Less experienced consumers tend instead to rely on ratings from experts or medals/awards, thus showing a simple like or dislike for a particular wine (Schiefer and Fischer, 2008). Previous studies have found that, when making their purchase decision, consumers with high level of knowledge rely more frequently on intrinsic cues compared to consumers with lower level (Phau and Suntornnond, 2006).

As different types of product-related experiences lead to different levels of expertise (Erdem et al., 1999), which, in turn, have various effects on product evaluation and choice behavior, it is hypothesized that:

H1b: Greater expertise is related more to intrinsic attributes than extrinsic ones.

*The effect of senses on wine experience*

Sensory stimuli affect consumers' perception of products and brands, as they impact both cognitive and emotional reactions (Krishna, 2012). However, extrinsic cues can be powerful enough to overcome sensory perceptions (Garber et al., 2000), since sensory perceptions are not always accurate and are influenced by expectations and beliefs (Priilaid, 2006). This means that intrinsic attributes can be weighted and interpreted more accurately when evaluated by consumers, even if the evaluation is through sensory means (Spence, 2012).

Wine is a product for which the evaluation of intrinsic sensory characteristics is strongly affected by extrinsic attributes (Mueller et al., 2010b). In particular, taste is not physiologically made up of sensations from taste buds only; it also relies heavily on input from the other senses (Spence, 2015). It derives first from sight and then odor. Each sense has some role in generating taste (Rolls, 2005). Sight works cognitively to inform and identify the product, and affectively to differentiate and stimulate emotions; visual clues are also significant in consumer quality evaluations (Garber et al., 2000; Hoegg and Alba, 2007). Experiments in meat consumption (Bredahl, 2003; Hurling and Sheperd, 2003) showed that consumers prefer the appearance of very lean and red steak, which contributes to a better tasting product.

Olfaction, instead, is the truly emotional sense, and naturally hedonic, evoking a primary reaction of either liking or disliking. It produces an experience that involves at least some degree of self-reference, thus having an effect on affective processes and hedonic values (Fitzgerald Bone and Jantrania, 1992; Small and Prescott, 2005). Finally, taste drives choice and experience, thus creating an attachment with the wine chosen. It is both cognitive and affective (Veale and Quester, 2008).

It is thus evident from physiology and neuroscience literature (e.g., Spence, 2015; Spence and Piqueras-Fiszman, 2014) that taste is derived from multiple intrinsic sensory components, including smell and sight. However, the automaticity of these inputs is largely unexplored, leaving the question as to whether or not marketing actions incorporating these cues will have an impact on taste perceptions. This question addresses also the general impact of extrinsic cues on taste perceptions. The olfactory experience, which can also take place independently, always accompanies the tasting one together with the visual aspect, which can influence flavor perceptions (Deroy, Crisinel and Spence, 2013; Doty, 2015). However, food and drink consumption is not only a physical experience that involves smell, taste and sight, but also a cognitive and affective experience. The sensorial experience of tasting therefore can be described more easily from a cognitive point of view, notwithstanding its strong emotional component (Ferrarini et al., 2010). Therefore, it is hypothesized that:

H2: The combination of senses (sight, olfaction and taste) positively impacts wine experience

*The mediating role of brand attachment*

Wine has been found to be a product for which the evaluation of intrinsic sensory characteristics is strongly influenced by extrinsic attributes (Lange, Issanchou and Combris, 2000; Mueller et al., 2010b; Priilaid, 2006; Siegrist and Cousin, 2009). Consumers almost always are conscious of the extrinsic characteristics when actually consuming wine; that is they are informed about the wine's brand, origin, price and packaging (Mueller et al., 2010b). It is well acknowledged that consumers are heterogeneous in their liking of sensory cues (Carbonell et al., 2008; Semenou, 2007) and also differ in their reaction to extrinsic cues (Gracia, Loureiro and Nayga, 2009; Jaeger and Rose, 2008).

Brands facilitate the decision-making process, especially in the case of wine that is often regarded as complex and/or having a high level of associated risk (Lockshin et al., 2006). The addition of salient intrinsic attributes to a product or consumer experience enhances the quality and value perceived by consumers, and will increase the positioning strength of the brand (Batra and Ahtola, 1991). While some physical/functional attributes of the wine (e.g., producer information, label and bottle) are linked to the brand in its basic function of guarantee, risk reduction and trust building, the sensorial cues (e.g., color, bouquet) characterize the uniqueness of the offer and contribute to the brand attachment through symbolic meanings related to self-concept and social identity. An emotional utility is therefore reflected in the expression of the self and the brand experience (Keller, 1993).

Marketing literature has investigated the effect of senses on brands (e.g., Krishna, 2010), thus highlighting the sensory branding concept (Lindstrom, 2005). Senses, in particular, recall brand image and reputation (Brakus et al., 2009). The sensorial responses from a consumer's exposure to a brand precede affective responses (Zajonc and Markus, 1982) and the hedonic experience of senses (sight, odor, taste) contributes to the formation of mechanisms like brand attachment, which mediate all feelings with a pleasant experience (Park et al., 2008).

While a number of studies has proven and measured the combined effect of several extrinsic cues on product evaluation (e.g., Combris et al., 2009; Stefani et al., 2006), they did not disentangle their relative impact (Mueller and Szolnoki, 2010). Also unexplored is the degree to which consumers differ in their relative responsiveness to extrinsic cues. Moreover, only some brand elements, such as label and brand name, have been examined. Recently, Hoegg and Alba (2007) show the impact of several extrinsic cues for orange juice, including brand name, price, and region of origin, on taste discrimination and taste preference. Their findings include a national brand receiving better taste evaluations than a store brand and differences in the color of orange juice leading to greater differences in perceived taste than in brand labels. Therefore, it is hypothesized that:

H3: Brand attachment mediates the effect of senses on wine experience

This study tests the following conceptual framework (see figure 1), in which sensorial cues affect wine experience through the mediation of brand attachment. This framework is studied in 2x2 design; gift-giving vs. self-consumption and low vs. high expertise.

**Figure 1: Conceptual framework**

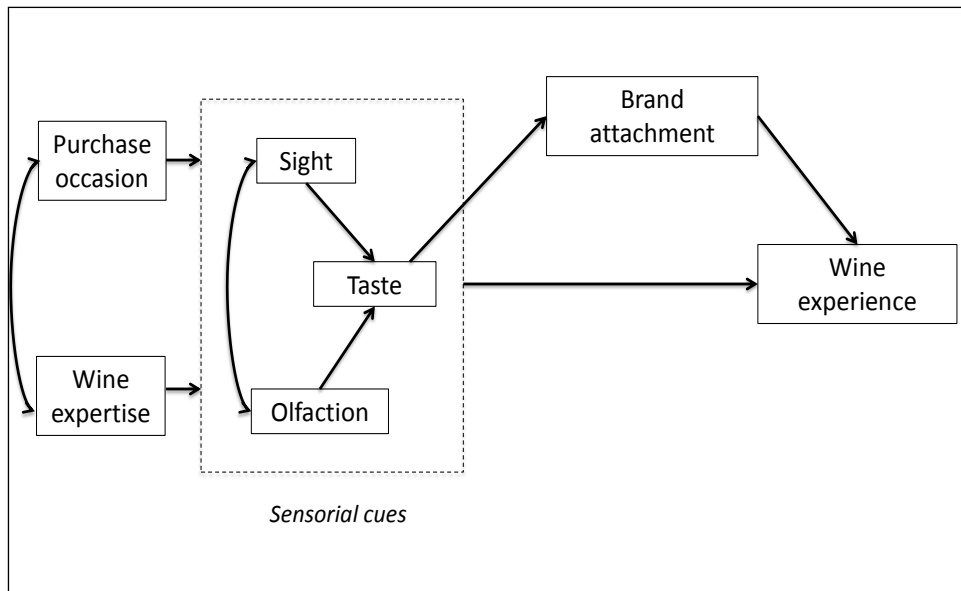

## METHODOLOGY

This paper aims to investigate the effect of the combination of sight, olfaction and taste on wine experience. A questionnaire was developed, in which all variables were measured on seven-point Likert scales (1 = not important, 7 = very important) using multiple items, in an effort to overcome the limitations of previous studies that used single-item rating scales (Cohen, 2009). The scales, whether used in full or partially (adjusting to the study objectives), were drawn from relevant literature. Respondents were asked to answer the questions in relation to the last bottle of their favorite wine they purchased. This approach particularly derives from the definition of wine experience, considering also that wine is a product with strong sensory fatigue due to its alcohol content (Mueller, Francis and Lockshin, 2009). In fact, Mueller et al. (2009) showed that in a blind condition consumers were not able to discriminate between wines due to the sensory interaction and carryover effects of stimuli in a choice set. Moreover, we were interested in memorable, attention capturing and easy to process perceptually experiences (Spence, 2012). Grunert (2003) found that, if a consumer has previously consumed a product, then the memory of the beliefs formed due to the previous taste experience will influence his later repurchase and not the original taste experience itself. Zandstra (2006) showed that the memory of a taste can be quite different from the actual taste impression. If one

analyses products that exist in the market, then some consumers are likely to have previously tasted the product. Accordingly, the fuzzy memory of the taste experience and extrinsic cues will likely influence their purchase decision. Therefore, we believe that the experience of the favorite brand of wine is easy to recall, since perception relies on an interpretative ability to recognize and compare with previous sensory experiences, which, in turn, depend on social practices and an individual's personal history.

Ferrarini et al. (2010) have demonstrated that people are capable of identifying a circumscribed range of terms within the broader emotional lexicon that describe the emotional aspects elicited by wine. Therefore, since we measured the emotional attachment the respondents have to a wine brand, we asked them to evaluate all variables in relation to their favorite brand instead of giving them some brands. In fact, Mueller et al. (2010b), analyzing market shares and choices, have confirmed that extrinsic characteristics and product memories from previous consumption are very strong drivers for consumers' wine purchase.

First, respondents were asked to rate their wine expertise through a 15 item, seven-point scale (Kleiser and Mantel, 1994). Respondents were then asked to indicate the importance level of extrinsic and intrinsic attributes derived from the literature (Lockshin et al., 2006; MacDonald et al., 2013; Mueller and Szolnoki, 2010). The extrinsic attributes were brand, area of production, price, point of purchase (shop staff, atmosphere), bottle, label, medals, certifications, the producer and, finally, the producer's marketing actions (leaflets and/or brochures). The intrinsic attributes referred to the three senses: taste, sight and olfaction. In particular, the dimensions used were:

- sight: color intensity, color brightness and color shade;
- olfaction: frankness, intensity, delicacy, harmony balance;
- taste: body, aromatic persistency, aftertaste, acidity, mouth thickness, astringency.

The three senses were measured through self-reported questions covering different aspects in relation to the wine the respondent preferred.

Respondents were then asked to rate their emotional attachment to the brand of wine they usually purchase by using 7 seven-point scale items from Thomson et al. (2005). Lastly, they rated their wine experience in terms of familiarity, memorability and affection by using 3 seven-point scale items adapted from Murray (1991).

Finally, socio-demographic variables such as age, gender, income and nationality were also included to explain certain behaviors, along with respondents' preferences in terms of the type of wine (red, white, rosé) and their favorite brand of wine.

The questionnaire was submitted to a sample of specialized students enrolled in a Master degree program in tourism and wine marketing in Switzerland and a *sommelier* course in the South of Italy.



For the Italian sample, items were translated into Italian using an iterative approach (Douglas and Craig, 2007). Participants in the survey were highly involved wine consumers, having either high or low expertise. According to the literature (Coulter and Coulter, 2003), these consumers have a high level of preference insight, which means that they choose a product evaluating all its elements properly. Since they are able to accurately weigh the sensory enjoyment of wine tasting, they carefully evaluate, and are less driven by, extrinsic cues such as brands and promotions. Therefore, the type of respondents allowed us to be fairly confident on their recall of all the dimensions analyzed. A total of 748 respondents were asked to participate after being intercepted at the end of the classes. They were randomly assigned to the 2 purchase occasions, namely self-consumption and gift-giving. A total of 698 questionnaires were ultimately deemed usable since 50 of them had missing responses. Due to the locations where the interviews were conducted, the achieved sample is somewhat skewed in favor of younger people (64% of respondents being under 35), and somewhat balanced in terms of gender (M = 335, F = 363). In the section related to brand attachment, as the respondents were asked to think of their favorite brand of wine, they highlighted different brands, varying in brand reputation that goes from very well-known brands to unknown brands. The wines chosen covered a wide range of chemical and sensory properties (fruit intensity, oak flavor, astringency, sweetness, alcohol levels, etc.) and a wide range of extrinsic (non-sensory) characteristics, such as price points, label type, different vintages, brands and regions from all over Italy and France.

In terms of preferences, 65% of the respondents prefer red wine (28% primitivo, 33% negramaro, 22% aglianico, 17% merlot vine variety), 25% prefer white wine (38% pinot, 12% gewurtztraminer, 25% sauvignon blanc, 25% falanghina vine variety) and 10% rosé wine. In terms of price the wines chosen range from 9 Euros to 30 Euros, thus reducing the impact of price on their preferences. Six brands emerged as most preferred mainly from Italy and France.

The extrinsic factors that consumers consider when choosing wine have been factor analyzed with a Varimax rotation (see Table 1). The analysis highlighted 2 components: (1) 'Functionality', which groups elements related to the tangible and functional aspects of the wine, highlighting the importance of cognitive information that constitutes wine expertise; and (2) 'Point-Of-Purchase (POP)', which groups extrinsic attributes that highlight both the informational function of the point of purchase (i.e., through the shop staff,) and the experiential function (i.e., the atmosphere).

**Table 1. The Factor analysis results**

Component	
1	2
Functionality	POP

Label (aesthetic aspects)	.642	.297
Bottle (shape, color, weight, type of cap)	.689	.181
Producer	.700	.129
Area of production	.661	.169
Medals and Certifications	.557	.395
Location where the purchase takes place	.311	.725
Reliance in the shop assistant	.318	.620
Leaflets and/or brochures about the winemaker	.164	.717
Ease of matching with food	.389	.501
Price	.477	.385
Ambience	.085	.771

KMO = .914; Variance explained = 58.7%

The two components reflect the brand literature (e.g., Keller, 1993), which considers products as a bundle of product-related attributes. They are essentially defined as the components of the core product function sought by consumers, along with non-product-related ones, which are external to the function or process of the product offering.

To assess the effect of the product attributes and senses in relation to the two purchase occasions (gift-giving vs. self-consumption) and level of wine expertise (high vs. low), a two-way ANOVA was carried out. To test the effect of senses on wine experience, a structural equation model was run (see figure 2).

## RESULTS

To test H1a and H1b, a two-way ANOVA was carried out with wine experience as a dependent variable. All sensorial variables and wine experience were computed by calculating the mean of the items measured for each variable.

In both the purchase occasions, all variables were found to significantly affect wine experience: sight ( $F(1, 698) = 174.54, p < 0.001$ ), olfaction ( $F(1, 698) = 149.21, p < 0.001$ ), taste ( $F(1, 698) = 204.98, p < 0.001$ ), functionality ( $F(1, 698) = 216.69, p < 0.001$ ) and POP ( $F(1, 698) = 160.23, p < 0.001$ ).

The gift condition, in particular, shows that all variables have higher means than in self-consumption scenario (see Table 2), which confirms the gift function in self-expression that requires both cognitive and sensory dimensions. The former are activated in order to avoid the risks of a wrong choice that could negatively impact the image, and the latter reinforce the psychological and emotional meaning of a gift.

**Table 2. t-tests for gift-giving vs. self-consumption<sup>a</sup>**

	Taste	Sight	Olfaction	Functionality	POP
--	-------	-------	-----------	---------------	-----

	M	SD	M	SD	M	SD	M	SD	M	SD
Gift-giving	5.30	.86	5.33	.92	5.28	.92	5.39	.83	5.18	.87
Self-consumption	3.64	.89	3.61	1.10	3.68	1.08	3.60	1.16	3.63	.92
t-value	24.18		21.75		20.52		23.44		22.54	

<sup>a</sup>df = 698;  $p < 0.001$

The sensory dimensions affect wine experience rather than the extrinsic ones, confirming H1a.

Also, the level of expertise exhibits a significant effect on wine experience for all variables: sight ( $F(1, 698) = 20.99, p < 0.001$ ), olfaction ( $F(1, 698) = 35.63, p < 0.001$ ), taste ( $F(1, 698) = 51.65, p < 0.001$ ), Functionality ( $F(1, 698) = 23.48, p < 0.001$ ) and POP ( $F(1, 698) = 62.30, p < 0.001$ ). In particular, high-expertise consumers showed higher means for all the sensory and non-sensory variables (see Table 3); this means that the higher the expertise, the higher the consumer's consciousness of what is truly important when choosing a wine. Therefore, H1b is confirmed.

**Table 3. t-tests for high vs. low expertise**

	Taste		Sight		Olfaction		Functionality		POP	
	M	SD	M	SD	M	SD	M	SD	M	SD
Low expertise	3.68	1.03	3.72	1.19	3.71	1.15	3.65	1.25	3.65	.92
High expertise	5.08	.93	5.04	1.10	5.05	1.01	5.13	1.04	5.02	.99
t-value	-17.91		-14.35		-15.68		-16.36		-17.81	

<sup>a</sup>df = 698;  $p < 0.001$

Moreover, the interaction between the occasion and the expertise confirms the sensoriality of the wine experience. In fact, all variables were significant: sight ( $F(2, 698) = 30.84, p < 0.001$ ), olfaction ( $F(2, 698) = 23.17, p < 0.001$ ), taste ( $F(2, 698) = 36.40, p < 0.001$ ) and POP ( $F(2, 698) = 32.78, p < 0.001$ ) – except for Functionality ( $F(2, 698) = 2.59, p = .108$ ). High-expertise consumers show higher means in both the occasions, except for Sight in the self-consumption occasion, confirming that it is through the senses that these consumers experience wine, while the functional aspects basically provide cues that cognitively reinforce the choice (Table 4).

**Table 4. t-tests for high vs. low expertise and gift vs. self-consumption<sup>a</sup>**

		Taste		Sight		Olfaction		Functionality		POP	
		M	SD	M	SD	M	SD	M	SD	M	SD
Low expertise	Gift	4.31	1.86	4.40	1.75	4.34	1.82	4.82	1.59	4.17	1.27
	Self-consumption	3.59	.82	3.60	1.04	3.59	.98	3.44	1.08	3.55	.83
High expertise	Gift	5.47	.45	5.47	.65	5.43	.58	5.50	.62	5.38	.65
	Self-consumption	3.69	.86	3.49	1.05	3.70	1.06	3.78	1.14	3.75	.90

<sup>a</sup>df = 698;  $p < 0.001$

To test H2 and H3, a structural equation model (LISREL 8.80) has been run with the three senses (sight, olfaction and taste) as independent variables, wine experience as a dependent variable and brand attachment as a mediator (see Figure 2 and Table 5). In regards to the senses, it is assumed here that sight and olfaction are antecedents of taste. As for brand attached, 4 factors resulted significant.

The model has a good fit ( $\chi^2(164) = 260.44, p < .001$ ; CFI = .98; NNFI = .94; RMR = .104; GFI = .964; AGFI = .954; PGFI = .753; RMSEA = .029) and shows that the sensory effect is mostly driven by Taste, which

had a direct effect on Wine experience ( $\beta = .65$   $p < 0.001$ ). Sight ( $\beta = .25$   $p = .792$ ) and Olfaction ( $\beta = .71$   $p = .460$ ) are not found to have a significant effect on Taste. Therefore, H2 is confirmed.

Further, it is maintained that sensorial perceptions have an effect on extrinsic cues such as the brand that in turn acts as a mediator of the relationship with the wine experience. In fact, brand attachment turned out to be a mediator ( $\beta = .269$   $p < 0.001$ ), reinforcing emotionally the sensory features. Instead, cognitively the function of a brand, represented by elements such as the name of the producer and the region of origin, is displayed in the label.

Brand attachment is also affected by the purchase occasion ( $F(1, 698) = 516.79$ ,  $p < 0.001$ ), with a higher mean in gift purchases ( $M = 5.4$ ;  $SD = .82$ ) than in self-consumption ( $M = 3.64$ ;  $SD = 1.18$ ). This highlights the role of the brand in affecting the social aspect of wine. Therefore, H3 is confirmed.

**Figure 2: Standardized theoretical path coefficients**

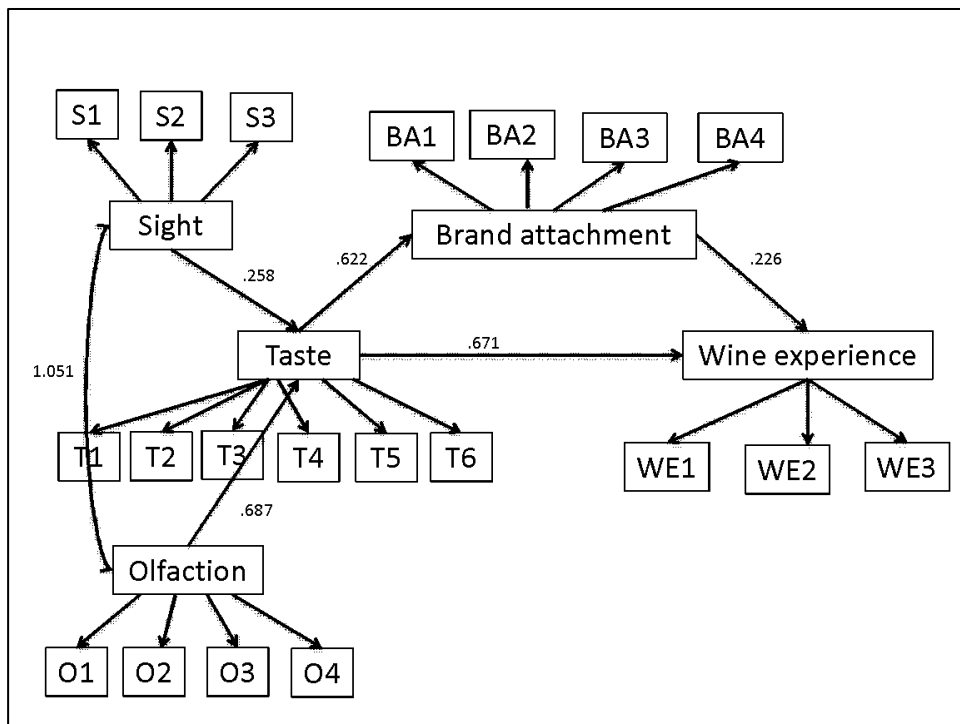

**Table 5 Path coefficients for the model in Figure 2**

Measure paths	Path	Structural paths	Path
---------------	------	------------------	------

	coefficients		coefficients
Wine experience		Wine experience	
Sight → Color intensity	.584***	Sight → Taste	.258
Sight → Color brightness	.615***	Olfaction → Taste	.687
Sight → Color shade	.609***	Taste → Brand attachment	.622***
Olfaction → Frankness	.590***	Brand attachment → Wine experience	.226***
Olfaction → Intensity	.606***	Taste → Wine experience	.671***
Olfaction → Delicacy	.625***		
Olfaction → Harmony balance	.615***	Sight ↔ Olfaction	1.051***
Taste → Aromatic persistency	.605***		
Taste → Body	.623***		
Taste → Aftertaste	.632***		
Taste → Acidity	.632***		
Taste → Astringency	.621***		
Taste → Mouth thickness	.598***		
Wine experience → Familiarity	.571***		
Wine experience → Memorability	.613***		
Wine experience → Nostalgia	.583***		
Brand attachment → Affectionate	.655***		
Brand attachment → Passionate	.690***		
Brand attachment → Connected	.671***		
Brand attachment → Attached	.727***		

**Notes:** All values are standardized; \*\*\* indicates p-value < .001

## DISCUSSION

The study shows that wine is a multisensory experience and that the combination of extrinsic and intrinsic cues contributes to wine experience. Consistently with a growing body of sensory consumer research (e.g., Biswas et al., 2014; Krishna and Schwarz, 2014; Meiselman, 2013; Spence, 2015), this paper highlighted that extrinsic product cues, such as branding, influence how consumers experience food and beverage products, in this case wine. This finding confirms the complexity and variety of factors that influence wine consumption (e.g., Hollebeek et al., 2007; MacDonald et al., 2013; Martinez et al., 2006; Siegrist and Cousin, 2009), thus highlighting the importance of simultaneous processing of extrinsic and intrinsic cues. In fact, despite the differences in the country of origin and demographics of wine consumers, taste is not the only factor that can influence consumer experience and needs to be supported and combined with other factors, whether or not sensory.

First, the findings demonstrate that the purchase situation affects wine experience. Congruent with the gift-giving literature, the social situations and the consequent use of wine affect how consumers proactively reinforce their self-perception when gift-giving, especially for the non-expert general public. This confirms the experiential nature of wine and its appeal to senses, also given by the respondents' preference for full body wine with a strong smell and strong taste (red wine from primitivo or aglianico vine variety), which encapsulate the pleasure of senses. The non-sensory components serve to reinforce the sensory nature of wine, cognitively supporting the experiential features.

Secondly, wine expertise helps in appreciating the wine in a sensory way, thus confirming previous studies on knowledge (Schaefer, 1997). A higher level of wine knowledge helps the consumer weigh relatively sophisticated product cues such as region, vintage or estate, while low-knowledge consumers predominantly rely on peripheral product cues such as medals and awards that may act as substitutes for product knowledge (Charters, 2004). Experts develop, through successive wine tasting, a somewhat different set of sensory concepts that do not include the personal idea of "liking" a wine. Experts' assessment tends to be based on a number of specialist parameters and criteria that are part of a collection of standards widely accepted in the reference community.

Moreover, the higher mean for the point of purchase in case of high expertise respondents can reflect a certain level of wine knowledge. Consumers might choose stores perceived as more functional by nature (e.g., supermarkets or grocery stores) to purchase wine for everyday consumption (i.e., self-consumption), while specialty stores might be more common for premium wines, a product considered to be more symbolic and/or hedonic (e.g., in case of gift).

Lastly, the findings demonstrate that brand is an important element in wine experience, representing a premium when consumers value their own preferences, especially in a gift-giving context. In fact, through brand attachment, sensory cues have a positive effect on wine experience, thus confirming the experiential nature of wine (Benfratello et al., 2009; Spence, 2012). Brand attachment summarizes the cognitive characteristics to the emotional features of wine. The combination of sensorial cues together with cognitive cues such as information on the bottle's label and design factors (i.e., imagery, color and layout), contribute to developing the attachment (Elliot and Barth, 2012). Since a wine brand is a layered or hierarchical concept, in which layers of brand elements interact (e.g., vintage, grape variety, region and country of origin), it represents a unique bundle of characteristics that only one, or very few, producers are able to combine to differentiate and create a distinctive experience. The importance of these elements also varies in relation to consumer knowledge and situational factors.

This paper also contributes to the growing sensory marketing literature by examining the effect of multiple senses on experience, demonstrating that senses acts through the brand even for products that need to be consumed in order to fully appreciate their qualities.

This paper is a first understanding of sensory branding in wine, analyzing how senses through brand attachment affect consumer experience. We are aware of the limitations of the approach chosen, which aims at obtaining an overall evaluation of wine experience in different aspects including brand attachment and sensory factors. Future research could therefore combine self-referential measurements of senses and experimental real settings involving taste. This approach would help to better understand the impact of remembered taste versus taste impression in a taste test on consumer purchase behavior. It should be also investigated whether differences in terms of expertise are more attributable to an acquired taste or to an innate ability. In addition, other measurements of brand effects (e.g., brand loyalty) and behavioral responses (e.g., purchase intention, willingness to pay a premium price) should be considered in the model. The wine quality could be included as a mediator of the relation between the cues and the brand. The findings could also be further validated by replication in other countries.

Further research on sensory branding could consider whether more specific aspects of the brand are differentially effective based on the recipient and a different type of product (e.g., a search product, which, being more utilitarian, would show a different experience outcome especially in gift giving situations).

## CONCLUSION

This paper looks at the role of functional and sensory cues in consumers' wine purchasing decisions. The relatively high complexity and perceived risk of a wine purchase give rise to a need for selecting an optimal mix of wine elements when creating marketing communications. These communication efforts should take both low- and high-knowledge consumers into account.

The wine industry is facing major changes, shifting from a production-oriented industry to a more marketing-oriented industry, while its agricultural roots and emphasis on product source remain unpredictable factors. From a managerial point of view, this study reinforces the necessity of a sound marketing strategy. It is important for practitioners to understand the interplay of sensory and non-sensory attributes as both dimensions have to be optimized for a product to be successful in the marketplace. The wine business needs to combine price competitiveness with experiential and sensorial strategies. Wine as a product is an experience of the brand, the lifestyle connotations that are associated with it and the region where the wine comes from. For wine brand trust or brand relationship factors are not sufficient for consumer repurchase. Consumers do not expect the wine to

be branded per se as a tool of engagement, but rather to engage them in cultural and geographical storytelling, using elements such as heritage and terroir, which convey a sense of authenticity. As consumers become increasingly exposed to a wider range of wines in retail outlets, wine producers need to build strategies to strengthen consumer loyalty for their brands. The appeal to senses must be matched to all components of a wine brand in order to connect with consumers and, ultimately, increase sales.

## REFERENCES

- Babin, B.J., Chebat, J.-C. and Michon, R. (2004), "Perceived appropriateness and its effect on quality, affect and behavior", *Journal of Retailing and Consumer Services*, Vol. 11 No 5, pp. 287–298.
- Babin, B.J., Darden, W.R. and Griffin, M. (1994), "Work and/or Fun: Measuring Hedonic and Utilitarian Shopping Value", *Journal of Consumer Research*, Vol. 20 No 4, pp. 644–656.
- Baskin, E., Wakslak, C.J., Trope, Y. and Novemsky, N. (2014), "Why Feasibility Matters More to Gift Receivers than to Givers: A Construal-Level Approach to Gift Giving", *Journal of Consumer Research*, Vol. 41 No 1, pp. 169–182.
- Batra, R. and Ahtola, O.T. (1991), "Measuring the hedonic and utilitarian sources of consumer attitudes", *Marketing Letters*, Vol. 2 No 2, pp. 159–170.
- Beatty, S.E., Kahle, L.R. and Homer, P. (1991), "Personal Values and Gift-Giving Behavior: A Study Across Cultures", *Journal of Business Research*, Vol. 22 No 2, pp. 149–157.
- Benfratello, L., Piacenza, M. and Sacchetto, S. (2009), "Taste or reputation: what drives market price in the wine industry? Estimation of a hedonic model for Italian premium wines", *Applied Economics*, Vol. 41 No 17, pp. 2197–2209.
- Biswas, D., Szocs, C., Krishna, A. and Lehmann, D.R. (2014), "Something to Chew On: The Effects of Oral Haptics on Mastication, Orosensory Perception, and Calorie Estimation", *Journal of Consumer Research*, Vol. 41 No 2, pp. 261–273.
- Brakus, J.J., Schmitt, B.H. and Zarantonello, L. (2009), "Brand Experience: What Is It? How Is It Measured? Does It Affect Loyalty?", *Journal of Marketing*, Vol. 73, pp. 52–68.
- Bredahl, L. (2003), "Cue utilisation and quality perception with regard to branded beef", *Food Quality and Preference*, Vol. 15 No 1, pp. 65–75.
- Bruwer, J. and Buller, C. (2012), "Country-of-origin (COO) brand preferences and associated knowledge levels of Japanese wine consumers", *Journal of Product & Brand Management*, Vol. 21 No 5, pp. 307–316.
- Bruwer, J., Saliba, A. and Miller, B. (2011), "Consumer behaviour and sensory preference differences: implications for wine product marketing", *Journal of Consumer Marketing*, Vol. 28 No 1, pp. 5–18.
- Camillo, A. (2012), "A strategic investigation of the determinants of wine consumption in China", *International Journal of Wine Business Research*, Vol. 24 No 1, pp. 68–92.
- Carbonell, L., Izquierdo, L., Carbonell, I. and Costell, E. (2008), "Segmentation of food consumers according to their correlations with sensory attributes projected on preference spaces", *Food Quality and Preference*, Vol. 19 No 1, pp. 71–78.
- Chebat, J.-C., Gélinas Chebat, C. and Vaillant, D. (2001), "Environmental Background Music and In-Store Selling", *Journal of Business Research*, Vol. 54 No 2, pp. 115–123.
- Chrea, C., Melo, L., Evans, G., Forde, C., Delahunty, C. and Cox, D.N. (2011), "An investigation using three approaches to understand the influence of extrinsic product cues on consumer behavior: An example of Australian wines", *Journal of Sensory Studies*, Vol. 26 No 1, pp. 13–24.
- Cohen, E. (2009), "Applying best-worst scaling to wine marketing", *International Journal of Wine Business Research*, Vol. 21 No 1, pp. 8–23.
- Combris, P., Bazoche, P., Giraud-Heraud, E. and Issanchou, S. (2009), "Food choices: What do we learn from combining sensory and economic experiments?", *Food Quality and Preference*, Vol. 20 No 8, pp. 550–557.
- Coulter, K.S. and Coulter, R.A. (2003), "The effect of industry knowledge on the development of trust in service relationships", *International Journal of Research in Marketing*, Vol. 20 No 1, pp. 31–43.



- Deroy, O., Crisinel, A.-S. and Spence, C. (2013), "Crossmodal correspondences between odors and contingent features: Odors, musical notes, and geometrical shapes", *Psychonomic Bulletin & Review*, Vol. 20 No 5, pp. 878-896.
- Ding, C.G. and Tseng, T.H. (2015), "On the relationships among brand experience, hedonic emotions, and brand equity", *European Journal of Marketing*, Vol. 49 No 7/8, pp. 994-1015.
- Doty, R.L. (2015), *Handbook of olfaction and gustation*, Wiley-Blackwell, Hoboken, NJ.
- Douglas, S.P. and Craig, C.S. (2007), "Collaborative and Iterative Translation: An Alternative Approach to Back Translation", *Journal of International Marketing*, Vol. 15 No 1, pp. 30-43.
- Elder, R.S. and Krishna, A. (2010), "The Effects of Advertising Copy on Sensory Thoughts and Perceived Taste", *Journal of Consumer Research*, Vol. 36 No 5, pp. 748-756.
- Elliot, S. and Barth, J.E. (2012), "Wine label design and personality preferences of millennials", *Journal of Product & Brand Management*, Vol. 21 No 3, pp. 183-191.
- Enneking, U., Neumann, C. and Henneberg, S. (2007), "How important intrinsic and extrinsic product attributes affect purchase decision", *Food Quality and Preference*, Vol. 18 No 1, pp. 133-138.
- Erdem, T., Swait, J., Broniarczyk, S., Chakravarti, D., Kapferer, J., Keane, M., Roberts, J., Steenkamp, J.E.M. and Zettelmeyer, F. (1999), "Brand equity, consumer learning, and choice", *Marketing Letters*, Vol. 10 No 3, pp. 301-318.
- Fennell, G. (1978), "Consumers' Perception of the Product - Use Situation", *Journal of Marketing*, Vol. 32, pp. 30-35.
- Ferrarini, R., Carbognin, C., Casarotti, E.M., Nicolis, E., Nencini, A. and Meneghini, A.M. (2010), "The emotional response to wine consumption", *Food Quality and Preference*, Vol. 21 No 7, pp. 720-725
- Fitzgerald Bone, P. and Jantrania, S. (1992), "Olfaction as a cue for product quality", *Marketing Letters*, Vol. 3 No 3, pp. 289-296.
- Garber, L.L., Hyatt, E.M. and Starr, R.G. (2000), "The Effects of Food Color on Perceived Flavor", *Journal of Marketing Theory and Practice*, Vol. 8 No 4, pp. 59-71.
- Garcia-Retamero, R. and Galesic, M. (2012), "Doc, What Would You Do If You Were Me? On Self-Other Discrepancies in Medical Decision Making", *Journal of Experimental Psychology: Applied*, Vol. 18, pp. 38-51.
- Gino, F. and Flynn, F.J. (2011), "Give Them What They Want: The Benefits of Explicitness in Gift Exchange", *Journal of Experimental Social Psychology*, Vol. 47 No 5, pp. 915-922.
- Gracia, A., Loureiro, M.L. and Nayga, R.M. (2009), "Consumers' valuation of nutritional information: A choice experiment study", *Food Quality and Preference*, Vol. 20 No 7, pp. 463-471.
- Grunert, K.G. (2003), "Purchase and consumption: The interdisciplinary nature of analysing food choice", *Food Quality and Preference*, Vol. 14 No 1, pp. 39-40.
- Hoegg, J. and Alba, J.W. (2007), "Taste Perception: More than Meets the Tongue", *Journal of Consumer Research*, Vol. 33 No 4, pp. 490-498.
- Hollebeek, L.D., Jaeger, S.R., Brodie, R.J. and Balemi, A. (2007), "The influence of involvement on purchase intention for new world wine", *Food Quality and Preference*, Vol. 18 No 8, pp. 1033-1049.
- Hurling, R. and Shepherd, R. (2003), "Eating with your eyes: effect of appearance on expectations of liking", *Appetite*, Vol. 41 No 2, pp. 167-174.
- Hussain, M., Cholette, S. and Castaldi, R. (2007), "Determinants of wine consumption of US consumers: an econometric analysis", *International Journal of Wine Business Research*, Vol. 19 No 1, pp. 49-62.
- Jaeger, S.R. and Rose, J.M. (2008), "Stated choice experimentation, contextual influences and food choice: A case study", *Food Quality and Preference*, Vol. 19 No 6, pp. 539-564.
- Jaeger, S.R., Danaher, P.J. and Brodie, R.J. (2009), "Wine purchase decisions and consumption behaviours: Insights from a probability sample drawn in Auckland, New Zealand", *Food Quality and Preference*, Vol. 20 No 4, pp. 312-319.
- Jover, A.J.V., Montes, F.J.L. and Fuentes, M.D.F. (2004), "Measuring perceptions of quality in food products: The case of red wine", *Food Quality and Preference*, Vol. 15 No 5, pp. 453-469.
- Kardes, F.R., Cronley, M.L., Kellaris, J.J. and Posavac, S.S. (2004), "The role of selective information processing in price-quality inference", *Journal of Consumer Research*, Vol. 31 No 2, pp. 368-374.
- Keller, K.L. (1993), "Conceptualizing, measuring, and managing customer-based brand equity", *Journal of Marketing*, Vol. 57, pp. 1-22.
- Kleiser, S.B. and Mantel, S.P. (1994), "The dimensions of consumer expertise: A scale development", in *American Marketing Association Summer Educators' proceedings*, Vol. 5, pp. 20-26.
- Krishna, A. (2010), *Sensory Marketing: research on the sensuality of products*, Taylor and Francis Group, New York, NY.

- Krishna, A. (2012), "An integrative review of sensory marketing: Engaging the senses to affect perception, judgment and behavior", *Journal of Consumer Psychology*, Vol. 22 No 3, pp. 332-351.
- Krishna, A. and Schwarz, N. (2014), "Sensory marketing, embodiment, and grounded cognition: A review and introduction", *Journal of Consumer Psychology*, Vol. 24 No 2, pp. 159-168.
- Lange, C., Issanchou, S. and Combris, P. (2000), "Expected versus experienced quality: Trade-off with price", *Food Quality and Preference*, Vol. 11 No 4, pp. 289-297.
- Laran, J. (2010), "Goal Management in Sequential Choices: Consumer Choices for Others Are More Indulgent than Personal Choices", *Journal of Consumer Research*, Vol. 37 No 2, pp. 304-314.
- Lee, S.-J. and Lee, K.-G. (2008), "Understanding consumer preferences for rice wines using sensory data", *Journal of the Science of Food and Agriculture*, Vol. 88 No 4, pp. 690-698.
- Lindstrom, M. (2005), "Broad sensory branding", *Journal of Product and Brand Management*, Vol. 14 No 2, pp. 84-87.
- Lockshin, L., Jarvis, W., d'Hauteville, F. and Perrouy, J.P. (2006), "Using simulations from discrete choice experiments to measure consumer sensitivity to brand, region, price, and awards in wine choice", *Food Quality and Preference*, Vol. 17 No 3/4, pp. 166-178.
- MacDonald, J.B., Saliba, A.J. and Bruwer, J. (2013), "Wine choice and drivers of consumption explored in relation to generational cohorts and methodology", *Journal of Retailing and Consumer Services*, Vol. 20 No 3, pp. 349-357.
- Martinez, L.M.C., Molla-Bauza, M.B., Gomis, F.J.D. and Poveda, A.M. (2006), "Influence of purchase place and consumption frequency over quality wine preferences", *Food Quality and Preference*, Vol. 17 No 5, pp. 315-327.
- Mattila, A.S. and Wirtz, J. (2001), "Congruency of scent and music as a driver of in-store evaluations and behavior", *Journal of Retailing*, Vol. 77, pp. 289-293.
- Meiselman, H.L. (2013), "The future in sensory/consumer research: evolving to a better science", *Food Quality and Preference*, Vol. 27 No 2, pp. 208-214.
- Melo, L., Delahunty, C., Forde, C. and Cox, D.N. (2010), "Development and validation of a tool to recall alcohol and wine consumption over consumers' lifetimes", *Food Quality and Preference*, Vol. 21 No 7, pp. 697-704.
- Menichelli, E., Olsen, N.V., Meyer, C. and Naes, T. (2012), "Combining extrinsic and intrinsic information in consumer acceptance studies", *Food Quality and Preference*, Vol. 23, pp. 148-159.
- Mueller, S., Francis, I.L. and Lockshin, L. (2009), "Comparison of best-worst and hedonic scaling for the measurement of consumer wine preferences", *Australian Journal of Grape and Wine Research*, Vol. 15 No 3, pp. 205-215.
- Mueller, N., Lockshin, L. and Louviere, J.J. (2010a), "What you see may not be what you get: Asking consumers what matters may not reflect what they choose", *Marketing Letters*, Vol. 21 No 7, pp. 335-350.
- Mueller, S., Osidacz, P., Francis, I.L. and Lockshin, L. (2010b), "Combining discrete choice and informed sensory testing in a two-stage process: Can it predict wine market share?", *Food Quality and Preference*, Vol. 21 No 7, pp. 741-754.
- Mueller, S. and Szolnoki, G. (2010), "The relative influence of packaging, labelling, branding and sensory attributes on liking and purchase intent: Consumers differ in their responsiveness", *Food Quality and Preference*, Vol. 21 No 7, pp. 774-783.
- Murray, K.B. (1991), "A Test of Services Marketing Theory: Consumer Information Acquisition Activities", *Journal of Marketing*, Vol. 55, pp. 10-25.
- Olsen, J.E., Thompson, K.J. and Clarke, T.K. (2003), "Consumer self-confidence in wine purchases", *International Journal of Wine Marketing*, Vol. 15 No 3, pp. 40-51.
- Olson, J.C. (1977), "Price as an Informational Cue: Effects on Product Evaluations", in Woodside, A.G., Sheth, J.N. and Bennett, P.D. (Eds.), *Consumer and Industrial Buying Behavior*. North Holland, New York, NY, pp. 267-286.
- Olson, J.C. and Jacoby, J. (1972), "Cue utilization in the quality perception process", *Advances in Consumer Research*, Vol. 3, pp. 167-179.
- Otnes, C., Lowrey, T. and Kim, Y.C. (1993), "Gift Selection for Easy and Difficult Recipients: A Social Roles Interpretation", *Journal of Consumer Research*, Vol. 20 No 2, pp. 229-244.
- Park, C.W., MacInnis, D.J. and Priester, J. (2008), "Brand Attachment: Constructs, Consequences, and Causes", *Foundations and Trends in Marketing*, Vol. 1 No 3, pp. 191-230.
- Perrouy, J.P., d'Hauteville, F. and Lockshin, L. (2006), "The influence of wine attributes on region of origin equity: an analysis of the moderating effect of consumers' perceived expertise", *Agribusiness*, Vol. 22 No 3, pp. 323-341.
- Phau, I. and Suntornnond, V. (2006), "Dimensions of consumer knowledge and its impacts on country of origin effects among Australian consumers: a case of fast-consuming product", *Journal of Consumer Marketing*, Vol. 23 No 1, pp. 34-42.

- Polman, E. and Emich, K.J. (2011), "Decisions for Others Are More Creative than Decisions for the Self", *Personality and Social Psychology Bulletin*, Vol. 37, pp. 492–501.
- Priilaid, D.A. (2006), "Wine's placebo effect: How the extrinsic cues of visual assessments mask the intrinsic quality of South African red wine", *International Journal of Wine Marketing*, Vol. 18 No 1, pp. 17–32.
- Raz, C., Piper, D., Haller, R., Nicod, H., Dusart, N. and Giboreau, A. (2008), "From sensory marketing to sensory design: How to drive formulation using consumers' input?", *Food Quality and Preference*, Vol. 19 No 8, pp. 719–726.
- Ritchie, C. (2007), "Beyond drinking: the role of wine in the life of the UK consumer", *International Journal of Consumer Studies*, Vol. 31 No 5, pp. 534–540.
- Rolls, E.T. (2005), "Taste, Olfactory, and Food Texture Processing in the Brain and the Control of Food Intake", *Physiology and Behavior*, Vol. 85, pp. 45–56.
- Schaefer, A. (1997), "Consumer knowledge and country of origin effects", *European Journal of Marketing*, Vol. 31 No 1, pp. 56–72.
- Schiefer, J. and Fischer, C. (2008), "The gap between wine expert ratings and consumer preferences: Measures, determinants and marketing implications", *International Journal of Wine Business Research*, Vol. 20 No 4, pp. 335–351.
- Schifferstein, H.N.J. and Spence, C. (2008), "Multisensory product experience", in: Schifferstein, H.N.J. and Hekkert, P. (Eds.), *Product experience*, Elsevier, Amsterdam, pp. 133–161.
- Semenou, M. (2007), "Preference study using a latent class approach. Analysis of European preferences for smoked salmon", *Food Quality and Preference*, Vol. 18 No 5, pp. 720–728.
- Siegrist, M. and Cousin, M.E. (2009), "Expectations influence sensory experience in a wine tasting", *Appetite*, Vol. 52 No 3, pp. 762–765.
- Small, D.M. and Prescott, J. (2005), "Odor/Taste Integration and the Perception of Flavor", *Experimental Brain Research*, Vol. 166 No 3–4, pp. 345–357.
- Spence, C. (2012), "Managing sensory expectations concerning products and brands: Capitalizing on the potential of sound and shape symbolism", *Journal of Consumer Psychology*, Vol. 22 No 1, pp. 37–54.
- Spence, C. (2015), "Multisensory Flavor Perception", *Cell*, Vol. 161 No 1, pp. 151–158.
- Spence, C. and Piqueras-Fiszman, B. (2014), "The perfect meal: The multisensory science of food and dining", Wiley-Blackwell, Oxford.
- Srinivasan, N., Jain, S.C. and Sikand, K. (2004), "An experimental study of two dimensions of country-of-origin (manufacturing country and branding country) using intrinsic and extrinsic cues", *International Business Review*, Vol. 13 No 1, pp. 65–82.
- Stefani, G., Romano, D. and Cavicchi, A. (2006), "Consumer expectations, liking and willingness to pay for specialty foods: Do sensory characteristics tell the whole story?", *Food Quality and Preference*, Vol. 17 No 1–2, pp. 53–62.
- Steffel, M. and Le Boeuf, R.A. (2014), "Overindividuation in Gift Giving: Shopping for Multiple Recipients Leads Givers to Choose Unique but Less Preferred Gifts", *Journal of Consumer Research*, Vol. 40 No 6, pp. 1167–1180.
- Thach, E.C. and Olsen, J.E. (2006), "Market segment analysis to target young adult wine drinkers", *Agribusiness*, Vol. 22 No 3, pp. 307–322.
- Thach, L. (2012), "Time for wine? Identifying differences in wine-drinking occasions for male and female wine consumers", *Journal of Wine Research*, Vol. 23 No 2, pp. 134–154.
- Thomson, M., MacInnis, D.J. and Park, C.W. (2005), "The Ties That Bind: Measuring the Strength of Consumers' Emotional Attachments to Brands", *Journal of Consumer Psychology*, Vol. 15 No 1, pp. 77–91.
- Veale, R. and Quester, P. (2008), "Consumer sensory evaluation of wine quality: The respective influence of price and country of origin", *Journal of Economics*, Vol. 3 No 1, pp. 10–29.
- Ward, M.K. and Broniarczyk, S.M. (2011), "It's Not Me, It's You: How Gift Giving Creates Giver Identity Threat as a Function of Social Closeness", *Journal of Consumer Research*, Vol. 38 No 1, pp. 164–181.
- Yang, S., Allenby, G.M. and Fennell, G. (2002), "Modeling Variation in Brand Preference: The Roles of Objective Environment and Motivating", *Marketing Science*, Vol. 21 No 1, pp. 14–31.
- Zajonc, R.B. and Markus, H. (1982), "Affective and cognitive factors in preferences", *Journal of Consumer Research*, Vol. 9 No 2, pp. 123–131.
- Zandstra, E.H. (2006), "Creating memorable products: Actual liking and remembered liking", *Food Quality and Preference*, Vol. 17 No 7–8, pp. 2–3.
- Zeithaml, V.A. (1988), "Consumer Perceptions of Price, Quality, and Value: A Means-End Model and Synthesis of Evidence", *Journal of Marketing*, Vol. 52, pp. 2–22.



## A SOUTH AFRICAN INDUSTRY PERCEPTIVE ON MODERN TRANSIT ADVERTISING MEDIA OPPORTUNITIES

Roux, Thérèse

Department of Marketing, Logistics and Sport Management, TUT, Pretoria, South Africa

### ABSTRACT

The evolution of the transportation systems in South Africa offers a whole range of novel advertising opportunities; however, practitioners' perspectives on planning this Out-of-home advertising platform remain unknown. This study is one of the first to explore practitioners' perspective on transit advertising media in an emerging context and contributes to the limited theory on OOH advertising and media planning. Using qualitative interviews, this study detailed themes concerning media professionals' evaluation of transit advertising media in a developing context. The feedback of these experts was used to ascertain the key strengths and limitations of transit advertising media. The practical as well as academic implications of findings were also presented.

*Keywords: media planning, out-of-home advertising, transit advertising media, South Africa*

### INTRODUCTION

Gustavo Petro, the mayor of Bogota, Columbia, is well known for his contribution to transportation systems in developing countries and the quote: "A developed country is not a place where the poor have cars. It's where the rich use public transportation." Consider for a moment, some of the finest cities across the globe - London, Paris, New York, Dubai, Singapore, and Mumbai. The majority of the populations in these cities travel via massive first-world public transport networks of trains, trams and buses. This trend has only lately expanded to some developed countries (Subramania, 2016). In South Africa, recent infrastructural developments, such as the new transportation hubs, new airports, taxi-rank upgrading, SARCC (the South African Rail Commuter Corporation) integration, the new upmarket Gautrain, the Bus Rapid Transport (BRT) system, resulted in a far wider range of Out-of-home (OOH) advertising media opportunities (Du Preez, 2015).

OOH advertising in South Africa can be classified in four major platforms based on their reach in different environments: outdoor advertising aimed at vehicular traffic; transit advertising aimed at commuters; street-and-retail furniture advertising for pedestrians and shoppers; and alternative OOH advertising targeting exact audience profiles where particular groups congregate for a specific purpose (Roux *et al.*, 2013). This article offers an industry perspective on planning one of these OOH advertising

platforms; transit advertising media. OOH and transit advertising media are expanding across the globe. The global OOH advertising expenditure of \$7.6 billion is driven primarily by digital OOH in the transit environments (GIA, 2015). Globally transit advertising is the fastest growing OOH platform at 7% (Magna Global, 2016). It is also expanding in African markets due to the formalization of transit environments (Du Preez, 2015). Most commuters in these markets are reliant on the minibus taxi- and bus industry for their daily travel. This in turn generates a captive audience for brands to effectively reach these economically active consumers. It is evident that there are prospects for small and large businesses to use transit advertising to engage and reinforce their advertising messages – and even to entertain commuters in this new media landscape.

## THE PROBLEM INVESTIGATED

No empirical study on how media practitioners evaluate modern transit advertising media platforms in a developing context could be found. Research in developed markets predominantly concentrated on consumers' responses to traditional outdoor advertising boards (Donthu *et al.*, 1993; Wilson & Till, 2011; Wilson *et al.*, 2015), as well as digital advertising signage (Roggeveen, *et al.* 2016). Consumers' contact with outdoor advertising messages for potential harmful foods or alcoholic beverages are often the focus in developing countries (De Bruijin, *et al.* 2014). However very limited studies on transit advertising have been conducted; with the exception of a few such as commuters in Hong Kong perceptions on exterior-bus advertising (Prendergast & Hang, 1999) and subway advertising (Chan & Fung, 2013); airport advertising in New York (Wilson & Till, 2008) and taxi-cab advertising in Scotland, UK (Veloutsou & O'Donnell, 2005). There still remains a serious paucity of academic literature on the practices of transit advertising media sector, even more so in an emerging market context, such as South Africa.

In the light of this insufficiency, the objective of this article to explore how experienced media experts evaluate transit advertising media when planning campaigns within South Africa. The contribution of this study is practical as well as academic. From a practical perspective, the findings can assist marketers and businesses in understanding transit advertising, in order to make use of this innovative OOH advertising media platform effectively for their advertising purposes. Despite the growing potential and opportunities there is still a lack of understanding of the value of this platform for businesses. The planning of advertising media followed by the nature and scope of transit advertising media will be reviewed in the following sections. This will be followed by the research methods and insight obtained from the in-depth interviews with advertising media professionals. Finally, the managerial implications and suggestions for future research are presented.

## ADVERTISING MEDIA PLANNING

Advertising media planning is the most crucial function to achieve the advertising objective of reaching the target market (Koekemoer; 2010). Numerous academic sources acknowledge the complexity and significance of advertising media planning within the overall marketing strategy (Barker, 2014; Lane *et al.*, 2011). It is a critical area of research because companies invest millions on advertising and promotional campaigns to persuade and engage; driving participation, facilitation, and conversation to build relationships. Furthermore the digitization of media channels, proliferation of media options and increase in customer touch points has driven a intense fragmentation of target audiences, and continues to complicate the advertising media planning process of setting the media strategy and selecting the media options through which to deliver effective communications (Barker, 2014).

The current article is focused on advertising media planning, a specialist subset within marketing communication based around the selection of communication platforms used to transfer the organisations' marketing messaging to their desired audience (Barker, 2014). Advertising media planning refers to the decision made to deliver advertising messages to the appropriate people, the right number of times, in the right environment at minimum cost to achieve the advertised brand's marketing communication objectives (Koekemoer, 2010). A media plan refers to the complete analysis and execution of the media component of an advertising plan (Lane *et al.* 2011). No two media plans would be exactly the same, since it depends on the advertiser or the product, the objective to be achieved and the media planner or agency. At the crux of advertising media planning is the selection or evaluation of the best medium or combination of media to obtain the marketing communication-and-media objectives. The focus of the current study is on the evaluation of transit advertising media by experienced media experts in South Africa.

When selecting advertising media, the following factors should be considered: The ability of the media to communicate the brand or product the most effectively, the media objective (such as the reach and frequency required and the cost involved); the size, type and media habits of the target audience; the unique characteristics of each medium, and the nature of the product or service to be advertised (Sissors & Baron 2010; Lane *et al.* 2011) An important principle in media selection is "Media Neutral Planning" (MNP), where each medium is treated as potentially appropriate, depending on the specific marketing objectives. This requires the "consideration of, and expertise in all media channels", including transit advertising (Tapp, 2005). Media neutral planning, therefore, requires an in-depth understanding of all the available transit advertising media types and their unique characteristics.

Advertising media can be evaluated based on objective criteria and subjective media values when planning campaigns. Objective media considerations such as the level of media exposure, frequencies and cost indicate the ability of the different media options to reach a target audience at the right time,

place and cost (Koekemoer, 2010). Quantitative media considerations such as the level of media exposure, frequencies and cost indicate the ability of the different media options to reach a target audience at the right time, place and cost. The media exposure and frequency delivered in an OOH campaign depends on the location and features of media types as well as the creative message (Donthu et al., 1993; Wilson & Till; 2008). Subjective media values refer to how and which subjective media-context variables influence the effects of the advertisements embedded in that context (Bronner & Neijens 2006; Belch & Belch, 2015). The qualitative values of OOH advertising media have only recently been explored in empirical research, despite the fact that global companies are increasingly relying on these values to promote the image of their brands in international as well as developed countries (Wilson & Till, 2011; World Outdoor Advertising News, 2012; Ju & Chung, 2016).

## **TRANSIT ADVERTISING MEDIA**

The Outdoor Association of America (OAAA) defines transit advertising as “advertising displays affixed to moving vehicles or positioned in the common areas of transit stations, terminals and airports” (OAAA, 2015). Transit advertising thus consists of moving transit advertising media affixed to the outside or inside of moving vehicles as well as static advertising boards located in the common areas of train stations, taxi ranks, bus terminals and airports.

Some scholars examined commuters’ responses to moving transit advertising media affixed to moving vehicles (Chan & Fung, 2013; Veloutsou & O’Donnell, 2005), while others studied the noting and recall of static transit advertising (Wilson & Till, 2008). Veloutsou and O’Donnell (2005) conducted exploratory research in three areas in Scotland, on the overall attitudes and feelings towards advertising, outdoor advertising and taxi advertising from the perspective of the taxi commuters. They warned that there is more to the effectiveness of an advertising medium than the respondent’s ability to recall the advertisement – and the subsequent short-term sales increase. Therefore, target audiences’ attitudes and perceptions towards the medium and advertising also need to be taken into consideration when determining the effectiveness of an advertising medium. They found significant differences in exposure to taxi cab advertising between the different groups surveyed. For example higher exposure was measured for those from living in the city compare to those living in smaller towns, where taxi advertising is relatively new or not used as often. This suggests that specific types of transit advertising can be very successful for geographic selectivity to target different audience groups, however not all types might be equally effective or available across geographical areas.

Other studies also confirmed the ability of certain transit advertising types to target narrowly defined audiences. Wilson and Till (2008) suggest that airport advertising media are effective for narrowly defined customers audiences that coincide with airport passengers’ profiles such as businessmen. The



findings also showed that the size and shapes of the advertising medium, the themes used in the messages, as well the number of words in the copy, influenced the recall and recognition levels. The findings iterated the importance of the “less is more” principle of using a simple message with fewer words, rather than longer and more complex copy for effective advertising messages in the transit environment. This creative limitation in terms of the design is a potential disadvantage (Belch & Belch, 2015). The findings also suggest that placing advertisements on unusual or unique media vehicles and the use of context- related themes (such as destinations, or airport-related themes for airport media) in the message increase the level of processing of information by a audience in transit.

Prendergast and Hang (2008) examined the recall of exterior bus advertising in Hong Kong. They found that the exposure to and recall of exterior bus advertisements is relatively high due to long time spend by commuters waiting for busses in this geographical area. This type of public transit adverting is thus able to deliver reach to a wide captive audience. However message wear-out was also reported due to repetitive exposure. It was also found Hong Kong consumers are generally less opposed to tobacco and liquor advertising on the exterior of buses compared to developing countries. Exterior bus advertising was found to be more effective if consumers were highly involved with the products/services being advertised, and if consumers had positive attitudes towards advertising in general.

The nature of public transit in South Africa is fairly different in comparison to that in the Western developed countries. South Africans spend on daily far more time commuting to work, compared developed countries (World Bank in PMG, 2014). Public transport users in South Africans earn less than those in developed countries (StatsSa, 2013). Minibus taxis, are used as transport by the majority of the South African population (18 million people); and it accounts for 69% of public transport in the country (StatsSA, 2013). The commuters are typically lower income workers (26,5%); and key decision-makers in household purchases (OMD South Africa, 2013). Commuters using taxicabs in developed markets are part of the higher-income segment of the market; and they are transporting only a few passengers at a time (Veloutsou & O'Donnell, 2005; Wilson & Till, 2008).

## **STUDY DESIGN AND PROCEDURE**

In-depth interviews with 16 transit advertising media specialists in South Africa were conducted to understand how they apply objective criteria and subjective values when planning transit advertising media in a South African context. Qualitative research was deemed to be appropriate as it allows for the in-depth understanding of participants' perspectives in their own words (Patton, 2005). Purposive sampling was applied to select specialists in prominent media agencies and transit media providers across South Africa. The membership lists of Advertising Media Association of South Africa (AMASA)

and Out of Home Media South Africa (OHMSA) were used to identify organizations that met the following criteria: 20 or more employees, 10 million rand (764 619 USD) or more in revenue, experienced in transit advertising media, and within reasonable distance from the researcher. The size and distance prerequisites allowed the researcher to conduct in-depth interviews with these specialists in their own space, which facilitated the building of rapport. Twenty-two organizations met these criteria. The highest-ranking manager at each organization was contacted and briefed on the purpose of this research. They advised the researcher on the most suitable person in their company to participate in the study. Of these, ten participants with extensive experience in transit advertising media were interviewed for this study.

The interviews moved from general to specific questions to provide context for each participants' answers and allow the conversation to develop based on the point of view of the participants (Morrison *et al.* 2011). To develop a rapport, participants were first asked about their experience in the media industry. They were then asked some general questions about how they employ quantitative criteria and qualitative values when planning transit advertising media campaigns. Each question used laddering to further probe perceptions and media practices (Reynolds & Gutman 1988). Participants were also requested whether they had any additional ideas on the topic to share before the interview was concluded.

The framework approach was used to analyze the data (Gale, 2013; Ritchie & Spencer, 2002). Firstly, all the interviews were digitally recorded and transcribed verbatim. This was followed by familiarization with the data and construction of a thematic framework drawing upon priori literature- and emerging issues from the data. Then indexing by applying the thematic framework and abstraction to synthesize were conducted.

The last phase of data analysis involved finding of thematic patterns and interpretation of the data as a whole to address the research purpose. Guba's four criteria to ensure trustworthiness (Lincoln & Guba, 1985) were considered for this study. The strategies as suggested by Shenton (2004) were implemented to meet these criteria. Sufficient understanding and thorough review of the literature to conceptualize and frame the findings ensured credibility or validity of the findings and conclusions. Transferability is concerned with the applicability of the findings to all relevant contexts. Detailed descriptions of the research design and methodology, as well as rich and solid descriptions of the data analysis were provided to satisfy the concerns for transferability. Confirmability or neutrality of the findings was ensured by discussions between the researcher and key experts to reduce potential bias. An accurate and detailed record on how the study was approached and conducted, including how the data were collected and analysed also contributed in this regard.

## FINDINGS

Several potential approaches can be followed to structure or report on qualitative findings, including chronology, life-history, themes, composites, critical events, zoom lens and portraits (Patton, 2005). For this article, the conceptual networks with meaningful themes that emerged from the data analyses were used to report the findings. A schematic overview of the related themes that encapsulate the overall findings of this study can be seen in Figure 1.

Target Audience exposure	Frequency & Reach	Relative cost
<ul style="list-style-type: none"> <li>•Selectivity</li> <li>•Increasing non-exclusivity of airport media</li> </ul>	<ul style="list-style-type: none"> <li>•Exceptionally high levels of frequency and reach</li> <li>•Low unit cost on mass public transport</li> </ul>	<ul style="list-style-type: none"> <li>•Low unit cost on mass public transport</li> <li>•Expensive up-market transit media</li> </ul>

Figure 5. Major themes and related themes

In the following sections, the discussion of the insights obtained from the qualitative analysis of the interviews will be done, according to three themes: Target audience exposure; Frequency and reach, and relative cost. Verbatim quotations of participants are indicated with quotation marks and identified by the number of the participant. For example P1 means participant 1, and P2 refers to participant 2. In the case where words were added to the verbatim quotations to enhance the understanding, it was indicated by putting the inserted words in parenthesis: (...).

### Theme 1: Target audience exposure

The participants revealed that there are various types of transit advertising options that can be employed in an campaign, to target different commuter profiles with different levels of disposable income, who typically make use of different modes of public transport in South Africa: *“These offer the opportunity to be seen by high volumes of people of specific demographic and/or income groups.”* (P3). Consumers in low-income and middle-income groups are typically reached by advertising on buses, minibus taxis and metro-trains: *“Transit is usually when you are talking to your mass market, then you brand an entire taxi or brand a taxi rank or buses. It is great because so many people are using this transport... So typically you would use your transit for the low and medium LSM groups”* (P6).

Transmit media opportunities catering for high income groups are expanding. Until recently advertising at airports was the only option for businesses targeting high-income travellers. As one participant noted: *“airport media is the class of transit media that reach higher income and business people”* (P4). However, it seems that there has been a shift from the past, where transit media were mainly suitable to reach the mass market by minibus taxis or metro train advertising to targeting higher LSM groups. As one participant noted: *“the improvements in the public transport lead to new opportunities”*; and

confirmed that *“you will get more people (advertisers) involved in the transit media”* (P1). A number of recently introduced upmarket transit advertising opportunities for businesses to reach higher-income commuters using media options were highlighted by the specialists, such as: *“... opportunities for branding of metered cabs, not only on the outside, but inside as well”* (P9); *“the light boxes, Gauframes and digital platforms at all the Gautrain stations,”* (P5); *“Bus networks like Cape Town’s MyCiti and Rea Vaya in the Johannesburg”* (P8).

Private car branding was another innovative opportunity revealed, where car owners’ lifestyles are matched with the target market of the product or service being advertised. The participants gave several examples illustrating highly targeted campaigns. *“You give them your details and then the marketer will say he’s trying to reach people at gyms; so, therefore they will go into the database and see who are the active healthy type and goes to which gym”* (P6). *“Branding of selected fleets of private vehicles based on your target market criteria is also an option. We can combine it with brand ambassadors to distribute samples or flyers.”* (P13)

## **Theme 2: Frequency and reach**

Major strengths of transit advertising media identified in the findings are the ability to deliver exceptionally high levels of frequency, together with specific reach, because of the commuters’ habitual travel, as well as the specific routes of the transport modes in the area. A number of the participants corroborated this. One explained that *“it’s a good format for frequency and reach; since, because of the mobile nature of that, it is specifically handy in areas where billboard availability is limited”* (P10). Others explained, *“this flexible medium is good to target hard-to-reach target areas.”* (P7) *“Each vehicle is chosen for routes within the advertiser’s market; Locally or regionally or nationally within South Africa”* (P11). Public transit advertising and minibus taxi advertising media are usually employed to reach the mass market travelling back and forth to major metropolitan areas on a daily basis. The participants believed that this offers businesses the opportunity to expose a captive audience to their message several times during the course of a day. One participant explicated, *“transit is usually when you are talking to your mass market, then you brand an entire taxi or brand, a taxi rank, or buses. It is great, because so many people are using this transport”* (P6). Another reiterated the potential of mobile transit media to deliver high and repetitive audience reach and exposure. *“Busses are like moving billboards with the ability to penetrate areas where other forms of OOH media are restricted. They offer advertisers frequency, reach, and high visibility within exactly targeted geographic zones”* (P 3).

Some of the public transport vehicles used for advertising, such as buses and trains follow pre-determined and scheduled routes in specific geographic areas, while the routes of other vehicles, such as minibus taxis and upmarket cabs are more flexible, stopping at a large number of different locations within an area. This influences the way different transit advertising formats are employed in

campaigns. The participants differentiated between broad nationally and narrow geographically target campaigns. *"This message is going to be relayed, and re-impacted to your broad target audience going on this route, every day, every morning to work and back. Or, we can be targeted, for example, if you just want to target taxis that run next to school routes and you target school kids"* (P1). Another explained how the levels of frequency and reach could be maximized using mobile media options and repetitive message placement. *"For regional reach, branding of taxis or your bus advertising... so if you want to carry a message or a product demonstration or a brand activation – or just getting your message out there for a specific product - you can use the mobile media, and you can take it into Gugulethu (township close to Cape Town) the one day and the next day, Khayalitsha (township in Western Cape), and the next day, off to Durban, the next week you can do Umlazi (township on the east coast of KwaZulu-Natal), KwaMashu (township close to Durban), Claremont up to Jo'burg, wherever you need to be"* (P5). The transit advertising media attributes should thus be taken into account, when planning such a campaign, since this influence the actual reach and frequency of the media plan, as well as the potential demographics of the commuters in the spaces being exposed to the advertising.

### **Theme 3: Cost**

When comparing the cost efficiency of the different formats of transit advertising media, minibus taxis are regarded to be able to deliver a message to a large number of commuters at a reasonable low unit cost. *"Taxis get around. You know they work for twelve hours a day, and cover more than 300km each day. In a month a taxi will transport almost 5000 passengers and cover almost 10 000 kilometres "* (P14). *"Taxi advertising is a cost-effective way to reach the commuters' market that is active in the economy, so they have spendable income"* (P7). Advertising on upmarket transit advertising media, such as the Gautrain station, or at airports is perceived to be far more expensive. One participant explained, *"If you are looking for the fancy high class cabs you are looking for high expense, and if you are looking for minibus taxis, you are looking at low expense. However, the cost of new transit, such as the Gautrain, is very high"* (P 3). Another confirmed that formats reaching higher income commuters are expensive. *"Airport media are very expensive. For example, a gantry exiting OR Tambo, costs almost R400 000 (30 585 USD) per month "* (P5).

A number of the participants were of the opinion that airport media do not offer adequate value for their clients' budget any more, due to the extremely high media cost and the loss of exclusivity. They believe that this is due to low-cost airlines expanding air travel to a wider market, which in the past was only possible for the really affluent. *"The cheap airlines operating over the past few years have resulted in air travelling having become far more accessible to a lot more people. One cannot claim that same exclusiveness with regard to the audience at the airports anymore, due to lower incomes; people are also using that mode of transport. So, I think the traditional argument that the airports are the highest concentration of wealthy viewers is less valid now than it was 15 years ago"* (P10). Others confirmed the high expenses associated with airport

media. "The set-up cost is can require an enormous investment, so a brand must determine if it will offer long-term pay-off" (P15).

## DISCUSSIONS

The findings in *theme 1* revealed that transit media advertising offers targeted audience exposure. This is in line with the findings of previous study reporting on the ability of specific types of transit advertising to target narrowly defined audience segments such as taxi commuters of frequent flyers (Veloutsou & O'Donnell; 2005; Wilson & Till; 2008). However some novel insights were also revealed in the developing context of the current study. Airport media no longer offer exclusivity to advertisers aiming at high-income consumers and business travellers due to cheaper airlines making air travel affordable for the lower-income mass market.

When selecting specific transit advertising media options, it is thus critical to consider the demographic profile of the travellers advertisers are hoping to reach versus who they will actually be reaching. People travelling with airlines no longer just include affluent business people or international travellers. Voluminous middle-income families, local and international arriving or departing from South Africa also utilise this type of transportation.

Advertisers can choose from a variety of interior airport displays (located throughout the terminals in the arrival and departure areas, ticketing areas, baggage-claim areas, gate-hold rooms, concourses, entrances/exits, retail shops and VIP lounges) or exterior airport displays (along airport and terminal roadways in the form of billboards, spectaculars or overhead signs) to match the demographics of the targeted travellers leaving or entering this environment. For instance, those advertising car rental, accommodation or attractions aimed at tourist might consider baggage-claim areas, while those aiming at wealthy business travellers might consider VIP lounges or duty free shops.

The findings in *theme 2* with regards to the *frequency and reach* highlighted some strengths as well limitations of transit advertising media. It confirmed the potential to deliver high and continuous levels of frequency and reach due to commuters' mobility and repetitive exposure to the same message daily or weekly. This collaborates with research results on the geographic selectivity offered by different transit advertising media (Veloutsou & O'Donnell, 2005). While an advantage of transit advertising is the ability to provide high levels of exposure and frequency to a large number of people, this overly repetitive exposure to messages can result in message wear-out so that commuters just ignore them. Advertising wear-out occurs when, at some level of repetition, the audience affective response is either no longer positive or shows a significant decline. Advertising wear-out is the result of excessive frequency causing viewers to perceive there is nothing new to be gained from processing the advertisement, thereby withdrawing attention.

Distracting stimuli in a cluttered and crowded transit environment can also make it difficult for advertisers to engage with captive commuters, because they can be tired, bored or too absorbed in their thoughts to even notice a message. Controversial messages may contribute to this less than positive feeling. Limited availability in certain areas is another limitation. For example, in rural or suburban areas, mass transit is limited or non-existent, so the medium is not very effective for reaching these people.

The surroundings may detract from advertisers' messages. A mud-splashed bus, a graffiti-sprayed subway car or a decaying subway entrance wall may not be ideal to showcase prestigious brands. Also, rushing through an airport may create apprehensions that limit the effectiveness of the advertisements placed there.

Advertisers could use creative techniques to minimize wearing-out over repeated exposures. To avoid wear-out they must offer ample variations in advertising executions. They can for example develop and rotate a pool of advertisements that employ different executions but convey the same basic message. These executions can share a number of common features, such as brand name, logo and tag line while other features such as headline, copy and graphic elements are changed. They could also include context-related themes such as destinations, or airport-related themes for airport media in the message to increase the level of processing of information by the audience. This use of context-related themes draws on consumers associations and relevant knowledge, which, in turn, facilitates learning and the recall of information or messages. They can also utilize original media strategies such as placing advertisements on unusual or unique sizes and shapes that are custom-designed to gain maximum attention through special eye-catching effects, such as cut-outs, three-dimensional sculpted features and digital-interactive screens. The effectiveness of the message can be improved – not only by using simple short messages, but also by using one that is relevant to the context or the environment, and placing it in unique advertising formats, such as an unusual shape.

The findings in *theme 3* confirmed that mass public transit advertising is able to deliver reach to a wide captive audience at relative low unit cost. This is a common cited and empirically proven advantage of transit advertising (Prendergast & Hang, 2008). However the study furthermore reported on the high prices of up-market transit media such as airport media. This is because a captive audience is valuable for advertisers, and the transit media providers and agencies know and exploited it.

## CONCLUSION AND RECOMMENDATIONS

Academic literature focuses predominately on freestanding outdoor advertising signs or billboards with limited studies on transport advertising. None of these offer insights on the value and challenges of those responsible for transit advertising strategies in a developing context. For that reason, insight was obtained purposefully selected specialists in the South African industry. This was reported in thematic format and compared with existing transit advertising media literature.

This study is not without limitations. Only media specialists in South Africa were interviewed, a valuable future research agenda could therefore be to compare the media tactics to target particular audiences identified in this study with those applied in other developed or developing countries. Specialists might not truly comprehend consumers' perspective. Hence, one could add value by examining consumers' exposure to and attitudes towards different transit advertising formats. It would especially be interesting and worthwhile to conduct empirical research on the qualitative values of media – such as the image and potential impact of the different media types, the context in which they are placed and the fit between the brand/product image and the context where it is advertised in light of the findings of the study that specialists are relying on these values to promote the image of advertisers' brands.

## REFERENCES

- Bae, Y. H., Jun, J. W., & Hough, M. (2016). Uses and Gratifications of Digital Signage and Relationships with User Interface. *Journal of International Consumer Marketing*, 28(5), 323-331.
- Barker, B. (2014). *Media Planning: Measuring the distance between theory and practice*.
- Belch, G. E., & Belch, M. A. (2015). *Advertising and promotion: An integrated marketing communications perspective*. 10th Edition, The McGraw– Hill, New York, NY.
- Bronner, F., & Neijens, P. (2006). Audience experiences of media context and embedded advertising-a comparison of eight media. *International Journal of Market Research*, 48(1), 81-100.
- Chan, K., & Fung, M. S. (2013). Effectiveness of subway advertising in Hong Kong. *Journalism and Mass Communication*, 3(12), 757.
- De Bruijin, A., Ferreira-Borges, C., Engels, R., & Bhavsar, M. (2014). Monitoring outdoor alcohol advertising in developing countries: findings of a pilot study in five African countries. *African Journal of Drug and Alcohol Studies*, 13(1).
- Du Preez, J. (2015). Trends in Out-of-Home, available at <http://www.theredzone.co.za/1168-trends-in-out-of-home> (accessed 16 June 2017).
- Gale, N. K., Heath, G., Cameron, E., Rashid, S., & Redwood, S. (2013). Using the framework method for the analysis of qualitative data. *BMC research methodology*, 13(1), 117.
- GIA. (2015). The Global outdoor advertising market, available at: <http://www.strategyr.com/MarketResearch/Infographics/Images/MCP-1610/1610.jpg> (accessed 16 June 2017).
- Ju, I., & Chung, J. (2016). The Effect Model of Billboard Advertising Media. *Journal of Multidisciplinary Research*, 8(2), 15-31.
- Koekemoer, L. (2010) *Introduction to Integrated Marketing Communications*. Juta, Claremont.
- Lane, R.W., King, K.W. & Reichert, T. (2011). *Kleppner's advertising procedure*. Upper saddle river, New Jersey: Prentice Hall.
- Lincoln, Y. S., & Guba, E. G. (1985). *Naturalistic inquiry* Sage.
- Magna Global. (2015). Global advertising forecasts, available at: <https://www.magnaglobal.com> (accessed 16 June 2017).
- Morrison, M.A., E. Haley, K.B. Sheehan, & R.E. Taylor (2011). *Using qualitative research in advertising: Strategies, techniques and applications*. Thousand Oaks, CA: Sage Publications.



- OAAA. (2015). OOH advertising today , available at: [https://oaaa.org/Portals/0/Public%20PDFs/Outdoor%20Advertising%20Today\\_2015.pdf](https://oaaa.org/Portals/0/Public%20PDFs/Outdoor%20Advertising%20Today_2015.pdf) (accessed 16 June 2017).
- OMD South Africa, (2013) South African Media Facts – Blueprint 2013, available from <http://www.omb.co.za> (accessed 16 June 2017).
- Patton, M. Q. (2005). *Qualitative research*. John Wiley & Sons, Ltd.
- Prendergast, G., & Hang, C. C. (1999). The effectiveness of exterior bus advertising in Hong Kong: A preliminary investigation. *Journal of International Consumer Marketing*, 11(3), 33-50.
- Reynolds, T. J., & Gutman, J. (1988). Laddering theory, method, analysis, and interpretation. *Journal of advertising research*, 28(1), 11-31.
- Ritchie, J., & Spencer, L. (2002). *Qualitative data analysis for applied policy research. The qualitative researcher's companion*, 573(2002), 305-329.
- Roux, T., van der Waldt, D. L. R., & Ehlers, L. (2013). A classification framework for out-of-home advertising media in South Africa. *Communicatio*, 39(3), 383-401.
- Tapp, A. (2005). Media neutral planning—A strategic perspective. *Journal of Database Marketing & Customer Strategy Management*, 12(2), 133-141.
- Shenton, A. K. (2004). Strategies for ensuring trustworthiness in qualitative research projects. *Education for information*, 22(2), 63-75.
- StatsSA. (2013). *National Household Travel Survey*, available from <http://statssa.gov.za> (accessed 16 June 2017).
- Subramania, J. (2016). Developing public transport, *The Hindu*, available from <http://www.thehindu.com/todays-paper/tp-in-school/Developing-public-transport/article12551479.ece> (accessed 16 June 2017).
- Veloutsou, C., & O'Donnell, C. (2005). Exploring the effectiveness of taxis as an advertising medium. *International Journal of Advertising*, 24(2), 217-239.
- Wilson, Rick T., and Brian D. Till. "Airport advertising effectiveness: An exploratory field study." *Journal of Advertising* 37, no. 1 (2008): 59-72.
- Wilson, R. T., Baack, D. W., & Till, B. D. (2015). Creativity, attention and the memory for brands: an outdoor advertising field study. *International Journal of Advertising*, 34(2), 232-261.
- Wilson, R. T., & Till, B. D. (2011). Effects of outdoor advertising: Does location matter?. *Psychology & Marketing*, 28(9), 909-933.
- World Outdoor Advertising News. (2010). *Clinique on wrap for International Audiences* Available from <http://www.pacificbreeze353.com/newsletters/index.cfm?y=article&company=1&article=1453&nl=262&click=web&subsection=3&lang=1> accessed 16 June 2017).
- This work is based on the research support in part by the National Research foundation of South Africa, Grant: 99338

# UNDervalUED AND DISORGANIZED? CLASSIFICATION AND APPRAISAL OF CONTEMPORARY OUT-OF-HOME ADVERTISING IN SOUTH AFRICA

Roux, Thérèse; Babst, Melanie; de Jager, Johan

Department of Marketing, Logistics and Sport Management, TUT, Pretoria, South Africa

## ABSTRACT

Systematic reviewing of prominent marketing communication journals and online industry sources offered some insight on the effectiveness of contemporary OOH advertising media types, but it presents no comprehensive classification thereof. This article therefore proposes an audience-centred matrix to plan and classify out-of-home advertising media options, according to the different environments in which audiences are exposed to them. Marketers are advised to focus on audience's mode of mobility and their opportunity to process brand information, rather than the media features typically emphasised in the literature. This article contributes to the current theory for this type of advertising by synthesising discordant theory and practitioner sources on this type of advertising. Clear directions for future research were offered in particular, consumers' process ability and mobility patterns in different environments, and the value of OOH advertising from a user- and consumer perspective.

*Keywords: Outdoor advertising, Transit advertising, Street furniture advertising, Mall and point-of-purchase advertising,*

## INTRODUCTION

Out-of-home (OOH) advertising has always been somewhat unappreciated in academic literature. It remains of the least researched mediums - probably due to high costs involved with enacting field experiments or the large national surveys typically required to study this medium (Donthu and Bhargava, 1999). Some researchers have focused on the effectiveness of outdoor advertising boards (Bhargava *et al.*, 1994; Donthu *et al.*, 1993; Ju and Chung, 2016; Klerkx and Van Meurs, 2006; Taylor and Franke, 2003; Taylor *et al.*, 2006), while a few others considered contemporary OOH advertising types (Veloutsou and O'Donnell, 2005; Wilson and Till, 2008). However they don't offer a comprehensive logical taxonomy to apprehend the whole range of contemporary OOH advertising media possibilities. The practitioner's perspective - as represented by OOH advertising media associations across the globe - recognises an increasing wide variety of options, but don't concur on exactly what constitutes

contemporary OOH advertising media (OAAA, 2017; OMC, 2017; OMANZ, 2017; OMA Ireland, 2017; OMAC Canada, 2017, OMA Australia, 2017, OHMSA, 2017, OAAN, 2017). Marketers seem to rely on traditional outdoor advertising billboards in the roadside environment while failing to appreciate the potential synergy of contemporary alternatives options in transport-, retail-and-leisure-, and place-based environments (Roux and Van der Waldt, 2016).

## **THE PROBLEM INVESTIGATED**

There seem to be a lack of a proper comprehensive OOH advertising media matrix or taxonomy for the whole range of media options. Without such a classification matrix or taxonomy there is no systematic, integrated basis to define, study or measure this persuasive advertising medium, neither is there a thorough understanding of the wide range of contemporary OOH advertising media options. For example according to Nielsen Media Research (NMR), OOH advertising media in South Africa accounted for R1,6 billion or 4,3% of the total of advertising media investment (OMD, 2013). However other reputable industry sources (such as Gordon Muller as Chairperson of the Advertising Media Forum and the Advertising Media Association of South Africa and Price Waterhouse Coopers) indicate that it was at least R4 billion or closer to 11.8% of total advertising investment in the country in the same year (Muller, 2013; PwC South Africa, 2013). The significant difference between these figures can be attributed to a number of factors. Firstly, the Nielsen figure only considered traditional OOH advertising media types such as roadside billboards, while disregarding the wide range of contemporary OOH advertising opportunities (OHMSA, 2017). Secondly, unlike other reported media formats the OOH advertising investment does not include agency commission, resulting in a 16.5% under-representation (PwC South Africa, 2013). Thirdly, a significant number of the OOH media companies, do not report their advertising revenue figures to Nielsen (Muller, 2013).

In order to address this shortcoming, the purpose of this article is to develop an audience-centred matrix to plan and classify the wide range of contemporary OOH advertising media options. It is necessary to approach conventional and contemporary alternatives OOH advertising with a holistic and audience-centred perspective in order to recognize and emphasize common elements (e.g., out-of-home placement and a mobile audience). This can guide marketers to better integrate and coordinate their efforts by increasing effective and efficient allocation of their advertising budget, recognizing the potential of the environmental urban context as a persuasive advertising medium beyond traditional and expensive mass media and exploiting all possible synergies among the potential environmental touch-points with commuters, pedestrians and shoppers. In the light of this discussion, the objectives of this article are twofold: i) To propose a contemporary OOH advertising media matrix; ii) To review the value of the major OOH advertising media platforms

This next section firstly outlines the methods used to design the study; and it then presents the results of the systematic review. Thereafter, a contemporary OOH advertising media matrix is proposed – derived, as it is - from this systematic review. Finally, the article provides conclusions, summarises the limitations, and recommends some areas for future research.

## RESEARCH METHOD

Systematic reviewing is a methodological approach that systematically maps out the available evidence, critically appraises the evidence, and synthesises the results (Petticrew and Roberts, 2008). Systematic reviews allow for the objective appraisal of evidence, in order to address a specific research question, the synthesis of the results in an explicit way, as well as an identification of those areas where research is insufficient and further investigations are required (Kitchenham, 2004). A key element of a systematic review is the research protocol, which describes the research question; the search process; the inclusion and exclusion criteria; and methods for synthesising the studies, according to the type of data available (Petticrew and Roberts, 2008). In this article, the research question deals with exploring what constitutes contemporary OOH advertising media. The search process entails searching for classifications of OOH advertising media types by screening recent journals in advertising and marketing communication, as well as perusing the websites of global OOH advertising media associations. These online sources were considered, because there is only a very limited amount of scholarly articles available on the whole range of OOH advertising media types and even less so in the developing context (Roux and Van der Walddt, 2016).

Specific inclusion and exclusion criteria for journals were applied. To search for relevant journal articles the keywords "out-of-home advertising", "outdoor advertising" and "billboard advertising" were entered in the search functions nine prominent international journals in the advertising, communication and marketing disciplines. These international journals (Journal of Advertising, Journal of Advertising Research, Journal of Current Issues and Research in Advertising, Journal of Marketing, Journal of Marketing Research, Journal of Consumer Research, Communication Research, Journal of Marketing Communications) are widely accepted as the top journals in the respective disciplines. They are also similar to those used in previous studies to examine scholarly literature on advertising and media within these discipline (Khang *et al.*, 2016). No classifications of the major OOH advertising media types were found when examining the abstracts of the identified articles. However they offered valuable insight on the effectiveness of different OOH advertising types. This was integrated in assessment of the features of the major OOH advertising media platforms.

Websites of OOH advertising media companies, which are part of FEPE, the international industry association of OOH advertising media) with English on their webpage were also considered to review

practitioners' perspective. These media companies represent the majority of industry revenues in the respective countries, as well as globally (FEPE International, 2017). A summary of OOH advertising media classifications found in on the websites of official OOH advertising media associations is depicted in Table 1.

Practitioner OOH advertising media taxonomies	Outdoor Advertising	Transit Advertising	Street Furniture Advertising	POP/Retail Advertising	Alternative OOH Media
Criteria used: Physical features					
America (OAAA, 2015)	■	■	■	■	Cinema, DOOH
Ireland (OMA Ireland, 2015)	■	■	■	■	DOOH
New Zealand (OMANZ, 2015)	■	■	■	■	DOOH
Criteria used: Type of Audience/ environment					
Australia (OMA Australia, 2015)	■	■	■	■	DOOH
Canada (OMA Canada, 2015)	■	■	■	■	Place based
United Kingdom (OMC UK, 2015)	■	■	■	■	Cinema
Nigeria (OAAN Nigeria, 2015)	■	■	■	■	DOOH
South Africa (OHMSA, 2015)	■	■	■	■	DOOH

*Table 1: A comparison of OOH advertising media taxonomies presented in practitioner sources*

The progression of industry is illustrated by the wide variety of unique media options offered to advertisers, such as sport-stadium advertising, promotional activities at shopping malls, and transit environments, various digital OOH advertising types, floating and flying advertising on boats and balloons, place-based advertising at medical clinics and restaurants. Furthermore different criteria are used to categorise the numerous types. Some base their classification mainly on the media format, irrespective of the environments and those audiences, which will be exposed to the medium. This means that an advertising board aimed at drivers on the highway, and one placed at a transport hub, and even one located inside a shopping mall, would be classified as outdoor advertising – irrespective of the environment in which it is located, or the type of audience exposed to it. While this method of categorisation is simple, it does not capture the environmental complexity of locations in which out-of-home advertising messages are delivered. Other associations classify the OOH advertising media types on the basis of the environment in which it is placed, or the key audience reached by the medium while they are involved in specific activities. The implication is that a billboard aimed at drivers on the highway would be classified as a roadside medium; but when it is located at a transport hub, it would be classified as transit advertising; and if inside a shopping mall, it would be regarded as retail a medium. Following an audience-centred approach like this is arguably more prudent, than merely focusing on the physical features of the medium. Ultimately, the target audience should be the main focus of any advertising campaign and the focal point around which all communication decisions are made.

There are also some differences of opinions on the inclusion or exclusion of cinema advertising as part of the OOH advertising media class. Some sources regard cinema advertising as part of alternative

OOH advertising media; while most exclude it. The nature of cinema advertising differs from OOH advertising media in that the audience has to give its explicit consent to being exposed to the messages. Advertisements on OOH media are just advertisements; the brand messages are not embedded in a medium consisting of editorial or programme content (Muller, 2013). Consequently, cinema advertising will, therefore, be excluded from the OOH advertising media class in this article.

The systematic reviewed revealed that academic literature classifying OOH advertising is insufficient. It also showed that the industry present a variety of options but don't agree on the major types of OOH advertising media. The aim of this article is thus to overcome this by proposing a contemporary OOH advertising media matrix and then present the value of the major OOH advertising media platforms.

## A CONTEMPORARY OOH ADVERTISING MEDIA MATRIX

The proposed OOH advertising media matrix in Figure 1 contains five major OOH advertising media platforms and OOH environments to incorporate the wide assortment of contemporary media recognized by global OOH advertising media associations. The major platforms are classified, according to two dimensions, namely: the *audiences' mode of mobility* and their *opportunity to process the information* presented in an advertisement. The *audience* is at the centre of this planning matrix. In the context of integrated marketing communication, this is known as an outside-in planning approach, or a customer/audience-centred planning (Kliatchko, 2008). This approach is critical for media planning; since advertising without value or relevance to an audience, or which are not delivered via relevant media, would be filtered out, or ignored by the potential consumers (Wilson *et al.*, 2015). Therefore, a audience's perspective should be followed in deciding which media would be most effective in reaching a specific target audience or audiences by delivering relevant messages via the most-preferred media. This is achieved when the information needs, motives, lifestyle, frame-of-mind, and behaviour of the target audience(s) are used as a basis to select the most suitable OOH advertising media touch-points, as opposed to focusing on the media characteristics. For example by placing contextually relevant messages on airport media in appropriate locations with longer dwelling times, would improve the level of processing of information by the travellers (Wilson and Till, 2008).

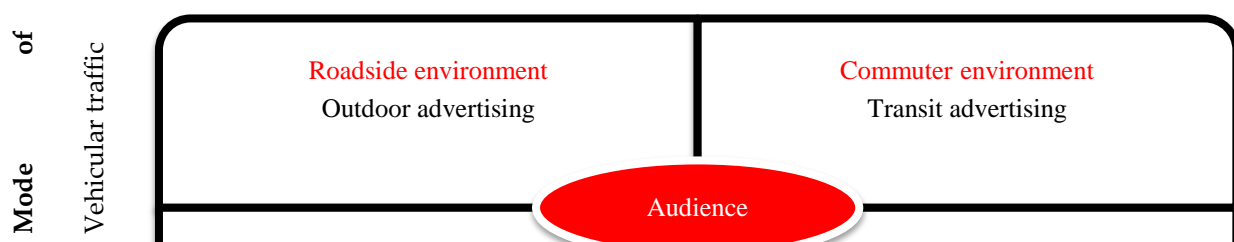

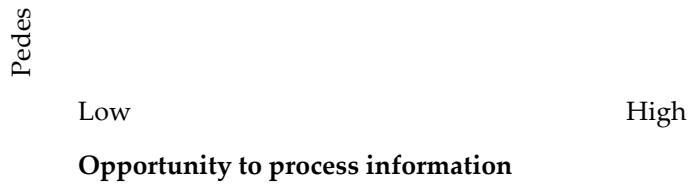

Figure 1: Contemporary OOH advertising media matrix

#### *Mode of mobility of audience*

Analysing the mobility patterns of a population is the basis of precise OOH advertising media planning (Bloom, 2000). The mobility of audiences reached differs considerably across the OOH media platforms, and should be considered when designing media plans and advertisements. Outdoor advertising is mainly aimed at moving traffic such as drivers or commuters. With mobile consumers moving in one direction and the advertisements possibly in another direction, the time of the exposure to the message is usually very brief and the likelihood of taking notice of a message is relatively low (Van Meurs and Aristoff, 2009). However this type of advertising has the ability to expose members of a target market to a message numerous times in a relatively short period of time (Donthu *et al.*, 1993). Based on understanding where people are travelling from and to and for what purpose, the relevant target groups can be addressed with greater precision and less wastage (Bloom, 2000). The OOH mobility patterns of pedestrians and shoppers impact how they interact with advertising media. Advertising is more likely to be noticed when consumers are alone compared to when being in a group; and when being placed at specific locations such as close to a store or POP, but away from security checkpoints or gate-waiting areas (Wilson and Till, 2008).

The design can also influence the effectiveness of advertisements aimed at a mobile audience. The recognition of brands and products can be improved by using easily identifiable branding (logos/packaging/brand colours) and strong contrasting colours but limiting distracting content and informative information cues (images or words); (Donthu *et al.*, 1993; Van Meurs and Aristoff, 2009). Design can even enhance the experience and influence the buying behaviour of shoppers by including humorous components, sounds and contextual relevant information to assists them in making their purchase decisions more rapidly (Dennis *et al.*, 2012, Newman *et al.*, 2010).

#### *Opportunity to process information*

A unique feature of OOH advertising compared to other media is the relatively low level of control and involvement of the audience when processing messages (Donthu *et al.*, 1993; Wilson and Till, 2008). The situation in each of the OOH environments differs considerably; and therefore, this provides distinctive opportunities for audiences to process brand messages. The potential viewing- and dwelling-time of

the target audience depends on the OOH environments in which they are exposed to the message (Wilson and Till, 2008). Advertisements viewed by a mobile vehicular audience are more difficult to process; because their appearance is often fleeting – and consumers have limited time to attend to them. Consequently, they do not usually lead to a high level of involvement in message processing (Donthu *et al.*, 1993). Using simple short messages that are relevant to the context or the environment, and placing these on unique advertising formats, such as an unusual shape or form, can be used to increase the level of information processing (Dennis *et al.*, 2012). Vehicular traffic is typically exposed to the advertisement very briefly. Environments with longer dwelling time, such as travellers waiting at an airport or people waiting at doctors' rooms typically result in more time being available for people to notice the message (Wilson and Till, 2008).

The opportunity for interaction and engagement from the audience is better in environments with longer potential dwelling times than those with limited exposure times, such as at waiting areas at airports and kiosks in shopping malls displaying advertising on video screens (Gambetti, 2010). The disposition of consumers in the retail environment might be more composed; since they have already reached their shopping destination. Consequently, they are in shopping mode, and likely to be most receptive to information that could assist them in making purchase decisions (Burke, 2009). Thus, the opportunity to process information is typically low in both the outdoor- and urban environment, while the transit- and retail environment provide audiences with more opportunities to process such information.

## **OOH ADVERTISING MEDIA PLATFORMS**

### *Outdoor advertising in the roadside environment*

Outdoor advertising media are usually placed in the roadside environment, targeting fast-moving vehicular traffic on highways and other major roads, and are viewed from a distance. Consequently, an important condition for the effectiveness of outdoor advertising media is visibility from the side of a road (Taylor *et al.*, 2006). This inherently requires readable and concise messages, remarkable sizes and prominent locations for messages to be noticed by motorists and passengers (Donthu *et al.*, 1993). In the roadside environment, boards that are larger in size are more conspicuous and therefore have a greater likelihood of being seen (Wilson *et al.*, 2015). Research has shown that brand and/or company recall levels are positively related to high levels of repetitive message exposure on outdoor-advertising media (Bhargava *et al.*, 1994). Its round-the-clock presence offers advertisers a broader reach at high frequency levels in both national and local markets (Taylor *et al.*, 2006). By placing outdoor advertising on specific highways and other major routes, advertisers can target a defined geographic market (Belch and Belch, 2015). Local companies often use this platform rather than traditional broadcasting and print



media, because it exposes a broad mass market to their messages at a lower price (Taylor and Franke, 2003). The high impact of messages on these pervasive and massive canvases produces high awareness levels that could improve the brand image (Ju and Chung, 2016) and package identification (Klerkx and Van Meurs, 2000). Advertisements on these large formats are potentially more attractive and noticeable (Katz, 2014); and they can be used to portray the advertised organisation as an important and respected company or brand (Ju and Chung, 2016).

Nevertheless, outdoor advertising media have some limitations. Some countries have banned or limited the placement of outdoor advertising, and extreme environmentalists regard this medium as visual pollution (Iveson, 2012). For example Baro and Iqani (2017) criticised the massive scale outdoor billboards that cover the entire facades of city buildings in Johannesburg and believe that they are at the expense of citizens' visibility and their opinion. Outdoor advertising delivers messages to a broad mass market with limited information on demographic variables for target audience selection, such as age, gender, occupation, income and family size (Lane *et al.*, 2011). Another limitation is the limited copy/text supported by such a brief exposure to the message – due to audiences often passing by at high speeds. However, short, simple and legible messages tend to be recognised by consumers in split seconds; and they allow for more rapid brand and company identification (Klerkx and Van Meurs, 2000).

#### *Transit advertising media in the commuter environment*

Transit advertising is another major platform of OOH advertising media; and it has also been in existence for quite some time. In the early nineteenth century, messages, brand names and company names attached to or pasted on carriages, buses and vans were carried through the streets by means of horses (Bernstein, 2005). However, it has evolved considerably since then to now encompass a wide variety of new advertising opportunities on moving transit media, such as on and/or inside buses, taxis, trains and planes, or on trailers and trucks as well as on static transit media, such as airport terminals, taxi ranks, bus stations and train stations (Veloutsou and O'Donnell, 2005). Advertising on transit media provides widespread reach and repetitive exposure of messages to citizens working in major metropolitan areas (Veloutsou and O'Donnell, 2005). The majority of commuters travel the same route to work every day, using the same mode of transport, and spending approximately an hour each day travelling to work (Advantage, 2012). This allows for prolonged and repetitive exposure to brand messages on various transit advertising media formats.

The surrounding stimuli in this active environment and the preoccupied minds of passengers introduce some challenges to the advertisers (Wilson and Till, 2008). As the OOH advertising media class grows in terms of appeal and available formats, the use thereof increases, along with the advertising clutter. In

addition, commuters may be engaged in other activities or media, such as newspapers, magazines or mobile devices, which may prevent contact with transit-advertising messages. This emphasizes the importance of a striking message that could hold the attention and interest of the target audience (Bhargava *et al.*, 1994). Although advertising on moving vehicles can be quite a challenge, this form of transit media offers substantial creative opportunities, especially if used as a support medium in conjunction with other media such as radio and television (Veloutsou and O'Donnell, 2005).

#### *Street-furniture advertising in the urban environment*

While transit advertising delivers message to commuters, advertising on street-furniture provides a means to reach audiences somewhat closer to the point of purchase. Street-furniture advertising refers to those messages affixed to structures/furniture found in the streets of urban, suburban and metropolitan areas, such as bus shelters, park or street benches, kiosks, litterbins, bicycle racks, street poles and other structures erected for the purpose of advertising (OHMSA, 2017). Consequently, it can reach pedestrians, shoppers, and even drivers or passengers in slow-moving vehicles. This OOH media format offers exposure to a highly defined, motivated consumer market that commutes to, gathers at, or resides in specific areas (Lane *et al.*, 2011). Urban furniture is not a primary advertising medium; but it rather facilitates and exploits the infrastructure provided for public use. Part of the income obtained from renting the advertising space on this furniture goes to the municipal bodies and local government, which, in turn, can use it to maintain or improve the infrastructure (OHMSA, 2017).

Street-furniture advertising is an economical option to deliver repetitive brand exposure to a specific geographically defined market on a 24-hour basis (Blakeman, 2011). It can also be used in residential areas of high-income households and public places, such as parks, where other larger types of OOH advertising are typically not allowed (OHMSA, 2017). Apart from the information feature of commuter shelters as advertising vehicles; they offer bus-users, and often taxi-users, other features, such as shelter, comfort and convenience (Bernstein, 2005).

#### *POP advertising in the retail environment*

POP advertising is found inside and outside shopping malls, convenient stores and other central gathering points (OHMSA, 2017). The wide variety of size and types is ideal for delivering advertising messages – wherever and whenever prospective customers make actual purchase decisions (Burke, 2009). Furniture and fixtures found inside the retail environment, such as elevators, escalators, information booths/kiosks, banners, benches, phone booths, restrooms and shopping trolleys, can also be used for advertising aimed at potential shoppers. Structures outside the retail location, for example,

bicycle-racks, car parks, parking booms, parking tickets, and even the outer walls of shopping centres, can also be employed (OHMSA, 2015). The effectiveness of advertising in this environment can be maximised by ensuring that shoppers remember the brand, when they enter this setting.

A consumer exposed to advertising via traditional print or broadcast media at their homes, often cannot recall what they have seen or heard, once they leave their homes (Gambetti, 2010). A brand is, therefore, best advertised close to the POP (such as on retail furniture or in malls), in order to maintain brand awareness and remind consumers of the advertising theme used for the traditional media, the closer the consumer comes to purchasing (Burke, 2009).

#### *Alternative advertising media*

Ambient or alternative OOH advertising media involve the use of almost any structure or format imaginable to reach specific audiences in unexpected and unusual places and manners (Jurca and Madlberger, 2015). The alternative media are positioned in the centre of the four OOH environments in this matrix, because they can be located in the outdoor-, transit-, urban- and retail environments. Alternative advertising media is the most diverse of all the OOH advertising media formats (Saucet, 2015) and can be seen on goods used by the public, such as shopping trolleys, shopping bags, soap dispensers, cups, fruits, vegetables, bus seats and petrol pumps; or goods exposed to the public, such as sidewalks, walls, structures, floors, ceilings and even people (Gambetti, 2010). A major difference between alternative OOH advertising and other OOH advertising media formats is that the audience is typically exposed to the brand message – when and where the message is most relevant to the particular product or service (Saucet, 2015). Advertisers and advertising agencies therefore have to scan the environment, in order to determine through which platform the advertising messages would be most relevant to, not just the product and context, but also a specific and often narrow target audience (Gambetti, 2010).

Ambient OOH advertising media offer organisations a cost-effective way to reach consumers (Jurca and Madlberger, 2015). This medium is characterised as being a low investment in terms of time, resources and money; and it is ideal for breaking through the cluttered advertising environment – by enhancing the consumers' advertising and brand experience (Gambetti, 2010). A common objective of using ambient OOH advertising is to reach consumers in their daily lives, surprising and getting noticed so that they would want to share their experience with their network via electronic word-of-mouth (WOM) (Saucet, 2015). Using the relevant media and messages can enhance the value that consumers receive from positive experiences. The ambient OOH advertising media is ideal when used as part of an advertising campaign to support the messages delivered via traditional media and/or other OOH media platforms (Gambetti, 2010). This medium should, therefore, be strategically integrated into the

advertising campaign, in order to guarantee a collaborated advertising effect that would strengthen a similar theme delivered via other media vehicles.

## CONCLUSION AND RECOMMENDATIONS

This article proposed an original conceptualisation matrix of contemporary OOH media platforms. This matrix suggest that the audience's mobility and opportunity to process information should form the basis of contemporary OOH advertising media planning, rather the physical features of the media platforms. The proposed matrix is one of the first to offer a holistic and audience-centred perspective on the contemporary OOH advertising in a developing context to guide advertisers, marketers and media planners when evaluating and selecting different media options. The application value of the OOH advertising media matrix a developing context could change global views on the ad hoc and often hap hazardous use of these media platforms.

This article has important implications for both academics and practitioners. From an academic viewpoint, the results of this study offer insight into the diverse nature of the OOH advertising media class and the various opportunities offered across environments. This matrix can be form the basis to compare, measure or focus scholarly research on this topic. The research contributes to the literature by providing a more inclusive classification of OOH advertising media – with a particular emphasis on the different environments in which audiences are exposed to brand messages. Practitioners, such as advertisers and media planners face numerous challenges in effectively reaching the evading consumers of today. Consequently, they need to consider the wide range of alternative media options placed in the OOH environment, where its powers of intrusion do not require the explicit consent of the consumer, in order to make an impact.

This article offers several opportunities for future research. It would be worthwhile to launch an empirical study on consumers' frame-of-mind and ability to process messages in the respective OOH environments. Consumers' mobility patterns in different environments could also be analysed and monitored, in order to determine the impact of mobility on the cognitive resources available to process messages. Another possibility is to conduct empirical research to appraise the unique strengths and weaknesses of the major OOH advertising media platforms in the proposed matrix from an advertiser and consumer perspective.

## REFERENCES

- Advantage Magazine. (2012). Transit Media Guide 2012: The way to the future.
- Belch, G. E.. and Belch, M. A. (2015), 'Advertising and promotion: An integrated marketing communications perspective'. 10th Edition, The McGraw– Hill, New York, NY.
- Bernstein, D. (2005). 'Advertising outdoors: watch this space'. London: Phaidon Press.

- Bhargava, M., Donthu, N. and Caron, R. (1994). 'Improving the effectiveness of outdoor advertising: Lessons from a study of 282 campaigns', *Journal of Advertising Research*, 34(2): 46-55.
- Blakeman, R. (2011). 'Strategic Uses of Alternative Media: just the essentials'. New York: M E Sharpe Incorporated.
- Bloom, D. (2000). 'Measuring the audience to poster advertising'. *International Journal of Market Research*, 42(4), 395.
- Burke, R.R. (2009). 'Behavioural Effects of Digital Signage', *Journal of Advertising Research*. 94(2): 108-185.
- Dennis, C., Michon, R., Brakus, J.J., Newman, A. and Alamanos, E. (2012). 'New insights into the impact of digital signage as a retail atmospheric tool', *Journal of Consumer Behaviour*, 11: 454-466.
- Donthu, N., Cherian, J. and Bhargava, M. (1993). 'Factors influencing recall of outdoor advertising', *Journal of Advertising Research*, 33(3): 64-72.
- FEPE International. (2017). Federation European Publicite Exterieur, Worldwide association of OOH advertising media companies. [Online] Available on: <http://www.fepe.com> (accessed 1 June 2017).
- Gambetti, R.C. (2010). 'Ambient communication: How to engage consumers in urban touch-points', *California Management Review*, 52(3): 34-51.
- Iveson, K. (2012). Branded cities: outdoor advertising, urban governance, and the outdoor media landscape. *Antipode*, 44(1), 151-174.
- Iqani, M., and Baro, G. (2017). The branded skyline? A socio-semiotic critique of Johannesburg's architectural adverts. *African Studies*, 1-19.
- Ju, L., and Chung, J. (2016). The Effect Model of Billboard Advertising Media. *Journal of Multidisciplinary Research*, 8(2), 15.
- Jurca, M. A., & Madlberger, M. (2015). 'Ambient advertising characteristics and schema incongruity as drivers of advertising effectiveness'. *Journal of Marketing Communications*, 21(1), 48-64.
- Katz, H. (2014). 'The Media Handbook: A Complete Guide to Advertising Media Selection, Planning, Research, and Buying'. 5th edn. Routledge Communication Series.
- Khang, H., Han, S., Shin, S., Jung, A. R., and Kim, M. J. (2016). 'A retrospective on the state of international advertising research in advertising, communication, and marketing journals: 1963-2014'. *International Journal of Advertising*, 35(3), 540-568.
- Kelley, L.D., Jugenheimer, D.W. and Sheehan K.B. (2012). 'Advertising media planning: A brand management approach'. (3rd ed.). Armonk, New York: M. E. Sharpe.
- Kitchenham, B. (2004). 'Procedures for performing systematic reviews'. Keele, UK: Keele University, 33:1-26.
- Klerkx, M. and Van Meurs, L., (2006). 'Processing outdoor posters: product- and brand recognition in a split second', *International advertising and communication: current insights and empirical findings*. Wiesbaden, 124-139.
- Kliatchko, J. (2008). 'Revisiting the IMC construct', *International Journal of Advertising*, 27(1): 133-160.
- Lane, R.W., King, K.W. and Reichert, T. (2011). 'Kleppner's advertising procedure'. 18th edn. Upper saddle river, New Jersey: Prentice Hall.
- Muller, G. (2013). 'Advertising in the Out-of-Home Zone'. South Africa. Advertising Media Association of South Africa.
- Newman, A., Dennis, C., Wright, L., and King, T. (2010). 'Shoppers' experience of digital signage – a cross-national qualitative study', *International Journal of Digital Content Technology and its Applications*, 4(7): 50-57.
- OAAA. (2017). Outdoor media formats. Outdoor Media Association of America. available at: <http://www.oaaa.org?OutofHomeAdvertising/OOHMediaFormats/OOHMediaFormats.aspx> (accessed 1 June 2017).
- OAAN. (2015). Outdoor Advertising Association of Nigeria. available at: <http://www.oaan.org/oaan/> (accessed 1 June 2017).
- OHMSA, 2017. OOH classification matrix. Out-of-home Media Association of South Africa. available at: <http://www.ohmsa.co.za> (accessed 1 June 2017).
- OMA Australia, (2017). Outdoor formats. Outdoor Media Association of Australia. available at: <http://www.oma.org.au/using-oooh> (accessed 1 June 2017).
- OMA Ireland. (2017). The outdoor media in Ireland. The Outdoor Media Association of Ireland. available at: <http://www.oma.ie> (accessed 1 June 2017).
- OMAC Canada, (2017). OOH media in Canada. Out-of-home Marketing Association of Canada. available at: <http://www.omaccanada.ca> (accessed 1 June 2017).
- OMD, (2013). SA media facts - 2013. [Online] Available from: <http://www.omb.co.za> (accessed 1 June 2017).
- OMANZ. (2017). The formats of OOH advertising. The Outdoor Media Association of New Zealand. available at: <http://www.omanz.co.nz> (accessed 1 June 2017).

- OMC. (2017). UK outdoor revenue by environment. Outdoor Media Centre of the United Kingdom. available at: <http://www.outdoormediacentre.org.uk/> (accessed 1 June 2017).
- Petticrew, M. and Roberts, H. (2008). *Systematic reviews in the Social Sciences: A practical Guide*. Malden, USA: Wiley-Blackwell.
- PricewaterhouseCoopers (2013). "Global entertainment and media outlook", available from <http://www.pwc.com/gx/en/global-entertainment-media-outlook/segment-insights/out-of-home.jhtml> (accessed 1 June 2017).
- Roux, A. T., and Van der Waltd, D. L. R. (2016). Toward a Model to Enhance Synergy of Out-of-Home Advertising Media Integration Strategies. *Journal of Promotion Management*, 22(3), 386-402.
- Saucet, M. (2015). 'Street Marketing: The Future of Guerrilla Marketing and Buzz', New York: Frederick A. Praeger Publishers
- Taylor, C.R. and Franke, G.R. (2003). 'Business perceptions of the role of billboards in the U.S. Economy', *Journal of Advertising Research*, June: 150-161.
- Taylor, C.R. & Franke, G.R. and Bang, H. (2006) 'Use and effectiveness of billboards: Perspectives from selective-perception theory and retail-gravity models', *Journal of Advertising*, 35(4): 21-34.
- Veloutsou, C. and O'Donnell, C. (2005). 'Exploring the effectiveness of taxis as an advertising medium', *International Journal of Advertising*, 24(2); 217-239.
- Wilson, R.T. and Till, B.D. (2008). 'Airport advertising effectiveness: an exploratory field study'. *Journal of Advertising*, 37(1): 59-72.
- Wilson, R. T., Baack, D. W., and Till, B. D. (2015). Creativity, attention and the memory for brands: an outdoor advertising field study. *International Journal of Advertising*, 34(2), 232-261.
- WONSA, (2015). World Outdoor News South Africa. [Online] Available on: <http://www.pacificbreeze353.com/wonsa/> (accessed 1 June 2017).

## EMPLOYEE LEARNING IN INTERCULTURAL INTERACTIONS - GROUNDED THEORY

Rozkwitalska, Malgorzata

Faculty of Finance and Management, WSB University in Gdansk, WSB, Gdansk, Poland

### ABSTRACT

Owing to the presence of multinational corporations (MNCs) worldwide and the global mobility of workforce, working in multicultural environments is a daily reality for a growing number of people. Such a workplace introduces unique challenges to employees, yet it is also abundant in learning opportunities. The aim of the paper is to depict employee learning in intercultural interactions in MNCs. The in-depth interviews with 38 informants were conducted to explore learning in intercultural interactions in 2 MNCs' subsidiaries. The grounded theory approach was applied to collect and analyze the data, which were further interpreted with regard to the existing theoretical concepts. The emerged theory states that employees in intercultural interactions face specific job demands that evoke their stress (cognitive dissonance). If they believe that they can handle with them, then they classify them as challenges, mobilize their resources and learn in interactions. Job resources offered by MNCs that facilitate cooperation in a multicultural environment are of vital importance too.

The paper supports the positive view in the literature on cultural diversity in organizations, thus it contributes to the research conducted with the Positive Organizational Scholarship lens. Yet the study is limited due to application of the qualitative methodology, which does not allow for a generalization of the findings.

The study indicates that managers need to invest in the development of organizational and individual resources to foster learning in intercultural interactions. Moreover, they should recruit employees whose need for growth is well-developed since those individuals can benefit more from such work settings.

*Keywords: intercultural interactions, learning, multinational corporations, grounded theory, Positive Organizational Scholarship*

### INTRODUCTION

Global and national business theories and practice:  
bridging the past with the future

ISSN: 2547-8516  
ISBN: 978-9963-711-56-7

The work landscape is constantly changing due to the worldwide presence of multinational corporations (MNCs) in host economies, the global mobility of workforce, the unprecedented flow of immigrants, a growing need of companies to search for a more diverse staff with a broader knowledge base or the short supply of professionals for certain key positions in organizations (Collings et al., 2007; Harvey et al., 2004; Nolan, 2012; Samnani et al., 2012; van Veen et al., 2014). As a result, national diversity in organizations and states is rising, leading to a growing number of people working with culturally diverse others. Hence, intercultural interactions, here understood as contacts between individuals from a home country and other countries, are becoming and will be more and more significant in today business (Abdul Malek and Budhwar, 2013; Groeppel-Klein et al., 2010).

The work context in MNCs is different than in other types of organizations mainly due to cultural and language diversity which impacts on the interactions of MNCs' employees (Lauring, 2009; Tanova and Nadiri, 2010) and lead to norm complexity or discrepancy. Individuals in intercultural interactions can notice their face threat, an identity conflict or performance ambiguity. In addition, cultural diversity may lead to a different perception of an appropriate behavior with its negative influence on intercultural interactions (Lauring, 2009; Molinsky, 2007; Tanova and Nadiri, 2010). However, Davidson and James (2009) claim that when culturally different people interact with one another and are "faced with the novel worldview-perspective, a thought process, values – that the other person presents" (p. 139), learning takes place. It, in turn, affects the quality of interactions and may trigger an organizational change (Antonacopoulou and Gabriel, 2006; Carmeli et al., 2009; Minbaeva et al., 2003). Learning is, therefore, a vital aspect of individual and organizational functioning. Employee learning behaviors are essential antecedents of organizational learning (Engelhard and Nägele, 2003) since they enables the workforce to adapt to their environment, to grow, build and maintain their competitive advantage (Carmeli et al., 2009).

Scholars emphasize the importance of social contacts as facilitators of a learning process, yet there is still insufficient knowledge of the phenomenon, especially in a cross-cultural context (Carmeli et al., 2009; Engelhard and Nägele, 2003). Carmeli et al. (2009) argue that the nature and quality of social interactions may be substantial enablers of or obstacles to learning in organizations. Considering intercultural interactions, in view of prior research, they bring "double-edged sword" outcomes (Stahl and Tung, 2014). Thus, the aim of the paper is to depict employee learning in intercultural interactions in MNCs. Employee learning is defined in a holistic manner and as such "is the combination of processes throughout a lifetime whereby the whole person", i.e. his/her body and mind, "experiences social situations" that are transformed "and integrated into the individual person's biography, resulting in a continuously changing (or more experienced) person" (Jarvis, 2009, p. 25).



To actualize the aim, the paper first presents the literature review concerning learning in intercultural interactions and in MNCs. Then it shows methodology and the empirical findings, i.e. the grounded theory that reflects the research problem, with discussion. Conclusions, contributions, practical implications and directions for future research close the discourse.

## LITERATURE REVIEW

First and foremost, the literature on organizational learning and knowledge sharing in MNCs provides evidence that cultural barriers impede the learning process (e.g. Engelhard and Nägele, 2003; Kohlbacher and Kra, 2007). Although individual learning does not equate with organizational learning (Boateng, 2011), it may suggest that employee learning in MNCs encounter difficulties due to linguistic and cultural boundaries which create potential friction and different behavioral norms as well as communication codes, which make interactions troublesome (Mäkelä et al., 2012). On the other hand, MNCs are also seen as “a knowledge integrating institution (...), whose productive knowledge defines a competitive advantage” (Ambos et al., 2006, p. 295). Moreover, there are studies which demonstrate that MNCs’ internal environment and multicultural teams are abundant in learning opportunities (Basinska, 2017; Puck et al., 2008; Rozkwitalska and Basinska, 2015; Stahl et al., 2010).

The positive impact of intercultural interactions on employee learning is also highlighted in the studies on global careerists. Those people frequently admit that international assignments and dealing with cultural diversity contribute to their learning and growth as well as satisfy their need for adventure and curiosity (Stahl et al., 2010; Suutari and Mäkelä, 2007). Likewise, in the research on intercultural learning it is emphasized that interactions with foreigners are necessary for this type of learning which further fosters development of a person’s cultural competence or intelligence (Bartel-Radic, 2006; Gertsen and Søderberg, 2010).

The studies on cultural adaptation of expatriates or intercultural interactions of students expose the role of cognitive dissonance that individuals may face in contacts with other country nationals. It may motivate to reflective thinking, taking a stand on encountered unexpected and, as a result, learning that helps to reduce cognitive dissonance (Bowman and Brandenberger, 2012; Maertz et al., 2009).

## METHODOLOGY

*The research method*

The paper presents the results of an explorative, qualitative study carried out in the year 2014. It was aimed at exploring intercultural interactions in subsidiaries of MNCs. It investigated both the outcomes of intercultural interactions and facilitators of successful interactions. Due to the study's aim, the grounded theory approach was applied to analyze the data (Corbin and Strauss, 2008; Goulding, 1998). Therefore, the theory emerging process started with no previous hypotheses or propositions to test (Hassi et al., 2011; Randall and Mello, 2012). Afterward, the empirical findings were interpreted, as accepted by the grounded theory approach (Goulding, 1998), with regard to existing theories to better explain what was found.

Following the grounded theory approach, the research started with semi-structured, in-depth individual interviews with a rather loose structure of open-ended questions (Glaser and Strauss, 1999). The design of the interview assumed four sections, yet with necessary flexibility concerning the order of the questions asked (Dearnley, 2005). The first section tackled an issue of the interviewee's job position and his/her intercultural interactions at the workplace. The second part was built around the positive and negative outcomes of his/her intercultural interactions, while the third one referred to conditions for fruitful intercultural contacts. The last section comprised the participants' particulars, who were both managers and specialists employed in subsidiaries of the MNCs and involved in intercultural interactions. There were about 39 hours of the interviews with an average time of 63 minutes.

The interviews were transcribed, manually coded, analyzed and constantly compared with one another. The analytic procedure was based on the three-step procedure of analysis to meet the requirements of the grounded theory approach (Hassi et al., 2011). The first phase, i.e. the open coding, concentrated on common themes (keywords, phrases) emerging from the interviews (Randall and Mello, 2012) such as e.g. broader perspectives or diverse viewpoints. In the axial coding phase, those categories were labeled with the higher-level concepts, i.e.: 1) problems encountered in intercultural interactions; 2) positive outcomes of intercultural contacts; 3) enabling factors of successful interactions. In the selecting coding step, the categories were integrated and refined. As a result, a theoretical scheme emerged with respect to: 1) specific job demands and resources in MNCs; 2) learning as an outcome of intercultural interactions; 3) personal and acquired resources as facilitators of intercultural contacts.

Moreover, the study entailed additional interviews with the representatives of the board of directors in the subsidiaries, non-participant observations of managers and document analysis to contextualize the data and to ensure methodological and data triangulation (Maxwell, 2005).

#### *The companies and participants*

The sample consisted of subsidiaries of two MNCs (Table 1), which could “inform the research questions being investigated” (Zhang and Wildemuth, 2009, p. 309). They were selected purposively as the method is usually applied in research with qualitative content analysis (Zhang and Wildemuth, 2009). Following the study’s aim, only subsidiaries of MNCs in which intercultural interactions at work are a daily reality for their staff were appropriate for the investigation and the subsidiaries A and B met this initial criterion.

Subsidiary	A	B
Country of origin	Germany	the United States
Year and form of establishment	1986, greenfield investment	1994, greenfield investment, 1999 acquisition
Industry	surface protection, scaffolding, steel construction, oil and gas offshore services	IT-, HR- and the global tax and trade shared service center
Major markets	Europe	Europe, the Middle East, Africa
Degree of MNC’s internationalization	medium	very high
MNC’s staffing policy	polycentric	Geocentric
Degree of internal integration with MNC	low	High
Type of intercultural interactions	face-to-face and virtual contacts with clients or their authorized representatives, employees of other subsidiaries, and suppliers	mainly virtual contacts with other MNC employees of various, culturally distant nationalities, including teammates in virtual multicultural teams
Frequency of intercultural interactions	rare to medium	rather intense and frequent

Table 13. *A brief profile of the subsidiaries in the sample*

In terms of the number of participants the sample consisted of 38 individuals - 20 subjects in subsidiary A and the remaining 18 interviewees in subsidiary B. They were mainly specialists and middle-level managers (42.1% and 26.3% of the sample respectively). 60.5% of the participants were men, including 3 foreigners (from Denmark, the United States and Ukraine). The majority of the individuals (65.8%) were in their twenties and thirties. The respondents have had some international experience since 71.1% of them have worked and lived abroad, while 47.4% individuals have professional experience gained in other MNCs. In terms of job tenure, 55.3% of the informants have worked in the present MNCs for less than five years. Operation departments (18.4%), HR/administration (15.8%) or board of directors (15.8%), and R+D unit (13.2%) were the most represented organizational units in the sample.

## LEARNING IN INTERCULTURAL INTERACTIONS IN MNCS – GROUNDED THEORY

### *Results*

The content analysis of the data revealed the first category of the emerging theory, namely *specific job demands and job resources* that stimulate or facilitate the participants' learning at work (Table 2). The vast majority of them categorized those job demands, such as necessity to speak foreign language, to manage the difference of attitudes, perspectives, views, habits, etc. and to adjust to cultural diversity, as challenges rather than barriers. The following quotation mirrors the perception: *"The difficulties you face [in a multicultural team] are not a problem but a challenge. It is interesting, not annoying. It requires more effort, though I also learn more."* [interviewee 1, subsidiary B]

Job demand	Subsidiary A	Subsidiary B
Communication in common language	"I like communication in a foreign language. (...) Before the contact you never know if a person has a good command of language. I had problems with a Dutch accent. (...) You need to adjust your communication style to your interlocutor, e.g. if someone doesn't speak fluently, you should use simple vocabulary." [interviewee 5]	"There are plenty of benefits, developmental, personal ones, an occasion of working in another language, so we boost our linguistic competence." [interviewee 3]
Managing cultural differences	"While working with foreigners I have observed that they obey the rules and that's it... We look for solutions, how to bypass the rules, we see such opportunities." [interviewee 6]	"I'm fascinated with the differences and cooperation with other people. Understanding otherness is quite developmental for me. I become more flexible, see things from other perspectives. I become more tolerant." [interviewee 3]
Cultural adaptation	"...it is not any problem to provide our services here in our country or in any place in the world. Since we work on the European scale, or even occasionally on the global one, they are very operative, open and versatile, they easily adapt to a local organization as well." [interviewee 2]	"We learn from people whose worldview and business approach differ. I learn humility while noticing that others may not think the same way I do... The world is colorful... My organization develops since people who were raised in various cultures are the repository of diverse ideas which are brought to the work process." [interviewee 1]

Table 14. *Job demands and learning in intercultural interactions*

According to the participants of the study, while job demands activate employee learning, *job resources* offered in MNCs (such as language and cross-cultural trainings, communication technology for dispersed teams, knowledge databases, core values, special initiatives, relocation, etc.) facilitate intercultural interactions. Likewise, the latter could be obstacles if they are insufficient (e.g. a lack of face-to-face contacts due to limited resources allocated for business trips for virtual teams). The belief is the best depicted in the research quotation: *"It helps a lot when people can meet informally to see peers from virtual teams or other sites. Then communication and cooperation go better. Yet, it is all about money – it should be more videoconferences (teleconferences are more common nowadays) – the direct contact is the key."* [interviewee 9, subsidiary B]

The interviewees highlighted benefits of intercultural interactions, nevertheless they also noted barriers or challenges, e.g. various emotional states (like stress, anxiety, frustration, impatience,

curiosity, excitement, enthusiasm, pleasure, surprise, joy, etc.) that accompany such contacts. As far as this research is concerned, it has occurred evident that *learning*, including *personal growth*, was the most frequently mentioned outcome of intercultural contacts in both subsidiaries, i.e. 100% and 55.6% of the respondents in subsidiary A and 68.4% and 84.2% of the interviewees in subsidiary B directly referred to either learning or personal growth respectively. The following quotations demonstrate this finding (Table 3):

Subsidiary A	Subsidiary B
<p>“The contacts always teach you something and bring something. If they are with a foreigner, then you very often learn about the other country’s culture and it is somewhat enrichment. The contacts with other countries broaden your horizons... The contacts with foreigners let you observe how they work and you learn it.” [interviewee 1]</p> <p>“You gain personal development and cultural exchange owing to a contact with foreigners.” [interviewee 6]</p>	<p>“You may learn a lot... The whole world is not homogenous. Other nations introduce an element of stimulating anxiety. A person becomes vigilant, keeps acute senses. I personally prefer such an unstructured environment, when my impact on future results is significant, the creative excitement of working with teams that you cannot fully rely on. On the one hand, you feel nervous; on the other hand, it increases your curiosity concerning the outcomes.” [interviewee 5]</p> <p>“I personally appreciate the chance to learn from people from other places. It is a kind of reward to observe others, their talents and how they come up with a solution.” [interviewee 17]</p>

Table 15. *Learning as an outcome of intercultural interactions*

In view of the interviewees’ opinions, certain *personal or acquired resources* may enable positive intercultural interactions, i.e. interactions that bring about more benefits, such as e.g. learning, than barriers. These are personality traits (e.g. being open, flexible), a positive attitude, skills (social, technical, linguistic) and international experience (Table 4).

Subsidiary A	Subsidiary B
<p>“Previous experience, personality, an attitude, if we want to achieve something – if there is a problem, you have to solve it, this way or another; an approach to life, upbringing, inherited traits.” [interviewee 6]</p> <p>“If you do your job well, it doesn’t matter if you are a Pole or a foreigner – you have to do your job well in this sector. Your experience in working with foreigners, each contact, contributes to better cooperation in the future.”</p>	<p>“You should have a positive attitude toward others, be flexible and expect the unexpected, be ready for unconventional approaches to problems, and be open.” [interviewee 5]</p> <p>“You need patience to reach a common set of vocabulary, emotional maturity, tolerance, willingness to tune oneself, intercultural openness” [interviewee 18]</p>

Table 16. *Personal and acquired resources as facilitators of positive intercultural interactions*

### Discussion

The aim of the research was to depict employee learning in intercultural interactions in MNCs. The emerged grounded theory revealed that specific job demands in MNCs that are the consequences of cultural and language diversity trigger employee learning, while organizational and personal resources, including the acquired ones, help to forge positive intercultural interactions and enhance the learning process. The observation emerging from the study that learning is a relational process

which results from social interactions is congruent with previous research (Carmeli et al., 2009; Rozkwitalska and Basinska, 2015, 2016) and theories.

The study demonstrates that although MNCs' job demands put effort into the work process, they can be evaluated by employees more as challenges than hindrances (barriers). This approach can be interpreted with regard to the cognitive appraisal, the key term used in the transactional stress theory (Lazarus, 1991; Lazarus and Folkman, 1984). Cognitive primary appraisal determines whether a specific situation (e.g. a job demand) is perceived as a challenge or a hindrance. Despite the fact that challenge stressors require personal effort and induce strain, individuals can anticipate that they have necessary skills to deal with them, which, in consequence, makes challenges positively related to work performance (in this study to learning). In contrast, hindrance stressors produce an adverse effect because individuals do not have a sufficient ability to deal with the barriers (LePine et al., 2005).

The notion that intercultural interactions introduce "stimulating anxiety", as stated in one interview, can be referred to cognitive dissonance theory and Piaget's theory of cognitive development. These theories posit that novel and/or discrepant with one's worldviews experiences provide the chance of cognitive growth or lead to actions aimed at reducing discrepancy (Maertz et al., 2009). In such a case, people "must either find a way to reconcile this novel interaction with their current beliefs and conceptions, or they must change their views to incorporate this new information" (Bowman and Brandenberger, 2012, p. 181). Thus, people who are in a state of cognitive dissonance may change their beliefs to fit with their new experiences, which includes learning.

The fact that the participants were aware of the impact of organizational and personal resources on their ability to manage differences can be further interpreted in accordance with social cognitive theory (Bandura, 2001). It states that personal agency functions within a broad network of social interactions. The agentic transactions involve individuals as producers and products of social systems. They are compelled to be agents and learn in intercultural interactions since they are more demanding than common social interactions.

Figure 1 presents the grounded theory that emerged from the field data of this study with its connections to the existing theories.

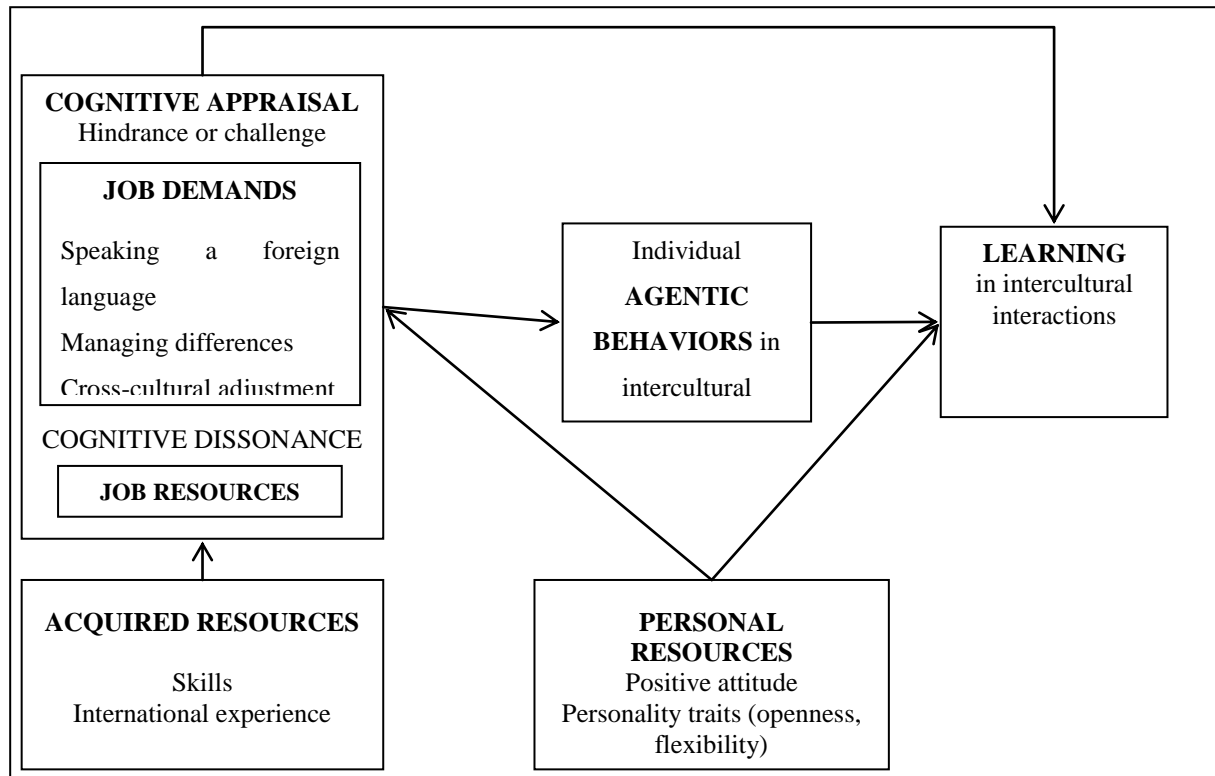

Figure 6. *Employee learning in intercultural interactions*

## CONCLUSIONS

The study extends the literature on employee learning and cultural diversity since it revealed that specific job demands in MNCs, such as the necessity to use functional language, to manage the differences and to adjust to them, can be acknowledged as the *antecedents* of employee learning, whereas organizational, personal and acquired resources can support the process as they impact on intercultural interactions. The paper emphasizes a positive approach to cultural diversity in organizations via documenting such a positive outcome as learning. It augments the knowledge of the role of intercultural interactions, as a peculiar type of social interactions, in a learning process.

The study allows for formulating some *practical implications*. Namely, the findings indicate that, owing to learning potential embedded in multicultural work settings, managers need to invest in development of organizational and individual resources (personal and acquired ones) to foster learning in intercultural interactions. Moreover, managers of MNCs should recruit employees whose need for growth is well-developed since those individuals can benefit more from multicultural work settings.

The study *shortcomings* are as follows. First and foremost, the applied qualitative methodology does not enable a generalization of the findings. Although the sample size was sufficient for the grounded theory approach, it was limited in terms of proposing any general theory of employee learning in

intercultural interactions. Nonetheless, the study indicates certain directions for *future research*. For instance, the obtained results could be further tested on a larger sample in quantitative studies. Moreover, a focus on job resources in future research might help to explain the role of organization in fostering individual learning in intercultural contacts. Finally, employee learning in social interactions in other types of organizations could be separately explored in future studies to deepen the understanding of social aspects of learning and to compare the results with the current research.

To sum up, *the organizational antecedents* such as job demands and job resources, and *the individual antecedents*, such as personal and acquired resources, can foster learning in MNCs that is triggered by cognitive dissonance experienced while interacting with culturally diverse others. The research posits that due to learning embedded in MNCs' settings these companies can be an attractive workplace for people seeking to grow.

## ACKNOWLEDGMENTS

The study was financially supported by National Science Centre in Poland (the research grant no. DEC-2013/09/B/HS4/00498).

## REFERENCES

- Abdul Malek, M. and Budhwar, P. (2013), "Cultural intelligence as a predictor of expatriate adjustment and performance in Malaysia", *Journal of World Business*, Elsevier Inc., Vol. 48 No. 2, pp. 222–231.
- Ambos, T.C., Ambos, B. and Schlegelmilch, B.B. (2006), "Learning from foreign subsidiaries: An empirical investigation of headquarters' benefits from reverse knowledge transfers", *International Business Review*, Vol. 15 No. 3, pp. 294–312.
- Antonacopoulou, E.P. and Gabriel, Y. (2006), "Emotion, learning and organizational change", *Journal of Organizational Change Management*, Vol. 14 No. 5, pp. 435–451.
- Bandura, A. (2001), "Social cognitive theory: An agentic perspective", *Annual Review of Psychology*, Vol. 52 No. 1, pp. 1–26.
- Bartel-Radic, A. (2006), "Intercultural learning in global teams", *Management International Review*, Vol. 46 No. October 2003, pp. 647–677.
- Basinska, B.A. (2017), "Thriving in a multicultural workplace", in Rozkwitalska, M., Sułkowski, Ł. and Magala, S. (Eds.), *Intercultural Interactions in the Multicultural Workplace. Traditional and Positive Organizational Scholarship*, Contributi., Springer International Publishing, Switzerland, available at: [https://doi.org/DOI.10.1007/978-3-319-39771-9\\_8](https://doi.org/DOI.10.1007/978-3-319-39771-9_8).
- Boateng, R. (2011), "Do organizations learn when employees learn: the link between individual and organizational learning", *Development and Learning in Organizations*, Vol. 25 No. 6, pp. 6–9.
- Bowman, N. A. and Brandenberger, J.W. (2012), "Experiencing the unexpected: Toward a model of college diversity experiences and attitude change", *The Review of Higher Education*, Vol. 35 No. 2, pp. 179–205.
- Carmeli, A., Brueller, D. and Dutton, J.E. (2009), "Learning behaviours in the workplace: The role of high-quality interpersonal relationships and psychological safety", *Systems Research and Behavioral Science*, Vol. 98 No. November 2008, pp. 81–98.
- Collings, D.G., Scullion, H. and Morley, M.J. (2007), "Changing patterns of global staffing in the multinational enterprise: Challenges to the conventional expatriate assignment and emerging alternatives", *Journal of World Business*, Vol. 42 No. 2, pp. 198–213.
- Corbin, J. and Strauss, A.L. (2008), *Basics of Qualitative Research*, 3rd ed., Sage Publications, Thousand Oaks, CA.



- Davidson, M.N. and James, E.H. (2009), "The engines of positive relationships across difference: conflict and learning", in Dutton, J.E. and Ragins, B.R. (Eds.), *Exploring Positive Relationships at Work. Building a Theoretical and Research Foundation*, Psychology Press, New York, London, pp. 137–158.
- Dearnley, C. (2005), "A reflection on the use of semi-structured interviews.", *Nurse Researcher*, Vol. 13 No. 1, pp. 19–28.
- Engelhard, J. and Nägele, J. (2003), "Organizational learning in subsidiaries of multinational companies in Russia", *Journal of World Business*, Vol. 38 No. 3, pp. 262–277.
- Gertsen, M.C. and Söderberg, A.M. (2010), "Expatriate stories about cultural encounters - A narrative approach to cultural learning processes in multinational companies", *Scandinavian Journal of Management*, Elsevier Ltd, Vol. 26 No. 3, pp. 248–257.
- Glaser, B.G. and Strauss, A.L. (1999), *The Discovery of Grounded Theory: Strategies for Qualitative Research*, Aldine De Gruyter, Hawthorne, NY.
- Goulding, C. (1998), "Grounded theory: the missing methodology on the interpretivist agenda", *Qualitative Market Research: An International Journal*, Vol. 1 No. 1, pp. 50–57.
- Groepel-Klein, A., Germelmann, C.C. and Glaum, M. (2010), "Intercultural interaction needs more than mere exposure: Searching for drivers of student interaction at border universities", *International Journal of Intercultural Relations*, Elsevier Ltd, Vol. 34 No. 3, pp. 253–267.
- Harvey, M., Hartnell, C. and Novicevic, M. (2004), "The inpatriation of foreign healthcare workers: A potential remedy for the chronic shortage of professional staff", *International Journal of Intercultural Relations*, Vol. 28, pp. 127–150.
- Hassi, A., Storti, G. and Azennoud, A. (2011), "Corporate trainers' credibility and cultural values: evidence from Canada and Morocco", *Cross Cultural Management: An International Journal*, Vol. 18 No. 4, pp. 499–519.
- Jarvis, P. (2009), "Learning to be a person in society: learning to be me", in Illeris, K. (Ed.), *Contemporary Theories of Learning. Learning Theorists ... in Their Own Words*, Routledge, Taylor & Francis Group, New York, pp. 21–34.
- Kohlbacher, F. and Kra, M.O.B. (2007), "Knowledge creation and transfer in a cross-cultural context – empirical evidence from Tyco Flow Control", *Knowledge and Process Management*, Vol. 14 No. 3, pp. 169–181.
- Lauring, J. (2009), "Managing cultural diversity and the process of knowledge sharing: A case from Denmark", *Scandinavian Journal of Management*, Vol. 25 No. 4, pp. 385–394.
- Lazarus, R. (1991), "Cognition and motivation in emotion.", *American Psychologist*, Vol. 46 No. 4, pp. 352–367.
- Lazarus, R. and Folkman, S. (1984), *Stress, Appraisal, and Coping*, Springer, New York.
- LePine, J., Podsakoff, N. and LePine, M. (2005), "A meta-analytic test of the challenge stressor–hindrance stressor framework: An explanation for inconsistent relationships among stressors and performance", *Academy of Management Journal*, Vol. 48 No. 5, pp. 764–775.
- Maertz, C.P., Hassan, A. and Magnusson, P. (2009), "When learning is not enough: A process model of expatriate adjustment as cultural cognitive dissonance reduction", *Organizational Behavior and Human Decision Processes*, Elsevier Inc., Vol. 108 No. 1, pp. 66–78.
- Mäkelä, K., Andersson, U. and Seppälä, T. (2012), "Interpersonal similarity and knowledge sharing within multinational organizations", *International Business Review*, Vol. 21, pp. 439–451.
- Maxwell, J.A. (2005), *Qualitative Research Design: An Interactive Approach*, Sage Publications, Thousand Oaks, CA.
- Minbaeva, D., Pedersen, T., Björkman, I., Fey, C.F. and Park, H.J. (2003), "MNC knowledge transfer, subsidiary absorptive capacity, and HRM", *Journal of International Business Studies*, Vol. 34 No. 6, pp. 586–599.
- Molinsky, A. (2007), "Cross-cultural code-switching: the psychological challenges of adapting behavior in foreign cultural interactions", *Academy of Management Review*, Vol. 32 No. 2, pp. 622–640.
- Nolan, S. (2012), "Global mobility of human capital increasingly important", *Strategic HR Review*, Vol. 11 No. 3.
- Puck, J.F., Mohr, A.T. and Rygl, D. (2008), "An empirical analysis of managers' adjustment to working in multinational project teams in the pipeline and plant construction sector", *The International Journal of Human Resource Management*, Vol. 19 No. 12, pp. 2252–2267.
- Randall, W.S. and Mello, J.E. (2012), "Grounded theory: an inductive method for supply chain research", edited by Flint, D. *International Journal of Physical Distribution & Logistics Management*, Vol. 42 No. 8/9, pp. 863–880.
- Rozkwitalska, M. and Basinska, B.A. (2015), "Thriving in multicultural work settings", in Vrontis, D., Weber, Y. and Tsoukatos, E. (Eds.), *Conference Readings Book Proceedings. Innovation, Entrepreneurship and Sustainable Value Chain in a Dynamic Environment*, EuroMed Press, September 16-18, 2015, Verona, pp. 1897–1910.
- Rozkwitalska, M. and Basinska, B.A. (2016), "Positive psychological capital enhances thriving in the multicultural work environment of multinational corporations", in Vrontis, D., Weber, Y. and Tsoukatos, E. (Eds.), *Innovation, Entrepreneurship and Digital Ecosystems*, EuroMed Press, Warsaw, pp. 1565–1576.

- Samnani, A.-K., Boekhorst, J.A. and Harrison, J.A. (2012), "Acculturation strategy and individual outcomes: Cultural diversity implications for human resource management", *Human Resource Management Review*, Elsevier Inc., Vol. 22 No. 4, pp. 323–335.
- Stahl, G.K., Mäkelä, K., Zander, L. and Maznevski, M.L. (2010), "A look at the bright side of multicultural team diversity", *Scandinavian Journal of Management*, Vol. 26 No. 4, pp. 439–447.
- Stahl, G.K. and Tung, R.L. (2014), "Towards a more balanced treatment of culture in international business studies: The need for positive cross-cultural scholarship", *Journal of International Business Studies*, pp. 1–24.
- Suutari, V. and Mäkelä, K. (2007), "The career capital of managers with global careers", *Journal of Managerial Psychology*, Vol. 22 No. 7, pp. 628–648.
- Tanova, C. and Nadiri, H. (2010), "The role of cultural context in direct communication", *Baltic Journal of Management*, Vol. 5 No. 2, pp. 185–196.
- van Veen, K., Sahib, P.R. and Aangeenbrug, E. (2014), "Where do international board members come from? Country-level antecedents of international board member selection in European boards", *International Business Review*, Elsevier Ltd, Vol. 23 No. 2, pp. 407–417.
- Zhang, Y. and Wildemuth, B.M. (2009), "Qualitative analysis of content", in Wildemuth, B. (Ed.), *Applications of Social Research Methods to Questions in Information and Library Science*, Libraries Unlimited, Westport, CT, pp. 308–319.

## THE MEDIATING EFFECT OF INNOVATION ON THE RELATIONSHIP BETWEEN INTANGIBLE RESOURCES AND EXPORT PERFORMANCE

Rua, Orlando Lima<sup>1</sup>; França, Alexandra<sup>2</sup>

<sup>1</sup>Applied Management Research Unit (UNIAG); Polytechnic of Porto/ISCAP/CEOS.PP, Porto, Portugal

<sup>2</sup>School of Economics and Management, University of Minho, Braga, Portugal

### ABSTRACT

This paper develops a framework to test the relationship between intangible resources and export performance, considering the mediating effect of innovation.

Based on survey data from Portuguese small and medium-sized enterprises (SMEs) exporting footwear findings suggest that: (1) innovation has a direct and positive influence on export performance; and (2) innovation does have a mediating effect on the relationship between intangible resources and export performance.

This study deepens our understanding and provides novel insights into strategic management literature, since it combines multiple factors and has obtained the importance of each construct in SMEs business growth.

*Keywords: intangible resources, export performance, absorptive capacities, innovation, PLS-SEM.*

### INTRODUCTION

As the importance of internationalization grows for many firms around the globe, there is an increasing interest in the strategic determinants that predict export performance. Consequently, research on export performance has developed exponentially. This increase interest of the academia is due to the various macro and micro-level benefits associated with export development. At the macro-level, superior export performance is a cost-effective vehicle for economic growth, employment creation and a general improvement in living standards. There are countless benefits at firm-level that includes opportunities for growth, worldwide market share, better margins and risk diversification (Kahiya and Dean, 2014).

Strategic management has focused on firms' intangible resources and this has attracted considerable interest among academics and practitioners (Barney, 1991). Particularly, scholars have focused a great deal of attention on a subclass of intangible assets that is called "social approval assets", because they develop their value from favorable collective perceptions (Pfarrer, Pollock, & Rindova, 2010).

Innovation, as a process of generating new ideas, will prevent firms' stagnation and give their products and services competitive advantage by allowing to define direction and business strategy to adopt (Abrar et al., 2009). Moreover, innovation can support a strategic posture and the willingness and ability to question (or leave) existing circumstances, thus creating space for creativity, new ideas and experiences (Frank, Kessler, & Fink, 2010). Regardless of the sort of innovation adopted, the most innovative firms tend to overcome unstable situations, and is thus considered the most important dimension in the context of entrepreneurial orientation, as it determines the means by which organizations can achieve competitive advantage and promote its growth (Dess & Lumpkin, 2005).

SMEs are increasingly confronted by challenges and opportunities in international markets. Together with large corporations, smaller firms are among the key players in international trade. Smaller firms that belong to traditional (low-tech and labor-intensive) industries can find here opportunity for growth or challenge their survival. In fact, they are particularly vulnerable to global competition, particularly from players located in low-labor-cost economies. In order to achieve competitiveness in this context, smaller firms need to develop unique, firm-specific assets (Zucchella and Siano, 2014).

Literature on export performance is extensive but arguably it has not yet achieved the consensus required to prescribe exporting strategies to small firm (Casey and Hamilton, 2014). Moreover, factors that set off SME growth (including exporting) are still in need of research (Stouraitis, Harris, Harun and Kyritsis, 2017). So, the purpose of this paper is to broad the boundaries of strategic management literature and test the following general hypotheses — *does intangible resources positively influence small business export performance? Additionally does innovation mediates this relationship?*

## THEORETICAL FRAMEWORK

### *Intangible resources*

Resources and capabilities are a set of tangible and intangible assets that can be used by firms to help choose and implement strategies (Barney, Ketchen, & Wright, 2011). There is a consensus in the literature that the sources of competitive advantage are more associated to intangible resources than with the tangible ones. In addition, the tangible assets tend to depreciate over the time, while intangible assets may accumulate value over time (Porter, 1991).

Scholars argue that resources form the basis of firm strategies (Barney, 1991). Therefore, firm resources and strategy cooperate to create positive returns. Firms employ both tangible resources (such as physical infrastructures and financial resources) and intangible resources (like knowledge and brand equity) in the development and implementation of strategies. However, intangible resources are more likely than tangible resources to produce a competitive advantage, since they are often rare and

socially complex, thereby making them difficult to imitate (Hitt, Bierman, Shimizu and Kochhar, 2001). Thus, intangible resources are considered strategic resources (Amit and Schoemaker, 1993).

Intangibles resources have three intrinsic characteristics that distinguish them from tangible resources (Molloy, Chadwick, Ployhart and Golden, 2011). First, intangibles do not deteriorate with use, since these resources are expected to confer benefits for an indeterminate period of time (Cohen, 2005). Secondly, multiple managers can use the intangibles resources simultaneously, for example, the use of a brand is available for all managers. Finally, the intangibles resources are immaterial, making them difficult to exchange, as they often cannot be separated from its' owner (Marr and Roos, 2005).

The existing literature suggests six types of resources that are particularly important sources of export venture competitive advantage: reputational resources; access to financial resources; human resources; cultural resources; relational resources; and, informational resources (Morgan, Vorhies and Schlegelmilch, 2006).

#### *Innovation*

Innovation refers to the support and encouragement to new ideas, experimentation and creativity that will lead to new products, services and processes. Any form of innovation involves a series of efforts, such as: technological innovation involves a research and engineering effort, focused on the development of new products and processes; product innovation includes market research, design, and the focus on advertising and promotion; administrative innovation refers to the development of management systems, control techniques and organizational structure. Thus, innovation reflects the trend that an organization has to participate and support new ideas, innovations, processes, experimental and creative, which may result in new products, services or processes (Lumpkin & Dess, 1996). Thus, innovation reflete a tendência que uma organização tem para participar e apoiar novas ideias, novidades, processos experimentais e criativos que possam resultar em novos produtos, serviços ou processos (Lumpkin & Dess, 1996), being that the adoption of new innovations can generate competitive advantage and can promote a greater source of growth (Dess & Lumpkin, 2005).

Innovation can occur throughout a long process, a new product line, a new announcement or a new technological advance (Lumpkin & Dess, 1996). On one hand, there are several ways to identify the degree of innovation of companies, such as the quantity of financial resources invested in innovation, human resources devoted to innovation activities, number of new products or services launched on the market or frequency of change in product lines or services. On the other hand, the financial resources invested in innovation and the level of commitment of human resources with the innovative activities will dictate the degree of innovation in an organization (Covin and Slevin, 1989).

While it is true that all types of innovations involve a lot of efforts, be it in technology, management, products or markets, the most innovative firms tend to overcome unstable situations and, in this way, there is a consensus that this dimension is the most important in the context of entrepreneurial orientation, as it determines the means by which firms achieve competitive advantage and growth (Dess & Lumpkin, 2005).

#### *Export performance*

The use of efficient worldwide communications technology and transportation, the decrease in governments' protectionist policies, and the decrease of geographically protected markets have made it possible, and necessary, for many firms to view their operating domains as global (Gil-Pechuan, Exposito-Langa and Tomas-Miquel, 2013). Moreover, small countries with constricted domestic markets depend on the success of small firms who can export successfully and grow to a scale beyond that which their home market could support (Casey and Hamilton, 2014).

Exporting is an early phase in the internationalisation model established by Johanson and Vahlne (1977, 2009), grounded on the assumption that new exporters can gradually engage with foreign markets, depending their exploitation strategy on knowledge and other resources. This export research, however, was not pertinent for small exporters (Casey and Hamilton, 2014), since its unit of analysis was large firms.

In a fairly recent literature review, Sousa, Martínez-López and Coelho (2008) conclude that, along with internal capabilities and competencies, the main determinants of export performance are firm size and international experience. Actually, internationalization processes have mainly been studied with reference to multinational corporations and less for SMEs, because smallness is usually considered a problem, as these firms often have a disadvantage in resource access (Musso and Francioni, 2014). This, however, does not support small firm managers in search of a growth strategy through exporting.

Conversely, the number of small firms operating in international markets has increased and represents the majority of firms in most countries, and therefore, they play an important role in the economic growth of their countries. As a consequence, the internationalization process of SMEs has become a topic of academic and governmental attention (Musso and Francioni, 2014).

Hence, the development of exports is of great importance, both at macro and micro levels. Exporting contributes to economic and social development of nations, helps the industry progress, increases productivity and creates jobs. At firms' level, through market diversification, exports provide an opportunity for them to become less dependent on the domestic market, gaining new customers,

exploiting economies of scale and achieving lower production costs while producing more efficiently (Okpara, 2009).

Exports is a more attractive way to enter international markets, especially for SMEs, in comparison with other alternatives, such as joint ventures, which involve spending a large number of resources (Dhanaraj and Beamish, 2003; Fuchs and Köstner, 2016; Piercy, Kaleka and Katsikeas, 1998), does not create high risk and commitment and allows greater flexibility in adjusting the volume of goods to different export markets (Lu and Beamish, 2002).

On one hand, export activity fulfils certain business goals, which may be economic (such as increasing profits and sales) and / or strategic (such as diversification of markets, gaining market share and increasing brand reputation) (Cavusgil and Zou, 1994).

On the other hand, export motivation may result from proactive or reactive actions. For example, proactive actions are advantage of profit, introduction of a single product, technological advantage, exclusive information, commitment of management, tax benefits and economies of scale. Reactive motivations are identifying competitive pressures, excess production capacity, sales decrease or saturation in the domestic market and proximity of customers and landing ports (Stouraitis et al., 2017; Wood & Robertson, 1997).

#### *Hypotheses Derivation*

The literature suggests that resources and capabilities are related to each other (Dhanaraj & Beamish, 2003; Morgan, Kaleka, & Katsikeas, 2004). Integration, reconfiguration and learning resources only become significant when resources are abundant (Wu & Wang, 2007), thus improving firms' dynamic capabilities. Moreover, innovation is an ability that can attract the necessary resources to exploit opportunities (Alvarez & Busenitz, 2001). These resources can thus promote, support and facilitate innovation, allowing firms to innovate and prosper, contributing to the construction of healthy and enduring business (Miller, Wright, Le Breton-Miller, & Scholes, 2015). The benefits of innovation may result in the development of products and processes that occurs in multiple stages (multi-stage process), requiring a complete set of resources for an innovative firm (Teece et al., 1997). Barney (1991) highlights resources as assets, capabilities, organizational processes, firm attributes, information and knowledge, which, according to this author, are valuable, rare, imperfectly imitable and non-substitutable (VRIN).

The resource-based perspective conceptualizes innovation as a complex and dynamic process (Zhang et al., 2016) through which firms consistently develop innovation capabilities by exploring new resources or new combinations of resources (e.g. Galunic and Rodan, 1998; Mahoney and Pandian, 1992; Teece et al., 1997).

*H1: Intangible resources influence positively innovation.*

The RBV posits that variations in firms' performance result from the possession of heterogeneous resources. This heterogeneity of resources and capabilities leads to performance imbalances and affects firms' ability to design and implement competitive strategies (Barney, 1991; Peteraf, 1993). Thus, this theory suggests that heterogeneous resources and capabilities have a direct effect on firms' performance (Makadok, 2001; Teece et al., 1997). Thus, we tested the following hypothesis:

*H2: Intangible resources influence positively export performance.*

Zahra and Garvis (2000) believe that innovation is important for organizational success both to local and foreign markets. According to these authors, success in the global market requires creativity and risk-taking. Literature suggests that innovation has a positive influence in business performance (Wiklund and Shepherd, 2005), since it increases firms' engagement to, for example, create new products and services, seek new opportunities and new markets (Lumpkin and Dess, 1996; Miller, 1983). In this sense, innovative firms have an extraordinary performance and can even be seen as a country's engine of economic growth (Schumpeter, 1934). Thus, these firms can control markets by mastering distribution channels and building brand recognition. Hence, we intended to confirm this relationship and test the following working hypothesis:

*H3. Innovation influences positively export performance.*

Innovation is the ability to simultaneously pursue both exploration and exploitation, efficiency and flexibility, or alignment and adaptability (De Clercq, Thongpapanl, & Dimov, 2013). Innovation requires different strategic orientations, technological resources and processes. Innovation provides a mechanism to effectively manage change by repeatedly pursue and achieve both disruptive and incremental innovation (Andriopoulos & Lewis, 2009; Jansen et al., 2009).

This research posits one hypothesis regarding the mediating effect of innovation in the relationship between intangible resources and export performance. The significance of the mediating effect of the variables was assessed by Aroian test (Baron & Kenny, 1986). This test is used to determine whether the indirect effect of the independent variable on the dependent variable via the mediator is significantly different from zero (Aroian, 1947). Thus we propose:

*H4. Innovation mediates the relationship between intangible resources and export performance.*

## **METHODOLOGY**



*Setting and data collection*

To test the hypothesis a sample of Portuguese SMEs exporting footwear was used, that meet the following criteria: companies in which at least 50% of income comes from exports of goods, or companies in which at least 10% of income comes from exports of goods and the export value is higher than 150.000 Euros (INE, 2011).

The population of this empirical study has been drawn from Portuguese footwear industry firms. Questionnaires were used as primary data sources and were carried out over the period of April 22 to July 22, 2014. The identification of companies was done through the Portuguese Footwear, Components and Leather Goods Association (APICCAPS) database. To reduce misunderstandings, the questionnaire was validated by the research department of APICCAPS. So, in this study we use a non-probabilistic and convenient sampling.

A total of 42 complete and validated questionnaires accounting for 25 % per cent of the population were obtained. This response rate is considered quite satisfactory, given that the average of top management survey response rates are in the range of 15%-20% (Menon and Bharadwaj, 1999).

*Measures*

This study uses well-validated scales from previous studies to operationalize the key constructs and adapted them to the particular context of our empirical setting.

Independent variables – Following Morgan et al. (2006), in the intangible resources construct we included six dimensions: reputational resources; access to financial resources; human resources; cultural resources; relational resources; and informational (knowledge) resources.

Mediators - To assess Innovation we adopted Covin and Slevin's (1989) measurements.

Dependent variable - Performance is a construct that is difficult to operationalize holistically, since it may refer to different aspects of the organizational effectiveness (Gil-Pechuan et al., 2013). The decision-makers were asked to assess the relative position of their firm vis-à-vis their competitors. All constructs were assessed on a five-point Likert scale.

**RESULTS**

The structural equation model is a multiple regression analysis, with reflective indicators that are presented as an image of the unobserved theoretical construct, representing observed variables or measures, with the objective of strengthening the relationship of influence between the constructs (Marôco, 2011). The simple correlation between these indicators with their construct must have a value equal to or higher than 0.707 so that the shared variance between the construct and their indicators is higher than the error variance (Carmines and Zeller, 1979).

*Partial Least Squares (PLS)* is a technique that best fits predictive applications (exploratory analysis) and theory development when it is not soundly established (Cepeda and Roldán, 2014). This technique, on one hand, maximize the explained variance of the dependent variables (latent or observed, or both) and estimate structural models with small samples (Chin and Newsted, 1999; Reinartz, Haenlein and Henseler, 2009). On the other hand, it estimates reflective and formative measurement models without identification problems (Chin, 2010). PLS appear to be a preferable option for researchers with samples below 250 observations (42 in this study) (Reinartz et al., 2009).

In order to verify the reliability of overall variables we estimated the stability and internal consistency through Cronbach's alpha ( $\alpha$ ). Generally, an instrument or test is classified with appropriate reliability when  $\alpha$  is higher or equal to 0.70 (Nunnally, 1978; Chin, 2010). The result of 0.958 achieved for all variables is considered excellent, confirming the sample's internal consistency (Pestana and Gageiro, 2008). Table 1 show all constructs largely achieved the required level.

Table 1 - Cronbach's alpha

Construct	Cronbach Alpha	p values
IR	.964	.000
INOV	.825	.000
EP	.929	.000

We also use the composite reliability coefficient to assess construct validity (Chin, 1998). This coefficient reflects construct adequacy for a level higher than 0.6 using confirmatory factor analysis (Gefen and Straub, 2005), as in our case. Table 2 illustrates that the studied constructs (all multidimensional) highly exceeded the minimum required for a good fit.

Table 2 - Composite reliability coefficient of multidimensional variables

Construct	Composite reliability	R2	p values
IR	.967	-	.000
INOV	.895	.276	.000
EP	.946	.472	.000

For validity assessment, two subtypes are usually examined: convergent and discriminant validity. Convergent validity implies that a set of indicators represents one and the same underlying construct (Henseler et al., 2009). Fornell and Larcker (1981) suggest using the Average Variance Extracted (AVE) criterion and that an AVE value of at least 0.5 indicates sufficient convergent validity. Next table demonstrates that only absorptive capacity is slightly below the minimum required.

Table 3 - Convergent validity

Construct	AVE	p values
IR	.563	.000
INOV	.739	.000
EP	.779	.000

Discriminant validity is the degree to which any single construct is different from the other constructs in the model. To have discriminant validity a construct must exhibit weak correlations with other

latent variables that measure different phenomena. There are two measures of discriminant validity in PLS. The Fornell–Larcker criterion (1981) recommends that the AVE should be greater than the variance between a given construct and the other with which it shares the model. The second criterion suggests that the loading of each indicator is expected to be greater than all of its cross-loadings (Henseler et al., 2009).

We can observe the explanatory power of each variable in the model. Entrepreneurial orientation is the only purely explanatory variable and reputational resources and absorptive capacity of knowledge exploitation the explained variables. Chin (1998) distinguishes the explanatory power from moderate to substantial. Table 4 expresses the good results in terms of discriminant validity of the research model, confirming that constructs do differ significantly.

Table 4 - Discriminant validity

Fornell-Larcker Criterion	EP	INOV	IR
EP	.882		
INOV	.516	.860	
IR	.478	.407	.750

In order to determine the significance of the studied relationships and the confidence intervals of the path coefficients, we used bootstrapping technique. The weighted coefficients indicate the relative strength of each exogenous construct. According to Chin (1998), relationships between constructs, with structural coefficients higher than 0.2, are considered robust. From table 5, we thus conclude that the original model does not present non-significant paths.

Table 5 – Effects

Path	Original Sample (O)	Sample Mean (M)	Standard Error (STERR)	T Statistics ( O/STERR )	p values
IR --> +INOV					
Direct effects	.140	.148	.200	.697	n.s.
Indirect effects	.267	.290	.137	1.956	.050
Total effects	.407	.437	.114	3.577	.000
IR --> +EP					
Direct effects	.083	.054	.133	.624	n.s.
Indirect effects	.395	.439	.115	3.431	.001
Total effects	.478	.493	.106	4.495	.000
INOV --> +EP					
Direct effects	.236	.218	.116	2.034	.042**
Indirect effects	-	-	-	-	-
Total effects	.236	.218	.116	2.034	.042**

n.s. – non-significant;  $p < .001$ ; \*\* $p < .05$ .

The significance of structural coefficients and the magnitude of the total effects enabled us to test the research hypotheses, having registered the following results:

H1. IR --> INOV – Not supported;

H2. IR --> EP – Not supported;

H3. INOV --> EP – Supported.

H4. IR --> INOV --> EP – Supported.

## DISCUSSION AND CONCLUSIONS

This study allowed us to conclude that innovation has a mediating effect on the relation between intangible resources and export performance. Our findings confirm that indeed resources and capabilities are related to each other, supporting the studies of Dhanaraj and Beamish (2013) and Morgan et al. (2004). Conversely, results do not support Teece et al. (1997) and Teece (2007), since these authors claim that innovation requires not only the property of intangible resources, but also its exploration.

Success in the global market requires creativity, ingenuity and risk taking, both in domestic markets and in foreign ventures (Zahra and Garvis, 2000). The literature suggests that innovation has a positive and direct influence in business performance (Damanpour, Szabat, & Evan, 1989; Han, Kim and Srivastava, 1998). Our findings support this statement. Indeed, innovative firms have an extraordinary performance and can even be seen as a country's engine of economic growth (Schumpeter, 1934).

### *Theoretical and practical implications*

Theoretically, this study contributes to the literature of intangible resources that leverage firm performance, when mediated by innovation (e.g. (Cabral et al., 2015; Damanpour et al., 1989; Han et al., 1998). We also highlight the contribution of this study to the theory of strategic management. It is known that strategy includes deliberate and emergent initiatives adopted by management, comprising resource and capabilities used to improve business performance (Nag, Hambrick and Chen, 2007). In order to remain competitive, firms must assess which strategic determinants give them an advantage over their competitors. The findings are a contribution to clarify the influence of innovation, intangible resources and absorptive capabilities in small firms export performance.

In addition, the results provide guidance to business practitioners; since they indicate intangible resources and innovation as predictors for export performance. Firms are a bundle of resources and capabilities (Peteraf, 1993), it is essential to understand and identify which resources are relevant to gain competitive advantage and superior performance. Business managers must be able to systematically analyse the changes that arise in their target market(s) and to identify the present and future needs and market trends, anticipate changes in demand and seek new business opportunities.

*Research limitations*

While this research provides valuable insights into SMEs in the footwear industry, the study is not without its limitations. First, the main limitation of this study is related to the sample size, since it was difficult to find companies with the willingness to collaborate in this type of research. Second, it would have been interesting to control our analysis. The fact that the research does not consider the effect of control variables such as age, location and target market of the respondents can be seen as a limitation. Third we used an online study to collect our data. While electronic data collection methods are becoming more common, strategies to encourage a greater response rate are lacking compared to other survey implementation methods. Finally, the fact that the sampling is non probabilistic and convenience is a limitation. Therefore we advise prudence in the generalization of results.

*Future lines of research*

Firstly, in future work, we suggest that the model is used in a sample with a higher number of observations to confirm these results. Second, this study has been based on a mature sector, as is the footwear sector in Portugal. The results obtained should be understood in this context. For this reason, new research could be done in more modern industries to test again the proposed relations. Third, given the irregular nature of business growth, a snapshot survey may not be able to capture strategy and performance variations over long periods of time. As such, further studies with a longitudinal perspective would be of added value to investigate why these differences persist. In other words, to find how and why some small exporters become highly successful while others, in the same industry, struggle to raise their export strengths. Finally, the moderating effect of other variables (e.g. competitive advantage, dynamic capabilities, environment hostility) should be studied.

**ACKNOWLEDGMENTS**

UNIAG, R&D unit funded by the FCT – Portuguese Foundation for the Development of Science and Technology, Ministry of Science, Technology and Higher Education

This work is funded by national funds through the FCT – Foundation for the Development of Science and Technology, I.P., in the framework of the project «UID/GES/04752/2016».

**REFERENCES**

- Andriopoulos, C., & Lewis, M.W. (2009). Exploitation-exploration tensions and organizational ambidexterity: Managing paradoxes of innovation. *Organization Science*, 20(4), 696–717.
- Amit, R., & Schoemaker, P. (1993). Strategic assets and organizational rent. *Strategic Management Journal*, 14(1), 33–46.
- APICCAPS. (2013). *Footure - Plano Estratégico - Cluster do Calçado (APICCAPS)*.

- Aroian, L. A. (1947). The probability function of the product of two normally distributed variables. *The Annals of Mathematical Statistics*, 18(2), 265-271.
- Barney, J. (1991). Firm Resources and Sustained Competitive Advantage. *Journal of Management*, 17(1), 99–120.
- Barney, J., Ketchen, D. J., & Wright, M. (2011). The Future of Resource-Based Theory: Revitalization or Decline? *Journal of Management*, 37(5), 1299–1315.
- Baron R. M., & Kenny, D. A. (1986). The moderator-mediator variable distinction in social psychological research: conceptual, strategic, and statistical considerations. *Journal of Personality and Social Psychology*, 51(6), 1173-1182.
- Cabral, J. E. O., Coelho, A. F. M., Coelho, F. J. F., & Costa, M. da P. B. (2015). Capabilities, innovation, and overall performance in Brazilian export firms. *RAM, Rev. Adm. Mackenzie*, 16(3), 76–108.
- Carmines, E. G., & Zeller, R. A. (1979). *Reliability and Validity Assessment*. Newbury Park, CA: Sage Publications.
- Casey, S. R., & Hamilton, R. T. (2014). Export performance of small firms from small countries: The case of New Zealand. *Journal of International Entrepreneurship*, 12(3), 254–269.
- Cavusgil, T., & Zou, S. (1994). Marketing strategy-performance relationship: an investigation of the empirical link in export market ventures. *Journal of Marketing*, 58(1), 1–21.
- Cepeda, G., & Roldán, J. L. (2004). Aplicando en la práctica la técnica PLS en la Administración de Empresas. XIV Congreso Nacional ACEDE, 74-78.
- HART, C., & Chen, J. (2013). Breakthrough innovation: The roles of dynamic innovation capabilities and open innovation activities. *Journal of Business and Industrial Marketing*, 28(5), 444–454.
- Chin, W. W. (1998). *The Partial Least Squares Approach to Structural Equation Modelling*. Lawrence Erlbaum Associates, Publisher. Mahwah, New Jersey. London.
- Chin, W. W. (2010). How to write up and report PLS analyses. In V. Esposito Vinzi, W. W. Chin, J. Henseler & H. Wang (eds.), *Handbook of partial least squares: Concepts, methods and applications*, (pp. 655-690). Berlin, Germany: Springer-Verlag.
- Chin, W. W. & Newsted, P. R. (1999). Structural Equation Modeling Analysis with Small Samples Using Partial Least Squares. In R. Hoyle (ed.), *Statistical Strategies for Small Sample Research* (pp. 307-341). Thousand Oaks, CA: Sage Publications.
- Cohen, J. A. (2005). *Intangible Assets: Valuation and Economic Benefit*. Wiley.
- Covin, J., & Slevin, D. (1989). Strategic management of small firms in hostile and benign environments. *Strategic Management Journal*, 10(1), 75–87.
- Damanpour, F., Szabat, K. A., & Evan, W. M. (1989). The relationship between types of innovation and organizational performance. *Journal of Management Studies*, 26(6), 587–601.
- De Clercq, D., Thongpapanl, N. T., & Dimov, D. (2013). Shedding new light on the relationship between contextual ambidexterity and firm performance: An investigation of internal contingencies. *Technovation*, 33(4), 119–132.
- Dess, G., & Lumpkin, G. (2005). The role of entrepreneurial orientation in stimulating effective corporate entrepreneurship. *The Academy of Management Executive*, 19(1), 147–156.
- Dhanaraj, C., & Beamish, P. W. (2003). A Resource-Based Approach to the Study of Export Performance. *Journal of Small Business Management*, 41(3), 242–261.
- Fornell, C., & Larcker, D. F. (1981). Evaluating structural equation models with unobservable variables and measurement error. *Journal of Marketing Research*, 18(1), 39-50.
- Frank, H., Kessler, A., & Fink, M. (2010). Entrepreneurial orientation and business performance—a replication study. *Schmalenbach Business Review*, (April), 175–199.
- Fuchs, M., & Köstner, M. (2016). Antecedents and consequences of firm's export marketing strategy: An empirical study of Austrian SMEs (a contingency perspective). *Management Research Review*, 39(3), 329–355.
- Galunic, D. C., & Rodan, S. (1998). Resource recombinations in the firm: Knowledge structures and the potential for Schumpeterian innovation. *Strategic Management Journal*, 19, 1193–1201.
- Gefen, D., & Straub, D. (2005). A Practical Guide To Factorial Validity Using PLS-Graph: Tutorial And Annotated Example. *Communications of the Association for Information Systems*, 16, 91-109.
- Gil-Pechuan, I., Exposito-Langa, M., & Tomas-Miquel, J. V. (2013). International entrepreneurship in SMEs: A study of influencing factors in the textile industry. *International Entrepreneurship and Management Journal*, 9(1), 45–57.
- Henseler, J., Ringle, C. M., & Sinkovics, R. R. (2009). The use of Partial Least Squares Path Modeling in international marketing. In R. R. Sinkovics & P. N. Ghauri (ed.), *New Challenges to International Marketing (Advances in International Marketing)*, 20 (pp. 277-319). Emerald Group Publishing Limited.

- Hitt, M., Bierman, L., Shimizu, K., & Kochhar, R. (2001). Direct and moderating effects of human capital on strategy and performance in professional service firms: A resource-based perspective. *Academy of Management Journal*, 44(1), 13–28.
- Johanson, J., & Vahlne, J.-E. (1977). The internationalization process of the firm—a model of knowledge development and increasing foreign market commitments. *Journal of International Business Studies*, 23–32.
- Johanson, J., & Vahlne, J.-E. (2009). The Uppsala internationalization process model revisited: From liability of foreignness to liability of outsidership. *Journal of International Business Studies*, 40(9), 1411–1431.
- Kahiya, E. T., & Dean, D. L. (2014). Export performance: multiple predictors and multiple measures approach. *Asia Pacific Journal of Marketing and Logistics*, 26(3), 378–407.
- Lumpkin, G., & Dess, G. (1996). Clarifying the entrepreneurial orientation construct and linking it to performance. *Academy of Management Review*, 21(1), 135–172.
- Mahoney, J. T., & Pandian, J. R. (1992). The resource-based view within the conversation of strategic management. *Strategic Management Journal*, 13(5), 360–380.
- Makadok, R. (2001). Toward a synthesis of the resource-based and dynamic-capability views of rent creation. *Strategic Management Journal*, 22(5), 387–401.
- Marôco, J. (2011). *Análise estatística com o SPSS Statistics (5ª)*. ReportNumber, Lda.
- Marr, B., & Roos, G. (2005). A strategy perspective on intellectual capital. In *Perspectives on intellectual capital* (pp. 28–52). Nova Iorque: Routledge.
- Menon, A., & Bharadwaj, S. (1999). Antecedents and consequences of marketing strategy making: A model and a test. *Journal of Marketing*, 63(April), 18–40.
- Miller, D. (1983). The correlates of entrepreneurship in three types of firms. *Management Science*, 29(7), 770–791.
- Miller, D., Wright, M., Le Breton-Miller, I., & Scholes, L. (2015). Resources and Innovation in Family Businesses. *California Management Review*, 58(1), 20–41.
- Molloy, J. C., Chadwick, C., Ployhart, R. E., & Golden, S. J. (2011). Making Intangibles “Tangible” in Tests of Resource-Based Theory: A Multidisciplinary Construct Validation Approach. *Journal of Management*, 37(5), 1496–1518.
- Morgan, N., Vorhies, D. W., & Schlegelmilch, B. B. (2006). Resource–performance relationships in industrial export ventures: The role of resource inimitability and substitutability. *Industrial Marketing Management*, 35(5), 621–633.
- Musso, F., & Francioni, B. (2014). International strategy for SMEs: criteria for foreign markets and entry modes selection. *Journal of Small Business and Enterprise Development*, 21(2), 301–312.
- Nag, R., Hambrick, D., & Chen, M. (2007). What is strategic management, really? Inductive derivation

- of a consensus definition of the field. *Strategic Management Journal*, 955(October 2006), 935–955.
- Nunnally, J. C. (1978). *Psychometric theory*. New York: McGraw-Hill.
- Okpara, J. (2009). Entrepreneurial orientation and export performance: evidence from an emerging economy. *Int. Rev. Bus. Res. Papers*, 5(6), 195–211.
- Pestana, M. H., & Gageiro, J. N. (2008). *Análise de Dados para Ciências Sociais - A complementaridade do SPSS (5ª)*. Edições Silabo.
- Peteraf, M. (1993). The cornerstones of competitive advantage: A resource-based view. *Strategic Management Journal*, 14(3), 179–191.
- Pfarrer, M. D., Pollock, T. G., & Rindova, V. P. (2010). a Tale of Two Assets: the Effects of Firm Reputation and Celebrity on Earnings Surprises and Investors' Reactions. *Academy of Management Journal*, 53(5), 1131–1152.
- Piercy, N., Kaleka, A., & Katsikeas, C. (1998). Sources of competitive advantage in high performing exporting companies. *Journal of World Business*, 33(4), 378–393.
- Porter, M. (1991). Towards a dynamic theory of strategy. *Strategic Management Journal*, 12.
- Reinartz, W., Haenlein, M., & Henseler, J. (2009). An empirical comparison of the efficacy of covariance-based and variance-based SEM. *International Journal of Research in Marketing*, 26(4), 332–344.
- Ridder, A. (2011). Sensing and seizing open innovation: A capability-based approach. Paper presented at the DIME-DRUID ACADEMY Winter Conference 2011 on. Aalborg, Denmark: Comwell Rebild Bakker.
- Schumpeter, J. A. (1934). *The Theory of Economic Development*. Transaction Publishers.
- Sousa, C. M. P., Martínez-López, F. J., & Coelho, F. (2008). The determinants of export performance: A review of the research in the literature between 1998 and 2005. *International Journal of Management Reviews*, 10(4), 343–374.
- Stouraitis, V., Harris, M., Harun, M., & Kyritsis, M. (2017). Motivators of SME initial export choice and the European Union regional effect in manufacturing. *International Journal of Entrepreneurial Behavior & Research*, 23(1), 35–55.
- Teece, D. J. (2007). Explicating dynamic capabilities : the nature and microfoundations of ( sustainable ) enterprise performance. *Strategic Management Journal*, 1350, 1319–1350.
- Teece, D. J., Pisano, G., & Shuen, A. (1997). Dynamic capabilities and strategic management. *Strategic Management Journal*, 18(7), 509–533.
- Wiklund, J., & Shepherd, D. (2003). Knowledge-based resources, entrepreneurial orientation, and the



performance of small and medium-sized businesses. *Strategic Management Journal*, 24(13), 1307–1314. <http://doi.org/10.1002/smj.360>

Wiklund, J., & Shepherd, D. (2005). Entrepreneurial orientation and small business performance: a configurational approach. *Journal of Business Venturing*, 20(1), 71–91.

Wu, L.-Y. & Wang, C.-J. (2007). Transforming resources to improve performance of technology-based firms: a Taiwanese empirical study. *Journal of Engineering and Technology Management*, 24, 251-261.

Zucchella, A., & Siano, A. (2014). Internationalization and Innovation as Resources for SME Growth in Foreign Markets. *International Studies of Management and Organization*, 44(1), 21–41.

## THE ROLE OF HUMAN RESOURCES FOR INBOUND OPEN INNOVATION: IMPLICATIONS FOR HIGH-TECH FIRMS.

**Santoro, Gabriele**

Dipartimento di Management, Università degli Studi di Torino, Italia

### ABSTRACT

With the increasing proclivity in engaging in open innovation, firms likely to face some tensions and opportunity given by the management of human resources. This starts from the assumptions that the knowledge base of the firms reside in the people who works for the firms and that some human resource management factors can influence innovation within firms. Despite this, there is a lack of studies investigating the link between human resource management and open innovation. This paper intends to fill this gap and nurture future research directions by assessing whether some human resource management elements help in engaging in open innovation and whether these elements are mediated by open innovation in enhancing innovation.

The paper uses structural equation modelling to test the aforementioned relationship on a sample of Italian firms in high-tech sectors, to provide theoretical and managerial implications.

*Keywords: inbound open innovation, human resource management, high-tech, innovation.*

### INTRODUCTION

Early studies in the business management field suggest that knowledge is the most important resource for firms to compete and create unique advantages (Nonaka, 1994; Grant, 1996). So far, there has been an arduous debate on whether firms create knowledge internally or acquire externally. Anyhow, no doubt exists that firms have to create and leveraging dispersed knowledge to increase competitiveness (von Krogh 1998; Argote and Ingram, 2000; Alavi and Leidner, 2001), to respond to changes of the competitive and technological environment (Teece, 2007). Consequently, firms increasingly have to heighten internal knowledge management capacity in order to manage inward and outward flows of knowledge exploiting and exploring external opportunities (Lichtenthaler and Lichtenthaler, 2009).

According to the open innovation paradigm, firms can and should acquire dispersed knowledge from external actor to integrate to knowledge developed internally and possessed by firm employees (Chesbrough, 2003). Most importantly, people inside the organization are called to search for external knowledge and integrate it with the internal one to improve processes and products (West and Bogers, 2014). For this reason, it is reasonable to infer that certain HRM practices could affect the capacity of managing knowledge properly. In fact, studies within the HRM domain found that certain practices help knowledge acquisition, knowledge creation and innovation (Ichniowski et al., 1997; Laursen and Foss, 2003; Michie and Sheehan, 2003; du Chatenier et al., 2007, 2010). In addition to this, acquiring or sourcing external knowledge may provoke many internal tensions requiring cultural and HRM efforts and practices. Despite this, there has been scarce interest in the intra-organisational aspects of open innovation so far (van de Vrande et al., 2010; Petroni et al., 2012; Vanhaverbeke et al., 2014; Bogers et al., 2016).

Therefore, with this paper aims to contribute to literature addressing the research gap aforementioned by shedding more light on the issue concerning the human aspect of open innovation.

To reach this goal, this paper follows a quantitative methodology approach through hierarchical regression model technique to test several hypotheses developed under the open innovation and HRM lens. Finally, theoretical and managerial implications are provided.

## **THEORETICAL BACKGROUND**

### *Open innovation*

The value creation for a firm depends on intangible and knowledge-based resources (Grant, 1996), which can be acquired externally or developed internally by employees and R&D departments. In fact, an integrative perspective which considers both internal and external sources of knowledge is relatively new in management studies (Grant and Baden-Fuller, 2004; Chesbrough, 2006; Teece, 2007; Del Giudice and Maggioni, 2014).

From a dynamic capabilities perspective, Teece (2007) claims that firms could combine internal and external knowledge in order to cope with the dynamic environment and to exploit technological and commercial opportunities. The open innovation theory describe this combination suggesting that "...firms can and should use external as well as internal ideas, and internal and external paths to market, as they look to advance their technology" (Chesbrough, 2004; p. 1). Thus, an alternative innovation model suggests new forms of interactions and collaborations that foster innovativeness within firms.

Therefore, firms develop competitive advantages through knowledge exploitation and exploration both within and outside the firm's boundaries (Vrontis et al., 2016). From one hand, internal departments and employees are pushed to find new solutions close to customers' need to develop new products. From the other hand, internal departments and employees struggle to find knowledge externally provided by the customers through customer engagement techniques, from other market-based sources such as suppliers and distributors, but also from scientific partners such as universities for more radical innovations development (Fabrizio, 2007).

Several studies suggest that, despite no firm can be considered totally open to innovation, some firms tend to establish more external relationships, while other concentrate their effort with one or two intense ties (Laursen and Salter, 2006; Naqshbandi and Naqshbandi, 2016).

A part from the level of openness to innovation, employees cover an important role in recognising and integrating sources of knowledge within the innovation process (West and Bogers, 2014). Despite this, there have been few attempts to describe the human and intra-organisational aspects of open innovation in literature. This is striking given that acquiring or sourcing external knowledge may provoke many internal tensions requiring cultural and HRM efforts and practices (Vanhaverbeke et al., 2014).

#### HRM and innovation

HRM regards to all the decisions made by management of a firm that affect the relationship between the firm and its employees (Beer et al., 1984). Literature usually distinguishes a number of relevant areas of policies and practices within the broad field of HRM. In particular, HRM regards (De Leede and Looise, 2005): a) the design of organizations and tasks; b) the staffing of the organization by managing the in-, through- and out- flow of personnel; c) the measurement of performance and the reward of employees; d) the channels for communication and participation in work and decision-making.

To date, there has been an increasing interest in understanding the strategic role of HRM and the benefit for the firm performance.

Accordingly, there is evidence of positive effects of recruitment and selection, training, HR planning, rewards system and employees participation activities on higher productivity (Koch and McGrath, 1996; Lazear, 1996); market performance (Delaney and Huselid, 1996; Hartog and Verburg, 2004), overall performance (Pfeffer, 1998; Fey et al., 2000), and innovativeness (Hoque, 1999; Andries and

Czarnitzki, 2014). With regard to innovation, the following part will develop hypotheses on HRM and innovation under the open innovation lens.

## **THE HUMAN AND INTER-ORGANISATIONAL ASPECTS OF OPEN INNOVATION: HYPOTHESES DEVELOPMENT**

An open approach to innovation involves the engagement between two actors through formal or informal ties (West and Lakhani, 2008). This means that, at organizational level, employees and teams are essential in managing inter-organizational innovation process, in particular for what concern (du Chatenier et al., 2007, 2010): a) the management of collaboration processes; b) the management of the whole innovation process; c) the creation of knowledge in a collaborative manner; d) the importance of boundary-spanning, novelty-generating, negotiating and learning competences for employees.

Therefore, I believe that:

*Hp. 1: the greater the use of team works within a firm, the higher the proclivity of engaging in inbound open innovation*

*Hp. 2: the greater the use of team works within a firm, the higher the likelihood of benefiting from inbound open innovation*

Global talent management is about systematically utilizing HRM activities to attract, develop, and retain individuals with high levels of human capital (e.g., competency, personality, motivation) consistent with the strategic directions of the firm in a dynamic, highly competitive, and global environment (Tarique and Schuler 2010). Despite the fact that most of useful knowledge is outside the firm's boundaries (Chesbrough, 2003), our belief is that the ability of recognising useful external knowledge reside in the employees' capabilities and talent (Lewis and Heckman, 2006), given that talent plays a key role in the relationships a firm has with its external stakeholders (Zhang et al., 2015). Therefore, the employees' retention is reasonable expected to be positively associated with commitment and trust with the firm, and it is also likely to foster knowledge specialization and fortification (Muffatto, 1998). In fact, short-term contracts and low level of commitment have been found counterproductive to firm's innovativeness (Michie and Sheehan, 2003), and OI strategies potentially lead to higher levels of professional commitment of employees (Bogers et al., 2016). Through higher level of commitment and retention, it is reasonable to infer that employees are more willing to consider the open innovation strategy and approach of the firm, understanding the need to integrate the knowledge developed internally and externally. Moreover, with the retention of the employees, the knowledge base of the firm increase, and therefore firm augments the likelihood of

benefiting from inbound open innovation, because employees' retention is important to acquire knowledge and for knowledge integration (Weber and Tarba, 2010).

Therefore, I believe that:

*Hp. 3: the higher the employees' retention, the higher the proclivity of engaging in inbound open innovation*

*Hp. 4: the higher the employees' retention, the higher the likelihood of benefiting from inbound open innovation*

Linked to the above hypotheses, HRM practices, such as training and learning, proper recruitment and selection, have been found positively associated with knowledge acquisition, knowledge creation and innovation in literature (Laursen and Foss, 2003; Michie and Sheehan, 2003; Chand, 2010). Moreover, with reward systems these benefits are even stronger because employees feel incentivized to be work better (Ichniowski et al., 1997). In general, appropriate roles, structures, procedures and systems are also relevant in order to enable effective knowledge flows when innovation is carried out in collaboration (Petroni et al., 2012). Other scholars have highlighted the crucial role of human and organizational capital and related HRM practices in creating a context which favours knowledge sharing within the firm (Cabrera & Cabrera, 2005; Yang & Lin, 2009). Lazzarotti et al. (2015) suggest that firms should carefully manage several HRM practices, e.g. selection and recruiting of personnel, training, development, and reward system in order to promote knowledge transfer and innovativeness.

Finally, literature also recognizes that greater degrees of openness imply increasing organizational and managerial complexity (Bader & Enkel, 2014), and certain HRM practices can help in manage such complexity. From a social capital perspective, HRM systems may help in building social relations among employees by improving their opportunity, motivation, and ability to access and mobilize that may extend to collaborative ties externally (Adler and Kwon, 2002).

*Hp. 5: the greater the use of HRM practices, the higher the proclivity of engaging in inbound open innovation*

*Hp. 6: the greater the use of HRM practices, the higher the likelihood of benefiting from inbound open innovation*

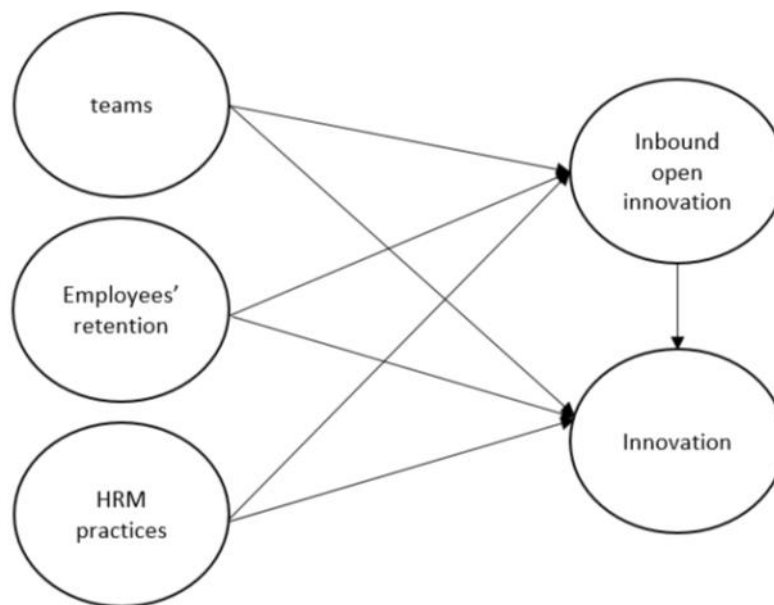

**Figure 1: the conceptual model**

## METHODOLOGY

### Research sample, design and variables

The research involves data gathered from CEO, R&D managers and HRM managers of high-tech firms located in Italy. First, a total of 1000 high-tech firms were selected from an Italian database. Second, an email with invitation to participate in the survey along with a letter containing an explanation of the study's purpose was sent to all the firms. In total 192 firms have expressed the interest in entering the study. Third, a questionnaire, composed of 27 questions (open and closed), was sent to these firms, which was answered and returned by 118 firms, which is the final sample. The answers for all the variables and general information of the firm were gathered from the different key managers to avoid concerns regarding common method bias.

In detail, firms within the sample operate in manufacturing and services high-tech industries in the following specific sectors: electronic and electrical component; biotechnology; information and communication technology; pharm and medicine; chemical; computer engineering. The majority of them are small and medium enterprises (79% of them have less than 250 employees).

The paper builds on the theoretical framework and the consequent conceptual model to conduct the empirical research, which follows two main steps. First, the literature review led us to develop the questionnaire and therefore the variables of our model. Second, I have tested the model and the

hypotheses through structural equation modelling (SEM), which was considered a suitable method for our research.

As stated before, the questionnaire was composed of 27 questions. The questions were stated according to a funnelling technique (Breiman et., 1984). Therefore, general questions were followed to the specific one. In this way, I collected general information about the firm such as number of employees, industry, financial data, etc. Consequently, specific questions were outlined and focused mainly on HRM with specific regard to team works, employees' retention and HRM practices, open innovation and innovation.

With regard to innovation as a performance measure, it measures the ability of a firm in developing new products or services (Laursen and Salter, 2006).

Consequently, variables were developed using multi-item scales according to relevant literature in order to ensure content validity. Table 1 shows the specific questions and items for each variable. In particular, I asked to respondent to evaluate several statements with a seven-points likert scales.

**Table 1. Variables and items**

Variables	Questions	Related literature
Teams	The importance of team works in managing the interorganizational collaboration process	du Chatenier et al., 2010
	Team works for managing the overall innovation process	du Chatenier et al., 2010
	The importance of team works in creating new knowledge collaboratively	du Chatenier et al., 2010
Employees' retention	The importance of retaining employees in the top management	Ranft and Lord, 2000
	The importance of retaining employees in the middle management	Ranft and Lord, 2000
	The importance of retaining employees in manufacturing and operations	Ranft and Lord, 2000
	the importance of retaining employees in R&D	Ranft and Lord, 2000
	The importance of retaining employees in finance, legal and other staff	Ranft and Lord, 2000
HRM practices	The importance of performance related rewards	Chand, 2010
	The importance of flexible work	Chand, 2010
	The importance of training and learning	Chand, 2010
	The importance of recruitment and selection	Chand, 2010



Inbound open innovation	Importance of external knowledge from market-channels	Chen et al., 2015
	Importance of external knowledge from scientific-channels	Chen et al., 2015
	Importance of licensing-in of knowledge and technologies	Chen et al., 2015
Innovation	New to the world products	Laursen and Salter, 2006
	New to the firm products	Laursen and Salter, 2006
	Improved products	Laursen and Salter, 2006

Before the hypotheses testing with SEM, a measurement model is conducted to ensure reliability and validity of the scales. First, a confirmatory factor analysis (CFA) for each constructs has been done in order to ensure the reliability of the measures (Henseler & Fassott, 2010), and data indicate that the Cronbach's alpha are higher than 0.7, the threshold recommended (Hair et al., 2010). Also, composite reliability and average variance extracted are respectively above 0.7 and 0.5, the recommended threshold (Fornell and Larcker, 1981). The validity of the scale is confirmed by loading factors which are higher than 0.5, suggesting a good convergent validity. Also content validity is ensured given that scales are developed according to literature.

**Table 2. Descriptive statistics and measurement model**

	Mean	No. items	Alpha	SCR	AVE
Teams	3.38	3	0.79	0.82	0.54
Employees' retention	3.76	5	0.72	0.76	0.51
HRM practices	3.85	3	0.74	0.75	0.61
Inbound open innovation	3.71	3	0.71	0.73	0.51
Innovation	3.85	3	0.78	0.81	0.56

## PROCEDURES AND RESULTS

The conceptual model shows the relationship among variables developed following the literature. In particular, the hypotheses have been tested through PLS – SEM technique, useful for small sample (Chin et al., 2010). It is also recommended for statistical models containing latent variables with several cause and effect relationships (Gustafsson and Johnson, 2004), and when mediation effect are willing to be assessed (Chin, 1998).

The path coefficients generated by PLS provide an indication of relationships and can be used similarly to the traditional regression coefficients (Gefen et al., 2000).

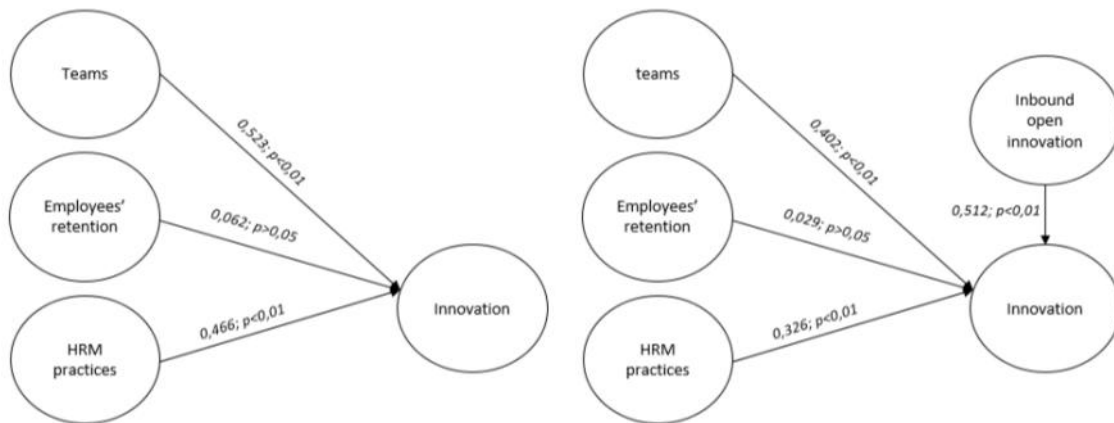

**Figure 2. the PLS coefficients**

Table 3 shows the relationship among variables through direct effects (standardized beta coefficients). In particular, it indicates that: first, teams is positively associated with open innovation (0.618; p<0.01), confirming hypothesis 1; second, employees’ retention is not associated with open innovation (0.123; p>0.05), therefore hypothesis 3 is not confirmed; third, HRM practices is positively associated with open innovation (0.553; p<0.01), confirming hypothesis 5.

For hypotheses 2, 4 and 6 potential mediation effects have been assessed. Mediation exists if the coefficient of the direct path between the independent variable and the dependent variable is reduced when the indirect path via the mediator is introduced into the model (Bontis et al., 2007). As figure 2 shows (right part), all the three direct path coefficient are lower when the indirect effect of inbound open innovation is introduced. In particular: a) the direct effect of teams on innovation is reduced from 0.523 to 0.402; b) the direct effect of employees’ retention on innovation is reduced from 0.062 to 0.029; c) the direct effect of HRM practices on innovation is reduced from 0.466 to 0.326.

For the sake of brevity, the paths of teams, employees’ retention and HRM practices to inbound open innovation are not reported in figure 2 but they are indicated in Table 3. These paths are positive and significant, meaning that all the component of HRM are positively associated with inbound open innovation.

**Table 3. Direct path of independent variables on mediating variable**

Path	Beta
Teams → Inbound open innovation	0.618; p<0.01
Employees’ retention → Inbound open innovation	0.123; p>0.05

HRM practices → Inbound open innovation

0.553;  $p < 0.01$

The indirect effect are calculated as follows. The indirect effect of teams to inbound open innovation and from inbound open innovation to innovation was  $0.618 \times 0.512 = 0.316$ . The indirect effect of employees' retention to inbound open innovation and from inbound open innovation to innovation was  $0.123 \times 0.512 = 0.063$ . Finally, the indirect effect of employees' retention to inbound open innovation and from inbound open innovation to innovation was  $0.553 \times 0.512 = 0.283$ .

## DISCUSSION AND CONCLUSIONS

The main purpose of this paper was investigate the relationship between HRM and open innovation. Developing a conceptual model based on human resource and open innovation literature, several hypotheses have been tested through SEM-PLS.

In particular, it has been hypothesized that several HRM elements are important in engage with an open innovation approach, and that the open innovation approach mediates the relationship between HRM and innovation in firm. Results indicate that teams and HRM practices are important to establish an open innovation approach (hypothesis 1 and hypothesis 5), while employees' retention is not essential in engaging in inbound open innovation (hypothesis 3).

Furthermore, our results suggest that inbound open innovation mediates the relationship between teams and innovation, and the relationship between HRM practices and innovation (hypothesis 2 and hypothesis 6). Whilst, despite open innovation improves the relationship between employees' retention and innovation, I cannot conclude that a mediating effect exists. Therefore, hypothesis 4 cannot be confirmed absolutely.

Our research findings drive us to develop several implications to theory. First, our research contributes to theory indicating that the HRM aspect of open innovation is important for firms given that knowledge is the most important resource for innovation within firms, and innovation is driven by the knowledge possessed by firm's employees. In this regard, acquiring or sourcing external knowledge may provoke many internal tensions requiring cultural and HRM efforts and practices. Despite this, there has been scarce interest in the intra-organisational aspects of open innovation so far (Vanhaverbeke et al., 2010; Petroni et al., 2012; Vanhaverbeke et al., 2014; Bogers et al., 2016). Therefore, I suggest that some HRM activities have to be established before structuring inbound open innovation activities.

Second, by drawing on HRM literature, our research proposes several elements important in the management knowledge possessed by firms. Accordingly, the effects of teams, employees' retention

and HRM practices on inbound open innovation and innovation have been tested. In particular, team works for inter-organizational processes, for managing the innovation process, for creating new knowledge collaboratively, and HRM practices such as performance related rewards, flexible work, training and learning and recruitment and selection, are important in engaging in inbound open innovation and are fully mediated by open innovation for the improvement of the innovation performance. Therefore, with certain HRM activities firms are more able to develop innovative products and services as suggested by literature (Hoque, 1999; Andries and Czarnitzki, 2014). In turn, employees' retention is not important in improving innovation, and this result is different from previous studies (Michie and Sheehan, 2003). One possible explanation is that, despite the employees' turnover within the firm, important knowledge resides in few employees seen as talented. Therefore, firms can hold some employees for a long time and change some others without compromising the knowledge base or the ability to engage in inbound open innovation.

Our study has also practical implications. First, the management of the firms should adopt a HRM strategic view when approaching inbound open innovation. This underlines the importance of employees' and human aspect in managing internal and external sources of knowledge as antecedents of innovation. In particular, HR managers must promote initiatives to stimulate collaborative approach to innovation and specific practices that can be useful to improve innovation. In the specific case of our paper, rewards based on performance, flexibility in workday training and learning activities, and recruitment and selection are seen as important elements in applying inbound open innovation and manage properly external sources of knowledge to enhance innovation.

The results of our work should be considered in light of several limitations. First, data were gathered from top managers of the firms involved in the research and therefore they can be influenced from subjectivity. Future studies can address the human aspect of open innovation analysing the perspective of the employees' active in the management of knowledge and in collaborative activities. Second, our research focused on high-tech firms from a specific country; therefore, results in different context such as traditional firms can be different.

To conclude, our results strikingly indicate that employees' retention is not associated with open innovation and therefore hiring talented human resources is important but retaining them for a long time is not essential to approaching and benefiting from open innovation. This result opens for future questions and deserves surely more attention.

## REFERENCES

- Adler, P. S., & Kwon, S. W. (2002). Social capital: Prospects for a new concept. *Academy of management review*, 27(1), 17-40.
- Alavi, M., & Leidner, D. E. (2001). Review: Knowledge management and knowledge management systems: Conceptual foundations and research issues. *MIS quarterly*, 107-136.
- Andries, P., & Czarnitzki, D. (2014). Small firm innovation performance and employee involvement. *Small Business Economics*, 43(1), 21-38.
- Argote, L., & Ingram, P. (2000). Knowledge transfer: A basis for competitive advantage in firms. *Organizational behavior and human decision processes*, 82(1), 150-169.
- Bader, K., & Enkel, E. (2014). Understanding a firm's choice for openness: strategy as determinant. *International Journal of Technology Management* 23, 66(2-3), 156-182.
- Beer, M. (1984). *Managing human assets*. Simon and Schuster.
- Bogers, M., Zobel, A. K., Afuah, A., Almirall, E., Brunswicker, S., Dahlander, L., ... & Hagedoorn, J. (2016). The open innovation research landscape: Established perspectives and emerging themes across different levels of analysis. *Industry and Innovation*, 1-33.
- Bontis, N., Booker, L. D., & Serenko, A. (2007). The mediating effect of organizational reputation on customer loyalty and service recommendation in the banking industry. *Management decision*, 45(9), 1426-1445.
- Breiman, L. (1996). Bagging predictors. *Machine learning*, 24(2), 123-140.
- Cabrera, E. F., & Cabrera, A. (2005). Fostering knowledge sharing through people management practices. *The International Journal of Human Resource Management*, 16(5), 720-735.
- Chand, M. (2010). The impact of HRM practices on service quality, customer satisfaction and performance in the Indian hotel industry. *The International Journal of Human Resource Management*, 21(4), 551-566.
- Chatenier, E. D., Verstegen, J. A., Biemans, H. J., Mulder, M., & Omta, O. S. (2010). Identification of competencies for professionals in open innovation teams. *R&D Management*, 40(3), 271-280.
- Chen, Y., Vanhaverbeke, W., & Du, J. (2015). The interaction between internal R&D and different types of external knowledge sourcing: an empirical study of Chinese innovative firms. *R&D Management*.
- Chesbrough, H. (2003) *Open Innovation: The New Imperative for Creating and Profiting from Technology* (Boston: Harvard Business School Press).
- Chesbrough, H. (2004). Managing open innovation. *Research-Technology Management*, 47(1), 23-26.
- Chesbrough, H. W. (2006). *Open innovation: The new imperative for creating and profiting from technology*. Harvard Business Press.
- Chin, W. W. (1998). The partial least squares approach to structural equation modeling. *Modern methods for business research*, 295(2), 295-336.
- Chin, W. W. (2010). How to write up and report PLS analyses. In *Handbook of partial least squares* (pp. 655-690). Springer Berlin Heidelberg.
- De Leede, J., & Looise, J. K. (2005). Innovation and HRM: towards an integrated framework. *Creativity and innovation management*, 14(2), 108-117.
- Del Giudice, M., & Maggioni, V. (2014). Managerial practices and operative directions of knowledge management within inter-firm networks: a global view. *Journal of Knowledge Management*, 18(5), 841-846.
- Delaney, J. T., & Huselid, M. A. (1996). The impact of human resource management practices on perceptions of organizational performance. *Academy of Management journal*, 39(4), 949-969.
- Du Chatenier, E., Biemans, H. J. A., Verstegen, J. A. A. M., & Mulder, M. (2007, June). Collaborative knowledge creation in open innovation teams. In *Eighth International Conference on HRD Research and Practice Across Europe* (pp. 27-29).
- Fabrizio, K. R. (2007). University patenting and the pace of industrial innovation. *Industrial and Corporate Change*, 16(4), 505-534.
- Fey, C. F., Björkman, I., & Pavlovskaya, A. (2000). The effect of human resource management practices on firm performance in Russia. *International Journal of Human Resource Management*, 11(1), 1-18.
- Fornell, C., & Larcker, D. F. (1981). Structural equation models with unobservable variables and measurement error: Algebra and statistics. *Journal of marketing research*, 382-388.
- Gefen, D., Straub, D., & Boudreau, M. C. (2000). Structural equation modeling and regression: Guidelines for research practice. *Communications of the association for information systems*, 4(1), 7.
- Grant, R. M. (1996). Toward a knowledge-based theory of the firm. *Strategic management journal*, 17(S2), 109-122.
- Grant, R. M., & Baden-Fuller, C. (2004). A knowledge accessing theory of strategic alliances. *Journal of management studies*, 41(1), 61-84.
- Gustafsson, A., & Johnson, M. D. (2004). Determining attribute importance in a service satisfaction model. *Journal of Service Research*, 7(2), 124-141.

- Hartog, D. N., & Verburg, R. M. (2004). High performance work systems, organisational culture and firm effectiveness. *Human Resource Management Journal*, 14(1), 55-78.
- Henseler, J., & Fassott, G. (2010). Testing moderating effects in PLS path models: An illustration of available procedures. In *Handbook of partial least squares* (pp. 713-735). Springer Berlin Heidelberg.
- Hoque, K. (1999). Human resource management and performance in the UK hotel industry. *British Journal of Industrial Relations*, 37(3), 419-443.
- Ichniowski, C., Shaw, K., & Prennushi, G. (1997). The effects of human resource management practices on productivity: A study of steel finishing lines. *The American Economic Review*, 291-313.
- Koch, M. J., & McGrath, R. G. (1996). Improving labor productivity: Human resource management policies do matter. *Strategic management journal*, 335-354.
- Laursen, K., & Foss, N. J. (2003). New human resource management practices, complementarities and the impact on innovation performance. *Cambridge Journal of economics*, 27(2), 243-263.
- Laursen, K., & Foss, N. J. (2003). New human resource management practices, complementarities and the impact on innovation performance. *Cambridge Journal of economics*, 27(2), 243-263.
- Laursen, K., & Salter, A. (2006). Open for innovation: the role of openness in explaining innovation performance among UK manufacturing firms. *Strategic management journal*, 27(2), 131-150.
- Lazear, E. P. (1996). Performance pay and productivity (No. w5672). National bureau of economic research.
- Lazzarotti, V., Manzini, R., & Pellegrini, L. (2015). Is your open-innovation successful? The mediating role of a firm's organizational and social context. *The international journal of human resource management*, 26(19), 2453-2485.
- Lewis, R. E., & Heckman, R. J. (2006). Talent management: A critical review. *Human resource management review*, 16(2), 139-154.
- Lichtenthaler, U., & Lichtenthaler, E. (2009). A capability-based framework for open innovation: Complementing absorptive capacity. *Journal of management studies*, 46(8), 1315-1338.
- Michie, J., & Sheehan, M. (2003). Labour market deregulation, 'flexibility' and innovation. *Cambridge journal of economics*, 27(1), 123-143.
- Muffatto, M. (1998). Corporate and individual competences: how do they match the innovation process?. *International journal of technology management*, 15(8), 836-853.
- Naqshbandi, M. M., & Naqshbandi, M. M. (2016). Managerial ties and open innovation: examining the role of absorptive capacity. *Management Decision*, 54(9), 2256-2276.
- Nonaka, I. (1994). A dynamic theory of organizational knowledge creation. *Organization science*, 5(1), 14-37.
- Petroni, G., Venturini, K., & Verbano, C. (2012). Open innovation and new issues in R&D organization and personnel management. *The International Journal of Human Resource Management*, 23(1), 147-173.
- Pfeffer, J. (1998). *The human equation: Building profits by putting people first*. Harvard Business Press.
- Ranft, A. L., & Lord, M. D. (2000). Acquiring new knowledge: The role of retaining human capital in acquisitions of high-tech firms. *The Journal of High Technology Management Research*, 11(2), 295-319.
- Tarique, I., & Schuler, R. S. (2010). Global talent management: Literature review, integrative framework, and suggestions for further research. *Journal of world business*, 45(2), 122-133.
- Teece, D. J. (2007). Explicating dynamic capabilities: the nature and microfoundations of (sustainable) enterprise performance. *Strategic management journal*, 28(13), 1319-1350.
- Van De Vrande, V., Vanhaverbeke, W., & Gassmann, O. (2010). Broadening the scope of open innovation: past research, current state and future directions. *International Journal of Technology Management*, 52(3/4), 221-235.
- Vanhaverbeke, W., Chesbrough, H., & West, J. (2014). Surfing the new wave of open innovation research. *New frontiers in open innovation*, 281.
- Von Krogh, G. (1998). Care in knowledge creation. *California management review*, 40(3), 133-153.
- Vrontis, D., Thrassou, A., Santoro, G., & Papa, A. (2016). Ambidexterity, external knowledge and performance in knowledge-intensive firms. *The Journal of Technology Transfer*, 1-15.
- Weber, Y., & Tarba, S. Y. (2010). Human resource practices and performance of mergers and acquisitions in Israel. *Human resource Management review*, 20(3), 203-211.
- West, J., & Bogers, M. (2014). Leveraging external sources of innovation: a review of research on open innovation. *Journal of Product Innovation Management*, 31(4), 814-831.
- West, J., & Lakhani, K. R. (2008). Getting clear about communities in open innovation. *Industry and Innovation*, 15(2), 223-231.
- Yang, C. C., & Lin, C. Y. Y. (2009). Does intellectual capital mediate the relationship between HRM and organizational performance? Perspective of a healthcare industry in Taiwan. *The International Journal of Human Resource Management*, 20(9), 1965-1984.

Zhang, J., Ahammad, M. F., Tarba, S., Cooper, C. L., Glaister, K. W., & Wang, J. (2015). The effect of leadership style on talent retention during merger and acquisition integration: Evidence from China. *The International Journal of Human Resource Management*, 26(7), 1021-1050.

## **RE-AFFIRMING THE NEED FOR SYSTEMS THINKING IN SOCIAL SCIENCES: A VIABLE SYSTEMS VIEW OF SMART CITY**

**Saviano, Marialuisa; Caputo, Francesco**

Department of Pharmacy, University of Salerno, Fisciano, Italy

### **ABSTRACT**

Although widely recognized as fundamental to supporting the understanding of social and economic dynamics, systems thinking still seems to suffer from the old criticism of being considered too abstract to address solutions for specific real problems or maybe there is a lack of capacity to think about our societies in a more systemic and holistic way. With the aim of re-exploring the contribution of systems thinking in the field of management, the Viable Systems Approach (*VSA*) has been developed in the last decades as a methodology, rooted in systems thinking and based on the Viable Systems Model of Stafford Beer, which is useful to interpret and articulate complex social and business dynamics. As an exemplification of the way systems thinking can be applied in the context of social sciences through the *VSA*, the case of Smart City is proposed, which highlights how the *VSA* can contribute to bridging the gap between an abstract adoption of systems thinking and the application of its principles and models to specific problematic contexts of high social complexity.

*Keywords: Systems Thinking, Viable Systems Approach, Smart City.*

### **INTRODUCTION: RE-AFFIRMING THE NEED FOR SYSTEMS THINKING IN SOCIAL SCIENCES**

In the last few years, various evolutionary trends have progressively changed social configurations (Beck & Sznaider, 2006), determining the emergence of new lifestyles and social behaviours (Lawson & Todd, 2002), increasingly based on information sharing and supported by the innovative instruments offered by Information and Communication Technologies (Huysman & Wulf, 2006; Caputo et al., 2016b; Evangelista *et al.*, 2016). But a topic to develop is how can we move from an emphasis in information to communications and learning processes to increase the quality of our cities.

Progress, especially at the technological level, allows for the development of new possibilities, offering, on the one hand, ever new solutions and creating, on the other hand, ever new needs. As a consequence, an increasing variety can be observed together with an increasing interconnection between social, economic, and environmental phenomena (Lofland & Lofland, 2006), which make



even more complex the understanding of socio-economic dynamics requiring the development of new interpretative models (Giddens, 1979; Manski, 1995; Parsons *et al.*, 1965; Holling, 2001).

As a 'soft' science, social sciences typically deal with multi-dimensional phenomena the understanding of which require the adoption of multiple perspectives and the development of interdisciplinary knowledge. These requirements, however, are difficult to address because, over time, each discipline has developed its own interpretative models, making dialogue between different perspectives more problematic and the attempt to define 'best' solutions that could be applied to categories of similar problems fails (Gergen, 1985).

The understanding of this variety has led to the development of even more specific models by enriching the interpretative frameworks used, through the development of specialized and hyper-specialized knowledge (Johns *et al.*, 2011, Caputo, 2017), thus ending up with complicated models. Moreover, with increasing information, the capability of models to effectively represent the observed dynamics results has weakened. Models, in fact, cannot include all relevant variables without losing their readability and capability to represent reality. The challenge is to find simple explanations for very complicated dynamics (May, 1976).

An increasingly analytical study of observed phenomena implies splitting up a problem and investigating its parts with the aim of defining an effective solution for the specific situation (Bohman, 1993). Through this reductionist approach, relevant properties that emerge from interaction will be lost and the functioning of the whole cannot be understood. Complexity, in fact, cannot be reduced because, as will be shown in the next section, it is interaction that yields "coherent patterns of behaviours" (Stacey *et al.*, 2000: 7). This problem has long been evidenced by systems theory. In order to address complexity, it is necessary to identify the rules that govern those coherent patterns of behaviours, which cannot be completely designed and controlled – at least when they involve humans – as for any social phenomenon.

Believing that the increasing complexity of reality cannot be addressed by 'complicating' the models and departing in an opposite direction, this paper re-affirms the need for a general reference conceptual framework (Weber, 1949) and re-explores the contribution of systems thinking as one of the most general level frameworks of reference for investigating any kind of phenomenon of reality.

Systems theory, however, has been alleged to fail "in its attempt to deal with soft, unstructured problem situations where values and objectives are multiple and conflicting" (Mingers, 1980: 45).

Although limitations in the application of systems thinking to the analysis of social dynamics are still debated (Blanche *et al.*, 2006), its interpretative power for complex social dynamics is unquestionable.

Recognizing the need for an interpretative framework that can ground the understanding of complex multi-dimensional phenomena, the contribution of systems thinking (Von Bertalanffy, 1968;

Maturana, 1975; Checkland, 1985; Bogdanov, 1989; Senge & Sterman, 1992; Jackson, 2003) has been widely re-explored and re-affirmed (Maani & Maharaj, 2004; Galanakis, 2006).

In the context of management studies, the recognition of the necessity to adopt a systems thinking view in the interpretation of socio-economic dynamics, has led to the development of a research stream, the aim of which is to provide general reference interpretation schemes for the management and study of business as well as social organizations. Rooted in systems thinking and based on the Viable Systems Model of Stafford Beer (1984), the Viable Systems Approach (VSA). VSA is a useful methodology used to study socio-economic phenomena by integrating an analytical with a holistic approach.

VSA – like systems thinking – can be expected to provide interpretative tools that can be effectively applied to real problem-solving or dissolving problems and offering spaces for continuous learning processes. It should be said, however, as will be illustrated in the next section, that VSA aims to contribute to fill the gap at a general reference level for interpreting complex business and social dynamics, the understanding of which cannot rely on consolidated management tools as they are conceived in a specific problem-solving perspective.

An effective example of articulated multi-dimensional phenomena that can be effectively investigated through the adoption of the VSA is Smart City (Anttiroiko *et al.*, 2014). In fact, the governance of Smart City implies the understanding of complex dynamics that involve multiple social, economic, and technical dimensions. Both theoretically and practically, Smart City is a challenging phenomenon to deal with, which requires interaction and collaboration between several different disciplines. In this perspective, the need of a general conceptual framework is apparent. Nevertheless, the study of Smart City still appears to lack the support of a general framework of reference both at a theoretical and practical level (Nam & Pardo, 2011; Jin *et al.*, 2014).

With the aim of providing an exemplification of the way systems thinking can be applied in the context of social sciences through the VSA, the case of Smart City is discussed in this paper, highlighting how the VSA can contribute to bridging the gap between an abstract adoption of systems thinking and an application of its principles and models to real problematic contexts. A key research question summarizes the perspective adopted: *Is a Smart City a designed or an emergent outcome?*

The paper is structured as follows: following a brief review of the contribution of systems thinking to social sciences, the main focus is on the VSA as an interpretative methodology rooted in systems thinking. Subsequently, the case of Smart City will be discussed as an interesting multi-dimensional social phenomenon, the interpretation of which still lacks the support of a general framework of reference. In order to bridge this gap, the VSA framework will be applied to outline the fundamental

elements of a possible interpretative framework of common reference for the study and governance of Smart City. Finally, some conclusions and future directions for research will be proposed.

## THE FUNDAMENTAL CONTRIBUTION OF SYSTEMS THINKING TO SOCIAL SCIENCES

In the first chapter of their book – *Complexity and management: fad or radical challenge to systems thinking?* Stacey *et al.* (2000: 7) stated that “there are alternative ways of thinking about causality, some of them suggested by the provocative thinkers in the complexity sciences [...]. These thinkers suggest that interaction itself has the intrinsic capacity to yield coherent patterns of behaviours. They propose that the entities of which nature is composed interact locally with each other, in the absence of any blueprint, plan or program, and through that interaction they produce coherent patterns in themselves”. These words effectively summarize the challenges faced and the opportunities offered by systems thinking.

Over time, the scenario described by Stacey *et al.* (2000) has attracted the interest of an increasing number of researchers and research streams involved in defining possible applications and useful advancements in knowledge in social sciences in the light of systems thinking. Undoubtedly, systems thinking is nothing new; it has a long history originating in the research domain of natural sciences (Von Bertalanffy, 1968; Maturana, 1975). Only in the last century, however, have social and economic researchers tried to apply its principles and frameworks to the studies of social and economic dynamics (Von Foerster, 1984; Bogdanov, 1989). More specifically, the willingness to apply systems thinking in social domains was inspired by the increasing uselessness of traditional mechanistic, as well as reductionist, approaches in explaining social dynamics and trends (Hedström & Ylikoski, 2010; Calabrese *et al.*, 2017). Many scholars have proposed the application of systems thinking in the social sciences domains (Boulding, 1956; Beer, 1979; Bowler, 1981), highlighting its general validity as an interpretative lens (Von Bertalanffy & Rapoport, 1963) and the need to build more explicative conceptual frameworks for social sciences (Mingers, 1980; Tronvoll *et al.*, 2017).

Among the numerous works devoted to representing organizations from a systems perspective, one that still attracts interest from a significant number of scholars and professionals is that of Stafford Beer (1984) who developed the Viable System Model (VSM). The VSM builds on key concepts of cybernetics in order to propose a representative model of an organization able to produce itself by adapting its configuration to the external changes. The VSM offers a conceptual framework useful for underlining in what ways an organized entity can modify itself to ensure its survival (Espejo & Harnden, 1989; Espejo, 1990; Schwaninger, 2006). This conceptualization has several implications for social sciences and has opened up a wider perspective in the studies of social phenomena (Jackson,

1992; Espejo & Reyes, 2011). The model is functional for any type of organization that aims to survive by modifying its logical and physical structure over time. Hence, 'viability' is the modality which characterizes the nature of social entities, expressing the interaction of an organization with its context in order to learn, adapt, develop itself, and improve its efficacy in relation to the specific aim of survival. However, the Stafford Beer's model, based on the observation of biological and social systems, gives centrality an organization's recursive structures.

An interesting advancement in this area was offered in the work of Schein (1985) which proposed an organizational culture model based on the differences among underlying values, espoused values, and artefacts. This model enriches previous knowledge by outlining the opportunities to analyse a system from different viewpoints; furthermore, it identifies possible implications of systems recursion in social sciences by acting on the construct of 'organizational and occupational cultures'. The model, however, does not offer a clear explanation about the ways in which the culture evolves over time and impacts on the systems configurations (Škerlavaj *et al.*, 2007).

From a different viewpoint, Hatch and Cunliffe (2006), with the aim of enriching the structural perspective of VSM, introduced in the model some 'dynamic dimensions' by identifying five major fields of organization theory: organizational culture and identity, organizational strategy, organizational design and structure, organizational behaviour and performance, and strategic response to organizational environment. This contribution underlines the relevance of dynamic dimensions in systems thinking (Hatch & Cunliffe, 2006).

Many difficulties arise, however, when dealing with social dynamics, and lead to recognition of the impossibility of including and considering all the relevant dimensions in a unitary framework by advocating the concept of complexity (Gell-Mann, 1995; Anderson, 1999; Di Nauta *et al.*, 2015; Rosenberg, 2015; Basile & Caputo, 2017; Del Giudice *et al.*, 2017).

With the aim of re-exploring the contribution of systems thinking to social sciences by shifting attention from the structures to the dynamics of social organizations living in turbulent environments, the *VSA* has been developed in the field of management by adopting a multi-disciplinary approach that integrates contributions from psychology, sociology, and philosophy (Barile, 2009a).

As will be illustrated in the next section, although essentially based on the same conceptual matrix of Stafford Beer's VSM, to better fit the current problematic context of organizations, *VSA* introduces several innovations, above all in relation to the analysis of decision-making processes in conditions of complexity.

## **THE VIABLE SYSTEMS APPROACH AS A SYSTEMS THINKING METHODOLOGY**

The *vSA* has been developed in the last few decades by an Italian group of researchers in the field of management and is gaining increasing interest at an international level (Barile, 2000, 2008, 2013; Golinelli, 2000, 2005, 2010; Barile *et al.*, 2012). It builds on the key concepts of Stafford Beer's VSM in order to develop a coherent framework for investigating the way viable systems survive in their environments by interacting with other systems entities (Barile, 2013; Saviano & Caputo, 2013); that is, the ways a system perceives, interprets, and reacts to environmental changes in order to become even more effective (VV.AA., 2011; Barile *et al.*, 2013; Saviano *et al.*, 2014).

Grounded in a constructivist view of reality (von Glasersfeld, 2001), the *vSA* states that the behaviour of a viable system, be it an individual or an organization, depends on a subjective perception of reality affected by the system's previous experiences and knowledge, and by the strong beliefs that progressively define its identity (Barile *et al.*, 2015). The identity of a viable system is represented through what the *vSA* calls its *Information Variety* (Barile, 2009b): a system's identity made up of knowledge possessed (*information units*), cognitive capabilities developed over time (*interpretation schemes*), and strong beliefs that characterize its personality (*categorical values*). More specifically, the information units refer to the total amount of data held by the system and on which systems' decisions are based. The interpretation schemes are the ways through which a system organizes the available information in order to represent a specific problem or situation. Finally, the categorical values are the strong beliefs that affect the systems' perspective in defining elements that are relevant to the system. By adopting the Information Variety Model in the study of social dynamics, it is possible to identify what elements are involved in the resolution of specific problems and/or in the analysis of a specific phenomenon. In this respect, Barile (2009a) states that it is possible to identify a relationship between the kind of problems subjectively perceived by a system and the different levels of the Information Variety Model. In particular, the model is useful to investigate conditions of harmonic interaction between systems at any level of interaction.

As shown in Figure 1, from the intersection of the dimensions of Information Variety, emerges the identity of a viable system. As any social entity can be viewed as a viable system, the model can be used for investigating social configurations of organized entities, from individual systems to networked systems (Barile *et al.*, 2016).

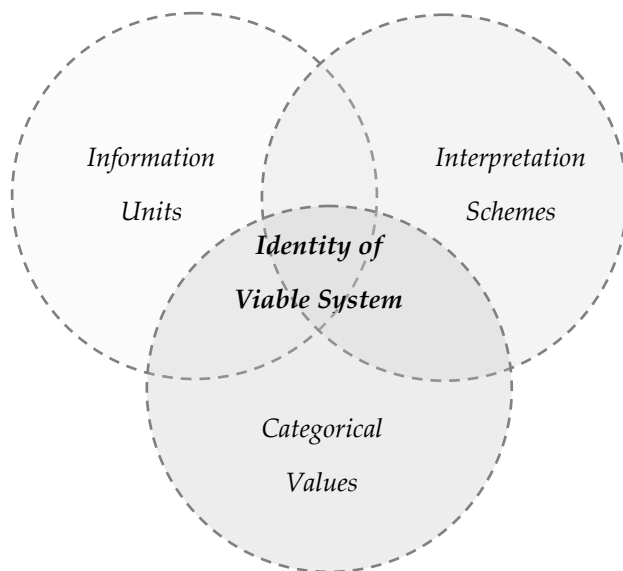

Figure 1. A possible representation of the Information Variety Model (Source: Authors' elaboration on Barile, 2009a. See [www.asvsa.org](http://www.asvsa.org))

What is relevant when interpreting a system's behaviour from a *VSA* perspective is its dynamic of interaction, as observed both internally and externally. The need to shift to a dynamic view is clarified by distinguishing between two different perspectives that can support the study of organized entities as viable systems (Barile & Saviano, 2011): a *static view* that allows the description of the structural configuration of a system by focusing on the parts that compose it and relations between them; and a *dynamic view* that interprets the ways in which a system behaves and evolves over time as a consequence of the interactions internal to its structure and with the external environment as subjectively construed by the decision-maker (context).

By establishing relationships and interacting, viable systems create recursive structural configurations that involve other systems. In the current highly interconnected scenario ever more effectively supported by ICTs, a common configuration is that of networked systems; i.e., systems of systems (XHerron & Mendiwelo-Bendek, (2006); Di Fatta *et al.*, 2016; 2017; Caputo & Walletzky, 2017). Although directed through regulation, the way these systems interact if not designed, however, is inevitably emergent. Hence, a fundamental problem is to have interaction directed towards the achievement of desired outcomes.

The *VSA* provides a useful criterion to evaluate the capability of a system to govern interaction towards the achievement of a planned goal; it depends on its degree of completion as a viable system (Barile, 2008). The *VSA* identifies three key evolutionary stages by distinguishing between the *embryonic system*, *systems in via of completion*, and *accomplished systems* (Golinelli, 2010). To evaluate the degree of completion of a system, it is necessary to verify, on the one hand, the presence and decision-making capabilities of a *governing body* – i.e., a subject recognized as responsible for the governance of the system – and, on the other hand, the functioning of an *operative structure*, as defined by the

intensity of interconnection among the parts that compose it and that are involved in the pursuit of the system's goal. The three degrees of accomplishment of the observed system give information about its capability of governance, its contractual power in relationships, and its capability of influencing other systems' behaviours (Barile & Saviano, 2010). As shown in Figure 2, the *embryonic system* is characterized by a set of components slightly and temporarily interconnected on the basis of emerging common interests; there is no recognized governing body, but only shared behavioural rules (an example is the market). The *system in via of completion* is characterized by emerging interactions among the parts that are activated in order to achieve specific goals through the definition of a temporary shared governing body supported by the formalization of a structure (e.g., a joint venture). Finally, *the accomplished system* is characterized by strong relationships among parts that share the willingness to achieve common aims and recognize a governing body (e.g., a company).

This latter entity can be considered a fully viable system, which means a system whose components are committed to the achievement of a common goal and produce coherent patterns of interaction. Accomplished systems are more effective in developing long-lasting synergistic relationships and co-creating value.

Connect ivity among the parts	High		<i>Accomplished system</i>
	Medium		<i>Systems in via of completion</i>
	Low	<i>Embryonic system</i>	
		Absent	Only partially or temporary recognized
			Present
		<i>Governing body</i>	

Figure 2. The system's degrees of accomplishment in the VSA perspective (Source: Authors' elaboration on Barile, 2008. [www.asvsa.org](http://www.asvsa.org))

## SMART CITY AS AN EXAMPLE OF A MULTI-DIMENSIONAL PHENOMENON

In the last few years, social sciences have devoted increasing attention to the problem of interactions between physical and human resources (Stjernholm Madsen, 2005; Caputo *et al.*, 2016c). Researchers have analysed the ways in which interactions take place and evolve in the social domains (Folke,

2006), the key variables able to affect and support social interactions (Yang & Chen, 2007), and the role of ICTs in ensuring efficient, effective, and sustainable social interactions (Del Giudice *et al.*, 2016).

Among the various topics under study in social sciences, Smart City represents an interesting research stream because it is a typical example of multi-dimensional context of interaction in which, in particular, human and physical resources are involved. Smart Cities are essentially targeted towards the improvement of the quality of life of communities (Townsend, 2013; Shapiro, 2006). In effect, as stated by Bakıcı *et al.* (2013: 138), the Smart City is the “implementation and deployment of information and communication technology infrastructures to support social and urban growth through improving the economy, citizens’ involvement and governmental efficiency”. This definition clarifies that the Smart City concept essentially deals with structural and infrastructural aspects of a technical nature that can impact on the efficient functioning of a system. Conversely, the concept of ‘quality of life’ represents a higher level and more meaningful goal that, although basically including elements that impact on a community’s way of living, such as pollution, traffic congestion, crime, etc., also refers to “factors such as sense of achievement, love and affection, perceived freedom, and so on” (Dalkey, 1971: 9). In this view, the notion of quality of life approaches that of “well-being” (Polese *et al.*, 2016). But more than anything else quality of life relates, as many have pointed out, to the capacity of the social systems to improve being, belonging and becoming conditions of its citizens. How the cities are empowering citizens to shape their city and their possibilities to progress and grow as individuals and collectively.

So far, the phenomenon of Smart City has been investigated from various viewpoints focusing on different dimensions (Nam & Pardo, 2011). Shapiro (2006), for example, underlines that the core essence of Smart City refers to the application of socio-technical innovations to support economic and social growth of a community; Paskaleva (2009) states that Smart City is the finalized use of innovative technologies and better performing infrastructures; Morvaj *et al.* (2011) point out the relevance of technological infrastructures in the functioning of Smart City.

Other researchers have focused attention on the role of citizens in Smart City and how to increase knowledge, skills and also how to observe structures and processes to enable effective citizens empowerment processes (Espejo & Mendiweso-Bendek, 2011; Mendiweso-Bendek, 2015). From this perspective, Winters (2010) analysed the key impact that citizens have in affecting the opportunity for the emergence and survival of Smart Cities; Edvinsson (2006) investigated the impact of Smart City configuration on human relationships and its relevance for the improvement of the quality of city life. Combining the technological and human perspectives, Karwowski *et al.* (2014) identified four key dimensions of Smart City: structure, process, outcome, and market.



Despite the advancements in knowledge offered by all these contributions and the effort to combine the various dimensions, a shared conceptual framework for the domain of Smart City is still missing (Saviano *et al.*, 2016). The existing literature on this topic, for example, does not provide a clear explanation about the ways in which a Smart City is created (or emerges) and remains viable, about the role of humans and the way their behaviours impact on the dynamics of a Smart City, about general reference approaches to managing the multiple dimensions on which Smart City functioning is inevitably based, and overcoming the divides between the different disciplines and perspectives involved.

In order to bridge this gap, in the next section an interpretation of Smart City through the interpretative lens of the *VSA* is proposed.

## **TOWARDS A VIABLE SYSTEMS VIEW OF SMART CITY**

As highlighted in the previous section, the main literature about Smart City focuses attention on the structural and infrastructural 'building' of the Smart City. Smart City, however, activates and develops a multi-dimensional functioning in which the role of humans, as citizens, cannot be taken as given. Be it explicitly designed to or not, a Smart City develops dynamics that give rise to the emergence of *socio-technical systems* (Weber, 2003). Looking at a Smart City as essentially a technological (ICT-based) phenomenon would provide a structural view of the same. Indeed, citizens as users are not only the beneficiaries of technological investments typical of a Smart City. They are key *actors* whose behaviour strongly impacts the effective (and sustainable) functioning of a Smart City. Hence, combining the technological and human perspectives is fundamental. Adequate consideration of the citizens' perspectives makes apparent the most challenging aspect of Smart City: although designed to be 'smart', the emerging socio-technical configuration does not ensure a 'smart' functioning. As clarified by *VSA*, from the same structure multiple systems can emerge depending on the goals pursued by actors involved in its dynamics. Human (viable) systems finally determine the 'smart' functioning of a city and their behaviours cannot be 'designed'; however, at least they can be regulated and/or incentivized.

Accordingly, although designed to be smart, a city's functioning will always be emergent due to humans' unpredictable behaviours. A way to direct or influence humans' behaviours is through the effective guidance of a recognized governing body or through the effective sharing of a common system of laws, norms and rules (Barile & Saviano, 2010; Caputo *et al.*, 2016a).

In this manner, a Smart City, which, in *VSA* terms, is at least an embryonic system, can easily evolve to the configuration of a system in the process of completion, which would allow an effective smart functioning, synergistically contributed to (or co-created) by all involved actors.

To integrate this view with the previous literature about Smart Cities, in order to progress towards the building of a shared conceptual framework, it is possible to identify at least three essential elements to focus on: *citizens* (Nam & Pardo, 2011), *infrastructures* (Jin *et al.*, 2014), and *high quality of citizen life* (Shapiro, 2006).

The interpretative models proposed by the *vSA* can be used to base a multi-dimensional analysis of not only the Smart City's structure and infrastructures, but also (and mainly) of its social dynamics. In the *vSA* view: the *citizens*, as the only full viable entities able to assess, analyse, decide and act accordingly, are key actors of a Smart City; the *infrastructures* represent the ways through which citizens interact with the physical and technological resources of Smart City in order to achieve their aims; the *high quality of citizen life* represents the shared goal that can activate the synergistic functioning from which the Smart City system can emerge.

By integrating the Smart City components in the *vSA* framework, as shown in Figure 3, it is possible to identify a strong correlation among them and the elements that affect the degree of accomplishment of a system defined by the *vSA*: the set, the structure, and the system.

By adopting the interpretative lens of the *vSA*, it is possible to note that the goal 'high quality of citizen life' is the outcome of a unitary systemic functioning of the City that implies its full completion. Citizens and resources represent the set of possible components of the system's structure. The ways in which citizens are connected to resources define the structure. Indeed, the *vSA* underlines that a Smart City will emerge only if citizens, as viable actors – i.e., systems capable of an autonomous existence in their environment (Beer, 1979) – embrace the shared finality of a 'high quality of life' and behave accordingly, producing coherent patterns. Therefore, a Smart City emerges as a consequence of a shared willingness to achieve the common aim of the high quality of citizen life. According to the Information Variety Model, it is possible to state that to ensure a shared willingness to achieve the aim of high quality of city life, it is not sufficient to act upon the information units (e.g., information sharing); an analysis of dominant and/or common interpretation schemes and of the categorical values that influence their decisions and behaviours is necessary to assess what the *vSA* calls the conditions of consonance (Barile, 2013; Barile & Saviano, 2013). In this view, Smart City becomes a conceptual model for creating social configurations of people, technology, information, and values, the integration of which allows for the emergence of a viable system

Connectivity among the parts	High		<b>System</b>	
	Medium		<b>Structure</b>	
	Low	<b>Set</b>		
		Absent	Only partially or temporarily recognized Governing body	Present

Figure 3 The Smart City's system in the vSA perspective (Source: Authors' elaboration)

## PRACTICAL IMPLICATIONS AND CONCLUDING REMARKS

As illustrated with reference to the case of Smart City, many researchers interested in studying socio-economic dynamics have tried to address their complexity by enriching models in order to include their multiple dimensions. Re-affirming the need for a space to hold constructed conversations about conceptual social sciences frameworks, this paper highlights the advantages of applying systems thinking as an interpretative lens have a wider and deeper understanding of the dynamics and dimensions of social phenomena and the ways they interact.

By discussing the case of Smart City, the paper highlights the ways systems thinking can be applied to a social configuration that involves multiple structural levels, actors, and perspectives: the vSA helps to deal with complex multi-dimensional dynamics by exploring the key rules of effective interaction. The domain of Smart City is analysed in the light of the vSA perspective in order to underline in which ways different elements interact and should be managed in order to ensure the viability of the whole configuration.

From the application of the vSA to the understanding and management of Smart City, several managerial implications have been derived. Specifically, the vSA indicates directions for a better understanding of the ways users, services, infrastructure, and technologies interact to produce a coherent whole. The vSA helps to identify general level rules that explain the emergence and evolution over time of an organized entity.

Thanks to the application of the vSA, several opportunities have been demonstrated which would help to bolster the success of the Smart City plans. The vSA can support the understanding of requirements for a more efficient, effective, and sustainable organization of citizens' life, and, consequentially, the

development of better performing instruments, techniques, and models for the effective governance of Smart City.

In conclusion, the success in planning and management of Smart City as a Viable System is related to the ability to investigate its components and the relations that link them, without losing the view of the whole: it is interaction that produces coherent patterns of behaviours (Mendiwelo-Bendek, 2002). By adopting this interpretative approach, useful guidelines for the management of Smart City and new research pathways in the domain of Smart City can be derived by the application of systems thinking approaches like *vSA*; these developments, however, are not within the scope of this paper and could be analysed in future research.

## REFERENCES

- Anderson, P. (1999), "Perspective: complexity theory and organization science", *Organization Science* Vol. 10 No. 3, pp. 216-232.
- Anttiroiko, A.V., Valkama, P., Bailey, S.J. (2014), "Smart cities in the new service economy: building platforms for smart services", *AI & Society*, Vol, 29 No. 3, pp. 323-334.
- Bakıcı, T., Almirall, E., Wareham, J. (2013), "A smart city initiative: the case of Barcelona", *Journal of the Knowledge Economy*, Vol. 4 No 2, pp. 135-148.
- Barile, S. (2000), *Contributi sul pensiero sistemico in economia d'impresa*. Arnia: Salerno.
- Barile, S. (2008), *L'impresa come sistema: contributi sull'Approccio Sistemico Vitale (ASV)*, Giappichelli, Torino.
- Barile, S. (2009a), *Management Sistemico Vitale. Parte Prima: Decidere in Contesti Complessi*, Giappichelli, Torino.
- Barile, S. (2009b), "The dynamic of informative varieties in the processes of decision making", in *The 3rd International Conference on Knowledge Generation, Communication and Management*, Orlando, Florida.
- Barile, S. (Ed.) (2013), *Contributions to theoretical and practical advances in management. A viable systems approach (vSa)*, Aracne, Roma.
- Barile, S., Saviano, M. (2010). "A new perspective of systems complexity in service science", *Impresa, Ambiente, Management*, Vol. 4 No. 3, pp. 375-414.
- Barile, S., Saviano, M. (2011). "Foundations of systems thinking: the structure-system paradigm", in VV.AA., *Contributions to theoretical and practical advances in management. A Viable Systems Approach (vSa)* (pp. 1-24), International Printing, Avellino.
- Barile, S., Saviano, M. (2013), "An introduction to a value co-creation model. Viability, syntropy and resonance in dyadic interaction", *Syntropy Vol. 2*, pp. 69-89.
- Barile, S., Carrubbo, L., Iandolo, F., Caputo, F. (2013), "From 'EGO' to 'ECO' in B2B relationships", *Journal of Business Market Management* Vol. 6 No. 4, pp. 228-253.
- Barile, S., Lusch, R., Reynoso, J., Saviano, M., Spohrer, J. (2016), "Systems, networks, and ecosystems in service research", *Journal of Service Management*, Vol. 27 No. 4, pp. 652-674.
- Barile, S., Pels, J., Polese, F., Saviano, M. (2012), "An introduction to the viable systems approach and its contribution to marketing", *Journal of Business Market Management*, Vol. 5 No. 2, pp. 54-78.
- Barile, S., Saviano, M., Caputo, F. (2015), "How are markets changing? The emergence of consumers market systems", in Dominici G, (Eds.), *3rd International Symposium. Advances in Business Management. Towards Systemic Approach* (pp. 203-207), *Systems Laboratory E-book series*, Palermo.
- Basile, G., Caputo, F. (2017), "Theories and Challenges for Systems Thinking in Practice", *Journal of Organisational Transformation & Social Change*, Vol. 14, No. 1, pp. 1-3
- Beck, U., Sznaider, N. (2006), "Unpacking cosmopolitanism for the social sciences: a research agenda", *The British Journal of Sociology*, Vol. 57 No. 1, pp. 1-23.
- Beer, S. (1979), *The Heart of Enterprise*, John Wiley & Sons, New York.
- Beer, S. (1984), "The viable system model: its provenance, development, methodology and pathology", *Journal of the Operational Research Society*, Vol. 35 No. 1, pp. 7-25.

- Blanche, M.T., Durrheim, K., Painter, D. (2006), *Research in Practice: Applied Methods for the Social Sciences*, Juta and Company Ltd., London.
- Bogdanov, A.A. (1989), *Tectology: Universal Organizational Science*, Finance, Moscow.
- Bohman, J. (1993), *New Philosophy of Social Science: Problems of Indeterminacy*, The MIT Press, Cambridge.
- Boulding, K.E. (1956), *General systems theory – the skeleton of science*. *Management science*, Vol. 2 No. 3, pp. 197-208.
- Bowler, T.D. (1981), *General Systems Thinking: Its Scope and Applicability*, North Holland, London.
- Calabrese, M., Iandolo, F., Caputo, F., Sarno, D. (2017), "From mechanical to cognitive view: The changes of decision making in business environment", in Barile, S., Pellicano, M., Polese, F. (eds.), *Social Dynamics in a System Perspective*, Springer, New York.
- Caputo, F. (2017), "Reflecting upon Knowledge Management studies: insights from Systems thinking", *International Journal of Knowledge Management studies* (in press).
- Caputo, F., Del Giudice, M., Evangelista, F., Russo, G. (2016a), "Corporate disclosure and intellectual capital. The light side of information asymmetry", *International Journal of Managerial and Financial Accounting*, Vol. 8 No. 1, pp. 75-96.
- Caputo, F., Evangelista, F., Russo, G. (2016c), "Information Sharing and Communication Strategies: a Stakeholder Engagement view", in Vrontis D., Weber Y., Tsoukatos E. (eds.), *Innovation, Entrepreneurship and Digital Ecosystems* (pp. 436-442), EuroMed press, Cyprus.
- Caputo, F., Formisano, V., Buronova, B., Wallezky, L. (2016c), "Beyond the digital ecosystems view: insights from Smart Communities", in Vrontis D, Weber Y, Tsoukatos E (eds), *Innovation, Entrepreneurship and Digital Ecosystems* (pp. 443-454), EuroMed Press: Cipro.
- Caputo F. Wallezky L. (2017), "Investigating the users' approach to ICT platforms in the city management", *Systems*, Vol. 5, No. 1. doi:10.3390/systems5010001.
- Checkland, P. (1985), "From optimizing to learning: a development of systems thinking for the 1990s", *Journal of the Operational Research Society*, Vol. 36 No. 9, pp. 757-767.
- Dalkey, N.C. (1971), "An elementary cross-impact model", *Technological forecasting and social change*, Vol. 3, pp. 341-351.
- Del Giudice, M., Caputo, F., Evangelista, F. (2016), "How are decision systems changing? The contribution of Social Media to the management decisional liquefaction", *Journal of Decision Systems*, Vol. 25 No. 3, pp. 214-226.
- Del Giudice, M., Ahmad, A., Scuotto, V., Caputo, F. (2017), "Influences of Cognitive Dimensions on the Collaborative Entry Mode Choice of Small and Medium-Sized Enterprises", *International Marketing Review*, Vol. 34, No. 5, (in press).
- Di Fatta, D., Caputo, F., Evangelista, F., Dominici, G. (2016), "Small world theory and the World Wide Web: Linking small world properties and website centrality", *International Journal of Markets and Business Systems*, Vol. 2 No. 2, pp. 126-140.
- Di Nauta, P., Merola, B., Caputo, F., Evangelista, F. (2015), "Reflections on the Role of University to Face the Challenges of Knowledge Society for the Local Economic Development", *Journal of Knowledge Economy*, pp. 1-19.
- Edvinsson, L. (2006), "Aspects on the city as a knowledge tool", *Journal of Knowledge Management*, Vol. 10 No. 5, pp. 6-13.
- Espejo, R. (1990), "The viable system model", *Systemic Practice and Action Research*, Vol. 3 No. 3, pp. 219-221.
- Espejo, R., Harnden, R. (Eds) (1989), *The Viable System Model: Interpretations and Applications of Stafford Beer's VSM*, Wiley, London.
- Espejo, R., Mendiweso-Bendek, Z. (2011), "An argument for active citizenship and organisational transparency", *Kybernetes*, Vol. 40 No. 3/4, pp. 477-493.
- Espejo, R., Reyes, A. (2011), *Organizational Systems: Managing Complexity with the Viable System Model*, Springer Science & Business Media, New York.
- Evangelista, F., Caputo, F., Russo, G., Buhnova, B. (2016), "Voluntary corporate disclosure in the Era of Social Media", in Caputo F. (Ed.), *The 4rd International Symposium Advances in Business Management. "Towards Systemic Approach"* (pp. 124-128), Business Systems. E-book series, Avellino.
- Folke, C. (2006), "Resilience: the emergence of a perspective for social-ecological systems analyses", *Global Environmental Change*, Vol. 16 No. 3, pp. 253-267.
- Galanakis, K. (2006), "Innovation process. Make sense using systems thinking", *Technovation*, Vol. 26 No. 11, pp. 1222-1232.
- Gell-Mann, M. (1995), *The Quark and the Jaguar: Adventures in the Simple and the Complex*, Macmillan: London.

- Gergen, K.J. (1985), "The social constructionist movement in modern psychology", *American Psychologist* Vol. 40 No. 3, pp. 266-281.
- Giddens, A. (1979), *Central Problems in Social Theory: Action, Structure, and Contradiction in Social Analysis*, University of California Press, West Sussex.
- Golinelli, G.M. (2000), *L'approccio sistemico vitale*, Giappichelli, Torino.
- Golinelli, G.M. (2005), *L'approccio sistemico al governo dell'impresa. L'impresa sistema vitale*, Cedam, Padova.
- Golinelli, G.M. (2010), *Viable Systems Approach (VSA), Governing Business Dynamics*, Cedam, Padova.
- Hatch, M.J., Cunliffe, A.L. (2006), *Organization Theory: Modern, Symbolic and Postmodern Perspectives*, Oxford University Press, Oxford.
- Hedström, P., Ylikoski, P. (2010), "Causal mechanisms in the social sciences", *Annual Review of Sociology*, Vol. 36, pp. 49-67.
- Holling, C.S. (2001), "Understanding the complexity of economic, ecological, and social systems", *Ecosystems*, Vol. 4 No. 5, pp. 390-405.
- Huysman, M., Wulf, V. (2006), "IT to support knowledge sharing in communities, towards a social capital analysis", *Journal of Information Technology*, Vol. 21, No. 1, pp. 40-51.
- Jackson, M.C. (1992), "The soul of the viable system model", *Systemic Practice and Action Research*, Vol. 5 No. 5, pp. 561-564.
- Jackson, M.C. (2003), *"Systems Thinking: Creative Holism for Managers"*, Wiley, Chichester.
- Jin, J., Gubbi, J., Marusic, S., Palaniswami, M. (2014), "An information framework for creating a smart city through internet of things", *IEEE Internet of Things Journal*, Vol. 1 No. 2, pp. 112-121.
- Johns, T., Laubscher, R.J., Malone, T.W. (2011), "The Age of Hyper Specialization", *Harvard Business Review*, Vol. 89 No. 7/8, pp. 56-65.
- Karwowski, W., Ahram, T., Amaba, B. (2014), "A system-of-systems engineering approach to leadership and innovation: sustainable STEM education and workforce development through the Smart Cities initiative", in *QScience Proceedings (World Congress on Engineering Education 2013)*, Bloomsbury Qatar Foundation Journals, Qatar.
- Lawson, R., Todd, S. (2002), "Consumer lifestyles: a social stratification perspective", *Marketing theory* Vol. 2 No. 3, pp. 295-307.
- Lofland, J., Lofland, L.H. (2006), *Analyzing Social Settings*, Wadsworth Publishing Company, Belmont, CA.
- Maani, K.E., Maharaj, V. (2004), "Links between systems thinking and complex decision making", *System Dynamics Review*, Vol. 20 No. 1, pp. 21-48.
- Manski, C.F. (1995), *Identification Problems in the Social Sciences*, Harvard University Press, Cambridge.
- Maturana, H.R. (1975), "The organization of the living: a theory of the living organization", *International Journal of Man-Machine Studies*, Vol. 7 No. 3, pp. 313-332.
- May, R.M. (1976), "Simple mathematical models with very complicated dynamics", *Nature*, Vol. 261, pp. 459-467.
- Mendiawelso-Bendek, Z. (2015), "Community-based research: enabling civil society's self-organisation", *Kybernetes*, Vol. 44 No. 6/7, pp. 903-912.
- Mendiawelso-Bendek, Z. (2002), "Citizens of the future: beyond normative conditions through the emergence of desirable collective properties". *Journal of Business Ethics*, Vol. 39 No. 1/2, pp. 189-195.
- Mingers, J.C. (1980), "Towards an appropriate social theory for applied systems thinking: critical theory and soft systems methodology", *Journal of Applied Systems Analysis*, Vol. 7, pp. 41-49.
- Morvaj, B., Lugaric, L., Krajcar, S. (2011), "Demonstrating smart buildings and smart grid features in a smart energy city", in *Energetics (IYCE), Proceedings of the 2011 3rd International Youth Conference on. IEEE* (pp. 1-8).
- Nam, T., Pardo, T.A. (2011), "Conceptualizing smart city with dimensions of technology, people, and institutions", in *Proceedings of the 12th Annual International Digital Government Research Conference: Digital Government Innovation in Challenging Times*, ACM (pp. 282-291).
- Parsons, T., Shils, E.A., Smelser, N.J. (Eds) (1965), *Toward a General Theory of Action: Theoretical Foundations for the Social Sciences*, Transaction Publishers, London.
- Paskaleva, K.A. (2009), "Enabling the smart city: the progress of city e-governance in Europe", *International Journal of Innovation and Regional Development*, Vol. 1, No. 4, pp. 405-422.
- Polese, F., Caputo, F., Carrubbo, L., Sarno, D. (2016), "The value (co)creation as peak of social pyramid", in Russo-Spena T., Mele C. (eds.), *Proceedings 26th Annual RESER Conference, "What's ahead in service research: new perspectives for business and society"* (pp. 1232-1248), University of Naples "Federico II": Reser.
- Rosenberg, A. (2015), *Philosophy of Social Science*, Westview Press, Boulder, Colorado.
- Saviano, M., Caputo, F. (2013), "Managerial choices between systems, knowledge and viability", in Barile S. (Ed.), *Contributions to Theoretical and Practical Advances in Management. A Viable Systems Approach (VSA)*, (pp. 219-242), Aracne: Roma.

- Saviano, M., Caputo, F., Formisano, V., Wallezky, L. (2016), "From theory to practice in systems studies: a focus on Smart Cities", in Caputo F (Ed), 4rd International Symposium Advances in Business Management. "Towards Systemic Approach" (pp. 35-40), Business Systems E-Book Series, Palermo.
- Saviano, M., Parida, R., Caputo, F., Kumar Datta, S. (2014), "Health care as a worldwide concern. Insights on the Italian and Indian health care systems and PPPs from a VSA perspective", *EuroMed Journal of Business*, Vol. 9 No. 2, pp. 198-220.
- Schein, E.H. (1985), *Organisational Culture and Leadership: A Dynamic View*, Jossey-Boss, San Francisco.
- Schwaninger, M. (2006), "Design for viable organizations: the diagnostic power of the viable system model", *Kybernetes*, Vol. 35 No. 7/8, pp. 955-966.
- Senge, P.M., Sberman, J.D. (1992), "Systems thinking and organizational learning: acting locally and thinking globally in the organization of the future", *European Journal of Operational Research*, Vol. 59 No. 1, pp. 137-150.
- Shapiro, J.M. (2006), "Smart cities: quality of life, productivity, and the growth effects of human capital", *The Review of Economics and Statistics*, Vol. 88 No. 2, pp. 324-335.
- Škerlavaj, M., Štemberger, M.I., Dimovski, V. (2007), "Organizational learning culture – the missing link between business process change and organizational performance", *International Journal of Production Economics*, Vol. 106 No. 2, pp. 346-367.
- Stacey, R.D., Griffin, D., Shaw, P. (2000), *Complexity and Management: Fad or Radical Challenge to Systems Thinking?*, Psychology Press, London.
- Stjernholm Madsen, A., Ulhøi, J.P. (2005), "Technology innovation, human resources and dysfunctional integration", *International Journal of Manpower*, Vol. 26 No. 6, pp. 488-501.
- Townsend, A.M. (2013), *Smart Cities: Big Data, Civic Hackers, and the Quest for a New Utopia*, WW Norton & Company, New York.
- Tronvoll, B., Barile, S., Caputo, F. (2017), "A systems approach to understanding the philosophical foundation of marketing studies", in Barile, S., Pellicano, M., Polese, F. (eds.) *Social Dynamics in a System Perspective*, Springer, New York.
- Von Bertalanffy, L. (1968), *General Systems Theory*, George Braziller, New York.
- Von Bertalanffy, L., Rapoport, A. (eds) (1963), *General Systems*, Society for General Systems Research, Wiley, New York.
- Von Foerster, H. (1984), *Observing Systems*, Intersystems Publications, London.
- von Glasersfeld, E. (2001), "The radical constructivist view of science", *Foundations of Science*, Vol. 6 No. 1-3, pp. 31-43.
- VV.AA. (2011), *Contributions to theoretical and practical advances in management. A Viable Systems Approach (VSA)*. International Printing: Avellino.
- Weber, K.M. (2003), "Transforming large socio-technical systems towards sustainability: on the role of users and future visions for the uptake of city logistics and combined heat and power generation", *Innovation: The European Journal of Social Science Research*, Vol. 16 No. 2, pp. 155-175.
- Weber, M. (1949), *The Methodology of the Social Sciences*, The Free Press of Glencoe, Illinois.
- Winters, J.V. (2010), "Why are smart cities growing? Who moves and who stays", *Journal of Regional Science*, Vol. 51 No. 2, pp. 253-270.
- [www.asvsa.org](http://www.asvsa.org)
- XHerron, R., Mendiwelo-Bendek, Z. (2006), "Building community networks for Active Learning for Active Citizenship", *OR insight*, Vol. 19 No. 2, pp. 18-24.
- Yang, C., Chen, L.C. (2007), "Can organizational knowledge capabilities affect knowledge sharing behavior?", *Journal of Information Science*, Vol. 33 No. 1, pp. 95-109.

## TAYLORISM AND AMAZON: SCIENTIFIC MANAGEMENT AT THE WORLD'S MOST SUCCESSFUL RETAIL COMPANY

**Schein, Andrew**

Business School, Netanya Academic College, Netanya Israel

### ABSTRACT

Over the past hundred years many management theories have been proposed to help owners and managers of firms get the best results from their firms. However, there abounds much skepticism concerning the effectiveness of these theories. In this paper, we return to one of the first management theories, Taylorism or scientific management, and review its positive goal of helping firms produce more efficiently and the claim that it dehumanizes workers. Furthermore, we review the growth of Amazon and show how Amazon embodies most of the principles of Taylorism, except that while Taylor had a disdain for workers' initiative, Amazon encourages workers to initiate projects. The paper ends with a brief discussion as to whether Amazon could have grown even more had its management been more employee-friendly.

*Keywords: Fredrick Taylor, Jeff Bezos, e-commerce, online shopping, hi-tech retail*

### INTRODUCTION

With the growth of large firms in the last 150 years, many management theories have been suggested to explain the best methods for managers to manage these large firms. One of the first theories of management was the theory of scientific management or Taylorism. In the period after WWII, the theory became much maligned since it was considered to not be in consonance with the modern times because it was contended that it led to workers being mistreated. However, in the twentieth first century, a version of Taylor has been revived in the fascinating story of Amazon, the largest online retailer in the US in 2017.

In this paper, we will briefly review Taylorism, and the amazing growth of Amazon. Afterwards, we will discuss how Taylorism applies to Amazon's management practices, and we end with a discussion of whether Amazon could be even more successful if it was more employee-friendly.



## TAYLORISM

Fredrick Winslow Taylor (1856-1915), who on his death, *The New York Times* (1915) referred to as the "originator of modern methods of industrial management," stressed the idea of efficiency in production and the manager's role in having the work done in the most productive manner. His theory is referred to as the scientific theory of management since he claimed that his method was scientific, or Taylorism.

Taylor was bothered by workers who were, he claimed, not working to their utmost ability, what he called soldiering or loafing. He writes (1919, p. 33):

It is well within the mark to state that in nineteen out of twenty industrial establishments the workmen believe it to be directly against their interests to give their employers their best initiative, and that instead of working hard to the largest possible amount of work and the best quality of work for their employers, they deliberately work as slowly as they dare while at the same time try to make those over them believe that they are working fast.

He claims that this soldiering is the cause both of low wages and low output, and he set out to correct this "evil."

Taylor notes that he was not the first person to note this problem of workers not working to their potential and he describes what he claimed was the best type of management system prior to his system, which he calls "initiative and incentive." In this system, the manager uses higher pay, promotions, and better working conditions, as incentives for a worker to work harder. While this may seem like a reasonable system, Taylor (pp. 35,36) claims that success in this system "depends almost entirely upon getting the 'initiative' of the workmen and it is indeed a rare case in which this initiative is really attained." Instead, Taylor proposed his theory of scientific management.

Taylor explains that there are four elements to his theory of scientific management. One, the manager is to develop a science for each element of a man's work, as opposed having each man decide on his own how best to accomplish the task. This "science" means that the manager is to decide not only what work is to be done, but also how it is to be done and in how much time. The work is divided into as many smaller tasks as possible and each individual task is timed. Two, the manager is to select and train the best workers. Three, the manager is to cooperate with the workers, and four, management does all the work for which they are better fitted than the workers. *The Economist* (2015) compresses these four elements into three categories: "Break complex jobs down into simple ones; measure everything that workers do; and link pay to performance, giving bonuses to high-achievers and sacking sluggards."

Taylor attempted to implement his ideas in various factories and he claimed great success. For instance, in 1898, Taylor went to work for Bethlehem Steel Company, and he "determined" that the

workers could be working harder, that a worker could move between 47-48 tons of pig iron a day instead of the 12.5 tons they were doing beforehand. He then selected some workers, paid them a little extra, \$1.85 a day instead of \$1.15, had a man stand over the workers with a watch telling them when they could work and when they could rest, and "all of the pig iron was handled at the rate of 47.5 tons" (p. 47).

Even though the workers were working harder, Taylor claimed that his system was beneficial for the workers since a worker's prosperity will increase when he/ she is producing at his/ her maximum capacity, and the workers' wages also will rise, as in the Bethlehem Steel Company, the salaries of the selected workers increased by 60%. As further proof of the worker's greater happiness with his system, he writes (p. 28) that in companies where his system had been implemented, "in place of the suspicious watchfulness and more or less open warfare which characterizes the ordinary types of management, there is universally friendly cooperation between the management and the men." Accordingly, Taylor claimed that his system was a win-win situation both for the workers and for the firms.

Many people have supported Taylor's approach. For example, Peter Drucker stated that Taylor deserves to be ranked with Darwin and Freud in the trinity of makers of the modern world and that Taylorism is perhaps the most powerful as well as the most lasting contribution America has made to Western thought since the Federalist Papers. (Will, 1997, p. 8)

However, even Drucker (1974, p. 202), believes that the followers of scientific management, or as he calls them industrial engineers, only focus on the "logic of work" how the work is to be done, and not enough on the "logic of working" how to motivate the workers.

More trenchant criticism is that Kiechel (2012, p. 66) writes that "behind the effort of Taylor was an elitism, a class of arrogance, almost incomprehensible by today's standards." For example, Taylor (1919, p. 59) described the worker who moved the pig iron as "so stupid and so phlegmatic that he more nearly resembles in his mental make-up the ox than any other type." Kiechel (2012, pp. 65, 67) notes:

The publication of Taylor's scientific managements set off a century-long quest for the right balance between the things of production and the humanity of production...The overall thrust of the postwar managerial thinkers was to elevate the humanity of production.

Thus, Taylorism would have been expected to have become passé by the twentieth first century due to the perception that it was not in consonance with the humanity of production since it was claimed that it led to workers being treated harshly. However, it is having a revival in one of the most successful companies in the US in the twentieth first century, Amazon, which seems to have adopted a managerial style analogous to Taylorism.

## THE RISE OF AMAZON

In the 1980s and the 1990s, the retail book industry in the US had become highly concentrated. The independent booksellers, who previously had been the major sellers of books, were being pushed out by large bookstore chains, such as Barnes & Noble, Borders, and a few others firms, and it seemed that these large chains were going to be the dominant firms in the market for the foreseeable future (Bekken, 1997/98). However, the internet was shortly going to upend these large firms.

In 1994, the internet was just beginning and Jeff Bezos realized the great potential of the internet for selling goods, as he had read that the use of the web then was growing at a rate of 2,000% a year (Martinson, 2000). Bezos quit his job in finance and founded Amazon to sell books on the internet. He chose this product since he realized that even the large bookstore chains did not stock that many books in each store, which could give a seller on the internet an advantage since the online store could list many more books for sale (Packer, 2014). The Amazon website began to function on July 16, 1995, and almost immediately, sales began to pour in (Brandt, 2011). Amazon has since branched into numerous fields selling clothing, toys, electronic products (for example the Kindle, first released in 2007), music, entertainment, grocery items, and even cloud service, AWS. In 2014, it was estimated that "Amazon carried 230 million items for sale in America—some 30 times the number sold by Walmart, the world's biggest retailer" (*The Economist*, 2014).

In 2017, *The Economist* (2017a, p. 9) noted that

Amazon is an extraordinary company. The former bookseller accounts for more than half of every new dollar spent online in America. It is the world's leading provider of cloud computing. This year Amazon will probably spend twice as much on television as HBO, a cable channel. Its own-brand physical products include batteries, almonds, suits and speakers linked to a virtual-activated assistant that can control, among other things, your lamps and sprinklers.

In addition, Wingfield (2017) notes that many analysts are predicting that in 2017 Amazon will replace Macy's as the largest seller of apparel in America. Amazon's influence on American shoppers has even generated the term "the Amazon ecosystem" and marketers in the US must set their ad campaigns based on Amazon's website if they want their product to be marketed successfully (Maheshwari, 2017).

This amazing growth is expected to continue in the foreseeable future. Morgan Stanley has predicted that Amazon's sales will rise by a compound average of 16% each year from 2016 through to 2025. Since 1950, no company with sales of more than \$100bn has grown by an average of 15% or more for ten years. Amazon's annual sales in 2016 were \$136bn, so the Economist (2017a, p. 22) notes that if Morgan Stanley's prediction is correct then "it would be the most aggressive expansion of a giant company in the history of modern business."

Despite its huge growth in sales, Amazon is not noted for its large profits since Bezos' strategy has always been to lower prices to consumer to increase sales and to forgo current profits (Thompson, 2013). A better way to measure Amazon's great success is through the incredible increase in Amazon's stock price and market capitalization.

Amazon had its IPO on 15 May 1997 at \$18 a share, when it raised \$54 million dollars for a market valuation of \$440 million dollars (Hoffman 2017 and Shen 2017). Amazon has had three stock splits, on 2 June 1998 (2 for 1), on 5 January 1999 (3 for 1) and on 2 September 1999 (2 for 1) which means that after accounting for the stock splits the initial share price was \$1.5 ([www.stocksplithistory.com/amazon-com/](http://www.stocksplithistory.com/amazon-com/)). This period of stock splits coincided with the dot-com craze/ bubble of the late 1990s, and during this period Amazon's stock rose to \$106 with a market capitalization of \$36 billion dollars. When the dot-com bubble broke in 2000/01, Amazon's market capitalization declined to \$2.2 billion dollars, and its share price fell to \$6. In the following years, the stock price rebounded to \$60 in 2003, but then it fell again, unrelated to any crises in the market, to \$26 in July 2006. At that point, the stock started to soar (Stoffel, 2016). Perry (2015) notes:

From January 2005 to December 2006, shares of Amazon and Wal-Mart stock were trading at about the same price. During the 24-month period, Amazon's share price averaged \$38.22 while Wal-Mart's stock averaged \$38.27 per share. Since then Amazon's share price has increased almost 16 times to nearly \$600 compared to about a 1.5 time increase in Wal-Mart's share to \$58.

This difference has continued to grow since Perry made this point in October 2015. In the first half of 2017, Amazon's stock price passed a \$1,000, a price that only a few American companies have reached (The Economist 2017b). On 26 July 2017, Amazon's share price was \$1,052.8, an increase of 75% from October 2015, while Wal-Mart's share price was \$78.90, a very respectable increase of 36%, but still less than the growth rate of Amazon's share price.

Sommer (2017) calculated that from 2002 to July 2017, Amazon's stock price rose by more than 8,200% and that if a person had invested a \$1,000 in Amazon in 2002, then in July 2017 it would have been worth \$83,000. Sommer writes that the rise in Amazon's stock price is "one of the great tales in the history of capitalism."

On 26 July 2017, Amazon's market capitalization passed \$500 billion dollars (Gonzales, 2017). In July 2017, the only companies in the US that had a larger market capitalization than Amazon were Apple (\$800 billion dollars), Alphabet (Google, \$657 billion dollars) and Microsoft (\$571 billion dollars). These three companies are high-tech companies, and we see that Amazon has made itself to be considered and hence valued as a high-tech firm and not as a "simple retailer."

## TAYLORISM AND AMAZON

There are several reasons for Amazon's great success, its business strategy, its commitment to consumer service, and its great technology for storing, sorting and delivering goods ("fulfillment centers"), but what about its management practices?

A major component of Amazon's managerial practices is Amazon's obsession with measuring everything, as Anders (2012) writes that "Bezos calls it a culture of metrics." This measuring refers both to measuring consumers in their purchases and preferences and the workers' productivity. Kantor and Streitfeld (2015) quote Amy Michaels, a former Kindle marketer, who noted that Amazon runs "a continual performance improvement algorithm on its staff." Furthermore, Kantor and Streitfeld note that at Amazon, workers "are held to standards that the company boasts are unreasonably high." This "culture of metrics" with regard to the workers re-calls Taylor's system of dividing the tasks of each working, timing the worker as to how quickly the worker is able to perform the task, and pushing the workers to work beyond the industry norm.

Brandt (2011) provides an example of this drive in Amazon to get workers to be more productive beyond the norm from Amazon's early years. In 1999, the customer service had about 500 people whose job it was to answer emails from consumers.

The best of them could answer a dozen emails a minute. Those who dropped below seven were often fired. One customer-service manager recalled that, when the staff got a week and a half behind in answering email- despite putting in 12-hour days, seven days a week – Mr. Bezos called her to complain. When she told him they couldn't work any harder, he came up with a solution: They dedicated one weekend to competing with each other to see who could get through the most unanswered emails. During that 48-hour period, everyone worked at least ten hours beyond their regular shifts. Each person was given a cash bonus of \$200 for every thousand messages he or she could answer. It cleared out the backlog.

A more recent example of Amazon driving its workers to perform beyond the industry standard is reported by Young (2013):

Amazon warehouse employees (or, as the company calls them, "fulfillment center associates") contend they're told by Amazon and outsourced managers to meet productivity goals designed to be unattainable for most in an effort to keep them in a perpetual state of insecurity about their continued employment. If they give up or are fired, there's a legion of temp workers -- recruited by subcontracted labor recruiters who have offices inside the warehouse facility -- waiting to take their turn processing hundreds of packages per hour...

A source who went undercover at an Amazon sorting center in California for eight weeks this summer as part of academic research into warehouse working conditions told International Business

Times that Amazon wanted its employees to pack about 240 boxes per hour. A floor manager, with experience at multiple logistics firms, conceded to this source that the industry standard was only about 150.

*The Economist* (2015, p. 63) makes this connection between Amazon's management practices and Taylorism as it refers to Amazon's management practices as digital Taylorism. They write:

Amazon uses classic Taylorist techniques to achieve efficiency: workers are constantly measured and those who fail to hit the numbers are ruthlessly eliminated, personal tragedies notwithstanding....

This new version of Taylor's theory starts with his three basic principles of good management but supercharges them with digital technology and applies them to a much wider range of employees – not just Taylor's industrial workers but also service workers, knowledge workers and managers themselves. In Taylor's world, managers were the lords of creation. In the digital world they are mere widgets in the giant corporate computer.... And Taylorist managers are mixing the sweet with the bitter: Amazon's "Amabots", as they call themselves, seem happy to put up with micromanagement if they get a nice bonus at the end of the year. The most basic axiom of management is "what gets measured gets managed". So the more the technology of measurement advances, the more we hand power to Frederick Taylor's successors.

*The Economist* (2015) also noted another similarity between Amazon and Taylorism that "digital Taylorism is just as unpopular as its stopwatch-based predecessor." This assessment is based on the article by Kantor and Streitfeld (2015) who reported that many workers at Amazon felt that they were treated quite harshly. For example, Kantor and Streitfeld (2015) write:

Bo Olson lasted less than two years in a book marketing role (in Amazon) and said that his enduring image was watching people weep in the office, a sight other workers described as well. "You walk out of a conference room and you'll see a grown man covering his face," he said. "Nearly every person I worked with, I saw cry at their desk."

Another example mentioned by Kantor and Streitfeld is that a woman who had breast cancer was told that she was in danger of being fired since "difficulties in her private life had interfered with fulfilling her work goals."

In a follow up article, Streitfeld and Kantor (2015) noted that former workers in Amazon had mixed reactions to their article: "Some defended the culture as highly demanding but humane, while others described feeling pummeled by unrelenting demands, over-the-top-competition, and a feeling they could never meet the standards that the company boasts are unreasonably high." Jeff Bezos also responded to the article by Kantor and Streitfeld, and his response indicates that he believes that workers are not treated harshly at Amazon. Bezos wrote:

It (the article) claims that our intentional approach is to create a soulless, dystopian workplace where no fun is had and no laughter heard. Again, I don't recognize this Amazon and I very much hope you don't, either. More broadly, I don't think any company adopting the approach portrayed could survive, much less thrive, in today's highly competitive tech hiring market. The people we hire here are the best of the best. You are recruited every day by other world-class companies, and you can work anywhere you want. I strongly believe that anyone working in a company that really is like the one described in the NYT would be crazy to stay. I know I would leave such a company. But hopefully, you don't recognize the company described. Hopefully, you're having fun working with a bunch of brilliant teammates, helping invent the future, and laughing along the way. (Mac, 2015)

Those workers and Bezos who defended Amazon's culture would be maintaining that Amazon's management style is a win-win situation, which is what Taylor claimed occurred in his system of scientific management. On the other hand, those workers who described feeling pummeled by unrelenting demands would be claiming that Amazon's management system treats its workers harshly and does not accord with the humanity of production, and this view accords with the opinion of the critics of Taylorism.

One possible difference between Taylor and Amazon is with regard to the method of motivating workers. In the case of Bethlehem Steel Company, Taylor used the carrot system of rewards, higher pay, to get workers to attain the huge increase in carrying pig iron. On the other hand, while Amazon uses the carrot system of rewards, it heavily relies on the stick system, the fear of being fired, to motivate workers. Kantor and Streitfeld (2015) report with regard to new recruits at Amazon:

Many of the new comers filing in on Mondays may not be there in a few years. The company's winners dream up innovations that they roll out to a quarter-billion customers and accrue small fortunes in soaring stock. Losers leave or are fired in annual cullings of the staff – "purposeful Darwinism," one former Amazon human resource director said.

Even with regard to the people already at Amazon, Kantor and Streitfeld (2015) write, "In interviews, 40-year-old men were convinced Amazon would replace them with 30-year-olds who could put in more hours, and 30-year-olds were sure that the company preferred to hire 20-somethings who would outwork them." Young (2013), as quoted above, also notes how in the fulfillment centers Amazon relies on the stick method, that the workers are scared of being fired, to motivate the workers to meet the very high productivity goals.

Another definite difference between Taylorism and Amazon is that Taylor was disdainful of worker's participating in the decision making process of the firm, while Amazon encourages workers to contribute new ideas and to develop them. For example, Kantor and Streitfeld (2015) quote Elisabeth

Rommel a retail executive at Amazon who stated that in Amazon, "Many employees are motivated by thinking big and knowing that we haven't scratched the surface on what's out there to invent."

Kantor and Streitfeld present an example of a worker taking the initiative:

Stephenie Landry, an operations executive, joined in discussions about how to shorten delivery times and developed an idea for rushing goods to urban customers in an hour or less. One hundred eleven days later, she was in Brooklyn directing the start of the new service, Prime Now. "A customer was able to get an Elsa doll that they could not find in all of New York City, and they had it delivered to their house in 23 minutes," said Ms. Landry, who was authorized by the company to speak, still sounding exhilarated months later about providing "Frozen" dolls in record time.

This encouragement of workers to initiate and think on their own is a sign of a supportive managerial environment at Amazon, and contrasts with the reports of harsh treatments of workers and the policy of "purposeful Darwinism" at Amazon. This contrast raises the question whether Amazon could have succeeded more had it been more employee-friendly. This question might be surprising since Amazon has been so successful that it is hard to imagine it being even more successful. Yet, maybe the reason for its great success was its business strategy while its management methods might have hindered the company's growth.

Kantor and Streitfeld (2015) quote Robin Andrulevich, a former top Amazon human resource executive, who claimed that Amazon, "never could have done what its accomplished" without the policy of constantly hiring employees, driving them and cutting them. This statement is claiming that Amazon's tough management methods were needed, but not everybody agrees with this analysis.

One of the responses to the Kantor and Streitfeld's article was by an ex-employee of Amazon, named Dan, who had worked at Amazon for 15 years. Dan wrote (The New York Times, 18 August 2015):

Amazon is a great place to learn from fantastically skilled and intelligent people. It's a terrific place to work on systems on a scale that most companies can't even fathom. It's a thrilling place to work if you thrive and love being part of something huge and powerful. .... It's a great place to work if you don't have any interests outside of work and if you're a corporate-ladder-climber type. But corporate culture doesn't really promote treating its employees like human beings who have feelings and a life outside of work. ... I wish Jeff Bezos and Company continued success, but I wonder how much more successful they could be if they would only show the same kind of obsessive care about their employees as they do about their customers.

Borison (2015) quotes a similar idea from Piper Jaffray investment bank analyst Gene Munster. Munster notes while "Amazon's been a wildly successful company and probably one of the top five most successful tech companies, the company could probably be even more successful if they would have had a more employee-friendly culture."



While this claim and Dan's are possible, it is also possible that Andrulevich's argument is correct, and this question how employee-friendly should Amazon be is a question which cannot really be answered and verified, as who could ever know whether the company would have been even more successful. This question of how employee-friendly a company should be is not just relevant for Amazon but it is an important question for all firms and warrants further research.

## CONCLUSION

One of the oldest management theories, Taylorism or scientific management, is having a revival in the twentieth first century in the management practices of Amazon. The major similarity between Taylorism and Amazon's management practices is the focus on measuring all actions by workers and pushing and driving workers to perform beyond industry norms. This pushing and driving of workers is also viewed by some as being akin to Taylorism since critics of Taylorism claimed that Taylorism treated workers harshly, and this pushing and driving workers at Amazon is also alleged to lead to workers being treated callously. However, Taylor himself argued that Taylorism is beneficial to workers, and some of Amazon's workers and Jeff Bezos also maintain that Amazon's management practices are advantageous for the workers.

There are differences between Taylorism and Amazon's managerial practices. The question of how to push workers is one possible difference between Taylorism and Amazon since Amazon's motivation of workers relies on lot on the fear of being fired while Taylor used wage increases to get workers to work harder. In addition, a major difference between the two systems is that Taylor was not interested in worker's initiative, while Amazon encourages worker's initiative.

Amazon has been unbelievably successful, but the question remains how much of this success is due to its business strategy and whether its management practices have slowed down or contributed to the firm's spectacular success. If its management practices have impeded the firm's growth, then it is possible that firm could have grown even more if was more employee-friendly.

## REFERENCES

- Anders, G. (2012), "Jeff Bezos' top 10 leadership lessons", *Forbes*, 4 April. Available at: <https://www.forbes.com/sites/georgeanders/2012/04/04/bezos-tips/#13c31d8a2fce>. [Accessed July 2017].
- Bekken, J. (1987/1998), "Feeding the dinosaurs: Economic concentration in the retail book industry", *Publishing Research Quarterly*, Vol. 13, pp. 3-26.
- Borison, R. (2015), "Amazon's secrets of success don't include coddling workers", *TheStreet*, 16 April. Available at: <https://www.thestreet.com/story/13102438/1/amazons-secrets-of-success-dont-include-coddling-workers.html>. [Accessed August 2017].
- Brandt, R. L. (2011), "Birth of a salesman", *The Wall Street Journal*, 15 October, Eastern edition, C1.
- Drucker, P. F. (1974), *Management: Tasks, responsibilities and practices*, Harper and Row, New York, NY.

- Economist, (2014), "Amazon: Relentless.com", 14 June. Available at: <https://www.economist.com/news/briefing/21604559-20-amazon-bulking-up-it-notyetslowing-down-relentlesscom>. [Accessed July 2017].
- Economist, (2015), "Digital Taylorism: A modern version of "scientific management" threatens to dehumanise the workplace," 12 September, p. 63.
- Economist, (2017a), "Leaders: Amazon's Empire" and "Briefing Amazon: Primed", 25 March, pp. 9, 22-24.
- Economist, (2017b), "King of the retailing jungle", 3 June, p. 9.
- Gonzales, A. (2017), "Amazon's \$500 billion market milestone marks its status as corporate titan", The Seattle Times, 26 July. Available at: <http://www.seattletimes.com/business/amazon/amazon-worth-more-than-500-billion-as-stock-continues-its-climb/>. [Accessed July 2017].
- Hoffmann, G. (2017), Here's how rich you would be if you invested in Amazon at its IPO (AMZN), Business Insider, 28 April. Available at: <http://markets.businessinsider.com/news/stocks/amazon-stock-price-gains-since-ipo-2017-4-1001963246>. [Accessed July 2017].
- Kantor, J. and Streitfeld, D. (2015), "Amazon's bruising thrilling workplace", New York Times, 16 August, New York edition A1.
- Kiechel, W. (2012), "The management century", Harvard Business Review, November, 90, pp. 62-75.
- Mac, R. (2015), "Jeff Bezos: Anyone Working At A Company Described In New York Times Story Would Be Crazy To Stay", Forbes, 17 August. <https://www.forbes.com/sites/ryanmac/2015/08/17/jeff-bezos-amazon-letter-to-employees-crazy/#657be175228e>. Accessed July 2017.
- Martinson, J.(2000), "This man just lost \$1bn. So why is he still smiling?", The Guardian, 27 June, p. 2.2.
- Maheshwari, S. (2017) "Ads Zero in on Amazon", The New York Times, 1 August, New York edition p. B1.
- New York Times, (1915), "F. W. Taylor, expert in efficiency, dies", 22 March.
- New York Times, (2015), "Depiction of Amazon stirs a debate about work culture", 18 August.
- Packer, G. (2014), "Cheap words", The New Yorker, 17 & 24 February. Available at: <http://www.newyorker.com/magazine/2014/02/17/cheap-words>. [Accessed July 2017].
- Perry, M. (2015), "Chart of the day: Amazon vs. Wal-Mart and the triumph of online shopping", 25 October. Available at: [www.aei.org/publication](http://www.aei.org/publication). [Accessed January 2017].
- Shen, L. (2017), "If You Invested in Amazon at Its IPO, You Would Be a Millionaire Today", Fortune, 15 May. Available at: <http://fortune.com/2017/05/15/amazon-stock-20-years-ipo/>. [Accessed July 2017].
- Sommer, J. (2017), "Amazon's Mind-Boggling Ascent", The New York Times, 30 July, New York edition p. BU4.
- Stoffel, B. (2016), "Amazon Stock's History: The Importance of Patience", The Motley Fool, 26 June, Available at: <https://www.fool.com/investing/2016/06/26/amazon-stocks-history-the-importance-of-patience.aspx>. [Accessed July 2017].
- Streitfeld D. and Kantor, J. (2015), "Jeff Bezos and Amazon employees join debate over its culture", The New York Times, 17 August.
- Taylor, F. W. (1919, first published 1911), The principles of scientific management, Harper & Brothers Publishers, New York, NY.
- Thompson, D. (2013), "The Amazon mystery: What America's strangest tech company is really up to", The Atlantic, November.
- Will, G. F. (1997), "A faster mousetrap", New York Times Book Review, 15 June, pp. 8-10.
- Wingfield, N. (2017), "Amazon Finds A Fit in Apparel", New York Times, 1 May, New York Edition B1.
- Young, A., (2013), "Amazon.com's Workers Are Low-Paid, Overworked And Unhappy; Is This The New Employee Model For The Internet Age?", International Business Times, 19 December. Available at: <http://www.ibtimes.com/amazoncoms-workers-are-low-paid-overworked-unhappy-new-employee-model-internet-age-1514780>. [Accessed July 2017].

## WHAT IS SMART LEADERSHIP IN LUXEMBOURG?

Schinzel, Ursula

Unicaf University: Online Education [www.unicaf.org](http://www.unicaf.org) with Partner Universities Marymount California University and University of Nicosia

### ABSTRACT

The purpose of this study is to determine what smart leadership is in multicultural and multilingual Grand Duchy of Luxembourg. 42 semi-structured interviews were conducted between March and October 2016 among four categories, notably: 1) Lux.Nat. (Luxembourgers with Luxembourgish nationality), 2) Lux.Foreigner (foreigners who reside in Luxembourg), 3) cross-border workers (people who come to work to Luxembourg every day from Germany, France, and Belgium), and 4) the rest of the world (World). Interviews were in Luxembourgish, French, English, German, and Italian with executives. The following results were found: While worldwide attributes of smart leadership apply also in Luxembourg – have a vision, motivation, communication, delegation, prioritization, search for talent, trust, confidence, collaboration and creativity, particularities were found – the trilingual public education system, multiculturalism, integration of the different, and tolerance. While the small size of the country represents advantages – knowledge of your people, networking, it also represents disadvantages – nepotism, lack of resources. However, the geographically central location right in the middle of Europe with borders to France, Belgium and Germany allowed for political European integration decisions, the creation of a common economic and monetary market, the treaty of Schengen, the common currency Euro, and peace, wealth, and stability in Europe. Some interview citations are reprinted in the results paragraph. Conclusion, discussion, implication, limitations, future research and references follow.

*Keywords: Smart leadership, cross-cultural management, education, international business, Hofstede, management and language, Luxembourg*

### 1 INTRODUCTION

The purpose of this research is to discover what smart leadership is in multicultural and multilingual Luxembourg. 42 semi-structured interviews were performed between March and October 2016 among four categories, notably: 1) Lux.Nat. (Luxembourgers with Luxembourgish nationality), 2) Lux.Foreigner (foreigners who reside in Luxembourg), 3) cross-border workers (people who come to work to Luxembourg every day from Germany, France, and Belgium), and 4) the rest of

the world (World). Although responses from all four categories were quite similar, they still were different. The author has been carrying out cross-cultural research in these four categories since 2009, while starting her doctoral studies in cross-cultural comparison following Geert Hofstede's cultural dimensions. Even though other categories could be chosen, these four categories demonstrate similarities and differences in replies quite significantly.

The structure of this paper will be as follows: first, this paper will briefly review the extant literature on Smart Leadership, then describe Luxembourg's linguistic and cultural peculiarities, and then present a proposition. Second, the applied method - semi-structured interviews - will be described. Respondents were asked: 1) what is smart leadership in general and 2) what is it particularly in Luxembourg? Third, the results from the four different categories of respondents will be presented, some interviews will be reprinted entirely, some partially. Finally, a summarizing table is offered for the reader's convenience.

### 1.1 Smart Leadership

"There is only one irrefutable definition of a leader: someone people follow. Therefore, leadership is a relationship between the leader and the led. Unlike management, the leadership relationship cannot be delegated or automated" (Maccoby and Scudder, 2011).

Smart Leadership, alongside with strategic leadership (Elenkov, Judge, and Wright, 2005), supportive leadership (Banai and Reisel, 2007) and responsible leadership (Maccoby, 2015) has been in the focus and has attracted attention of several great leaders. Peter Drucker was one of them, if not the most renowned. Among the over forty books he wrote, *What makes an Effective Executive* (2004) and *Management Challenges for the 21<sup>st</sup> Century* (2011) are interesting for this research. For him, ethics and integrity were key to effective leadership. In brief, his eight rules for effective leaders are: "Ask what needs to be done. Ask what's right for the enterprise. Develop action plans. Take responsibility for decisions. Take responsibility for communicating. Focus on opportunities, not problems. Run productive meetings. Say 'We', not 'I'." (Drucker, 2004). Any person, but especially a CEO needs to set priorities, and while doing so, there are four rules to be followed (Drucker, 2004): Focus on the future, not the past. Focus on opportunities, not problems. Do not climb on bandwagons and forget safe options. Aim high, aim at making a difference. Rao (2012) summarizes the leadership lessons from Drucker: "Follow your passions and lead a complete life. Manage your time. Focus on your core competencies. Differentiate between persistence and futility. Reinvent yourself constantly. Focus on achievement rather than making money. Spend time on community service and work for non-profit institutions as it widens your mental horizons. Never put off your work for the next day as every day is a good day to finish your work. Learn to live in an imperfect world and strive to make it perfect.

Pursue your passions at every stage of your life. You can work from anywhere if your knowledge is portable. Abandon old practices systematically. Treat employees as assets. Focus on the customer. Leave a legacy for tomorrow.” (Rao, 2012, pp. 117, 118). For Drucker, it was important to have diverse skills in several areas, he called it having a parallel career, best started at a younger age, as they provide meaning and stability to your life. If one area suffers a downturn, you still can work in the other(s). It also makes you a rounded and interesting person, having multiple areas of interests. Drucker called on us to search for happiness in our present, not in our future, stressing that ‘Happiness is a journey, not a destination’ (Souza cited by Rao, 2012, p. 119), and Einstein said, “Try to be a person of value rather than a person of success” (Einstein cited by Rao, 2012, p. 119). Drucker wanted us to lead our life completely by pursuing our passions and interests, in order that we do not have any regrets on our deathbed (Rao, 2012, p. 119).

“Besides Peter Drucker, Jack Welch, Ram Charan (2007), Jim Collins, John Maxwell (2007), Anthony Vlamis(1999), Gita Piramal and Jennifer Netarwala (2005), William Austin (2009), Marshall Goldsmith (2007) authored important publications, articles and books on smart leadership. Max Weber, James MacGregor Burns, Bernard, M. Bass, Warren Bennis, and Nanus have written about transformational leadership” (Rao, 2012, pp. 101, 108, 109). “We have seen several smart leaders who inspired our lives more or less: Mahatma Gandhi, Mother Teresa, Dalai Lama, Aung San Suu Kyi, Martin Luther King Jr, Florence Nigthingale, Barack Obama, Frances Hesselbein, Warren Buffet, Bill Gates, Steve Jobs, Mark Zuckerberg... These have positive energy, while other big leaders had negative energy: Adolf Hitler, Osama Bin Laden. Some charismatic leaders lead to the disintegration of their empires, as they did not train any leaders to follow them and were able to replace them: Alexander the Great, Ashoka, Genghis Khan.”

Here are the 5 leadership levels by John C. Maxwell (2013, p. 12):

“1. Position - People follow because they have to. 2. Permission - People follow because they want to. 3. Production - People follow because of what you have done for the organization. 4. People Development - People follow because of what you have done for them personally. 5. Pinnacle - People follow because of who you are and what you represent.”

Success is defined by John C. Maxwell (2008, p. 5): “Knowing your purpose in life, growing to reach your maximum potential, and sowing seeds that benefit others.” “Two things are required (for success): the right picture of success and the right principles for getting there.” (Maxwell, 2008, p. 4). Following Rao (2012, p. 9) the six steps for success as a leader are: “you must connect, communicate, understand, network, synergize, and accomplish the desired outcomes”. Gina Rudan (2011) publishes a five-step plan to re-genius us: “Visualize success. Recognize and remove negative thoughts from your mind. Focus on the present and let go the past. Overcome your phobias and fears. Avoid

superstitions. Avoid fear of failure. Solitude is fortitude. Avoid information overload" (Rudan, 2011; Rudan cited in Rao, 2012, pp. 12-14). "Great leaders – the truly successful ones... –all have one thing in common. They know that acquiring and keeping good people is a leader's most important task." (Maxwell, 2012, p. 1).

Anthony Vlamis (1999) interviewed eight leaders on smart leadership, asking eleven questions, the first being: Do you have a personal vision of good leadership in these times? In summary, here is what they said. The complete interviews are in Vlamis' book. **Dan R. Bannister**: (1) they have to be comfortable in global situations, (2) they must have an endless supply of energy; and (3) they have know-how to energize people; breadth of knowledge and long-term performance; continual learning; people skills; studying what leaders or other companies do; earn trust; a willingness to take risks; create buy-in. **James Champy** said, it is, first and foremost, a certain inborn sensing capability, and secondarily are integration skills, "it's how to make integration work across your company and your customers and your suppliers"; and thirdly: empathy (Champy cited by Vlamis, 1999, p. 13). "People have to trust your business judgment, and they have to trust your values." (p.14). It is knowing when to act (p. 16). "Many young people are going to high-paying big banking and financial services firms to do big deals. They may be doing big deals. But are they doing anything new? I don't think so. They are often driven by greed...the people I would want to put in a boat setting out to sea on a new adventure, are smart people who would be excited about the opportunity to create something different and something new, something that meets a real need out there that nobody else has seen or discovered yet." "The quintessential guy is Jack Welch. It's true. He has all those qualities, sensing capability, the right sense of where to integrate, what to do, and so forth. He has much more of a humanistic sense than he is given credit for. I have experienced him personally as being very caring" (James Champy cited by Vlamis, 1999, p. 17). In **Mort Feinberg's** opinion, it is, first: "Know what you want to accomplish in your company. What is your vision for the company?" Second: "...know what basic resources you need to accomplish your mission: economic, people, the kinds of relationships you need with your people, your suppliers, and your customers.... Next: Go out and find able people. Next: Create a boundaryless culture.... Third, a leader needs sheer physical energy. Finally, make certain that the message is heard throughout the organization: so, it is: vision, equipment, energy, boundaryless culture, everybody works toward a common vision.... A smart leader has to wander around, giving feedback and celebrating successes" (Feinberg cited by Vlamis, 1999, pp. 19-23). Following **Frances Hesselbein**, smart leadership is a matter of how to be, not how to do it. A good leader embodies the vision, mission, and principles of the organization. He is mission focused. And leads by example, from the front, with clear, consistent messages and values that are moral and a sense of ethics. He earns peoples' trust, inspires through example, language and inclusion. (Hesselbein

cited by Vlamis, 1999, pp.25-26). For **Thomas R. Horton**, leadership “is a very individualistic thing; it has to do with a leader being fully himself or herself, and motivating others to be the same” (Horton cited by Vlamis, 1999, p. 31-35). For him, it is about integrity, communication, alertness to opportunity, decision making, focus, tenacity, fairness, people development, compliance and expanding business. **Victor Kiam’s** “leadership philosophy is “Lead by example, try to instill an entrepreneurial spirit throughout the organization not based solely on monetary rewards, and be constantly alert to the changing global and domestic marketplaces and the effects of peripheral factors on the business” (Kiam cited by Vlamis, 1999, p. 43). A smart leader needs to be decisive, be honest, be fair and lead by example. **Ed Ridolfi** said: “Leaders are people who take you to places you’ve never been before. Managers get things done. They implement strategy. Managing is about blocking and tackling. Leadership is about defining strategy” (Ridolfi cited by Vlamis, 1999, p. 51). Leaders have a high level of integrity. They uphold quality and ethics every day, without exception. They focus on results, motivate others, have a strategic vision and thinking, they communicate, they are customer/market oriented, they are accountable, they have enthusiasm and energy (Ridolfi by Vlamis, 1999, pp. 53-55). The new global leader will be aware of technology and has the ability to effectively manage complexity and uncertainty! (p. 57). **Glen Tobe’s** most important element is authenticity or realness. “Leaders need to communicate who they are as people”. He cites Robert Greenlead’s 2002 book, originally from 1977: *Servant Leadership*. He says, the smart leader remains present in the room. “He listens to what people have to say, just like Colombo” (Tobe cited by Vlamis, 1999, p. 62).

## 1.2 Luxembourg

Luxembourg is a parliamentary democracy and a constitutional monarchy, it is the only remaining Grand Duchy in the world. Luxembourg is one of the smallest countries in Europe with a total size of only 2,586 km<sup>2</sup>. It is 82 km long and 57 km wide and has borders with Germany (138 km), with France (73 km), and with Belgium (148 km) (The World Factbook). As of 1<sup>st</sup> of January 2016, Luxembourg's total population consisted of 576,200 inhabitants of whom 307,000 (53.28%) were Luxembourgers and 269,200 (46.72%) were foreigners (statec, 2016), these included 93,100 Portuguese, 41,700 French, 20,300 Italians, 19,400 Belgians, 12,800 Germans, 6,100 British, 4,000 Dutch, 32,100 other EU countries, and 39,700 other, see <http://www.statistiques.public.lu/stat/TableViewer/tableView.aspx>. The cross-border workers are a key component of Luxembourg’s employment situation. Domestic employment was 405,600, comprising 170,200 cross-borders (41.96%): 84,400 from France, 43,100 from Belgium, and 42,700 from Germany. The minister for the Greater Region in 2016, Corinne Cahen, gives insights into the Greater Region’s future (Langenbrink, 2016), looking for bilateral solutions, language learning programs,

bilingualism as horizon 2030 in the Saarland, a traffic concept, education system, agriculture, ecology and energy solutions.

Luxembourg's motto is: '*Mir wëlle bleiwe, wat mir sin*' [*We want to remain what we are*']. The language situation is anchored deeply in the country's history (Schinzel, 2013): with three official administrative languages: French, German, Luxembourgish (statec, 2016); Luxembourgish is the national language (Lëtzebuergesch). The public education system is trilingual: the language of instruction in kindergarten is Luxembourgish, being replaced by German as language of instruction in primary school and then gradually replaced by French as language of instruction in secondary school (Kraemer, 1995; Schinzel, 2014a; 2014b, 2017; Weber and Horner, 2008). Citizenship is only awarded to those who speak Lëtzebuergesch (Spizzo, 1995). The language defines the in-group (Briley et al. 2005) and the out-group. Those who speak Luxembourgish are part of the in-group and those who do not speak the language are part of the out-group (Schinzel, 2014).

	The author's Lux.Nat.	The author's Lux.All.	Hofstede's estimates on Luxbg	Hofstede's France	Hofstede's Germany	UK	Belgium FR	Belgium NL	Italy	NL	China	USA	Japan
PDI	29	36	40	68	35	35	68	61	50	38	80	40	54
UAI	95	97	70	86	65	35	93	97	75	53	30	46	92
IDV	34	51.5	60	71	67	89	71	78	76	80	20	91	46
MAS	54	47	50	43	66	66	60	43	70	14	66	62	95
LTO	65	69	64	63	83	51	82	82	61	67	87	26	88
IVR	55	53.5	56	48	40	69	57	57	30	68	24	68	42
MON	24	10	-	16.5	9.9	35.4	-	-	35.2	11.9	0	57.2	4.0

**Table 1 Cultural Comparisons: The author's Luxembourg, Lux.Nat. in comparison with Hofstede's UK – Belgium FR – Belgium NL – Italy – the Netherlands NL – China –USA – Japan (on a scale from 1-100, 1 being the lowest and 100 the highest score)**

In 2010 the author replicated Geert Hofstede's cultural dimensions' study in Luxembourg and compared the findings with Hofstede's estimates. Luxembourg's specific cultural environment is characterized by low Power Distance (PDI=29), high Uncertainty Avoidance (UAI=95), low Individualism = high Collectivism (IDV=34) (COL=66), medium Masculinity (MAS=54), high Long-Term Orientation (LTO=65), medium Indulgence versus Restraint (IVR=55), and low Monumentalism (MON=24).

Table 1 (Schinzel, 2015) shows Hofstede's (2001) and Hofstede et al. (2010) cultural dimensions of Lux.Nat. and Lux.All., Hofstede's estimates on Luxembourg, his data for France, Germany, the UK,



Belgium FR, Belgium NL, Italy, the Netherlands, China, the USA, and Japan, where the cultural differences become clear.

It is worth citing Hofstede himself: "At 70 Luxembourg has a high score on uncertainty avoidance which means that as a nation they are quite reluctant to test unknown territories. Security is a key word in Luxembourg: there is not one activity which is not depending on some sort of security control from authorities; from banker's money to safety exits in a restaurant. It makes life in Luxembourg very safe, but some would argue a bit boring. New ideas, new methods, new management techniques must first be proven to work in other countries in order to be accepted in Luxembourg. Historically more "farmers" than "traders" the inhabitants kept that good old "common sense" made of cautiousness which has proven to be profitable for a country who managed not to be at war since the Napoleonic time!" (<http://geert-hofstede.com/luxembourg.html>).

In September 2015 Jeremy Rifkin presented his 'third industrial revolution' for Luxembourg, including subjects such as energy, mobility, construction, nutrition, industry, financial sector, smart economy, circular economy and a social model, comprising digitally linked houses, shared cars and 100% digitalized economy (Schmit, 2016a). Directly after Jeremy Rifkin's presentation, doubts arose: is this concept realizable in Luxembourg? At date, discussion among professionals is ongoing. The 'Sustainability Forum 2016' invited everybody to participate in Jeremy Rifkin's second presentation, allowing for more discussion. See also <http://www.troisiemerevolutionindustrielle.lu>.

In this context and taking into consideration the potential changes that Luxembourgers wish to carry out, the author asked this question: what is smart leadership – in general, and in particular: in the Grand Duchy of Luxembourg? Having read the extant literature in general, she wants to break it down to the special context of the Grand Duchy of Luxembourg. She comes up with the following proposition:

Proposition: *'Smart leadership in Luxembourg' is deeply anchored in Luxembourg's cultural and linguistic identity in the middle of Europe.*

This will be examined in the following sections.

## 2 METHOD

Semi-structured interviews were carried out during spring, summer and autumn of 2016. Respondents were asked: 1) what is smart leadership in general and 2) what is it particularly in Luxembourg? Respondents were from the four categories: Lux.Nat. (15), Lux.Foreigners (11), Cross-border workers (3) and the rest of the World (3). Interviews were carried out in Luxembourgish, English, French, German, and Italian. They were in person, by phone, via skype or email exchange and lasted between 30 minutes and 2 ½ hours. While some respondents took this research seriously by

dedicating to me all the time needed to clarify all the necessary points, other respondents obviously had less time to devote. Sampling was convenience sampling. For confidentiality reasons, interviews were not taped, nor recorded or filmed. In-depth notes were taken during the interviews. After the interviews, the respondents were presented the summary of the interview and their consent was asked. Interviews in Luxembourgish, French, German, and Italian were translated into English.

### 3 RESULTS

Between March and September 2016 the author performed a total of 42 semi-structured interviews with business men and women in companies in the four categories 1) Lux.Nat., 2) Luxembourg Foreigners, 3) Cross-border workers, and 4) the rest of the world (World). The interview languages were for 16 in English, 10 in French, 8 interviews in Luxembourgish, 5 in German, and 3 in Italian. Interviews were mainly held in person, or on the telephone, via skype and via email conversation, indebt notes were taken. The longest interview lasted 2.5 hours, the shortest 30 minutes. The 42 interviews can be divided in 4 categories: 16 Luxembourgers with Luxembourgish nationality (Lux.Nat.), 11 foreigners living in Luxembourg, 3 cross-border workers, and 12 respondents from the rest of the world. Among the 11 foreigners living in Luxembourg 3 were Italian, 2 German, 2 Belgian, 1 Portuguese, 1 Australian, 1 Czech. The cross-border workers live in the neighbouring Germany (1), France (1) and Belgium (1). The respondents from the rest of the world come from the USA (1), Canada (1), Australia (1), the UK (2), Germany (2), Poland (2), South Africa (1), China (1). Here are the respondents' mother tongues: 16 speak Luxembourgish as mother tongue, 8 French, 5 English, 4 German, 3 Italian, 1 Portuguese, 1 Russian, 1 Hebrew, 1 Czech, 1 Arabic, 1 Chinese, 2 Polish, 1 Afrikaans. 3 respondents have 2 mother tongues: Luxembourgish and French, Russian and Czech. To summarize the language situation: 2 respondents speak six languages, 8 respondents speak 5 languages, 16 respondents speak 4 languages, 4 respondents speak 3 languages, 8 respondents speak 2 languages, 2 respondents speak one language, see table 2.

**Table 2** Respondents' demographics

Respondents' profile	Classification	Number of respondents
Gender	Male	27
	Female	15
	Total	42
Age	0-29	0
	30-49	25
	50-59	15
	Over 60	2

Industry sector	Finance	10
	State	9
	Education, Human Resources	15
	Tourism, Telecom, Construction	4
	Law, Medicine, Science	4
Education level	A-level and professional education, undergraduates	15
	Masters and Doctorates	27
Respondent's origin	Luxembourg	16
	Germany	4
	Belgium	4
	Italy	3
	France	2
	Australia	2
	Canada, China, Czech Republic, Israel, Poland, Portugal, UK, South Africa, Syria	11
Mother tongues	Luxembourgish	16
	French	8
	English	5
	German	4
	Italian	3
	Portuguese, Russian, Hebrew, Czech, Arabic, Chinese, Polish, Afrikaans.	8
Language of the interviews	English	16
	French	10
	Luxembourgish	8
	German	5
	Italian	3

In summary, the 42 respondents come from 15 different countries, hold 15 nationalities and speak 15 different languages. One respondent holds the double nationality.

What about gender? 27 respondents are male, 15 are female. What about age? Respondent's age is mainly between 35 and 59 (36 respondents out of 42), while there is no category 0-19, neither 20-24, nor 25-29, 5 are age 30-34, 12 age 35-39, 8 age 40-49, 15 age 50-59, and 2 are over age 60.

The education level of the 42 respondents is as follows: 4 with A-level, 0 with professional education, 11 hold an undergraduate degree, 12 hold a master's degree, and 15 a doctorate. With the following industry sectors: 10 from the banking and finance sector, 9 employed at the State as civil servants, 15 in education, 2 in commerce, 2 in the health sector, 1 in Telecom, 1 in construction, 1 in science, and 1 in law. As for the job level, there are 32 managers and 10 assistants, there are no blue-collar workers.

### *3.1 Results from the interviews*

In this section, the results from the 42 interviews in the four categories are summarized. In a first paragraph the positive points – the advantages – are presented in main points in the four categories, followed by a second paragraph on the negative points – the criticism respondents expressed. Responses from all four categories being different, a distinction is made in the results paragraph between the four categories.

#### *3.1.1 Results of Interviews - Luxembourg Nationals (Lux.Nat.) – positive points*

The number one advantage of Luxembourg is to be situated right in the middle of Europe, at the crossroad of three cultures: the German, the French and the Belgian cultures. This particular geographic situation is the origin of one of the most important smart decisions Luxembourg has taken: Europe!

To cite one Lux.Nat. respondent: “Luxembourg was among the initial 6 founding members of the CECA, which later led to the European Union EU. Luxembourg was able to attract parts of the European Parliament to Luxembourg, other parts are in Strasbourg (France) and in Brussels (Belgium). Especially smart was the fact to attract the Judicial and the Secretary and the Financial parts, with the EIB – European Investment Bank (BEI - Banque Européenne d'Investissement), the European Central Bank being in Frankfurt (Germany).”

Most Luxembourgish leaders have studied abroad, in neighbouring countries, and are travelling in these countries. They are interested in travelling and in knowing what happens not only in other European countries, but worldwide, they always have their eyes open with the aim to see / foresee what happens next, and how to forecast future decisions.

Second, Luxembourg is small, really small, approximately 80 km long, 40 km wide. This being often a disadvantage, in the case of smart leadership, it seems to be an advantage. Following some, not all respondents, Luxembourg's leaders have the ability to take bold decisions, to do bold things, to live their dreams, to realize their futuristic ideas. Big countries cannot experiment in this way. When a Luxembourgish leader makes an error, he causes an uproar, but 3 days later it is forgotten. The USA

cannot just go ahead and experiment on ideas. Luxembourg does. Many of these ideas failed, but many others succeeded. One of these ideas is the creation of SES (Société Européenne des Satellites) in Betzdorf under Pierre Werner, prime minister of Luxembourg 1959 - 1974 and 1979 - 1984, followed by Pierre Frieden, Gaston Thorn and Jacques Santer. Gaston Thorn was not only Prime Minister of Luxembourg, 1974 - 1979, but also President of the European Commission, 1981 - 1985. The 'Werner Plan', initiated in 1970, to create a European economic and monetary union was not immediately realized, but later by Jacques Delors, paved the way for the euro, the European common currency. Werner's centre of interest was European integration. Pierre Werner was also Minister of Culture, and a fan of cricket, creating the Luxembourgish Cricket Club. Jacques Santer succeeded Pierre Frieden as Prime Minister, 1984 - 1995, then became President of the European Commission, 1995-1999, while Jean-Claude Juncker succeeded as Prime Minister, 1995 - 2013, and then President of the European Commission in 2014.

As stated by one Lux.Nat. respondent: "No other European country has provided three Presidents of the European Commission, except Luxembourg."

The Grand Duchy of Luxembourg has many politicians with high importance for European integration, the peace process after World Wars 1 and 2, the creation of a common economic and monetary market, the EC, the EU, the treaty of Maastricht, as well as the treaty of Schengen, signed on 14 June 1985 in Schengen, Luxembourg, effective since 26 March 1995, with original signatories being: Belgium, France, West Germany, Luxembourg and the Netherlands.

SES Astra was created in 1985, with the help of the Luxembourg Government, under the name 'Société Européenne des Satellites' at Betzdorf. The first ASTRA satellite was launched in 1988. In 2015, SES owned 54 satellites, covering nearly the entire world – 99% coverage. O3b Networks was acquired on 1 July 2016, again with the help of the Luxembourg Government who remains one of SES's shareholders. See: <http://www.ses.com/4232583/en>, and <http://www.ses.com/fleet-coverage>:

"Welcome to SES

We are the world-leading satellite operator, providing reliable and secure satellite communications solutions to broadcast, telecom, corporate and government customers, reaching 99% of the world's population."

"Fleet and coverage

Our global fleet of 53 geostationary satellites covers 99% of the world's population to deliver reliable and secure connectivity. Our vast satellite footprint enables operators to deliver thousands of hours of the latest digital TV content every day, companies to provide broadband networks in remote locations and governments to connect their sites."

One Lux.Nat. respondent said: "If you want to have ideas, you need to travel a lot, and to make economic prospection, with the aim to identify the domains of interest that need development. This requires a huge open mindedness and strategic intelligence."

Luxembourg is the first nation on earth preparing to mine raw materials from space, together with SES.

Other respondents were of a contrary point of view; there being no difference between an American or a Luxembourgish leader. The same criteria for smart leadership apply for both of them: 1) understanding my own motivation; 2) respect, comprehension, empathy, communication, humility, positivity, love and integrity; 3) knowing my teams; 4) collaborating with competent employees; 5) delegating and prioritizing; 6) encouraging creativity; 7) concentrating on positive aspects; 8) being direct; 9) return on experience: what works, what doesn't; 10) the obstacles to success.

Luxembourg being so small, networking is essential, vital and critical. Several respondents underlined the importance of knowing the right people. This being true in big countries, it is even truer in small Luxembourg. The smart leader needs to have the right networks, he/she needs to have other smart leaders to network with.

One Lux.Nat. respondent said: "It is so small here, everybody knows or thinks they know everything about the other(s). We had a candidate here for an interview for a new job, and, imagine, her current employer already knew about her interview appointment. New employers automatically call the current employer to check on the person, especially as they all know each other, they all are friends, go together to the same events, sports, supermarkets, where they talk and exchange information."

Third, it is a multicultural society, where everybody ought to speak at least 4 languages: Luxembourgish, German, French and English, where learning Luxembourgish is beneficial for all nationalities. The Luxembourgish language is important here. The more foreigners come to Luxembourg, the more they become aware of the importance of the Luxembourgish language.

One Lux.Nat. respondent said: "Our identity is our language. Our language is my heart. This is shown in the history, especially World War 1 and 2, and the civic education. As a foreigner, you show, by learning Luxembourgish, that you are not only there for the money."

Fourth, Luxembourg is a long-term oriented country, following Hofstede et al. (2010) and Schinzel (2013), Long-term Orientation is 69 out of 100. Planning is done for the long term, always with continuity in mind, preserving the environment and nature, and forecasting for the generations to come.

One Lux.Nat. respondent said: "When a construction company builds a new building, it is built following the method 'quadle to quadle', meaning that everything will be recycled in the end."

Although trust, confidence, collaboration and creativity are key assets for the smart leader in Luxembourg, control mechanisms should be put in place to avoid abuse.

One Lux.Nat. respondent said: "Although smart leaders (as project leaders) should put their trust in others, they should never forget to have and use some powerful and accurate tools to check if people (customers, providers, partners, shareholders, employees, interns...) are sticking to the rules and are speaking the same language!"

Business often is done fast in Luxembourg, faster than in other countries, given its small size. This speed in action might be unusual for newcomers. While in other countries making an appointment may take several weeks or months, in Luxembourg it might be minutes or hours.

One Lux.Nat. respondent said: "A smart leader in Luxembourg has to quickly recognize and understand unique local situations and particular issues of his employees (expatriates, cross-borderers / accept homeworking), clients (depending on the size, location and field) and providers... in order to be able to negotiate and obtain win-win-win results. A smart leader in Luxembourg must be a good, well-prepared and enthusiastic trainer as well, in order to mould the perfect squad."

In Luxembourg, things do happen fast, except if you work for the State. If you do work for the State, things happen extremely slowly. Respondents confirmed the generally known fact, that at the State level, things happen slowly, people work slowly, and hardly anything changes. At the State level, the boss is the boss, and the lower-level civil servant is/remains just that. Nothing ever changes, nobody ever changes, and every day has the same procedure. While Change Management happens in other companies, at the State level, hardly never anything/anybody changes. One respondent proudly confirmed that the turnover is zero, as never anybody had quit the department in his/her 25 years at the head of the office.

One Lux.Nat. State employee said: "It is about time that things change here at the State!"

Another Lux.Nat. State employee expressed exactly the contrary: "I have been the boss here for the last 28 years, never anybody gave his notice letter here, I have 0 turnover, and this shall continue exactly like this forever."

Fifth, the smart leader in Luxembourg can experiment more than in other countries.

One Lux.Nat. respondent said: "He can go and try out new adventures easily."

This is done by a clear vision of performance, long-term orientation, in new ideas, new concepts, start-ups, there are several big examples, i.e. the construction of the newly established University, the **Belval Plaza** site, with movie-centre and **University** campus, new train station, a mall, including many shops, restaurants, gyms, new apartment buildings, sport events, the Rockhal (a concert hall):

"Definitely the best thing on the whole site: since its opening, many super famous actors have visited Luxembourg- RHCP, Mariah Carey, Pink, The Pussycat Dolls...., many of them would have never

come to the Atelier because of its small size. Not to mention all the other events that take place at the Rockhal.”

Another example is the **CFL Multimodal** cargo-train-station between Bettembourg and Dudelange, from where huge cargo trains depart for France, Italy, Spain, Portugal and other European countries, filled with cargo, to avoid street traffic. See: <http://www.cfl.lu/espaces/groupecfl/en/le-groupe/participations/cfl-multimodal> or <http://cfl-mm.lu>:

“CFL multimodal is a global service provider and offers a broad service portfolio: combined rail-road transport, freight solutions for rail, road, waterways and air, warehousing, customs services and all other services of the logistics chain. In addition, CFL multimodal offers city logistics services targeted at Luxembourg City's retailers.”

By setting clear objectives, another smart leader in Luxembourg is **Cargolux**. Who is Cargolux? See <http://www.cargolux.com/>:

“Cargolux Airlines International Cargolux, based in Luxembourg, is Europe’s leading all-cargo airline with a modern and efficient fleet composed of 13 Boeing 747-8 freighters and 11 Boeing 747-400 freighters. The Cargolux worldwide network covers 90 destinations, some 70 of which are served on scheduled all-cargo flights. The company has more than 85 offices in over 50 countries, and operates an extensive global trucking network to more than 250 destinations as well as full and part-charter services. Cargolux also offers third-party maintenance at its modern two-bay maintenance hangar in Luxembourg. The company is specialized in B747 line and hangar maintenance up to and including C-Checks. It offers a range of specialized maintenance services and holds line maintenance approval for 777 aircraft. The Cargolux Group employs close to 1,900 staff worldwide.”

Despite the cargo flights from all over the world to Luxembourg, the Government imposed a night flight prohibition on Cargolux and every other flight company. The airport being so close to town, inhabitants would suffer tremendously from night time noise, disturbing their natural sleep. This is an example of smart leadership.

Another company active in Luxembourg is **DuPont de Nemour**. Its Tyvek fabric provides new techniques for protection, packaging, and insulation, with an innovative, multipurpose sheet. DuPont in Luxembourg has a 100%-security policy, with an objective of: “Security is 0 accidents”. Not only is security encouraged inside the company, where non-respect of the security-rules is strictly punished, going as far as job termination. But also security outside the company, at home, is encouraged, following the idea that healthy employees are more beneficial for the DuPont Company than employees hurt at home while cleaning the house or other household accidents. This is where DuPont takes social responsibility as a smart leader. DuPont is enlarging its facilities in Luxembourg-Contern



in 2016/2017, investing 350 million euros in the construction of a new production line for Tyvek (Adam, 2016). In 2016, 1063 people worked in Contern, producing four product lines: Mylar, Typar, Hytrel and Tyvek. The new Tyvek production line will add 120 people. Tyvek does not have any equivalent competition worldwide, as opposed to Mylar, the polyester film, which is under enormous international pressure, and DuPont has to keep its production costs in Luxembourg low, while guaranteeing highest quality. See: <http://www.dupont.com/products-and-services/fabrics-fibers-nonwovens/protective-fabrics/brands/tyvek.html>:

“Tyvek® brand - For Greater Good™

What if you could lessen your worries?

Like weather conditions that could affect your home and your family time. Or the worry that the hazardous materials you handle responsibly could put you at risk. For almost 50 years, DuPont™ Tyvek® has provided the protective barrier people need to worry less, so they can focus on accomplishing bigger things. Tyvek® is a family of tough, durable spun bonded olefin sheet products that are stronger than paper and more cost-effective and versatile than fabrics. Lightweight and durable, Tyvek® has introduced new dimensions of protection, security and safety in a wide variety of applications—building envelope, protective apparel, medical packaging. Even graphics. And we continue to innovate today. We encourage our customers to develop new ideas for Tyvek®, and to dream big. Because once Tyvek® frees you from worry, a world of greater good becomes possible.”

**Fage International** announced the construction of a new yoghurt production line in Bettembourg/Luxembourg, able to produce 40,000 tons of yoghurt per year from 2018 on (Cortey, 2016), using 180,000 tons of milk, approximately half the country’s annual production, collaborating with Luxlait for supply in milk, and with ADEM (Administration de l’Emploi) for training the 100 future employees, investing 100 million euros.

**Euro-Composites** in Echternach will invest 61 million euros in 2016/2017. Etienne Schneider, Luxembourg’s Minister for Economy said: “This is the third major investment we announce this month. After Dupont (350 million) and Euro-Composites (61 million) the announcement of Fage International brings the investment at more than 500 million euros and 450 job creations” (Cortey, 2016). So many announces make Etienne Schneider ‘a happy minister’, demonstrating that the country’s economy is competitive beyond the financial center (Cortey, 2016).

**Guardian** invests in glass and exports most of its glass, including to Dubai, building the Burj Khalifa – the skyscraper. For Guardian, values are primordial, they publish them on their website and have the slogan: “People are making our difference”, see: <http://www.guardian.lu/values/index.htm>

“Values that govern our business conduct

**Integrity:** Conduct all affairs with integrity, for which courage is the foundation.

**Compliance:** Strive for 10,000% compliance with all laws and regulations, which requires 100% of employees fully complying 100% of the time. Stop, think and ask.

**Value Creation:** Create long-term value by the economic means for customers, the company and society. Apply MBM® to achieve superior results by making better decisions, pursuing safety and environmental excellence, eliminating waste, optimizing and innovating.

**Principled Entrepreneurship:** Apply the judgment, responsibility, initiative, economic and critical thinking skills, and sense of urgency necessary to generate the greatest contribution, consistent with the company's risk philosophy.

**Customer Focus:** Understand and develop relationships with customers to profitably anticipate and satisfy their needs.

**Knowledge:** Seek and use the best knowledge and proactively share your knowledge while embracing a challenge process. Develop measures that lead to profitable action.

**Change:** Anticipate and embrace change. Envision what could be, challenge the status quo and drive creative destruction through experimental discovery.

**Humility:** Exemplify humility and intellectual honesty. Constantly seek to understand and constructively deal with reality to create value and achieve personal improvement. Hold yourself and others accountable.

**Respect:** Treat others with honesty, dignity, respect and sensitivity. Appreciate the value of diversity. Encourage and practice teamwork.

**Fulfillment:** Find fulfillment and meaning in your work by fully developing your capabilities to produce results that create the greatest value."

**Enthusiastic people:** Communication should be done continuously and informally.

The Luxembourgish supermarket **Cactus** is considered as a smart leader in Luxembourg. It has collaborated with Luxembourg city since 1990 to run the annual City Jogging event, see: <http://www.cactus.lu/fr/yuppi/gallery/city-jogging-luxembourg-0>. Cactus always adapts their offer to clients' needs, e.g. increased offer in organic products, vegetarian products and household products at reasonable prices. Adapting to people having less time, they cook and offer take-away lunch food, first only at lunch times, now all day long. Opening hours have been adapted as well, opening early mornings, later in the evenings and on Sunday mornings. Despite the fierce international competition by huge international supermarket chains, Cactus has always known to reinvent itself to maintain its dominant position in Luxembourg's supermarket landscape. Cactus helps sustaining local farmers, local producers, local people, not only by selling local products – local milk, meat, apples, juice – but especially by sponsoring local events, by growing trees, supporting farmers, beekeepers, by educating

children, with the Yuppi mascot, by sponsoring sports and cultural events, e.g. City Jogging, Run for the Kids, Fackellaf, Relais pour la Vie – 24- hour race against cancer – see <http://www.relaispourelavie.lu/>.

In addition to the local supermarkets, Luxembourg's smart leadership aims at attracting other companies to Luxembourg. After Mc Donald's and Quick, they attracted Burger King, Dunkin Donuts, and more recently Starbuck's. Even though, this seems to be smart for those globalized companies, it needs to be confirmed if it is smart for the local small cafés and restaurants.

**Lush Cosmetics** is considered a smart leader in Luxembourg, because they combat animal testing, favouring natural products, Fairtrade and charity events.

**Solar energy** is promoted by the Luxembourg government, having as objective the year 2020 with 11% energy production from renewable energy, and in 2030, the European objective is 23% (Schmit, 2016b). Currently the government focusses on supporting solar panels on private houses', schools' and sports halls' roofs, one photovoltaic system on the ground being in Langsur-Mesenich, next to the highway to Trier, on the Mosel. Other such ground installations are still rare.

Sixth, on a smaller scale, the sport activities organized all over the country by the respective communes is a great example of smart leadership. The '**Sports pour Tous**' from 'Ville de Luxembourg', see: <http://vdl.lu/sports.html>, was founded in the 1980's with the objectives to increase the quality of life, to create social contact among people, to keep people healthy, in good shape, to prevent sicknesses and ultimately to improve joy and happiness, without any competitive character. The City of Luxembourg does everything in order to offer daily sports activities, indoors, outdoors and in the water, providing infrastructure and high quality classes to its citizens. Not only the City of Luxembourg, but most communes nowadays offer their sports/fitness program for all. The sports classes were at the beginning but have since been followed by other classes: language courses, photography, computer, cooking, walking, hiking, painting.... These courses are generally offered at a low price.

One Lux.Nat. respondent said: "These courses are not too expensive generally, but of course the wonderful city of Esch has to exaggerate when it comes to their language classes, but their sports classes are actually really reasonable. With the result that many people acquire new skills and qualifications and possibly new jobs. Many people work out in fun groups, improving their motivation and consequently their health improves, their physical health in general, while the risk for dementia decreases."

### *3.1.2 Results of Interviews – Foreigners in Luxembourg*

One Italian in Luxembourg is specializing his research on 'smart cities'. In his research he underlines his theory: the smart city of tomorrow is digital. Luxembourg will have to adapt to the change from the 'physical' city to the 'digital' city, claiming companies make more profit digitally than physically.

Here is his citation: "The difference between 'private' and 'public' today is between 'private' and 'digital' (google). Google knows more about me than myself. The concept of reality is completely changed.

Public offices are archaic, they do not understand this change to the digital world. I bought 'The Art of War' by Sun Tzu, and I read the book over and over again: Nowadays it would be important to understand better, how Google functions. You need to be better than Google, Facebook and Twitter. The problem is the organization of the city, as it has completely changed. Here one story from 2013:

A 45 year old man (married, one 15 year old daughter) receives gifts at home, without having ordered them. He is astonished by the content of the gifts: body creams against pregnancy stripes, pregnancy creams ... teenage pregnancy creams.

What he didn't know, but Google did: was that his 15 year old daughter used his computer to consult websites about teenage pregnancy, because she was pregnant. Only she and google knew. Google sent her these creams. Only then the father knew as well. Citation from the book from Henri Lefebvre, written in 1967: "A travers les diverses tendances s'esquisse une stratégie globale s'est-à-dire un système unitaire et un urbanisme déjà total). Les uns feront entrer dans la pratique et concrétiseront sur le terrain la société de consommation dirigée. Ils construiront non seulement des centres commerciaux mais des centres de consommation privilégiés : la ville renouvelée. Ils imposeront en la rendant « lisible » une idéologie du bonheur par la consommation, la joie par l'urbanisme adapté à sa nouvelle mission. Cet urbanisme programme une quotidienneté opératrice de satisfactions (notamment pour les femmes acceptantes et participantes). La consommation programmée et cybernétisée (prévue par les ordinateurs) deviendra règle et norme pour la société entière. D'autres édifieront les centres décisionnels, concentrant les moyens de la puissance : information, formation, organisation, opération. Ou encore : répression (contraintes, y compris la violence) et persuasion (idéologie, publicité). Autour de ces centres se répartiront sur le terrain, en ordre dispersé, selon des normes de contraintes prévues, les périphéries, l'urbanisation désurbanisée. Toutes les conditions se réunissent ainsi pour une domination parfaite, pour une exploitation raffinée des gens à la fois comme producteurs, comme consommateurs de produits, comme consommateurs d'espace. La convergence de ces projets comporte donc les plus grands dangers. Elle pose politiquement le problème de la société urbaine. Il est possible que des contradictions nouvelles naissent de ces projets, gênant la convergence. Si une stratégie unitaire se constituait et réussissait, ce serait peut-être irréparable. (Written in 1967)"

The globalization trend was pointed out by one respondent as being highly damaging, saying, all city centres look exactly the same. They have all the big same, identical chains all over. Luxembourg looks like any other big city. Where is the typical Luxembourg? Where are the small, typical little shops, and famous city centers?

Recently a new law was voted by the Luxembourg government for the 1-Euro-company, allowing the creation of more small companies, notably start-ups.

The respondent said: "This is smart leadership in Luxembourg: to help small companies and single company-owners. Nowadays only the big chains survive, killing all the small local shops. What a shame! Luxembourg holds against this dying of little companies with the 1-Euro-company. Single people are encouraged to create their own start-up, whatever their genius idea might be."

"In Copenhagen, Denmark, they have their amusement park 'Tivoli' running all year long, while the Schouberfourer in Luxembourg lasts traditionally 3 weeks end of August, beginning of September."

Another example is the creation of financial instruments such as Bank of China listing its first Green Bond in 2016 at the **Luxembourg Stock Exchange**, allowing for future generations to save the environment by investing in ecological, green projects worldwide. See: <https://www.bourse.lu/> and: <https://www.youtube.com/watch?v=xzT8vXCAB-I> Bank of China lists first Green Bond in Luxembourg.

The vision is to take the country Luxembourg further, to make it profitable for future generations, to have this vision of wealth and health for everybody, by inspiring people.

One respondent said: "Smart leadership is to encourage people to go further, by listening to people what they have to say, rewarding the job done, providing them with a vision, giving them clear directions, ensuring the objectives make sense, and are achievable. Change peoples' minds. This fast changing world needs fast adaptation, the ability to change. The most important saying is this one for the smart leader: 'Train people well enough so they can leave, treat them well enough so they don't want to.'"

Seventh, the smart leader in Luxembourg knows his employees well. He knows their capabilities, their talents. He establishes a 'competences map' and offers necessary training and coaching to his employees. Typical for Luxembourg is the abundance of resources and talents. On the one hand, there is a lack of talent, because of the small size of the country, on the other hand there is an abundance of talents given the fact that many people are migrating to Luxembourg from Europe and other countries worldwide. This constitutes also the next advantage for Luxembourg: the cultural mix, the differences between all these different cultures represent an advantage and creates the richness of the country, making it easier to create connections, to increase creativity, to build winning teams.

One respondent said: "For me, smart leadership means the optimization of resources by using employees' natural talents. Smart stands for: Simple or specific, measurable, achievable, realistic or relevant, time scaled or time line. Here is my favorite quote: Everybody is a genius. But if you judge a fish by its ability to climb a tree, it will live its whole life believing that it is stupid". Me, for example, I am not strong in mathematics, I prefer delegating mathematics to a person naturally talented. The smart leader is capable of detecting employees' natural talents, identifying everybody's strong points."

This statement is confirmed by other similar statements by cross-border workers, saying they bring talent to the country. Cross-border workers and foreigners in Luxembourg proudly confirmed they bring the necessary talent to Luxembourg, as Luxembourg was lacking talent before their arrival. This is no longer true, thanks to the foreigners and the cross-border workers, a fact confirmed by leaders in Luxembourg, cross-border workers and foreigners living in Luxembourg. The talents originally lacking in Luxembourg are attracted to the country, allowing leaders sufficient choice in talent.

### *3.1.3 Results of Interviews – Cross-Border Workers*

Eighth, the smart leader uses the country's multilingualism as a power house. There being three official languages: Luxembourgish, French, German, everybody is supposed to speak at least these three languages, as well as English and any other language: Portuguese, Italian or Spanish, depending on the country of origin. This mixture in languages, but also in cultures makes the richness of Luxembourg. The Government is pushing this mixture to be a major asset, advantage, and a plus for Luxembourg, contrary to most other countries. The Luxembourg Government with its education policy was capable of integrating the three official languages Luxembourgish, French, and German into the education system, adding English to it, more or less obliging everybody to speak all of these languages, and more. While many migrants confirm the high wages were initially the cause of them migrating to Luxembourg, later they appreciated the tolerant and open lifestyle and the multilingualism, all three not necessarily present in other countries.

One respondent from Belgium stated: "The Belgium Government was/is not capable of the integration of the three languages in Belgium into the education system. In Belgium, people speak only French, or only German, or only Flemish, depending on where they live. But nobody has to learn all three languages in school. This is the biggest asset of Luxembourg's education system, where the Government was so intelligent to integrate the three/four languages into the education system of everybody."

Cross-border respondents said, the integration of the mainly Moslem refugees into the education system and the work environment represents the biggest challenge Luxembourg and Europe faces after a long period of European construction and integration.

### 3.1.4 Results of Interviews – Rest of the world

One respondent offered his PESTLE and SWOT analyses for Luxembourg:

#### **“PESTLE**

Political:...Original member of the EU/EC, many EU/EC groups based here, small country surrounded by much more ‘powerful’ countries, often prepares legislation quickly in anticipation of future trends (end of secret banking, domiciliation of companies, tax reform, etc.), former Prime Minister Juncker is now the President of the European Commission

Economic:...Niche market, Value added expertise, excellent business conditions in general

Social:...Multi-cultural, cosmopolitan, vibrant and active, yet stuck in the past,

Technological:...Fibre-optics, aerospace, outer space, efficient and competitive production units, data-centres (or even IT in general)

Legal:...Intellectual Property, same-sex marriage, nationality, but not giving the foreign residents the right to vote

Ecological:...just look around you! A lot of green space, movement away from pesticides, etc.

#### **SWOT:**

Strengths:...Agile, competence-centric, attractive

Weaknesses:...‘Be careful what you wish for because you just may get it’ regret, poor image, public education system

Opportunities:...well-placed to continue being a financial sector. Could even do more

Threats:...Other countries have copied Luxembourg’s model

References:

<http://www.free-management-ebooks.com/dldebk-pdf/fme-pestle-analysis.pdf>

[https://www.mindtools.com/pages/article/newTMC\\_05.htm](https://www.mindtools.com/pages/article/newTMC_05.htm)”

One respondent from Poland said: “Yet, what I think smart leadership is - is leadership that involves human energy to reach goals, when people feel that company goals are their own, when the leader is authentic, honest and tries to use the potential of people, when they develop their skills. With regard to smart leadership in Luxembourg - additional factors - cross-cultural issues that the leader needs to take into account, more opportunities but also challenges.”

Another respondent from Poland said: “Local banks domiciliated in Luxembourg implement models of sustainability to their activities (e.g. environmental and social due diligence for project finance).

One respondent from China replied: "I feel uncomfortable to talk about smart leadership in your country that is something I barely have knowledge off."

One respondent from Syria answered: "I guess, you are more knowledgeable in this field, but what makes your research interesting is doing it in a particular place 'Luxembourg' so I would only suggest to see whether there is anything special in Luxembourg itself that leaders have to be aware of. For instance, leaders' or followers' traits/ or how leadership is transmitted over there? You might be surprised with my answer, but I will be direct. I don't think there is something called (in my opinion) "responsible leadership" simply by asking one question: have you ever seen a leader who is not saying he/she is responsible? Let's say theoretically; all leaders would say I am responsible especially to make his/her picture nice, great, and cool.

I try to say that there are foundations in how people think, feel, and act in the workplace. Wherever they are, there must be something they believe in which has a great impact on the way they do things. After researching I found that people's personal values are the foundation they rely on to do, decide, make connections, communicate, prioritize, and as you can see in the model of PPV in my paper. In the Arab world, there are different things you need to consider in order to operate business as same as any other country, it is not only about culture. It is more about the human him/herself. I can say that I am closer to values-based leadership in the Arab world. But there is still a need for more research to prove that.

As a summary, I don't have enough knowledge to assess smart leadership as you do. I would rather be keen to discover more on how people think, feel, and act and see what can have an impact on them, what can drive, inspire, and lead them."

One respondent from Germany said: "It is difficult to define 'smart' in this context. I assume it alludes to a possibly innovative contemporary style of leadership.

I regard myself to be in the tradition of transformational leadership as I am convinced that our current manifold political social/cultural, economic, ecological and technological challenges and problems urgently call for transformation of structures to improve our environment. This transformation, in my view, should be pursued with a strong reflective and restitution spirit. You might call it 'Curative Leadership'. For 'curative' movements to create, a smart leader must be able to attract followers who share the vision and mission voluntarily and passionately, as applied successfully in some social entrepreneurship ventures.

The notion of 'sharing' in this respect implies to emphasize on using social media for international networking, with the latter being a key leadership characteristics based on a high level of emotional and intercultural competence. In generating 'curative' movements, a smart leader must be able to



unlock potential of diverse follower segments, such as the Generation Y or digital natives and/or the middle agers and old agers.

For me, the current 'magic word' in business is co-creation which necessitates to appeal to a variety of diverse internal and external stakeholders when attracting resources for the movement at hand. Finally, following Erich Kästner's sentence 'es gibt nichts Gutes ausser man tut es' (there is no good thing except we do it) I suggest to combine transformational leadership with transactional leadership to have, in additions two visions, also 'landing gears' for quicker implementation of change".

One respondent from Israel and one from Australia said: "It is about civility".

One respondent from the UK answered: "I found the list below from some Mickey Mouse website - actually, it looks quite good to me. I guess, if you think it looks good also, you should use it and put a Luxembourg example on each point, possibly thinking of a typical young female perhaps.

1. Develop your personal leadership style. No one is born knowing how to be an effective leader. Spend time learning as much about yourself as possible. When you work on yourself, you're working on your leadership. Consider finding a good leadership program, coach, or mentor.
2. Learn from experience. Think strategically about how you can gain the experience you need. Delve into challenging projects that may give you unusual problems to solve; practice observing situations from different perspectives and learn from everything you do.
3. Don't be afraid to fail. Unless you're not trying at all, you will almost certainly fail, maybe more than once. The important thing is to learn how to take responsibility for your failures, extract their lessons, and change directions while still moving forward.
4. Have a compelling vision. When a crisis hits--and it will--having a vision and knowing that people are aligned with that vision keep things in check. If you are trusted as a leader, you'll be perceived as someone who can bring people through and keep things on track instead of falling apart.
5. Polish your people skills. Great leaders have great interpersonal skills. They care for their people. As a leader, you need to know how to listen quietly and hear what people are really saying, by asking questions and being open to the truth. When challenges come, it's especially important to open up and show you care.
6. Motivate yourself. Your commitment is a signal for others. If people can see that you are working hard toward attaining a goal, they will join you. Learn to tap into the motivation that gives you energy and passion, so in turn you can inspire others through difficult times.
7. Keep people informed. When times get tough, it's always tempting to hide, but that's the worst thing you can do. Stay visible and keep people informed even when it's bad news. People don't like to

feel excluded from progress or from problems; when you keep them current, they will be invested and prepared to help.

8. Inspire others. Inspiration is empowering; when you inspire people, you also give them a sense of purpose. When you lead by example and people feel inspired by who you are, it empowers them to be more effective and productive.

9. Find a true mentor. When times are challenging, find someone who has been there before, learned his or her lessons, and is willing to guide you along the way. A good mentor should have the experience you want to gain, and should also have a sincere desire to help you along the way. Mentoring has to be genuine and positive to be truly meaningful.

10. Take care of yourself. The best leaders take care of others, especially in challenging times. But if you neglect yourself you will soon be overwhelmed by pressure. Do what you need to do to keep yourself sharp and healthy, and remind yourself often that what you do is valuable."

Yet, another respondent from the UK compared 'smart' leadership with 'wise' leadership, stating: "Smart Leadership knows how to build and nurture a valuing environment in whatever organization. Wise Leadership goes beyond the technical competence and skills and knows how to build and nurture from human dimension. This is important in an age of digital life. My next publication is entitled 'Smart Leadership - Wise Leadership'."

Before discussing the critical points of smart leadership in Luxembourg, a concluding sentence to the positive points of smart leadership in Luxembourg. One respondent created this slogan: "Work smarter, not harder!"

### *3.1.2 Smart Leadership - Criticism*

More critical respondents reported about lack of 'smart leadership' in Luxembourg, bringing critical situations to the surface, including incompetent people at decision taking positions, bad management, bad working atmosphere, bullying, work harassment, stating:

"Smart leadership in Luxembourg is confused with delegation to other people with only one goal: "doing less - maximizing your personal revenue. I am speaking from 20 years of experience in the financial sector."

Luxembourg being small especially implies nepotism. Everybody knowing everybody implies more often hiring family members, not always the most competent candidate, or helping friends. Knowing the right people, not your qualities, guarantees your personal career.

One respondent said: "The constitutional referendum in 2015 and the left wing of the government in general."

“Smart leadership in Luxembourg? Small country, many people know each other? How many people hire friends and family for positions? In a country where many people want to earn money to buy things to impress their neighbours, how many people work for their team, their business rather than their own profit?

Many positions require experience, but won't hire people who are just a tiny bit older, whereas, the people who have just graduated have only limited experience but are not given the opportunity to gain experience – this is a vicious circle. Personal style? No. People competing with others on many levels (professional and private) no such thing as personal style.

Many people would rather go for a secure job (civil servant jobs – ministry, teachers...) - not many leadership possibilities. “

Respondents said, globalization having the grip over the entire world, there is no longer any difference between Luxembourg or any other country in the world regarding 'leadership' or 'smart leadership' principles. Literature that inspired was by Buckingham and Coffmann (2015), Hersey (1984), and Lencioni (2005). Most companies in Luxembourg being a subsidiary of a big international company, the rules of the international company prevail. Only while looking at typical Luxembourg companies – Cactus, Luxair, Namur, Oberweis, Frank Schleck bikes... and privately owned small Luxembourg companies or of course the State positions with their Civil Servant status, typical Luxembourgish rules and values can still be found. Smart Leadership comprises: Coaching, motivation, decision taking, problem solving, training, communication, separation private – professional life and personal empowerment. Setting clear objectives is key.

“What is typical Luxembourgish here? I am working in a Belgium-American company. Luxembourg doesn't exist here. In the Civil Servant positions, they are asleep! Otherwise everything is more and more globalized. Everything is the same. There is no more Luxembourg!”

“Empowerment means setting clearly defined objectives. If my objective is working 12 hours a day, instead of 8, then the smart leader has to interfere and live per example. It cannot be that some people need to be first and last in the office every single day.”

An Australian living in Luxembourg answered: "It is difficult in Luxembourg for SMART leaders as there is a great problem with culture for a majority of stakeholders. The leadership to drive change is not really there, it all seems to be just words, even though Luxembourg business and political leaders understand they must adapt. Communication is lacking or uninspired. In general, Luxembourg management and shareholders are wary about innovation, often to the point of not taking risks. There is a very low level of true entrepreneurship in the country although this is slowly changing. There is

an historic resistance to accepting creative ideas and creative methodologies. Despite, these negative points, I am broadly optimistic for SMART leadership in Luxembourg as new companies, new leaders and changes in the way of thinking emerge."

Several critical respondents said, there is no such thing as 'smart leadership' in Luxembourg. One respondent even said, there was no leadership at all. Nor smart nor anything else, leadership in general was not existent in Luxembourg.

"Smart Leadership in Luxembourg doesn't exist."

Especially the newly created University of Luxembourg was criticized by respondents and in general is heavily criticized by students for being anonymous, cold, without any flair. The University of Luxembourg was founded in 2003, and moved from several spread locations in the city of Luxembourg to one single location in Esch-sur-Alzette in 2015, 20 km away from the city, in a newly built, modern and futuristic building. The bad reputation only increased.

One respondent said: "I fight against what happens at the University of Luxembourg. That's the reason why I never applied for being a professor there. What happens at the University of Luxembourg is ridiculous. They all are obstinate, confined, limited, restricted on themselves to publish ridiculous publications that are completely useless and that nobody wants to read."

Another respondent stated: "The University of Luxembourg should not offer all studies. It is better for students to study outside of Luxembourg, at a highly specialized university, with high quality studies. Especially Medical studies, Luxembourg does not hold the capacities nor the patients to be able to offer medical studies."

"The University – Campus Belval – has a bad reputation amongst students, however, it is a nice example showing that they (the Government) actually wanted this place to flourish."

"Conclusion: while the idea was good, one of the best since I was born, there are still many improvements to be made."

Respondents also named Asport, Delphi, some banks and lux-Airport as non smart leaders, where the general working atmosphere is bad, so they said, with a climate of fear and oppression, low motivation, high number of layoffs and dismissals (Luxemburger Wort, 27 September 2016, p. 13).

Several respondents emphasized the need for planning Luxembourg as a 'smart city', if it wants to remain attractive in the future. With the question in mind: "How to attract talent to Luxembourg?", the city/country needs to reflect on 'smart city issues', in order to avoid traffic collapse, traffic jams,

housing issues, expensive real estate, environmental issues, preservation of nature (Leanza and Carbonaro, 2017).

While there are many good ideas in Luxembourg, their realization often is more difficult than initially thought, requiring continuous improvement by talented people. The intentions often are good, but less good are the realization and outcome. It is easier said than done. With this last statement, this section comes to an end. A summary table regrouping the above arguments follows.

### 3.2 SUMMARY TABLE: Criteria for Smart Leadership in Luxembourg and in the world

Criteria for Smart Leadership	In Luxembourg	In the world
Have a vision	x	x
Inspiring people	x	x
My own motivation	x	x
Respect	x	x
Trust	x	x
Understanding	x	x
Empathy	x	x
Communication	x	x
Humility	x	x
Positivity	x	x
Love	x	x
Integrity	x	x
Knowing my team(s)	x	x
Talent and competences	x	x
Delegation	x	x
Prioritization	x	x
Clear objectives	x	x
Simplify	x	x
Stop the so-called hard work	x	x
Return on experiences	x	x

Creativity	x	x
Return on experiences	x	x
Change Management	x	x
Training	x	x
Coaching	x	x
Problem solving	x	x
Rewarding the job well done	x	x
Empowerment	x	x
Separation professional life – private life	x	x
Work smarter – not harder	x	-
....		
Multilingualism	x	Yes, but different
Trilingual public education system	x	No
Multiculturalism	x	Yes, but different
Tolerance	x	Yes, but different
Openness for the different	x	Yes, but different
Integration at the education / school level	x	Yes, but different

In conclusion, it could be said, that it is the mixture of cultures and of languages that make the wealth of Luxembourg. The results in differences in the answers following the four categories are elaborated in the following: In conclusion, *Lux.Nat.* speak about the pioneering role of Luxembourg in Europe's development, the multiculturalism and the benefits of multilingualism, especially trilingualism in education and about the efficiency of their companies, the low turnover, the good working conditions. It is their tolerance, their openness for the different that guarantees wealth and peace. *Foreigners* and *cross-border workers* say, they bring the talent to the country – because the country is lacking talent, and they like the multiculturalism, multilingualism, the tolerance and openness for the different, and of course the good working conditions. *The rest of the world* often has little knowledge or awareness, asking "Where is Luxembourg?" The author's contribution to knowledge is exactly to fill this gap, to put Luxembourg on the map. The University of Luxembourg was only

created in 2003, there is a considerable backlog regarding research in general and on cross-cultural comparison in particular.

#### 4 CONCLUSION, DISCUSSION AND IMPLICATION

The purpose of this research was to discover what 'smart' leadership is in Luxembourg. The 42 interviewees from the four different categories confirmed mainly the literature. Similarity and differences in the four categories were shown in the interviews section. While mainly the extant general literature is confirmed, there is however new knowledge added to the existing knowledge about smart leadership in particular in Luxembourg.

The biggest cultural peculiarities are Hofstede's cultural dimension scores: High Uncertainty Avoidance, high Collectivism, low Power Distance, medium Masculinity/Femininity, high Long-term Orientation, and medium Monumentalism. These place Luxembourg on the map of the world in a quadrant without any other country around, a unique constellation, found nowhere else worldwide. Indeed, this research is about civility.

Another peculiarity is the trilingual public education system, passing from Luxembourgish in kindergarten as language of instruction, to German in primary school, to French in secondary school as language of instruction.

With around 50% foreigners making up the population, multilingualism and multiculturalism is lived every moment. With the cross-border workers representing 30% of the current workforce this situation changes radically during the working hours 8h-18h, with enormous flows of people from the neighboring countries, including traffic jams. The tolerance for the different is the next peculiarity of Luxembourg, situated right in the middle of Europe, being the heart of Europe, the engine, the creator of many European ideas and realizations, e.g. the Schengen treaty....

In comparison with the rest of the world and the extant literature discussed here above, the main attributes of smart leadership are fulfilled in Luxembourg, see also <http://www.businessnewsdaily.com/5352-smart-leadership.html>;

<http://www.inc.com/lolly-daskal/10-smart-leadership-solutions-for-every-challenge.html>;

<https://www.entrepreneur.com/article/199908>

So, what is different in the Grand Duchy of Luxembourg? Despite this research's results showing mainly Luxembourg matching the theory of 'smart leadership', the main differences have been elaborated. These are the trilingual public education system, multilingualism, multiculturalism, the mixture of cultures, and the openness and tolerance for the different. The trilingual public

education system works as follows – in shortened version: the language of instruction is Luxembourgish in kindergarten, in primary school the language of instruction is German, and in secondary school the language of instruction is French. For details see Weber and Horner (2008), also explained by Schinzel (2014b, 2017).

In conclusion, it is the mixture of cultures and languages that makes the richness of Luxembourg's smart leadership, together with the tolerance and openness for the different.

What is more, Luxembourg has always had new ideas to ensure wealth and health for its citizens. It was always capable of re-inventing itself, thanks to its long-term orientation. Uncertainty Avoidance being near 100%, Luxembourgers argue this as an advantage: once everything else is ensured and secured, they can take care of the fun part of life.

Respondents named the following attributes of smart leadership, equivalent to the rest of the world: have a vision, inspiring people, my own motivation, respect, trust, understanding, empathy, communication, humility, positivity, love, integrity, knowing my team(s), talent and competences, delegation, prioritization, clear objectives, simplify, stop the so-called hard work, creativity, return on experiences, training and coaching, change management, rewarding the job well done, problem solving, empowerment, separation professional life – private life. What is specific for Luxembourg is: the trilingual public education system, multilingualism, multiculturalism, the mixture of cultures, the openness and tolerance for the different.

Respondents named the following smart leaders in Luxembourg: Cactus, SES Astra, CFL Multimodal, DuPont de Nemours, Ville de Luxembourg, Cargolux, Guardian, Lush Cosmetics, the Luxembourg Stock Exchange, CBL.

Respondents named the following 'not-smart' leaders in Luxembourg: University of Luxembourg, Asport, lux-Airport, and the constitutional referendum in 2015 and the left wing of the government in general.

In conclusion, the author's proposition was confirmed: *'Smart leadership in Luxembourg' is deeply anchored in Luxembourg's cultural and linguistic identity in the middle of Europe.*

## 5 RESEARCH LIMITATIONS

Cultural research has been in the focus ever since Hofstede's landmark study. While huge numbers of researchers gather to research groups, around Robert House (2004) - the GLOBE – and Ronald Inglehart (2008, 2011) – the World Values Survey, see: <http://www.worldvaluessurvey.org/wvs.jsp>, the author, as a single researcher, obviously cannot compete with these big groups. Nevertheless, this study, a combination of Hofstede's cultural dimensions study together with 'smart leadership', can pave the road for further research at the



crossroads of culture and leadership. Time limitation and financial limitations are other limitations of this study, performed mainly during spring-summer-autumn 2016, with the objective of conference participation and publication in 2017. This research might be useful for people working and living in Luxembourg. Human Resources managers and other deciders might find the results of the 42 interviews interesting, finding themselves in some of the citations.

Hofstede's cultural dimensions in Luxembourg being as follows – in short: high Long-Term Orientation (LTO), high Uncertainty Avoidance (UA), high Collectivism (low Individualism), combined with high salaries and a very good healthcare system, with high fringe benefits, seem to attract talent to Luxembourg. All these attributes, together with the trilingual public education system, representing a challenge for every pupil and parent, working in Luxembourg, is attractive, despite the peculiar weather.

## 6 FUTURE RESEARCH

Future research could focus first on transformational leadership and on change management in Luxembourg. "How to make change happen in multicultural, multilingual Luxembourg?" "What are the differences in 'change management' between Luxembourg and the rest of the world?" or: "Is change fast or slow in Luxembourg?" Another path of further research could be: "Smart City Luxembourg?" Future research could also focus second on talent search in Luxembourg, in combination with responsible and smart leadership, and linguistic and cultural specificities. The research question could be: How to find the talent your company needs in Luxembourg? How to attract the right people? How to train the existing people? The title could be: "In search for talent in multilingual, multicultural Luxembourg."

## REFERENCES

- Adam, A. (2016). "Standort auf Jahrzehnte gesichert". Der US-amerikanische Chemiekonzern DuPont will sein Werk in Contern erweitern. Luxemburger Wort, 25. August 2016, p. 11.
- Austin, W.J. (2009). Strategic Planning for Smart Leadership. New Forums. Stillwater, Oklahoma.
- Banai, M. and Reisel, W.D. (2007). The influence of supportive leadership and job characteristics on work alienation: A six-country investigation. Journal of World Business, Volume 42, Nr. 4, December 2007, pp.463–476.
- Briley, D.A., Morris, M.W. & Simonson, I. (2005). Cultural Chameleons: Biculturals, Conformity Motives, and Decision Making. Journal of Consumer Psychology, Vol.15 No. 4, pp. 351-362, available at: <http://works.bepress.com/briley/5/html>
- Buckingham, M., and Coffmann, C. (2015). First break all the rules. Simon & Schuster. Pocket Books. London. UK. Cactus available at: <http://www.cactus.lu/fr/yuppi/gallery/city-jogging-luxembourg-0>
- CFL available at: <http://www.cfl.lu/espaces/groupecfl/en/le-groupe/participations/cfl-multimodal>; or <http://cfl-mm.lu>
- Cargolux available at: <http://www.cargolux.com/>
- SES Astra available at: <http://www.ses.com/4232583/en>, and <http://www.ses.com/fleet-coverage>
- Ville de Luxembourg, Sports Pour Tous available at: <http://vdl.lu/sports.html>
- Charan, R. (2007). Leaders at all Levels. John Wiley & Sons.

- Cortey, L. (2016). Une usine de yaourts a Bettembourg. Le spécialiste du yaourt grec va investir 100 millions d'euros et créer 100 emplois. *Luxemburger Wort*, 29. Juli 2016, p. 13.
- Drucker, P. (2004). What makes an Effective Executive? In: Goleman, D. (Ed.). *Harvard Business Review: On Leadership*. www.hbr.org
- Drucker, P. (2011). *Management Challenges for the 21st Century*. Routledge. London and New York.
- DuPont available at: <http://www.dupont.com/products-and-services/fabrics-fibers-nonwovens/protective-fabrics/brands/tyvek.html>
- Elenkov, D.S., Judge, W., and Wright, P. (2005). Strategic leadership and executive innovation influence: an international multi-cluster comparative study. *Strategic Management Journal*, Volume 26, No. 7, July 2005, pp.665–682. doi: 10.1002/smj.469
- Goldsmith, M. (2007). *What got you here won't get you there – How successful People become even more successful*. Hyperion. New York.
- Greenleaf, R. (2002). *Servant Leadership*. Paulist Press. Mahwah, New Jersey.
- Guardian available at: <http://www.guardian.lu/values/index.htm>
- Hersey, P. (1984). *The Situational Leader*. Warner Books. New York: NY.
- Hofstede, G. (2001). *Culture's Consequences: Comparing Values, Behaviours, Institutions and Organizations across Nations* (2nd ed.). Thousand Oaks, CA, USA: Sage.
- Hofstede, G., Hofstede, G.J., and Minkov, M. (2010). *Cultures and Organizations. Software of the mind. Intercultural Cooperation and its Importance for Survival* (3rd ed.). New York, NY, USA: Mc Graw Hill.
- Hofstede, Geert, online available at: <http://geert-hofstede.com/luxemburg.html>
- House, R.J., Hanges, P.J., Javidan, M., Dorfman, P.W., & Gupta, V. (2004). *Culture, Leadership and Organizations: The GLOBE Study of 62 Societies*. Thousand Oaks, CA, USA: Sage.
- <http://www.businessnewsdaily.com/5352-smart-leadership.html>
- <http://www.inc.com/lolly-daskal/10-smart-leadership-solutions-for-every-challenge.html>
- <https://www.entrepreneur.com/article/199908>
- <http://www.relaispourelavie.lu/>
- <http://www.free-management-ebooks.com/dldebk-pdf/fme-pestle-analysis.pdf>
- [https://www.mindtools.com/pages/article/newTMC\\_05.htm](https://www.mindtools.com/pages/article/newTMC_05.htm)
- Inglehart, R. (2011). "Values change the world. World Values Survey", Brochure, available at: <http://www.worldvaluessurvey.org/html>
- Inglehart, R., Foa, R., Peterson, C. & Welzel, C. (2008). Development, Freedom, and Rising Happiness. A Global Perspective (1981-2007). *Perspectives on Psychological Science*, Vol.3, No. 4, pp. 264-285, available at: <http://www.worldvaluessurvey.org/html>
- Kraemer, J.-P. (1995). Une école plurilingue dans un pays multiculturel. In: G. Dondelinger and A. Wengler eds. (1995). *Plurilinguisme & identité culturelle. Actes des assises européennes pour une éducation plurilingue* (Luxembourg, 3-6 Novembre 1993). Louvain-la-Neuve: Peeters.
- Langenbrink, C. (2016). Die Bedeutungslosigkeitsfalle. Die Grossregion auf der Sinnsuche – ein analytischer Erklärungsversuch. *Luxemburger Wort*, Sa/So 3/4 September 2016, p. 10-11.
- Leanza, E. & Carbonaro, G. (2017). Socially Inclusive Urban Transformation After the Great Recession. In: Concilio, G. & Rizzo, F. (Eds.) (2017). *Human Smart Cities. Rethinking the Interplay between Design and Planning*. Springer International Publishing Switzerland. DOI 10.1007/978-3-319-33024-2. <http://www.springer.com/series/7906>.
- Lefebvre, H. (2009). *Le droit à la ville*. (3e ed). Anthropos.
- Lencioni, P. (2005). *Thriller psychologique pour manager autrement*. Editions d'Organisation. Paris.
- Luxemburger Wort* (Ed.) (2016). *Lux-Airport: OGBL beklagt "Klima der Angst und Unterdrückung"*. *Luxemburger Wort*, Dienstag, 27 September 2016, p. 13.
- Maccoby, M. & Scudder, T. (2011). *Strategic Intelligence: A Conceptual System of Leadership for Change*. Performance Improvement, March 2011.
- Maccoby, M. (2015). *Strategic Intelligence*. Oxford University Press. Oxford, UK.
- Maxwell, J.C. (2013). *5 Levels of Leadership. Proven Steps to Maximize Your Potential*. Center Street. New York, Boston, Nashville.
- Maxwell, J.C. (2008). *Success – What every Leader needs to know*. Thomas Nelson, Nashville, Tennessee.
- Maxwell, J.C. (2012). *Developing the Leaders around you*. Jaico Publishing House, India.
- Piramal, G. & Netarwala, J. (Eds) (2005). *Smart Leadership. Insights for CEOs*. Penguin Portfolio. New Delhi.
- Rao, M.S. (2012). *Smart Leadership. Lessons for Leaders*. Sterling Publishers. New Delhi.
- Rudan, G. (2011). *Practical Genius*. Touchstone. New York.

- Schinzel, U. (2013). Why are people in Luxembourg happy? An exploratory study of happiness and culture measured by the dimension of a language as identifier in the Grand Duchy. *Journal of Customer Behaviour*, 12(4), pp.315-340. doi: 10.1362/147539213X13575568505822
- Schinzel, U. (2014a). Hofstede in Luxembourg. Intercultural comparison of Luxembourg-France-Germany. *Journal of Strategic and International Studies*, Volume IX Number 6, 2014. ISSN 2326-3636.
- Schinzel, U. (2014b). Multinational – multicultural - multilingual Luxembourg – a system of integration – or – a system of failure? *Journal of Strategic and International Studies*, Volume IX Number 6, 2014. ISSN 2326-3636.
- Schinzel, U. (2015). An analysis of cultural shifts – the examples of Luxembourg, France, Germany. *World Review of Entrepreneurship, Management and Sustainable Development*, Vol. 11, Nos. 2/3, pp.308–326.
- Schinzel, U. (2017). How to Educate Multicultural Managers? The Example of Luxembourg. In: Rozkwitalska, M., Sulkowski, L. & Magala, S. (Eds.) (2017). *Intercultural Interactions in the Multicultural Workplace. Contributions to Management Science*. Springer International Publishing Switzerland. DOI 10.1007/978-3-319-39771-9\_16. <http://www.springer.com/gp/book/9783319397702>
- Schmit, L. (2016a). Die Zukunftsmacher. Experten diskutieren, wie die 2dritte industrielle Revolution“ in Luxemburg Realität werden kann. *Luxemburger Wort*, Sa/So 3., 4. September 2016, p. 15.
- Schmit, L. (2016b). Die glänzende Zukunft. Lange Zeit als teuer verschrien, sthet die Solarenergie vor dem Durchbruch. *Luxemburger Wort*, 23. August 2016, p.8-9.
- Spizzo, D. (1995). *La nation luxembourgeoise. Genese et structure d'une identite*. Paris: L'Harmattan.
- STATEC Luxembourg (2016). *Luxembourg in figures*. Luxembourg, Imprimerie Centrale, Luxembourg.
- The Luxembourg Stock Exchange available at: <https://www.bourse.lu/> and: <https://www.youtube.com/watch?v=xzT8vXCAB-I>
- The World Factbook. Available at: <https://www.cia.gov/library/publications/the-world-factbook/geos/lu.html>
- Tsu, S. (2015). *The Art of War. The Original Authoritative Edition*. Chiron Academic Press. Wisehouse Publishing. Sweden.
- Vlamiš, A. (1999). *Smart Leadership. Management Briefing*. American Management Association International. New York.
- Weber, J.J., & Horner, K. (2008). The Language Situation in Luxembourg. *Current Issues in Language Planning*, 9(1), pp.69-128. doi: 10.2167/cilp130.0

## WHAT IS SUCCESS OR FAILURE IN M&AS? A STAKEHOLDER PERSPECTIVES

Schriber, Svante<sup>1</sup>; Meglio, Olimpia<sup>2</sup>

<sup>1</sup>Stockholm Business School, Stockholm University, Stockholm, Sweden

<sup>2</sup>DEMME, University of Sannio, Benevento, Italy

### ABSTRACT

Success and failure arguably are the soundboard concepts in acquisition research. So far, the academic debate has been primarily concerned with measuring performance and assessing success and failure from the shareholders' perspective. In this paper we offer a different view. Several stakes, and therefore stakeholders, are touched on by acquisitions. Consequently, we propose to conceptualize success and failure needs in the light of the stakeholder perspectives. We achieve this aim by critically analyzing some of the most common approaches in extant research and elaborating a perspective explicitly building on organizations as comprising a multitude of stakes. In turn, this allows broadening the debate to discuss for whom acquisitions may be a success, how stakes change over time, and point to both common biases and overlooked insights. In so doing, this study contributes to critically assess and complement existing hegemonies in conceptualizing success or failure in acquisition research. It thereby serves to increase success or failure construct clarity and sensitivity to nuances, variations, dynamics, and overlapping interests in one of the most common strategic tools with far-reaching consequences to societies, firms, and individuals

*Keywords: mergers and acquisition, success, failure, acquisition performance, stakeholders, multiplicity of performance measures, acquisition outcomes.*

### INTRODUCTION

Success and failure are soundboard concepts in acquisition research. Strategic management perspective typically stresses acquisition success as vital to increase firm competitiveness and the many explanations for this are in focus. (Harrison et al. 1998, Zaheer, Castañer and Souder 2011).

Increasingly, concerns are raised about the operationalization of acquisitions outcomes. Since the very perception of success or failure depends on how success and failure are measured, several scholars have convincingly advocated for paying more attention to the measures of acquisition performance. As a result, research has focused on the technical aspects and resulted into ever finer nuances of

success or failure both in aggregate meta-measures (King et al., 2004), and specific measures (e.g. Lubatkin and Shrieves, 1986; Zollo and Meier, 2008; Cording et al., 2008).

We contend however that important issues remain insufficiently addressed. While we see value in e.g. revealing drivers of acquisition success and failure, and identifying more precise measurements, we believe acquisition research suffers from a limited attention to what these concepts may mean. As their meaning largely has been taken for granted if not completely overlooked, we contend that most research represents a homogeneous view. More precisely, most acquisition research argues implicitly or explicitly that acquisition success or failure is best measured in financial terms, leaving a more nuanced and multifaceted understanding of these concepts yet to be developed. Before this issue is better understood, debates about what measurements to use are likely to remain fragmented, biased, and incomplete. We build on the recognition that acquisition success has received insufficient attention (e.g. Meglio and Risberg, 2010), and that potentially several important perspectives remain in the shadow of dominating research accounts.

This is the gap this paper intends to fill, that is, the conceptualization of success or failure in acquisitions. We therefore aim to answer the following: “What is success/failure in acquisitions?”. We achieve this aim by broadening the domain of analysis from the prevailing, unifying perspective of the shareholders to other, often neglected, or silenced stakeholders.

We adopt a stakeholder view (Freeman 1984) to analyze the most common approaches in extant research. In turn, this allows broadening the debate to discuss for whom acquisitions may be a success, and point to both current biases and less commonly debated insights. In so doing, this study contributes to critically assess and complement existing hegemonies in conceptualizing success or failure in acquisition research. It thereby serves to increase success or failure construct clarity (Suddaby, 2010). Second, it illustrates that different groups are typically ascribed different stakes that acquisitions might sensitize. While these are shown to be unevenly attended by acquisition researchers, we also point to interests not yet covered thus pointing to potential ‘blind spots’ in research that, if not addressed, may delimit theorizing about acquisition success, failure, and performance.

## **BACKGROUND**

Acquisition research is, despite its seemingly unifying label, a number of complementary fields that cover numberless angles, and is enriched by various theoretical perspectives and empirical foci (Haleblian et al. 2009). In turn, this has encouraged a rich research searching for various performance drivers and a corresponding interest in how performance is defined (Zollo and Meier, Meglio and Risberg 2011).

The debate seems to be polarized around the following choices: financial versus accounting measures, objective versus subjective measures, single versus multiple indicators, short term versus long term. Meglio and Risberg (2011) found that the majority of the studies they reviewed (101) measure acquisition performance as the share price variation around the announcement date. In other words, financial and objective measures dominate the acquisition field. However, some scholars claim that one can also understand acquisition performance as a set of interpretations made by the acquiring company's executives in their attempts to understand the generating mechanisms of acquisition performance (cf. Côté et al. 1999). Therefore, objectivity and subjectivity live side by side in the acquisition field.

The multidimensional nature of acquisition performance is another important trait of the construct. Cording et al. (2008) find that acquisition performance is not one, but several measures, and that these measures tell different stories regarding how an acquisition performs. Zollo and Meier (2008) assess the measures that are used for acquisition performance, pointing to a variety of variables, and echo the claim that this concept is multifaceted. Despite these claims, research appears to provide a dominantly homogeneous picture of the acquisition performance concept. In their review Meglio and Risberg (2011) find that even though scholars claim that acquisition performance is multidimensional, they tend to measure it along a single dimension and often use a single indicator.

Regarding the time interval of measurement, the extensive use of stock-market based measures indicate that acquisition performance is measured in a short time window around the date of announcement. When *ex ante* and *ex post* measures are compared, interestingly, they seem to be divergent, as noted by Schoenberg (2006), suggesting that initial projections suffer from lack of information that unfolds, and hence can be captured, only as the process evolves. Moreover, Zollo and Meier (2008) find that the common short-term event-study measure remains unrelated to other metrics.

From this brief reconstruction, it emerges that the concept, while treated as unitary, presents a multiplicity of meanings, dimensions, indicators and time intervals that make findings fragmented and inconclusive. Following the same line of reasoning we contend that, just like acquisition performance, acquisition success or failure are broad and ambiguous concepts but are generally treated as unitary. We also would like to outline that success does not simply mean "outcome or result", it may also mean the degree of attainment of a desired outcome (Merriam-Webster Dictionary and Thesaurus, 2016). This, applied to the acquisition domain, means that the assessment of an acquisition as successful or not calls into question expectations of actors involved into the process. So far, as discussed above, acquisition scholars have emphasized or given voice mainly to shareholders or top managers. These latter are given voice e.g. in interview or survey studies of

acquisition performance (e.g. Kitching, 1967; Graebner, 2004; Bauer and Matzler, 2014), where the perspective of top management is accounted for. While we have no problem with research explicitly taking the perspective of managers or providing them with advice, we contend that a richer understanding can be achieved by considering other ways to define success and failure and explicitly debating about whose success or failure is primarily considered. Put differently, we believe there are other, legitimate stakes in acquisitions and that this, so far, is poorly reflected in acquisition research. Our underlying idea is to broaden the variety of ways in which acquisition success or failure might be measured, but also adding clarity by specifying an important boundary condition (Suddaby, 2010): success or failure for whom? By answering this question, we break down the unifying view of acquisitions as reflecting the stakes of shareholders or of top managers only, which are fairly well voiced in existing literature, and enlarge the domain of analysis taking into account the stakes of stakeholders other than shareholders.

### **TAKING A STEP BACK: WHOSE STAKES?**

As discussed above, success calls into question the attainment of goals. This applied to a firm pursuing an acquisition implies that success or failure should be assessed in relation to the goals the deal is intended to achieve. Goals for acquisitions are typically broadly stated: improving competitiveness, achieving synergies, entering new markets and the like. Acquisition performance measures used so far are assumed to be suitable to account for such broad goals. Here we do not want to state the merits of various measures. Rather, we would like to outline that in assessing success or failure we should not simply take into account goals of those initiating acquisitions but also stakes touched upon by acquisitions. Of the multitude of stakes acquisitions influence, mainly those of shareholders and top managers are generally voiced in the conventional discourse. We contend that silent or silenced stakes in the decision-making process may play an important role during the post-acquisition process and have an impact on the ultimate acquisition performance. This paper takes, therefore, a stakeholder perspective (Freeman 1984). A stakeholder perspective implies considering the interests, power, and positions of various groups with an interest in a focal venture. Despite its proven usefulness in many fields in business studies more broadly, a stakeholder perspective has remained relatively overlooked in acquisition literature with some exceptions (Anderson, Havila and Nilsson 2013, Meglio 2015).

Embracing this perspective might offer several advantages. It allows bringing existing yet sometimes fragmented studies together within a more coherent framework and condensing some of the main stakes associated with each stakeholder. It allows pointing to differences between the stakes of different stakeholders, and it is possible to sketch the stakes that are not yet described in acquisition

research. If of less value in terms of mere gap-spotting in the narrow sense (Alvesson and Sandberg, 2011), this renders a liberating power to break the confinements within which goals can be expressed or thought. It therefore seems to us that a stakeholder perspective offers much by means of moving research forward with regards to what constitutes success or failure.

## ACQUISITION AS MULTIPLICITY OF STAKES

Opening up the debate to the more fundamental issue of what stakes may be involved in acquisitions requires developing how this research has, or has not, described, the stakes of stakeholders, other than shareholders, typically involved in acquisitions. Put differently, the key to the contributions of this paper lies in discussing how each stakeholder has typically been treated in acquisition research, highlighting the stakes ascribed, silenced or even denied, and whether and how these stakes are intertwined. Our starting point is the most popular, if not sole, stakeholder accounted for by extant research; the shareholder, and then move onto the discussion of other and more neglected stakes and stakeholders.

### *Shareholders*

The traditional shareholder perspective argues that the overall goal function of a firm should be to maximize shareholder value (Capron 1999). Moreover, it has more important implications since it argues that firms not only should keep their eyes on the prize in terms of stock price, but that deviations from this rule or complementing it with other perspectives is potentially detrimental not only to financial performance but may come at a loss to societal productivity (Friedman, 1970). This view is the taken for granted perspective in much acquisition research (e.g. Lubatkin and Shrieves, 1986).

However, the notion of shareholder value must be considered simplified. Several studies have highlighted the difference in returns to acquiring and target shareholders, many of which claim that target owners gain at the expense of acquiring shareholders (Datta et al. 1992, Bruner, 2002). In sum, when we assess success or failure from a shareholder's perspective we should clearly state whether we are considering the acquiring or the target companies' shareholders.

### *Managers*

Managers are also well voiced in existing literature. Whereas managers are typically ascribed the role of serving shareholders' interests, this is not always true. Agency theory argues that owner-manager separation inevitably comes with potential goal deviation. For instance, managers can attempt to enrich themselves financially and in terms of status without this benefiting, or even coming at the



expense of owners, as in the case of acquisitions (Mueller 1969). Indeed, Trautwein (1990) found empire-building aims to have more research support than efficiency gains.

The agency theory has been subject to huge scrutiny that has outlined several drawback (see for instance Goshal's 2005 penetrating analysis of implications for management practices).

Here we want to outline that there is a tendency to conflate the managerial hierarchy to top managers. This denies the possibility to differentiate between those in the top with an influence on the acquisition in decision process, and those set to execute it – if they get to stay. Although often overlooked in research some research has described the precarious squeeze of middle management (Meyer, 2006). On the one hand, they are expected to implement the acquisition. On the other, they run the risk of being made redundant by overlapping competencies with managers from the other firm. Thus, middle managers are at simultaneously tool and victim in acquisition processes (Schriber, 2012).

#### *Employees*

Employees are well represented in existing literature. Many studies have highlighted the negative effects on employees that acquisitions may have. For instance, acquisitions often are motivated by resource overlaps that offer room for efficiencies through resource reduction and redundancies (Siegal and Simons 2010). There are many studies taking an explicit perspective that highlights the effects on employees (Seo and Hill, 2005), pointing to stress, anxiety, fear of job loss, identity challenges, conflict (Meyer 2008), cultural clashes and the like. The fundamental view conveyed, therefore, is one where employees wish to avoid uncertainty, keep their jobs, remain unaffected by new identities, keep existing power order, and not have basic assumptions and other cultural aspects altered.

While one can easily sympathize with many of these, they are not necessarily complete or always true. For instance, Teerikangas (2010) showed that target employees may well stand to win from acquisitions when the situation before was uncertain. Thus, the aim to keep uncertainty low may well remain, but acquisitions might actually reduce it, rather than increase it. Moreover, while acquisitions can challenge existing status or power orders (Meyer, 2008), this does not by necessity mean a change for the worse. There is enough evidence in research of poor working conditions in non-acquisition settings to suggest that while acquisitions may well make matters worse, this might not be the entire picture. For instance, Cooke (2006) found that employees can experience both benefits and drawbacks, simultaneously: acquisitions by foreign firms into China often leads to higher wages, but also tighter performance controls of employees. Put differently, some efforts may be welcomed, others less so, but this granularity is often lost in acquisition research.

Moreover, when distancing oneself from the literature it is possible to see that there is an understandable but limiting emphasis on current employees. Put differently, although completely

legitimate and more concrete, current employees only constitute one potential stakeholder group. If one takes a broader, temporal perspective (Shi, Sun and Prescott 2012) another hidden group in acquisition research appears, the one made up of potential employees who are rarely receiving a matching level of attention. Concretely, successful acquisitions leading to firm growth opens up to new employments. The worry explicated in much acquisition research is that this merely increases the number of people exposed to a variety of stress, anxiety, and job loss (e.g. Seo and Hill, 2005). In sum, while strategy research is concerned with acquisitions as means to firm growth, organization behavior research has not been equally concerned with overlapping interests between managers and current employees, or how profitable acquisitive growth offers positive opportunities to potential employees, but focused squarely on negative aspects on current employees.

#### *Customers and suppliers*

Several studies have shown how external relations may be affected by acquisitions. One of the main themes refers to loss of stability in network relations. Acquisitions encompass a broad spectrum of changes that actually cause the dissolution of business relationships with customers and suppliers (Anderson, Havila and Salmi 2000). Key personnel leaving a company, dissatisfaction produced by failure to meet customer requirements, bad reputation and financial difficulties of the acquiring company, less favorable business conditions, or product replacement may all be causes for terminating a business relationship (Öberg 2013). This in turn requires careful scrutiny of customers with the goal of reassuring them using customer relationship management strategies to nurture the business relationship with them.

Öberg, Henneberg and Mouzas (2007) showed how acquisitions can influence customer perceptions of the relation if not carefully managed through communication and symbolic efforts. Indicating the magnitude of this problem, Bocconcelli, Snehota and Tunisini (2006) showed that as many as 80 percent of customers may leave for another supplier, especially when a previously trust-based relation shifts toward increased formalization based on contractual agreements.

Suppliers are key stakeholders as purchasing is strictly related to the cost and quality of the purchased components (Holtström 2013). Acquisitions emphasizing cost savings in this function have a direct impact upon suppliers' corporate profitability. It may imply reduced/increased volumes, generally lower prices, and compressed lead times. Revising any of these aspects may put the supplier in a difficult position. Empirical evidence about horizontal mergers shows that, on average, suppliers experience significant declines in cash-flow margins subsequent to downstream mergers, as a consequence of an increased buying power. Fee and Thomas (2004) further contends that purchasing gains for the merging companies depend on the type of suppliers (retained versus terminated) and the industry contexts (concentrated versus fragmented). Suppliers who are terminated after a merger

experience significant negative abnormal returns at the merger announcement and significant cash flow reduction after the deal. Moreover, buying power effects are more pronounced when the merging companies operate in relatively concentrated industries.

Suppliers, just like employees, are not all alike: their relative importance might depend on the type of material/service supplied, or the existence of alternative suppliers and of switching costs. Taken together, these factors determine the type of relationship between the parties. A deal does not necessarily negatively affect the position of suppliers, yet it certainly adds uncertainty to the relationship with the merging parties and requires the renegotiation of contractual provisions. Again, the tendency also of allegedly critical acquisition research to embrace a typical competitive strategic viewpoint becomes visible in the emphasis on belligerent, rather than symbiotic relations. For instance, acquisitions leading to increased competitiveness e.g. through new innovation (Puranam and Srikant, 2007) may benefit suppliers and customers – a point rarely noted in current acquisition research.

#### *Consultants*

Acquisitions are, on the whole, typically rare events in the history of firms. This places managers at a disadvantage when conducting acquisitions, in turn creating fertile ground for consultants offering advice at various stages in the acquisition process. Although often not mentioned explicitly but considered from a competence resource, others have taken a more critical stance, openly questioning consultant loyalty to shareholder values (Parvinen and Tikkanen 2007). Among consultants investment banks play an important role. As Kesner, Shapiro and Sharma (1994) outline, the circumstance that investment banks act as agents for both the bidding and the target create conflicts of interests. Such conflicts of interest may cause bidding companies to bid beyond their financial capacity or pay a price where the target company is not worth buying. For its peculiar position, an investment bank experiences the so called “negotiator’s dilemma”, that is, choosing between collaborative tactics that create value for all the parties involved in the deal, and opportunistic tactics that yield even greater value for itself and lower value, or even no value, for the other parties. This generally produces greater premiums paid and puts at risk the achievement of acquisition goals for the acquiring firm. Of course, the position of the acquiring is weaker than that of the target, whose shareholders generally benefit from greater premium prices. Reputation effects for continued business likely mitigate self-interest by investment banks.

## **SUCCESS AND FAILURE MULTIPLICITY**

The academic debate on acquisition success has been heavily geared toward issues to do with acquisition performance. More specifically, this debate has centered on measures within a very

narrow perspective leaving some important issues unaddressed, and typically taking an explicit or implicit shareholder perspective. Within both the financial and the strategic management fields, success squarely is equaled to financial value creation to shareholders.

In turn, this has several potential explanations. One is the fundamental interest in strategic management research to produce insights to managers and, in turn, to offer increased financial value to shareholders. Another is the preference for (seemingly) objective, observable and easily quantifiable data, explaining why acquisition performance research is so heavily biased toward financial or accounting data from secondary, archival sources (Barkema and Schijven 2008) in turn associated with the proliferation of databases (Haleblian et al. 2009). Although some have drawn on other measurements such as interviews with managers (Kitching 1967), there is a dominance by financial measures, in turn reifying financial institutions and taking-for-granted a financial outlook on acquisitions.

Here we would like to discuss the role scholars play in influencing this state of affairs. Acquisition scholars play an important role in giving voice to stakes other than that of shareholders. If the majority of the stakes we have discussed in this paper are not only silent but also silenced in research, this is because scholars have not shed light on them. Reasons are many. The tendency to conformity referred to as gap spotting research (Alvesson and Sandberg 2011) is probably the most important because is strictly linked to our publishing norms in management journals and editors' policies. Their stake is to get published in order to get promoted and this explains their tendency to reproduce the same stock of knowledge, often, with minor contribution to advancing our knowledge. Moreover, the system of peer review may promote traditional, linear theoretical development at the expense of those contributions that challenge taken for granted accounts.

Regardless of the explanations, the effect to us seems to be an unfortunate bias that however can be addressed by shifting perspective. We have argued that it is fruitful, at this stage, in acquisition research to take a step back to allow for a broader picture. Financial goals measured in shareholder value are undoubtedly important in acquisitions. This means we do not wish to detract from the value of measuring financial outcomes, but rather that the dominance of one measure can, if not discussed, risk becoming hegemonic to the degree that others are considered irrelevant or illegitimate. Moreover, we have argued that different stakeholders have not only different goals, but different sources of power upon which to base their claims. This places the various stakeholder groups unevenly in terms of their chances of influencing.

Using a stakeholder framework advances to consider new aspects of success and failure. First, considering stakeholders constitutes an important step forward from the dominating homogeneity ascribed to how acquisition outcomes are typically depicted (Meglio, 2015). This means that we

simply allow ourselves to recognize discrepancies between various interest groups in organizations. Second, as we have argued, to analytically separate various groups in this manner should not detract from clear empirical overlaps. For instance, top managers are sometimes encouraged to invest in their firm, thus making managers also shareholders. Of course, this is an option open also to non-manager employees.

Third, there are sometimes clearly symbiotic interests also between distinctly different, stakeholders (Pfeffer and Salancik 1978). For instance, both managers and employees can benefit from increased competitiveness since it can offer job security (after all, managers are also hired) or room for salary increases. With mentioning this we also would like to distance ourselves from a sometimes tiresome simplification in the critique of financial figures as relating solely to an anonymous market. But more fundamentally, this also should make us sensitive to how deeply financial institutions, mechanisms, and rhetoric permeate today's society. Thus, acknowledging both differences and overlaps between stakeholder goals stands in no contrast to seeing more fundamental powers at play.

## CONCLUSIONS

The issue of success and failure constitutes the soundboard to virtually all acquisition research, as a problematic practical dimension, as the likely effect of a variety of organizational phenomena, or a recurring rhetoric phenomenon. However, this one-dimensional view of acquisition outcomes has given a preferred position to certain, typically financial effects, at the expense of others. In contrast to the richness of research often motivated by poor acquisition performance, the concept of acquisition performance itself has remained fragmented and lopsided. In particular, we have been concerned with a tendency to "technify" discussions by focusing on the merits of measurements, however mainly within a very limited scope representing a narrow interest. Success or failure, the arguably more fundamental terms, have remained in the background, thus diverting from the fact that there is an apparent lack of attention to the fundamental goals.

This leads us to consider a number of empirical and conceptual avenues for future research that appear, also in light of the shortcomings of our own paper, to carry much potential. We would welcome further elaboration on the different goals associated with acquisitions. This paper has drawn on stakeholder theory to condense and summarize research within the acquisition field. However, empirical data is needed to both substantiate and elaborate this theme. More conceptually, this research prompts further theoretical advances. This multiplicity of perspectives of what constitutes goals, dimensions of success or failure in acquisitions, and the questioning a taken for granted view of certain perspectives or stakes are regularly subordinated, raises important questions. Potentially, any transaction could be considered from an almost inexhaustible number of perspectives. The contrast

between actual research and that largely untapped potential has helped us illuminating what views or coalitions that are regularly considered as valid and point to fruitful avenues for future research. On the one hand, leaving homogeneous assumptions raises important issues such as if it becomes possible to say that a merger was a success or a failure in general or on average? Put differently: how can different interests be weighed against each other to form a balanced and coherent view of the outcome of a transaction? On the other hand, to what extent does this risk leading to a fragmentation of accounts? Is there a risk, for instance, that the fates of some become relativized by referring to benefits of others? Can this lead to the dead end of a complete relativism, making justified critique weaker? Our answer is that it is no longer possible to state that a merger was a success or a failure in general, but for whom.

## REFERENCES

- Alvesson, M., and Sandberg, J. (2011) 'Ways of constructing research questions: gap spotting or problematization?' *Organization*, 18 (1): 23-44.
- Anderson, H., Havila, V., and Nilsson, F. (eds.) (2013). *Mergers and acquisitions. The critical role of stakeholders*. New York/Oxon: Routledge.
- Anderson, H., Havila, V. and Salmi, A. (2000) 'Can you buy a business relationship? - On the importance of customer and supplier relationships in acquisitions', *Industrial Marketing Management*, 30: 575-86.
- Barkema, H., and Schjiven, M. (2008) 'Toward unlocking the full potential of acquisitions: the role of organizational restructuring' *Academy of Management Journal*, 51, 696-722.
- Bauer, F., and Matzler, K. (2014) 'Antecedents of M&A success: The role of strategic complementarity, cultural fit, and degree and speed of integration' *Strategic management journal*, 35(2), 269-291.
- Bocconcelli, R., Snehota, I., and Tunisini, A. (2006) 'Network relationships and corporate acquisitions outcomes' *The IMP Journal*, 1(2), 3-18.
- Bruner, R. (2002), 'Does M&A pay? A survey of evidence for the decision- maker', *Journal of Applied Finance*, 12, 48-68.
- Capron, L. (1999) 'The long-term performance of horizontal acquisitions' *Strategic Management Journal*, 20, 987-1018.
- Cartwright, S. and Schoenberg, R. (2006) 'Thirty years of mergers and acquisitions research: recent advances and future opportunities' *British Journal of Management*, 17, S1-S5.
- Cooke, F. L. (2006) 'Acquisitions of Chinese State-Owned Enterprises by Multinational Corporations: Driving Force. Barriers and Implications for HRM' *British Journal of Management*, 17(S1), 105-121.
- Cording, M., Christman, P., and King D. (2008) 'Reducing causal ambiguity in acquisition integration: intermediate goals as mediators of integration decisions and acquisition performance' *Academy of Management Journal*, 51, 744-767.
- Côté, L., Langley, A., and Pasquero, J. (1999) 'Acquisition strategy and dominant logic in an engineering firm' *Journal of Management Studies*, 36, 919-952.
- Datta, D.K., Pinches G.P., & Narayan, V.K. (1992) 'Factors influencing wealth creation from mergers and acquisitions: a meta-analysis' *Strategic Management Journal*, 13, 67-84.
- Fee, C.E. and Thomas, S. (2004). 'Sources of gains in horizontal mergers: evidences from customer, supplier and rival firms' *Journal of Financial Economics*, 74: 423-460.
- Freeman, R. E. (1984). *Strategic management: A stakeholder approach*. Boston: Pitman.
- Friedman, M. (1970) 'The social responsibility of business is to increase its profits'. *New York Times Magazine*, September 13: 122-126.
- Graebner, M. E. (2004) 'Momentum and serendipity: How acquired leaders create value in the integration of technology firms'. *Strategic Management Journal*, 25(8-9), 751-777.
- Haleblian, J., Devers, C., McNamara, G., Carpenter, M. and Davison, R. (2009) 'Taking stock of what we know about mergers and acquisitions: A review and research agenda' *Journal of Management*: 35: 469-502.

- Harrison, J. S., Hitt, M. A., Hoskisson, R. E., and Ireland, R. D. (2001) 'Resource complementarity in business combinations: Extending the logic to organizational alliances' *Journal of Management*, 27(6), 679 -690.
- Holtström, J. (2013). Supplier relationship at stake in mergers and acquisitions, in Anderson, H., Havila, V. and Nilsson, F. (eds.) *Mergers and acquisitions. The critical role of stakeholders*, 168-184, New York/Oxon: Routledge.
- Kesner, I.F., Shapiro, D.L. and Sharma, A. (1994) 'Brokering mergers: an agency theory perspective on the role of representatives', *Academy of Management Journal*, 37: 703-721.
- King, D., Dalton, D.R., Daily, C.M., & Covin, J. (2004). Meta-analysis of post-acquisition performance: indications of unidentified moderators. *Strategic Management Journal*, 25, 187-200.
- Kitching, J. (1967). Why do mergers miscarry?. *Harvard Business Review*, 45(6): 84-101.
- Lubatkin, M., & Shrieves, R.E. (1986). Towards reconciliation of market performance measures to strategic management research. *Academy of Management Review*, 11, 497-512
- Meglio, O. (2015). The acquisition performance game: a stakeholder approach. In Risberg A., King D.R., Meglio O. (eds.), *The Routledge Companion to Mergers and Acquisitions*. Routledge, Taylor & Francis Group Ltd, Abingdon, Oxford, UK, pp. 163-176.
- Meglio, O. & Risberg. A. (2011).The (mis)measurement of M&A performance—a systematic narrative literature review. *Scandinavian Journal of Management*. 27(4).
- Meglio, O., & Risberg, A. (2010). Mergers and acquisitions-time for a methodological rejuvenation of the field? *Scandinavian Journal of Management*, 26, 87-95.
- Merriam-Webster Dictionary and Thesaurus (2016).merriam-webster.com
- Meyer, C. (2008). Value leakages in mergers and acquisitions: Why they occur and how they can be addressed. *Long Range Planning*, 41: 197-224.
- Meyer, C.B. (2006). Destructive dynamics of middle management intervention in postmerger processes. *Journal of Applied Behavioral Science*, 42: 397-419.
- Mueller, D.C.(1969). A theory of conglomerate mergers. *Quarterly Journal of Economics*, 83(4): 643-659.
- Öberg, C. (2013). Why do customers dissolve their business relationships with the acquired party following an acquisition?', in Anderson, H., Havila, V. and Nilsson, F. (eds.) *Mergers and acquisitions. The critical role of stakeholders*, 185-202, New York/Oxon: Routledge
- Öberg, C. Henneberg, S.C. and Mouzas, S. (2007) 'Changing network pictures: evidence from mergers and acquisitions' *Industrial Marketing Management*, 36(7): 926-940.
- Parmar, B.L., Freeman, R. E., Harrison, J. S., Wicks, A.C., Purnell, L., and De Colle, S. (2010). Stakeholder theory: The state of the art. *The Academy of Management Annals*, 4(1), 403–445
- Parvinen, P., & Tikkanen, H. (2007). Incentive asymmetries in the mergers and acquisitions process. *Journal of Management Studies*, 44(5), 759-787.
- Pfeffer, J. and Salancik, G.R. (1978) *The External Control of Organizations - A Resource Dependence Perspective*. New York: Harper & Row
- Schriber, S. (2012) 'Weakened Agents of Strategic Change: Negative Effects of M&A Processes on Integration Managers' *International Journal of Business and Management*, 7(12): 159-172.
- Seo, M., and Hill, S. (2005). 'Understanding the human side of merger and acquisition' *Journal of Applied Behavioral Science*, 41(4): 422-443.
- Shi, W., Sung, J., and Prescott, J. (2012) 'A temporal perspective of merger, acquisition and strategic alliance initiative: review and future directions' *Journal of Management*, 38(1): 164-209.
- Sirower, M. L. (1997) *The Synergy Trap - How Companies Lose the Acquisition Game*. New York: The Free Press.
- Subbady, R. (2010). 'Editor's comments: Construct clarity in theories of management and organization' *Academy of Management Review*, 35, 346-357.
- Teerikangas, S. (2010) 'Dynamics of acquired firm pre-acquisition employee reactions,' *Journal of Management*, 38: 599-639.
- Trautwein, F. (1990) 'Merger motives and merger prescriptions,' *Strategic Management Journal*, 11: 283-95.
- Vaara, E.(2002) ' On the discursive construction of success/failure in narratives of post- merger integration' *Organization Studies*, 23(2): 211-248.
- Zaheer, A., Castañer, X., and Souder, D. (2011). Synergy sources, target autonomy, and integration in acquisitions. *Journal of Management*, 39: 604-32.
- Zollo, M., & Meier, D. (2008). What is M&A performance? *Academy of Management Perspective*, 22, 55-77.

# OVERCOMING “IMPERFECTIONS” OF TECHNOLOGICAL CHANGE: THE BORDERLESS NATURE OF ENTREPRENEURSHIP IN OPEN INNOVATION MODEL.

Scuotto, Veronica<sup>1</sup>; Usai, Antonio<sup>2</sup>; Murray, Alan<sup>3</sup>; Fiano, Fabio<sup>4</sup>

<sup>1</sup>School of Business and Enterprise, University of the West of Scotland, UWS, UK

<sup>2</sup>Department of Economics and Business, University of Sassari, Italy

<sup>3</sup>School of Business and Enterprise, University of the West of Scotland, UWS, UK

<sup>4</sup>Department of Economics, University of Campania Luigi Vanvitelli, Capua, Italy

## ABSTRACT

Growth in the economy, changing consumer preferences, the climate for labour relations and technological progress are all exogenous events, part of an external environment to which an organisation reacts and which it does not fully control. These events all highlight the borderless nature of entrepreneurship. To ensure the success and progression of business, entrepreneurs require the ability to seize the opportunities identified and avert the threats presented by the external environment. Entrepreneurs aim to develop innovative approaches and ideas through establishing both formal and informal relationships and connections. These relationships take the form of collaborative partnerships both internal and external to the organisational network. This can be seen through partnerships with research centres, consultancy groups, other organisations and universities amongst others. However, unless effectively managed such collaborations and partnerships could be constrained through a variety of factors.

Imperfections such as risk management, asymmetric information, and hold-up problems, all stand to disrupt these collaborative partnerships and limit opportunities for innovation. In order to address these issues, this research seeks to demonstrate how an entrepreneur overcomes these imperfections by adopting the open innovation model. Therefore a holistic case study will be presented to offer a deep and real story of a business in the UK.

This research has been submitted to the 10<sup>th</sup> annual EuroMed academy of business (EMAB) conference focused on “global and national business theories and practice: bridging the past with the future”. This study presents a summary of the theoretical development which will be deeply developed in a further publication, a holistic case study of a Scottish small to medium enterprise, and final remarks.

*Keywords: technological change, open innovation model, risk management, entrepreneurship, innovation management*

## THEORETICAL DEVELOPMENT

Currently entrepreneurs and research partners face multiple market imperfections in their relationships. These include moral hazard, effort provision, entrepreneurial risk management (ERM),



asymmetric information, and hold-up problem (Zsidisin and Ellaram, 2003; Smith, 2003; Moore, 1983; Liebenberg and Hoyt, 2003; Waters, 2007).

Whilst each provision alleviates some of these problems, it also exacerbates others. Focusing on some of these “imperfections” such as hold-up problem, ERM, and asymmetric information, this research focuses on the impact of these issues on open innovation.

In the digital era these imperfections frequently occur due to the difficulties to manage dynamic development of new technologies just using internal resources. Hence companies need more knowledge and expertise which are acquired by establishing new relationships with external partners (Del Giudice et al, 2011; Smith and Fischbacher, 2009). The increase of new relationships reduces costs and risk linked to innovation.

In fact the components “borrow” resources from other business and in the same time a company “lends” resources and knowledge to research centres, consultancy groups, other organisations and universities amongst others. Furthermore a company also invests in research and development to enhance the absorptive capacity and knowledge so as to create a new product or service (Cohen and Levinthal, 1990).

The present mainstream brief of open innovation evokes the classical idea of the economic institution, i.e. firms are the nexus of contracts. According to Jensen and Meckling (1976) the negotiations between the interested parties may provide efficient economic solutions. A contract could motivate each party to exploit external talent and knowledge so as to improve the innovation process. In addition, the management of property rights and patents could encourage companies to build new external relationships and invest in new research ideas.

A company makes a decision to create and buy or create or buy in reference to a need to buy the legal rights to be able to use technologies patented by others as a way of improving its own contractual position ex post.

In fact it decides to exploit external resources (either tangible or intangible) in relation to the prices of the components supplied, the delivery programs, and transaction costs. In this way, a company should discover where get those resources efficiently, make a contract in order to guarantee the effective transfer of the resources, learn and absorb externally sourced resources, and manage the inter-business relationships.

Success or failure thus may depend on companies managing such imperfections and consequently the relationship with their own sellers.

This research, proposes that entrepreneurs and external partners carry out innovative initiatives using the open innovation model and that they collaborate in a scenario characterized by high risk equilibrium and partially private information, where each agent's investment choice is public

information. Consequently there is an opportunity to improve the innovation performance of their company. On the one hand the competition reduces these imperfections increasing the options available to both entrepreneurs and research partners in new projects. On the other hand the open innovation model enables to the companies to develop something new through the establishment of formal and informal relationships. Indeed the open innovation may resolve some imperfections such as the uncertainty associated with costs regarding delimitation of the boundaries of ownership.

On this basis we propose the following assumptions:

1. Where entrepreneurial risk management is the lead factor in the relationship between entrepreneurs and external research partners, innovation performance will be increased through technological monitoring.
2. Where asymmetric information is the lead factor in the relationship between entrepreneurs and external research partners, innovation performance will be increased through the control of rights (copyrights and patents).
3. Where the hold-up problem is the lead factor in the relationship between entrepreneurs and external research partners, innovation performance will be increased through open innovation.

The study will address these assumptions using a holistic case study in order to investigate deeply how an entrepreneur tends to overcome these imperfections by adopting an open innovation model.

On this basis, the research aims to shed light on the relationship between entrepreneurs and external research partners. The “imperfections” comprise improvements in technology that render current technology and development efforts obsolete (Robertson and Gatignon, 1998). The inability of an entrepreneur to stay abreast of technological changes, has a negative effect on costs, competitiveness of products in the market and lead-times. Although the creation of new technologies have enforced the entrepreneurial attitude of exploiting external opportunities to generate new business ideas (Schumpeter, 1934).

The research aims to answer relevant questions concerning boundaries of the company (Coase, 1937; Williamson, 1985; Grossman and Hart, 1986; Hart and Moore, 1990). In addition the analysis imperfections stemming from open innovation has been fruitfully applied to many relevant economic topics which are no longer restricted to the theory of the firm. This research complements existing studies on open innovation theory in two ways. Firstly, we will focus on specific topics which received particular attention by researchers in recent years and emphasize open questions that should be addressed in future research. Secondly, we will offer a narrative entrepreneurial journey of a business in the UK which will extend existing studies on entrepreneurship offering a different view on the borderless nature of an entrepreneur.

## METHODOLOGY. THE CASE STUDY: KESTROS LTD

In order to offer a deep analysis of entrepreneurship applied to the process of the open innovation model to overcome the ‘imperfections’ of the technological change, we present an holistic explorative case study (Johnson, 2008; Yin, 2013). This case study supports new quantitative research and offers a better understanding of a complex phenomenon (Punch, 1998). In this specific case, a particular entrepreneurial journey is presented so as to show how an entrepreneur tries to face the aforementioned ‘imperfections’ by adopting an open innovation approach.

The present study analysed a British company for two reasons. First of all, enterprise culture is strongly embraced in this country (Hall and Hubbard, 1998). Secondly a sustainable endogenous economic development is promoted so as to offer a business – friendly market (Eisenschitz and Gough, 1993).

The company Kestros LTD was founded in 2009 by Manjit Mooker in the United Kingdom and was sold in 2014. The company that bought it over retained the entrepreneur for two years to run the project then he left to start a new business.

Table 1. Kestros LTD – general information.

Name of the Company: Kestros Ltd	Year of foundation: 2009
Founder: Manjit Mooker	Industry: Information Technology Consultancy Activities
Location: Scotland, UK	Business Structure: Private Ltd Company
Size (n. employees 2016): about 5	Revenue/Sales: (2015/16) 200k
Products/service: Consultancy services and software sales.	
Customers: Systems integrator and automation companies in the North of Italy	
Main motivation for starting a company a research group of a university of the North-East of Italy founded the spinoff company to sell the output of the research, to the final intent to increase the research funding	
Name and role of the interviewees Managing Director and Project Manager	

The founder identifies himself as ‘a disruptive early innovator’ because his stated vision was to “change the face of healthcare”. In 2013 with the clear growth of mobile usage I recognised an opportunity in the area of outpatient management application with the capability to empower patients with a digital solution in the form of an app which would allow them to access to their own information and manage their own appointments and other aspects of their care in a single digital location. After carrying out time and motion studies around patient throughput within various sectors of the NHS I was able to both confirm that a gap existed and also convince the Health Board that this opportunity was worth exploring further. The product itself was called “Mi Checkin”; an outpatient management app which the patient can download free from the App Store which allows the patient themselves to make, confirm or reschedule appointments, provides prompts for patients about their appointments and uses GPS to guide patient through the physical environment of the

hospital in addition to other features. Whilst, as can be seen, there are clear benefits of this innovation for the care provider the product was designed with the patient in mind and improved patient experience was the key driver throughout the innovation process. Key benefits of the product include;

- It delivers significant time savings for the hospital using the app at all stages of the process.
- It reduces the amount of missed and cancelled appointments thus saving considerable financial expense for the NHS.
- It improves customer experience and satisfaction rates by allowing them to manage key aspects of the process themselves and integrating and coordinating information they receive in terms of their care package such as; appointment times, travel directions, car parking, patient check in, updates of delays etc. through their mobile phone or tablet.
- The app delivers the equivalent of 3 to 4 Full Time Equivalent reception staff which equates to around £100k savings per year for the hospital.

#### *Open innovation Approach*

Having discovered the gap in the market and identified market opportunities, the entrepreneur decided to change traditional attitudes, cultural norms and ways of doing things within healthcare in order to develop a customer centred product which has the potential to completely disrupt the market in this sector. The entrepreneur confirmed that he adopted an open innovation model stating:

*I did adopt an open innovation approach. I took processes within the health care sector and combined these with the patients' own mobile technology on a consent-based basis and integrated other features such as mapping and GPS technology which already existed and combined them in an innovative way to create a completely new product. Features of mobile device technology which offered potential benefits for the patient were exploited at every stage of the process and without the adoption of an open innovation approach the product could not have been developed and delivered to market.*

This innovation was generated through the collaborations with the external environment. As he puts it;

*In order to develop the product and bring the product to market the I had to collaborate with a diverse range of stakeholders which were external to my own business such as; Scottish and English Health Boards, GPs, The Care Quality Commission, Primary Care Trusts and Patient representative bodies however there was no collaboration with research centres or universities as I was able to provide the resources I needed myself without needing to think about bringing in those types of organisations. Each stakeholder involved in the project had their own agendas and priorities which created a huge range of barriers to the innovation process, the extent of which, I feel I grossly underestimated. Whilst initially I believed that I did not need to develop networks and relationships I soon came to realise as a result of going through the innovation process that I should have spent a*

*lot more time developing relationships in order to overcome these barriers and build rapport and trust especially in the early stages of the process. This would in my opinion have allowed the product to be delivered to market much sooner.*

Whilst the entrepreneur was willing to develop external collaboration, he was at times demotivated by significant bureaucratic barriers which needed to be overcome such as;

- Public procurement procedures;
- Data Processing Agreements;
- Internal instruments of governance;
- Contract terms and agreements;
- Policies governing integration of systems with external partners;
- Governance around information. Culture of protectionism around patient data – The hospital viewed themselves as the “guardian and protector of the patients’ information”;
- Ambiguity around ownership of data. The patients’ information is their property but if a GP writes a report then there is a question around whether the GP owns that data.

Some of these barriers can be categorised as ‘imperfections’.

*Entrepreneurial risk management (ERM).*

Regarding the ERM, Manjit claimed that:

*There were some issues around getting access to the Hospital and wider NHS systems in order to integrate the product systems both from a bureaucratic point of view and because they had never done things before in the way I wanted and needed them done. In some instances what I wanted to do could not be achieved as the obstacles were too high and other innovative solutions needed to be developed for example I was not permitted to directly access the Hospital Intranet so a parallel system was developed which worked around this problem. Inversely there were also some issues around sharing of information where the I felt the need to protect myself for example I was asked to provide commercially valuable information relating to how my technology was set up and operated which did not impact on the project and which in the end I declined to provide. In terms of risk the risk management process was both ad hoc and evolving and at times I adopted a “a seat of the pants approach” and had to think on my feet to come up with solutions to problems as they presented themselves. However as I gained more experience of the stakeholders and their needs and expectations I was able to better manage these risks which included;*

- *Digital data breach, loss or theft for all parties.*
- *Management of costs in order to stay within budget constraints for all parties.*
- *Building, developing and maintaining trust in the product for the Owner.*
- *Reputational risk for stakeholders resulting from failure to deliver on promise.*
- *Negative publicity for stakeholders resulting from failure of the product.*

- *Management of expectations of end user.*

*The potential outcomes of these risks for my Company could have been; loss of reputation, loss of contract, increased costs because of unforeseen delays and loss of future commercial opportunities.*

#### *Asymmetric information*

Other problems were also experienced around information exchange which could be attributed not to a lack of trust but rather to miscommunication, misunderstanding or misinterpretation of instructions and expectations. In these cases the information was provided in good faith but could not be trusted.

Manjit stated that;

*There were no issues whatsoever around IP. I retained 100% of the intellectual property and I made it very clear at the beginning that I was not able to design a product specifically for the Hospital or Trust and that this product was designed for the patient themselves who were free to move between different Trusts and therefore the product should move with them.*

#### *Hold up problem*

A contract was stipulated to avoid any contractual hazard, e.g. hold up problem. It set out the terms of the project and the key partner (a hospital) was used to dealing with external partners on a daily basis.

On this regards, the entrepreneur declared that:

*Whilst I encountered challenges over an extended period of time which were significant at no time did I feel that I could not overcome them nor did I consider giving up. I will admit to being demotivated around the challenges especially at the beginning of the process where the greatest barriers to innovation were encountered but also in the final stages as I moved towards exit from the project. I feel that, looking back, of my total time spent on the project I spent 10% developing the actual product and 90% managing the innovation process in order to overcome barriers to market.*

## **DISCUSSION AND CONCLUSION**

The imperfections such as entrepreneurial risk management (ERM), asymmetric information, and hold-up problem are all capable of interrupting collaborative partnerships and limiting innovation opportunities (Zsidisin and Ellaram, 2003; Smith, 2003; Moore, 1983; Liebenberg and Hoyt, 2003; Waters, 2007).

This research shows how an entrepreneur faces these imperfections by adopting an open innovation model.

All the imperfections were noted in this case however the entrepreneurial skills attributes attitude and aptitude of the owner allowed him to overcome them or limit their impact on the innovation process.

The imperfections do not limit innovative capacity and alienation comes only from a viable sale opportunity; paradoxically, the imperfections have not been limitative but have played the leading role for open innovation.

In the aforementioned story, the deliberate strategy of open innovation is clearly evident: this implies the absorption of knowledge from a dense network of external relations, only possible thanks to technological monitoring.

According to Schumpeter's theory (1934), the entrepreneur is the innovator; as technological perception increases, risk is minimized, confirming the essence of ERM.

Managerial literature has sanctioned that new relationships bring with it the risk of opportunistic behaviors; the protection of intellectual property is the appropriate deterrent to minimize the risk in terms of emerging strategy, however, the entrepreneur dominates all intellectual property right from the start and has to dedicate the prevalence of his time in the development of innovation. A behaviour of fact arising from the perceived risks (loss of reputation, loss of contract, increased costs because of unforeseen delays and loss of future commercial opportunities).

The current industrial conformation has made open innovation the only lever capable of generating innovation, in the absence of a phase of substantial initial investment.

The case study would seem to confirm the three assumptions; the empirical significance of a single case does not allow theorization. The research offers an interesting result to be deepened in terms of empirical – quantitative approach; a viable alternative could be the development of a parallel case for conducting a comparative survey.

On the conceptual front, risk and innovation could be linked by a cause-effect relationship, re-opening in terms of strategies the diversification of ideas, thus interpreting innovative behaviour as an *escamotage* that minimizes entrepreneurial risks.

A further theoretical implication plays on the role of trust within the hypothesized conceptual framework. Risks management and perception, as well as informational asymmetries, are less manageable when the level of confidence between counterparties decreases.

It might be hypothesized to affect all the "relational theory", so extending the range of assumptions.

## REFERENCE

- Alchian, A., & Demsetz, H. (1972). Production, information costs, and economic organization. *American Economic Review*, 62, 777-795.
- Audretsch, D. B., Lehmann, E. E., & Plummer, L. A. (2009). Agency and governance in strategic entrepreneurship. *Entrepreneurship Theory and Practice*, 33(1), 149-166.
- Bachtler, John and Clement, Keith (1991) 'Inward investment in the UK and the single European market', *Regional Studies*, 24, 173-184.
- Cyert, R., & March, A. (1963). *A behavioural theory of the firm*. Prentice-Hall, Englewood Cliffs, NJ.

- Dekker, H. C., Sakaguchi, J., & Kawai, T. (2013). "Beyond the contract: Managing risk in supply chain relations". *Management Accounting Research*, 24(2), 122-139.
- Demski, J.S. and Feltham G.A., (1978). Economic incentives in budgetary control systems. *The Accounting Review*, 53, 336-359.
- Eisenhardt, K. (1990). Agency theory: an assessment and review. *Academy of Management Review*, 14(1), 57-74.
- Frame, J.D. 2003, *Managing risk in organizations: a guide for managers*, Jossey-Bass Inc Pub.
- Harwood, I., Ward, S. & Chapman, C. 2009, "A grounded exploration of organisational risk propensity", *Journal of Risk Research*, vol. 12, no. 5, pp. 563-579.
- Hisrich, R. D., & Ramadani, V. (2017). *Entrepreneurial Risk Management*. In *Effective Entrepreneurial Management* (pp. 55-73). Springer International Publishing.
- Johnson, K. L., Danis, W. M., & Dollinger, M. J. (2008). Are you an innovator or adaptor? The impact of cognitive propensity on venture expectations and outcomes. *New England Journal of Entrepreneurship*, 11(2), 5.
- Moore, P.G. 1983, *The business of risk*, Cambridge University Press, Cambridge.
- Sarasvathy, D. K., Simon, H. A., & Lave, L. (1998). Perceiving and managing business risks: Differences between entrepreneurs and bankers. *Journal of economic behavior & organization*, 33(2), 207-225.
- Smith, D. & Fischbacher, M. 2009, "The changing nature of risk and risk management: The challenge of borders, uncertainty and resilience", *Risk Management*, vol. 11, no. 1, pp. 1-12.
- Smith, N.J. 2003, *Appraisal, risk and uncertainty*, Thomas Telford Services Ltd, London.
- Werner, J. 2009, "Risk and risk aversion when states of nature matter", *Economic Theory*, vol. 41, no. 2, pp. 231-246.



# CONSUMER PERCEPTIONS AND USES OF SOCIAL MEDIA AROUND VARSITY CUP RUGBY: A TRADITIONAL SOUTH AFRICAN UNIVERSITY

Serra, Pamela

Tshwane University of Technology, Marketing, Logistics and Sport Management Department, Pretoria, South Africa

## ABSTRACT

*Globalization and technological advancements have diffused the physical confinements placed on the operations of any business. Social media platforms are new marketing channels that are global communication tools, each serving a different purpose and target market. The exponential growth of social media and technological advancements pose major difficulties, as well as the impact of the effectiveness of the current wave of technology is already established, the next surge of advancement is already upon us. Emphasis must be placed on continuously learning about trends and subsequently adapting to them. Marketing communications are a core aspect of any institutions marketing as it is used to not only create awareness but also to gain support. FGX Engage (2013) reports suggest that social media has created more awareness around the tertiary institutions sporting brands; yet, further research is needed and can be conducted to further investigate the South African tertiary institutions' consumer perceptions of social media communications. The purpose of this study was to identify consumer trends of a traditional university and preferences with regards to social media communication platforms around the Varsity Rugby Cup. Findings clearly deciphered the most frequently used source of technology, the preferable social media communication platforms, the daily usage, as well as what time of day these platforms were most actively utilized. Attitudes and preferences concerning the introduction of online ticket purchases and a Varsity Cup application were further explored. The findings can be used to align and implement improvement strategies around the marketing of tertiary institution sport.*

*Keywords: Social media, social media trends, Varsity Cup Rugby, South Africa*

## INTRODUCTION

Social media has become an area of interest to not only marketers, but researchers, students, celebrities and many other economic, educational and socio-political institutions. This has to do with the belief that the power of globalisation has led many people to be online in order to cope and survive with the demand of the information era (Musa, Azmi & Ismail, 2015). Today, not only are young people

surrounded by media in their homes and schools, but the portability made possible by the increased miniaturization of digital media means that they can remain connected almost anywhere they wish to go. Social media is viewed as any digital media that can be used to share messages, photos, news, information, music and videos with cyber communities (Papoola, 2014). For this reason, social media heavily relies on mobile applications and websites created for social interactions which allow users to generate, express and share information about themselves and others. One of the main differences between social media and traditional media, such as newspapers, magazines, radio and television, is defined in economic terms and it's clearly in the advantage of the online medium (Ionescu, 2013). It has been estimated that the economic impact of social media on an organization could exceed a trillion in the near future, most of which is gained from more efficient communication with their customers (Chui, Manyika, Bughin, Dobbs, Roxburgh, Sarrazin, Sands & Westergren, 2012).

With the introduction of Varsity Sport competitions at Higher Education Institutions (HEIs), a common challenge among university campus marketers specifically, is obtaining, maintaining, and increasing student attention and participation (Bayne & Cianfrone, 2013). Thus, campus sport marketing plans often aim to inform students through promotions online via social media platforms, in an effort to keep students aware of and engaged in the offered programmes and events (Bayne & Cianfrone, 2013). With this in mind, the popularity of social media sites, such as Facebook and Twitter, has impacted the sport and recreation field (Bayne & Cianfrone, 2013). Whichever social media site is used, it can be easily accessed by computer, laptop, tablet and smartphone so that communication can be instant and always on hand – at the click of a button thoughts can be shared with thousands of others (Ault, 2004; Wylie, 2014).

As social media grows and gains an increasingly larger following on a daily basis, the understanding and utilising of this markets growth potential poses immense high value to the business. Since its inception in 2004, Facebook has evolved as the global market leader of social media communication platforms. In recent earning reports, Facebook has announced 1.23 billion active users worldwide with annual revenue of R888.26 billion for 2013 (Herrold, 2014). Twitter, however, is used more for information or news-related aspects which boasts 288 million active users per month for 2013 (Gibbs, O'Reilly & Brunette, 2014). With the largest growth rate of active users for 2013 of 23%, Instagram could potentially become the new front runner for marketers to utilize (Knibbs, 2014).

As internet penetration keeps widening (with over 13.17 billion users of the internet today) and social media platforms continue proliferating, Whiting and Williams (2013) claimed that there is limited knowledge of why and how people use social media which is the basic foundation of the Uses and Gratifications Theory (UGT) (Katz, Blumler & Gurevitch, 1974). Students are described as the major users of social media and therefore the Uses and Gratification Theory is an ideal theory to identify and

analyse the reasons and perceptions of why they use social media (Whiting & Williams, 2013; Yoo & Kim, 2013). Some scholars such as Gallion (2010) predicted that the emergence of widespread usage of the internet would come with new changes in roles, personal and social habits of media users.

Li (2005) stated that people use social media to satisfy their needs which include cognitive needs, affective needs, personal and integrative needs, social needs, tension release needs and medium appeal needs. For this social media has become a prolific research field demonstrating the direct relevance of the UGT and its participants (Matei, 2010). In this review of the related studies, the researcher synthesized and examined works of Asemah (2011), Gallion (2010) and Whiting and Williams (2013). According to these scholars, the majority of people use social media for interaction, killing time, entertainment, seeking and sharing information, socialization, education and surveillance and communication.

*Social interaction or integration* (Asemah, 2011) is one of the predominant factors for people making use of social media. One of the key functions of mass media is to be a forum for public discussions. Social networks such as Facebook and Online Forums allows users to participate and interact on various issues. People use social media to interact with family, friends, spouses and loved ones (Papoola, 2014, Whiting & Williams, 2013).

*Killing time* is another reason for people to use social media so as to be able to release any stress or tension or similarly as a form of diversion. Studies (Asemah, 2011; Musi, Azmi & Ismail, 2015; Whiting & Williams, 2013) reported that respondents used Facebook when they felt bored. *Entertainment* is unquestionably amongst the most cited functions of mass media as people often prefer to be in a good mood and kept entertained. Gallion (2010) found that their respondents solely utilised media for leisure purposes. Whiting and Williams (2013) elaborated that entertainment was achieved through listening to jokes, reading humorous comments and watching the silliest videos.

Social media allows for people to *search and find information* effortlessly. Whiting and Williams (2013) posited that people used social media to find information about deals, sales, products and on how to do things yourself. *Socialisation* according to Gallion (2010) is one of the most central functions with the desire to make new friends, sustain relationships and socialise with people are among the socialisation needs. Musi, Azmi and Ismail (2015) highlighted that their responds used Facebook to make new and rediscover old friends.

*Education* can be regarded as one of the prime purposes of social media where people turn to social media for learning and self-education. In Papoola's (2014) study, it was posited that respondents utilised social media for academic purposes with search engines such as Google and Wikipedia at the disposal of the online user.

Asemah (2011) stated that individuals used certain social media platforms to check on and examine what happenings within and outside their domain are taking place otherwise known as *surveillance*. Similarly, Papoola (2014) and Whiting and Williams (2013) reported that social media allowed respondents a wider variety to report and upload images, videos, photos and voicenotes.

*Communication* is the last function that social media delivers on. It allows people the opportunity to express their feelings and opinions and communicate freely through the use of forums, various groups, pages, blogs etc. Whiting and Williams (2013) found that 56% of their respondents utilised social media such as Whatsapp, Twitter and Facebook to discuss, gossip and talk with their friends and receive real time feedback. This diversification of the use of media is what promotes the UGT.

As there are limited studies to revalidate the UGT in relations with social media, specifically around sport, this paper intends to apply the UGT to help explain the following:

1. To investigate whether sport consumers use social media;
2. To examine the social networks preference among these sport consumers; and
3. To demonstrate the relevance of the UGT in the sport consumers' use of social media.

With having said this, it is of vital importance that the efforts put forward by the institution are accurately meeting the social media trends, needs and perceptions of the greater university sport community to ensure further growth and higher return on investments for the university's sport brand.

## **MATERIALS AND METHODS**

### *Design*

This study was exploratory in nature and made use of a survey research design which is a very valuable tool for assessing opinions and trends (Thomas, Nelson & Silverman, 2015). The underlying principle for the use of this research design was that the survey questionnaire allowed the researcher to elicit the respondents' opinions and perceptions on their usage of social media and the gratifications they derive (Thomas, Nelson & Silverman. 2015).

### *Sample*

A purposive sampling approach was used in this study based on the accessibility and voluntary participation of the sampling pool (Patton, 2002). Purposive sampling allowed accessibility to important and in-depth first-hand information regarding the respondents' opinions and perceptions on their usage of social media (Patton, 2002). The participating sample pool (n=209) consisted of university students (n=105), athletes (n=100) and staff members (n=4) from two of the university's

campuses. The spread of the sampling pool included both males and females of all ages and ethnicities.

#### *Instrument and procedures*

Lewis, Messina & Wellington's (2014) social media questionnaire was adopted, adapted and piloted before direct distribution to the sample of respondents. The questionnaire consisted of six sections whereby participants were requested to answer questions based on the following: a) biographical information b) Practice of social media c) Types of social media platforms used d) General social media accessibility (how and when they access) e) Reasons for utilizing social media and f) Gratifications derived from utilizing social media.

#### *Validity and reliability*

With regards to the reliability of the instrument, prior the initialization of the research, the questionnaire measured a Cronbach alpha coefficient of 0.67, outlining an acceptable reliability score for the instrument and 0.69 post adaptation. The test-retest method was further conducted prior to the fieldwork so as to ensure content validity of the questionnaire.

#### *Data analysis*

The questionnaires were analysed utilising the Statistical Package for the Social Sciences (SPSS – Version 24). The results are illustrated through simple descriptive statistics such as frequencies and percentages.

## **RESULTS**

#### *Section A: Biographical information*

Survey questionnaires were distributed to 209 respondents with 42% were males (n=88) and 58% females (n=121). The overall racial demographics of the sample group consisted of 55% African (n=114), 3% Asian (n=7), 7% Coloured (n=15), 5% Indian (n=11) and lastly, 30% Caucasian (n=62). When focusing on the current level of study, 89% constituted of undergraduate students (n=186), 6% of postgraduate students (n=12) and 5% of staff members (n=12).

#### *Section B: Practice of social media*

When it came to the practice or usage of social media, the study revealed that the majority of respondents (n=200, 95.7%) made use of social media compared to 3.8% of respondents that did not (n=8).

#### *Section C: Types of social media platforms*

Social networks have become an integral part of sport consumers’ life. When it came to their most preferable social network, 26% preferred Facebook, 24% preferred Whatsapp and 16% preferred YouTube with Twitter (12%) and Instagram (11%) completing the Top 5 preferred social networks to use due to the functions of sharing information and being able to upload and share video and photos.

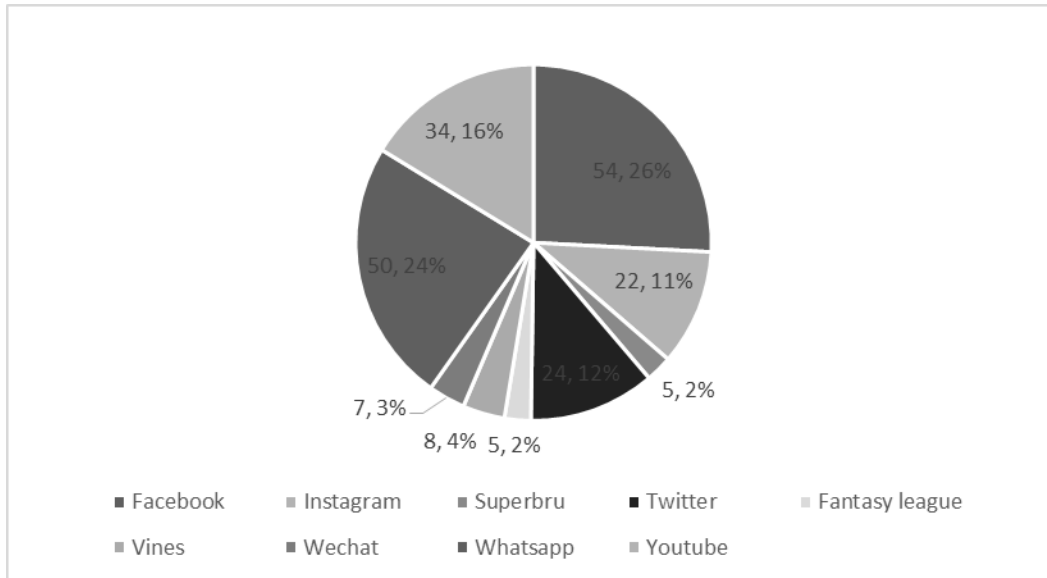

Figure 1: Preferred social networks used

Section D: General social media accessibility

Findings clearly illustrated that the source most used for accessibility to social media sites among the respondents were laptops (n=63, 30.4%) and smartphones (n=65, 31%) due to their convenience. On the contrary, desktops (n=30, 14.3%), tablets (n=35, 17%) and University computer labs (n=15, 7.3%) were the least often utilised.

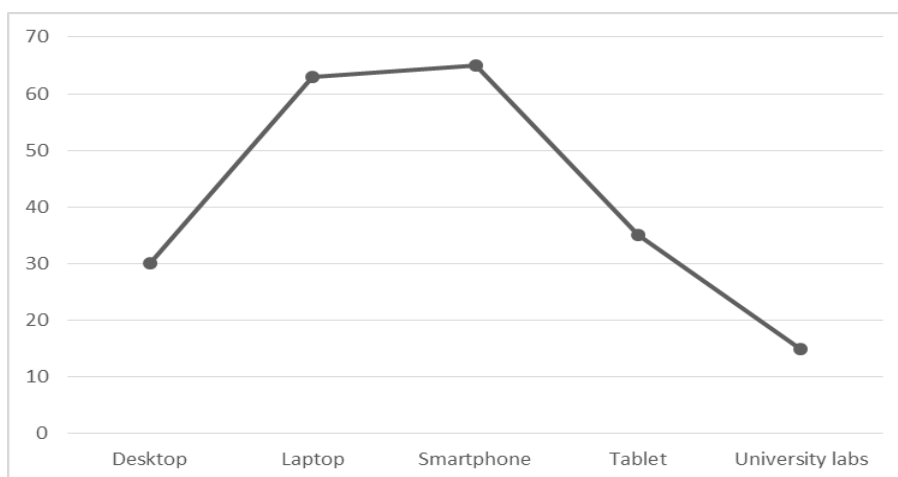

Figure 2: Source used to access social media

The findings in Table 1 suggest that there is a distinct time frame in which the most activity occurs with regards to social media platforms and the respondents’ subsequent usage. Between 20.00-22.00,

as the highest usage period for the identified respondents (17%) followed by 17.00-20.00 (14.4%) and then 08.00-10.00 (14.2%).

**Table 1: Time frame in which social media activity occurs**

Time	Frequency	Percentage
08.00-10.00	30	14.2
10.00-12.00	29	14.1
12.00-15.00	28	13.8
15.00-17.00	27	13.7
17.00-20.00	33	14.4
20.00-22.00	36	17
22.00-24.00	26	12.8

#### Section E: Reasons for utilising social media

Figure 3 outlines respondents' eight main uses or reasons for utilising social media. 100% of respondents outlined *communication* as the top use for social media usage (n=209), followed by 95.6% of respondent signalling *entertainment* (n=200) such as movies and videos as the second highest reason for social media practise. *Socialising* (n=180, 86%) via Facebook and *staying connected* and being able to *freely express* one's opinion on forums and/or blogs measured equally by 83.7% respondents (n=175). *Staying informed* (n=170, 81.3%) and *sharing news* (n=160, 76.5%) were rated lower on the scale with only 38.2% of respondents outlining *making friends* as the least apparent reason for making use of social media (n=80).

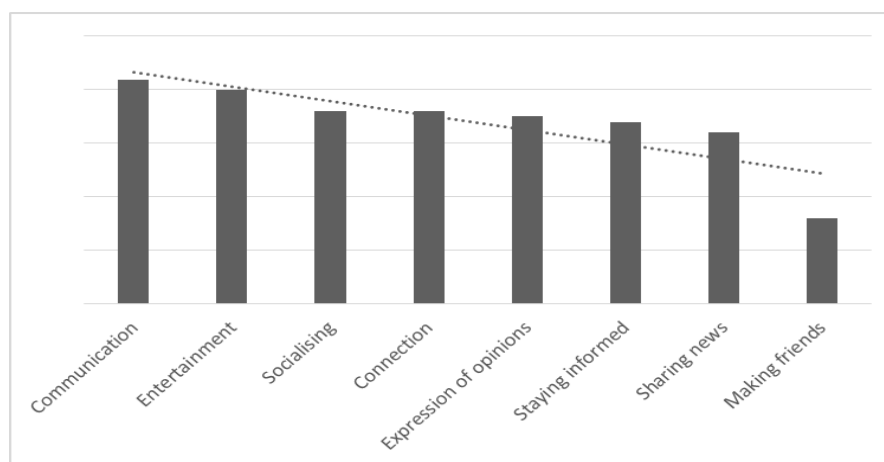
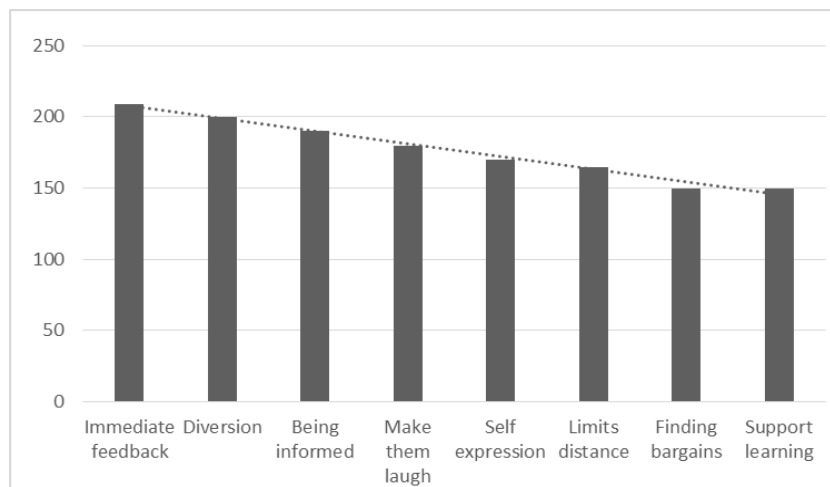

**Figure 3: Reasons for utilising social media**

#### Section F: Gratifications/benefits derived from utilising social media

In Figure 4, the gratifications respondents derived from the utilization of social media are outlined. The most predominant gratification derived from social media was outlined as being that of

immediate feedback (n=209, 100%). 95.6% of respondents cited diversion through the means of releasing tension or as a means of escapism as the second most predominant gratification derived from social media (n=200) Being informed (n=190, 90.9%) and being entertained through (n=180, 86%) was further outlined as forms of gratifications experienced during social media consumption. Being able to express oneself was measured at (n=170, 81.3%) as a means of gratification with 165 respondents (78.9%) highlighting the function of bringing people together and limiting distance through social media as another form of gratification. Similarly important but not as popular means of gratification derived from the usage of social media was that of finding bargains (n=150, 71.7%) and support learning (n=150, 71.7%).



*Figure 4: Gratifications derived from social media*

## DISCUSSION

The objective of this study was to identify the sport consumer uses of social media and gratifications derived from the usage thereof with the idea of aligning or implementing improvement strategies around the marketing of university sport based on the findings.

Results illustrated that the majority of the respondents made use of social media (95.7%) which was a trend found to be prevalent in studies done by Musi, Azmi and Ismail (2015) that posited that the power of globalisation has led more people to be online in order to cope and survive with the demand of the information era.

With regards to preferences of social media platforms, this study's findings illustrated that Facebook was the most daily utilized social media platform (26%) amongst the university's sport consumers reaffirming its global dominance on social media platforms as expressed by Herrold (2014). Similarly, this finding echoed studies of Whiting and Williams (2013) and Papoola (2014) which highlighted Facebook as the leader of social media platforms. Likewise, Twitter and Instagram were listed as alternative top two social media platforms postulated in Gibbs, O'Reilly and Brunette (2014) where



both Twitter and Instagram were underscored as social media platforms with the largest growth rate of active users.

Results illustrated a fine margin (0.6%) between the source of a laptop and smartphones being used to access the internet amongst participants, which was a trend found to be prevalent in other studies such as Wylie (2014) where research delineated that due to the rapid evolvement and the ease of accessibility of mobile technology, traditional methods of marketing were becoming less efficient with smartphones providing a channel for followers to continually access platforms and stay connected with their brands. Contrasting Ault's (2004) conclusion on desktops and tablets being as dominant as laptops and smartphones as sources of technology in accessing social media platform, this study measured desktops and tablets low, respectively 14.3% and 17% as sources of technology.

The time frame 20.00-22.00 prevailed as the time slot in which most social media activity occurs suggesting the gratification of diversion/entertainment as Gallion (2010) and Whiting and Williams (2013) posited that respondents used media mainly for leisure purposes with this time slot reclining within post working hours. Similarly, the less active time slots (22.00-24.00) outline the resting hours of the respondent.

This paper identified eight reasons and gratifications why students used social media which are communication, entertainment, socialising, staying connected, self-expression, staying informed, sharing news and making new friends. These showed that social media allows users to satisfy and gratify many of their needs which could not be possible in the conventional media as supported by Gallion (2010), Papoola (2014) and Whiting and Williams (2013).

## **STUDY LIMITATIONS AND IMPLICATIONS FOR FURTHER RESEARCH**

A distinct limitation of the study was the fact that the sample size was generated from only one university within the Varsity Cup Rugby competition. The results of the study can therefore not be generalised to the sport consumer populations of South African universities. Further research could include more universities within the competition of Varsity Cup Rugby to gain further insight of the tertiary institutions' sport consumer trends on social media. Finally, due to the ever-changing nature of social media communication platforms, future studies should account for the technological advancements, forms and updates.

## **CONCLUSION**

This study explores the UGT in the usage of social media among sport consumers pertaining to the Varsity Cup Rugby. The use of social networks among the sport consumers at university is becoming omnipresent indicating that these social networks have become an immense part in the life of the

sport consumers. More studies regarding the impact, be it positive or negative, of social media on sport consumers across all sporting competition platforms should be conducted. The study further outlined that the Uses and Gratification Theory is a valid and relevant communication theory when it comes to social media studies and therefore is a contribution to both literature and to the theoretical framework of mass communication. By understanding the uses and gratifications derived from different social media platforms, universities' marketing departments can build a two way dialogue with their sport consumers and in turn build and improve on their marketing strategies and in turn sporting brand.

## REFERENCES

- Asemah, E.S., (2011), *Selected mass media themes*, University Press: Jos.
- Ault, S., (2004), "Online Ticketing Wins More Fans", *Billboard*, Volume. 116, pp. 17-20.
- Bayne, S.K., & Cianfrone, A.B., (2013), "The Effectiveness of Social Media Marketing: The Impact of Facebook Status Updates on a Campus Recreation Event", *Recreational Sports Journal*, Vol. 37, pp. 147-159.
- Bizcommunity, (2017), UJ brand earns international recognition, <http://www.bizcommunity.com/Article/196/499/96521.html>, Retrieved 30 June 2017.
- Chui, M., Manyika, J., Bughin, J., Dobbs, R., Roxburgh, C., Sarrazin, H., Sands, G., & Westergren, M., (2012), *The Social Economy: Unlocking Value and Productivity through Social Technologies*. McKinsey & Company, New York, NY.
- Gallion, A.J., (2010), *Applying the uses and gratification theory to social networking sites: A review of related literature*, [http://www.academia.edu/1077670/Applying\\_the\\_uses\\_and\\_gratification\\_theory\\_to\\_social\\_networking\\_sites\\_a\\_review\\_of\\_related\\_literature](http://www.academia.edu/1077670/Applying_the_uses_and_gratification_theory_to_social_networking_sites_a_review_of_related_literature), Retrieved on 20 June 2017.
- Gibbs, C., O'Reilly, N. & Brunette, M., (2014), "Professional Team Sport and Twitter: Gratifications Sought and Obtained by Followers". *International Journal of Sport Communication*, Vol. 7, pp. 188 -213.
- Ionescu, N., (2013), "Online Political Communication: The Role of Image Upload on Facebook", *Journal of Communication*, Vol. 8, No. 1, pp. 53-58.
- Herrold, T., (2014), *Mobile Facebook advertising: Warc Best Practice*: New York, NY.
- Katz, E., Blumler, J.G. & Gurevitch, M., 1973, "Uses and gratifications research". *The public opinion quarterly*, Vol. 37, No.4, pp.509-523.
- Knibbs, K., (2014), *Instagram is growing faster than Twitter, Facebook, and Pinterest combined*. Digital Trends, New York, NY.
- Lewis, S. A., Messina, M. J. & Wellington, J. F., (2014), "Social Media Questionnaire of Marketing Students", *Erie, Marketing Management Journal*, Vol 28., No.2, pp. 149-165.
- Li, D., (2015), *Why do you blog: A uses and gratifications inquiry into bloggers' motivations*, <http://citeseerx.ist.psu.edu/viewdoc/download?doi=10.1.1.91.6790&rep1&type=pdf>.
- Matei, S.A., (2010), *What can U & G theory tell us about social media?*, [http://matei.org.think/2010/07/29/what\\_can\\_uses\\_and\\_gratification\\_theory\\_tell\\_us\\_about\\_social\\_media/](http://matei.org.think/2010/07/29/what_can_uses_and_gratification_theory_tell_us_about_social_media/).
- Musa, A.S., Azmi, M.N.L. & Ismail, N.S. (2015). "Exploring the Uses and Gratifications Theory in the Use of Social Media among the students of Mass Communication in Nigeria". *Malaysian Journal of Distance Education*, Vol. 17, No. 2, pp83-95.
- Papoola, M., (2014), "New media usage for communication and self concept among journalism and mass communication students in Oyo State, Nigeria, *New Media and Mass Communication*, Vol. 26, pp.22-34.
- Patton, M. Q., (2002), *Qualitative Research and Evaluation Methods*, 3rd Ed, Sage, Thousand Oaks: California, CA.
- Thomas, J., Nelson, J. & Silverman, S., (2015), *Research Methods in Physical Activity*, 7th Ed., Human Kinetics, New York, NY.
- Whiting, A. & Williams, D., (2013), "Why people use social media: a uses and gratifications approach, *Qualitative Market Research: An International Journal*, Vol. 16, No. 4, pp. 362-369.
- Wylie, L., (2014), "The social media revolution", *British Journal of Midwifery*, Vol. 22, No. 7, pp. 502-506.

Yoo, S.J. & Kim, S., (2013), "How and why college students use Web 2.0 applications: The role of social media in formal and informal learning", *International Journal of Web Based Communities*, Vol.9, No. 2, pp.174-187.

# OWNERSHIP STRUCTURE AND FINANCIAL PERFORMANCE OF COMPANIES IN THE FRENCH STOCK MARKET INDEX CAC 40: IS THE FRENCH GOVERNMENT A PERFORMING SHAREHOLDER?

Spurr, Michael<sup>1</sup>; Goehlich, Veronique<sup>1</sup>; Fournier, Guy<sup>2</sup>

<sup>1</sup>Pforzheim University, International Business, Pforzheim, Germany

<sup>2</sup>Pforzheim University, Global Process Management, Pforzheim, Germany

## ABSTRACT

The French state's shareholdings constitute a distinguishable exception in comparison to equally developed industrialised countries and their financial markets, with respect to the degree of state ownership and its significance to the overall national economy. The French government's agency for administering the state's investments in public listed companies is a substantial investor on the stock exchange and holds a portfolio of several billion euros. Thereby, the shareholdings in companies that are part of the leading French stock market index "Cotation Assistée en Continu 40" (CAC 40) are of quintessential interest due to their financial weight, publicness and external image. Therefore, an analysis of the interdependences of (state) ownership in public listed companies and their economic performance will aid in evaluating the economic viability and meaningfulness of such investments.

Consequently, this paper examines the relation between the type of shareholder and the financial performance of the CAC 40 companies, by comparing the degree of voting shares held and the respective financial indicator in a correlation analysis. The sample consists of the 40 listed companies in the CAC 40 stock market index in the period of 2012 to 2015. After considering the national differences and specific features of French shareholder types, the results indicate an overall inferior performance of state shareholdings. Rather than identifying an across-the-board superior ownership form, each of the other shareholder types seems to excel in a certain category depending on their individual motivations and viewpoints.

*Keywords: State ownership, state shareholdings, French stock market index, CAC 40*

## INTRODUCTION

In a 2014 study the Organisation for Economic Co-operation and Development (OECD) examined the degree, size and significance of state-owned enterprises within the OECD countries in 2012. The results varied greatly from country to country, however overall, majority and minority state-ownership was still common despite numerous privatisation efforts. The study identified that sectors of strategic

importance for the broader economy such as network industries (gas, electricity, telecommunications, and transportation) are coined by a high degree of state involvement. Yet, on average state-owned enterprises were only responsible for 2,5 % of national employment in the OECD countries. Furthermore, the study showed the importance of the state as a shareholder in listed companies on national stock exchanges. Considering the corporate forms of state ownership, 31 % (by value) of state-ownership were held in listed majority-owned companies.

Among the most advanced and largest economies represented by the Group of 7 (G7) France overwhelmingly employ the most working people with 2,54 million jobs depending on companies with state-ownership. Additionally, the state involvement of the French government measured by market value (279 billion USD-dollars) exceeds all other G7 countries except Japan. Especially compared to its European neighbour country Germany, the Hexagon's surplus of 147 billion US-dollars seems impressive. (OECD, 2014)

This raises the question if the strategy of the French government is the right one and especially if the state as a shareholder outperforms other types of shareholders. To clarify this question, we will first show in a literature review the link between ownership and firm performance and explain the different types of ownership in France. In a methodological chapter, we will then examine how to measure the financial performance of companies and describe the used sample to measure the performance in France. Finally we will analyse if the performance of state owned companies is more performant than others in France.

## LITERATURE REVIEW

### *Analysis of Ownership and Firm Performance*

The financial literature on the analysis of the interdependences between ownership and firm performance is extensive and has been a continuous topic of interest during the last decades. Due to historical factors, economic circumstances and the evolution of financial markets, the context and conditions of these analyses varied to the same degree. Studies differentiate between the regional or global scope, the measurement of firm performance as well as the type of ownership to be analysed. One can distinguish between the concentration of ownership, i.e. shares held, the nature of the shareholder as well as the distinction between main, second and third, i.e. majority and minority, shareholders. (Mard *et. al*, 2014)

The analysis of the interdependences of ownership structure on firm performance fundamentally stems from three central hypotheses. The "convergence in interest theory" by Jensen and Meckling, which is based on Berle and Means (1932) work, concludes that a higher degree of managerial shareholdings will lead to a great focus on value maximization as executives participate from the firm's performance.

In contrast, the “neutrality hypothesis” of Demsetz (1983) reasons that a company’s performance is dependent on restrictions within the environment of an enterprise and thus the type of ownership structure is irrelevant. Lastly the work of Shleifer and Vishny (1989) presents the “entrenchment hypothesis” which argues that executives holding a large amount of shares will not be easily inclined to unite the interests of smaller shareholders. Various empirical studies on the degree of ownership as well as its structure have tried to confirm the theories, however a concluding statement concerning the relationship of ownership and firm performance cannot be made. (Séverin, 2001)

Due to the importance of context concerning such studies, a large amount of regional analyses has been performed. As the assessment of state ownership forms the cornerstone of this paper, a number of country-specific studies will be presented in the following. Yu (2013) lists and summarises several key studies on the dependences of state ownership and firm performance. China marks a special case due to the country’s economic and political developments in recent decades as well as due to the significance of the Chinese state as a shareholder on the stock exchanges. The presented studies examine time periods from 1991 to 2004 whereby different samples of Chinese public listed companies were researched. However, the results vary greatly. Whereas Qi *et al* (2000), Sun and Tong (2003) and Lin *et al.* (2009) observe a negative relationship between state ownership and firm performance, Wei and Varela (2003), Tian and Estrin (2008), Wei *et al.* (2005) and Hess *et al.* (2010) identify a U-shaped relationship. Furthermore, Hovey *et al.* (2003) observed no relationship and Sun *et al.* (2002) analysed an inverted U-shape interdependence. (Yu, 2013)

Chen *et al.* (2009), in analysing Chinese listed companies in the time frame 1999 to 2004, points out that in the case of China state ownership appears in the form of different state asset management bureaus and state-owned enterprises affiliated to local or central government, so that these should be distinguished between each other. This further highlights the importance of national differences when examining the influence of ownership structure. They conclude that enterprises owned by central government outperform other state-ownership types as well as private investors. (Chen *et al.*, 2009)

In further regional studies, Ahmad *et al.* (2008) identified a superior accounting performance (measured by the return on assets) as well as a better performance on debt, growth and profitability of Malaysian government linked companies compared to non-government linked companies. In a sample of Saudi-Arabian listed companies (2000-2003), Eljelly (2009) observed an outperformance of listed government related companies compared to private listed companies measured by the return on assets, return on equity and net profit margin. A further positive relationship was analysed by Rafiei (2014) in examining the Tehran stock exchange from 2009 to 2011. The results showed a significant positive effect of state ownership on performance and dividend pay-out.

The regional studies show that it is essential to recognise national differences, as was concluded based on the OECD study on state ownership in OECD countries. It is due to these national differences, that it is necessary to look at studies performed in the European and specifically French context, to achieve a certain degree of comparability. Mard *et al.* (2014) studied the connection between ownership structure and performance of French listed companies in the “Société des Bourses Françaises 250 index” from 2004 to 2008. Due to the relative inexistence of studies that combine the degree of ownership as well as the nature of the shareholder, they performed their analysis of shareholder concentration and type, and identified a U-shaped relationship concerning the degree of shares held by the main shareholder independent of the type of shareholder. For the second and third shareholder, they analysed a curvilinear-convex relationship. With respect to the state shareholdings, they identified a negative correlation with the companies’ profitability (return on assets) as well as market value (Tobin’s q). Mard *et al.* (2014)

To thoroughly prepare the analysis and interpretation of results, it is required to analyse the types of shareholders and ownership in France before examining their respective impact on the CAC 40 companies’ financial performance.

#### *Shareholder Types in France*

In France, as in the majority of capitalist countries, several different types of shareholders can be identified. The most wide-spread and important forms are management and executive shareholders, family shareholdings, financial institutional investors (banks, insurances, investment firms) industrial shareholders and the State as a shareholder – the State shareholder. (Mard *et al.*, 2014) This structure of shareholders is in line with La Porta *et al.* (1999) who defined family or individual shareholders, State shareholder, financial institutional shareholders (bank insurance company) and lastly miscellaneous shareholders.

The French model of corporate ownership is considered an insider model due to the high concentration of ownership, whereas the outsider model – defined by a wide dispersion of ownership – can be found in the United Kingdom, the United States and most of Continental Europe. La Porta *et al.* (1998) identified the historical relevance of shareholder regulation and protection as being integral in the shaping of ownership structures. In the case of France, Murphy (2005) determined a number of historical developments that shaped the ownership structure in the Hexagon. Firstly, a series of severe economic volatility starting with the rise and fall of John Law’s Mississippi Company, followed by the hyperinflation during the French revolution and lastly the demise of “Crédit Mobilier” and “Union Générale” in the nineteenth century, lead to the necessity of self-financing of companies and thus the facilitation of a high ownership concentration and the prevalence of family ownership. Secondly, according to Murphy (2005), the engagement of the state in the economy can be traced back to the 17<sup>th</sup>

century when Jean Baptiste Colbert (controller general of finances) was responsible for initiating considerable state involvements. Additionally, he analyses that alternating waves of nationalisations and privatisations during the last centuries influenced the balance between companies and the state, and thus cemented the importance of the French state. Lastly, the “pay-as-you-go system” (Murphy, 2005) in pension funding has led to an absence of fund and insurance investment and thus the importance of financial institutional investment is less relevant as compared to the United Kingdom or the United States. (Murphy, 2005)

#### *State Shareholdings*

In 2004, the French government established the “Agence de participations de l’État” (APE, decree n°2004-963, 9 September 2004) as an organisation of national competence under administration of the Ministry of Economy. The decree stipulated APE’s objective, as being the administration of the state’s shareholdings, whereby indirect and direct, as well as minority and majority participations of the French state were considered. (SGG, 2004)

In the financial year 2014-2015, APE controlled a portfolio of participations that was valued at 110 billion Euros and which paid 4.1 billion Euros in dividends to the French state’s general budget. Moreover, the companies in the state’s portfolio accumulated approximately to a combined 1.8 million jobs. These numbers show APE’s economic significance to France. Furthermore, it illustrates APE’s mission statement which specifies the goal of the state shareholder as being an investor in companies that are judged of strategic importance to the country, to stabilise their capital and potentially accompany them as they develop and transform. In light of APE’s strategic considerations, the agency has defined four economic sectors of national importance to the French state. Thus, the agency holds investments in the following industries: energy, heavy industry, services and transportation. Michel Sapin (Minister of Finance until 2017) and Emmanuel Macron (Minister of Economy, Industry and Digital Affairs until 2016, French President since Mai 2017) specified in the annual report 2015 the French state’s shareholding strategy. Firstly, the state acts as a long-term investor and aims to conciliate the strategy of the companies that are held by the state with the state’s strategy for France. Secondly, the state shareholder aspires to be a model for other shareholders concerning its social and environmental responsibility. (APE, 2015)

Whilst the French government is exclusively positive concerning this system, there are also critical voices existent, which condemn “the great return of state capitalism” (Ben-Abdelkader, 2014). Data provided by INSEE (national institute of statistics and economic studies) shows that in the period of 2007 until 2014, the French state’s shareholdings increased by 76%. In 2012, there were 1500 companies where the French state held a majority share, and 500 companies that were held by a minority share. (Ben-Abdelkader, 2014)



Amongst all the OECD countries, France holds the largest minority shareholdings measured in market value of its participations (160 billion US-dollars) and thus show that France most excessively makes use of this instrument. (OECD, 2014) Thereby it is relevant to refer to the discussions regarding the “Loi Florange” (Florange law). The Florange law stems from the closure of two production sites in Florange (north-west of France) by ArcelorMittal. The loss of jobs induced the French government to introduce this law that obligates companies to make all possible efforts to find a buyer before closing a production site. The most discussed article however related to double voting rights, as the law offered the possibility to implement the principle, that shareholders of a minimum of two years, are automatically granted double voting rights. Additionally, it gave companies the possibility to deactivate the 30%-threshold that, when reached by a single shareholder, obligates that shareholder to make an offer to the other investors. (Financial Times, 2015)

As the French state is not a speculative investor, it can build on these two provision of the Florange law to increase its voting rights without buying additional shares. With more voting rights, the state can consequently further influence a company’s strategy and impede hostile takeovers. The introduction of the law was heavily criticized by investors, however for the French state it provides a mean to enlarge its influence without additional costs and in continuing to collect dividends. As such it implies the state shareholder – which was presented as a “transitory step” on the route to a liberal capitalism – has turned into the French state’s long-term strategy. (Ben-Abdelkader, 2014)

#### *Family Shareholdings*

In France, the concept of family shareholders is not only limited to the sector of Small and Medium-sized Enterprises (SME) but also exists among the largest listed French companies of the CAC 40 stock index. Especially companies that have specialised in the industry of high-end luxury products and services are predominantly held by family shareholders. The internationally most well-known French brands and manufacturers are largely controlled by the members of one single family. Pernod Ricard, LVMH, L’Oréal and PPR (Kering) are only a few examples of corporations that are managed by a family’s second or third generation and that have a long heritage as well as history. These large groups exhibit the significance of family shareholdings to France – both economically and culturally. (Wood, 2011)

One reasoning that explains the phenomenon of strong family ownership in France looks at the historical financial traumas during the last centuries which prevented a wider dispersion of ownership. The need for self-financing translated to the necessary presence family- or individual-funding and also cemented the intergenerational nature of family ownership. In the 1930s, the then French prime minister Edouard Daladier condemned the “grandes familles” (Power dynasties) that controlled financial markets, business life and the press. Even though Anderson (1965) disproved the existence of

the assumed two hundred large dominating families, the concentration and prevalence of family-ownership can still be observed today. (Murphy, 2005)

Mard *et al.* (2014) highlight that family shareholders are very conscious and concerned about their (family's) reputation. However, the researchers debate the danger of a "rootedness" in the companies' management to the extent that family shareholders, to preserve controlling power over the firm, might be induced to refuse the implementation of transparent communication systems and effective governance structures. (Mard *et al.*, 2014)

In 2015, France held the third place concerning the percentage of listed companies under family control (>25 %-share voting rights or capital) in a European comparison. Approximately 30 % of listed companies were family-controlled, compared to an average of 17 % among all 31 examined European countries. Solely Italy and Belgium displayed a more elevated degree of family control. (FEAS, 2015)

#### *Financial Institutional Investors*

Financial institutional investors are the largest group within the CAC 40 stock market index, however there are some difficulties to structure and group the different types of institutional investors amongst each other. In 2013, 32% of the shares in the CAC 40 index were held by financial institutional investors. (Mard *et al.*, 2014)

This type of shareholder can be differentiated based on its status, its origin and its behaviour and degree of involvement in the management of a company. Overall, one can structure institutional investors in three categories: Mutual investment funds ("Les Organismes de Placement Collectif" (OPC)), insurances and pension funds. (Oheix, 2007) Moreover, different types of institutional investors are characterised by their degree of participation and intervention in a company's management. As such they can be classified in active and passive investors. An institutional investors' involvement is dependent on the investment horizon, the level of participations (percentage share) and the nature of the relationship between investor and company. In light of these differentiations, financial institutional investors can operate as active shareholders and influence a company's decision making heavily, however they can also be passive investors that only earn the dividends of their investment and want to profit from a rise in share prices. (Sahut and Gharbi, 2010)

Institutional investors are often accused of only focusing on the short-term benefit of their investments, and as such pressure the executives of a company to favour decisions that profit the corporation in the short-term. In that manner, financial institutional shareholders would be ready to accept the impediment of important long-term value creation. (Mard *et al.*, 2014)

#### *Industrial Shareholdings*

Share ownership of non-financial companies in France – industrial shareholdings – experienced a period of decline from 1977 up until 2013. Whilst the degree of industrial shareholdings was at around

30% during the 1970s, the ownership percentage of non-financial investors halved until 2009 when it stabilised at around 15 %. However, from 2009 until 2013 non-financial shareholdings in France increased again to about 22%. (OEE, 2013)

Mard *et al.* (2014) argue for a comparison of the Japanese “Keiretsu” system of investments and linkages amongst the largest Japanese companies, with the French and Swedish system of mutual investments by the large corporations and groups amongst each other. The researchers indicate the loss of flexibility and the difficulties with respect to governance questions as being drawbacks of this shareholder type. Central to industrial shareholdings is their long-term strategic interest. As such, companies often cooperate and collaborate on certain common products or projects. (Mard *et al.*, 2014)

A prominent example of such a long-term industrial cooperation is the case of Renault-Nissan in France with Daimler in Germany. In 2010, the two companies exchanged a certain degree of share ownership to consolidate their industrial partnership. The two car manufacturers agreed on the cooperation concerning the development of small vehicles, utility vehicles, power trains and electric vehicles. Through this partnership Renault-Nissan and Daimler aim to save costs by sharing investment expenditures, to benefit from economies of scale and to profit from the specific qualities of the other manufacturer. (Pluyette, 2010)

#### *Employee Shareholdings*

In contrast to Mard *et al.* (2014) who defined the category of managerial and executive share ownership, this study will broaden the perspective and highlight the significance of employee shareholdings in French listed companies.

Before elaborating on the status of employee shareholders in France, it is essential to give a definition of the term. The term “Actionnariat Salarié” (employee shareholder) is defined by the French Commercial Code (le Code de Commerce). Contrary to the implied sense of the words, the term refers to a company’s “Plans Épargne Entreprise” (PEE) (employee savings scheme), “Fonds Commun de Placement d’Entreprise” (FCPE) (employee mutual investment fund) and shares of privatisations (depending on if they are still in their period of non-transferability). By implication this signifies that all the people working for a company – its employees – holding shares of that company, do not necessarily have to be considered as employee shareholders. In 2014, France was designated “European champion” (ERES, 2015) of employee shareholdings as the country accounted for 40 % of employee shareholders in Europe (3,3 million in France versus 8,3 million in Europe) which held 30 % of the total market capitalisation (82,7 billion Euro in France versus 286,5 billion Euro) of employee-held shares. Moreover, the democratisation rate – the number of employee shareholders compared to the total of employees – was 18 percentage points higher than in Europe. Lastly, the share of total capital held by employee shareholders was the highest among European countries: France (3,9 %), Austria (2,4 %), United

Kingdom (1,5 %), Germany (1,0 %) and Europe (1,6 %). (ERES, 2015). In 1999, the “Fédération Française des Associations d'Actionnaires Salariés et Anciens Salariés” (French Federation of Associations of Employee and Former Employee Shareholders) (FAS) launched a stock market index of employee shareholding companies (“L'Indice de l'Actionnariat Salarié” (IAS)). The index is composed of companies in the SBF 250 stock market index. Amongst others BNP Paribas, Orange, Peugeot, Safran and Vivendi are part of the IAS index while these companies are also represented in the CAC 40 index. Moreover, in 2015 a study of the “Fédération Européenne de l'Actionnariat Salarié” (FEAS) (European Federation of Employee Share Ownership (EFES)) showed, that among the twenty companies with the largest employee participation in Europe (measured by the employee-held capitalisation, ranking position in brackets), eleven were French: Total (2), Bouygues (5), AXA (6), BNP Paribas (7), Safran (8), Vinci (10), Sanofi (11), Société Générale (14), Essilor (15), L'Oréal (17) and Schneider Electric (20).

## DATA AND METHODOLOGY

### *Measuring Financial Performance*

The before-mentioned studies measured firm performance by applying a number of different indicators. However, three main measures for performance can be identified across nearly all studies (Mard *et al* (2014), Ammari *et al.* (2014) Ahmad *et al.* (2008), Sun *et al.* (2002), Tian and Estrin (2008), Wei *et al* (2005), Hess *et al.* (2010)): return on assets (ROA) and return on equity (ROE) to measure the company's accounting performance and profitability, and Tobin's q to measure a company's market performance by comparing market value with book value.

### *Presentation of the Sample and Limitations*

The analysis in this paper is conducted on the sample of the 40 companies in the leading French stock market index CAC 40. The index is a main indicator for the performance of the French financial markets and one of Europe's most important indices. The CAC 40 displays the market sentiment and development of the French economy, so that an analysis of its components concerning the ownership structure and the financial performance will yield meaningful results. To be able to determine interdependences between these two variables and due to the relatively small sample size, it is essential to classify the shareholders with respect to their nature. However, one must also regard that the conclusions drawn from this analysis cannot be valued as definitive and are mainly applicable in the context of this study.

The forty companies in the CAC 40 have been structured in five categories of shareholders. Furthermore, the study examines the averages for the selected financial indicators in the period from 2012 to 2015, spanning four reporting periods of data. Data was available for all companies and sourced

from investment research websites. The ownership structures were analysed based on the information provided by the companies' web presence or annual report, and evaluated according to the shareholder's share of voting rights. Where such information was not provided the share of capital was considered assuming no deviation in the voting structure. The publication date of the ownership figures ranges from December 31, 2014 to June 30, 2016, thereby leading to the assumption that no significant changes in the structure have occurred.

Among the 40 companies there are 12 enterprises with state shareholdings, 10 with family shareholdings, 30 with financial institutional shareholdings, 12 with industrial shareholdings and 32 companies that recorded employee shareholdings.

#### *Explanation of the Variables and Measures*

The shareholders of the respective companies were classified – as presented in the literature review – in five different categories: state shareholdings, family shareholdings, financial institutional shareholdings, industrial shareholdings and employee shareholdings.

In deviating from the financial indicators applied by most of the existent studies (return on assets, return on equity and Tobin's q) in the current financial literature, this study has decided to use the following measure to evaluate the firm's respective financial performance: profitability (net profit margin and return on equity), economic development (revenue growth rate), financial attractiveness to shareholders (dividend payout ratio) as well as short-term (current ratio) and long-term financial stability (debt to equity ratio).

In the following the correlation between the group of shareholders that recorded ownership in a company and their associated financial indicator value have been calculated, so that the impact one type of shareholder has on the firm performance can be assessed.

## **RESULTS OF THE ANALYSIS**

The correlation analysis of the shareholder type and the evaluated financial indicators yielded the results displayed in Table 2, and aids in examining the interdependences of the two variables shareholder and performance. More specifically it helps to answer the question: How does ownership of a certain type of shareholder influence the financial performance of a company? Table 1 shows the average values per shareholder type and financial measure.

The influence of state shareholdings shows a majoritarian negative picture. Whereas the correlation with the dividend payout ratio is positive, the relationship with the debt to equity ratio, the revenue growth rate and the net profit margin show a negative trend. Especially concerning the impact on the financial stability measured by the debt to equity ratio and the company's profitability measured by the

net profit margin (see Figure), a negative correlation can be observed (-0,35 and -0,56 respectively). It is also further notable, that the state shareholdings have the lowest net profit margin, return on equity, current ration and debt to equity ratio among all shareholder types. Lastly the return on equity (-0,04) and the current ratio (0,05) do not show a clear trend regarding the state's influence.

Companies with shareholdings of financial institutional investors seem to be the most profitable, as this group of investors has the highest average net profit margin and return on equity. Furthermore, a positive correlation concerning the current ration and debt to equity can be observed, implying an increased financial stability. The influence of industrial shareholders is ambiguous. On the one hand, this type of shareholder leads to the highest positive correlation measured in the sample with respect to the revenue growth rate (0,73). This could stem from the increased cooperation on products and projects. On the other hand, a clear negative relationship regarding the current ration and thus financial stability can be observed.

The analysis in this paper further showed and confirmed stereotypical assumptions concerning family shareholdings. Whereas the financial caution and prudence is displayed in the lowest dividend payout ratio (66,9 %) as well as the strong negative correlation (-0,58), the long-term financial stability is significantly the highest among all types of shareholders. Lastly, the impact of employee shareholders on the firm performance gives an unclear picture. Companies with financial participation of their employees display a superior absolute profitability and a high dividend payout ratio. However, the relationship with respect to the short-term and long-term financial stability show a negative correlation. Having outlined this, it should not be neglected that the average percentage of ownership by employee shareholdings is at only 5,7%.

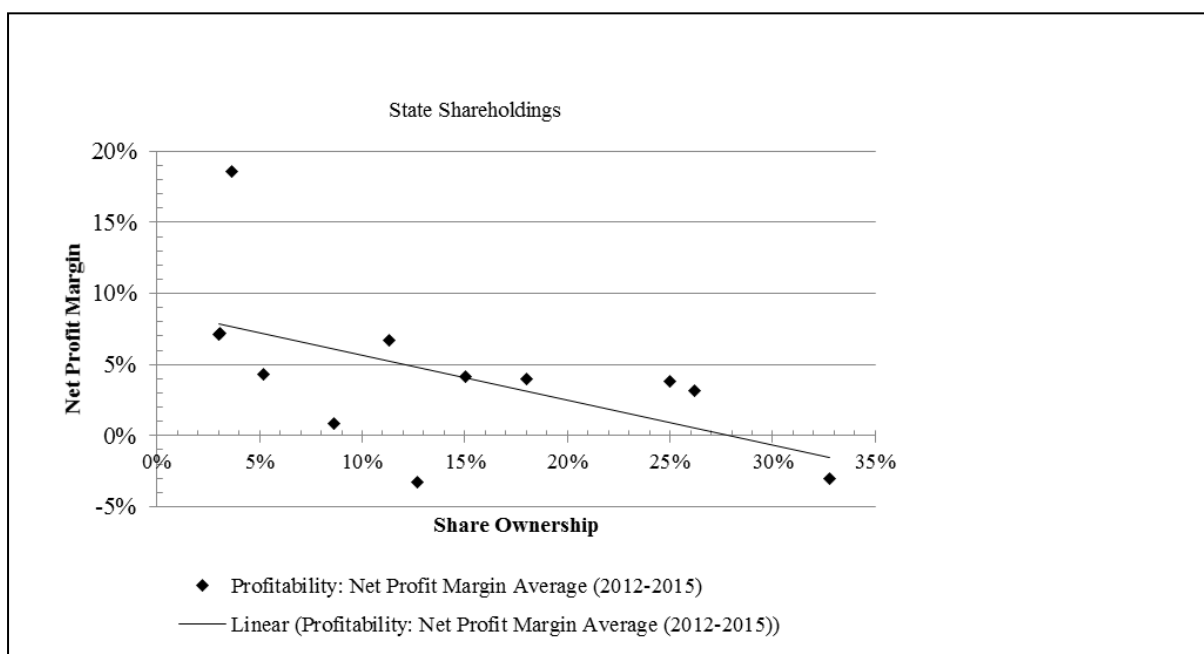

*Figure 1. Correlation analysis: State Shareholdings, Net Profit Margin*

Shareholder type	Percentage of shares held	Net Profit Margin	Return on Equity	Revenue Growth Rate	Dividend Payout Ratio	Current Ratio	Debt to Equity Ratio
State shareholdings	13,7 %	4,5 %	5,5 %	5,2 %	80,7 %	88,1 %	47,4 %
Family shareholdings	25,2 %	5,2 %	5,8 %	1,8 %	66,9 %	114,0 %	76,8 %
Financial institutional shareholdings	49,0 %	8,7 %	8,2 %	3,2 %	80,7 %	103,4 %	60,1 %
Industrial shareholdings	21,5 %	6,4 %	6,3 %	5,1 %	69,8 %	96,4 %	62,7 %
Employee shareholdings	5,7 %	8,7 %	8,1 %	4,4 %	82,5 %	104,4 %	62,0 %
Overall	n/a	8,2 %	8,6 %	4,2 %	71,9 %	105,8 %	59,7 %

*Table 1. Comparison of financial indicators across different shareholder types*

Shareholder type	Current Ratio	Debt to Equity Ratio	Dividend Payout Ratio	Net Profit Margin	Return on Equity	Revenue Growth Rate
State shareholdings	0,05	-0,35	0,42	-0,56	-0,04	-0,28
Family shareholdings	0,35	0,22	-0,58	0,14	-0,04	0,08
Financial institutional shareholdings	0,20	0,12	0,03	-0,19	0,19	-0,16
Industrial shareholdings	-0,48	-0,20	-0,14	-0,19	-0,08	0,73
Employee shareholdings	-0,10	-0,26	-0,14	-0,18	-0,01	0,15

*Table 2. Results of the correlation analysis*

## CONCLUSION

The initial goal of this paper was to answer the question whether the state as a shareholder outperforms other types of shareholders. The analysis was performed on the forty companies in the leading French stock market index CAC 40 for the period 2012 to 2015. The state shareholder was compared to family, financial institutional, industrial and employee shareholdings. The financial indicators applied in the study assessed the company's profitability, economic development, financial stability and attractiveness to shareholders.

The correlation analyses showed that state shareholdings do not lead to a superior financial performance. In contrast, the analysis showed a clear negative relationship and thus degradation concerning the profitability, long-term financial stability and economic development. Notable however

is the strong positive impact the state shareholder has on the dividend pay-out ratio. In conclusion, the state shareholdings seem to have a negative impact on the firm's performance. From an investor perspective however, the positive correlation concerning the dividend pay-out ratio could be evaluated rather favourably.

Furthermore, the analysis did not identify one type of shareholder that outperforms all other shareholders or a shareholder which provides a distinguishably more positive relationship than other shareholders. Rather, each ownership type excelled or displayed a comparably favourable in a certain category. Therefore, it is necessary to consider the individual shareholder type's viewpoint which explains their respective motivations.

Whereas financial institutional shareholders are primarily interested in their financial advantage exemplified by the payment of dividends, family shareholders are coined and their actions dominated by the intergenerational nature of preserving and passing the company on to their descendants. In contrast, industrial shareholders are concentrated on the cooperative nature of their investments and the benefits from sharing development costs. Moreover, employee shareholders are mainly interested in the financial advantages of their pension provisions and thus a secured retirement. In that same manner, the French state as a shareholder, as defined by its mission statement focuses on the alignment of the respective company's strategy with the strategy for France. Additionally, it sees itself as a supporting and stabilizing actor of the French economy, based on the shareholdings in the four defined strategic sectors: energy, heavy industry, services and finance and transportation. Consequently, the government aims to be a role model shareholder for other investors concerning its social and environmental responsibility.

If one bases the answer to the initial question of the state being a performing question solely on the quantitative analysis, giving the answer is easy: the French state is not a performing shareholder. Depending on a qualitative analysis of the company's performance however, could lead to different results. Moreover, despite its significance for the French economy, the sample of the stock market index CAC 40 cannot lead to conclusive answers. Thereby, an analysis on a large sample size of listed French companies combined with a multivariate regression analysis, testing an equation that has performance as dependent variable and other variables like the size of the firm, the type of industry, type of ownership etc. as independent variable would have to be conducted.

## REFERENCES

Agence des participations de l'État (APE) (2015), "Rapport annuel 2014-2015 : L'État actionnaire : Energie, Industries, Services et Finances, Transports", Juillet 2015, available at: [http://www.economie.gouv.fr/files/files/directions\\_services/agence-participations-etat/Rapport\\_APE.pdf](http://www.economie.gouv.fr/files/files/directions_services/agence-participations-etat/Rapport_APE.pdf) (accessed 15 February 2017).



- Ammari, A. and Kadria, M. and Ellouze, A. (2014), "Board Structure and Firm Performance: Evidence from French Firms Listed in SBF 120", *International Journal of Economic and Financial Issues*, Vol. 4 No. 3 2014, pp. 580-590.
- Ahmad, R. and Aliahmed, H.J. and Ab Razak, N.H. (2008), *Government Ownership and Performance: An Analysis of Listed Companies in Malaysia*, available at: <http://dx.doi.org/10.2139/ssrn.1252072> (accessed 15 February 2017).
- Ben-Abdelkader, F. (2014), "En France, le grand retour du capitalisme d'Etat", *Le Monde*, 27 February 2014, available at: [http://www.lemonde.fr/economie/article/2014/02/27/en-france-le-grand-retour-du-capitalisme-d-etat\\_4374480\\_3234.html](http://www.lemonde.fr/economie/article/2014/02/27/en-france-le-grand-retour-du-capitalisme-d-etat_4374480_3234.html) (accessed 15 February 2017).
- Chen, G. and Firth, M. and Xu, L. (2009), "Does the type of ownership control matter?: Evidence from China's listed companies", *Journal of Banking & Finance*, Vol 33, pp. 171-181.
- Epargne Retraite et Salariale (ERES) (2015), *Etude actionnariat salarié Eres : La France toujours championne d'Europe*. (12 May 2015), available at: <https://www.eres-group.com/etudes-et-enquetes/etude-actionnariat-salarie-eres-la-france-toujours-championne-deurope/> (accessed 15 February 2017).
- Eljelly, A.M.A. (2009), "Ownership and Firm Performance: The Experience of Saudi Arabia's Emerging Economy", *International Business & Economic Research Journal*, Volume 8 Number 8 August 2009, pp. 25-43.
- Mard, Y. and Marsat, S. et Roux, F. (2014), "Structure de l'actionnariat et performance financière de l'entreprise : le cas français", *Finance Contrôle Stratégie*, Vol 17-4 2014, available at: <http://fcs.revues.org/1559> (accessed 15 February 2017).
- Fédération Française des Associations d'Actionnaires Salariés et Anciens Salariés (FAS) (URL), *Indice IAS®*, available at: [http://www.fas.asso.fr/voir\\_evenement-detail\\_evenement-rubrique-2013-0-0-169.html](http://www.fas.asso.fr/voir_evenement-detail_evenement-rubrique-2013-0-0-169.html) (accessed 15 February 2017).
- Fédération Européenne de l'Actionnariat Salarié (FEAS) (2015), *RECENSEMENT ÉCONOMIQUE ANNUEL DE L'ACTIONNARIAT SALARIÉ DANS LES PAYS EUROPÉENS 2015*, available at: <http://www.efesonline.org/Annual%20Economic%20Survey/2015/Recensement%202020.pdf> (accessed 15 February 2017).
- Financial Times (2015), "French companies do not need the 'Loi Florange'", 8 April 2015, available at: <https://www.ft.com/content/c0527ee0-dde2-11e4-8d14-00144feab7de> (accessed 15 February 2017).
- L'Éducation Financière du Public (IEFP) (URL), *Salarié et actionnaire*, available at: <http://www.lafinancepourtous.com/Epargne-et-placement/Epargne-salariale/Salarie-et-actionnaire/Actionnaire-de-son-entreprise/Actionnaire-salarie.-Qu-est-ce-que-c-est> (accessed 15 February 2017).
- La Porta, R. and Lopez-De-Silanes, F. and Shleifer, A. (1999), "Corporate Ownership Around the World", *The Journal of Finance*, Vol. LIV No. 2, April 1999, pp. 471-517.
- Secrétariat général du Gouvernement (SGG) (2004), *Décret n°2004-963 du 9 septembre 2004 portant création du service à compétence nationale Agence des participations de l'Etat*. NOR: ECOZ0400043D, available at: <https://www.legifrance.gouv.fr/affichTexte.do?cidTexte=LEGITEXT000005842300> (accessed 15 February 2017).
- Murphy, A. (2005), "Corporate Ownership in France – The Importance of History", Morck, R.K., *A History of Corporate Governance around the World: Family Business Groups to Professional Managers*, University of Chicago Press, Chicago and London.
- Observatoire de l'Épargne Européenne (OEE) (2013), "Who owns the European economy ? Evolution of the ownership of EU-listed companies between 1970 and 2012", August 2013, available at: [http://ec.europa.eu/finance/finservices-retail/docs/fsug/papers/1308-report-who-owns-european-economy\\_en.pdf](http://ec.europa.eu/finance/finservices-retail/docs/fsug/papers/1308-report-who-owns-european-economy_en.pdf) (accessed 15 February 2017).
- Organisation for Economic Co-operation and Development (OECD) (2014), "The Size and Sectoral Distribution of SOEs in OECD and Partner Countries", OECD Publishing, available at: <http://dx.doi.org/10.1787/9789264215610-en> (accessed February 2017).
- Oheix, V. (2007), "Investisseurs institutionnels et marchés financiers (Dossier: Monnaie et financement)", *Idées économiques et sociales*, n°148, p. 37 (06/2007), available at: <http://www.educ-revues.fr/ID/AffichageDocument.aspx?iddoc=35543> (accessed 15 February 2017).
- Pluyette, C. (2010), "Renault-Nissan et Daimler signent leur union", *Le Figaro*, 7 April 2010, available at: <http://www.lefigaro.fr/societes/2010/04/07/04015-20100407ARTFIG00038-renault-nissan-et-daimler-signent-leur-union-.php> (accessed 15 February 2017).
- Rafiei, M. and Far, S.A.H. (2014), "Effect of State Ownership on Firm Performance and Dividend Payout Policy", *International Journal of Academic Research in Business and Social Sciences*, Vol. 4 No. 7 July 2014, pp. 213-219.
- Séverin, E. (2001): "Ownership structure and the performance of firms: Evidence from France", *European Journal of Economic and Social Systems*, Vol 15 No. 2 (2001), pp. 85-107.

Sahut, J.M. and Gharbi, H.O. (2010), "Activisme des investisseurs institutionnels : cadre général et facteurs d'influence", *La Revue des Sciences de Gestion*, 3/2010 (n°243-244), pp. 25-33.

Wood, Z. (2011), "In France, making billions is often a family business", 23 March 2011, *The Guardian*, available at: <http://www.theguardian.com/world/2011/mar/23/new-europe-france-family-businesses-pernod-lvmh-dior> (accessed 15 February 2017).

Mei Yu (2013): "State ownership and firm performance: Empirical evidence from Chinese listed companies", *China Journal of Accounting Research*, Vol. 6 Issue 2, pp. 75-87.

## BIG DATA IN SME - FINDINGS OF AN EMPIRICAL STUDY

**Sterk, Matthias; Graue, Carolin; Britzelmaier, Bernd**

Business School, Pforzheim University, Pforzheim, Germany

### ABSTRACT

The aim of this study is to provide an analysis of the relevance, challenges and potentials of big data analytics for small and medium-sized enterprises (SMEs) in Germany. Big data is a comparatively young topic and the literature indicates that little research has addressed big data in SMEs in a German context. Given the lack of knowledge in this field, this paper follows a rather explorative approach. Based on literature review there is a research gap for SMEs in terms of relevance of big data analytics, of affiliated challenges and risks as well as opportunities and potentials and responsibility issues. Following a multi-perspective approach, twelve experts with various backgrounds were interviewed in order to get a holistic view of the topic. Half of them are employed in SMEs; whereas the other six experts come from external consultancies and academic institutions.

*Keywords: Big data analytics, small and medium-sized enterprises, SMEs, relevance, challenges, potentials, Germany*

### INTRODUCTION

This paper shows the results of a qualitative study, which analyses the relevance, challenges and potentials of big data analytics for small and medium-sized enterprises (SMEs) in Germany. The term “big data” is a relatively recent construct and was first used in 1997 by researchers Michael Cox and David Ellsworth at NASA (Bundesrechenzentrum, 2015), who addressed the rapid and unstoppable increase in data volumes (Press, 2013). Due to the increasing digitalization (Roßmeißl and Gleich, 2014; Seufert, 2014, Feindt and Grüssing, 2014) and an increased storage of pictures and videos, there is an ever-increasing data expansion (Vierkorn et al., 2014; Stockinger and Stadelmann, 2014). Additionally, the “Internet of Things” had made it possible to connect the digital world to the physical one for several years now (Roßmeißl and Gleich, 2014). Meanwhile, machine-generating data such as log files or sensor data are also being obtained (Stockinger and Stadelmann, 2014). This rapid growth in data volumes and availability is considered the main initiator of big data.

Due to its novelty, big data was until recently a buzzword, which was not clearly defined. However, this has changed and most companies of all sizes now seem to be fully aware of the topic. Internationally and nationally, there are a variety of different studies on the subject of big data

analytics. But up to now there is a research gap for big data analytics in SMEs, which this paper tries to bridge.

## **BIG DATA AND SMES**

### *Definition of big data*

There have been several independent attempts to define big data. The global management consulting firm McKinsey (2011) determines the term as follows and deals mainly with the increasing volume of data: "Big data refers to datasets whose size is beyond the ability of typical database software tools to capture, store, manage, and analyze." Davenport (2014) agrees to that in his view of big data as "The broad range of new and massive data types that have appeared over the last decade (...)" and adds the feature data variety. Another important feature of big data is the non-negligible data velocity. On the one hand, this is the accelerating transfer rate, in which data is currently being generated in highly diverse fields of applications. On the other hand, these huge amounts of data must be analyzed within a small time frame or even in (almost) real time for the fastest possible response (BITKOM, 2014a). Dumbill (2012) refers to this third characteristic in his interpretation of big data: "Big data is data that exceeds the processing capacity of conventional database systems. The data (...) moves too fast, or doesn't fit the strictures of your database architectures."

For data management, Laney (2001) was the first one to define volume, velocity and variety as integrative and interdependent. His understanding of the so-called "3 V's" is nowadays used by many specialists and organizations (Berman, 2013; BITKOM, 2014a; Miele et. al, 2013; Schroeck et al., 2012). But some experts and institutions expand the 3V model by a fourth dimension, veracity, which was initiated by IBM (Schroeck et al., 2012; Grönke et al., 2014; Baumöl and Berlitz, 2014).

"Volume", a characteristic already contained in the name of big data, is the exponential growth of the data sets (BITKOM, 2014b). According to studies, a total of 90 percent of today's data volumes have only emerged in the last two years (Kaufmann, 2014) and data volume doubles every two years (Fraunhofer, 2012; Dorschel, 2015). This enormous growth in global data volume makes clear that the ratio between applicable knowledge and information from existing (and disproportionately growing) data is becoming ever-smaller (Kaufmann, 2014).

"Variety" reflects the fact that data is produced in new areas of life. When considering the variety of the data, a distinction is made between "structured", "semi-structured" and "unstructured" data (King, 2014). Structured data is extracted from ERPs, CRMs and transaction data. However, McAfee and Brynjolfsson (2012) note that they are nowadays untenable as single databases and are only suitable to a limited extent for big data. Enterprises therefore include semi-structured data, which are created automatically and cannot be processed by standardized instruments (King, 2014). Examples are social

media applications, GPS signals, sensor data, geodata, online purchases or smartphone applications (McAfee and Brynjolfsson, 2012). Unstructured data are not consistent in both, their format and structure and therefore require new technologies for processing, evaluating and filtering (King, 2014). The best-known unstructured data are emails, text documents, audio and video files or other internal business documents (McAfee and Brynjolfsson, 2012; King, 2014). Dealing with data variety is, according to Burow et al. (2014), the greatest challenge for many companies.

“Velocity” describes the increasing speed with which new data are generated, as well as the reduction of the period in which they can be used to create value (Fasel, 2014; McAfee and Brynjolfsson, 2012). Often large amounts of data with different data characteristics only provide added value if they are evaluated and analyzed as fast as possible and (almost) in real time, so that a company can act more agile than its competitors and is able to respond quickly to economically important events (Baumöl and Berlitz, 2014; Bendler et al., 2014; Mayer-Schönberger, 2015; McAfee and Brynjolfsson, 2012).

“Veracity” refers to the quality of the data in particular for its authenticity, completeness and ambiguity (Baumöl and Berlitz, 2014). Many data, such as internet videos or data from social networks, do not have high trustworthiness and represent a great risk because of the high manipulability (Burow et al., 2014).

All four elements solely describe the characteristics of big data. Grönke et al. (2014) and King (2014) point out that a single consideration of volume, variety, velocity and veracity of the data is not sufficient if big data is to create value within companies. The real additional value of big data is the creation of new insights based on an analysis and evaluation of the data (big data analytics).

This results in following definition which shall be used for this study: Big data analytics describes the processing and evaluation of constantly growing data sets with a diverse data structure in the highest possible data quality at a high speed, whose goal it is to generate economic value.

#### *Big data responsibility in companies*

The general responsibility for big data in companies is not entirely clear. Big data can impact many business areas, resulting in the need to coordinate new findings. Not only in business practice but also in literature, it is agreed that the departments management control and IT play an important role in the coordination process (Burow, 2014). Although according to Weber (2014), there is a lack of suitable persons who have an adequate overview of the company, management accountants are most likely to see and implement big data’s interdisciplinary opportunities due to their interaction with all management levels and functions. Burow (2014) also underlines the necessary cooperation with the IT department, which is the enabler that provides the IT systems for the data handling. The processing (analytics) of big data is carried out by the management control department, that provides decision-makers with evaluated analysis results (Burow, 2014). However, this close interlinking of IT and

management control makes it necessary, that management accountants deal with new, changed requirements (Horváth and Aschenbrücker, 2014; Becker et al., 2015; Grönke and Heimel, 2015; Michel et al., 2015).

The possible improvement in transparency through previously unavailable data from customers, products, resources, business processes, etc. is an important by-product (Gänßlen and Losbichler, 2014). Likewise, big data affects the planning and control system and can be used there. The “Internationale Controller Verein” (2014) (association of management accountants from Germany, Austria and Switzerland) mentions examples such as forecasting, scenarios or early identification.

#### *Definition of small and medium-sized enterprises*

SMEs economically play a very important role in Germany (Mac an Bhaird, 2010). Their importance is substantiated by the following points: More than 99 percent of German companies are considered SMEs, they employ around 60 percent of the employees, accounting for over 30 percent of the total turnover and contribute almost 55 percent to Germany’s overall economic performance. In addition, SMEs have the comparatively highest importance in Germany compared to other European countries (BMW, 2014; Statistisches Bundesamt, 2012; European Commission, 2014).

However, there is no legal and generally valid definition for the concept of SMEs in Germany. That makes a comparability of studies on SMEs complicated (Curran and Blackburn, 2001). However, two definitions are used in science and practice: the SME definition of the European Commission as well as the one of the “Institut für Mittelstandsforschung (IfM) Bonn” (Reinemann, 2011).

The definition of SMEs by the European Commission (2003) is based on a subdivision into micro, small and medium-sized enterprises. It uses the criteria number of employees (< 250), turnover (< EUR 50 million) and the balance sheet total (< EUR 43 million). But the most widely used definition in Germany is the one of IfM Bonn (2016). It also refers to quantitative criteria, but only considers the criteria number of employees (< 500) and turnover (< EUR 50 million). The advantage of using purely quantitative aspects is the simple determination and availability of statistical data (Reinemann, 2011). However, the actual classification of SMEs often does not take place through purely numerical differentiation criteria, but also takes into account qualitative and structural aspects, which sometimes allow a differentiation from large enterprises without size limits. Similar to the quantitative analysis, there is also no consensus in determining the relevant qualitative criteria.

According to literature, one of the most important qualitative criteria is that SMEs are characterized by the unity of ownership and management (Schäfer, 2004; Reinemann, 2011; Britzelmaier et al., 2009). Additional characteristics are flat hierarchies and a personal relationships between the company and its environment. Also the legal independence, which means the exclusion of group-dependent companies

from the circle of SMEs, is always taken into account (Becker et al., 2008; Reinemann, 2011; Schäfer, 2004).

Due to the novelty and complexity of big data, which leads to a lack of familiarity also with larger medium-sized companies, an own defined definition shall be used for this research. Hence, the thresholds of up to 3,000 employees and annual sales of up to EUR 600 million are set as quantitative indicators. These are subjectively determined, but are based on the analysis of various studies and the knowledge gained from them. In addition, the listed qualitative aspects are considered, but are rated as complementary and do not always have to be fully applicable to the companies under investigation. There is no application of corporate or group interlinking in this research. Accordingly, small and medium-sized enterprises which are dependent on a group are not included in the definition of SMEs.

#### *Current state of research*

Big data analytics is a very young field of research in both, the theoretical scientific view and the practical implementation in companies (Schroeck et al., 2012). Also the literature research shows that first relevant professional literature or research-specific studies have been published no earlier than 2011.

A study conducted by the Experton Group (2012) reveals, that almost 50 % of the respondents have not yet started any concrete big data activities. 38 % plan activities in the future, while only 13 % have already implemented and executed big data projects. Consequently, only about 50 % of German companies are actively engaged with the issue, while internationally 75 % of the companies already deal with big data. This rather conservative and waiting attitude towards big data in German companies is confirmed by a study conducted by the auditing firm KPMG (2014). The study shows that 47 % have neither planned the use of big data solutions at present nor in the future and only 11 % carry out pilot projects. The study also reveals that the younger the participants, the higher the potential and importance of big data are weighted. After all, the more advanced a company deals with big data, explores possible potentials and is actively involved with big data solutions, the higher the potential is also assessed.

Studies also confirm, that the responsibility of big data is often not clearly defined in companies. Due to the novelty as well as the lack of experience, interdisciplinary project teams are responsible. According to the BARC (2014) study, the departments IT (44 percent), finance and management control (39 percent) as well as those of the BI organization (36 percent) are particularly important. The same can also be observed in the actual application fields of big data. According to BITKOM's (2014b) study report, big data solutions are particularly used in finance and management control (44 percent) as well as in IT (33 percent). Big data activities also take place in the areas of logistics (33 percent) and HR (26 percent). By far the biggest use is, however, in the fields of marketing and sales (74 percent).

In a study conducted by the professional services firm Deloitte (2014), the growing importance of big data is also apparent for SMEs. 87 % of surveyed SMEs reported that there was a sharp rise in data volumes in the recent past, which made a more intensive debate indispensable. Furthermore, 77 % of respondents strongly support the need for ever-faster decision-making due to the increasing complexity of the environment. Hence, despite the high significance of big data for SMEs, it comes as a surprise that according to BARC (2014), only 7 % use big data solutions as an integral part of business processes or 13 % have at least a pilot project. The remaining 80 % have no active discussion of the topic. Similar results are evident in the survey of BITKOM (2014b). Only 7 % of SMEs up to 499 employees already use big data solutions, whereas 64 % did not plan a concrete use of it. For comparison, 27 % of the companies with more than 500 employees already use big data solutions.

A study of the auditing company PwC (2014) takes a closer look at the surprising and paradoxical attitude of SMEs towards big data, whose importance they are aware of. It compares the familiarity with big data on the basis of different company sizes and the already mentioned lack of knowledge becomes clear. There is a correlation between company size and familiarity with the topic. With increasing company size, the familiarity with big data also increases. Only 10 % of SMEs with up to 499 employees see themselves as “very familiar” with the topic. For comparison, 60 % of the companies with a workforce of 1,000-4,999 and 65 % with more than 5,000 employees show a familiarity. This relativity thus has an effect on further results. SMEs with up to 499 employees have the highest “non-familiarity” (33 %) compared to companies with more than 5,000 employees (6 %), and see themselves not in a position to successfully integrate big data activities into company processes.

## RESEARCH QUESTIONS

As shown above, most studies do not follow a specific size of companies like SMEs. They also do only differentiate very limited or not at all between qualitative features. Nevertheless, a number of studies show the strong reluctance of SMEs to deal with big data activities compared to large corporations. The main reason is their lack of familiarity with the topic. Although there are some new insights regarding big data in general, the research on SMEs is yet to mature. Their statements are often limited and very superficial. Given this background, the study aims at answering following research questions:

- RQ 1: How relevant is big data analytics for SMEs?
- RQ 2: What are the challenges and risks, but also opportunities and potentials concerning big data?
- RQ 3: Who can take the responsibility for big data activities in SMEs?

In this respect, the study shall contribute to important questions concerning big data in the context of small and medium-sized enterprises, whose outstanding importance for the German economy is undisputed.



The necessary confrontation of SMEs with big data analytics is obvious. Big data is generally a very young and complex research area, which is why in practice there are often more uncertainties regarding the handling, the concrete use as well as the potentials. Although it became clear that SMEs increasingly have problems with the subject of big data analytics (PwC, 2014), only very limited research and studies in the context of SMEs are available. This is why this research needs to be deliberately wide-ranging in order to gain the most comprehensive insights possible. The overall objective is therefore to create a holistic picture of big data analytics in SMEs.

## RESEARCH METHODOLOGY

Researchers can use methods of empirical data collection to describe the reality and investigate a special topic (Bortz and Döring, 2016). It is generally differentiated between two types of measurement and evaluation; quantitative and qualitative research methods (Brosius et al., 2012; Bryman and Bell 2015). Qualitative research interpretatively processes verbal or non-numerical data and often describes a complex phenomenon in its entire breadth. In contrast, the analysis of measured values in the quantitative approach is carried out statistically and numerically (Bortz and Döring, 2016; Brosius et al., 2012). Due to the uncertainty concerning big data in SMEs, quantitative research would be unrewarding since general knowledge needs to be explored first. Therefore, the acquisition of expert knowledge seems to be the best choice as the big data issue is discussed across all companies, but there is inadequate knowledge for SMEs and the research needs are therefore very extensive. For this reason, the expertise of experts will be the focus in order to identify and analyze the limited knowledge of big data in SMEs. This justifies the use of expert interviews, although authors like Fischer (2006), Sedlmeier and Renkewitz (2013) consider them as problematic because of the lack of the sample's representative status.

Expert interviews are part of the category of qualitative interviews (Bryman and Bell, 2015). Brosius et al. (2012), Alvesson and Ashcraft (2012) as well as Flick (2014) make clear that open questions are to be preferred in qualitative methods, because they lead to answers with larger amounts of text and thus to new knowledge. Due to the novelty of big data, it is advisable and necessary to interview experts from various areas. Thus the intention to obtain a holistic picture of the research object can be taken into account. A multi-perspective approach is selected for this purpose and company internal and external interviewees were chosen.

Within companies, the departments management control and IT are most likely responsible for big data. Therefore, experts from both departments were interviewed in order to obtain a comprehensive picture of big data regarding the company's internal situation. The internal interviewees are, in their entirety, employed in companies which apply to the defined subject of this study and meet the criteria.

On the company external side, experts from consultancies were interviewed. While those experts are not employed in the research subject of SMEs, they do have an extensive experience in business practice due to their advisory activities and thereby contribute a more practical approach. However, since these three areas are all derived from the corporate practice, experts from the theory-led field of science were also interviewed to obtain a holistic picture. In order to provide the same weighting to all four individual areas, three experts were interviewed per area. Following table 1 provides an overview of the functions of the selected twelve experts. The expert interviews took place in the period from June 29, 2015 to August 04, 2015. At the beginning, an additional test interview was carried out.

company internal perspective		company external perspective	
management control department	Commercial director and authorized signatory	consultancies	Senior manager, authorized signatory and head of big data and advanced analytics
	Team leader management control		Founder, owner and CEO
	Team leader finance and administrations, responsible for big data		Founder and CEO, leads expert sessions on the topic of big data
IT department	Head of IT	academics	Chairman of a standard committee, founder and CEO
	Head of IT and organization		Professor at a university, active member in various interest representatives
	Head of IT		Founder and owner of an institute for data analysis, lecturer at a university, leads various expert and discussion sessions

Table 17. Overview of selected experts

After conducting and transcribing the interviews, the information obtained will be evaluated. For an analysis of such large amounts of data obtained by expert interviews, the literature pleads for the method of qualitative content analysis (Mayring, 2016; Meuser and Nagel, 2005; Bryman and Bell 2015; White and Marsh 2006), which was also used.

## FINDINGS

### *Relevance of big data*

All experts clearly expressed that big data is very relevant to SMEs. They especially regard the increasing data volume as a signal to deal with big data analytics. Anyone who does not consider this in the future will have big problems with the doubling of the data volume every two years and will not

be able to master them anymore. Moreover, they agreed that SMEs are still very reluctant with regard to this topic and that there is a high potential for catching up.

Big data is often associated with negative aspects such as the espionage affair of the NSA around Edward Snowden. Nevertheless, the experts argued that the hype surrounding the buzzword “big data” was the stumbling block for awareness, which is why SMEs have become aware of the rapid development of data after all. This was also very urgent, since big data can have a strong impact on the competitiveness of SMEs. Competitive advantages can become particularly apparent when the company is in a severe recession. These newly acquired information and insights can help companies to overcome crises in order to free themselves from a crisis faster than competitors. Some experts even go so far that they consider the trend of big data as a possible factor in the market displacement of businesses.

The respondents further indicate that there is no industry that can be excluded with respect to the relevance of the current data development, as the newly gained information and the resulting findings can lead to an improved decision-making base for strategic orientations. Nevertheless, big data shows a higher relevance for such industries, which generate relatively large amounts of data. Due to data protection, big data is somewhat less relevant to companies who work with very sensitive personal data.

In addition, pioneering sectors have been mentioned, where big data is already very much addressed and applied in an advanced way. Driven by the external pressure of government and media with regard to “Industry 4.0” (high-tech strategy of German government), companies in manufacturing and other industries in particular are described as pioneering sectors. For example, big data can offer decisive benefit in mechanical engineering. With the increasing competition from countries such as China or India, it can help companies identify new cost savings potentials. Experts also see the sectors of trade, especially online trade, as extremely relevant, since a large number of electronic data, like the purchasing behavior of customers, are being generated.

Similar to the industry view, the interviewees also agreed that the impact of big data will be noticeable in all areas of the company, as there is a higher degree of interest in different analyses. Big data will have a particularly high impact on the areas of production and sales. For example, a great deal of data is generated throughout the production process. After processing and evaluation, quality controls can be optimized or production processes can be improved and monitored more effectively. Big data can also lead to an improvement in the predictions about the quality of products. In addition, the areas of marketing and management control were frequently mentioned. According to the experts, it will also have a strong influence on the IT, as it is responsible for providing the respective tools and has to discuss them with the relevant departments.

*Challenges and risks*

The experts consider big data with an enormous complexity for companies, therefore a correspondingly highly qualified work force is required to effectively deal with the topic. All experts, however, agree that a lack of professional staff is one of the main reasons for the lack of debate. Various aspects can be considered in the differentiation of this finding. On the one hand, there is a lack of expertise within the company to deal with the new kind of data analysis. In the opinion of the experts, highly qualified people in the field of big data need both, very specific technical IT knowledge and a well-developed business management understanding. This combination of specialists is currently very rare on the market and especially for SMEs very difficult to get. The experts also complain that the subject matter is so new that young academics and graduates have too few points of contact with big data analytics. Consequently, there is a lack of suitable specialists for data analysis in the high-end environment. Thus, many companies only have the opportunity to engage external consultants.

This leads to a further main problem in the opinion of the experts, the extremely high costs. Some of the interviewees said that in many SMEs the information and data analysis, as well as the IT infrastructure are below average, and do not have the necessary basic prerequisites for the successful engagement with big data. One expert described this metaphorically as an “investment backlog” of the past. Due to the increasing and especially abrupt new meaning of big data, this new awareness makes it clear to many companies that they need to invest a great deal of money in the near future. These high investment costs amount to external consultants, corresponding big data tools and software, but also the time of the engagement and thus the bound personnel costs. In this context, new staff is often unavoidable; some experts even advocate the creation of new departments.

Not only the recognition of the high costs, but also the question of a corresponding budget has to be considered. Most of the experts note that in SMEs, often no or very limited budget is provided for big data topics. In this context, an expert mentioned the often inadequate cost center structure in SMEs, which makes the allocation of budgets difficult. He described this as a non-existent “global cost center” that would benefit all sectors of the company.

Also the demands placed on the IT departments are growing ever further and many experts see an overloading of the IT in many SMEs. But the inclusion of this department is essential for big data.

Moreover, SMEs place great importance on data protection and, according to experts, are particularly sensitive to data handling. They are very skeptical towards big data technology innovations, especially cloud systems in the US. The reason is the fear of the lack of verifiability of access to such cloud systems, which is partly due to the negative associations against the background of the espionage scandal of the NSA by Edward Snowden. It leaves SMEs reluctant to deal with big data due to the opacity and lack of transparency of the scandal.

As a further not negligible aspect, some experts mention the prevailing demographic structures in SMEs. Many of the management positions are occupied by people of the so-called “baby boomer generation”. An expert described a large part of these persons metaphorically as “technological Neanderthals”. They are not accustomed to ever-changing technological changes and often find it difficult to adapt to the fast-moving and constantly changing technological innovations and to select the innovations relevant to their company. They are constantly confronted with new technologies - as is big data - and often do not deal with such modern topics because of the lack of knowledge and mental overload. Furthermore, some experts also referred to family enterprises, which are often run by comparatively very old owners, with a markedly lacking interest in the company management. The conservative mindset “everything as usual” is very strong and it is often difficult to convince elderly owners of the cost-benefit ratio of big data.

If SMEs do not deal with big data intensively in the near future, the experts see a number of risks. The interviewees see a strong to very strong competitive disadvantage, which can vary depending on the industry. If SMEs ignore big data’s possibilities, they cannot uncover weak spots in the company or possible cost advantages. Many experts also argued that a not confronting might have a negative impact on the market strength, or even lead to a possible insolvency, if the corresponding trends are not or too late taken into account due to the lack of information. Many SMEs often postpone dealing with big data due to the problems mentioned so far and choose a “follower strategy”. Considering the rapid data development, many experts see this as very dangerous. As there are already many first movers in different sectors, they strongly urge SMEs to follow as soon as possible. There is a high backlog demand for SMEs in this context. Especially industries in which many (customer) data are generated are severely affected. It can also have a significant impact on markets where disruptive technologies and innovations often dominate the market, as it is the case with electronics consumer goods. These risks, however, cannot be generalized, since they are often sectoral and market-related and must be examined individually.

Risks can also occur after the implementation of big data applications. Almost all experts see the main risk after the introduction of big data applications in the mere collection of data that is not used since many SMEs do not know what to do. Another risk is due to the complexity of such tools and the difficult data management. Many experts see a lack of personnel, which is familiar with the complex big data tools, and that often leads to improper handling.

Big data is characterized by the four properties of the data volume, variety, velocity and veracity. The experts agree without exception that the increase in data volume is noticeable in all companies, but the handling of the increasing amounts of data and their storage is not a big problem for SMEs anymore. Also the data velocity was only briefly mentioned as a possible problem by one of the experts.

Very often, however, data variety was mentioned as one of the biggest challenges for SMEs. Problems can arise in the processing of different data structures, i.e. the linking of unstructured, semi-structured and structured data, as well as the decision which data should be integrated into which business and decision-making processes. These must then be managed with new database technologies, which then again require corresponding knowledge and personnel. Likewise, the experts consider the veracity of data as particularly important and challenging. It has to be guaranteed and is regarded as the basic prerequisite for drawing decisive value from the information.

In order to address the challenges, the experts state the necessary requirements and prerequisites. Most of them suggested that a clear, structured big data strategy should be considered ahead of the preparation. Before SMEs are concerned with a mere, unconsidered accumulation of data, they should work through the following roadmap shown in Table 2, which results from the statements of the interviewed experts:

1.	Personnel-related questions
	Are there qualified employees? Do external people need to be involved in the big data strategy?
2.	Development of a data governance model
	Due to the high sensitivity of the data topic: Storage duration and usage, corresponding agreements from data protection points, protection against unauthorized data access.
3.	Creation of a data map
	What data is currently available to the company? What data can the company have additional access to, but does not yet save it?
4.	Data selection
	What are the most important and relevant data for the company from the potentially collectable data?
5.	Concreting and consolidation
	What added value should and can be achieved? A purposeful use must be defined in order to make relevant statements.

Table 18. *Roadmap*

The experts therefore recommend a retrograde approach. Specific questions are derived from the big data strategy in order to look at what a company wants to achieve in concrete terms by using big data. Only a clearly structured big data strategy leads to a useful information gain.

As a further prerequisite, the experts advocate for a future closer collaboration between IT and the departments that would like to gain new insights from big data. An expert summarized this in such a way that the previous “corporate IT departments” have to turn into “business IT departments”. In this function, they act as internal consultants and show the specialist departments which technical solutions are available for their needs.

Big data and the new methods of data analysis can lead to cross-sectoral changes. It can have strategic implications and influence processes, systems and structures. As a result, an effective change management has the task of informing employees about these innovations and preparing them accordingly. Whereas big data is a continuous process, data must always be up-to-date and, if

necessary, new data needs to be integrated. In addition, the data used must always be critically interrogated and adjusted.

#### *Opportunities and potentials*

The experts generally see an enormous potential for big data in SMEs. Due to the immense additional information, big data can add real value in all areas.

Big data technologies enable completely new possibilities to collect and analyze unused customer data as well as market data. In this context, the experts agree that the customer, and also the often closely connected market understanding, can be significantly improved. For example, it is possible to evaluate products and services more holistically through the new data. Thus, an earlier counter-reaction concerning poor ratings is possible (e.g. product enhancements). In addition, it is possible to better analyze customer needs. The questions “What does a consumer want?” or “What does a consumer need that he does not know yet?” are easier to answer, e.g. using unstructured and semi-structured social media monitoring data. Thus, trends in customer needs can be better recognized. In this context, the new findings of big data also enable better-customized products that are tailored to individual customers. It is also easier to find out how to use a product at the customer’s optimum level and which sales channels are the best to reach the individual customer. The mentioned aspects often result in an improvement in customer loyalty.

The interviewed experts also frequently stated that the new market forecasts also provide opportunities for SMEs to become active in new markets, as the additional data and information provide new insights of previously unused potentials. This can be based on entirely new business models, or on the possibility of entering with completely new products.

Not only on the external side, but also internally, the experts see a multitude of opportunities and potentials. Thus, a clear improvement and optimization of business processes in all areas were often mentioned. In addition, better and often faster decisions can be made, since the decision-making bases have holistic aspects based on correct data (veracity). Frequently, unused potential savings are becoming visible, e.g. in production. This can lead to an optimization of the production costs or an efficiency increase in the process, e.g. by early identification of waste. It would also be possible to use a “predictive maintenance” to make faster and more accurate statements as to when a machine fails or when its optimum maintenance period is. In addition, an increase in efficiency can be achieved with the use of raw materials or energy. Such resource conservation can sometimes be reflected in the reduction of throw-outs. Some experts argued that the above stated points, if used correctly, can all lead to an increase in turnover or profitability.

The potentials presented can offer real value added to SMEs in many respects. Insofar as companies consider the topic of big data as extremely important and want to use it in many areas, this often has a

wide impact in many areas of the company. The experts, who had taken this fact into account in their comments, would in this case advocate a linkage of the big data strategy to the company's objectives resp. strategies.

Due to the wide range of influence in the company, it also has a great influence on the business strategy. An enterprise-internal expert, in whose SME big data analytics already plays an important role and whose use is well advanced, called such a link as inevitable. In his experience only then the significance of the subject matter can be made clear to the employees.

SMEs have advantages over large companies in many areas, including the handling and implementation of big data. The flat hierarchies, which are often typical for SMEs, result in shorter decision-making processes. With regard to big data, this time factor makes itself noticeable with a faster release of the required budget. In addition, a first pilot project can be launched and implemented more quickly, as it is easier to bring together all project participants and project managers. This time factor plays an important role for SMEs and can bring decisive competitive advantages through the faster implementation of big data technologies.

After a big data project launch, another advantage of SMEs is their higher flexibility regarding necessary adjustments such as changes in the concept or an expansion of the budget. Furthermore, some experts mentioned that faster implementation leads to comparatively quicker and more decisive decisions, which can also bring competitive advantages.

As already stated in this study, big data is, in the opinion of the experts, relevant to all companies, but the intensity of the dispute is to be examined with regard to the meaningfulness in the individual case. In this respect, some experts have mentioned another advantage of SMEs: They examine the necessary investments for big data more precisely and question the meaningfulness significantly more than it is often the case in large companies.

### *Responsibility*

The experts agreed without exception, that the company's management is to be actively involved in the task of stepping up and supporting the topic within the company. Big data has to be pushed ahead from the highest level, as it is a strategically important topic. The management must therefore deal with it and take responsibility for the fact that it must bear and ensure not only the political but also the corporate responsibility. Through the active participation and conscious support, it can ensure a corresponding enforcement within the company. An expert who has already been involved in many big data projects in SMEs has pointed out that there is no other chance and that big data has to be "pressed into the company" by the management, since the issue is top priority. If the company management does not back it, the urgency and importance of the issue is not seen within the company.



When big data is specifically addressed within a company, the experts argue that the responsibility should not lie on a lower hierarchical level, but on the executive level. This seems conclusive, as they must release temporal resources, employees and other necessary means. The interviewees, however, do not agree in their statements which department can assume the overall responsibility for big data. Nevertheless, from the different statements two departments stand out: Some experts do not see the general responsibility at the IT department, but it is very important for the implementation and use of big data. It must provide the necessary systems and tools and generate the various data, although many of them lack the corresponding business background for the analysis (analytics). Here, the department of management control was often put into play, which is most likely to have the overall overview and the appropriate know-how for the evaluations. A few experts also argued that the responsibility of the evaluation does not have to lie with the management control departments, but with the individual areas in which big data is used. Certainly, both views are comprehensible and must be examined individually for the implementation of big data in a company.

By contrast, the interview partners agreed without exception that a big data initiative should not immediately implement the new technologies and applications companywide; rather, they advise that the complex issue shall be addressed by means of a small project or use case. Otherwise, there is a great danger of not being able to recognize a multitude of problems and thus the risk that the actually desired added value cannot be claimed. The goal of such first small use cases is the creation of awareness within the company as well as the identification of advantages and added values by the initiative. Other departments get ideas on the areas in which big data could be applied to them in a profitable way as well. After carrying out a suitable use case, it is also desirable to monetize the demonstrated advantage.

Big data is a complex issue that can have an enterprise-wide impact. For this reason, the experts clearly advocate an interdisciplinary project team for the big data initiative in order to get a holistic view. In any case, they consider it essential to involve the IT department, since it must act as an internal advisor for big data applications of the individual departments.

## CONCLUSIONS AND OUTLOOK

### *Conclusions*

From the findings of this study, it can be said that SMEs have to deal with the actual core of the topic - the current data development - in all its complexity. For them there is a considerable backlog and action demand with regard to big data analytics.

In terms of RQ 1, the doubling of the worldwide data volume every two years is scientifically proven and makes a prompt discussion with the topic big data unavoidable. In this context, large companies

are relatively early adopters of new data technologies. Due to the strong relevance for SMES, the quickest possible discussion is advisable in order not to lose any competitiveness in the future. If the new potentially generated data are not considered and used, the risk of a competitive disadvantage is high, as other competitors can gain clear market advantages through the information advantage. The extent to which big data has a more or less strong relevance in the individual sectors must be examined individually in advance.

Concerning RQ 2, the results show that due to the lack of professional personnel, especially SMEs are encouraged to acquire the necessary professional know-how as soon as possible either internally through appropriate continuing learning or, if necessary, (additionally) through external consultants. This is essential because the new big data technologies are far more complex than the previous applications and require corresponding knowledge. After the perception is created within a company, the advantages are pointed out and corresponding projects are regarded as worthwhile, SMEs are often faced with the increased investment costs. These should, however, not only be seen in the short but in the longer term, since big data is a strategically important topic.

Data protection plays an important role especially in SMEs and is often treated very critically. It is therefore recommended to develop and implement a corresponding data governance model that regulates the core points of data protection and the legal and ethical handling of sensitive and personal data.

Regarding RQ 3, the inclusion of the company's management is particularly important in the case of SMEs, since big data can influence all company segments and bring corresponding values there. It is also a strategically important issue. For the first discussion of the topic, it is advisable to set up an interdisciplinary big data initiative.

Big data is a topic that also affects the IT department very much due to the new technologies. Accordingly, there must be a closer and more trusting collaboration between the relevant departments and the IT. The latter has to be more strongly understood as "business IT", which increasingly serves as an internal consultant for the respective needs of the departments.

### *Outlook*

The qualitative study has shown a holistic view of big data's current situation in small and medium-sized enterprises and has thus generated a first impression. This was based - due to the lack of studies specifically on SMEs - on the generation of additional knowledge by experts. Now this impression can be refined, for example by a higher number of interviews. It is also possible to extend the present work by quantitative methods and to use the results as the basis on which a quantitative analysis can be built on.

The focus of this study was on the business background. However, the technological area or the intensive examination of specific IT technologies was less addressed. Further research needs can be undertaken here by carrying out an intensive investigation and evaluation of possible big data solutions by means of IT technologies, software or other tools.

## REFERENCES

- Alvesson, M. and Ashraft, K. L. (2012), "Interviews", in Symon, G. and Cassell, C. (Eds.), *Qualitative Organizational Research: Core Methods and Current Challenges*, Sage, London, pp. 239-257.
- BARC (Business Application Research Center) (2014), "Big data Analytics 2014", available at [http://www.exasol.com/fileadmin/content-de/pdf/Studien/BARC\\_Big\\_Data\\_Analytics\\_2014.pdf](http://www.exasol.com/fileadmin/content-de/pdf/Studien/BARC_Big_Data_Analytics_2014.pdf) (accessed 06 February 2017).
- Baumöl, U. and Berlitz, P.-D. (2014), "Big Data – Neue Wege der Entscheidungsunterstützung", in Gleich, R. and Klein, A. (Eds.), *Controlling und Big Data*, Haufe, Freiburg and Munich, pp. 159-176.
- Becker, W., Staffel, M. and Ulrich, P. (2008), *Mittelstand und Mittelstandsforschung*, Deloitte Mittelstandsinstitut, Bamberg.
- Becker, W., Ulrich, P., Botzkowski, T. and Eurich, S. (2015), "Data Analytics in Familienunternehmen – Implikationen für das Controlling", *Controlling – Zeitschrift für erfolgsorientierte Unternehmenssteuerung*, Vol. 27, No. 4/5, pp. 263-268.
- Bendler, J., Wagner, S., Brandt, T. and Neumann, D. (2014), "Taming Uncertainty in Big Data", *Business and Information Systems Engineering*, May 2014, pp. 279-288.
- Berman, J. (2013), *Principles of Big Data*, Morgan Kaufmann, Waltham.
- BITKOM (2014a), "Leitfaden Big-Data-Technologien - Wissen für Entscheider", available at <https://www.bitkom.org/Bitkom/Publikationen/Big-Data-Technologien-Wissen-fuer-Entscheider.html> (accessed 06 February 2017).
- BITKOM (2014b), "Potenziale und Einsatz von Big Data – Ergebnisse einer repräsentativen Befragung von Unternehmen in Deutschland", available at [https://www.bitkom.org/files/documents/Studienbericht\\_Big\\_Data\\_in\\_deutschen\\_Unternehmen.pdf](https://www.bitkom.org/files/documents/Studienbericht_Big_Data_in_deutschen_Unternehmen.pdf) (accessed 06 February 2017).
- BMW (2014), "German Mittelstand: Motor der deutschen Wirtschaft. Zahlen und Fakten zu deutschen mittelständischen Unternehmen", available at [http://www.midasgruppe.de/uploads/media/German\\_Mittelstand\\_Motor\\_der\\_deutschen\\_Wirtschaft\\_-\\_BMW.pdf](http://www.midasgruppe.de/uploads/media/German_Mittelstand_Motor_der_deutschen_Wirtschaft_-_BMW.pdf) (accessed 06 February 2017).
- Bortz, J. and Döring, J. (2016), *Forschungsmethoden und Evaluation in den Sozial- und Humanwissenschaften*, 5th ed., Springer, Heidelberg.
- Britzelmaier, B., Thiel, C. and Kraus, P. (2009), "Controlling in Practice – an empirical study among Small and Medium-sized Enterprises in Germany", in Vrontis, D., Weber, Y., Kaufmann, R. and Tarba, S., *Managerial and Entrepreneurial Developments in the Mediterranean Area*, EuroMed Press, Cyprus, pp. 335-348.
- Brosius, H.-B., Haas, A. and Koschel, F. (2012), *Methoden der empirischen Kommunikationsforschung*, 6th ed., Springer, Wiesbaden.
- Bryman, A. and Bell, E. (2015), *Business Research Methods*, 4th ed., Oxford University Press, Oxford.
- Bundesrechenzentrum (2015), "White Paper – Big data in der öffentlichen Verwaltung", available at [https://www.brz.gv.at/downloads/studien/2015-03-30\\_Big\\_Data\\_in\\_der\\_oeffentlichen\\_Verwaltung\\_v1.2\\_pub.pdf?4vh7le.pdf](https://www.brz.gv.at/downloads/studien/2015-03-30_Big_Data_in_der_oeffentlichen_Verwaltung_v1.2_pub.pdf?4vh7le.pdf) (accessed 06 February 2017).
- Burow, L., Leyk, J. and Briem, C. (2014), "Experten-Interview zum Thema Controlling und Big Data", in Gleich, R. and Klein, A. (Eds.), *Controlling und Big Data*, Haufe, Freiburg and Munich, pp. 13-20.
- Curran, J. and Blackburn, R.A. (2001), *Researching the Small Enterprise*, Sage, London.
- Davenport, T. (2014), *Big Data @ Work. Dispelling the Myths, Uncovering the Opportunities*, Harvard Business School Review Press, Boston.
- Deloitte (2014), "Data Analytics im Mittelstand", available at <http://www2.deloitte.com/content/dam/Deloitte/de/Documents/Mittelstand/studie-data-analytics-im-mittelstand-deloitte-juni-2014.pdf> (accessed 06 February 2017).
- Dorschel, J. (2015), *Praxishandbuch Big Data*, Springer, Wiesbaden.

- Dumbill, E. (2012). "What Is Big data?", in Dumbill, Edd (Ed.), *Planning for Big data – A CIO's Handbook to the Changing Data Landscape*, O'Reilly Media, Sebastopol.
- European Commission (2014), "European Commission Annual Report on European SMEs 2013/2014", available at [http://ec.europa.eu/enterprise/policies/sme/facts-figures-analysis/performance-review/files/supporting-documents/2014/annual-report-smes-2014\\_en.pdf](http://ec.europa.eu/enterprise/policies/sme/facts-figures-analysis/performance-review/files/supporting-documents/2014/annual-report-smes-2014_en.pdf).
- European Commission (2003), "Commission recommendation of 6 May 2003 concerning the definition of micro, small and medium-sized enterprises", available at <http://eur-lex.europa.eu/LexUriServ/LexUriServ.do?uri=OJ:L:2003:124:0036:0041:EN:PDF> (accessed 06 February 2017).
- Experton Group (2012), "Datenexplosion in der Unternehmens-IT – Wie Big Data das Business und die IT verändert", available at [http://www.globalservices.bt.com/static/assets/pdf/campaign/germany/BT%20Whitepaper\\_BigData\\_Experton.pdf](http://www.globalservices.bt.com/static/assets/pdf/campaign/germany/BT%20Whitepaper_BigData_Experton.pdf) (accessed 06 February 2017).
- Fasel, D. (2014), "Big Data – Eine Einführung", in Fasel, D. and Meier, A. (Eds.), *Big Data*, Springer, Wiesbaden, pp. 386-400.
- Feindt, M. and Grüssing, D. (2014), "Strategische Entscheidungen mit automatisierten Prognosen operativ umsetzen", in Gleich, R. and Klein, A. (Eds.), *Controlling und Big Data*, Haufe, Freiburg and Munich, pp. 177-188.
- Fischer, T. (2006), *Unternehmenskommunikation und Neue Medien*, DUV, Wiesbaden.
- Flick, U. (2014), *An Introduction to Qualitative Research*, 5th ed., Sage, London.
- Fraunhofer Institut für intelligente Analyse- und Informationssysteme (2012), *Big Data – Vorsprung durch Wissen. Innovationspotenzialanalyse*, Sankt Augustin.
- Gänßlen, S. and Losbichler, H. (2014), "Big Data – ein Segen für das Controlling? ICV White Paper", available at <http://www.ar-reporting.de/static/2015/02/150215Big-Data-Whitepaper.pdf> (accessed 06 February 2017).
- Grönke, K. and Heimel, J. (2015), "Big Data im CFO-Bereich – Kompetenzanforderungen an den Controller", *Controlling – Zeitschrift für erfolgsorientierte Unternehmenssteuerung*, Vol. 27, No. 4/5, pp. 242-248.
- Grönke, K., Kirchmann, M. and Leyk, J. (2014), "Big Data: Auswirkungen auf Instrumente und Organisation der Unternehmenssteuerung", in Gleich, R. and Klein, A. (Eds.), *Controlling und Big Data*, Haufe, Freiburg and Munich, pp. 63-82.
- Horváth, P. and Aschenbrücker, A. (2014), "Data Scientist: Konkurrenz oder Katalysator für den Controller?", in Gleich, R. and Klein, A. (Eds.), *Controlling und Big Data*, Haufe, Freiburg and Munich, pp. 47-62.
- Institut für Mittelstandsforschung (IfM) Bonn (2016), "Mittelstandsdefinition", available at <http://www.ifm-bonn.org/definitionen/mittelstandsdefinition-des-ifm-bonn/> (accessed 06 February 2017).
- Internationaler Controller Verein (ICV) (2014), "Big Data. Potenzial für den Controller. Dream Car der Ideenwerkstatt im ICV 2014", available at [http://www.icv-controlling.com/fileadmin/Assets/Content/AK/Ideenwerkstatt/Files/ICV\\_Ideenwerkstatt\\_DreamCar-Bericht\\_BigData.pdf](http://www.icv-controlling.com/fileadmin/Assets/Content/AK/Ideenwerkstatt/Files/ICV_Ideenwerkstatt_DreamCar-Bericht_BigData.pdf) (accessed 06 February 2017).
- Kaufmann, M. (2014), "Die Geister die wir riefen", in Fasel, D. and Meier, A. (Eds.): *Big Data*, Springer, Wiesbaden, pp. 383-385.
- King, S. (2014), *Big Data. Potential und Barrieren der Nutzung im Unternehmenskontext*, Springer, Wiesbaden.
- KPMG (2014), "Ein Meer an Daten – Ein Mehr an Wissen. Empirische Studie zum Einsatz von Big Data", available at <https://home.kpmg.com/de/de/home/themen/2014/11/studie-meer-daten-mehr-wissen.html> (accessed 06 February 2017).
- Laney, D. (2001), "3D Data Management: Controlling Data Volume, Velocity, and Variety", in META Group Inc. (Ed.), *Application Delivery Strategies*, available at <http://blogs.gartner.com/doug-laney/files/2012/01/ad949-3D-Data-Management-Controlling-Data-Volume-Velocity-and-Variety.pdf> (accessed 06 February 2017).
- Mac an Bhaird, C. (2010), *Resourcing Small and Medium Sized Enterprises*, Springer, Berlin and Heidelberg.
- Mayer-Schönberger, V. (2015), "Was ist Big Data? Zur Beschleunigung des menschlichen Erkenntnisprozesses", *APuZ – Aus Politik und Zeitgeschichte*, Vol. 65, pp. 14-19.
- Mayring, P. (2016), *Einführung in die Qualitative Sozialforschung*, 6th ed., Beltz, Weinheim and Basel.
- McAfee, A. and Brynjolfsson, E. (2012), "Besser Entscheiden mit Big Data", *Harvard Business Manager*, November 2012, pp. 22-30.
- McKinsey (2011), *Big Data: The next frontier for innovation, competition, and productivity*, McKinsey Global Institute, Lexington.
- Meuser, M. and Nagel, U. (2005), "ExpertInneninterviews – vielfach erprobt, wenig bedacht", in Bogner, A., Littig, B. and Menz, W. (Eds.), *Das Experteninterview – Theorie, Methoden, Anwendung*. 2nd ed., Leske and Budrich, Opladen, pp. 71-93.
- Michel, U., Aschenbrücker, A. und Horváth, P. (2015), "Big Data – Potenzial für den Controller", *Controlling – Zeitschrift für erfolgsorientierte Unternehmenssteuerung*, Vol. 27, No. 2. pp. 103-106.

- Miele, S. and Shockley, R. (2013), "Analytics: The real-world use of big data. Studie des IBM Institute for Business Value", available at [http://www.ibm.com/services/multimedia/Analytics\\_The\\_real\\_world\\_use\\_of\\_big\\_data\\_in\\_Financial\\_services\\_Ma\\_i\\_2013.pdf](http://www.ibm.com/services/multimedia/Analytics_The_real_world_use_of_big_data_in_Financial_services_Ma_i_2013.pdf) (accessed 06 February 2017).
- Press, G. (2013), "A Short History of Big Data", Forbes Magazine Online, available at <http://www.forbes.com/sites/gilpress/2013/05/09/a-very-short-history-of-big-data/> (accessed 06 February 2017).
- PwC (2014), "Revolution Big Data. Eine Studie über das Thema Big Data und Data Analytics", available at [https://www.pwc-wissen.de/pwc/de/shop/publikationen/?page=2&sort\\_by=ranking](https://www.pwc-wissen.de/pwc/de/shop/publikationen/?page=2&sort_by=ranking) (accessed 06 February 2017).
- Reinemann, H. (2011), *Mittelstandsmanagement. Einführung in Theorie und Praxis*, Schaeffer-Poeschel, Stuttgart.
- Roßmeißl, E. and Gleich, R. (2014), "Industrie 4.0: Neue Aufgaben für Produktionsmanagement und -controlling", in Gleich, R. and Klein, A. (Eds.), *Controlling und Big Data*, Haufe, Freiburg and Munich, pp. 141-156.
- Schäfer, W. (2004), "Die Kennzeichen des Mittelstands", Handelsblatt, available at <http://www.handelsblatt.com/unternehmen/mittelstand/was-sind-eigentlich-kleine-und-mittlere-unternehmen-die-kennzeichen-des-mittelstands/2303966.html> (accessed 06 February 2017).
- Schroek, M., Shockley, R., Smart, J., Romero-Morales, D. and Tufano, P. (2012), "Analytics: Big Data in der Praxis. Studie des IBM Institute for Business Value", available at <http://www-935.ibm.com/services/de/gbs/thoughtleadership/GBE03519-DEDE-00.pdf> (accessed 06 February 2017).
- Sedlmeier, P. and Renkewitz, F. (2013), *Forschungsmethoden und Statistik*, 2nd ed., Pearson, Munich.
- Seufert, A. (2014), "Das Controlling als Business Partner: Business Intelligence und Big Data als zentrales Aufgabenfeld", in Gleich, R. and Klein, A. (Eds.), *Controlling und Big Data*, Haufe, Freiburg and Munich, pp. 23-45.
- Statistisches Bundesamt (2012), "Beschäftigtenzahl im Mittelstand", available at <https://www.destatis.de/DE/ZahlenFakten/GesamtwirtschaftUmwelt/UnternehmenHandwerk/KleineMittlereUnternehmenMittelstand/Aktuell.html> (accessed 06 February 2017).
- Stockinger, K. and Stadelmann, T. (2014), "Data Science für Lehre, Forschung und Praxis", in Fasel, D. and Meier, A. (Eds.), *Big Data*, Springer, Wiesbaden, pp. 469-479.
- Vierkorn, S., Weber, A. and Kolb, M. (2014), "Big Data – Zukunftsmusik oder gelebte Realität?", *Controller Magazin. Software-Kompendium 2014/2015*, No. 5, pp.10-14.
- Weber, J. (2014), "Controller & Big Data", *Controller Magazin*, Vol. 39, No. 5, p. 27.
- White, M. D., and Marsh, E. E. (2006), "Content Analysis: A flexible Methodology", *Library Trends*, Vol. 55, No. 1, pp. 22-45.

## PROMOTING INTERNET USAGE: AN ANALYSIS OF NONUSERS

Teerakapibal, Surat

Department of Marketing, Thammasat Business School, Thammasat University, Bangkok, Thailand

### ABSTRACT

Extant literatures associate Internet usage rate with economic growth by analyzing data on Internet users. However, developing mechanisms to foster Internet use based on users alone may be misleading. Therefore, this study aims to investigate the underlying reason for why individuals are not using the Internet via an analysis of nonusers. The logistic regression model is estimated to fit Thai survey data which was administered to citizens across regions (Bangkok, Central, North, Northeast, and South) and area of residence (Municipal, Non-municipal) from 2013 to 2016. Empirical results illustrate the importance of urbanization in determining Internet usage rate. Interestingly, parameter estimates suggest that individuals decline to use the Internet because they do not know how to use it as opposed to limitation of broadband infrastructure or high cost of access. Managerial implications are then discussed.

*Keywords: Internet Usage; Digital Divide, Nonusers, Logistic Regression.*

### INTRODUCTION

Benefits of the Internet have been realized by citizens virtually everywhere in the world (Robey, Gupta and Rodriguez-Diaz, 1990; UNCTAD, 2001). Not only is it able to eliminate limitations due to geographical boundaries, the Internet provides communication at a minimal cost. Only a couple of decades earlier, the global penetration rate of the Internet was merely 1 percent. This figure has grown at a rapid rate to reach 40 percent in 2016 (Internet Live Stats, 2016). Arguably, the Internet is the backbone of the digital era. Accordingly to Frederick (2016), approximately 19 percent of smart phone owners in the United States participates in e-commerce with their mobiles, a striking 61 percent year-over-year increase. At the global scale, Statistia (2016) forecasted that the B2C e-commerce sales worldwide account for 1.7 trillion U.S. dollars in 2015. Furthermore, this figure is expected to reach over 2.4 trillion U.S. dollars in 2018.

With its importance on economic growth, nations places Internet usage rate among first priorities (Chen, Gillenson, and Sherrel, 2002; Teo, Lim, and Lai, 1999; Wang *et al.*, 2003). For instance, Brazil government aims to provide access to broadband for 50 out of every 100 households (World Bank Group, 2016). Malaysia, on the other hand, sets a goal to realize the broadband penetration rate of 75 percent (World Bank Group, 2016). Consequently, governments employ various mechanisms to

promote Internet use among its citizens with the objective to bolster its economic expansion. In particular, Chile adopted a national broadband strategy to drive advancements in information and communication technology (World Bank Group, 2016). In the United Kingdom, 1.5 billion pounds were spent to construct digital infrastructure (Curtis, 2015).

Though the Internet provides numerous benefits, its positive influences does not uniformly reach all individuals. This phenomenon has been named the “digital divide.” In particular, extant researches documented that those with higher education level, income level, residing in urban areas, greater resources will not only have better access to the Internet but will also be able to exploit its benefits in comparison to their less fortunate counterparts (Anderson *et al.*, 1995; Benton Foundation, 1998; Hoffman and Novak, 1998, 1999; Pew Center for the People and the Press, 1995; Strover, 1999). This ultimately raises a concern as to whether the Internet will promote equality or widen the inequality gap.

While extant researches focus on examining users of the Internet, this paper aims to shed light on how to effectively promote Internet usage by analyzing nonusers instead. In particular, the objective of this paper is to answer the following research questions:

1. What are the main obstacles to access the Internet?
2. Does urbanization determine Internet usage rate?

Understanding the underlying cause(s) of not using the Internet will allow policy makers to employ appropriate mechanisms to improve Internet usage rate. This should in turn help fostering economy both at the national and global level.

The rest of the paper is organized as follows. In the next section, I describe the survey data utilized in the analysis. The logistic regression model is then explained. Next, I present the empirical results. Finally, I conclude with discussions and conclusions.

## DATA AND METHODOLOGY

### *Data*

As the objective of this paper is to examine the determinants of nonusers, it requires that the data must come from a market where access to the Internet has not reached the maturity stage at the time when data is initially collected. Therefore, Thai macroeconomic data are used for the analysis. In terms of Internet usage, more than 38 million Thais currently are able to access the Internet. This figure has grown tremendously from merely 26 million in 2013.

This paper utilizes the annual number of Thai Internet nonusers by regions (Bangkok, Central, North, Northeast, South), area of residence (Municipal Area, Non-municipal Area), and reasons for not

using the Internet (Don't know how to use, Not interested in using, Access to the Internet is too expensive, No equipment to access the Internet with, No broadband infrastructure in the area, other) from 2013 to 2016, made available by the Thai National Statistical Office. The data is collected by the Ministry of Information and Communication Technology via the Information and Communication Technology survey.

#### Model

Let  $nonusers_{ijt}$  be the number of nonusers of the Internet in region  $i \in \{Bangkok, Central, North, Northeast, South\}$ , living in area  $j \in \{Municipal Area, Non - municipal Area\}$ , at time  $t$  and  $population_{ijt}$  be the number of residents in region  $i$ , living in area  $j$ , at time  $t$ . The log-odd of being a nonuser is defined by:

$$\log\left(\frac{nonusers_{ijt}}{population_{ijt}}\right) = \alpha + \gamma R_i + \delta A_j + \beta X_{ijt} + \varepsilon_{ijt} \quad (1)$$

where  $\alpha$  is an intercept term representing intrinsic log-odd of being a nonuser. This implies that a negative intercept would mean that people are more likely to use the Internet in absence of exploratory variables. On the other hand, a positive intercept would imply otherwise.  $\gamma$  captures the effect of region on Internet usage decision.  $\delta$  measures the impact of urbanization on Internet usage. Here,  $A_j$  takes on the value of 1 if the area is a municipal area, and 0 if otherwise. Notably, municipal area is more urbanized.  $\beta$  measures the extent to which each reason ( $X$ ) contributes to the decision to not use the Internet. Lastly,  $\varepsilon_{ijt}$  is the random error term which is assumed to follow binomial distribution.

Parameter estimation was conducted using SAS statistical package. The GENMOD procedure fits the logistic regression by the method of maximum likelihood.

## EMPIRICAL RESULTS

#### Model Fit

Criterion	
AIC	12084018
BIC	12084055
Log Likelihood	-323243437

Table 1: *Fit Statistics*

To assess goodness of fit, we employ three distinct measures: log-likelihood, Akaike information criterion (*AIC*), and Bayesian information criterion (*BIC*). *AIC* is developed by Hirotugu Akaike (1974) and is defined by:



$$AIC = 2k - 2 \log LL \quad (2)$$

*BIC* (Schwarz, 1978), on the other hand, can be written as:

$$BIC = -2 \log LL + k \log n, \quad (3)$$

where  $k$  denotes the number of parameters in the statistical model,  $LL$  represents the maximized value of the likelihood function for the estimated model, and  $n$  denotes the number of observations. Log-likelihood, *AIC*, and *BIC* are calculated to be -323243437, 12084018, and 12084055, respectively.

#### Parameter Estimates

Parameter	Estimate	Std. Err.	Wald Chi-Square	P-value
<b>Intercept</b>	<b>-7.3284</b>	0.0022	11010000	<0.0001
<b>Region</b>				
Central	<b>0.2103</b>	0.0004	260348	<0.0001
North	<b>0.2292</b>	0.0004	273345	<0.0001
Northeast	<b>0.1953</b>	0.0004	218415	<0.0001
South	<b>0.1552</b>	0.0005	115714	<0.0001
Bangkok	0.0000	0.0000		
<b>Area of Residence</b>				
Municipal Area	0.0000	0.0000		
Non-municipal Area	<b>0.0958</b>	0.0002	176306	<0.0001
<b>Reason for not using the Internet</b>				
Don't know how to use	<b>6.7126</b>	0.0022	9513115	<0.0001
Not interested in using	<b>5.6365</b>	0.0022	6694167	<0.0001
Access to the Internet is too expensive	<b>1.6301</b>	0.0024	470195	<0.0001
No equipment to access the Internet with	<b>2.2788</b>	0.0023	996541	<0.0001
No broadband infrastructure in the area	<b>0.4553</b>	0.0028	26864	<0.0001
Other	0.0000	0.0000		

\* *Boldface denotes estimates which are statistically significantly different from zero at the significance level of 0.05*

Table 2: *Parameter Estimates*

Empirical results show that individuals are generally inclined to use the Internet as the intercept is negative (-7.3284) and statistically significant at the 0.05 level. Variation of Internet usage rate is also evident across regions and area of residence. Results illustrate that Bangkok, the capital of Thailand, is the area where Internet usage is prominent. Proportion of citizens who refuse to use the Internet is much larger in the Central, North, Northeast, and South regions of Thailand (0.2103, 0.2292, 0.1953, and 0.1552, respectively). Moreover, there are fewer nonusers in municipal area as the estimated coefficient for non-municipal area is found to be positive (0.0958) and statistically significant at the 0.05 level.

The focal variables of the analysis are the reasons why people choose not to use the Internet. Based on the Wald Chi-Square statistics, the most prominent reason is found to be "Don't know how to use" (6.7126), followed by "Not interested in using" (5,6365), "No equipment to access the Internet with" (2.2788), "Access to the Internet is too expensive" (1.6301), and "No broadband infrastructure in the area" (0.4553).

## DISCUSSIONS AND CONCLUSIONS

The potential of the Internet has urged governments to promote the use of Internet among their citizens. Various mechanisms have been employed to boost the Internet usage rate. However, there are still significant number of nonusers around the world. Most studies focus on analyzing Internet users in order to uncover the determinants for usage. This paper attempts to shed light on the issue with an opposite approach. Using the Thai macroeconomic data, I examine to underlying reason for individuals' reluctance to get online.

Empirical results reveal that the most prominent reason for nonusers is the skills to use the Internet, whereas the limitation of broadband infrastructure in the area and price of Internet service come in last. This implies that governments should shift their focus from expanding infrastructure to training courses. Equipping nonusers with skills to exploit the benefits of the Internet would be effective in shifting nonusers to the user segment. Moreover, interest in using the Internet is also another reason for why individuals refuse to use the Internet. This suggests that policy makers should be proactive in communicating benefits of the Internet to citizens. In addition, providing citizens with equipments to access the Internet with would also foster Internet usage. In addition, this paper reinforces the claim made by extant researches that urbanization plays an important role in determining Internet usage. In sum, this paper contributes to both literatures and practitioners. Based on empirical results, I propose the priority of actions in promoting Internet usage.

## REFERENCES

- Akaike, H. (1974). "A New Look at the Statistical Model Identification," *IEEE Transactions on Automatic Control*, Vol. 19 No. 6, pp. 716-723.
- Anderson, R. H., Bikson, T. K., Law, S. A., and Mitchell, B. M. (1995). *Universal Access to E-mail – Feasibility and Societal Implications*. Santa Monica, CA: RAND.
- Benton Foundation (1998). *Losing Ground Bit by Bit: Low-income Communities in the Information Age*. Washington DC: Benton Foundation and National Urban League.
- Chen, L. D., Gillenson, M. L., and Sherrel, D.L. (2002), "Enticing Online Consumers: An Extended Technology Acceptance Perspective," *Information & Management*, Vol. 39 No. 8, pp. 705-719.
- Curtis, S. (2015). "Government Maps Public Infrastructure to Encourage Use by Internet Providers," available at: <http://www.telegraph.co.uk/technology/broadband/11384762/Government-maps-public-infrastructure-to-encourage-use-by-internet-providers.html> (accessed 1 March 2017).
- Frederick, J. (2016). "5 Key 2016 eCommerce Trends," available at: <http://www.pfsweb.com/blog/5-key-2016-e-commerce-trends/> (accessed 1 March 2017).
- Hoffman, D. L., and Novak, T. P. (1998). "Bridging the Racial Divide on the Internet." *Science*.
- (1999). *Examining the Relationship of Race to Internet Access and Usage over Time*. Working Paper. Nashville, Tenn: eLab Manuscripts, Vanderbilt University.
- Internet Live Stats (2016). "Internet Users," available at: <http://www.internetlivestats.com/internet-users/> (accessed 1 March 2016).
- Pew Center for the People and the Press. (1995). "Technology in the American Household. Washington DC," available at: <http://www.people-press.org/tech.htm> (accessed 1 March 2017).
- Robey, D., Gupta, S. and Rodriguez-Diaz, A. (1990). "Implementing Information Systems in Developing Countries: Organizational and Cultural Considerations," in S. Bhatnagar & N. Bjorn-Anderson (eds.), *Information and Technology in Developing Countries*, Amsterdam.

- Schwarz, G. (1978). "Estimating the Dimension of a Model," *The Annals of Statistics*, Vol. 6 No. 2, pp. 461-464.
- Statista (2016). "B2C e-commerce sales worldwide from 2012 to 2018," available at: <http://www.statista.com/statistics/261245/b2c-e-commerce-sales-worldwide/> (accessed 1 March 2017).
- Strover, S. (1999). *Rural Internet Connectivity*. Columbia, MO: Rural Policy Research Institute.
- Teo, T., Lim, V., and Lai, R. (1999). "Intrinsic and Extrinsic Motivation in Internet Usage," *Omega International Journal of Management Science*, Vol. 27, pp. 25-37.
- UNCTAD (2001), "E-commerce and Development Report 2001," available at <http://www.unctad.org/eCommerce> (accessed 1 March 2017).
- Wang, Y, Wang, Y., Lin, H, and Tang, T. (2003), "Determinants of User Acceptance of Internet Banking: An Empirical Study," *International Journal of Service Industry Management*, Vol. 14 No. 5, pp. 501-519.
- World Bank Group (2016). "The Role of Government: The Public Sector's Evolving Role in Broadband," available at <http://broadbandtoolkit.org/2.2> (accessed 1 March 2017).

## MANDATORY DISCLOSURE OF NON-FINANCIAL INFORMATION: A STRUCTURED LITERATURE REVIEW

Testarmata, Silvia; Sergiacomi, Silvia; Fortuna, Fabio

Department of Business and Economics, Niccolò Cusano University, Rome, Italy

### ABSTRACT

This paper reviews the field of mandatory disclosure of non-financial information (<MDNFI>) to develop insights into how <MDNFI> research is developing, offer a critique of the research to date, and outline future research opportunities. We find that most published <MDNFI> research presents normative arguments for <MDNFI> and there is little research examining <MDNFI> practice. Thus, we call for more research that critiques <MDNFI>'s rhetoric and practice. Thus, this paper offers an insightful critique into an emerging accounting issue.

*Keywords: mandatory disclosure of non-financial information, structured literature review, external reporting.*

### INTRODUCTION

Corporate Social Responsibility (CSR) has become a well-established concept whereby companies integrate social, environmental, ethical human rights and consumer concerns into their business operations and core strategy in close cooperation with their stakeholders (EU, 2011a). As defined by the European Commission, CSR is “the responsibility of enterprises for their impacts on society” (EU, 2011b, p. 6).

According to the triple bottom line approach, CSR outcomes encompass economic, social and environmental dimensions (Elkington, 1998). Economic responsibility references a company's contribution to the on-going viability of the larger economic system. Social responsibility considers the company's impact on the local communities in which it operates, ranging from corporate philanthropy to providing safe working conditions. Environmental responsibility regards a company's effect on the physical environment (Testarmata, Fortuna, Ciaburri, 2015).

In turn, companies have rapidly entered a dialogue with their stakeholders to communicate their CSR initiatives and interventions and their impacts on society (Freeman and Moutchnik, 2013; Gibson, 2012; Gray *et al.*, 1995; Morsing and Schultz, 2006).

Prior research has noted the role of corporate disclosure in sharing CSR initiatives with stakeholders (e.g., Branco and Rodrigues, 2007; De Bakker *et al.*, 2005; Parker, 2011). The early research on CSR disclosure has primarily focused on financial reports (Deegan and Gordon, 1996; Gray *et al.*, 1995; Gray

*et al.*, 1987; Guthrie and Mathews, 1985). Afterwards, studies have shifted their focus on voluntary non-financial reports such as social and environmental reports (Crawford and Clark Williams, 2011; Deegan *et al.*, 2002; GBS, 2013; Gray *et al.*, 1996; Guthrie and Parker, 1990; Roberts, 1991), sustainability reports (United Nations Global Compact, 2009; GRI, 2013; Gray, 2010; Kolk, 2004) and integrated reports (Busco *et al.*, 2013; Cheng *et al.*, 2014; Dumay, 2016; IIRC, 2013, Eccles and Krzus, 2010). Over the last decade, research has begun to analyse the Internet as new tool for communicating with stakeholders (Campbell and Beck, 2004; Frost, 2005; Patten and Crampton, 2004; Williams and Pei, 1999). More recently, research has noted that in the digital age corporations are rapidly expanding their use of social media (such as Facebook, LinkedIn, and Twitter) as an instrument for corporate disclosure (see, Dumay, 2017; Alexander and Gentry, 2014; Jung *et al.*, 2014; Paniagua and Sapena, 2014; SEC, 2013; Zhou *et al.*, 2015).

Despite there being continual calls for over 40 years for the inclusion of additional information for investors beyond the financial in external disclosure and reporting, there is still no framework that has succeeded in achieving this end (Milne and Gray, 2013). The importance of divulging non-financial information such as social and environmental factors was recognized by EU, that issued the EU Directive 2014/95 as regards mandatory disclosure of non-financial and diversity information by certain large undertakings and groups.

Considering the fragmented development of the disclosure of non-financial information and its move from a voluntary approach to a mandatory approach, it would be interesting to see how academia is responding through research into the mandatory disclosure of non-financial information (<MDNFI>). Stemming from these considerations, the purpose of the paper is to provide an overview of the current state of the literature by developing a structured literature review (Massaro, Dumay and Guthrie, 2016) on <MDNFI>.

## METHODOLOGY

Our research examines the <MDNFI>'s research foundations, so that we can establish the focus of <MDNFI> literature and offer some insights into how it may develop in the future. For this paper we use the structured literature review (<SRL>) methodology as developed by Massaro, Dumay and Guthrie (2016), that is a method for studying a corpus of scholarly literature, to develop insights, critical reflections, future research paths and research questions.

Massaro *et al.*, (2016, p. 769) argue that:

*[...] for experienced academic researchers an SLR offers an alternative approach that can either confirm one's knowledge or open up new avenues for research to which the traditional approach may not provide*

*access. The latter is the likely outcome, therefore, an SLR can help experienced scholars develop new and interesting research paths by accessing and analysing a considerable volume of scholarly work.*

Additionally, the SLR method complements traditional literature reviews because the approach helps to yield different outcomes that are defensible. The SLR can be useful for higher degree students and emerging scholars, allowing them to demonstrate that their literature reviews are defensible (Massaro *et al.*, 2016, p. 769).

## **THE STRUCTURED LITERATURE REVIEW**

In our study we adopt an SLR method to provide insights and critique that will help identify future research agenda for <MDNFI>. Essentially a structured literature review is a form of content analysis whereby the unit of analysis is the article, as opposed to words, sentences or paragraphs, as is commonly found in content analysis research (Massaro *et al.*, 2015, p. 533). Accordingly, the review process is conducted in ten different stages shown in Figure 1.

### *The Literature Review Protocol*

The structured literature review protocol, proposed by Massaro *et al.*, (2016), consisting of the following steps: statement of research questions, literature search, articles impact analysis, definition of analytical framework, reliability, validity, articles coding, insights and critique, further research on <MDNFI> .

### *Research questions*

Researchers use SLRs to map and assess the existing intellectual territory to identify future research needs (Dixon-Woods, 2011, p. 331). Before proposing a path of future research development with the literature review, we need to analyse from a critical point of view the existing field of knowledge by developing research issues. Subsequently, in the second stage we adapt the three generic research questions to focus specifically on the <MDNFI> literature.

1. How is research for inquiring into <MDNFI> developing?
2. What is the focus and critique of the <MDNFI> literature?
3. What is the future for <MDNFI> research?

### *The literature search*

The third stage involves the selection of data sources for the review. We select articles from internationally recognised academic journals covering different disciplines, including, but not limited to, the accounting literature based on the term 'mandatory disclosure of non-financial information' appearing in the title, abstract or keywords of the article.

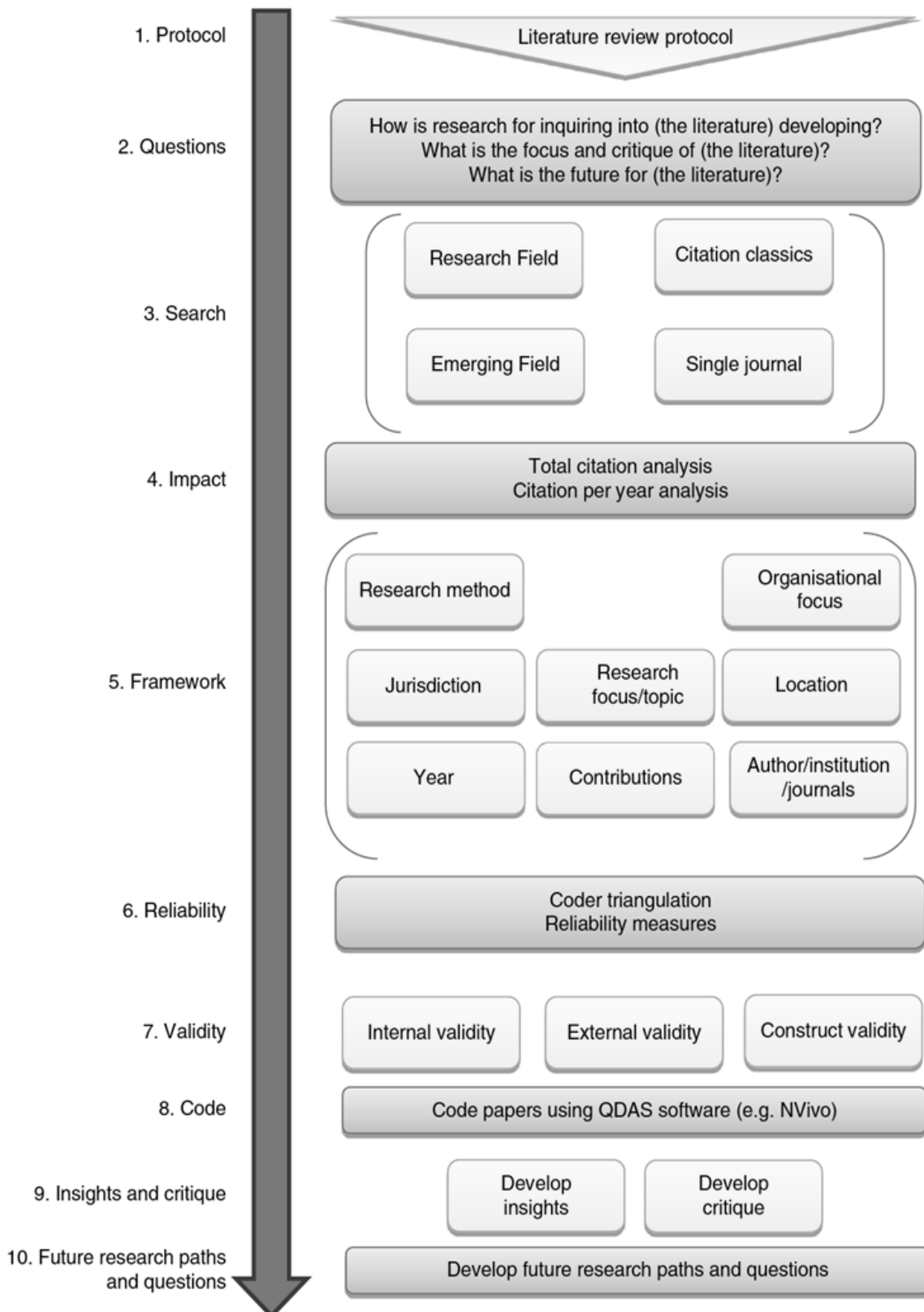

Figure 1. The process to develop the structure literature review adapted by Massaro et al. (2016)

We focus on three types of academic articles (based on Scopus, the largest abstract and citation database of peer-reviewed literature): articles by citations, articles in press and conference papers, using specific keywords. In fact, “a keyword search can help researchers to find relevant articles that extend existing topics in a particular field. Although a keyword search is a powerful tool, researchers have to be careful in the keyword selection criteria” (Massaro *et al.* (2016, p. 777). Furthermore, according to Cronin, Ryan and Coughlan (2008, p. 40) “keywords need careful consideration to select terms that will generate the data being sought”.

We retrieve data from Scopus database on 1 April 2017, for a period of 25 years. We used 1 January 1991 as a starting date and adopted a cut-off date of 31 December 2016. As a result, we identify 1,184 articles.

Subsequently, we examine the titles, abstracts and keywords of all the retrieved academic journals and select articles examining <mandatory disclosure of non-financial information> to ensure the articles are relevant. As a result, we identify 77 articles.

We then download the PDF versions of these articles and stored them in a public Dropbox folder with full referencing details.

#### *Article impact*

In the forth stage we determine the articles’ impact according to the number of Scopus citations. To do so we download from Scopus the articles’ citation data as of 10 May 2017.

We used the citation metrics to measure the article’s impact because interesting insights can come from an analysis of the number of articles in terms of citation metrics (Dumay, 2014b). Citation metrics allow researchers to understand how the literature develops and if the research topic is important, by examining the impact different articles have over time (Massaro *et al.* 2016, p. 774). In fact, as Serenko and Bontis (2013, p. 309) outline, “a key assumption is that there exist a strong positive relationship between the number of citations attracted by a journal and its overall quality”.

But this method can have some problems. Dumay and Dai (2014, p. 270) outline that “One problem with determining the impact from citations alone is that older articles can accumulate more citations”. For this reason we have set the period analysed from 1991 to 2015 excluding the articles published in 2016 because they may have less citations.

First, we examine the results of the preliminary literature search that identifies 1,184 articles in terms of timeline, source, author, author affiliation and country.

Figure 2 shows a noticeably growing trend of <MDNFI> articles, that reaches a peak in 2015. This is explained by the fact that the Directive 2014/95/EU was introduced in 2014. So, scholars paid a growing attention to this issue due to the regulation change.



Documents by year

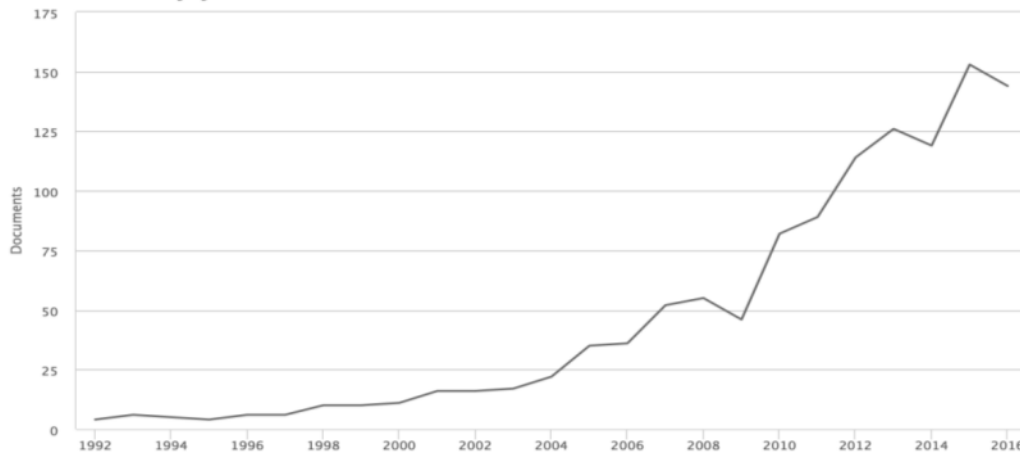

Figure 2. Document by year

Looking at the type of academic journals, we note a predominant interest for the <MDNFI> literature from accounting and auditing journals as we expected (see Figure 3).

Documents per year by source

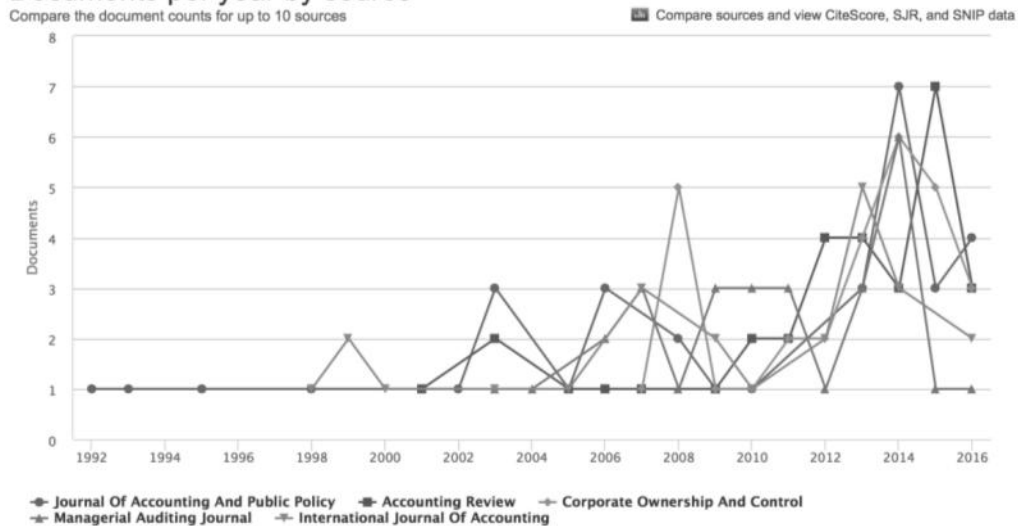

Figure 3. Documents per year by source

Figure 4 shows the main authors that publish articles on <MDNFI>. They are K. Hussainey, J., Guthrie, C. Leuz, D. Cormier, L. Hail and E. Lee.

### Documents by author

Compare the document counts for up to 15 authors

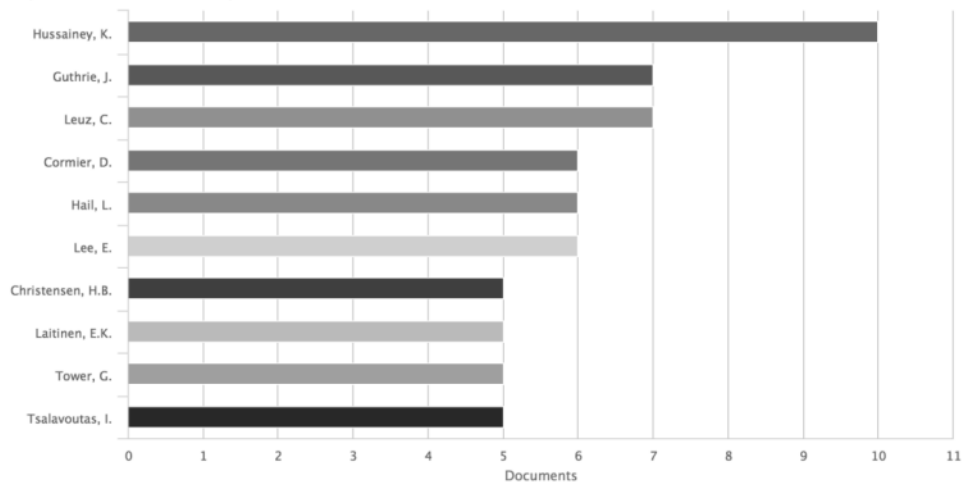

Figure 4. Documents by author

More interesting is Figure 5, that explains the most recurring affiliations. At the top lies the Macquarie University, University of Chicago ranks second and the University of New South Wales UNSW Australia is the third. These results show that the <MDNFI> items are mainly studied in Australia (there are six Australian universities among the first ten universities that study <MDNFI> issues). There are also a remarkable component in the USA.

### Documents by affiliation

Compare the document counts for up to 15 affiliations

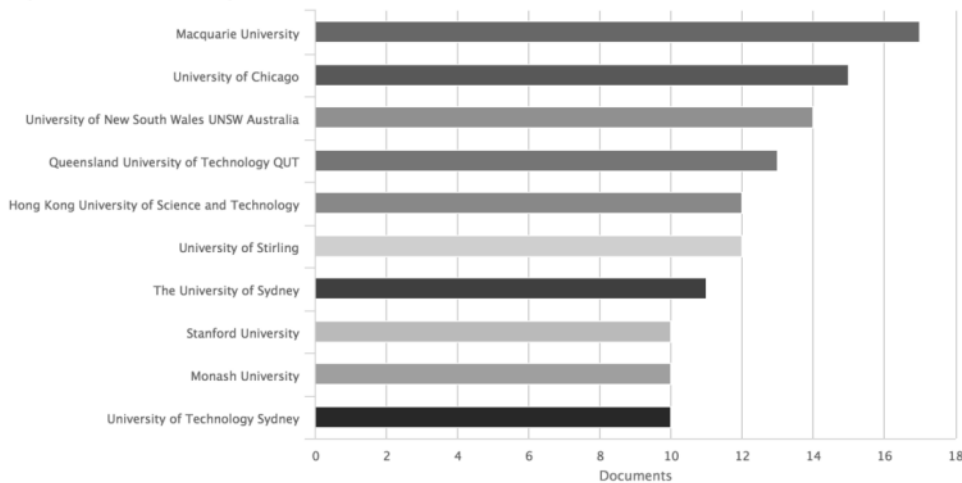

Figure 5. Documents by affiliation

Figure 6 shows the documents by country/territory. The first three countries where <MDNFI> is investigated are United States, Unites Kingdom and Australia; so, these results express a strong interest on <MDNFI> research according to the evidences outlined in the previous graph on authors affiliations.

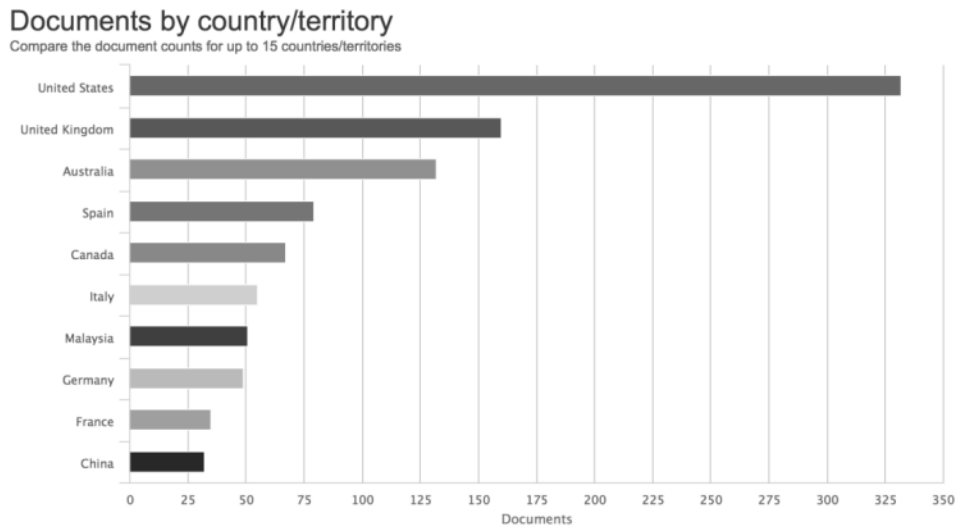

Figure 6. Documents by country/territory

After the first analysis, we select 77 articles examining the titles, abstracts and keywords of all the retrieved academic journals to ensure the articles are relevant. We use Scopus citations to measure the academic impact of the articles and to provide insight into the evolution of the <MDNFI> literature.

In Table 1 we report the top ten articles by Scopus citations, highlighting the authors name, the publication year, the article's title and the total number of citations. For example, the article by Beyer, Cohen, Lys, Walther (2010) has been cited 293 times indicating that it has a strong impact on the academic <MDNFI> debate. The same consideration could be done for the article by Beattie, McInnes, Fearnley (2004), that has been cited 206 times.

Subsequently, in Table 2 we report the top ten articles by Scopus citations per year (Massaro *et al.* 2016). From a comparative analysis with the results of the previous tables, we observe that some recent articles (Frias-Aceituno, Rodriguez-Ariza, Garcia-Sanchez, 2013; Campbell, Chen, Dhaliwal, Lu, and Steele, 2014; García-Sánchez, Frías-Aceituno, Rodríguez-Domínguez, 2013) appear in the list of Table 2, and each has been cited more than ten times, indicating that they have already had an impact on the <MDNFI> debate.

Number	Reference	Publication Year	Article	Scopus Citations
1	Beyer, Cohen, Lys, Walther	2010	The financial reporting environment: Review of the recent literature	293
2	Beattie, McInnes, Fearnley	2004	A methodology for analysing and evaluating narratives in annual reports: A comprehensive descriptive profile and metrics for disclosure quality attributes	206
3	Holder-Webb, Cohen, Nath, Wood	2009	The supply of corporate social responsibility disclosures among U.S. firms	132
4	Bushee and Leuz	2005	Economic consequences of SEC disclosure regulation: Evidence from the OTC bulletin board	127

5	Chen, Bouvain	2009	Is corporate responsibility converging? a comparison of corporate responsibility reporting in the USA, UK, Australia, and Germany	121
6	Owusu-Ansah	1998	The impact of corporate attributes on the extent of mandatory disclosure and reporting by listed companies in Zimbabwe	120
7	Leuz	2010	Different approaches to corporate reporting regulation: How jurisdictions differ and why	97
8	Ghazali	2007	Ownership structure and corporate social responsibility disclosure: Some Malaysian evidence	93
9	Magness	2006	Strategic posture, financial performance and environmental disclosure: An empirical test of legitimacy theory	91
10	Clarkson, Overell, Chapple	2011	Environmental Reporting and its Relation to Corporate Environmental Performance	86

Table 1. Top ten articles by Scopus citations - As at April 1, 2017

Number	Reference	Publication Year	Article	Scopus Citations per Year
1	Beyer, Cohen, Lys, Walther	2010	The financial reporting environment: Review of the recent literature	49
2	Holder-Webb, Cohen, Nath, Wood	2009	The supply of corporate social responsibility disclosures among U.S. firms	19
3	Frias-Aceituno, Rodriguez-Ariza, Garcia-Sanchez	2013	The role of the board in the dissemination of integrated corporate social reporting	18
4	Chen, Bouvain	2009	Is corporate responsibility converging? a comparison of corporate responsibility reporting in the USA, UK, Australia, and Germany	17
5	Clarkson, Overell, Chapple	2011	Environmental Reporting and its Relation to Corporate Environmental Performance	17
6	Beattie, McInnes, Fearnley	2004	A methodology for analysing and evaluating narratives in annual reports: A comprehensive descriptive profile and metrics for disclosure quality attributes	17
7	Campbell, Chen, Dhaliwal, Lu, Steele	2014	The information content of mandatory risk factor disclosures in corporate filings	17
8	Leuz	2010	Different approaches to corporate reporting regulation: How jurisdictions differ and why	16
9	Bushee and Leuz	2005	Economic consequences of SEC disclosure regulation: Evidence from the OTC bulletin board	12
10	García-Sánchez, Frías-Aceituno, Rodríguez-Domínguez	2013	Determinants of corporate social disclosure in Spanish local governments	11

Table 2. Top ten articles by citations per year (CPY) - As at April 1, 2017

Define the analytical framework

To pursue an SLR, we must identify units of analysis within selected papers and treat them as independent elements to be analysed. Thus, in the fifth stage, we define an analytical framework in order to help us to organize the existing literature on <MDNFI>.

To develop this framework, we adopted the criteria used by (Massaro *et al.* 2016). Particularly, “as part of developing the framework three authors initially coded five articles to determine the suitability of the adopted frameworks and to determine if any other criteria or attributes needed changing, adding or deleting” (Dumay, Bernardi, Guthrie, Demartini 2016, p. 171).

#### *The literature review reliability*

Because structured literature review is a form of content analysis, we use subjective coding to analyse the selected articles because the “research is based on data generated by human beings asked to make some kind of judgment” (Hayes and Krippendorff, 2007, p. 77). So, it is important to develop particular forms of control and triangulation that reduce the “bias by integrating theories, methods, data sources and researchers with complementary strengths and non-overlapping weaknesses” (Modell, 2009, p. 209). In fact, if researchers could reduce bias they would be able to argue that their coding and analytical framework are reliable.

In fact, the reliability measure can help researchers to demonstrate that their data: “(a) have been generated with all conceivable precautions in place against known pollutants, distortions and biases, intentional or accidental, and (b) mean the same thing for everyone who uses them” (Krippendorff, 2013, p. 267). We discuss the coding system together and, after having clarified the questionable issues, we develop the remain part of the analysis.

#### *Testing literature review validity*

External validity is concerned with whether the results of a study can be generalised (White and McBurney, 2012, p. 145). In our study, we select the most representative articles of the available literature. Firstly, we do a content analysis of the selected articles reading the abstracts and, in some cases, the full content of the articles to select the articles that are more representative of the academic literature on <MDNFI>.

#### *Article coding*

We define the analytical framework and we check the framework’s reliability. After this, we code the articles we recorded the results in an Excel spreadsheet. Furthermore, we retain an open coding approach alongside coding for the pre-established categories in the framework, in case we discover any relevant new article attributes or categories.

As such, we add two of the extra three criteria to the analytical framework, after the first pass at coding, because we found new insights as we read and coded the articles. This highlights how the SLR process is not just a rigid approach, but is flexible and develops iteratively (Dumay et al. 2016, p. 172).

## INSIGHT AND CRITIQUE

In this section we present the main research results of our analysis of <MDNFI>'s articles and attempt to answer to the research questions. The research follows the SLR method, classifying the articles according to the SLR schema and the changes we include for analysing <MDNFI> criteria (see the following tables).

### *Jurisdiction*

We adopt the Jurisdiction criterion from Guthrie *et al.* (2012, p. 71). It examines the context of <MDNFI> research. We also sub-classify these attributes into "Industry" or "Organisational" subcategories either from "Supra-national" or "National" perspective.

In the "Supra-national" perspective, we categorize articles in which authors have compared two or more countries. For example, we classify articles that do not have an empirical based as "Supra-national/International/Comparative-General". The sub-category "National-Industry" includes papers based on a specific industry belonging a single country. On the contrary, the "National-General" subcategory includes articles whose analysis concerns a single country but not a specific industry.

As shown in table 3, in the National perspective the articles analysed are concentrated in the "Industry" and "General" subcategories; instead, in the "Supra-national" perspective major of articles adopt a general approach because there is a greater concentration in the subcategory "Supra-national/International/Comparative-General".

Jurisdiction							
Supra-national/International/Comparative-General	Supra-national/International/Comparative-Industry	Supra-national/International/Comparative-Organisational	National-General	National-Industry	National-Organisational	One Organisation	Total
14	10	0	25	28	0	0	77,00

Table 3. Results of analysis of <MDNFI> – Jurisdiction

### *Country of research*

The Country of research criterion shows the place in which the authors conducted their researches and helps the field identify other places that could be subject to investigation.

We build a classification scheme dividing the Country of research in seven regions: USA/Canada, Australasia, United Kingdom, European Union, Asia, Africa and Other. The results suggest that the most studied locations are the European Union and the USA/Canada with twenty-six and twenty-one articles respectively, so these are the contexts dominating the <MDNFI> research agenda (see Table 4).

Country of research							
USA/Canada	Australasia	United Kingdom	European Union	Asia	Africa	Other (including General)	Total
21	14	6	26	12	5	6	78,00

Table 4. Results of analysis of <MDNFI> – Country of research

#### Research methods

In this section we propose the research method criterion adopted from Guthrie *et al.* (2012) and we include five attributes.

In particular, the first three attributes relate to studies that are empirical in nature (Dumay *et al.* 2016): “Case/Field study/Interviews”, “Content analysis/Historical analysis”, “Survey/ Questionnaire/Other empirical”. The next two attributes are normative in nature and include “Commentary/Normative/Policy” and “Literature review”.

The results of our analysis show that empirical analysis (“Survey/Questionnaire/Other empirical”) is the most common methodology for the <MDNFI> research. “Content analysis/Historical analysis” ranks second, so it is also popular for investigating <MDNFI> items.

Whereas we retrieved six contributes adopting a “Literature review” research method, four contributes that can be included in the “Case/Field study/Interviews” attributes and only two articles about “Commentary/Normative/Policy”.

Research Methods					
Case/Field study/Interviews	Content analysis/Historical analysis	Survey/Questionnaire/Other empirical	Commentary/Normative/Policy	Literature review	Total
4	24	41	2	6	77,00

Table 5. Results of analysis of <MDNFI> – Research methods

#### Academic, Practitioners and Regulators

In our study Academic, Practitioners and Regulators is a double criterion used to know the authors of the articles and the subjects to which the articles are addressed. For this reason, we identify three categories: “Academic(s)”, “Practitioner(s)”, “Regulator(s)” and “Academics, practitioners and regulators”.

Academic and Practitioners (as authors)			
Academic(s)	Practitioner(s)	Academics and practitioners	Total
74	3	0	77,00

Table 6. Results of analysis of &lt;MDNFI&gt; – Academic, Practitioners (as authors)

On the basis of the examined articles that constitute our sample, the analysis shows that <MDNFI> studies are usually prepared by academics and mostly intended for academics and practitioners and much less than just regulators.

Academic, Practitioners and Regulators (as readers)				
Academic(s)	Practitioner(s)	Regulators	Academics, practitioners and regulators	Total
28	24	6	19	77,00

Table 7. Results of analysis of &lt;MDNFI&gt; – Academic, Practitioners and Regulators (as readers)

#### Organisational focus

The Organisational focus helps to identify the type of organisations that a research paradigm investigates. In our research this criterion consists of six attributes: “Publicly listed”, “Private –SMEs”, “Private – Others”, “Public sector”, “Not-for-profit”, “General/Other”.

We find that the majority of <MDNFI> studies focusing on “Publicly listed” companies (with 46 articles), so these are the most commonly researched type of organisations. “General/Other” attribute has 26 contributes and “Public sector” has five articles.

Organisational Focus						
Publicly listed	Private SMEs	Private Others	Public sector	Not-for-profit	General/Other	Total
46	0	0	5	0	26	77,00

Table 8. Results of analysis of &lt;MDNFI&gt; – Organisational Focus

#### Focus of <MDNFI> literature

We develop the Focus of <MDNFI> literature from Guthrie *et al.* (2012) original classification scheme. In particular, we changed the original format to highlight the research topic of our analysis, so we introduced a specific focus “External reporting” that is further investigated in the table 10 and two others explanatory categories of research focus, that are “Ethics and CSR” and “Risk disclosure”.

This analysis shows that the most discussed focus is “External reporting” with forty-six articles. “CSR” ranks second followed by “Accountability and Governance”. Looking at the “External reporting” focus we observe that ten articles analyse the “Environmental reporting and disclosure).

Focus of <MDNFI> Literature						
External reporting	Ethics and CSR	Auditing and assurance	Accountability and governance	Management control/Strategy	Performance measurement	Total
46	15	1	13	0	2	77,00

Table 9. Results of analysis of &lt;MDNFI&gt; – Focus of &lt;MDNFI&gt; literature

External reporting						
Financial reporting	Sustainability reporting and	Social reporting and	Environmental reporting and	Risk disclosure	Other disclosure (including	Total



	disclosure	disclosure	disclosure		general)	
8	7	0	10	7	14	46

Table 10. Results of analysis of <MDNFI> – Focus of <External reporting> literature

## THE FUTURE RESEARCH QUESTIONS

Based on the results and analysis, we argue that the way forward for <MDNFI> research is a transformation from its current desk-bound traditions into a modern global discipline. Researchers need to be innovative in searching for <MDNFI>, for example investigating new media such as news media and social media.

Additional evidence that current <MDNFI> research is the persistence with which the majority of studies examine publicly listed companies suggests to focus on other organization types. One last comment relates to the synonymous nature of the terms “reporting” and “disclosure”. We feel the use of these two terms needs to be further explored.

To conclude the research examines the <MDNFI>’s research foundations. The study establishes the focus of <MDNFI> literature and offers guidelines for future research and suggests to move beyond the first stage towards second stage research on <MDNFI>.

## REFERENCES

- Alexander, R.M. and Gentry, J.K. (2014), “Using Social Media to Report Financial Results”, *Business Horizons*, Vol. 57 No. 2, pp. 161-167.
- Alvesson, M. and Deetz, S. (2000), “Doing Critical Management Research”, Sage, London.
- Branco, M.C. and Rodrigues, L.L. (2007), “Issues in Corporate Social and Environmental Reporting Research: An Overview”, *Issues in Social and Environmental, Accounting*, Vol. 1 No. 1, pp. 72-90.
- Busco, C., Frigo, M.L., Quattrone, P. and Riccaboni, A. (2013), *Integrated Reporting-Reflections on the Concepts, Principles, Elements and Case Studies that Are Redefining Corporate Accountability*, Heidelberg, DE: Springer.
- Campbell, D. and Beck, A.C. (2004), “Answering Allegations: The Use of the Corporate Website for Restorative Ethical And Social Disclosure”, *Business Ethics: A European Review*, Vol. 13, No. 2-3, pp. 100-116.
- Cheng, M., Green, W., Conradie, P., Konishi, N. and Romi, A. (2014), “The International Integrated Reporting Framework: Key Issues and Future Research Opportunities”, *Journal of International Financial Management & Accounting*, Vol. 25 No. 1, pp. 90-119.
- Crawford Perrault, E. and Clark Williams, C. (2011), “Communication Corporate Social Responsibility through Nonfinancial Reports”, in Ihlen, O., Barlett, J. L. and May, S. (Eds.), *The Handbook of Communication and Corporate Social Responsibility*, Chichester, UK: John Wiley & Sons, pp. 338-357.
- Cronin, P., Ryan, F. and Coughlan, M. (2008), “Undertaking a literature review: a step-by-step approach”, *The British Journal of Nursing*, Vol. 17 No. 1, pp. 38-43.
- De Bakker, F.G.A., Groenewegen, P. and Den Hond, F. (2005), “A Bibliometric Analysis of 30 Years of Research and Theory on Corporate Social Responsibility and Corporate Social Performance”, *Business & Society*, Vol. 44 No. 3, pp. 283-317.
- De Villiers, C. and Dumay, J. (2013), “Construction of research articles in the leading interdisciplinary accounting journals”, *Accounting, Auditing & Accountability Journal*, Vol. 26 No. 6 pp. 876-910.
- Deegan, C. and Gordon, B. (1996), “A Study of the Environmental Disclosure Practices of Australian Corporations”, *Accounting and Business Research*, Vol. 26 No. 3, pp. 187-199.
- Deegan, C.M., Rankin, M. and Tobin, J. (2002), “An Examination of the Corporate Social and Environmental Disclosures of BHP from 1983-1997 – A Test of Legitimacy Theory”, *Accounting, Auditing and Accountability Journal*, Vol. 15 No. 3, pp. 312-343.

- Dixon-Woods, M. (2011), "Systematic reviews and qualitative methods", in Silverman, D. (Ed.), *Qualitative Research. Issues of Theory, Method and Practice* (3rd ed.), Sage, London, pp. 331-346.
- Dumay, J. (2014b), "15 years of the journal of intellectual capital and counting: a manifesto for transformational IC research", *Journal of Intellectual Capital*, Vol. 15 No. 1, pp. 2-37.
- Dumay, J. (2016), "A critical reflection on the future of intellectual capital: from reporting to disclosure", *Journal of Intellectual Capital*, Vol. 17 No. 1, pp.168-184.
- Dumay, J. and Dai, T.M.X. (2014), "Integrated thinking as an organisational cultural control?", in *Critical perspectives on accounting conference*.
- Dumay, J. and Garanina, T. (2013), "Intellectual capital research: A critical examination of the third stage", *Journal of Intellectual Capital*, Vol. 14 No. 1, pp. 10-25.
- Dumay, J., Bernardi, C., Guthrie, J. and Demartini, P. (2016), "Integrated reporting: A structured literature review", *Accounting Forum*, Vol. 40, pp. 166-185.
- Eccles R. and Krzus M.P. (2010), *One Report: Integrated Reporting for a Sustainable Strategy*, Chichester, UK: John Wiley & Sons.
- Elkington, J. (1998), *Cannibals with Forks: The Triple Bottom Line of 21st Century Business*, Hoboken, USA: John Wiley & Sons.
- EU (2011a), *Corporate Social Responsibility: a new definition, a new agenda for action*, MEMO/11/730, Commission of the European Communities, Brussels.
- EU (2011b), *A renewed EU strategy 2011-14 for Corporate Social Responsibility*, COM(2011) 681 final, Commission of the European Communities, Brussels.
- Feng, T., Cummings, L. and Tweedie, D. (2017), "Exploring integrated thinking in integrated reporting – an exploratory study in Australia", *Journal of Intellectual Capital*, Vol. 18 No. 2, pp. 330-353.
- Freeman, R.E. and Moutchnik, A. (2013), "Stakeholder Management and CSR: Questions and Answers", *UmweltWirtschaftsForum*, Vol. 21, No. 1, pp. 5-9.
- Frost, G., Jones, S., Loftus, J. and Van Deer Lan S. (2005), "A Survey of Sustainability Reporting Practices of Australian Reporting Entities", *Australian Accounting Review*, Vol. 15, No. 1, pp. 89-96.
- Gibson, K. (2012), "Stakeholders and Sustainability: An Evolving Theory", *Journal of Business Ethics*, Vol. 109, No. 1, pp. 15-25.
- Global Reporting Initiative (2013), "G4 Sustainability Reporting Guidelines", available at: <https://www.globalreporting.org/reporting/g4/Pages/default.aspx> (accessed 19 April 2015).
- Gray, R., Kouhy, R. and Lavers, S. (1995), "Corporate Social and Environmental Reporting: A Review of the Literature and a Longitudinal Study of UK Disclosure", *Accounting, Auditing & Accountability Journal*, Vol. 8 No. 2, pp. 47-77.
- Gray, R.H, Owen, D.L. and Adams, C.A. (1996), *Accounting and Accountability: Changes and Challenges in Corporate Social and Environmental Reporting*, Hemel Hempstead, UK: Prentice Hall.
- Gray, R.H., Owen, D.L. and Maunders, K.T. (1987), *Corporate Social Reporting: Accounting & Accountability*, Hemel Hempstead, UK: Prentice-Hall.
- Gruppo di studio per il Bilancio Sociale (2013), "Il Bilancio Sociale, GBS 2013 Standard", available at: <http://www.gruppobilanciosociale.org/wp-content/uploads/2014/02/Standard-GBS-2013-Principi-di-redazione-del-Bilancio-Sociale.pdf> (accessed 19 April 2015).
- Guthrie, J., Ricceri, F. and Dumay, J. (2012), "Reflections and projections: A decade of intellectual capital accounting research", *The British Accounting Review*, Vol. 44 No. 2, 68-82.
- Guthrie, J.E, and Parker, L.D. (1990), "Corporate Social Disclosure Practices: A Comparative International Analysis", *Advances in Public Interest Accounting*, Vol. 12 No. 2, pp. 123-142.
- Guthrie, J.E. and Mathews, M.R. (1985), "Corporate Social Accounting in Australasia", *Research in Corporate Social Performance and Policy*, Vol. 7 No. 1, pp. 251-277.
- Hayes, A.F. and Krippendorff, K. (2007), "Answering the call for a standard reliability measure for coding data", *Communication Methods and Measures*, Vol. 1 No. 1, pp. 77-89.
- International Integrated Reporting Council (2013a) "The International <IR> Framework", Available at: <http://www.theiirc.org/wp-content/uploads/2013/12/13-12-08-THE-INTERNATIONAL-IR-FRAMEWORK-2-1.pdf> (accessed 19 April 2015).
- Jung, M.J., Naughton, J.P., Tahoun, A. and Wang, C. (2014), "Corporate Use of Social Media", working paper, available at: [http://www.rhsmith.umd.edu/files/Jung Michael.pdf](http://www.rhsmith.umd.edu/files/Jung%20Michael.pdf) (accessed 26 February 2015).
- Kolk, A. (2004), "A Decade of Sustainability Reporting: Developments and Significance", *International Journal of Environment and Sustainable Development*, Vol. 3 No. 3, pp. 1-64.
- Krippendorff, K. (2013), *Content Analysis. An Introduction to Its Methodology*, Sage Publications, Thousand Oaks, CA.

- Massaro, M., Dumay, J. and Garlatti, A. (2015), "Public sector knowledge management: a structured literature review", *Journal of Knowledge Management*, Vol. 19 No. 3 pp. 530-558.
- Massaro, M., Dumay, J. and Guthrie, J., (2016), "On the shoulders of giants: undertaking a structured literature review in accounting", *Accounting, Auditing & Accountability Journal*, Vol. 29 No. 5 pp. 767-801.
- Milne, M.J. and Gray, R. (2013), "W(h)ither ecology? The triple bottom line, the global reporting initiative, and corporate sustainability reporting", *Journal of Business Ethics*, Vol. 118 No. 1, pp. 13-29.
- Modell, S. (2009), "In defence of triangulation: a critical realist approach to mixed methods research in management accounting", *Management Accounting Research*, Vol. 20 No. 3, pp. 208-221.
- Morsing, M. and Schultz, M. (2006), "Corporate Social Responsibility Communication: Stakeholders Information, Response and Involvement Strategies", *Business Ethics: A European Review*, Vol. 15, No. 4, pp. 323-338.
- Paniagua, J. and Sapena, J. (2014), "Business Performance and Social Media: Love or Hate?", *Business Horizons*, Vol. 57 No. 6, pp. 719-728.
- Parker, L.D. (2011), "Twenty-one Years of Social and Environmental Accountability Research: A Coming of Age", *Accounting Forum*, Vol. 35 No. 1, pp. 1-10.
- Patten, D.M. and Crampton, W. (2004), "Legitimacy and the Internet: An Examination of Corporate Web Page Environmental Disclosures", in Bikki, J. and Freedman, M. (Eds.), *Advances in Environmental Accounting and Management*, Vol. 2, Bingley, UK: Emerald Group Publishing Limited, pp. 31-57.
- Roberts, C.B. (1991), "Environmental Disclosures: A Note on Reporting Practices in Europe", *Accounting, Auditing & Accountability Journal*, Vol. 4 No. 3, pp. 62-71.
- Securities and Exchange Commission (SEC) (2013), "SEC Says Social Media OK for Company Announcements if Investors Are Alerted", available at: <http://www.sec.gov/News/PressRelease/Detail/PressRelease/1365171513574> (accessed 14 June 2015).
- Serenko, A. and Bontis, N. (2013), "Global ranking of knowledge management and intellectual capital academic journals: 2013 update", *Journal of Knowledge Management*, Vol. 17 No. 2, pp. 307-326.
- Testarmata S., Fortuna F., Ciaburri M. (2015), "The Use of Social Media in Corporate Social Responsibility Disclosure", in *Proceedings of EUROMED 2015 "Innovation and Entrepreneurship in a Dynamic Environment"*, 8th Annual Conference, Verona (Italia), 16-18 September.
- White, T. and McBurney, D. (2012), *Research Method*, 9th ed., Wadsworth, Belmont, CA.
- Williams, S.M. and Pei, C.A.H.W. (1999) "Corporate Social Disclosures by Listed Companies on Their Web Sites: An International Comparison", *The International Journal of Accounting*, Vol. 34, No. 3, pp. 389-419.
- Zhou, M., Lei L., Wang, J., Fan, W. and Wang, A.G. (2015), "Social Media Adoption and Corporate Disclosure", *Journal of Information Systems*, Vol. 29 No. 2, pp. 23-50.

**APPENDIX A. <MDNFI> PUBLICATIONS REVIEWED (1991-2015)**

- Ackers, B. and Eccles, N. S. (2015), "Mandatory corporate social responsibility assurance practices: The case of King III in South Africa", *Accounting, Auditing and Accountability Journal*, Vol. 28 No. 4, pp. 515-550.
- Adams, C.A. (2004), "The ethical, social and environmental reporting-performance portrayal gap. Accounting", *Auditing & Accountability Journal*, Vol. 17 No. 5, pp. 731-757.
- Adams, C.A., Muir, S. and Hoque, Z. (2014), "Measurement of sustainability performance in the public sector", *Sustainability Accounting, Management and Policy Journal*, Vol. 5 No. 1, pp. 46-67.
- Akhtaruddin, M. (2005), "Corporate mandatory disclosure practices in Bangladesh", *International Journal of Accounting*, Vol. 40 No. 4, pp. 399-422.
- Al-Akra, M., Eddie, I.A. and Ali, M.J. (2010), "The influence of the introduction of accounting disclosure regulation on mandatory disclosure compliance: Evidence from Jordan", *British Accounting Review*, Vol. 42 No. 3, pp. 170-186.
- Alali, F. and Romero, S. (2012), "The use of the internet for corporate reporting in the Mercosur (southern common market): The Argentina case", *Advances in Accounting*, Vol. 28 No. 1, pp. 157-167.
- Amran, A., Manaf Rosli Bin, A. and Che Haat Mohd Hassan, B. (2009), "Risk reporting: An exploratory study on risk management disclosure in Malaysian annual reports", *Managerial Auditing Journal*, Vol. 24 No. 1, pp. 39-57.
- Arvidsson, S. (2011), "Disclosure of non-financial information in the annual report: A management-team perspective", *Journal of Intellectual Capital*, Vol. 12 No. 2, pp. 277-300.
- Barbu, E.M., Dumontier, P., Feleagă, N. and Feleagă, L. (2014), "Mandatory environmental disclosures by companies complying with IASs/IFRSs: The cases of France, Germany, and the UK", *International Journal of Accounting*, Vol. 49 No. 2, pp. 231-247.
- Bassett, M., Koh, P.-S. and Tutticci, I. (2007), "The association between employee stock option disclosures and corporate governance: Evidence from an enhanced disclosure regime", *British Accounting Review*, Vol. 39 No. 4, pp. 303-322.
- Beattie, V., McInnes, B. and Fearnley, S. (2004), "A methodology for analysing and evaluating narratives in annual reports: A comprehensive descriptive profile and metrics for disclosure quality attributes", *Accounting Forum*, Vol. 28 No. 3, pp. 205-236.
- Belal, A.R. and Roberts, R.W. (2010), "Stakeholders' perceptions of corporate social reporting in Bangladesh", *Journal of Business Ethics*, Vol. 97 No. 2, pp. 311-324.
- Berger, P.G. (2011), "Challenges and opportunities in disclosure research-A discussion of 'the financial reporting environment: Review of the recent literature'", *Journal of Accounting and Economics*, Vol. 51 No. 1-2, pp. 204-218.
- Beyer, A., Cohen, D.A., Lys, T.Z. and Walther, B.R. (2010), "The financial reporting environment: Review of the recent literature", *Journal of Accounting and Economics*, Vol. 50 No. 2-3, pp. 296-343.
- Bezhan, I. (2010), "Intellectual capital reporting at UK universities", *Journal of Intellectual Capital*, Vol. 11 No. 2, pp. 179-207.
- Bhatia, A. (2012), "The corporate social responsibility report: The hybridization of a 'confused' genre (2007-2011)", *IEEE Transactions on Professional Communication*, Vol. 55 No. 3, pp. 221-238.
- Boubaker, S., Lakhali, F. and Nekhili, M. (2011), "The determinants of web-based corporate reporting in France", *Managerial Auditing Journal*, Vol. 27 No. 2, pp. 126-155.
- Broberg, P., Tagesson, T. and Collin, S.-O. (2010), "What explains variation in voluntary disclosure? A study of the annual reports of corporations listed on the Stockholm stock exchange", *Journal of Management and Governance*, Vol. 14 No. 4, pp. 351-377.
- Burritt, R.L. (2002), "Environmental reporting in Australia: Current practices and issues for the future", *Business Strategy and the Environment*, Vol. 11 No. 6, pp. 391-406.
- Bushee, B.J. and Leuz, C. (2005), "Economic consequences of SEC disclosure regulation: Evidence from the OTC bulletin board", *Journal of Accounting and Economics*, Vol. 39 No. 2, pp. 233-264.
- Campbell, J.L., Chen, H., Dhaliwal, D.S., Lu, H.-M., and Steele, L.B. (2014), "The information content of mandatory risk factor disclosures in corporate filings", *Review of Accounting Studies*, Vol. 19 No. 1, pp. 396-455.
- Carnegie, G.D. and West, B.P. (2005), "Making accounting accountable in the public sector", *Critical Perspectives on Accounting*, Vol. 16 No. 7, pp. 905-928.
- Chang, J.C. and Sun, H.L. (2009), "Crossed-listed foreign firms' earnings informativeness, earnings management and disclosures of corporate governance information under SOX", *International Journal of Accounting*, Vol. 44 No. 1, pp. 1-32.
- Chen, S. and Bouvain, P. (2009), "Is corporate responsibility converging? a comparison of corporate responsibility reporting in the USA, UK, Australia, and Germany", *Journal of Business Ethics*, Vol. 87 No. 1, pp. 299-317.

- Clarkson, P.M., Overell, M.B. and Chapple, L. (2011), "Environmental reporting and its relation to corporate environmental performance", *Abacus*, Vol. 47 No. 1, pp. 27-60.
- Cohen, J.R., Holder-Webb, L.L., Nath, L. and Wood, D. (2012), "Corporate reporting of nonfinancial leading indicators of economic performance and sustainability", *Accounting Horizons*, Vol. 26 No. 1, pp. 65-90.
- Combes-Thuélín, E., Henneron, S. and Touron, P. (2006), "Risk regulations and financial disclosure: An investigation based on corporate communication in French traded companies", *Corporate Communications*, Vol. 11 No. 3, pp. 303-326.
- Crawford, E.P. and Williams, C.C. (2010), "Should corporate social reporting be voluntary or mandatory? evidence from the banking sector in France and the united states", *Corporate Governance*, Vol. 10 No. 4, pp. 512-526.
- Criado-Jiménez, I., Fernández-Chulián, M., Husillos-Carqués, F.J. and Larrinaga-González, C. (2008), "Compliance with mandatory environmental reporting in financial statements: The case of Spain (2001-2003)", *Journal of Business Ethics*, Vol. 79 No. 3, pp. 245-262.
- Day, R. and Woodward, T. (2004), "Disclosure of information about employees in the directors' report of UK published financial statements: Substantive or symbolic?", *Accounting Forum*, Vol. 28 No. 1, pp. 43-59.
- Dimmock, S.G. and Gerken, W.C. (2012), "Predicting fraud by investment managers", *Journal of Financial Economics*, Vol. 105 No. 1, pp. 153-173.
- Doshi, A.R., Dowell, G.W.S. and Toffel, M.W. (2013), "How firms respond to mandatory information disclosure", *Strategic Management Journal*, Vol. 34 No. 10, pp. 1209-1231.
- Dumay, J., Frost, G. and Beck, C. (2015), "Material legitimacy: Blending organisational and stakeholder concerns through non-financial information disclosures", *Journal of Accounting and Organizational Change*, Vol. 11 No. 1, pp. 2-23.
- Fasterling, B. (2012), "Development of norms through compliance disclosure", *Journal of Business Ethics*, Vol. 106 No. 1, pp. 73-87.
- Frias-Aceituno, J.V., Rodriguez-Ariza, L. and Garcia-Sanchez, I.M. (2013), "The role of the board in the dissemination of integrated corporate social reporting", *Corporate Social Responsibility and Environmental Management*, Vol. 20 No. 4, pp. 219-233.
- Frost, G.R. (2007), "The introduction of mandatory environmental reporting guidelines: Australian evidence", *Abacus*, Vol. 43 No. 2, pp. 190-216.
- Frownfelter-Lohrke, C. and Fulkerson, C.L. (2001), "The incidence and quality of graphics in annual reports: An international comparison", *Journal of Business Communication*, Vol. 38 No. 3, pp. 337-358.
- Gao, L. and Kling, G. (2012), "The impact of corporate governance and external audit on compliance to mandatory disclosure requirements in china", *Journal of International Accounting, Auditing and Taxation*, Vol. 21 No. 1, pp. 17-31.
- García-Meca, E. (2005), "Bridging the gap between disclosure and use of intellectual capital information", *Journal of Intellectual Capital*, Vol. 6 No. 3, pp. 427-440.
- García-Sánchez, I.-M., Frías-Aceituno, J.-V. and Rodríguez-Domínguez, L. (2013), "Determinants of corporate social disclosure in Spanish local governments", *Journal of Cleaner Production*, Vol. 39, pp. 60-72.
- Ghazali, N.A.M. (2007), "Ownership structure and corporate social responsibility disclosure: Some Malaysian evidence", *Corporate Governance*, Vol. 7 No. 3, pp. 251-266.
- Gomes, C.F., Yasin, M.M. and Lisboa, J.V. (2004), "An examination of manufacturing organizations' performance evaluation analysis, implications and a framework for future research", *International Journal of Operations and Production Management*, Vol. 24 No. 5-6, pp. 488-513.
- Graaf, J. (2013), "Colouring the numbers - on the role of intellectual capital in financial reporting", *Journal of Intellectual Capital*, Vol. 14 No. 3, pp. 376-394.
- Habersam, M., Piber, M. and Skoog, M. (2013), "Knowledge balance sheets in Austrian universities: The implementation, use, and re-shaping of measurement and management practices", *Critical Perspectives on Accounting*, Vol. 24 No. 4-5, pp. 319-337.
- Haji, A.A. (2013), "Corporate social responsibility disclosures over time: Evidence from Malaysia", *Managerial Auditing Journal*, Vol. 28 No. 7, pp. 647-676.
- Holder-Webb, L., Cohen, J., Nath, L. and Wood, D. (2008), "A survey of governance disclosures among U.S. firms", *Journal of Business Ethics*, Vol. 83 No. 3, pp. 543-563.
- Holder-Webb, L., Cohen, J.R., Nath, L. and Wood, D. (2009), "The supply of corporate social responsibility disclosures among U.S. firms", *Journal of Business Ethics*, Vol. 84 No. 4, pp. 497-527.
- Husin, N.M., Hooper, K. and Olesen, K. (2012), "Analysis of intellectual capital disclosure - an illustrative example", *Journal of Intellectual Capital*, Vol. 13 No. 2, pp. 196-220.

- Jaggi, B., Chin, C.-L., Lin, H.-W. and Lee, P. (2006), "Earnings forecast disclosure regulation and earnings management: Evidence from Taiwan IPO firms", *Review of Quantitative Finance and Accounting*, Vol. 26 No. 3, pp. 275-299.
- Kanto, A.J. and Schadewitz, H. J. (1997), "A multidimensional model for the disclosure policy of a firm", *Scandinavian Journal of Management*, Vol. 13 No. 3, pp. 229-249.
- Konishi, N. and Ali, M.M. (2007), "Risk reporting of Japanese companies and its association with corporate characteristics", *International Journal of Accounting, Auditing and Performance Evaluation*, Vol. 4 No. 3, pp. 263-285.
- Leong, S., Hazelton, J., Taplin, R., Timms, W. and Laurence, D. (2014), "Mine site-level water reporting in the Macquarie and Lachlan catchments: A study of voluntary and mandatory disclosures and their value for community decision-making", *Journal of Cleaner Production*, Vol. 84 No. 1, pp. 94-106.
- Leuz, C. (2010), "Different approaches to corporate reporting regulation: How jurisdictions differ and why", *Accounting and Business Research*, Vol. 40 No. 3, pp. 229-256.
- Macve, R. and Chen, X. (2010), "The "equator principles": A success for voluntary codes?", *Accounting, Auditing and Accountability Journal*, Vol. 23 No. 7, pp. 890-919.
- Magness, V. (2006), "Strategic posture, financial performance and environmental disclosure: An empirical test of legitimacy theory", *Accounting, Auditing and Accountability Journal*, Vol. 19 No. 4, pp. 540-563.
- Mallin, C., Farag, H. and Ow-Yong, K. (2014), "Corporate social responsibility and financial performance in islamic banks", *Journal of Economic Behavior and Organization*, Vol. 103, pp. 21-38.
- Meng, X.H., Zeng, S.X. and Tam, C.M. (2013), "From voluntarism to regulation: A study on ownership, economic performance and corporate environmental information disclosure in China", *Journal of Business Ethics*, Vol. 116 No. 1, pp. 217-232.
- Miihkinen, A. (2013), "The usefulness of firm risk disclosures under different firm riskiness, investor-interest, and market conditions: New evidence from Finland", *Advances in Accounting*, Vol. 29 No. 2, pp. 312-331.
- Mio, C. and Venturelli, A. (2013), "Non-financial information about sustainable development and environmental policy in the annual reports of listed companies: Evidence from Italy and the UK", *Corporate Social Responsibility and Environmental Management*, Vol. 20 No. 6, pp. 340-358.
- Mobus, J.L. (2005), "Mandatory environmental disclosures in a legitimacy theory context", *Accounting, Auditing and Accountability Journal*, Vol. 18 No. 4, pp. 492-517.
- Mokhtar, E.S. and Mellett, H. (2013), "Competition, corporate governance, ownership structure and risk reporting", *Managerial Auditing Journal*, Vol. 28 No. 9, pp. 838-865.
- Naser, K. and Nuseibeh, R. (2003), "Quality of financial reporting: Evidence from the listed Saudi nonfinancial companies", *International Journal of Accounting*, Vol. 38 No. 1, pp. 41-69.
- Omar, B. and Simon, J. (2011), "Corporate aggregate disclosure practices in Jordan", *Advances in Accounting*, Vol. 27 No. 1, pp. 166-186.
- Owusu-Ansah, S. (1998), "The impact of corporate attributes on the extent of mandatory disclosure and reporting by listed companies in Zimbabwe", *International Journal of Accounting*, Vol. 33 No. 5, pp. 605-631.
- Owusu-Ansah, S. and Yeoh, J. (2005), "The effect of legislation on corporate disclosure practices", *Abacus*, Vol. 41 No. 1, pp. 92-109.
- Perrini, F. (2005), "Building a European portrait of corporate social responsibility reporting", *European Management Journal*, Vol. 23 No. 6, pp. 611-627.
- Reverte, C. (2012), "The impact of better corporate social responsibility disclosure on the cost of equity capital", *Corporate Social Responsibility and Environmental Management*, Vol. 19 No. 5, pp. 253-272.
- Robinson, J.R., Xue, Y. and Yu, Y. (2011), "Determinants of disclosure noncompliance and the effect of the SEC review: Evidence from the 2006 mandated compensation disclosure regulations", *Accounting Review*, Vol. 86 No. 4, pp. 1415-1444.
- Romolini, A., Fissi, S. and Gori, E. (2014), "Scoring CSR reporting in listed companies - evidence from italian best practices", *Corporate Social Responsibility and Environmental Management*, Vol. 21 No. 2, pp. 65-81.
- Rylander, A., Jacobsen, K. and Roos, G. (2000), "Towards improved information disclosure on intellectual capital", *International Journal of Technology Management*, Vol. 20 No. 5-8, pp. 715-741.
- Sánchez, I.-M. G., Domínguez, L.R. and Álvarez, I.G. (2011), "Corporate governance and strategic information on the internet: A study of Spanish listed companies", *Accounting, Auditing and Accountability Journal*, Vol. 24 No. 4, pp. 471-501.
- Skouloudis, A., Jones, N., Malesios, C. and Evangelinos, K. (2014), "Trends and determinants of corporate non-financial disclosure in Greece", *Journal of Cleaner Production*, Vol. 68, pp. 174-188.

- Steyn, M. (2014), "Organisational benefits and implementation challenges of mandatory integrated reporting: Perspectives of senior executives at South African listed companies", *Sustainability Accounting, Management and Policy Journal*, Vol. 5 No. 4, pp. 476-503.
- Tschopp, D.J. (2005), "Corporate social responsibility: A comparison between the United States and the European Union", *Corporate Social Responsibility and Environmental Management*, Vol. 12 No. 1, pp. 55-59.
- Vander Bauwhede, H. and Willekens, M. (2008), "Disclosure on corporate governance in the European Union", *Corporate Governance*, Vol. 16 No. 2, pp. 101-115.
- Vormedal, I.H. and Ruud, A. (2009), "Sustainability reporting in Norway - an assessment of performance in the context of legal demands and socio-political drivers", *Business Strategy and the Environment*, Vol. 18 No. 4, pp. 207-222.
- Williams, C.C. (2008), "Toward a taxonomy of corporate reporting strategies", *Journal of Business Communication*, Vol. 45 No. 3, pp. 232-264.
- Xiao, Z. (1999), "Corporate disclosures made by Chinese listed companies", *International Journal of Accounting*, Vol. 34 No. 3, pp. 349-373.

## LINKING MOTIVATION WITH CREATIVITY IN GREECE

Thrassou, Alkis<sup>1</sup>; Orfanos, Dimosthenis<sup>2</sup>; Tsoukatos, Evangelos<sup>3</sup>

Department of Marketing, School of Business, University of Nicosia, Nicosia, Cyprus

WTG Engineering – EMEA Southern Hub, Global Service, Greece

Department of Accounting and Finance, University of Applied Sciences Crete (T.E.I. of Crete), Greece

### ABSTRACT

Motivation and creativity principles have diachronically concerned employees throughout organizational hierarchies, as they contribute significantly to productivity, efficiency and innovation. Leaders have particularly been the ones who mostly cultivate these principles in the workplace, so as to streamline their organizations and make them more productive. In this research we investigate how Greek business leaders and the wider hierarchy can stimulate employee motivation to a degree that would lead to generation of innovative creative ideas. The research combines primary qualitative and quantitative data, through interviews and a survey of over one hundred employees, of various job positions and hierarchy levels. Both methods investigated primarily the subjects of motivation and creativity in the workplace and particularly in the context of leadership styles and hierarchy. The main findings of this research show, that once both leadership and hierarchy motivate the employees to a level where employee job satisfaction is achieved, the employees thereafter become creatively innovative. The research validates for Greece the mainstream international theoretical arguments which are documenting the effectiveness of leadership and hierarchy in motivating the employees to become creative.

*Keywords: Motivation, Creativity, Innovation, Leadership, Leadership Styles, Hierarchy, Job Satisfaction, Greece*

### RESEARCH BACKGROUND AND AIM

Leaders have long been seeking ways and tactics to enhance creativity in the work place. A key element which could prepare the work place to accommodate creativity that potentially leads to innovation, is employee motivation (Amabile, 1988).

*The aim of this research* is to assess the effectiveness of hierarchy and leadership styles in motivating employees in Greece to become more creative; and to assess the degree to which creative ideas generated are actually materialized and actually lead to innovation (Zhou & Hoever, 2014). In this context the research establishes the theoretical foundations of the subject to generate and



quantitatively and qualitatively test hypotheses, to ultimately draw explicit conclusions that expand the theoretical knowledge on the subject and identify managerial implications towards practical implementation.

## **THEORETICAL FINDINGS AND RESEARCH HYPOTHESES**

This section builds on the findings of an extended literature review, including the works of Avolio and Gardner (2005), Baek-Kyoo et al. (2013), Bass and Riggio (2006), Bass et al. (2003), Birasnav et al. (2011), Bresciani et al. (2013), Černe et al. (2013), Chebbi et al. Chebbi H., Y(2017), Conger (1990), Crossan and Apaydin (2010), Dikshit and Dikshit (2014), Fisher and Sharp (2009), Ford and Gioia (2000), Gagne and Deci (2005), George et al. (2007), Gilley et al. (2009), Gong et al. (2009), Herrmann and Felfe (2014), Ilies et al. (2005), Jaques (1990), Mumford et al. (2007), Pearce et al. (2007), Rosing et al. (2011), Rossi et al. (2013), Santoro et al. (2017), Shalley et al. (2000), Shalley and Gilson (2004), Sosik et al. (1998), Taggar (2002), Treffinger et al. (1994), Vrontis et al. (2010), Walumbwa and Hartnell (2011), and Wilson-Evered et al. (2001, 2004). The literature review presents a positive relation of leadership and hierarchy with employee motivation for creativity in the work place. Particular styles of leaders can stimulate employee perception on the relation between leader support with motivation and creativity. These leaders emphasize on emotional as well as coordination support behaviors (Amabile et al., 2004). Coordination support, equips the employee with the proper expertise in order to perform well, while at the same time the leader prompts the employees' intrinsic motivation for creative work. With this instrument the leader facilitates the employees with the tasks he has to carry out in a creative way (Amabile et al., 1996). With the interpersonal support, the leader reveals his interest, empathy and consideration to the employee for the tasks he has to perform, which was found to enhance employee creativity (Oldham & Cummings, 1996; Amabile et al., 2004). Innovation support perception states the depth where the employee realizes the leadership engagement to support him to come up with novel ideas, which lead to innovative solutions. This is directly linked with the leadership styles. For instance, the rational transparency element authentic leaders possess, as part of the self-regulation characteristic, evidently reveals to the employee his leader true self (Gardner et al., 2005).

*Hypothesis 1: Positive leadership style work place environment effect stimulate employee motivation for generating creative ideas towards innovation.*

According to Fletcher & Ka"ufer (2003) shared leadership stimulates the team members to focus more on collaboration, act mutually with their peers, rather than having a classic hierarchical format such as a leader-follower cooperation. Furthermore, Pearce & Manz (2005) state that shared leadership is

substantial for organisations which foster constant innovation so as to offer innovative products and services to their customers and thus remain competitive in a very dynamic environment. On the other hand flexible organisations have the infrastructure to support creative ideas and innovation (Chebbi et al., 2016). Based on Hyypiä & Parjanen (2013), generation of ideas and innovation are quite likely to emerge from flexible and flat organizations, as they are more open to communication throughout the entire organization. Hence, in this way, they cultivate an organizational culture which focuses at communication throughout the organization, which fosters employee commitment to creativity and innovation across all organizational layers. Several research studies have also shown that transformational leadership has been categorized as a positive leadership style, which can increase employee motivation and innovation (Gumusluoglu & Ilsev, 2009). What is more, leadership can substantially influence the employees to collaborate better, become more creative so the organization can foster innovation (Amabile, 1998; Gumusluoglu & Ilsev, 2009).

*Hypothesis 2: Shared leadership) can yield sustainable creativity towards innovation.*

Effective cooperation amongst peers superiors and subordinates can bring astonishing outcomes to the organization. According to Bligh et al. (2006) development of shared leadership can be effective when dealing with complex problems. Shared or lateral leadership has the ability to engage multiple employees with knowledge and skills on different sectors in order to solve a complex problem. In other words, teams with various skills, advanced knowledge and experience can replace the hierarchical superior with one of the members of the team, whom they mutually agree on. Hence they are not supervised by a hierarchical superior, instead they are headed by one member of the team. This set up may lead to a powerful and successful type of leadership, which might yield motivation for creativity (Cox et al., 2003).

Transformational leaders critically affect employee creativity for two main reasons. Firstly, leadership is important to intriguing the individual traits that are critical for creativity, as well as the skills that are relevant to creativity and task motivation; and, in turn, these factors influence the level and frequency of employee creative behaviour (Amabile et al., 1996). Secondly, since leaders are empowered to manage rewards and sanctions, they ought to have the leadership behavior to identify whether the creative ideas employees come up with could potentially be beneficial, or instead they can be costly and jeopardize the company (Detert & Burris, 2007; George, 2007). Leadership styles which motivate employees to act creatively by exploring new ideas, support them during uncertain times, cultivate creative work and demonstrate to employees that acting creatively is not so risky. Transformational leaders assess the individuality context and the unique perspectives (Bass, 1985) and

subsequently build an environment which encourages the employees not to fear and to feel comfortable with creative activities.

*Hypothesis 3: Lateral and transformational leadership can yield sustainable creativity towards innovation*

Development employee problem solving skills, is an important element for the contemporary organizations. It is often mentioned that organizations are not that effective in innovating independently, and are often accused of having insufficient internal capabilities for facing the challenges of the external dynamic environment which is constantly changing (Hyypiä & Parjanen, 2013). The nominated leader are usually the ones who promote agility, rationality, systematical thinking, and approaching problems cautiously. The leader approaches problems spherically before proposing potential solutions or guiding its subordinates; and considers all perspectives. S/he then proposes new approaches for examining how to complete the tasks and encourages the re-evaluation of ideas which had not been argued properly in the past (Bass & Avolio, 1994). In this way the leader stimulates his subordinates to come up with creative ideas by questioning assumptions, re-evaluating problems and approaching old issues in new and perhaps innovative ways. Rank et al. (2009) found that transformational leadership has had meditating effects on employees with low self-esteem, increasing their motivation and making them more innovative.

*Hypothesis 4: Superiors' guidance to subordinates towards creative problem solving ideas positively affects their ability to overcome barriers that hinder innovation*

Jaques (2009) argues that managerial hierarchy is the most difficult, albeit efficient and factually the most normal structure large organisations have ever invented. Properly structured organisations in terms of hierarchy can motivate employees to come up with creative ideas normalize productivity and improve moral. Furthermore, Jaques (2009) stresses that the mould where organisations are casted in, utilises people to work, and in order to utilise them effectively it employs managerial hierarchies' systems. In this sense organisations keep the employees accountable to get their job done. Quite few other or adjacent mechanisms are presented in extant literature, which charismatic CEOs could use so as to influence organisations performance. For instance an inspirational and tangible vision could intrigue the employees, and various other stakeholders to increase their motivation level, as well as their commitment to serve the organisation even better (Shamir et al., 1993). Furthermore, when they demonstrate confidence in their employees' efforts and capabilities CEOs could maximise motivation (House, 1977). Organisations with solid identity i.e. having a strong brand, is a key element for organisational identification (Ashforth et al., 2008; Kreiner & Ashforth, 2004) and very likely to affect positively employee motivation for creativity (Shamir et al., 1993).

*Hypothesis 5: Employee motivation and facilitation towards creative idea generation and implementation is a key function of organizational structure.*

## **METHODOLOGY**

Towards this research both qualitative (interviews) and quantitative (survey) data have been employed, with their combination providing more comprehensive analyses on the research subject. Through the applied triangulation method the quantitative and qualitative data have been mixed so as to enrich the research analyses and discussion of the research subject (Robson, 2002; Tashakkori and Teddlie, 2003).

The survey sample is purposive and is composed of 114 responses for both closed type and in-depth interview questionnaires. The sample consists of employees who are currently employed in multinational and large size companies, which operate in the sectors of construction, manufacturing and services. For practicality purposes a convenience representative sample was chosen.

For the completion of this research we distributed the closed type questionnaires via the web so as to collect the quantitative data. In the meantime, several interviews were carried out for the collection of the qualitative data. The next stage, after the collection of the primary data was to run the statistical analyses on the responses of the closed type questionnaires via SPSS and align them with the measurement model.

Firstly, we have measured the respondents and carried out the frequency analysis of the demographics data, so as to obtain the majority of the respondents' characteristics. Following we have carried out a factor and reliability analysis through SPSS so as to confirm the coherence and the quality of the quantitative data we have collected. The factor and reliability analysis helped create a research model for the analyses of the results; and employed a retrogression measurement model to test the research hypothesis. Subsequently, retrogression analysis carried out via SPSS concluded the final group of the quantitative data, which is composed by the following elements: (1) Creativity, (2) Lateral-shared leadership, (3) Hierarchy incentives, (4) Hierarchy supporting, (5) Hierarchy Motivation, (6) Leadership bridging gaps, (7) Leadership inspiration. These elements contain both dependent and independent variables examined in this research, with the SPSS analysis identifying the interrelation between these. The main advantage of the retrogression technique is that it can reduce huge amounts of raw data into more actionable informations, and with the aid of SPSS we also made sure that that quantitative data matched perfectly with the model, and that the model is seamless.

Following the analysis of the quantitative data, we deployed and injected the qualitative ones in order to reinforce the results from the quantitative data and the research hypotheses. For the collection of the qualitative data we have used ten questions which aimed to derive the perception and the views of the respondents on the research subject. The ten questions purposefully have common ground with some of the questions of the closed type questionnaire in order to achieve (a) coherency between the qualitative and quantitative data, (b) alignment between qualitative data and the research model, and (c) results alignment

## RESULTS, DISCUSSION AND FINDINGS

### *Measurement model*

The below model (figure 1) has emerged naturally from from the research hypotheses as well as from both the quantitative and quanlitative data. Initially we have checked the correlation between the dependent and un-dependent variables, based on the significance column in the coefficient matrix. In the first selection, 'creativity' is the dependent variable and the predictors are 'self-motivation', 'hierarchy-motivation', 'lateral leadership', 'hierarchy supporting', 'hierarchy incentives', 'job satisfaction', 'leadership bridging gaps', and 'leadership inspiration' (see table 1). In the second selection, the dependent variable is 'job satisfaction', and the predictors are 'hierarchy-motivation', 'hierarchy supporting', 'hierarchy incentives', 'leadership bridging gaps', 'lateral leadership', and 'leadership inspiration' (see table 2)

**Figure 1: The Measurement model**



### *Quantitative Research Findings*

The quantitative results revealed that the dependent variable 'creativity' is driven by two predictors. The first one is self-motivation and the second is job satisfaction. Based on the SPSS results, self-motivation is driven by the inherent will of the employee to be motivated, or perhaps s/he is inspired by the intrinsic incentives or rewards s/he obtains from her/his work and thus her/his motivation level grows more and more. Self-motivation is the process where the employee evaluates her/his performance based on the targets to be achieved, timeline, budget and other critical for her/his evaluation elements. This form of motivation, mainly operates via internal comparison processes, and requires setting personal standards which are able to evaluate the employee performance (Bandura & Shunk, 1981). The dependent variable job satisfaction is driven by three predictors, hierarchy incentives, lateral-shared leadership and leadership bridge gaps. The significance value of all the above mentioned predictors lies below the 0,05, which is the threshold that discloses the relation of the dependent variable from its predictors. More specifically the significance level of predictors' job satisfaction and self-motivation is 0,019 and 0,018 respectively when creativity is the dependent variable

**Table 1: Creativity predictors and coefficients**

a. Dependent Variable: Creativity

b. Predictors: (Constant), Self\_motivation, Hierarchy\_Motivation, Teamwork, Hierarchy\_supporting, Hierarchy\_incentives, Job\_Satisfaction, Leadsrship\_bridging\_gaps, Leadsrship\_inspiration  
Coefficientsa

Model		Sig.
1	(Constant)	,000
	Hierarchy_Motivation	,223
	Hierarchy_supporting	,545
	Hierarchy_incentives	,791
	Leadsrship_inspiration	,621
	Leadsrship_bridging_gaps	,225
	Teamwork	,654
	Job_Satisfaction	,019
	Self_motivation	,018

Based on the results depicted above (table 1) there is a positive relation between the dependent variable 'creativity' and the predictors job satisfaction and self motivation. The employees perceive the two predictors (job satisfaction and self motivation) as key drivers leading them to creativity. What is more the significance level of predictors hierarchy incentives, lateral-shared leadership and leadership bridging gaps is 0,004 – 0,001 and 0,067, when job satisfaction is the dependent variable.

**Table 2: Job satisfaction predictors and coefficients**

a. Dependent Variable: Job\_Satisfaction

b. Predictors: (Constant), Teamwork, Hierarchy\_incentives, Hierarchy\_supporting, Hierarchy\_Motivation, Leadsrship\_bridging\_gaps, Leadsrship\_inspiration  
Coefficientsa

Model		Sig.
1	(Constant)	,015
	Hierarchy_Motivation	,929
	Hierarchy_supporting	,467
	Hierarchy_incentives	,004
	Leadsrship_inspiration	,224
	Leadsrship_bridging_gaps	,067
	Lateral, shared leadership	,001

Based on the above outcome, the drivers which make employees feel satisfied with their job are both leadership and hierarchy. The employees feel satisfied with their job when hierarchy provides them with adequate incentives in order to carry out their job. Furthermore, they praise the leadership styles which bring them closer with their leaders and make them cooperate even better with their colleagues. Hence, based on the above mentioned results, the predictors can drive the dependent variables towards the desired results.

#### *Injecting the Qualitative Research Results: Discussion and Findings*

Based on our model and research findings it appears that creativity is highly dependent on self-motivation and job satisfaction. Self-motivation can be considered as an inherent merit of employees which drives them towards creativity. Whereas job satisfaction, is driven by leadership and hierarchy.

Hypothesis 1 and 4 appear aligned with the research findings. Based on the results, leadership can bridge gaps between the regular employees and the superiors, at a level where the employees are satisfied with their job. Following, job satisfaction leads to creativity which can lead both to innovative solutions or efficient problem solving methods. Hence, leadership appears to influence positively both the employees and the superiors in their efforts towards setting goals and working hard to achieve these goals.

Enthusiasm does not appear to be taken too much into account: the majority of the respondents do not come across enthusiasm in their daily working life for the goals to be achieved. However, it turns out that all of them understand the value of being inspired and of demonstrating enthusiasm for the

company goals. Unenthusiastic employees are less willing to engage in tasks, they are dissatisfied and perhaps de-motivated.

Hypothesis 2 and 3 seems to be aligned with the research findings as well. Based on the data analysis there is relation between lateral, shared leadership and job satisfaction which in turn leads to creativity.

Based on the qualitative data the employees communicate often with their peers, subordinates and their managers. They either communicate via well-established processes which support effective communication between the employees, or by building both professional and personal relations. The close and constant communication motivates the employees to come closer and supports the adoption and perhaps materialization of creative ideas. The leaders have actively contributed to the cases where they could share knowledge, experience and in general where they could contribute. The leaders have acted like role models and this action has stimulated the employees to act the same. Furthermore, the leaders have encouraged the employees to emphasize more to develop creativity and communication in the organization.

Problems that arise at work potentially disorganize employees and engage more resources to resolve them. Based on the qualitative data below, the problems arising at work are dealt with at the team level, and depending on the complexity of the problem they are then elevated to higher levels within the organization. The employees share their experience, knowledge, skills in order to come up with a creative solution to the problems and adopt a more proactive approach to avoid repetition. What is more, they use the tools, procedures and all organizational means available to solve a problem efficiently and before it escalates. Subsequently, they try to adopt proactive/preventive methods.

Based on the quantitative results the incentives a properly hierarchically structured organization provides leads to job satisfaction, an outcome aligned with the fifth hypothesis. The employees, therefore, are satisfied with their job when they receive either intrinsic or extrinsic rewards. Based on the qualitative data, employees appear engaged in their organisation, and committed to generating new ideas, which could lead to innovative solutions. They are close to their customers, they understand the significance of their needs and they strive to fulfil them. Furthermore, their organisation provides them the tools they need to carry out their job and to become creative.

Communication between employees and their superiors also appears good. Superiors are close to employees, guiding them by sharing the organizations goal and try to help them overcome the barriers they come across in their daily working life. Superiors provide adequate incentives to the employees, both intrinsic and extrinsic. The former are: challenging tasks, close communication,



support, good relationship backed up by trust, smart and tangible goals, and constant review of their performance. The latter are: annual bonuses and non-monetary incentives like days off.

Hence, the organization and thus the hierarchy across the various layers of the organization provide adequate incentives, thereby boosting their performance and motivation level. Furthermore, employees feel free to express business related ideas they might have, and this approach seems to be encouraged by their entire organization as well. Furthermore, creative ideas are taken seriously into account and creative employees are rewarded.

## **CONCLUSIONS & RESEARCH LIMITATIONS**

There are several contributors which make the employees feel motivated so as to yield creative solutions. This research concludes that employees in Greece have a positive perception of the motivation and creativity notions, and believe they are essential to the work place. Moreover, the incentives provided make employees feel satisfied with their job and in turn they become creative. This is something we have seen in the quantitative data analyses and in the qualitative data as well. Further, employees utilize the processes and procedures their organization towards the above ends. Employees have a good relation with and feel close to their leaders, and enjoy cooperating with their colleagues in order to achieve a common goal. However, they miss the enthusiasm element, or perhaps they prefer to utilize their powers otherwise to 'survive' in a competitive environment. Evidently, employees have developed self-motivation skills, which often lead them to creativity. First and fourth hypotheses arise to be true, as the employees feel they are close with their superiors, they are satisfied with their job and they work in a creative way which leads them to innovation. Furthermore the workplace is overwhelmed by positivism as the gaps between the lower and higher levels are bridged.

Employees appear to be excited when it comes to cooperating with other peers, subordinates and superiors. They acknowledge the value of lateral and shared leadership where employees with various skills, different expertise, education and seniority level join forces, and they work as a team for achieving a common goal. They prefer to leave aside personal issues and any other kind of barriers which hinder goal achievement, and instead they prefer to work as a team, act creatively towards reaching an innovative solution. So the second and third hypotheses are true as well.

Properly structured organizations support motivation for creativity. Based on both the quantitative and qualitative data, the hierarchy provides adequate incentives to employees to become creative; hence the fifth hypotheses is proven true as well. This outcome shares also some common ground

with some of the abilities of the transformational and transactional leaders to motivate the employees for creativity.

Finally the objective of this study and the research hypotheses are aligned with the research findings. Employees perceive the authentic, transformational, transactional leaders as well as the lateral shared leadership as positive styles of leadership, which strengthen their motivation for creativity. Furthermore the employees are satisfied with well-structured organizations which provide them the desired incentives they need in order to become creative. Finally, self-motivation has not been considered by this research, however, from the primary data it emerged that employees are empowered with the inherent merit of self-motivation towards creativity and innovation.

The research has some limitations, largely stemming from as yet unrefined nature of terms and their explicit interrelationship; which also partly constitute further research directions. Further to the obvious limitation of the rather constricted sample, the first limitation stems from the disproportionate focus on larger and multinational organisations, calling for further research with a more distinct SME focus. The second limitation relates to the model's self-motivation element, which remains unexplored with regards to its drivers and its relationship with creativity and innovation. The third limitation stems from the research's combination of leadership styles and hierarchy. Further research may focus on a specific leadership style to draw more explicit conclusions. Finally, the qualitative data have given rise to 'enthusiasm' as a critical factor of creativity, which is, albeit, insufficiently explored herein and could constitute an enticing area to research.

Overall, the research has successfully interlinked the organizational elements of leadership style, structure, motivation, creativity and innovation, in the specific context of Greek businesses, and at a time when the specific context is characterized by idiosyncrasies stemming from the rather extreme socio-economic conditions. And while this scientific accomplishment lacks the degree of accuracy and refinement to produce absolute and unquestionable conclusions, it does pave the way, setting the foundation for further research to follow.

## REFERENCES

- Amabile, T. M. (1988), "A model of creativity and innovation in organizations." *Research in Organizational Behavior*, Vol. 10, pp. 123-167.
- Amabile, T. M. (1998), "How to kill creativity", *Harvard Business Review*, Vol. 76, No. 5, pp. 76-87.
- Amabile, T. M., Conti, R., Coon, H., Lazenby, J. and Herron, M. (1996), "Assessing the work environment for creativity", *Academy of Management Journal*, Vol. 39, No. 5, pp. 1154-1184.
- Amabile, T. M., Schatzel, E. A., Moneta, G. B. and Kramer, S. J. (2004), "Leader behaviors and the work environment for creativity: Perceived leader support", *The Leadership Quarterly*, Vol. 15, No. 1, pp. 5-32.
- Ashforth, B. E., Harrison, S. H., and Corley, K. G. (2008), "Identification in organizations: An examination of four fundamental questions", *Journal of Management*, Vol. 34, No. 3, pp. 325-374.

- Avolio, B.J., Gardner, W.L. (2005), "Authentic leadership development: Getting to the root of positive forms of leadership", *The Leadership Quarterly*, Vol. 16, p.p 315 - 338.
- Baek-Kyoo, B.J., Gary, N.M. and Baiyin, Y. (2013), "Creativity and Human Resource Development: An Integrative Literature Review and a Conceptual Framework for Future Research", *SAGE Publications*, Vol. 12, No.4, pp. 390-421.
- Bandura A, Dale, H. S. (1981), "Cultivating competence, Self-efficacy, and intrinsic Interest Through proximal Self-motivation", *American Psychological association Inc*, Vol. 41, No. 3, pp. 586-598
- Bass, B. M., and Avolio, B. J. (1994), *Improving organizational Effectiveness through Transformational Leadership*. Thousand Oaks, CA: Sage Publications, Inc.
- Bass, B. M., and Riggio, R. E. (2006), *Transformational leadership* (2nd ed.). New Jersey, USA: Lawrence Erlbaum Associates, Publishers.
- Bass, B. M. (1985). *Leadership and performance beyond expectations*. New York: Free Press.
- Bass, M.B., Jung, D.I., Avolio, B.J., Berson, Y. (2003), "Predicting Unit Performance by Assessing Transformational and Transactional Leadership", *Journal of Applied Psychology*, Vol. 88, No. 2, pp. 207-218.
- Birasnav, M., Rangnekar, S., and Dalpati, A. (2011), "Transformational leadership and human capital bene-fits: The role of knowledge management", *Leadership & Organization Development Journal*, Vol. 32, No. 2, pp. 106-126.
- Bligh, M. C., Pearce, C. L. and Kohles, J. C., (2006), "The importance of self- and shared leadership in team based knowledge", *Journal of Managerial Psychology*, Vol. 21, No. 4, pp. 296-31.
- Bresciani, S., Thrassou, A. and Vrontis, D., (2013), *Mindset and Behaviour Effect on Firm Performance*, in Vrontis, D. and Thrassou, A. (eds), *Innovative Business Practices: Prevailing a Turbulent Era*, UK: Cambridge Scholars Publishing (ISBN 10: 1-4438-4604-X)
- Černe, M., Jaklič, M. and Škerlavaj, M. (2013), "Authentic leadership, creativity, and innovation: a multilevel perspective.", *Leadership*, Vol .9, No. 1, pp. 63 - 85.
- Chebbi, H., YChebbi H., Yahiaoui, D., Thrassou, A. (2017), *Multi-Country Collaborative Innovation in the Internationalisation Process*, *International Marketing Review*, Vol. 34, Iss. 1
- Chebbi, H., YChebbi H., Yahiaoui, D., Vrontis, D., Thrassou, A. (2016), *The Impact of Ambidextrous Transformational Leadership on the Internationalization of Emerging Market Firms (EMF)*, *Thunderbird International Business Review*
- Conger, J. A. (1990), "The dark side of leadership", *Organizational Dynamics*, Vol. 19, No.2, pp. 44-55.
- Cox, J.F., Pearce, C.L. and Perry, M.L. (2003), "Toward a model of shared leadership and distributed influence in the innovation process: how shared leadership can enhance new product development, team dynamics and effectiveness", in Pearce, C.L. and Conger, J.A. *Meso-level model of leadership* 313 (Eds), *Shared Leadership: Reframing the How's and Whys of Leadership*, Sage Publications, Thousand Oaks, CA, pp. 48-76.
- Crossan, M. M., and Apaydin, M. (2010), "A Multi-Dimensional Framework of Organizational Innovation: A Systematic Review of the Literature", *Journal of Management Studies*, Vol. 47, No. 6, pp. 1154-1191.
- Detert, J. R., & Burris, E. R. (2007). "Leadership behavior and employee voice: Is the door really open?" *Academy of Management Journal*, Vol. 50, pp. 869 - 884.
- Dikshit, A. Y. and Dikshit, P. A. (2014), "A Theoretical study of leadership development at workplace", *International Journal of Advanced Research in Management and Social Sciences*, Vol. 3, pp. 39 - 52.
- Fisher, R. and Sharp, A. (2009), "Lateral leadership: Getting it done when you are not the boss", *Profile books LTD*.
- Fletcher, J.K. and Ka'ufer, K. (2003), "Shared leadership: paradox and possibility", in Pearce, C.L. and Conger, J.A. (Eds), *Shared Leadership: Reframing the Hows and Whys of Leadership*, Sage Publications, Thousand Oaks, CA, pp. 21-47.
- Ford, C. M., & Gioia, D. A. (2000), "Factors influencing creativity in the domain of managerial decision making", *Journal of Management*, Vol.26, pp.705-732.
- Gagne, M., and Deci, E. L. (2005), "Self-determination theory and work motivation", *Journal of Organizational Behavior*, Vol. 26, pp. 331-362.
- Gardner, W., Avolio, B., Luthans, F., May, D., & Walumbwa, F. (2005), "Can you see the real me? A self-based model of authentic leader and follower development.", *The Leadership Quarterly*, Vol. 16 No. 3, pp. 343-372.
- George, B., Sims, P., McLean, A., & Mayer, D. (2007), "Discovering your authentic leadership." *Harvard Business Review*, Vol. 85 No. 2, pp. 129-138.
- George, J. M. (2007). "Creativity in organizations." *The Academy of Management Annals*, Vol. 1, pp. 439-477.
- Gilley, A., Gilley, W. J. and McMillan, S. H. (2009), "Organizational Change: Motivation, Communication, and Leadership Effectiveness", *Wiley Inter Science, Performance Improvement Quarterly*, Vol. 21 No. 4, pp. 75 - 94.

- Gong, Y., Huang, J. C., and Farh, J. L. (2009), "Employee learning orientation, transformational leadership, and employee creativity: the mediating role of employee creative self-efficacy.", *Academy of Management Journal*, Vol. 52, No. 4, pp. 765-778.
- Gumusluoglu, L., and Ilsev, A. (2009), "Transformational leadership, creativity, and organizational innovation", *Journal of Business Research*, Vol. 62, No. 4, pp. 461-473.
- Herrmann, D. and Felfe, J. (2014), "Effects of Leadership Style, Creativity Technique and Personal Initiative on Employee Creativity", *British Journal of Management*, Vol. 25, pp. 209-227.
- House, R. J. (1977), "A 1976 theory of charismatic leadership", In J. G. Hunt, & L. Larson (Eds.), *Leadership: The cutting edge* (pp. 189-207). Carbondale, IL: Southern Illinois University Press.
- Hyypiä, M. and Parjanen, S. (2013), "Boosting Creativity with Transformational Leadership in Fuzzy Front-end Innovation Processes", *Interdisciplinary Journal of Information, Knowledge, and Management*, Vol. 8, pp. 21-41.
- Ilies, R., Morgeson, F. P., & Nahrgang, J. D. (2005), "Authentic leadership and eudaemonic well-being: Understanding leader-follower outcomes", *The Leadership Quarterly*, Vol. 16 No. 3, pp. 373- 394.
- Jaques, E. (1990), "In Praise of Hierarchy", *Harvard Business Review*, pp. 127 - 133.
- Kreiner, G. E., and Ashforth, B. E. (2004), "Evidence toward an expanded model of organizational identification", *Journal of Organizational Behavior*, Vol. 25, No. 1, pp. 1-27.
- Mumford, M., and Gustafson, S. (1988), "Creativity syndrome: Integration, application, and innovation", *Psychological Bulletin*, Vol. 103, pp. 27-43.
- Mumford, T., Campion, M., and Morgeson, F. (2007), "The leadership skills strataplex: Leadership skill requirements across organizational levels", *The Leadership Quarterly*, Vol. 18, No. 2, pp. 154-166.
- Oldham, G. and Cummings, A. (1996), "Employee creativity: Personal and contextual factors at work", *Academy of Management Journal*, Vol. 39, No. 3, pp. 607-634.
- Pearce, C. L., Conger, J. A. and Locke, E. A. (2007), "Shared leadership theory", *Management Department Faculty Publications, Leadership Quarterly*, Vol. 18, No. 3, pp. 281-288.
- Pearce, C.L. and Manz, C.C. (2005), "The new silver bullets of leadership: the importance of self and shared leadership in knowledge work", *Organizational Dynamics*, Vol. 34 No. 2, pp. 130-40.
- Rank, J., Nelson, N. E., Allen, T. D. and Xu, X. (2009), "Leadership predictors of innovation and task performance: Subordinates' self-esteem and self-presentation as moderators", *Journal of Occupational & Organizational Psychology*, Vol. 82, pp. 465-489.
- Rosing, K., Frese M. and Bausch, A. (2011), "Explaining the heterogeneity of the leadership-innovation relationship: ambidextrous leadership", *Leadership Quarterly*, Vol. 22, pp. 956- 974.
- Robson, C., (2002) *The analysis of qualitative data*. In: *Real World Research: A Resource for Social Scientists and Practitioner-researchers*. Wiley-Blackwell
- Rossi, M., Thrassou, A., Vrontis, D., (2013), *Open Innovation System and New Form of Investment: Venture Capital's Role in Innovation*, in Vrontis, D. and Thrassou, A. (eds), *Innovative Business Practices: Prevailing a Turbulent Era*, UK: Cambridge Scholars Publishing (ISBN 10: 1-4438-4604-X)
- Santoro, G., Vrontis, D., Thrassou, A., Dezi, L. (2017). *The Internet Of Things: Building Knowledge Management Systems For Open Innovation And Knowledge Management Capacity, Technological Forecasting and Social Change*, DOI information: 10.1016/j.techfore.2017.02.034
- Shalley, C. E., Gilson, L. L., and Blum, T. C. (2000), Matching creativity requirements and the work environment: Effects on satisfaction and intentions to leave", *The Academy of Management Journal*, Vol. 43, No. 2, pp. 215-223.
- Shalley, CE and Gilson LL. (2004), "What leaders need to know: A review of social and contextual factors that can foster or hinder creativity", *The Leadership Quarterly*, Vol. 15, No. 1, pp. 33-53.
- Shamir, B., House, R. J., and Arthur, M. B. (1993), "The motivational effects of charismatic leaders: A self-concept based theory", *Organization Science*, Vol. 4, No.4, pp. 577-594.
- Sosik, J. J., Kahai, S. S., and Avolio, B. J. (1998), "Transformational leadership and dimensions of creativity: Motivating idea generation in computer-mediated groups", *Creativity Research Journal*, Vol. 11, No. 2, pp. 11-121.
- Taggar, S. (2002), "Individual creativity and group ability to utilize individual creative resources: A multilevel model", *Academy of Management Journal*, Vol. 45, pp. 315-330.
- Treffinger, D., M. Tallmann and S. C. Isaksen (1994), "Creative problem solving: an overview". In M. A. Runco (ed.), *Problem Finding, Problem Solving, and Creativity*, pp. 223-236. Norwood, NJ: Ablex.
- Vrontis, D., Thrassou, A. and Razali, M. Z. (2010), "Internal Marketing as an Agent of Change - Implementing a New Human Resource Information System for Malaysian Airlines", *Journal of General Management*, Vol.36, No. 1, pp. 21-41 (ISSN: 0306-3070- Braybrooke Press).

- Walumbwa, F. O., and Hartnell, C. A. (2011), "Understanding transformational Leadership - employee performance links: the role of relational identification and self-efficacy", *Journal of Occupational and Organizational Psychology*, Vol. 84, No.1, pp. 153 - 172
- Wilson-Evered, E., Härtel, C. E. H., & Neale, M. (2004). Leadership and innovation surfacing synergies among theories and constructs. In A. B. Ghobadian, N. O. Regan, D. Gallear, & H. Viney (Eds.), *Strategy and performance: Achieving competitive advantage in the global market place* (pp. 268-285). Palgrave Macmillan, Basingstoke.
- Wilson-Evered, E., Hartel, C. E. J., and Neale, M. (2001), "A longitudinal study of workgroup innovation: The importance of transformational leadership. In M. D. Fottler, G. T. Savage, & J. D. Blair (Eds.), *Advances in health care management* (Vol. 2, pp. 315-340). Amsterdam: Elsevier Science.
- Zhou, J. and Hoever, I. J. (2014), "Research on Workplace Creativity: A Review and Redirection", *Annu. Rev. Organ. Psychol. Organ. Behav.*, Vol. 1, pp. 333-359.

## EXAMINING THE ECONOMIC FACTORS THAT INFLUENCE THE TECHNICAL EFFICIENCY IN GOAT FARMS IN GREECE.

**Tsiouni, Maria<sup>1</sup>; Aggelopoulos, Stamatis<sup>2</sup>; Papanagiotou, Evangelos<sup>1</sup>; Chioteris, Cpyridon<sup>2</sup>**

<sup>1</sup>Department of Agricultural Economics, Faculty of Agriculture, Aristotle University of Thessaloniki, Thessaloniki, Greece

<sup>2</sup>Department of Agricultural Technology, Alexander Technological Educational Institute of Thessaloniki, Thessaloniki, Greece

### ABSTRACT

This paper explores the economic factors that influence the Technical Efficiency in goat farms in Greece. The method applied for the microeconomic analysis is DEA. The selected research area is the geographical region of Thessaloniki, where a large number of goat farms are concentrated. The research data was collected by using questionnaires and through personal interviews with the “heads” of the goat farms. The analysis of farm efficiency showed that the majority of goat farms exhibit technical inefficiency, which can improve by reducing inflows by 24% in short terms and 32% in long term, keeping in both cases the same level of production. Due to the existence of increasing returns to scale the increase of the number of animals in goat farms would reduce production costs and improved financial results. If the farms wanted to eliminate their technical inefficiency they could reduce the feed cost. In a hypothesized reduction of 10% in the feed cost, the technical efficiency will be increased by 17%.

*Keywords: Technical Efficiency, Data Envelopment Analysis (DEA), Economic Factors, Goat farming*

### INTRODUCTION

Goat farming in Greece plays an important role in the development of the country with a relatively high contribution to the Gross value of livestock production (16%) (Greek Statistical Service, 2011).

Greece holds the ninth position in world production of goat's milk, and at the same time it's third among the EU countries, after France. The total number of goats in the country is around 4.8 million (FAO, 2009). The number of livestock farms in Greece is very important and most of them are in Macedonia, Thessaly and Thrace. According to FAO (2011), around 45% of the total number of EU goats is reared in Greece.

A large proportion of goat milk and meat production takes place in mountainous and disadvantaged areas in Greece, which are characterized by poor resources in comparison to other rural areas and remoteness from main centers of population. Livestock production, which is largely extensive, is one of the main economic activities in such areas and is considered to be a potential option for rural development (Aggelopoulos et al., 2009; Tzanopoulos et al., 2011)

Goat farming has a major financial impact, due to: a) the production of large product quantities of a high biological and dietary value, b) the fact that it provides employment and an adequate stable income to a large number of animal breeders, and c) the creation of added value through the processing and trading of goat's meat and milk (Aggelopoulos et al., 2009).

The major production system in the sector can be characterized as pastoral -extensive, which is characterized by low inputs. Indeed, Greece is the only European country where the extensive system is the most common, against the semi-intensive and intensive system which have primarily been adopted in other European countries with developed dairy goat. Also, while in the EU the goat breeding is mainly for the meat in our country milk production is in the first place, while meat production is regarded as a secondary activity.

Despite the high productivity and high quality of products, the goat industry shows low competitiveness due to high production costs compared to other EU countries (Vlontzos et al., 2006; Aggelopoulos et al., 2009). This fact implies the reduced efficiency and the low competitiveness of the industry.

In recent years the number of goats and the average production has decreased (Min. Of Rural Development and Food, 2011). Approximately 76% of goat holdings in Greece are no viable, while 11% are marginally viable (Arsenos, 2012). The business development rates in the sector are small, resulting in reduced competitiveness and sustainability. The level of competitiveness and sustainability of goat farming is influenced by the level and structure of the invested capital, the funding profile, the degree of utilization of available production factors, and also from the productivity and economics. Most farms in Greece operates under increasing scale, is therefore required increase in size in to achieve lower manufacturing costs and improved profitability (Theocharopoulos et al., 2007). The total cost of production in goat farms become from feed costs, annual stocking costs, annual costs of fixed assets and the remuneration of labour (Kitsopanidis, 2006). Therefore, any business development efforts in the sector will be associated with the reduction of production costs, as well as the investigation of financial identity in order to determine the structural characteristics of the goat farming.

The aim of this study is to examine the current state of goat farming in Greece, to identify factors that affect its profitability and analyze the efficiency of goat farms. Moreover, this study is examines the

processes and economic viability of goat farms quantifying their technical efficiency, with a view to suggesting measures to make goat farming more competitive.

## LITERATURE REVIEW

A number of studies have examined, compared and proposed a variety of methods that can be used in order to analyze the efficiency of farms. It is worth mentioning that many researchers have studied the economics and sustainability of goat sector and the potential for further improvement of the competitiveness.

Technical efficiency (TE) improvement is one of the key factors influencing productivity growth and hence profitability in agriculture (Ha et al., 2001; O'Donnell, 2010). Goat industry research in Greece and other countries has revealed differences in TE suggesting that less efficient farms could benefit from using resources more efficiently.

Theocharopoulos et al. (2007) measured the expenses of the use of production factors and determined the technical efficiency of sheep farms. They determined the potential of reducing production costs by improving technical efficiency of farms, in order to address the elimination of subsidies in the context of CAP measures.

Karagiannis and Galanopoulos (2000), are using the DEA model, in sheep farms in Epirus, in order to evaluate the impact of the milk characteristics in the technical efficiency.

Fousekis et al., (2001), is using the DEA model, determined the overall efficiency on sheep farms in mountainous areas of Greece. To this end, both a Constant Returns to Scale (CRS) and a Variable Returns to Scale (VRS) DEA model has been applied to a sample to 101 farms located in the mountainous areas of Epirus, Sterea, and Thessaly.

Galanopoulos et al. (2011) mentioned that, despite of the diminishing number of transhumance farms, they remain an essential activity in less-favoured and mountainous areas of the country. The article applies DEA (Data Envelopment Analysis) in a sample of transhumance farms in Greece in order to assess the technical efficiency of sheep and goat transhumance flocks and determine the factors that affect their performance.

Gaspar et al. (2008), studied economic factors affecting the livestock farms in Extremadura, in Spain. The data was analyzed using a nonparametric Data Envelopment Analysis (DEA) model. The influence of the European Union's Common Agricultural Policy (CAP) subsidies (taken as an output) on the farms' efficiency was determined. The measurement of the efficiency has taken place from inputs per hectare thus allowing a different interpretation from the scale efficiency that, instead of referring to the dimension of the farm, refers to intensification.



Theodoridis et al. (2012), examined the presence of technical inefficiency in the allocation of resources in Chios sheep farms in Greece and to identify its inefficiencies. Based on farm accounting data from the 58 Greek farms that participate in the Chios sheep breeding program, DEA is applied in order to estimate the level of relative technical efficiency of these farms, which is then used as a classification criterion. The 58 farms are categorized into efficiency groups on the basis of this criterion and their main physical and economic data are analyzed, determining, to some extent, their contribution to the improvement of the level of technical efficiency.

From all of the above, this study was considered appropriate due to limited research in Greece and globally. The investigations that have been made mainly concern the exploration of the socio-economic factors affecting the structure of the sector. The surveys that have been made about the efficiency of the goat industry, are not taking into account the numerical indicators describing the financial and operational situation of a holding.

## **2. MATERIALS AND METHODS**

### **2.1. Case study area**

The selected research area is the geographical region of Thessaloniki, where a large number of goat farms are concentrated. The variety of breeding conditions in this region allows a generalization of the research output for the whole country, with no major deviation from reality.

### **2.2. Case study data**

The research data was collected by using questionnaires and through personal interviews with the "heads" of the goat farms during the years 2015-2016. Stratified random sampling was used to determine the sample (Siardos, 2005), with the regions of Greece representing the strata being studied. The sample consists of 120 goat farms, which is the 19.5% of the goat farms in the study area and 0.17% of the total number of goat farms in the country. The questionnaire completion time was estimated at 60 minutes for each goat farm. The data obtained from the questionnaires were first introduced in Microsoft Office 2010 and specifically in Excell program and then, for the statistical analysis, was used the SPSS 24.

### **2.3. Model specification (DEA analysis)**

Technical efficiency is the effectiveness with which a given set of inputs is used to produce an output. A firm is said to be technically efficient if it is producing the maximum output from the minimum quantity of inputs, such as labour, capital and technology (Farrell, 1957). Technical efficiency represents the ability of a farm to produce the maximum physical output given a set of inputs and technology (Output- Oriented) or, alternatively, to produce the same output with the maximum feasible reductions in inputs given the technology set (Input-Oriented) (Farrell, 1957).

DEA model is based on the use of linear programming, in which attempts to quantify the maximum value of the relative effectiveness of the production units (Coelli et al., 1998). DEA recognizes autonomous administrative units (units decision making) - (DMU) as productive units, which consume inputs and produce outputs. The economic units whose output-input combinations are on the potential production function is technically fully effective, while the degree of technical efficiency (TA) of the other is calculated using the Euclidean distance of the output-input combination from the surface of under production function (Coelliet al., 1998).

The formulation of the present study is input oriented solving the following model:

$$\text{Min}_{\theta, \lambda} \theta$$

subject to  $y_i \geq Y\lambda$

$$\theta x_i \geq X\lambda$$

$$\lambda \geq 0$$

where  $y_i$  is the  $(k \times 1)$  vector of outputs produced and  $x_i$  is the  $(m \times 1)$  vector of inputs used for unit  $i$ .  $Y$  is the  $(k \times n)$  vector of outputs and  $X$  is the  $(m \times n)$  vector of outputs of all  $n$  units included in the sample  $\lambda$  is a  $(n \times 1)$  vector of weights and  $\theta$  is a scalar with boundaries of one and zero that determines the efficiency score of each DMU.

## INPUT AND OUTPUT FACTORS

In this study, the input oriented model is used, which is more appropriate for the purpose of the research, as in the agricultural sector a farmer has more control over input rather than over output levels, which may be exogenously determined. Moreover, the inelastic demand of most agricultural products makes cost reduction a better means of promoting agricultural economic development with respect to output increase.

The model used in order to analyze the efficiency assumes one output (gross margin in €) and five inputs, which represent the key factors of production (labor costs €, feed costs €, variable capital in €, without feed, fixed capital and loans). In the output factor it was not considered subsidies (€) in order to measure the real efficiency of farms, without any regulatory distortions. All variables have been normalized by an additional variable, namely the number of farm animals. Estimates of the degree of technical efficiency was using program DEAP 2.1 (Coelli, 1996). The labour variable includes both family and hired labour. Fixed capital includes all the annual expenses of fixed assets, such as the interest costs, depreciation, maintenance, insurance and some other annual expenses of lesser importance. Feeding expenses include the annual cost of feedstuffs. Gross returns of farms include revenues from goat production such us milk and meat.

## RESULTS

In Table 1, the average total valid observations summed to  $n = 120$ . An analysis of the descriptive statistics reveals that the mean score of gross margin is about 156 €/goat. Labor costs were in about 44 €/goat. Loans were in the range of 2.50 €/goat and the mean score of feed cost were 76.25 €/goat. Fixed capital expenses were about of 38 €/goat. Moreover, the mean score of variable capital expenses without feed were 2.40 €/goat.

Table1. Descriptive statistics per animal

	Mean	Standard Deviation	N
Gross Margin (€)	156.19	27.60	120
Labor (€)	43.87	12.41	120
Loans (€)	2.49	4.92	120
Feed (€)	76.25	26.65	120
Fixed capital expenses (€)	37.70	10.78	120
Variable capital expenses without feed (€)	2.41	1.64	120

The main economic results of goat farms included in table 2, indicate that there is a Loss of 8.15 €/goat. The farm income is about 51 €/goat. The farm family income is about 37 €, while the annuity capital is about 4.70 €/goat. The capital efficiency is 1.81/goat.

These economic results are of great importance for goat farming and its prospects for future growth. The viability of farms in the long run and the prosperity of a sector cannot rely on financial transfers from other economic sectors; instead, it should strive to improve efficiency and consequently increase productivity. A competitive sector can only make contributions towards a genuine and sustainable agricultural development.

Table 2. Economic results of goat farms without subsidies

Economic results	Per animal
Profit/ loss	-8.15
Farm income	50.67
Family farm income	37.11
Annuity capital	4.66
Capital efficiency	1.81

Table 3. Overall Technical Efficiency

Scale of efficiency	Number of goat farms	% of goat farms	Mean	St. deviation
0.1-0.49	27	22.5	0.28	0.15
0.5-0.79	46	38.4	0.66	0.08
0.8-0.99	32	26.6	0.90	0.05
1	15	12.5	1.00	0.00
Total	120	100	0.68	0.26

According to Table 3, the average overall efficiency (or technique CRS efficiency) of goat farms is 0.68 with a standard deviation of 0.26. Moreover, 12.5% of the farms operate efficiently (technical efficiency from CRS,  $crste = 1$ ), which means that in the specific farms no change in inputs will not change gross

annuity. These holdings seem to combine the right amount of input and utilize efficiency using existing technology. The overall technical efficiency relates to the long time period which takes into account the possibility to make changes in the operating range of farms. Approximately 23% of farms shows extremely low efficiency (0.1-0.49). 38% of the farms have a low efficiency (0.50 to 0.79), 27% of farms exhibits satisfactory efficiency (0.80 to 0.99) without however to be regarded as efficient (crste <1).

Table 4. Pure Technical Efficiency

Scale of efficiency	Number of goat farms	% of goat farms	Mean	St Dev
0.1-0.49	23	19.2	0.28	0.31
0.5-0.79	29	24.1	0.67	0.18
0.8-0.99	23	19.2	0.89	0.11
1	45	37.5	1.00	0.00
Total	120	100	0.76	0.27

According to table 4 the average pure technical efficiency is 0.76 with a standard deviation of 0.27. This means that inefficient goat farms proposed to reduce their inputs by 24%. This reduction can be achieved without making scale adjustments and without changing the level of output based on technology that is already widespread among goat farms, some of which use it fully effective. Also, 37.5% of the farms are fully efficiently (technical efficiency from VRS, vrste = 1). 19% of the farms shows extremely low efficiency (<0.1-0.49). 24% has low efficiency (0.50 to 0.79), 19% of farms exhibits satisfactory efficiency (0.80 to 0.99), without being able to be characterized as efficient (crste <1).

The difference between technical efficiency in farms results from the incorrect use of production technology of inefficient farms.

Table 5. Scale Efficiency

Scale of efficiency	Number of goat farms	% of goat farms	Mean	St Dev
0.1-0.49	3	2.6	0.41	0.07
0.5-0.79	16	13.3	0.72	0.13
0.8-0.99	85	70.8	0.93	0.12
1	16	13.3	1.00	0.00
Total	120	100	0.9	0.12

The scale efficiency is 0.9 with a standard deviation of 0.12. Therefore farms have the potential to reduce inputs by 10% without changing the output level if they take the appropriate size adjustments with the standard technology and output level.

As we have already mentioned 62.5% of the farms are technical inefficiency. However, if farms wanted to eliminate their technical inefficiency they could reduce the feed cost. Feed costs have been found to represent the largest share of total expenses and the choice of feed composition has a

significant impact on herd health and quality (Galanopoulos et al., 2006). Moreover, Galanopoulos et al. (2006) found that farms producing their own feed were correlated with lower efficiencies. Additionally, farms producing their own feed can take advantage of economies of scale (Rowland et al., 1998). One of the greatest threats to producer profitability is the cost of feed, which accounts for 40%–60% of total production costs, and can even reach up to 70% of total costs depending on investments made (housing conditions, automatic feeding, etc.) (Gidenne et al., 2017). Feed efficiency is a key criterion to improve the economic sustainability of the farm (Gidenne et al., 2017).

From this, we assumed that reducing feeding is positively correlated with TE.

If it is hypothesized that all farms reduce the feed cost by 10% then the technical efficiency will take the following results (Table 6.)

Table 6. Average technical and scale efficiency measures of goat farms

OTE		PTE		SE	
Mean	St Dev	Mean	St Dev	Mean	St Dev
0.85	0.22	0.93	0.25	0.92	0.14

If the feed cost has a reduction of 10%, then the overall technical efficiency will become 85%, the pure technical efficiency 93% and the scale efficiency 92%.

Enhancing the knowledge on the use of rational feeding systems and on the quality, digestibility and production of animal feed, will lead to the increase of technical efficiency farms. Moreover, the decrease in the feeding costs can be achieved through the elaboration of a balanced and economic feeding system that will be based on the animals' needs. A reduction in animal feed expenses could also be reached by increasing production of at least part of the animal feed required by the farm (Milan et al. 2014).

## CONCLUSIONS

In this article an attempt was made to analyze the technical efficiency of a sample of goat farms in the geographical region of Thessaloniki in Greece, using the nonparametric, input-oriented DEA approach a tool to explore at the microeconomic level the potential shortcomings in the efficiency of Greek goat farms that may create a setback for the sector and hinder its future growth.

The analysis of farm efficiency showed that the majority of goat farms exhibit technical inefficiency, which can improve by reducing inflows by 24% in short terms and 32% in long term, keeping in both cases the same level of production.

Due to the existence of increasing returns to scale the increase of the number of animals in goat farms would reduce production costs and improved financial results. Moreover, if farms wanted to

eliminate their technical inefficiency they could reduce the feed cost. In a hypothesized reduction of 10% in the feed cost, the technical efficiency will be increased by 17%.

In conclusion, if the performance of the farms tends to the unit, less reduction is needed in order to become the holdings efficiency. The inefficient holdings should reduce, to a lower or higher level depending on the class of performance, the capital expenses, the expenses of variable capital, the labour expenses, the feed expenses and the loans. The reduction of labour expenses can be achieved by using mechanising production (e.g. installation of milking systems), a modernisation of the facilities for ergonomic purposes, should lead to a reduction of this cost component. Moreover, in order to lead to the optimum exploitation of feed factor, a well-balanced and inexpensive feeding is recommended. The knowledge of animal feed contents in nutritious ingredients and their suitability as well as efficient mixing, feeding and storage facilities of animal feed should lead to the improvement of the used animal feed. Finally, modernization of building facilities and machinery were not designed rationally, were based on limited data and misleading projections of the future, which finally led to an overestimation of their efficiency.

## REFERENCES

- Aggelopoulos, S., Soutsas, K., Pavlouidi, A., Sinapis, E. and Petkou, D. (2009). Suggestions for Reformation in Sheep Farms based on Production Cost, *Journal of food Agriculture and Environment*, Vol. 7 (No 3 & 4), 561-566.
- Arsenos G. (2012). Goat farming the developing branch of Greek livestock farming: results from the research program SOLID. *Proceedings of the Workshop: The Contribution of goat Farming to Rural Development of Greece: Problems and Prospects*, 2 November 2012, GEOTE, Thessaloniki.
- Coelli, Rao. O'Donnell, Battese (2005). *Introduction to Efficiency and Productivity Analysis*.
- Coelli, T.J.(1995). Recent developments in frontier modeling and efficiency measurement. *Australian Journal of Agricultural Economics*, Vol 39, 219-245.
- EUROSTAT: *Agricultural Statistics – Main Results: 2006–2011*
- FAO: *Statistics in* <http://www.fao.org/corp/statistics/en>, 2009
- FAO: *Statistics in* <http://www.fao.org/corp/statistics/en>, 2011
- FAO: *Statistics in* <http://www.fao.org/corp/statistics/en>, 2013
- Farrell, M. (1957). The Measurement of Productive Efficiency. *Journal of the Royal Statistical Society. Series A (General)*, Vol 120, 253-290.
- Fousekis, P., Spathis, P. & Tsimboukas K, (2001). Assessing the Efficiency of Sheep Farming in mountainous Area of Greece. A non-parametric approach. *Agricultural Economic Review*, Vol 2 (No 2), 5-14.
- Galanopoulos, K., Abas, Z., Laga, V., Hatziminaoglou, I., Boyazoglu, J., 2011. The technical efficiency of transhumance sheep and goat farms and the effect of EU subsidies: Do small farms benefit more than large farms?. *Small Ruminant Research*, Vol 100 (No 1), 1-7
- Gaspar, P., Mesías, F.J., Escribano, M., & Pulido, F. (2008). Assessing the technical efficiency of extensive livestock farming systems in Extremadura, Spain. *Livestock Science*, Vol 121 (No 1), 7–14.
- Gidenne T., Garreau H., Drouilhet L., Aubert C., Maertens L., (2017). Improving feed efficiency in rabbit production, a review on nutritional, technico-economical, genetic and environmental aspects, *Animal Feed Science and Technology*, Vol 225, 109–122
- Ha, A., Strappazon, L., Fisher, W., (2001). What is the difference between productivity and profit? Working paper series. Department of Natural Resources and Environment, Victoria, Australia
- Karagianis, G. and Galanopoulos, K. (2000). Analysis of the impacts of milk qualitative features on the technical efficiency of sheep farms in the region of Epirus. *Proceedings of 6th Greek Congress of Agricultural Economy*, Thessaloniki, 563-574.

- Kitsopanidis, G. (2006). *Animal Production Economics. Principles-Applications Technical-Economic Analysis*. Zitis Publications, Thessaloniki.
- Milan MJ, Frendi Gonzalez-Gonzalez R, Caja G (2014) Cost structure and profitability of Assaf dairy sheep farms in Spain. *Journal of Dairy Science*, Vol 97, 5239–5249
- O'Donnell, C.J., (2010). Measuring and decomposing agricultural productivity and profitability change. *Aust. J. Agr. Resour. Econ.*, Vol 54, 527–560.
- Siardos, G. (2005). *Methodology of Sociological Research*. Zitis Publications.
- Theocharopoulos, A., Melfou, K., Papanagiotou, E. (2007). A microeconomic approach for agricultural development: A DEA application to Greek sheep farms, *New Medit - Mediterranean Journal of Economics, Agriculture and Environment*. Vol. 6 (No 4), 48-54.
- Theodoridis, A., Ragkos, A., Roustemis, D., Galanopoulos, K., Abas, Z. & Sinapis, E. (2012). Assessing technical efficiency of Chios sheep farms with data envelopment analysis. *Small Ruminant Research*, Vol 107 (No 2&3), 85-91.
- Tzanopoulos, J., Kallimanis, A.S., Bella, I., Labrianidis, L., Sgardelis, S., Pantis, J.D., (2011). Agricultural decline and sustainable development on mountain areas in Greece: sustainability assessment of future scenarios. *Land Use Policy*, Vol 28, 585–593.
- Vlontzos, G. & Duquenne N. (2009). Evolution of trade flows for sheep's milk cheese: an empirical model for Greece. In: *International Marketing and International Trade of Quality Food Products*, Edited by M. Canavari, N. Cantore, A. Castellini, E.Pignatti and R. Spadoni, Wageningen Academic Publishers, Netherlands, Ch. 2, 31-42.

# EXPLORING ALTERNATIVE VIEWS ON CLUTCHES OF UKUTHWALA IN THE PATRIARCHAL CULTURE OF SOUTH AFRICA: BALANCING OF HUMAN RIGHTS

Van der, Bank; Christiena, Maria

Vaal University of Technology, South Africa

## ABSTRACT

*Ukuthwala* involves the act of taking a marriage partner in unconventional ways, seemingly forceful ways, sometimes with the sanction of certain adults who have stake in the possibility of formalising a resulting partnership. “Ukuthwala” is a form of abduction that involves kidnapping a girl or a young women by a man and his friends or peers with the intention of compelling the girl or her family to endorse marriage negotiations. This type of kidnapping has become traditionally acceptable, as long as cultural rules are followed.

This study explores alternative views on *Ukuthwala* as contrary to the community’s perception of justice or the legal convictions of society. Abuses of *ukuthwala* have clearly perpetrated without the girl’s consent and have proven to have an adverse effect on her education, health and physical wellbeing. Disadvantages of women and girls are a major source of inequality. Women and girls are discriminated against in health, education and in the labour market which are very negative.

The Bill of Rights in chapter 2 of the Constitution plays an important role in deciding whether conduct of *ukuthwala* is contrary to public policy or the community’s sense of justice and is therefore unlawful. The Constitution guarantees persons who belong to a cultural community the right to enjoy their culture and the right to participate in the cultural life of their choice. However, neither of these rights may be exercised in a manner that is inconsistent with any provision of the Bill of rights and therefore competing rights must be balance.

*Keywords: Constitution, ukuthwala, equality, custom and balancing of rights.*

## INTRODUCTION

There is a huge problem associated with the shift and changing meanings, and also with perceptions of *ukuthwala*. In this study, the researcher is seeking to explore why the practice of *ukuthwala* has come



under intense scrutiny through a growing number of revelations that young girls have contracted HIV after being forced into marriage.

*Ukuthwala* is described as "to carry on head and shoulders or load gripping by the hands" (Doke, Malcolm, Sikakana and Vilakazi, 2008). Other definitions are more figurative and may include a mention of "pregnancy" and "carrying a bride home". It also includes the concept of taking a partner in unconventional ways. Bennet describes *ukuthwala* as one of the unconventional methods of "opening marriage negotiations" (Bennet, 2004). "Ukuthwala" is a form of abduction that involves kidnapping a girl or a young woman by a man and his friends or peers with the intention of compelling the girl or her family to endorse marriage negotiations (Maluleke, 2009). This type of kidnapping has become traditionally acceptable, as long as cultural rules are followed.

There are multiple understandings of what constitutes *ukuthwala* in the different cultures, which are themselves contested. There is paucity in the literature on the beautification of women in the African continent. This gap in the literature has motivated the researcher to raise social awareness about the importance of the *ukuthwala*, and its changing meanings from a Southern African perspective. We believe that the study may contribute to African literature – and also the black feminist movement in South Africa.

It is practised among indigenous African Communities in Southern Africa, in various mutations, within the context of many other customary practices related to marriage. Many of these practices are aimed at satisfying the traditional standards or norms relating to marriage, and sometimes unconventional ways of doing so. The practice of *ukuthwala* is said to be cultural and to have been practiced by indigenous people. However, the way it is practiced currently is illegal and harmful to the wellbeing of young girls (Modisaotsile, 2016).

The overbearing preferences of people who hold traditional or cultural power and control over the lives of young men and women seeking to establish conjugal relationships may be linked to some instances of *ukuthwala*. Popular references to *ukuthwala* as a culture unduly create an impression that the practice is a rigid and formalistic prescript, whereas it was originally devised as an optional safety valve against too extreme a parental authority.

This paper seeks to determine whether *ukuthwala* is a cultural right or a crime perpetrated under the guise of culture. Some of the factors that make the practice occur regardless of the Children's Act, the impacts of the practice on the educational, economic and social well-being of the child are also discussed.

## FEMINIST PERCEPTIONS

Feminism is chosen to form the theoretical framework that undergirds this study. Jane Freedman writes that Feminism is concerned with women's inferior position in society, and with the discrimination encountered by women because of their sex (Freedman, 2001). Estelle Freedman defines feminism as a belief that although women are inherently of equal worth, most societies privilege men as a group (Freedman, 2003). As a result, social movements are necessary to achieve political equality between women and men, with the understanding that gender always intersects with other social hierarchies, such as the perception held by people, and in particular, patriarchal Zulu men.

This study is located within the feminist theories, which hold that although women are inherently of equal worth, most societies privilege men as a group. As a result, social movements are necessary to achieve political equality between women and men, with the understanding that gender always intersects with other social hierarchies (Freedman, 2003).

The literature shows that the perception of a woman's body by patriarchy is an issue that is addressed by feminists. Spivak claims that women have been doubly colonised: *firstly* by their patriarchal culture, and *secondly* by the colonial regime. Patriarchal culture determines how women should look and dress (Spivak, 1988) Morrison (Morrison, 2012) challenges the male-dominated society and encourages women to know their own inside "free person" – and to not permit anybody to decide "who" they have to be.

Mkhwanazi states that the Zulu culture is used to justify indecent behaviours in the modern world (Mkhwanazi, 2008). This shows how patriarchal cultural men undermine women, and how culture is always in favour of men – even when they are in the wrong. Luvuno suggests that societies should be discouraged to stereotype women and for looking at, and treating women, as the subordinates of men (Luvuno, 2004). This gender regime constructs men as being in the dominant and public position within society and it continually allows violence against women and imposes traditional systems of controlling women in the post-colonial nation-state.

Sandi Schultz organised the *Slut Walk* protest that took place in Johannesburg to bring awareness of sexual harassment and violence against women perpetrated in public places. Carr states that the *Slut Walks* is initiated by young Feminists who are furious with victim-blaming, slut-shaming patriarchal cultures (Carr, 2013). Carr posits that the focus must not be on what women wear; but rather it should be on the rape culture (Carr, 2013). Patriarchal custom and tradition often hold the power to determine what is proper and what is not acceptable.

Gender inequality starts early and keeps women at a disadvantage throughout their lives (Worldbank, 2000). Inequality in the lives of women that is deeply imbedded in history, tradition and culture

affects them for the rest of their lives. This also impacts on women's access to and enjoyment of economic, social and cultural rights (International Covenant on Economic, Social and Cultural Rights, 2002).

Aspects of culture are evident in everything we do in our daily lives- from speaking to eating to clothing- yet to define the term is not an easy task. Local cultures and traditions influence the way the custom of early marriage is practiced in different regions, but the causes and consequences are universal (Marry, 2008).

Harmful traditional practices emanate from the deeply entrenched discriminatory views and beliefs about the role and position of women in society. The role differentiation and expectations in society relegate women to an inferior position from birth throughout their lives. Harmful traditional and cultural practices maintain the subordination of women in society and legitimize and perpetuate gender based violence (Wadesango, Rembe and Chabaya, 2011).

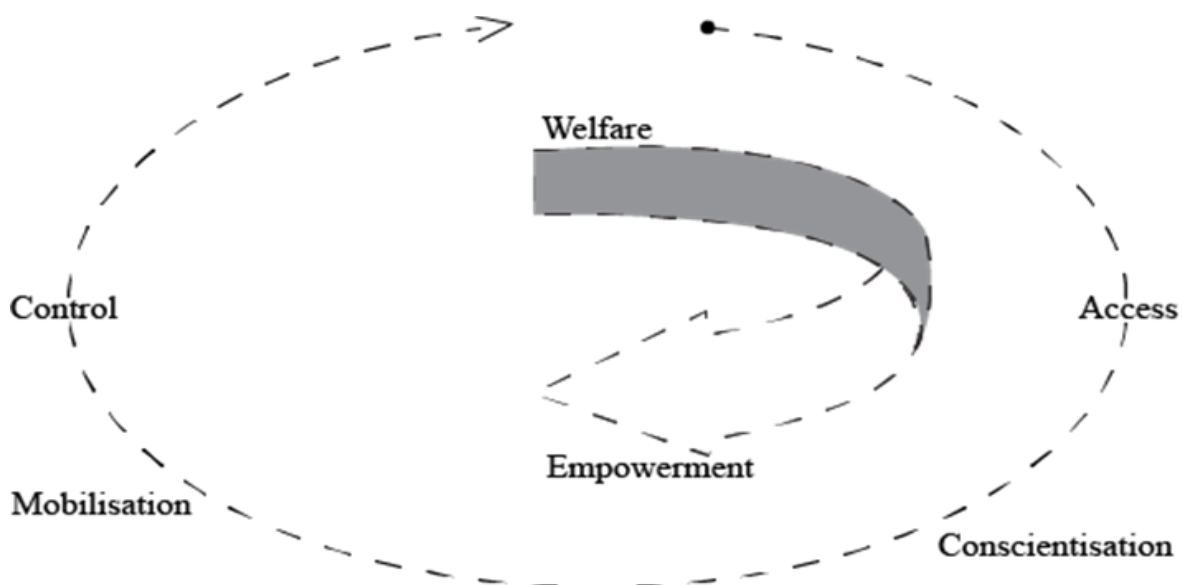

Figure 1: The Women's Empowerment Cycle from an African Feminist perspective

Source: (UNICEF, 2001).

## RESEARCH METHODS

The chosen methodology for this study is qualitative. Qualitative research is concerned with developing explanations of phenomena. It aims to help us to understand the social world in which we live, and why things are the way they are. It is concerned with the social aspects of our world; and it seeks to answer questions about: Why people behave the way they do; how opinions and attitudes are formed; how people are affected by the events that go on around them; and how and why cultures

and practices have developed in the way they have (Hancock, Windridge and Ockleford, 2009). The qualitative research paradigm is relevant for this study, as it assists in understanding the meaning of the phenomenon of *ukuthwala*. It is significant for this study, as it deals with understanding a social issue, which has allowed us to explore how society perceives *ukuthwala* as a social issue, and how people behave and react towards the practice of *ukuthwala* (Homes, 2015).

The qualitative research methodology is important; as it focuses on words and creating meaning, rather than on mere numbers and statistics. This study is based on creating meaning for the practice of *ukuthwala* and reviewing how *ukuthwala* has been seen throughout the years.

## THE CONSTITUTION

South Africa enjoys one of the most progressive Constitutions in the world with numerous organisations that work to protect the rights of women and child (Homes, 2015). The values reflected in the Constitution – such as human dignity, the achievement of equality, and the advancement of human rights and freedoms – are crucial in deciding this issue (Section 2 of The Constitution of South Africa 108 of 1996). It is therefore imperative to review the practice of *ukuthwala* and all its consequences, in particular forced marriages and child marriages and the violence which has come to characterise this practice, in light of the Constitution as the supreme law of the Republic (Section 2 of The Constitution of South Africa 108 of 1996). The supremacy of the Constitution is specifically enunciated by the Founding Provisions of Chapter 1. Section 2 of the Constitution provides that the Constitution is the supreme law of the Republic; law or conduct inconsistent with it is invalid, and the obligations imposed by it must be fulfilled. As regards the interpretation of the Bill of Rights, section 39 (3) provides that the Bill of Rights does not deny the existence of any other rights or freedoms that are recognized or conferred by common law, customary law or legislation, to the extent that they are consistent with the Bill (Section 39 of The Constitution of South Africa 108 of 1996).

Moral values that are crying out for renewal in Africa can be summed up in the principles of human rights, democracy and good governance. These are important in themselves because they enable African people everywhere to realise the values of *ubuntu*. This is the moral principle that promotes social responsibility and solidarity, the duty of care, the virtues of sensitivity, selflessness and devotion to duty, and the vision of a society founded on justice and equality. Kofi Annan, the secretary-general of the United Nations, states emphatically that: Respect for human rights and the rule of law are necessary components to any effort to make peace durable. They are cornerstones of good governance. By signalling its commitment to building a society in which all can live freely, a government can demonstrate its commitment to building a society in which all can live free (Annan, 1999).

Snyman puts forward an argument that we must follow a human- rights-centred approach. In Chapter two of the Bill of Rights it was stated that the Constitution plays an important role in deciding whether conduct is in conflict with public policy or the community's perception of justice and is therefore unlawful (Snyman, 2008).

## **BALANCING COMPETING RIGHTS**

On the one hand, the Constitution recognises that South Africa is not a homogenous society. The Constitution guarantees persons who belong to a cultural community the right to enjoy their culture and the right to participate in the cultural life of their choice. However neither of these rights may be exercised in a manner that is inconsistent with any provision of the Bill of Rights.

In relation to girl children, the Constitution considers everyone below the age of 18 years to be a child, and accords to this category of persons (with a few exceptions) the same rights as those granted to adults. Some of these rights are:

- The right to equality which must be read in conjunction with the Promotion of Equality and Prevention of Unfair Discrimination Act (Act 4 of 2000). This Act prohibits, among other things, customary practices that impair the dignity of women and undermine the dignity and wellbeing of girl children; the Act also prohibits sexual harassment.
- The right to human dignity (The Constitution 108 of 1996).
- The right to freedom and security of the person, which included the right to be free from all forms of violence.
- The right to education (The Constitution 108 of 1996).
- The rights of children in section 28, which include the right to protected from maltreatment, neglect, abuse and degradation, and the right not to be required or permitted to perform or to provide services that are inappropriate for a person of that child's age, or which would place at risk the child's wellbeing, education, physical or mental health or spiritual, moral or social development. Furthermore and most importantly, the Constitution enjoins everyone to take into account the child's best interest in every matter involving a child. The Children's Act elaborates what the principle of the "best interests of the child" entails, providing (for example) that in matters concerning a child, the following factors must be taken into account: the child's age, maturity and stage of development; and the need to protect the child from any physical or psychological harm (Section 7 of the Children's Act 38 of 2005).

The right to enjoy one's culture has been thrown into competition with other rights and inevitably this has led to conflict. The Constitution gives no indication whether other rights supersede cultural

rights; the fundamental rights are not ranked (the Constitution 108 of 1996). The SALRC has considered the interplay between individual rights and group rights in the Constitution, particularly with regard to children, and concluded that:

There can be no doubt that the South African Constitution recognises the importance of customary law to the majority of South Africans. The Commission also accepts the importance of customary law and practices for a very large portion of our population. However, the Commission notes that customary law is recognized as a system of law provided it operates within the broad principles of the Constitution of 1996. Given the fact that the best interest of the child principle in section 28 (Section 28 of the Children's Act 38 of 2005) is paramount and the individualistic nature of human rights protection, it would seem that the right of an individual child supersedes that of cultural or religious group.

## **EMPOWERMENT OF WOMEN**

The world empowerment is used in many different contexts and by many different organisations due to its widespread usage. A review of definitions of empowerment reveals both diversity and commonality. Most definitions focus on issues of gaining power and control over decisions and resources that determines the quality of one's life. Most also take into account structural inequalities that effect entire social groups rather than focus only on individual characteristics. Major issues in measuring women's economic activity include gender-based stereotypes, the employment status of unpaid family workers, the informal sector and rural activities (Vickers, 1997). Bennett developed a framework in which "empowerment" and "social inclusion" are closely related but separate concepts. Social inclusion is defined as the removal of institutional barriers and the enhancement of incentives to increase the access of diverse individuals and groups to assets and development opportunities (Bennett, 2004).

Women contribute to the economy and to combating poverty through both remunerated and unremunerated work at home, in the community and in the workplace. The empowerment of women is a critical factor in the eradication of poverty. In developing countries, industrialisation tends to coexist with agriculture, rather than displacing it. The same is true of family businesses – from farms to small enterprises. In South Africa a vicious circle of debt, inflation, economic stagnation and unemployment has placed the heaviest burden on women.

One of the ways generally advocating is strengthening affirmative action to promote gender equality. Positive steps must be taken to increase the representation of women and minorities in areas of employment, education and business from which they have been historically excluded. Affirmative

action is not about women taking over from men but is a process of sharing and recognising the need to make provisions for equality to all citizens of a country.

Early marriage violates a girl's right of a future and by doing so perpetuates the feminization of poverty (this is a global trend whereby women increasingly and disproportionately are numbered among those that live in poverty) (Thomas, 2007). It does so by denying a girl opportunities and compromising their development in areas such as education, livelihood and personal growth. Loss of schooling is more likely to reduce the chances of lessening household poverty, as a result of loss of both the education and skills necessary for gaining employment.

Education is the key area where many a child bride loses out when they are married too early. In many areas in South Africa girls are withdrawn at puberty often to undertake domestic duties or specifically for marriage (Grant and Hallman, 2008).

## **DOMESTIC LAW**

In the Republic, customary marriages are regulated by national legislation that was enacted after the advent of constitutional dispensation, and by laws promulgated by the former Transkei, Bophuthatswana, Ciskei, and by KwaZulu and Natal (Schedule 6 of the Constitution of South Africa 108 of 1996). Whether or not the marriage laws enacted by these self-governing territories and independent states should continue to exist, despite the coming into operation of the Recognition of Customary Marriages Act, is an issue beyond the scope of this investigation; the SALRC does not wish to express any view in that regard. The Children's Act, to the extent that it deals with the marriages entered into by children, will also be considered here (The Children's Act 39 of 2005).

There are serious gaps in the legislation, particularly in national legislation, which could exacerbate the abuse of *ukuthwala*. The various laws listed in this paragraph are considered below.

## **RECOGNITION OF CUSTOMARY MARRIAGES ACT**

In view of the fact that *ukuthwala* is a prelude to a customary marriage and should eventually lead to such a marriage, the essentials of a valid customary marriage as set out in the Recognition of Customary Marriage Act must be complied with (Section (3) of the Recognition of Customary Marriages Act). The Act clearly states that the parties to a customary marriage must be older than 18 years, and that they must both consent to the proposed marriage (Section (3)(1) of the Recognition of Customary Marriages Act). This Act also makes it possible under a number of provisions for people under the age of 18 to conclude a valid customary marriage. The Minister of Home Affairs or a person by him or her grant permission to a person under the age of 18 to marry, if such a marriage is desirable and in the interest of the prospective spouses (Section 3(4) of the Recognition of Customary

Marriages Act). *Ukuthwala* does not meet this requirement or the age requirement and is not a valid marriage arrangement in terms of the Marriage Act or the Recognition of Customary Marriages Act.

## REGISTRATION AND DETERMINATION OF AGE

The requirement of consent in the Recognition of Customary Marriages Act contains a number of safeguards at ensuring that the parties to customary marriages comply with the essentials set out in this Act. It states that the age of majority is determined by statute law and not by customary law (Section 9 of the Recognition of Customary Marriages Act). The Children's Act 38 of 2005 set the age of majority at 18. The Children's Act states that a child is anyone below the age of 18, and that in all matters affecting a child, the child's best interest and his or her involvement in decision-making are of paramount importance (Section 9 and 10 of the Children's Act 38 of 2005).

## CULTURAL PRACTICES

The attributes of culture are dearly held and valued by the community. Studies have defined culture as a coherent self-contained system of values and symbols that a specific cultural group reproduces over time, which provides individuals with the required signposts and meanings for behaviour and social relationships in their everyday life (Iyanuolu, 2008). The above statement shows that culture is a social heritage which includes all knowledge, beliefs, customs and skills that are available to members of a social group. It is also a source of individual and group identity within a given society (Wadesango, Rembe and Chabaya, 2011).

The Children's Act also makes it clear that children should not be subjected to social, cultural and religious practices which are detrimental to their wellbeing (Section 12(1) of the Children's Act 38 of 2008).

However, non-compliance with this provision does not attract criminal liability. It also provides that a child below the minimum age set by law for a valid marriage may not be given out in marriage or engagement, and that a child above minimum age may not be given out in marriage or engagement without his or her consent. Failure to adhere to this prohibition constitutes a criminal offence punishable by a fine of 10 years imprisonment or both, in the case of a first offender, and 20 years' imprisonment in the case of a second offender.

Section 12(2)(a) prohibits giving out a child in marriage. A child subject to *ukuthwala* practice is not in any conventional sense of the word given out (Children's Act 38 of 2008). These provisions of the Children's Act which were aimed at preventing forced marriages and child marriages have been rendered nugatory by the lack of specificity. The legislature did not specify the minimum age of marriages in the Republic. In the context of customary marriages, the provisions of the Children's Act



referred to above should be interpreted to mean that a girl of 12 years and a boy below the age of 14 cannot conclude a marriage at all, and in addition to the approval of a marriage by their parents, also consent to the proposed customary marriage. The Children's Act effectively prohibits the customary marriage of a girl below the age of 12 years, but sanctions the marriage of a girl older than 12 but younger than 18 years, provided she consents. This provision is problematic as it does not contemporaneously require the involvement of an official of the state, nor does it require that such a marriage should be allowed if it would be in the interest of the girl child.

Prevention and combating of trafficking in persons and make it punishable to conclude a forced marriage with another person.

## COMMON LAW AND STATUTORY OFFENCES

The age of the victim, people involved in the planning of *ukuthwala* where the consent of the bride is lacking could possibly be prosecuted for offences such as being an accomplice to rape, kidnapping, assault, rape, statutory rape and common law abduction (Snyman, 2008).

## VARYING VIEWS ON UKUTHWALA

*Ukuthwala* is regarded as amounting to the abuse of women. Abduction and kidnapping incidents are often accompanied by violent sexual abuse and therefore perpetuates a form of gender-based violence in the context of a culturally sanctioned patriarchy; and that it entrenches patriarchal power.

Abuses of *ukuthwala* have clearly perpetrated without the girl's consent and have proven to have an adverse effect on her education, health and physical wellbeing. Disadvantages of women and girls are a major source of inequality. Women and girls are discriminated against in health, education and in the labour market which are very negative.

Instances of *ukuthwala* commonly take place during times when men, mainly workers in big cities of South Africa, visit their rural homes. Many cases are reported to have occurred during the festive season as well as during major holidays. On returning to their rural villages, it seems that some men feel a heightened and urgent need to have a wife who will be responsible for domestic chores and fulfilling the man's sexual needs. Some girls reported that they were beaten and assaulted if they tried to escape. Some were given *muti* or traditional medicine which weakens them and makes it easier for their abductor to control them. Besides the fact that they may end up pregnant and have to drop out of school, they are also faced with lack of social and economic opportunities. The domestic demands placed on them often result in unsatisfactory school experiences and poor academic performance. Statistics show that rather than decreasing, the *ukuthwala* custom is gaining popularity

from decade to decade among the adherents of customary law among the Nguni tribes in South Africa (Koyana and Bekker, 2007).

Various reasons exist for the practice of *ukuthwala*, some of which are arguable strong and weighty. They include: to force the father of the girl to give his consent, to avoid the expense of the wedding and to speed matters up when the woman is pregnant. However, these reasons are also suggestive of the fact that the girl or the unmarried woman involved is, in some cases, abducted without her consent. Culture as a way of life for people, is given a place in our Constitution, but no culture should be above the law ([www.awid.org](http://www.awid.org)).

The practice of *ukuthwala* and early marriage is unconstitutional and it is discriminatory against the girl child on grounds of sex and gender.

## CONCLUSION

The study shows that *Ukuthwala* has faced criticism; because it is seen as an 'unAfrican' or foreign culture. *Ukuthwala* is a symbol of an intrusion of colonial ideas, and of the moral degeneration of urban youth, as a consequence of the intrusion. The common man on the street became agitated by this intrusion; and as a result, there are attacks against women.

Men use culture to justify their indecent behaviour, breasts and almost naked. Mkhwanazi clearly states that culture undermines women and is in favour of men, even when they are in the wrong (Mkhwanazi, 2008). Men should not feel entitled to a woman's body, and think that they have a right to respond to the signals they think a woman is sending.

We believe that, in order for women to be taken seriously by men and culture, women should stand up for themselves and fight against such a patriarchal system. Having regular marches that address issues, such as violence against women, could be a good initiative. According to the South African Constitution, we live in a democratic country, where everyone is supposed to be equal, and sexism should not exist; but in real life, the freedom from colonial regime is replaced by a patriarchal culture that oppresses African women.

What is human dignity and how important is it? Dignity is a proper sense of pride and self-respect, respectfulness or formality in any person's behaviour and bearing, the condition of being worthy of respect, esteem or honour. It is also described as the state of being worthy of honour and respect (Moloi, 2006).

De Vos states that African men have not internalised the excellent provision in our Constitution that guarantees every woman the right to equality, human dignity and bodily integrity. South Africa enjoys one of the most progressive constitutions in the world, with numerous organisations that work to protect the rights of women and child (De Vos, 2008). It is intolerable that *ukuthwala* is being

allowed to continue. We need to work harder to highlight the plight of these young child brides and bring pressure to bear to end this practice, which is another form of human trafficking.

Culture as a way of life for people, is given a place in our constitution, but no culture should be above the law (www.awid.org, 2011). The practise of *ukuthwala* and early marriage is unconstitutional and it is discriminatory against a girl child on grounds of sex and gender. Marriage in South Africa and in other countries, regardless of religion or culture, requires the full consent of both parties. The practice violates the rights of the girl child and endangers her future wellbeing, therefore it should be discarded. Child marriages deprive girls of the opportunity to obtain education which would be helping them live an economically rewarding life in future (Wadesango, Rembe and Chabaya 2011). There rights to choose their life partners are deprived because they were not given a chance to counter the decision to be married.

## REFERENCES

- Annan, K. (1999), Universal Declaration of Human Rights 147/1999, 149/1999 and 150/1999).
- Association for women rights in development 2011. Child marriage; Ukuthwala in South Africa. Available at www.awid.org (<http://awid.org>).
- Bennet, T.W. (2004), Customary Law in South Africa.
- Carr, J. L. (2013), The Slut Walk Movement: A Study in Transnational Feminist Activism. *Journal of Feminist Scholarship* 4, 24- 38.
- Doke, C.M. Malcolm, D.M, Sikakana, J.M.A. and Vilakazi, B.W. (2008), English-Zulu/Zulu- English Dictionary p. 811.
- De Vos, P. (2008), On miniskirts and transformation. Retrieved from <http://constitutionalspeaking.co.za/on-miniskirts-and-transformation/>, on 17th January 2016.
- Freedman, E. (2003), No turning back: a history of feminism and the future of feminism. Retrieved from <http://mdbrady.wordpress.com/2013/04/05/no-turning-back-a-history-of-feminism-and-a-history-of-feminism-and-the-future-of-feminism-by-estelle-freedman/>, on 07th April 2016.
- Freedman, J. (2001), Concepts in the social sciences: Feminism. Open University Press, Philadelphia.
- Grant, M.J. and Hallman, K.K. (2008). Pregnancy-related school dropout and prior school performance in Kwa-Zulu Natal, South Africa. *Studies in family planning*, 39 (4), 369-82. Retrieved at 16 April 2016 on <http://www.ncbi.nlm.nih.gov/pubmed/19248721>.
- Hancock, B, Windridge, K. and Ockleford, E. (2009), An introduction to qualitative research. The NIHR RDS for EM / YH, East Midlands.
- Homes, C. September 2015 Protect girls from clutches of ukuthwala. News/Homepage.
- Iyanuolu, A.E. (2008), The Challenge of Culture for the Rights of Women in Africa: A Critical Analysis of the Protocol to the African Charter on Human and Peoples' Rights on the Rights of Women in Africa. Masters' Thesis, Unpublished. Cape Town: University of Cape Town.
- Koyana, D.S. and Bekker, J.C. (2007), The Indomitable Ukuthwala Custom. University of Fort Hare and University of Pretoria: South Africa.
- Luvuno, D. M. (2004). The status of women and language use with particular reference to isiZulu. University of Zululand, KwaZulu Natal.
- Maluleke, J. (2009), Justice today, Vol.5.
- Marry, P.G. (2008), Before she's ready. NMs07381\_0808©2008 World Vision. Inc.
- Mkhwanazi, N. (2008), Miniskirt and Kangas: The use of culture in constituting postcolonial sexuality. Retrieved from: <http://www.darkmatter101.org/site/2008/05/02/miniskirts-and-kangas-the-use-of-culture-in-constituting-postcolonial-sexuality/>, on 01st May 2014.
- Modisaotsile, B. (July 2013), Ukuthwala: Is it culture correct or culture corrupt? Retrieved on 28 April 2016 at <http://www.pambazuka.org/printdf/85780>.

- Moloi, J. (December 2006), The case of S v Zuma: Implications of allowing evidence of sexual history in rape trials. SA Crime quarterly No 18, 25-29.
- International Covenant on Economic, Social and Cultural Rights (2002). Montreal Principles on Women's Economic, Social and Cultural Rights. <http://www.ichrdd.ca/english/commdoc/publications/women/Montrealprinciples.html> access 11th April 2016.
- Morrison, T. (2012), Home. A. Knopf Book, New York.
- Spivak, C. G. (1988), Can the subaltern speak? Marxism and the Interpretation of Culture. Nelson, G. & Grossberg, L. (eds.). University of Illinois Press, Chicago, 271-313.
- Snyman, C.R. (2008). Criminal Law. P 98.
- Thomas, L. (September 2006), International, Planned Parenthood Federation and Forum on marriage and rights of women and girls, (2006). Ending child marriage. Human Rights. Article available and retrieved on 28 April 2016 at <http://www.unfpa.org>.
- Vickers, J. (1997), Women and Work. Zed Book.
- UNICEF 2000, Gender Equality. [www.developmentgoals/Gender\\_Equality.htm](http://www.developmentgoals/Gender_Equality.htm).
- Wadesango, N., Rembe, S. and Chabaya, O. (2011). Violation of Women's Rights by Harmful Traditional Practices. Africa, 13(2), 121-129.
- Wordbank, Millennium Development Goals.

## LEGISLATION

- Children's Act 38 of 2005.
- Constitution of South Africa 108 of 1996.
- Recognition of Customary Marriages Act 25 of 1961.

## SHAREHOLDER DILEMMA: WHAT STAKE TO OFFER TO FINANCIAL INVESTORS? PROPOSALS BASED ON FINANCIAL PRINCIPLES

Vashakmadze, T.; Martirosyan, E.; Sergeeva, A.

IBS RANEPА, Moscow, Russian Federation

### ABSTRACT

Companies in their growth stage often require sums of money that exceed their operating cash flows. A need for raising funds might be associated with entering new markets, expanding production, acquiring other businesses. Debt and equity are the two main sources of capital available to businesses and each have advantages and limitations.

A sale of ownership stakes to private equity funds and other financial investors is an attractive alternative as far as it does not increase leverage and leads to competitive advantages achieved thanks to expertise and access to capital markets provided by the investor.

Private equity financing requires business owners to find their way solving a number of questions, including a choice between a strategic, financial and operational investor as well as making a decision on a stake offered to him.

*Keywords: private equity, financial investors, stake offered to investors.*

### INTRODUCTION

In the course of its development, a growing company faces a need for external financing for realizing its investment programs.

Various sources of financing are available. Two basic types of funding are debt financing and equity financing. The debt financing options might be limited: bank loans are only available to firms with good credit history and mature sales. Moreover, some business owners feel uncomfortable dealing with banks and deliberately avoid this option. Attracting a financial investor who is eager to provide financing in exchange for a share in business can be considered as a reasonable alternative.

### TYPES OF INVESTORS

Generally, there are two types of investors distinguished, namely they are financial and strategic investors. The major distinction between them is the following. Strategic investors besides economic viability are concerned with a strategic potential of a purchase and tend to accept offers not less than a controlling interest. By contrast, financial investors supply firms with capital and they are aimed at

exiting the business as soon as feasible, usually in 5-7 years earning annually not less than 25% return on invested capital.

Financial investors act as providers of sources both operating expenditures (OPEX) and capital expenditures (CAPEX). Primarily financial investors are focused on getting return on their investments. The most important indication of success for them is the price of their shares. The major driver of investment decisions of financial investor is the expectations of the exponential growth of the business within 3-5 years. Financial investors are motivated by capitalization increase and receiving dividends while holding a share. Usually financial investors require the following company's characteristics: consistent earnings, reasonably high growth rates, effective CEO and management team. They are always on the lookout, searching for willing buyers for their stake. The stock exchange is a common exit strategy.

In its turn a strategic investor is predominantly oriented on long-term investment horizons. They are concerned with a business model itself and its improvement. In the frame of this article we assume that strategic investors do not have speculative intentions and actively participate in managing a business aiming at revenue growth.

Alongside with financial and strategic investors we suggest introducing a notion of operational investors. How can an operational investor contribute to a business? His input may include base of clients, distributors and suppliers with beneficial business conditions, administrative resources. These market players invest in a target company achieving the growth of it as well as the growth of their core businesses. Thus, a target company is an instrument for stimulating growth of the core business that an operational investor holds. However he works on achieving synergy at companies that has aroused his interest.

In this article we describe aspects of business valuation and try to find the way to identify a share that can be offered to a financial investor. Strategic and operational investors are irrelevant for the objectives of this research as far as the owners of fast-growing businesses are often reluctant to attract strategic investors because shareholders are not willing to go out of their business.

## LITERATURE REVIEW

Attracting a financial investor is an effective tool for increasing business value. Exit strategies have a significant influence on business value and risk to owners of a business. Compared to strategic investors, financial investors are more conservative with respect to the business valuation (Zakharov, 2010). Due to the concentration on achievement of financial goals (high return on investment), and the possible lack of industry experience financial investors are not aimed at acquiring a controlling interest in business. One of the reasons for that is the risk avoidance. Most likely financial investor will

not be able to manage the business as efficiently as acting team of managers or owners. However, as a rule, a financial investor is interested in getting a share is not less than the blocking.

From the risks point of view the group of financial investors is not heterogeneous. Researchers (Weidig, Mathonet, 2004) stays that each type of private equity investment vehicle has a different risk profile. A direct investment has a total loss probability of 30%. A fund or a portfolio of direct investments has a very small probability of total loss. A portfolio of funds has a small probability of any loss.

In our research private equity funds takes a core place as financial investors. Financial mass media calls private equity funds as “new kings of Wall Street”. These financial investors deal with a wide range of business entities from startups to large corporations.

Significantly, private equity funds provide not only the initial capitalization for companies, but management and operational advice as well (Black, Gilson, 1998). Almost all private equity funds are set as limited partnerships, with private equity firms operating as a general partner (GP) of the funds, and big institutional investors and wealthy individuals providing capital as limited partners (LPs) or passive investors (Harris, 1998). The structure of the relationship between these investors and their fund managers set the base for potential several for investors to monitor an allocation of their investments. Interests of managers and investors often differ. On the one hand investors require managers to use their expertise to maximize the value of their investments. On the other hand, fund managers intuitively might want to shrink responsibility, and hide information or redirect resources for their own benefits. Thus an agent problem is created.

According to researchers, decisions of private equity funds are based on the market timing theory. Ljungqvist and Richardson (Ljungqvist, Richardson 2003) link the timing of funds’ investment to exit decisions, and the returns they earn on portfolio companies, to shifts in the demand for private equity. Following this logic, when investment opportunities improve and the demand for capital increases existing funds accelerate their investment flows and earn higher returns. Rises in supply lead to more intense competition for deals, and private equity fund respond by shrinking their investment programs.

Liquidity of securities may be a parameter that researchers associate with private equity decision-making process. Lerner and Schoar (Lerner, Schoar, 2004) present a model in which a private equity firm chooses the degree of illiquidity of shares to screen for investors with long horizons. The idea of the model is driven by the information asymmetry between inside and outside investors. Illiquidity is approached as a choice variable, which can be influenced by the manager of the fund and allows him to screen for deep-pocket investors. Low liquidity would not scare away long-term investors, but investors who expect to face many liquidity shocks in the future would find these restrictions

irrelevant and therefore would avoid investing. The benefits of having liquid investors become apparent once the firm has to go back to the market to raise new capital.

A number of studies are dedicated to an issue of investment attractiveness of a business. Methodology of Valinurova and Kazakova (Valinurova, Kazakova, 2005) suggests considering fifty-five parameters characterizing an enterprise. These parameters determine the cumulative investment potential and investment risk and then an integral index of investment attractiveness of the business is calculated.

For identifying company's investment attractiveness there has been developed a number of concepts, including the three-factor model (Sizykh, 2012), which allows to evaluate the investment attractiveness with regard to the preferences of investors in three areas: profitability, risk and corporate governance. Sevryugin's Methodology (Sevryughin, 2004) evaluates the following indicators of investment attractiveness of enterprises of different organizational forms: financial position, corporate governance and market environment. Financial position of a company is considered by some researchers (Kuznetsov et al, 2004, Krylov et al, 2003) as a core of a set company's investment attractiveness factors. Among the factors of investment attractiveness of an enterprise researchers also take into account the corporate governance practices, relations with the regions, and a role in the social division of labor (Doroshin, 2005).

Our experience in dealing with financial investors and the literature review have allowed us to create a test that determines the willingness of financial investors to consider business as an investment target.

A sign, that financial investors may be interested in a company is a positive response to the following three questions:

### **QUESTION 1. IS AN EXIT STRATEGY CLEAR FOR AN INVESTOR?**

Analysis of an investment target usually begins with an assessment of prospects for exiting the business (exit strategy). A private equity fund analyzes recent transactions in the industry, paying attention to exit ways of financial investors. Even if there are few or no deals, at the moment of entering the business the fund should clearly see an option for making a successful IPO or sale of a share to a strategic investor.

### **QUESTION 2. ARE THE BUSINESS AND BUSINESS MODEL SUSTAINABLE AND SCALABLE?**

Revenue model and the model of the company's profits should be understandable. Lack of ability to multiply (being reused in different environment) the business model, even if it is stable; make the business unattractive for financial investors.



### **QUESTION 3. IS A MANAGEMENT TEAM PROFESSIONAL, AND WHETHER IT HAS A STRONG MOTIVATION FOR ACHIEVING AN EXPONENTIAL BUSINESS GROWTH?**

The managing team need not only to prove its willingness to develop and implement a business strategy, but also be able to find new opportunities emerging in the market and launch new projects. However, in our literature review we have not found an answer to the question of how an owner can determine the share offered to investors. Further, on the hypothetical example we consider a situation that often occurs in practice, and suggest recommendations.

#### **WHAT STAKE TO OFFER?**

According to a definition provided by International Private Equity and Venture Capital Valuation Guidelines, a fair value is the price that would be received to sell an asset in transaction between market participants at the measurement date.

In order to identify a share to offer, it is important to understand a need in external financing and identify a fair value of equity at a day of negotiations.

Often business owners include into valuation assessment of future investment projects. However, since there is likelihood that investment projects can be launched later, or not implemented at all, the projects can be viewed as call option out of the money (OTM) and, therefore, they have an extremely low price today. Thus, firstly it is important to value the business "As It Is", and then take into account the investment projects.

Business valuation "As It Is" allows us to correctly identify a share offered to an investor while business valuation with projects enables an investor see gains in investment projects implementation.

#### **BUSINESS VALUATION "AS IT IS"**

Suppose you are a food products manufacturer, and in 2013 you received the following financial indicators:

- Revenue – 600 million rubles.,
- profitability EBIT - 8%
- required working capital - 10% of revenue,
- loans and borrowings - 100 million rubles.,
- income tax rate - 20%.

For annual growth of 10-12% you need net investment (capital expenditures minus depreciation) that amount to 4% of the revenue. You expect that by 2018, due to internal improvements the EBIT margin can be increased up to 10%. Then, the cash flow will be as follows (Table 1):

Table 1. Cash flow forecast

Million Rubles	2013	2014	2015	2016	2017	2018
Revenue	600,0	660,0	726,0	798,6	878,5	966,3
Growth rate		10%	10%	10%	10%	10%
EBIT	48,0	55,2	63,5	73,0	84,0	96,6
Profitability EBIT	8,0%	8,4%	8,7%	9,1%	9,6%	10,0%
EBIT after tax		44,2	50,8	58,4	67,2	77,3
Required working capital	60,0	66,0	72,6	79,9	87,8	96,6
Changes in required working capital		-6,0	-6,6	-7,3	-8,0	-8,8
Investments		-26,4	-29,0	-31,9	-35,1	-38,7
Free Cash Flow		11,8	15,2	19,2	24,1	29,9

If the weighted average cost of capital (WACC) equals 18% and exit multiple is 7x EBIT, then the value of the business is 384 million rubles., the cost of equity is estimated as 284 million rubles. (Table 2).

Table 2. Calculating the cost of equity

Discount factor		0,92	0,78	0,66	0,56	0,47
Discounted FCF		10,8	11,8	12,7	13,5	14,2
Terminal value						676,4
Discounted terminal value						321,2
Equity value (EV)	384,2					
Loans and borrowings	-100,0					
Cost of equity	284,2					

## BUSINESS VALUATION WITH INVESTMENT PROJECTS

Suppose the market provides good growth prospects. If the net investment in business the next two years will amount to 200 million rubles, then from 2016 to 2018, we can expect an annual revenue growth of 45%, and by 2018, EBIT margin of 12% with a projected 8.7 % in 2015. Then the company's cash flow will be following (Table 3):

Table 3. Cash flows forecast with investment projects

Million Rubles	2013	2014	2015	2016	2017	2018
Revenue	600,0	660,0	726,0	1052,7	1526,4	2213,3
Growth rate		10%	10%	45%	45%	45%
EBIT	48,0	55,2	63,5	102,3	164,8	265,6

Profitability EBIT	8,00%	8,37%	8,75%	9,72%	10,80%	12,00%
EBIT after tax		44,2	50,8	81,9	131,9	212,5
Required working capital	60,0	66,0	72,6	105,3	152,6	221,3
Changes in required working capital		-6,0	-6,6	-32,7	-47,4	-68,7
Investments		-126,4	-129,0	-42,1	-61,1	-88,5
Free cash flow to the firm (FCFF)		-88,2	-84,8	7,1	23,4	55,3

Using the described valuation assumptions (WACC=18%, exit multiple=7), then the business value will be 779 million rubles, and cost of equity will be 679 million., ie implementation of the investment program will increase the value of the business by 395 million rubles. (Table 4).

*Table 4. Calculating the cost of equity with investment projects*

Discount factor	0,92	0,78	0,66	0,56	0,47
Discounted FCFF	-81,2	-66,2	4,7	13,1	26,2
Terminal value					1859,2
Discounted terminal value					882,8
Equity value (EV)	779,4				
Loans and borrowings	-100,0				
Cost of equity	679,4				

## WHAT MINORITY STAKE TO OFFER TO AN INVESTOR?

In practice, share will be determined at the negotiations and will largely depend on the balance of forces during them, but if we approach financial investors with an offer of 29% (the necessary investments, divided by the cost of equity with investment projects), such an offer be rejected immediately. The main reason for that is the following. The cost of equity of 679 million rubles we get if a financial investor invests 200 million rubles. Without 100% investment equity share will worth 284 million rubles. Thus, the financial investor should be offered a stake of 41% (the necessary investments, divided by the sum of the cost of equity and the investments required).

As far as the value of a privately held company is subjective category, a share offered to a financial investor (assuming that the forecasted free cash flows accepted by an investor) depends on two factors: risk assessment (WACC) and the exit multiple.

A sensitivity analysis shows the following. If a financial investor believes that the risks in the business are higher than we describe, therefore value the company, using WACC of 20% and the exit multiple of 5 times EBIT in 2018, he will begin negotiations with the controlling stake, namely 54%, as shown in the table below (Table 5). In such scenario, an investor values 100% of the equity without investment projects as 173 million rubles.

Table 5.

		Exit multiple				
		5	6	7	8	9
WACC	16%	48%	43%	39%	36%	33%
	17%	50%	44%	40%	37%	34%
	18%	51%	46%	41%	38%	35%
	19%	52%	47%	42%	39%	36%
	20%	54%	48%	44%	40%	37%

## CONCLUSION

Both debt and equity financing are important sources of capital for business enabling it to fund its operations. Deciding which to use or increase depends on the long-term goals of the business and the amount of control shareholders willing to maintain. Private equity financing and financial investors are the center of attention of this research paper.

In this article, we have described types and motives of investors while acquiring equity interests in a business and proposed solely financial argumentation for calculating the share offered to investors.

Major result of the presented research is the concept for finding a size of a share offered the on the basis of financial calculations. This brings us to a recommendation to offer investors a share based not on "feeling", but on a solid basis of a particular method built on financial principles.

## REFERENCES

- Black, Bernard S. and Gilson Ronald J., *Venture Capital and the Structure of Capital Markets: Banks Versus Stock Markets*, 47 J. FIN. ECON. 243, 252-55 (1998).
- Doroshin DV *Evaluation of investment attractiveness of industrial enterprises// Economist Directory*. 2005. № 8 (26). Elitzur, Ramy, and Arieh Gavious. "A multi-period game theoretic model of venture capitalists and entrepreneurs." *European Journal of Operational Research* 144.2 (2003): 440-453.
- Harris Lee, *Mastering Corporations and Other Business Entities*, 60 (2009).
- Harris, Lee. "A critical theory of private equity." *Delaware Journal of Corporate Law (DJCL)* 35.1 (2010).
- International Private Equity and Venture Capital Valuation Guidelines* 1 Edition December 2012. <http://www.privateequityvaluation.com>
- Krylova E.I., Vlasov V.M., Egorova M.G., et al. *The analysis of financial condition and investment potential: studies*. Moscow: Finance and statistics, 2003.
- Kuznetsov AL, Sevryughin AS, Y. Sevryughin *Investment attractiveness of the enterprise: the concept and classification // Real economy: theory and practice of management*. - Izhevsk: IzhTU. 2004. № 1. P.56-58.
- Lerner, J., and Schoar A. "The illiquidity puzzle: theory and evidence from private equity." *Journal of Financial Economics* 72.1 (2004): 3-40.
- Ljungqvist, A. and Richardson, M. P., *The Cash Flow, Return and Risk Characteristics of Private Equity* (January 9, 2003). NYU, Finance Working Paper No. 03-001. Available at SSRN: <http://ssrn.com/abstract=369600> or <http://dx.doi.org/10.2139/ssrn.369600>
- Ljungqvist, A. and Richardson, M. P., *The Investment Behavior of Private Equity Fund Managers* (October 30, 2003). Available at SSRN: <http://ssrn.com/abstract=478061> or <http://dx.doi.org/10.2139/ssrn.478061>

- Sevryughin Y. Evaluation of investment attractiveness of industrial enterprise. Izhevsk, 2004.
- Sizykh N.V. To the evaluation of investment attractiveness of Russian enterprises, *Economics*, 1 (86), 2012.
- Valinurova LS, Kazakova, O., Management of investment activity: the textbook. M. KNORUS 2005.
- Weidig, T. and Mathonet, P.-Y., The Risk Profile of Private Equity (January 2004). Available at SSRN: <http://ssrn.com/abstract=495482> or <http://dx.doi.org/10.2139/ssrn.495482>
- Zakharov S.V., The increase in the cost of the growth stage in involving equity financing, *Economics*. 8 (69), 2010.

## SCREENING AND SCORING PROCESS IN M&A DEALS OF SERIAL ACQUIRERS. EVIDENCE FROM THE RUSSIAN AND INTERNATIONAL MARKETS

Vashakmadze, Teimuraz; Martirosyan, Emil; Sergeeva, Anastasia; Krechun Margarita

The Russian Presidential Academy of National Economy and Public Administration, Moscow, the Russian Federation

### ABSTRACT

This paper presents a study on the screening and scoring process as part of M&A strategies in Russian and international companies. It is hypothesized that an arrangement of the screening and scoring process in M&A is one of the key factors for the success of a transaction. Successful deal making requires a well-defined strategy. Serial acquirers that dominate the market consider M&A as an extension of their company's growth strategy. Targets' screening and scoring within an acquisition strategy develop clear view on prioritized growth opportunities, reflect M&A needs and create a pipeline of priority acquisition targets. All companies set targets for an acquisition on the basis of the corporate strategy. Some omit compiling long lists and short lists, but all companies consider strategic compatibility as a key criterion when choosing a target. A developed strategy sets the basis for elaborating criteria for the targets search, such as location, client portfolio, a range of products or services. The majority of companies adhere to the traditional approach to screening and scoring. Search for potential targets is conducted through analyzing market opportunities, comparing acquiring assets with strategic objectives. Some companies invite external parties such as banks, investment consultants or exploit the internal potential by involving company's business units, which understand the need for assets to expand the business. Companies tend to regularly update their long lists of targets, which requires fewer resources than creation of new target lists each time for a new deal. Some companies constantly monitor and analyze the market.

*Keywords: merger and acquisition (M&A), serial acquirer, target company, acquisition screening, scoring, acquisition strategy, Due Diligence.*

### INTRODUCTION

This paper presents a study on the screening and scoring process as part of M&A strategies in Russian and international companies. It is hypothesized that an arrangement of the screening and scoring process in M&A is one of the key factors for the success of a transaction.

Serial acquirers amount to 9% of all the companies involved in M&A activities. They dominate the market in terms of volume of mergers and acquisitions. They build M&A programs around frequent, continuous deal making and achieve notable success through establishing a full cycle of M&A process, focusing on searching target companies and integration process. They accumulate increasing expertise in conducting transactions, thus their best practices in targets' search have become the ground for a detailed study.

Theoretical part of the article includes case studies of 10 international serial acquirers. The practical part consists of 15 expert interviews conducted with representatives of strategy and M&A departments of Russian and foreign companies. Comparison of information on M&A activity of 10 serial acquirers with practical information obtained from 15 expert interviews proves the similarity of approaches of different companies during M&A.

#### *Case Analysis*

There have been selected 10 companies, classified as serial acquirers whose M&A processes are of potential interest for a detailed study and information on the screening process and scoring which has been available in open sources. These companies are: Dow (chemical industry), Tyco (security systems), Polycom and Cisco (telecommunications), Cemex (construction supplies), Mahindra& Mahindra (Automobile industry), Hindalco, Tata Steel (steel industry), Schneider Electric, Kone (engineering industry).

#### *Analysis of Experts Interviews*

A search for experts for interviews has been carried out on the basis of the following parameters. An expert needs to be a representative of a Russian or foreign company that regularly makes M&A transactions, have relevant experience in the field of M&A, hold a managerial position, be personally involved in several M&A deals. Some experts asked not to disclose the name of their companies. In order to preserve confidentiality, we pointed out their position and the company's industry.

Company/ expert	Country	Industry
Director, Asia Pacific M&A Ca	The U.S.A.	Engineering industry
M&A Director SE	France	Power industry, Engineering industry
Business development manager Metso	Finland	Engineering industry
Chandan Lohia, ex. M&A at Aditya Birla Group	India	Group of companies in metallurgy, construction materials, telecommunications, chemical and textile production sectors
M&A, TNK-BP	Russia	Oil and Gas, Oil Refining Industry
Vasiliy Migunov, ex-director of M&A, Evraz Group S.A.	The U.K.	Ferrous metallurgy

Group of companies "Riemer"	Russia	Oilfield Services, Engineering
LLC "Novaport"	Russia	Investments in airports
Alliance Oil Company	Bahamas	Oil industry
Evgeny Volk, head of the strategic development of OJSC "MTS"	Russia	Telecommunications
Alexander Rantsev, Director of Strategic Development and Controlling, JSC "Power Machines"	Russia	Power machinery

Table 1. A list of experts for the research

#### *Literature review*

Serial acquirers have become a center of attention of researchers investigating theory and practice of M&A. Both a high rate of M&A and a high variability of the rate are negatively related to performance. An acquirer's size, the scope of its acquisition program, and acquisition experience weaken the negative effects (Laamanen and Keil, 2008). According to another research (Kengelbach et al., 2012), multiple deal makers exhibit a 0.4 percentage points lower short-term abnormal return, equal to a \$31M shareholder value disadvantage. However serial acquirers can gain proficiency in some specific types of deals.

Developing a screening process for M&A targets is a significant step in creating an efficient M&A strategy (Rosner, 2006). A proactive, structured screening process enables companies accurately assess targets that can advance corporate business strategy. Applying a formal screening methodology involves establishing clear inclusion/ exclusion and prioritization criteria, building a comprehensive candidate list, applying the criteria to narrow a group of potential targets, creating in-depth candidate profiles to enable a more informed approach and support the initial due diligence stage. In addition to better M&A performance a well-established screening process provides such benefits as enhanced strategic consistency, opportunity prioritization, effective use of recourses and a framework for ongoing analysis.

Researches highlight an importance of the search period. Analysis of markets and competitors and the search process for potential candidates is the following step after the definition of an adequate strategy. To conduct a value adding search, preliminary search criteria must be determined. These are coherent with the company strategy, organizational form, and goals defined during the planning. The calculation of a target's strategic fit, synergies, and costs savings is conducted and with effective management. Potential targets are organized and the best fitting target is selected (Gleich et al., 2012). It is reasonable to take time for an adequate evaluation of a target and review the potential seller company on its fit into an acquirer's strategy and consider potential alternatives (Boos, Heitger, 2005).



## CASE STUDIES

### *Serial absorbers' influence to the M&A market*

Companies use M&A as a tool for non-organic growth to increase profits, market share and gain competitive advantages. M&A statistics over the last 10 years shows that more than half of mergers and acquisitions turn to be unsuccessful failing to reach their objectives.

However, serial acquirers refute the statistics. Research of Accenture consulting company (Kubel D., Langthaler, 2011) conducted between 2003 and 2009, showed that the serial acquirers have a significant impact on the market. 9% of all the companies involved in M&A activity are serial acquires (Figure 1). They implement 1/3 of the number of transactions and accounted for a half of the total volume of transactions in the market.

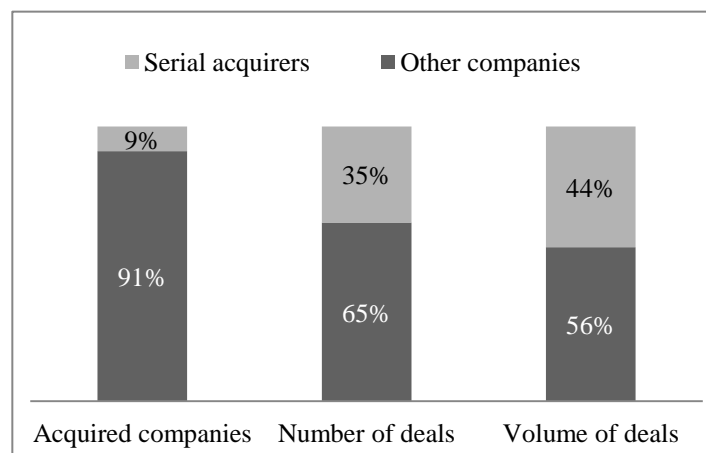
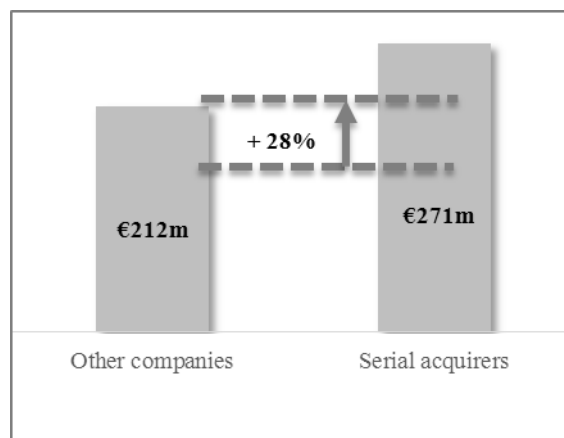

Figure 1. M&A Activity by the types of companies



Moreover, Accenture conducted a large-scale study of 2500 M&A in 110 different companies from 2007 to 2009. The sample included serial acquirers, companies what regularly implement M&A transactions. The study found out that the market is dominated by serial acquirers. Typically, serial acquirers make large transactions. Average transaction of serial acquirers is larger by 28% in comparison with other companies (Figure 2).

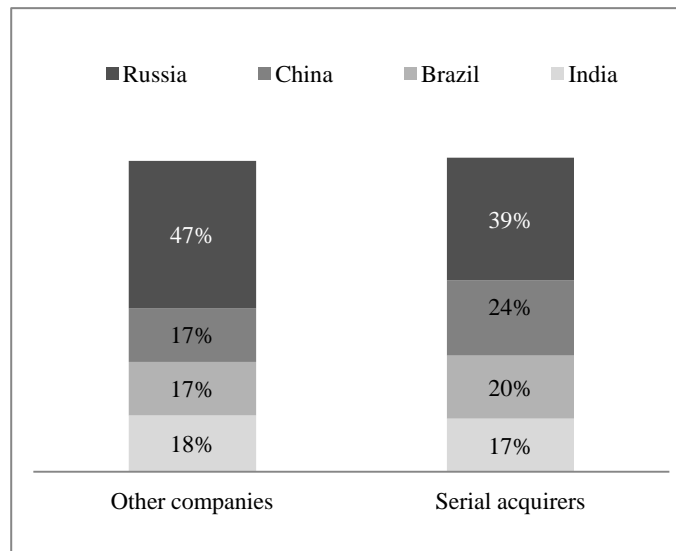

Figure 2. Volume of M&A deals

European serial absorbers companies are more likely to make cross-border transactions in emerging markets, which account for more than half of M&A in the BRICS countries. In 2003-2009 they closed 27% more mergers and acquisitions than any other company (Figure 3).

Serial acquirers are experiencing considerable difficulties. To maintain the flow of transactions, companies need to handle multiple transactions at the same time and manage a portfolio of projects at all stages of the transaction. However, some of the processes of serial acquirers can be improved. The majority of companies in Accenture's study are very strong in the traditional M&A process, namely in developing a strategy and managing a deal. But they are weak at the post-merger integration and the effectiveness management of M&A.

#### *General Characteristics of the Screening Process*

Among a variety of suitable targets a well-established rigorous search mechanism of target companies defines the ones that match the customer requirements best. The key to success in the targets search is a clear definition of the basic principles and criteria for screening within the frame of a company's M&A strategy. However, the criteria for screening are specific for each company and each transaction. Today acquirers are interested in the stability of a business model, competitive advantages of target companies and successful management of the post-merger integration. Furthermore, they evaluated M&A transaction in terms of risk. Financial institutions and business development specialists involved in the development of a target search methodology help to improve the efficiency of the process eliminating obstacles in the deal's implementation. The strategic compatibility and companies suitability after a deal are considered as critical factors in the M&A analysis. Qualitative and quantitative screening criteria are used to compare and evaluate possible strategic fit between the two companies.

The formal screening methodology includes 4 steps (Figure 4) and starts with defining clear inclusive/exclusive criteria for selecting and prioritizing target companies. Secondly comes drawing up a long list of potential targets. The next step is applying the search criteria to shrinking the long list. And finally an acquirer selects the most attractive companies to acquire.



Figure 3. Screening stages

#### *M&A Strategy as a Continuation of the Company's Strategy*

An acquisition strategy is being developed on the basis of a company's overall strategy that reflects the desired goals is the first step in the M&A process. After defining the strategic objectives a company's management need to formulate a set of strategic business alternatives. For the implementation of a selected alternative a company may combine in different proportions both types of growth, organic and M&A. For example, CEMEX combines internal business growth with strategic acquisitions and capital investments. And Dow Chemical is developing mainly due to active M&A activities capturing new markets, technologies and gaining access to new customers. In total, the company has acquired more than 200 businesses from 1983 to 2009. As well as Kone that implements 20-30 acquisitions a year, of which 6-8 of transactions exceed the value of 5 million euros.

The M&A process consists of 5 stages (Figure 5). The process starts with a decision on the strategic fit of the transaction and planning its milestones. Than a company runs screening and scoring of the wide range of potential targets for acquisition in order to narrow the list of the target companies. An acquirer negotiates and familiarizes himself with target companies and harmonize conditions of the deal. The next step is Due diligence (DD) that forms a clear picture of the investment's object, provides an assessment of the company's financial status and comprehensive study of its activities. Finally comes a stage of closing the deal.



Figure 4. Stages of the M&A process

Serial acquires have achieved considerable success through alignment of the full cycle of M&A process, focusing on technology of searching suitable target companies and post-merger integration practice.

*The Objectives of M&A Deals*

Companies' objectives in M&A differ according to the chosen business strategy. High-tech companies such as Cisco, Tyco and Polycom are usually aimed at new technologies and the expansion of the product line. For instance, M&A deals aimed at gaining access to new technologies are an integral part of the Cisco's strategy. This strategy was unique for the market of high-technology companies as far as the majority of market players perceived an appeal to the external sources new technologies as a sign of weakness. Cisco is also considering M&A transactions as a way to protect rare intellectual assets. M&A strategy of Polycom was aimed at expanding the product range of cloud services. While choosing targets for the acquisition attention was paid to a development team and engineers that can improve R&D capabilities of the company. Tyco in the selection of potential targets paid the prime attention to the product line, which could complement or improve its own range of products.

M&A objectives of companies from emerging markets such as India Hindalco and Tata Steel can form a separate group. Indian companies make M&A transactions with a long-term strategic bias. Through takeovers companies are gaining access to technology, knowledge and competencies necessary for the implementation of their strategy. Determining their weaknesses, Indian companies are selecting M&A targets to eliminate their weak spots. The deal with Novelis has allowed Hindalco to become a global leader in aluminum rolled products. Moreover, it would take Hindalco 10 years of its own research to develop high quality aluminum production technology by itself. Tata Steel after acquiring Corus Group has become the fifth largest steel company in the world, up from 56th place. With the help of M&A transactions it has united access to low-cost steel production with access to highly developed global markets of automobile manufacturers in Europe and the United States. An advantage of these M&A deals for both companies has become a supply of raw materials (steel and aluminum) to Western partners, that make the final production, and their manufacturing facilities are located close to the European consumers. Also, Indian companies have benefited from access to new advanced technologies and R&D competencies.

CEMEX's aggressive acquisition strategy has begun with purchasing of local companies aimed at becoming the largest cement producer in Mexico. When the company gained M&A competencies it has launched its international expansion in developing countries with a similar culture and language. After Spain CEMEX entered the Latin American market, where knowledge of the specifics of developing countries, a similarity of language and culture have become advantages over European competitors. Global expansion has been reducing fluctuations of operating performance indicators in the regions of presence.

Dow used M&A deals mainly in order to improve its position in the market of specialized chemical products of a high demand. At the same time it created joint ventures for the purpose of diversification

and risk mitigation. The company located its most mature business in regions with high growth rates, at the same time benefiting from the fact that it had access to cheap raw materials by working with local partners.

A table 2 summarizes purposes of M&A deals, which have been identified in a study of 10 companies. On the basis of the study of 10 serial acquirers, 3 key reasons for M&A can be pointed out. The major reasons are to enhance and extend a product line, acquire new technologies and R&D capabilities, geographically expand and access new markets and customers.

A company's name/ Purposes of M&A	CEMEX	Cisco	Tyco	Polycom	Dow	Kone	Schneider	Electric	Tata Steel	Hindalco	Mahindra&	Mahindra
1. Expanding geographical presence and access to new markets	<input checked="" type="checkbox"/>	<input checked="" type="checkbox"/>	<input checked="" type="checkbox"/>	<input checked="" type="checkbox"/>	<input checked="" type="checkbox"/>	<input checked="" type="checkbox"/>	<input checked="" type="checkbox"/>	<input checked="" type="checkbox"/>	<input checked="" type="checkbox"/>	<input checked="" type="checkbox"/>	<input checked="" type="checkbox"/>	<input checked="" type="checkbox"/>
2. Extension of products and services range	<input checked="" type="checkbox"/>	<input checked="" type="checkbox"/>	<input checked="" type="checkbox"/>	<input checked="" type="checkbox"/>	<input checked="" type="checkbox"/>	<input type="checkbox"/>	<input type="checkbox"/>	<input checked="" type="checkbox"/>	<input checked="" type="checkbox"/>	<input checked="" type="checkbox"/>	<input checked="" type="checkbox"/>	<input checked="" type="checkbox"/>
3. Access to new customers	<input checked="" type="checkbox"/>	<input checked="" type="checkbox"/>	<input checked="" type="checkbox"/>	<input checked="" type="checkbox"/>	<input checked="" type="checkbox"/>	<input checked="" type="checkbox"/>	<input checked="" type="checkbox"/>	<input checked="" type="checkbox"/>	<input checked="" type="checkbox"/>	<input checked="" type="checkbox"/>	<input checked="" type="checkbox"/>	<input checked="" type="checkbox"/>
4. Acquiring technological competences, access to R&D	<input checked="" type="checkbox"/>	<input checked="" type="checkbox"/>	<input checked="" type="checkbox"/>	<input checked="" type="checkbox"/>	<input checked="" type="checkbox"/>	<input type="checkbox"/>	<input type="checkbox"/>	<input checked="" type="checkbox"/>	<input checked="" type="checkbox"/>	<input checked="" type="checkbox"/>	<input checked="" type="checkbox"/>	<input checked="" type="checkbox"/>
5. Getting qualified personnel	<input type="checkbox"/>	<input checked="" type="checkbox"/>	<input checked="" type="checkbox"/>	<input checked="" type="checkbox"/>	<input type="checkbox"/>	<input type="checkbox"/>	<input type="checkbox"/>	<input type="checkbox"/>	<input checked="" type="checkbox"/>	<input checked="" type="checkbox"/>	<input type="checkbox"/>	<input type="checkbox"/>
6. Improvement of productivity and efficiency of an acquirer	<input checked="" type="checkbox"/>	<input type="checkbox"/>	<input type="checkbox"/>	<input type="checkbox"/>	<input type="checkbox"/>	<input type="checkbox"/>	<input type="checkbox"/>	<input type="checkbox"/>	<input checked="" type="checkbox"/>	<input checked="" type="checkbox"/>	<input type="checkbox"/>	<input type="checkbox"/>
7. Strategic long-term investments	<input checked="" type="checkbox"/>	<input type="checkbox"/>	<input checked="" type="checkbox"/>	<input type="checkbox"/>	<input type="checkbox"/>	<input type="checkbox"/>	<input type="checkbox"/>	<input checked="" type="checkbox"/>	<input checked="" type="checkbox"/>	<input checked="" type="checkbox"/>	<input checked="" type="checkbox"/>	<input checked="" type="checkbox"/>
8. Acquisition of large companies for restructuring	<input checked="" type="checkbox"/>	<input type="checkbox"/>	<input type="checkbox"/>	<input type="checkbox"/>	<input checked="" type="checkbox"/>	<input type="checkbox"/>	<input type="checkbox"/>	<input type="checkbox"/>	<input checked="" type="checkbox"/>	<input checked="" type="checkbox"/>	<input type="checkbox"/>	<input type="checkbox"/>
9. Contributing to infrastructure and resources of an acquiring company	<input type="checkbox"/>	<input checked="" type="checkbox"/>	<input type="checkbox"/>	<input type="checkbox"/>	<input checked="" type="checkbox"/>	<input type="checkbox"/>	<input type="checkbox"/>	<input type="checkbox"/>	<input checked="" type="checkbox"/>	<input checked="" type="checkbox"/>	<input type="checkbox"/>	<input type="checkbox"/>
10. Cost reduction	<input type="checkbox"/>	<input type="checkbox"/>	<input type="checkbox"/>	<input checked="" type="checkbox"/>	<input checked="" type="checkbox"/>	<input type="checkbox"/>	<input type="checkbox"/>	<input type="checkbox"/>	<input checked="" type="checkbox"/>	<input checked="" type="checkbox"/>	<input type="checkbox"/>	<input type="checkbox"/>

11. Acquiring attractive assets at a low price during a crisis



*Table 2. The objectives of M&A deals*

*Channels of Information for the M&A Targets Search*

There are several ways for serial acquirers to find potential M&A targets. The main way of drawing up a long list of target companies is a focused search based on specific criteria in accordance with the M&A strategy. Also a company can create and regularly update a database of potential targets for acquisition in order to pick one of them at the appropriate time. For example, Schneider Electric, Dow Chemicals and Mahindra & Mahindra used to define potentially interesting targets and monitored the actions of competitors in the market in order to take advantage of the economic difficulties of target companies and initiate M&A.

Often an initiative for an acquisition comes from business units of companies. For instance, the Polycom managers through communication with customers, suppliers, strategic partners have determined which products or technologies the company is lacking and what target companies have necessary competences. A Kone provides its affiliates with the power to compile a long list of potential targets, as far as its local representatives had more information on competitors and market conditions in the regions.

Usually investment banks provide assistance in finding targets for mergers and acquisitions have investment banks.

And finally one of the most common methods of obtaining information on targets for a takeover is receiving offers from small companies working with serial acquirers.

The study reveals 5 main channels of information on potential targets, including directed target search by the set of criteria, database creation, business units of a company, investment banks, small companies associated with the larger ones.

*Criteria for the Screening Process*

While planning objectives and the results of M&A transactions a company need to define the criteria for screening and scoring, which suit its M&A strategy. One of the most important criteria for selecting targets for M&A transactions is a strategic compatibility of an acquirer and acquiring companies. Unsuitable companies can be identified at an early stage of the screening before wasting significant resources on a transaction that is lacking in prospects.

As a rule, companies assess the strategic fit considering compatibility of the potential targets with the strategy of the company as well as specific screening criteria, including the feasibility and difficulty of the integration process. Also, challenges and risk factors that need to be considered are defined for each

M&A target. The most common selection criteria correlate with the objectives of the M&A strategy and are linked to the range of products and services, technological base and operations geography of a target company.

For example, Dow has a comprehensive approach to the selection process. A target company needs to suit the strategy, the spirit and vision, be in a good financial condition, discover new advantages and create value for shareholders. The company also needs to be suitable in terms of strategic vision in the field of technology, geography, business model, market position and product line. High-tech companies such as Cisco, Tyco, and Polycom, primarily looking for acquisition targets on the basis of the range of products and services to strengthen their market position. Important screening criteria for them are were innovative and progressive technologies of target companies, that are supposed to enhance their own potential.

Moreover, while searching for targets of M&A some companies pay much attention to specific screening criteria. For Tyco, a target's ability to increase its income quickly after M&A was an important screening factor. Polycom was getting involved into M&A only if it can be implemented within two quarters. Expanding the geography of its operations Kone chose markets that were not dominated by large companies in order to be able to take a leading position there. Indian companies, Tata Steel and Hindalco, was choosing targets of acquisitions primarily on the basis of synergy effects and high technological competence. The geography of production and sales of the target company were key factors that would allow them to gain access to developed markets. The majority of Mahindra & Mahindra acquisitions were made during an economic downturn.

The table 3 provides a summary of the screening criteria for M&A transactions, which have been identified in a study of 10 companies. Serial acquirers are looking for targets considering a variety of criteria. The table reveals the most important of them for specific companies.

Systematic screening process improves the chances of success in mergers and acquisitions. Most of the harmful factors that can destroy the value of an acquirer can be identified at an early stage and a waste of considerable resource on the wrong acquisition can be avoided. Deloitte identifies several "red flags" to filter the list of targets:

- Incompatibility of the accounting reporting, procedures and rules. The screening needs to consider standards of financial statements - IAS, GAAP;
- An impact of the transaction on the Balance Sheet and Profit and Loss Statement of an acquirer. It is important to identify how the deal will influence the Balance Sheet and EPS, how differences in accounting standards will be regulated;

A company's name/	CEMEX	Cisco	Tyco	Polycom	Dow	Kone	Schneider	Electric	Tata Steel	Hindalco	&	...

## Screening criteria

1 Strategic compatibility									
2 Specific products and services range									
3 Certain technological competence									
4 Innovation (technology, products, business model, etc.)									
5 Market leadership									
6 Location and geography of operations									
7 Potential to dominate a particular market									
8 Linguistic and cultural similarities									
9 Poor infrastructure									
10 Good financial condition of the target company									
11 An economic downturn									
12 A pace of an acquisition									
13 Synergy effects									

Table 3. Criteria for screening

- The next point is taxation. The understanding of tax accounting structure of a target company may have a significant impact on the amount of taxes paid and cash flows;
- The size of investments in a target, including direct transaction costs and investments into the working capital and the development of the company after M&A;



- An analysis of target's liabilities, some of which may not be reflected in the balance sheet;
- A comprehensive approach to risk analysis, which also includes the collection of information on the management of the target company;
- Operational and financial "red flags" that are a number of key customers and suppliers, and the company's dependence on them.
- A sharp improvement in the operating performance of the company represented by a short-term increase in sales, profit and cash.

The earlier potential hazards are identified, the less risk of picking a wrong M&A target is. The main criteria for screening targets, selected on the basis of the study of 10 serial acquirers include strategic compatibility, the necessary range of products and services, availability of the necessary technological competence, geography of operations and a target company's customer base. In the analysis of activity of 10 serial acquirers it was found that the companies did not have a unified approach to the search of targets for M&A. But the majority of cases have shown the dependence of criteria for the target search and a firm's M&A strategy.

Some companies prefer to buy market leaders, while others, on the contrary, go to markets where there are no major players. For some companies distribution channels and a target's customer base are important, others acquire advanced technology and skilled technicians.

The study has indicated that the majority of companies tend not to disclose the information on the screening and scoring process in their M&A activities.

## **EXPERT INTERVIEWS**

### *General Provisions*

In the majority of companies in this study a process of M&A fits an overall business strategy of inorganic growth. Business units may get involved into the global strategy development and determine what competencies the company needs to improve on. This is the case of Caterpillar or Schneider Electric. In other cases the head office forms the strategy and communicates it to all departments. This is how Evraz Group S.A. acts. All companies in the study choose M&A targets, if the deals correlate with the goals of the global strategy that reflects a geographical factor, promising industries, certain range of products and services. If a company has a less deep approach to screening that is based on current market opportunities, like Evraz Group S.A., this can later lead to erroneous from a strategic point of view acquisitions. In general, for Russian companies in the study, except the Group of Companies "Riemer", it is more common to have less rigorous approach to M&A deals in comparison with foreign entities. One of the main constrains for Russian companies is the lack of market information and companies' reports while some published communication materials may be

uninformative. Companies in the oil industry as TNK-BP, have their own peculiarities in a search for M&A targets, due to the limited market offer. Indian company Aditya Birla Group shows an in-depth approach to M&A deals. Each transaction of this company is made strictly on purpose to expand existing facilities or acquire specific skills for enhancement current business.

#### *The amount of M&A Deals*

Sometimes companies are carrying several M&A projects simultaneously and do not complete a part of them. For instance, Metso may have up to 5 ongoing projects in different lines of business. The reason for quitting or delaying a deal may be disagreements on value of business between a buyer and a seller, additional information received after due diligence, better offers received from competitors, etc.

A company	M&A deals
Caterpillar	10 transactions per year on average, 5 transactions in 2013
Schneider Electric	About 50 transactions from 2010 to 2013
Metso Oyj	3-4 M&A transaction per year on average
OJSC "MTS"	5-7 transactions per year: 9 deals in 2010, 18 deals in 2011, 7 deals in 2012

*Table 4. The amount committed M & A transactions*

#### *Channels for receipt of information about the*

Among all sources of information about the targets for the acquisition there can identified two main channels. Namely they are company' units and external consultants as well as investment bankers. Business units have relevant information on the market that is suitable for initiating M&A process. Moreover, suppliers and distributors can also be source of M&A offers.

A company	M&A deals
Caterpillar	business units, investment banks
Schneider Electric	business units, investment banks, direct offers from the sellers and partners
Metso Oyj	business units, information about players of the market, suppliers and distributors, consulting firms and investment banks
Aditya Birla Group	recommendations of companies that are parts of the conglomerate, banks, associations, public reports
TNK-BP	potential targets are known in advance, the market is well-known
Evraz Group S.A.	offers from banks, the company channels, market opportunities analysis
Group of companies "Riemer"	initiative of the shareholders and the company's management
Alliance Oil Company LLC "Novoport»	market research, an offer from investment banks, owners of companies
LLC "Novoport»	market research
OJSC "MTS"	market Information
OJSC "Power	market analysis, offers from the owners of companies

Machines"

*Table 5. Channels of the information about M&A targets**The M&A Duration*

Duration of M&A process of the companies in this study depends on a type of a transaction. Thus creation of a partnership or joint venture takes a longer period of time than a takeover. Also a deal duration is affected by specific characteristics of a target company. That is the reason Metso in some difficult cases conducts two-phase due diligence. Companies measure a duration of M&A in different ways. For Caterpillar planned duration includes steps from approval of a target and due diligence till signing an agreement of intent. Metso considers M&A process completed when all acquired assets are transferred and registered. In TNK-BP the process of due diligence can take up to six months, as well as approval of a deal at the investment committee. In MTS transaction time lasts from is calculated from signing an indicative offer till its closing. On average, the process takes 3-4 months.

A company	Duration of M&A process
Caterpillar	From approval of a target till signing an agreement of intent - 6-9 months
Metso Oij	From 4-6 months (in case of no difficulties) up to 1.5 years
TNK-BP	Up to 2 years

*Table 6. Duration of M&A**Department of M&A*

Although not each company has an M&A department, but all companies have units or specially designated employees, who are responsible for these functions.

A company	M&A Department	Number of employees involved	Areas of responsibility
Caterpillar	Yes	20	- internal consulting division for the entire company; - support business units of the company in all matters connected with the M&A process; - consulting services for business units dealing with joint venture creation, strategic alliances
Schneider Electric	No	8 (M&A team)	- Corporate Strategy Division is responsible for screening targets, an assessment of the strategic relevance and feasibility of a deal; - M&A team reports to CFO and is responsible for M&A from choosing a target till finalizing the deal.
Metso Oyj	No	2 (constantly focused on M&A)	- Corporate Strategy Department is responsible for transactions support. The Department includes a sub-team specializing in M&A;

			<ul style="list-style-type: none"> <li>- Functions are flexibly allocated within the Department, and powers, employees are involved in M&amp;A processes 40-50% of their working time;</li> <li>- the department supports the entire process and get stuff from business units involved at different stages.</li> </ul>
Aditya Birla Group			<ul style="list-style-type: none"> <li>- A team from a Corporate Strategy Department performs functions of M&amp;A support.</li> <li>- M &amp; A process is led by the Head of Corporate Strategy Development Department.</li> </ul>
TNK BP	Yes	3 employees	M&A Department collaborates with relevant business units, are getting holding coordinating functions at all stages involved in a deal
Evrax Group S.A. LLC	Yes	N/a	An M&A department supports deals but it does not searching target companies
"Novaport"	No	-	<ul style="list-style-type: none"> <li>- A Corporate Finance Director and an analyst deal with M&amp;A processes in the company;</li> <li>- Shareholders are involved in M&amp;A process.</li> </ul>
Alliance Oil Company	No	-	<ul style="list-style-type: none"> <li>- A Business Development Department represented by 2 employees is in charge of the M&amp;A targets search;</li> <li>- During a deal the Department works closely with other entities in the company.</li> </ul>
OJSC "MTS"	No	-	M & A functions are performed by the Department of Strategic Development

Table 7. M&A department in companies and its main functions

At Caterpillar the M&A department has all the functions of consulting and transaction support. At Schneider Electric this process is divided between a Corporate Department, assessing the strategic feasibility of a transaction, and an international team of 8 professionals who directly carry out all stages of a deal. In Metso an M&A function belongs to a team within a Corporate Strategy Department. The number of staff members involved depends on the number of projects in work. Department of M&A company Evrax Group S.A. does not deal with a search for targets except cases where offers received directly from banks.

#### Compiling long list and shortlist

Not every company from our sample has a well-established procedures and rules for building up the list of targets.

A company      Formation of a long list

Caterpillar	Defining potentially interesting companies in 8 key sectors of the economy
Schneider Electric	No long list, target companies are identified by the company's business units. There is a list of interesting targets that are regularly being monitored
Metso	Company continuously monitors the industry and related sectors, tracking major players and competitors
Aditya Birla Group	A dynamic long list of targets, containing 60-70 companies with a description of market activities and main characteristics. There are 3 criteria: manufacturing capabilities and potential synergies, MCap, financial multiples. A separate long list is created for each industry.
TNK-BP	A long list of potential target companies is pre-determined based on the market and its key players.
Evrast Group S.A.	A long list is compiled on the basis of raw materials and production base of companies.
Group of companies "Riemer" LLC	A search of companies is divided by 3 groups of competencies: drilling, production and servicing of downhole equipment and construction assets. The long list exceeds 100 items.
Alliance Oil Company	Continuous monitoring of potential 200 targets with an annual increase of 15-20 offers, mainly small oil companies and oil fields. The criteria to include a company in the list: the volume of oil and gas reserves, the price factor.
OJSC "MTS"	A list includes 20 potential companies. The criteria to include a company in the list: valuation multiples $EV / EBITDA = 5,5$ , $EV / Sales = 2,3$ , the city's population is 200 thousand or more, the company's market share is at least 20-30%, good financial performance.
OJSC "Power Machines"	A list consists of strategically relevant companies based on their financial and economic condition.

*Table 8. Criteria for a long list*

The process of target selection may be based on the current market offerings. Or, alternatively, target selection is carried out in line with a strictly developed methodology. It is a common practice to combine these two approaches while compiling a long list. For instance Metso monitors only potentially interesting companies within the industry, but does not initiate a global search.

Another reason a company may be reluctant to conduct a large scale search is a familiar market and well-known market players. This is the case of an oil industry and TNK-BP. In 2010 Caterpillar identified key markets through the study of the profile of buyers, with whom it was willing to collaborate. In order to evaluate the key characteristics of target companies there was developed a system of indicators for industries and companies. An industry-oriented system checked the growth rate and profitability, while a companies-oriented system checked a market share, growth rate, regional coverage, competence of employees. The Russian Group of companies "Riemer" also has a detailed

approach to creating a long list of targets for M&A. The company defines three key competencies: drilling, production and servicing of downhole equipment and construction assets. Aditya Birla Group has a similar systematic approach to form a long list has a company, conducting a weekly monitoring companies in the list and monthly producing peer reports. Schneider Electric does not create a long list, considering it a waste of time, because a lot of companies in its potential list cannot be sold and the list of potential targets includes thousands of items.

In the study companies didn't pointed out a geographical position of the target as a separate factor, since it is part of the overall strategy of the company and it is taken into account when searching for targets.

According to the study, while transforming from a long list of targets to a short one the key criteria for selection is an availability of a company for a deal and possibility to implement a transaction. Obtaining a precise response from a target company is possible by establishing a primary contact or determining its owners.

The lack of information for a decision on further detailed analysis of the company remains a challenge while converting a long list into a short one. Especially it is a complex issue if a target is a non-public company or a market is not studied enough. In such cases, companies use all available resources to gather more information. They involve employees, contractors and exploit materials from open sources. At the same time companies engage consultants who gather all the necessary information.

TNK-BP' approach to the selection of targets for an acquisition is based on the strategic objectives and by comparing offers available on the market. An important role was played by political factors since oil production can be attributed to strategic sectors of the economy. However, a smaller oil company focused on the Russian market, Alliance Oil Company, runs an ongoing analysis of the market focusing on changes in oil prices and its transportation costs. A long list is based on financial analysis and a short list is compiled as a result of more detailed calculations. An approach of Evraz Group S.A. differentiate itself from common practice by the lack of clear criteria for the transition from a long list to a short list. Targets are selected on the basis of market opportunities and prospects of the deal. The main criteria for the company are the following: infrastructure, being close to customers and potential demand for the product on the market. Return on the acquired assets need to be no less than 20% per year. However, the choice of targets is usually closely linked to a strategy of development of the company and is aimed at the creation of a vertically integrated system and the improvement of the transport system.

Generally, compiling of a list of potential targets for a takeover companies focus on industry-specific criteria. For instance, for oil companies these criteria are the amount of oil reserves, production costs

and NPV of the project, while telecommunication companies concerns about the city's population and a base of subscribers.

Metso is leading several projects at the same time despite choosing one target. The large scale of business and different areas of its acquisition interests make it reasonable for the company to manage several M&A processes simultaneously. Aditya Birla Group, as well as other Indian companies such as Hindalco and Tata Steel, determines the criteria for acquisition on the basis of specific parameters for the company's current needs. This is typical of companies from India to choose a target on the basis of its strengths.

A company	A criteria for a short list composition
Caterpillar	A product range and a rate of differentiation; the skills of the management team; a technological base, a cycle of a business; intellectual property; compatibility with the Caterpillar distribution network; R&D capacity; synergy opportunities.
Schneider Electric	Stage 1 - ranking and evaluation of targets by the company's business divisions with the involvement of the Department of Corporate Development and Corporate Strategy; Stage 2 - using the general criteria of the investment attractiveness, industry specific criteria. A list includes 5-10 companies on the basis of geography and product line.
Metso	Strategic compatibility in products and services; company's size does not exceed the financial capabilities of Metso; company is available for sale; environmentally friendly companies; profitability and operational efficiency improvement of an acquired assets after becoming a part of Metso.
Aditya Birla Group	Each company is selected strictly for specific needs Financial and non-financial aspects are evaluated on the basis of all available public information about it. Comparison of costs of building a similar business from the scratch and M&A; financial forecast of a target company before and after the acquisition; changes in the market position of a target company before and after the acquisition; synergy effects.
TNK-BP	Short list depends on offerings on the market; reaching new markets through M&A; financial attractiveness of the company (NPV); volume of inventory; political factors.
Evraz Group S.A.	Shareholders' selection of target companies; market research; comparison of costs of building a similar business from the scratch and M&A.
Group of companies "Riemer"	Stage 1 - studying companies from a long list considering 7 criteria: type of production/ services; scope of activities; geographical factor; production capacity; major clients (customers); shareholders; financial results. Stage 2 - 3 ranking criteria: an opportunity to acquire control in the shareholders capital; operational efficiency; detailed competency analysis.
LLC "Novaport"	Availability for M&A deal - readiness for sale; aprice factor.
Alliance	Financial modeling, evaluation of the production profile, CAPEX, OPEX.

Oil Company	
OJSC	Availability for M&A deal - readiness for sale.
"MTS"	
OJSC	Strategic relevance of business, financial and economic condition of the company.
"Power Machines"	

*Table 9. The criteria for the short-list*

The interviews with experts from Russian and foreign companies that are directly involved in M&A transactions reveal practically oriented issues expanding the base by adding new theoretically relevant information and relevant experience. The conjunction of both parts of the study provides a comprehensive look at the process of merger and acquisition.

Firstly, all companies set targets for an acquisition on the basis of the corporate strategy. Some omit compiling long lists and short lists, but all companies consider strategic compatibility as a key criterion when choosing a target. A developed strategy sets the basis for elaborating criteria for the targets search, such as location, client portfolio, a range of products or services.

Secondly, the majority of companies adhere to the traditional approach to screening and scoring. Search for potential targets is conducted through analyzing market opportunities, comparing acquiring assets with strategic objectives. Some companies engage external parties such as banks, investment consultants and contractors or exploit the internal potential by involving company's business units, which understand the need for assets to expand the business. Companies tend regularly update their long lists of acquisition targets, which requires fewer resources than creation of new target lists each time for a new deal.

Thirdly, the general screening criteria include sectorial and geographic filters, the possibility of acquiring a target company, a more detailed valuation of operating assets, its financial condition, as well as a price cap of the acquirer. Some companies constantly monitor and analyze the market. When ranking the companies and compiling a short list many acquirers face a problem of a shortage of information, especially if the target is non-public, or belongs to an insufficiently explored industry such as logistics. If an availability of a target company for sale was not examined at the stage of drawing up a long list, this criterion is beginning crucial for a short list. Also, at this stage, companies value targets and assess multiples and conduct peer analysis.

Analysis of case studies and expert interviews contains key indicators and approaches for screening and scoring target companies for acquisitions, but these methods are not a universal solution. Companies belong to different industries and countries, manage deals that differ in terms of volume and scale. Described approaches can be used as a theoretical base and practical examples of M&A



process, but not as a template. A key to success in M&A is a company's understanding of its development trajectory and generating necessary competences, which, in turn, are associated with the corporate strategy.

## REFERENCES

- Boos, F., and Heitger, B. (Eds.) (2005), *Wertschöpfung im Unternehmen: Wie innovative interne Dienstleister die Wettbewerbsfähigkeit steigern*, Springer-Verlag, Berlin.
- Gleich, R., Hasselbach, T., and Kierans, G. (Eds.), (2012). *Value in due diligence: contemporary strategies for merger and acquisition success*, Gower Publishing, Ltd., Surrey.
- Kengelbach, Dr, et al. (2012), "An anatomy of serial acquirers, M&A learning, and the role of post-merger integration." Available at SSRN: <https://ssrn.com/abstract=1946261>.
- Laamanen, T., and Thomas K. (2008), "Performance of serial acquirers: Toward an acquisition program perspective." *Strategic Management Journal* 29.6: 663-672.
- Rosner, S. (2006), "Screening for success: designing and implementing a strategic M&A screening process", *Corporate Finance Review*, 10.4: 9.
- Kubel D., Langthaler, M. "Inside Corporate M&A—The Formula of the Fittest" *Accenture Report*, 2011, [www.accenture.com/us-en/Pages/insight-inside-corporate-m-a.aspx](http://www.accenture.com/us-en/Pages/insight-inside-corporate-m-a.aspx)

## WHEN THINGS GO WRONG: UNTANGLING THE ORIGINS OF INTER-FIRM NETWORK TERMINATION

Vernizzi, Silvia;Cantele, Silvia

Department of Business Administration, University of Verona, Italy

### ABSTRACT

The aim of this paper is to create a more comprehensive framework for business-network termination and to highlight the different factors that in several ways can drive alliance failure in small and medium-sized enterprises (SMEs). Beginning by examining the previous literature, the study classifies factors that influence the duration of inter-firm networks into six main groups: 1) prior experience; 2) goal definition; 3) partner compatibility; 4) risk–return balance; 5) governance mechanisms; 6) soft items.

The results find many factors that drive network failure in several ways. Some of these factors are “hard” (e.g., governance mechanisms) and others are “soft” factors (e.g., trust-building initiatives). In addition, the results demonstrate that factors affecting network termination are not absolutely positive or negative; in contrast, their effect is relative, that is, these factors can play a positive or negative role in network termination depending on the specific context in which they act.

This paper contributes to the existing literature focusing on alliance termination by providing a taxonomy of factors that are important for interpreting inter-firm network termination. In addition, the study has managerial implications for the detection of potential risk factors and the consequent prevention of their transformation into negative outcomes.

*Keywords: networks, alliances, inter-firm relationships, termination, network longevity*

### INTRODUCTION

Growing competitiveness, technological turbulence and the emergence of new markets have deeply affected the global business and economic situation and the key value drivers of competitive advantage. Within this new and volatile environment, inter-organisational networking can be a key strategy by which to explore and exploit opportunities for growth and success (Gomes-Casseres, 1994).

Inter-organisational relationships are driven by many needs, for example, improving production

efficiency, sharing research and development skills, and gaining access to new resources and markets. Each of these aspects has become increasingly important, particularly for small and medium-sized enterprises (SMEs), whose resources are often significantly constrained (Burt, 1997; Ahuja, 2000; Davies, 2009; Håkansson *et al.*, 2009).

In this context, alliances and networks have been leading research topics for management scholars. Although many of studies have focused on the creation (e.g., Gulati, 1995; Mitsunashi and Greve, 2009), governance (e.g., Kale *et al.*, 2002; Saxton, 1997), and performance of inter-firm organisations (Cantele and Vernizzi, 2015; Cantele and Vernizzi, 2016), few have investigated alliance and network termination (e.g., Serapio and Cascio, 1996; Adobor and McMullen, 2002; Reuer and Zollo, 2005; McCutchen *et al.*, 2008; Sadowski and Duysters, 2008; Pangarkar, 2009; Rooks *et al.*, 2013; Cui, 2013; Dan and Zondang, 2016). In particular, the literature on termination usually refers to strategic alliances (and thus mainly to dyadic relationships); however, business networks have specific features that have not yet been extensively researched.

Nonetheless, many scholars have noted that alliances and networks are often problematic and unstable (Das and Teng, 2000; Inkpen and Beamish, 1997; Reuer *et al.*, 2002), and that understanding the drivers affecting inter-organisational-relationship termination represents a crucial part of knowledge on strategic alliances and networks.

Beginning from this premise, the aim of this paper is to review the literature relating to strategic-alliance termination to find common elements applicable to business networks. In particular, the paper explores the different factors found to lead to network termination, and classifies these into logical categories to obtain theoretical and managerial implications. The theoretical implications are connected to the deepening of termination factors relevant to inter-firm networks, whereas the managerial implications are connected to the goal of detecting these factors (i.e., potential risk factors) to prevent them transforming into negative outcomes.

This paper is structured as follows. In the following section, we briefly review the literature that frames our analysis of network termination. We then suggest a classification of the principal factors at the origin of network termination. Finally, we present the concluding remarks and suggestions for future research.

Before moving ahead, it is necessary to present two methodological clarifications. The articles used to examine the driving factors of network termination refer principally to strategic alliances, and in more general terms, to inter-organisational networks. Employing such articles is motivated by the prevalence of studies on alliance termination (rather than on networks), but also by the fact that our aim is to identify the risk factors associated with inter-organisational networking without (for the

moment) analysing factors affecting specific types of network agreement. In addition, we research from the network perspective rather than the focal-firm perspective. That is, we capture factors that can influence the longevity of the network itself, regardless of any specific factors that could drive some focal firms out of the network (e.g., firm-specific financial difficulties or mergers and acquisitions [M&A] events).

## **FACTORS AFFECTING ALLIANCE TERMINATION: LITERATURE HIGHLIGHTS**

Among the different issues stemming from the proliferation of network arrangements, the analysis of the factors of network termination represents a key question for academic researchers, business managers, and policy makers. Several researchers have attempted to analyse the sources of alliance instability, finding different and not always convergent conclusions.

First, it is important to note that network termination does not necessarily represent a negative outcome of alliances (i.e., a failure). On the contrary, as highlighted by Reuer and Zollo (2005), in some cases, termination is experienced as a physiologic step in inter-firm relationships because of consideration such as the firm achieving specific goals. Alliance ending can also be experienced as a “neutral” outcome (i.e., neither positive or negative) related to natural contract expiration or a unilateral withdrawal by a partner because of changes in specific strategic objectives. As the title of this paper—“When things go wrong”—suggests, this paper focuses on the negative aspects of alliance termination, leaving aside the possibilities for a physiologic or neutral ending of inter-firm networks.

Serapio and Cascio (1996) explore (and provide support from real-case examples) why international alliances end and how they end. The researchers identify six different reasons for alliance termination that are related to the outcomes of alliances, the inner difficulties of co-existence between partners, and contingent phenomena. For the first category (outcomes of alliances), the authors identify two main reasons for alliance termination: (1) the alliance has met its goals (successful termination); (2) the alliance cannot achieve its goals (unsuccessful alliance). For the second category (inner difficulties of co-existence between partners), the authors identify differences between partners (i.e., incompatibility of relevant people, different management styles, disagreement over objectives) as one of the main causes of alliance termination (failure side). Moreover, they demonstrate three contingent phenomena that could lead an alliance to end (failure side): (1) breach of agreement; (2) alliance no longer suits the goals/strategies of one partner; (3) exit of a partner because of financial difficulty or other specific issues.

Focusing on e-commerce alliances, Adobor and McMullen (2002) identify five steps/factors firms

should consider to better manage an alliance and increase its longevity. The first step they identify is partner protection against risk. The researchers highlight how in choosing and selecting the portfolio of alliances, firms should pay attention to the risk–return balance criterion. According to the finance-portfolio theory, when firms want to engage in multiple alliances they should select partners that reflect a desirable mix of risk and return. The lack of this balance increases the risk of alliance termination. The second step relates to the structure the of alliance. Informal alliances offer greater flexibility, but they are more likely to end. The contractual agreement can bridge, at least in part, the weakness of informal alliances. In general, the formalisation and implementation of contractual agreements can represent a form of protection of company interests, which increases the chances of alliance continuation. Contrary to prior research, the paper sheds light on the positive effect of short-term commitments. The researchers argue that high-speed environments such as e-commerce are characterised by short-time horizon firms that are focus on short-term payoffs from e-alliances. That is, the high-speed nature of e-commerce technology means that in the short-term, the dependency relationship between a firm and its partners may change radically. Therefore, short-term payoffs may be a positive driver of alliance longevity. Moreover, the definition of clear goals makes alliance management easier and its continuity more likely. Further, trust is a key element of any alliance relationship, which means that firms must create a positive context for trust building. Further, the definition of a clear exit strategy (i.e., that considers the conditions under which partners can take actions such as opting out of the deal and employing dispute-resolution mechanisms) may drive alliance continuity.

Reuer and Zollo (2005) investigate the role of prior alliance experience in alliance termination. Employing a survey administered to biotechnology and pharmaceutical firms engaged in inter-firm research collaboration, the researchers determine that general alliance experience or prior alliances in the same technological area have no significant favourable consequences for alliance termination. The researchers find that only partner-specific experience has a positive effect on successful termination, and that this effect is greater for non-equity alliances than for equity partnerships.

Based on survey responses from 85 parties in a biopharmaceutical alliance McCutchen *et al.* (2008) demonstrate there are four main elements affecting the stability of an alliance. The first element is task complexity, defined as the level of difficulty of achieving alliance objectives. Task complexity can be influenced by a variety of factors such as the nature of the objectives, the number of business functions involved, and the products and market involved in the alliance. An alliance characterised by a high level of task complexity is more likely to experience conflict among partners, which explains the complexity–failure relationship. The second element is partner nationality, distinguishing between domestic alliances and international alliances formed by partners of different countries. The

researchers find that domestic alliances terminate more easily, while differences between international partners increase the probability of obtaining complementary resources. When partner firms come from different countries, they are more likely to possess different technologies, know-how, connections, locations, capacities and distribution channels. Thus, resource complementarity, or resource fit, which is desirable in any alliance formation and duration, is easier to achieve through international alliances. The third element is strategic-alliance experience. Through have prior experience with strategic alliances, firms may develop expertise in identifying good partners, negotiating, inter-firm control, knowledge acquisition, and many other crucial aspects of alliance management, which means they develop so-called “collaborative know-how” (Simonin, 1997). This means that alliances characterised by limited prior strategic-alliance experience are more likely to terminate and have poor performance. Within the area of strategic-alliance experience, the authors identify the fourth element driving alliance termination, that is, disparity of strategic-alliance experience between partners. This element means that if a firm is more effective in achieving specific objectives from the alliance (also because of its prior alliance experience), it will have less need for the alliance (i.e., for its partner). This means that asymmetric experience skews the level of interdependence in an alliance and may result in weakening the alliance.

Sadowski and Duysters (2008) explore the origins of alliance termination by examining 48 strategic technology alliances in different high-technology industries. The researchers find that the first element in influencing the longevity of an alliance is negative prospects about future cooperation. Firms tend to be more loyal to partners once they expect future cooperation with the same partner. The probability that companies engage only in short-term cooperation can easily drive an alliance to terminate. The second element affecting alliance termination is connected to negative perceptions about joint benefits. The belief that both partners would not benefit from the strategic alliance also contributes to its termination. Partnering firms dissatisfied by their ability to gain benefits from the alliance are more willing to terminate the alliance prematurely. The third factor affecting alliance termination is the lack of a win-win situation. The so-called “win-win” situation seems to be an essential requirement for a successful strategic alliance. Therefore, firms might have to engage in extensive pre-alliance discussions to assess the viability and joint benefits of future cooperation.

Pangarkar (2009) identifies prior alliance-termination experience as a key driver of alliance longevity. Referring to a sample of 198 alliances (consisting of 99 alliance terminations and 99 alliance survivals) from the global biotechnology industry, Pangarkar (2009) argues that prior alliance-termination experience enables firms to design better alliances and adopt more appropriate alliance-management strategies to avoid future termination. In addition, Pangarkar (2009) suggests that the alliance-termination experience mediates the relationship between alliance formation and likelihood of alliance

termination. The underlying assumption is that since firms accumulate experience in undertaking organisational activities (e.g., termination management), they become more proficient at managing and preventing these activities. Moreover, the results demonstrate that alliances between dissimilar firms are no more likely to come to terminate than other alliances. On the contrary, a higher cultural distance leads to a lower likelihood of alliance termination because of the value and uniqueness of the resources coming from the partnership.

To understand the origin of alliance instability, Rooks *et al.* (2013) move from internal alliance factors (e.g., partner relationships) to factors related to the way in which a firm occupies a strategic position in the network through being involved in many significant ties (i.e., centrality) (Wasserman and Faust, 1994). By examining 1,061 information and communication technology (ICT)-alliances established in the period 1975–1989, the researchers found that differences in centrality increase alliance instability. Their study combines the centrality of a firm in a network with the resource-fit concept (Das and Teng, 2000), which is deeply rooted in the resource-based view. Resource fit refers to the alignment between one organisation's resource needs and another organisation's resource provisions. Defined in this way, resource fit is one of the main drivers of any strategic alliance. The more the resource fit decreases, and an alternative partner provides better resources, the more an organisation is inclined to end the alliance (Seabright *et al.*, 1992). The researchers state that resource fit is not independent from the position of the firm within the network. Firms that are more central in the network are better positioned to acquire external resources. If firms that are less central in the network are not able to keep up, then the resource fit decreases, and the more central partners are more likely to change partners. Consequently, differences between the degree of centrality of firms in an alliance decrease the resource fit and consequently, shorten the life span of the alliance.

Cui (2013) analyses how the propensity of alliance's termination is influenced by its resource relationships with other alliances of the firm. Many studies argue that dissimilar resources among partners positively affects alliance continuity. However, contrary to previous research, Cui (2013) highlights how under some conditions, resource dissimilarity among partners may be less supportive of, or even detrimental to, the continuity of an alliance. Cui (2013) identifies four conditional factors that may affect the role of resource dissimilarity. First, relational connectedness (i.e., the focal partner's engagement in alliances with other partners) is found to strengthen the positive effect of resource dissimilarity on alliance longevity. Second, vertical connectedness of alliance activities (i.e., the alliance with partners performing different value-chain activities) decreases the positive effect of resource dissimilarity on alliance continuity. Third, the formation of substituting alliances by the focal partner and market uncertainty weaken the role of resource dissimilarity in alliance longevity.

Dan and Zondang (2016) explore how characteristics of alliance partners and of the market at the time

of alliance formation act as predictors of alliance termination. Testing their hypothesis in the biopharmaceutical industry, they shed light on four main factors. First, they demonstrate how an increase in the perceived future value of the alliance is negatively associated with the propensity of alliance termination. That is, the greater the expectation of the co-creation value, (i.e., the perceived future value of the alliance, expressed in terms of factors such as level of financial resources committed to an alliance at its formation, investment in exploration and exploitation activities embedded in the alliance), the less the propensity for alliance termination. In addition, Dan and Zondang's (2016) results highlight the existence of an inverted U-shaped relationship between the focal company's product-market diversity and the propensity for alliance termination. That is, when a potential alliance partner is active in a low number of product markets, the likelihood of the termination of the alliance increases. However, as these same firms learn from their partners and from their different markets, they will also learn how to manage relationships and new market entry more efficiently, which increases the chances of alliance survival. Therefore, the relationship between a company's product-market diversity and the propensity for alliance termination initially increases, and then decreases, presenting an inverted U-shaped relationship. Another factor increasing the propensity for alliance termination is a high level of technological intensity of the alliance partner. Firms that are less dependent on alliance partners for exploration and exploitation activities are expected to share less knowledge. Consequently, firms with higher technological intensity will find fewer benefits in entering and maintaining alliances. The alliances that these firms do enter are expected to be more inherently unstable because technologically intense firms will act more based on self-interest than for the benefit of the alliance (Das and Teng, 2000). Further, the propensity for alliance termination increases more in high-density markets than it does in low-density markets. The complexity of the products, the regulatory environment and the higher level of competition make it difficult to become and remain a successful participant in crowded product markets. Therefore, alliances in high-density product markets are more likely to be terminated. Dan and Zondang's (2016) results confirm this hypothesis, highlighting that the propensity for alliances to be terminated in markets for the treatment of cancer, and neurological and cardiovascular diseases (high-density markets) are significantly higher than for alliances involved in markets for the treatment of blood, dermatological and gastrointestinal diseases (low-density markets).

## **INTER-FIRM NETWORK TERMINATION: TAXONOMY OF FACTORS**

From the examination of the literature focusing on alliances, we propose a taxonomy of the main factors driving alliance termination, which are also applicable to inter-firm networks. After having identified the factors that can affect alliance (and inter-firm network) termination in different ways,



we classified these factors into the following six groups:

1. prior experience
2. goal definition
3. partner compatibility/complementarity
4. risk–return balance
5. governance mechanisms
6. soft items.

Each group is composed of several different factors that, depending on the specific context, can play positive or negative roles in network longevity or termination (Table 1). The positive factors refer to factors that positively influence the longevity of the network, and the negative factors refer to the factors that negatively affect the network duration.

“Prior experience”, refers to factors connected to the previous network experience of firms belonging to the network. “Experience” can be define in different ways: general previous network experience; previous network experience with the same partners; and even, previous experience in network termination. “Goal definition” synthesises factors related to the features of the goals posed by the network cooperation (i.e., task complexity) and to the attitude of firms belonging to the network towards these goals (e.g., commitment). “Partner compatibility/complementarity” combines factors related to the “compatibility and complementarity” among the partners (i.e., resource fit or dissimilarity, cultural differences).

“Risk–return balance” refers to the factors connected to the perception of the cost–benefit ratio of staying within the relationship. “Governance mechanisms” refers to the set of tools that network managers can project and implement to make the network work efficiently towards goals achievement. “Soft items” refers to the set of elements tied to soft items that can affect network longevity in different way, for example, trust, commitment and power.

As stated, we focus our analysis on the network, leaving aside analysis of the role of the focal firm within the network. This means we exclude from our taxonomy factors that are strictly connected to a single firm (e.g., firm-specific financial difficulties and M&A events).

Prior experience	Serapio & Adobor (1996)	McMullen & Reuer (2002)	McCutchen & Sadowski (2008)	Duysters (2009)	Rooks et al. (2013)	Cui (2013)	Dan & Zondang
General prior experience						Positive	
Prior experience with same partner						Positive	
Disparity in prior experience						Negative	
Prior termination experience						Positive	
Goal definition							
Definition of clear goals			Positive				
Task complexity				Negative			
Short-term commitment			Positive		Negative		
Prospects about future cooperation					Positive		Positive
Impossibility of achieving goals				Negative			
Partner compatibility					Positive		
International partnership						Positive	
Resource fit						Positive	
Resource dissimilarity							Negative
Greater cultural distances						Positive	
Difference between partners			Negative				
Risk-return balance perception							Negative
Lack of win-win situation							
Risk-return balance						Positive	
Governance mechanisms							
Lack of formal alliance						Negative	
Formalisation of contractual						Positive	
Formal definition of exit strategy						Positive	
Soft items							
Trust-building initiatives							Positive

Table 1. Factors affecting network termination

An important insight emerging from this taxonomy is that the identified factors emerge in different stages of the network's evolution. For example, some factors, such as experience or goal setting, take shape in the early stages of network formation, but others, such as trust or resource fit, take shape during subsequent stages of the network's activities. For this reason, it would be very useful for future research to attach the factors identified in this preliminary research to the different stages of network evolution to understand the way they behave to improve knowledge in this area and the managerial implications of the research.

## CONCLUDING REMARKS AND FURTHER RESEARCH

Networks are motivated by the need to improve production efficiency, share research and development skills, and gain access to new markets. Each of these aspects has become increasingly important in the current business environment, particularly for SMEs, whose resources are often significantly constrained (Ahuja, 2000; Håkansson *et al.*, 2009).

As seen in the literature on the antecedents of networks and strategic alliances (Cantele and Vernizzi, 2014, Cantele *et al.*, 2016, Christoffersen, 2013), to achieve these goals, networks often rely on a broad set of different elements that are both structured elements and soft elements (e.g., commitment, trust and cooperation).

However, alliances and network relationships often fail to achieve the goals they were built for and either terminate or (more often) come to an inertial status that does not create any successful outcome. Understanding the factors that affect network termination can be useful for preventing such termination and increasing network longevity.

The extant literature demonstrates that there are many different factors that in several ways can drive alliance failure. Some of these are "hard" factors (e.g., governance mechanisms) and other are "soft" factors (e.g., trust-building initiatives).

In addition, this study finds that factors affecting network termination are not absolutely positive or negative; on the contrary, their effect is often relative. That is, these factors can play either a positive or negative role in network termination or longevity, depending on the specific context in which they act. For example, short-term commitment can play a negative role in networks of firms from traditional industries and a positive role in networks of firms from industries that are characterised by a short-time horizon such as e-commerce networks. However, all the factors identified that can be considered risk factors can threaten alliance or network longevity.

This paper represents a preliminary study that has collected research from the alliance literature to create

a more comprehensive framework on business-network termination. Studies on networks usually overlap because the term “network” is used in different contexts, which is why network termination can only be represented by including broad references to different kinds of inter-organisational relationships.

The analysis of network-termination factors synthesised in the paper positions this research path towards two main areas of future research. First, further studies should attempt to match network-termination factors with the different stages of network evolution. This will make it easier for network managers to monitor and prevent the negative effects of such factors because it will allow them to address these factors at the precise stage in which they usually take effect. Second, consistent with prior studies on Italian business networks’ contract agreements (Cantele and Vernizzi, 2014, 2015), further research should test the identified risk factors employing empirical observation to confirm, rather than exclude or extend, the supposed drivers of network termination arising in the literature, and to match the specific evolution stages of the network with their specific threats to longevity.

## REFERENCES

- Adobor, H. and McMullen, R.S. (2002), “Strategic partnering in e-commerce: guidelines for managing alliances”, *Business Horizons*, Vol. 45 No. 2, pp. 67-76.
- Ahuja, G. (2000), “The duality of collaboration: inducements and opportunities in the formation of interfirm linkages”, *Strategic Management Journal*, Vol. 21, pp. 317-343.
- Burt, R.S. (1997), “The contingent value of social capital”, *Administrative Science Quarterly*, Vol. 42 No. 2, pp. 339-365.
- Cantele, S. and Vernizzi, S. (2014), “Antecedents and critical success factors in contractual networks: new insights from Italian case studies”, 7th EuroMed Conference Book of Proceedings”, Kristiansand, Norway, 18-19 September, pp. 2035-2038.
- Cantele, S. and Vernizzi, S. (2015), “The effect of network participation on firm performance: a matched-pairs analysis”, 8th Annual Conference of the EuroMed Academy of Business Innovation, Entrepreneurship and Sustainable Value Chain in a Dynamic Environment, Verona, Italy, 16-18 September, pp. 482-494.
- Cantele, S. and Vernizzi, S. (2016), “Value co-creation and entrepreneurial challenges in business networks: What factors impact upon the performance of firms in networks?”, in H.R. Kaufmann and S.M. Riad Shams (eds), *Entrepreneurial Challenges in the 21st Century: Creating Stakeholder Value Co-creation*, Palgrave Macmillan, pp. 47-68.
- Cantele, S., Vernizzi, S. and Ricciardi, F. (2016), “The emerging wave of agility-oriented business networks in Italy: a new strategy for facing global competition”, *World Review of Entrepreneurship, Management and Sustainable Development*, Vol. 12, No. 2/3, pp. 270-284.
- Cui, A.S. (2013), “Portfolio dynamics and alliance termination: the contingent role of resource dissimilarity”, *Journal of Marketing*, Vol. 77, pp.15-32.
- Dan, S.M. and Zondag, M.M. (2016), “Drivers of alliance terminations: an empirical examination of the biopharmaceutical industry”, *Industrial Marketing Management*, Vol. 54, pp. 107-115.
- Das, T.K. and Teng, B.S. (2000), “A resource-based theory of strategic alliances”, *Journal of Management*, Vol. 26 No. 1, pp. 31-61.
- Davies, I.A. (2009), “Alliances and networks: creating success in the UK fair trade market”, *Journal of Business Ethics*, Vol. 86, pp. 109-126.
- Gomes-Casseres, B. (1994), “Group versus group: How alliance networks compete?”, *Harvard Business Review*, Vol. 72 No. 4, pp. 62-74.
- Gulati, R. (1995), “Social structure and alliance formation patterns: a longitudinal analysis”, *Administrative Science Quarterly*, Vol. 40, pp. 619-652.

- Håkansson, H., Ford, D., Gadde L.E., Snehota, I. and Waluszewsky, A. (2009), *Business in Network*, Wiley, Chichester.
- Inkpen, A.C. and Beamish, P.W. (1997), "Knowledge, bargaining power, and the instability of international joint ventures", *Academy of Management Review*, Vol. 22 No. 1, pp.177-202.
- Kale, P., Dyer, J.H. and Singh, H. (2002), "Alliance capability, stock market response, and long-term alliance success: the role of the alliance function", *Strategic Management Journal*, Vol. 23 No. 8, pp.747-767.
- McCutchen, W.W. Jr, Swamidass, P.M. and Teng, B. (2008), "Strategic alliance termination and performance: the role of task complexity, nationality, and experience", *Journal of High Technology Management Research*, Vol. 18, pp.191-202.
- Mitsuhashi, H. and Greve, H.R. (2009), "A matching theory of alliance formation and organizational success: complementarity and compatibility", *Academy of Management Journal*, Vol. 52 No. 5, pp. 975-995.
- Pangarkar, N. (2009), "Do firms learn from alliance terminations? An empirical examination", *Journal of Management Studies*, Vol. 46 No. 6, pp. 982-1004.
- Reuer, J.J. and Zollo, M. (2005), "Termination outcomes of research alliances", *Research Policy*, Vol. 34, pp. 101-115.
- Reuer, J.J., Zollo, M. and Singh, H. (2002), "Post-formation dynamics in strategic alliances", *Strategic Management Journal*, Vol. 23, pp. 135-151.
- Rooks, G., Snijders, C. and Duysters, G. (2013), "Ties that tear apart: the social embeddedness of strategic alliance termination", *The Social Science Journal*, Vol. 50, pp. 359-366.
- Sadowski, B. and Duysters, G. (2008), "Strategic technology alliance termination: an empirical investigation", *Journal of Engineering and Technology Management*, Vol. 25, pp. 305-320.
- Saxton, T. (1997), "The effects of partner and relationship characteristics on alliance outcomes", *Academy of Management Journal*, Vol. 40 No. 2, pp. 443-461.
- Seabright, M.A., Levinthal, D.A. and Fichman, M. (1992), "Role of individual attachments in the dissolution of interorganizational relationships", *Academy of Management Journal*, Vol. 35 No. 1, pp. 122-160.
- Serapio, M.G. Jr and Cascio, W.F. (1996), "End-games in international alliances", *Academy of Management Executive*, Vol. 10 No. 1, pp. 62-73.
- Simonin, B.L. (1997), "The importance of collaborative know-how: an empirical test of the learning organization", *Academy of Management Journal*, Vol. 40 No. 5, pp. 1150-1174.
- Wasserman, S. and Faust, K. (1994), *Social Network Analysis: Methods and Applications*, Vol. 8, Cambridge University Press.

# DIGITISATION AND BRANDING EVOLUTION: AN INTEGRATIVE CONCEPTUAL FRAMEWORK

Vernuccio, Maria

Department of Management, Sapienza University of Rome, Italy

## ABSTRACT

By systematically analysing academic literature between 1960 and 2016 (July), this article aims to fill a significant gap in the existing literature, offering a broad interpretative framework of branding evolution in the long term. To this end, it establishes three key research perspectives for understanding the evolutionary dynamics of branding, i.e. conceptual, managerial and organisational. These research perspectives are used to interpret in an integrative manner, on the one hand, the different phases of branding evolution by defining five branding paradigms (i.e. sign, image, identity, relational and social paradigm) from a theoretical and managerial standpoint and, on the other hand, the main innovative aspects of branding that are more closely related to digitisation.

*Keywords: Branding evolution, digitisation, branding paradigms, brand management, brand manager system, social engagement platform, hyper-connectivity, openness, systematic literature review, thematic content analysis.*

## INTRODUCTION

The digital revolution is leading to a paradigmatic shift in the way brands connect with people and in the how people connect among themselves. These connections are increasingly taking on the form of an interactive, fast and transparent network (many-to-many). Consequently, the traditional process of creating and managing brands is turning obsolete (Christodoulides, 2009). This process has always been based on linear and deterministic logic with a clear role distinction. On one hand, there is the company, the undisputed owner and sole creator of the brand narrative (Gensler *et al.*, 2013). On the other hand, there are the stakeholders, regarded as the “biddable recipients” of brand value creation (Ramaswamy and Ozcan, 2016). Many are the recent studies focusing on the new dynamics of digital interaction between the brand and consumer/consumer groups (e.g. Gensler *et al.*, 2013; Kozinets, 2014). At the same time, new branding constructs are being developed with the aim of better understanding the scope of participation and interaction (e.g. consumer-brand engagement).

Branding is a conceptual and managerial system that is very dynamic. It has undergone constant change for almost a century, driven both by internal company factors, such as new organisational

structures or managerial styles, and external factors, such as changes to consumer values, diminished product life cycles, increase in the power of trade and technological innovations (Berthon *et al.*, 2003; Louro and Vieira Cunha, 2001; Low and Fullerton, 1994). This system includes theoretical principles (i.e. the meaning of the brand and the sources of its value), as well as managerial and organisational aspects (i.e. players, resources, structures, tools, capabilities, relationships, strategic and tactical processes). Although academics generally agree that traditional branding is no longer suitable for the current “digitally empowered” world (Erdem *et al.*, 2016), there are still two substantial gaps in the existing literature: 1) the lack of studies on long-term evolutionary dynamics of branding and its constituent elements, both theoretical and managerial (Laporte *et al.*, 2016; Low and Fullerton, 1994); 2) the absence of wide-ranging analysis focusing on the impact of digitisation on branding. Therefore, we conducted a systematic literature review and a thematic content analysis in order to answer the following research questions:

RQ 1 – What are the main research perspectives for understanding the long-term evolutionary dynamics of branding from a conceptual, managerial and organisational point of view?

RQ 2 – In light of these perspectives, what are the different paradigmatic phases of branding evolution from a theoretical and managerial standpoint?

RQ 3 – What are the innovative aspects of branding, which are more closely associated with digitisation?

## **THEORETICAL BACKGROUND**

The digital revolution represents a widespread process of a transfer of people, organisations, relational and production processes from an analogue world to a hybrid, liquid and network-based world (Bauman, 2013; Castells, 1996), which Floridi (2011) defines “infosphere”. This new world involves bits and atoms, with new technological, economic and socio-cultural forces at play. The main characteristics of digital marketing contexts may be summarised as follows: 1) hyper-connectivity (Vernuccio and Ceccotti, 2015), based on comprehensive networks (online and offline) and interactivity (as opposed to linearity, hierarchy and unidirectionality). All market players (brands included), constitute interactive nodes in a global network, each with a digital identity that could be termed “networked self” (Papacharissi, 2011) or “digital extended self” (Belk, 2013). 2) Openness, defined by Tapscott (2012) in terms of transparency, breaking down of the traditional boundaries and collaboration/co-working, all of which connote business models, strategies and identity values. Therefore, what has emerged is the phenomenon of consumer empowerment (e.g. Denegri-Knott *et al.*, 2006; Kerr *et al.*, 2012), which can be attributed to greater access to information and consumers’ ability

to control what they access, as well as the option of taking part in the brand discourse and co-creating value with varying levels of engagement (Prahalad and Ramaswamy, 2004).

Researchers and brand managers are thereby forced to respond to these new challenges, questioning the validity of orthodox branding concepts and practices. Since 2000, marketing scholars have increased the efforts in investigating new ways of developing and managing brands. One should consider, for example, the plethora of studies on: the role of brands in online communities (e.g. Muniz and O'guinn, 2001), brand co-creation (e.g. Ramaswamy and Ozcan, 2016), brand management via social media (e.g. Burmann, 2010), and the recent line of research on consumer-brand engagement (e.g. Brodie *et al.*, 2011; Graffigna and Gambetti, 2015). In light of these considerations, first it emerges the need to undertake an analysis of the evolution of branding which encompasses a broader spectrum even from the temporal point of view. It could then be possible to understand and contextualise the innovative aspects of branding, which are more directly connected to digitisation.

## METHODOLOGY

For the purposes of this paper, a systematic literature review has been conducted (Tranfield *et al.*, 2003). The following academic databases have been used at the first stage: Science Direct, Business Source Complete, Scopus and Emerald Management. Papers of potential interest were identified through a structured research in the article title, abstract and key words section of the aforementioned databases based on a combination of different key words. The latter were selected according to the research objectives and background outlined above: "brand manager"; "brand manager system"; "brand management"; "brand strategy"; "brand building"; "brand evolution"; "internet & branding"; "brand & digital"; "brand & social media"; "brand & co-creation"; "brand & engagement"; "consumer empowerment"; "brand & community". Only papers or books written in English (full text) and published between 1960 and July 2016 (from Keith, 1960 to Ramaswamy and Ozcan, 2016) were considered eligible. After duplicate studies were discarded, a database of 498 articles was created. Table 1 shows the criteria of this review protocol.

Inclusion criteria	Exclusion criteria
Full-text	Uncompleted studies
Papers and books	Reports, master and doctoral dissertations
Published within selected period of time (1960-2016/July)	Outside the selected time
Published in the above selected academic database	Duplicated studies
In the domain of branding	

Table 1 – *Inclusion and exclusion criteria in the first phase of the selection protocol.*

In order to make the database more inclusive, a manual search of forward and backward citations was subsequently conducted (Webster and Watson, 2002), which meant that a further five books, 12 articles



and one conference paper were also included. By reading through the abstracts and conclusions of the papers, the second selection phase involved assessing the relevance of these studies to our research objectives. At the end of this process, five books (11 book chapters) and 139 articles were selected (mostly from the Journal of Marketing and the Journal of Brand Management). Finally, the full-texts were thoroughly analysed using the thematic content analysis technique following an exploratory approach (Braun and Clarke, 2006).

## MAIN FINDINGS

The content analysis yielded various inter-connected thematic areas, which represent key research perspectives on the evolution of branding from a conceptual, managerial and organisational point of view (RQ 1). Moreover, in light of these perspectives we identified the different paradigmatic phases of branding evolution (RQ 2) within a broad interpretative framework. Finally, we identified the innovative aspects of branding, which are more closely associated with digitisation (RQ 3). Hence, here follows a brief overview of the results.

### *Conceptual perspective*

In this perspective, we have taken into account all the studies that contributed to establish what constitutes a brand and the source of its value, from the initial statistic concepts to more dynamic, open and recent ones. Five perspectives emerged: brand as sign, image, identity, relationship and social platform. The first phase (“brand as sign”) starts at the beginning of the twentieth century (1900-1930) with an objective perspective centred on the company. The brand is conceived as a set of distinguishing signs (a view still upheld by Kotler, 1991), with the purpose of merely simplifying the purchasing process (Copeland, 1923). The consumer is forced to play a passive role and the brand value is completely embedded within the product (Merz *et al.*, 2009). The decades between the 1930s and the 1980s saw a lengthy period of research in the psycho-social domain (“brand as image”), shifting the perspective onto the consumer as an individual and viewing the brand as a mental representation and bearer of functional and symbolic benefit (Park *et al.*, 1986). The image is the source of the brand value (Merz *et al.*, 2009).

In the following period, which lasted only a decade (1990-2000), the attention was focused on the relationship between brand and consumer (Fournier, 1998), with an initial “emancipation” of the latter (Belk and Costa, 1998). There was a substantial increase of studies looking into the mental mechanisms involved in developing brand perceptions (Keller, 1993) and how such perceptions are at the heart of brand equity generation (Aaker, 1996). At the same time, the brand took on anthropomorphic qualities, acquiring a personality (Aaker, 1997) and an internally-planned identity that was at the heart of the

brand strategy (Kapferer, 1992; Aaker and Joachimsthaler, 2000). This decade, therefore, produced two perspectives: the brand as dyadic relationship and as identity, while the source of the brand value was the value as perceived by the individual, and was developed through to the consumer-brand relationship. Since the turn of the twenty-first century, a socio-cultural and experience-based approach has emerged, with the brand now being seen as a social process (Cayla and Arnould, 2008; Merz *et al.*, 2009). The corporate brand has become increasingly significant (Balmer and Greyser, 2006), while relational perspectives are gradually branching out to the various stakeholders (Gregory, 2007). In the digitally empowered world, brands have become social platforms with which stakeholders can openly engage (Ramaswamy and Ozcan, 2016). Brand value is developed dynamically, through complex social interactions with and among stakeholders, following engagement dynamics and cultural negotiations within communities of fans or much more extensive networks (Brodie, 2009; Gregory, 2007; Ind and Bjerke, 2007; Mühlbacher and Hemetsberger, 2008).

#### *Managerial perspective*

The second theme to emerge from the analysis is the managerial perspective and is closely connected to the conceptual one described above. The managerial perspective involves the various brand management approaches, that are: product-based, adaptive, identity-centred and relational approach. In addition to these approaches previously posited by the literature, a final one is emerged: while not fully defined in the literature and albeit having developed with the digital revolution, this new approach is defined here as “open”. On the one hand, what distinguishes these approaches is the varying degree of brand management strategic orientation: low (tactical orientation) *versus* high degree (strategic orientation) (Louro and Vieira Cunha, 2001; Quinton, 2003). On the other hand, there is a spectrum of managerial approaches, ranging from greater internal emphasis (focus on the characteristics and actions of the organisation as key in the brand value creation) to more external emphasis (focus on market and customer). The first managerial approach, named “product-based”, is related to the brand conceived as a sign and centres on the product and the marketing mix (Kapferer, 1992; Kotler, 1991). The product-based approach is characterised by tactical management of the brand (as a legally protectable trademark), as well as by internal emphasis, whereas the consumer is considered a marginal and passive element. The second tactical approach, named “adaptive” (Louro and Vieira Cunha, 2001), is focused on the brand image with an external emphasis. The consumer is considered as a key player in forging brand meanings. In this case, brand management is a tactical process of cyclical adjustment to consumer perceptions (de Chernatony and Dall’Olmo, 1998). Conversely, the third approach focus on brand identity, is mainly internal and has a strategic orientation. In this case, brand management is accomplished by creating, developing and

communicating the brand identity coherently (Aaker, 1996). The “relational approach” is also strategic, but places greater emphasis on external elements. It involves brand management based on the key role of the relationship between brand and consumer, within which co-creation of value is continually formed through communication of the brand identity (Louro and Vieira Cunha, 2001). The last approach, defined here as “open”, is the one that is most influenced by the digitisation. It combines strategic and tactical orientation with internal and external emphasis. While still fragmentary, the literature highlights the complexity of this brand management approach, illustrating the various aspects in terms of: social process (Mühlbacher and Hemetsberger, 2008); collaboration (Pitt *et al.*, 2006; Gensler *et al.*, 2013); co-creation (Hatch and Schultz, 2010; Ramaswamy and Ozcan, 2016); negotiation (Giesler, 2012); improvisation (Singh and Sonnenburgh, 2012), social engagement (Kozinets, 2014); risk management (Fournier and Avery, 2011); influence management (Bresciani and Ewing, 2014); variety of roles that digital media have in brand building (Aaker, 2015).

#### *Organisational perspective*

The third theme that emerges from the content analysis is the organisational perspective, and is closely linked to the above (Laporte *et al.*, 2016; Louro and Vieira Cunha, 2001; Low and Fullerton, 1994). Two sub-themes have been identified in this area: organisational structures and key players. With regard to organisational structures, the analysis highlighted the prevalence of a more bureaucratic type of functional logic in the case of product/brand-centred and market-centred organisations. The “product/brand centred organisation” is connected to the managerial approaches of product and identity, while the “market-centred organisation” relates to the adaptive managerial approach (Louro & Vieira Cunha, 2001). Conversely, a more flexible and dynamic perspective prevails in “customer-centric organisations”, given the dependence on a managerial-relational approach. Finally, organisational structures linked to today digital revolution, yet largely unexplored by academic literature, should be much more flexible. In relation to these innovative organisational structures, De Swaan Arons (2014) recalls, above all, the necessary characteristic of agility: “Complex matrixed organisational structures [...] are giving way to networked organizations characterized by flexible roles, fluid responsibilities, and more relaxed sign-off processes designed for speed” (p. 61). With regard to the key players (second sub-theme), academic research ranges from an exclusive focus on the brand manager system (Low and Fullerton, 1994) to an explicit evaluation of the new roles of the consumer and other stakeholders in brand building activities (Ramaswamy and Ozcan, 2016; Vernuccio and Ceccotti, 2015), as well as the emerging specialised roles, such as the Chief of Marketing Technologist (Brinker and McLellan, 2014). Analysing how the brand manager system has developed since the 1960s until present, Laporte, Aimé, and Berger-Remy (2016) describe three fundamental brand

manager profiles: 1) “the charismatic influencer” (1960s-1970s) who, despite little formal authority, boasts substantial influence-exerting capacity “thank to a legitimacy gained from recognized expertise but also from ‘personal attraction’” (p. 5); 2) “the good little soldier” (1980s-1990s) with less power and greater focus on internal planning; and 3) a hybrid figure inherited from the previous profiles, who should act as both “galvanic facilitator” and “absolute expert” (post 2000). This last profile coincides with the brand manager at the age of digital revolution. The brand manager should become a deeply renovated figure, equipped with both managerial and entrepreneurial mind-sets, as well as inside-out, outside-in (Day, 1994) and adaptive capabilities, in order to mobilise “dispersed and flexible partner resources” (Day, 2011, p. 188). He/she should play the role of “orchestrator” of both internal and external complementary capabilities: such as analytical, creative, relational and technical-executive (De Swaan Arons, 2014).

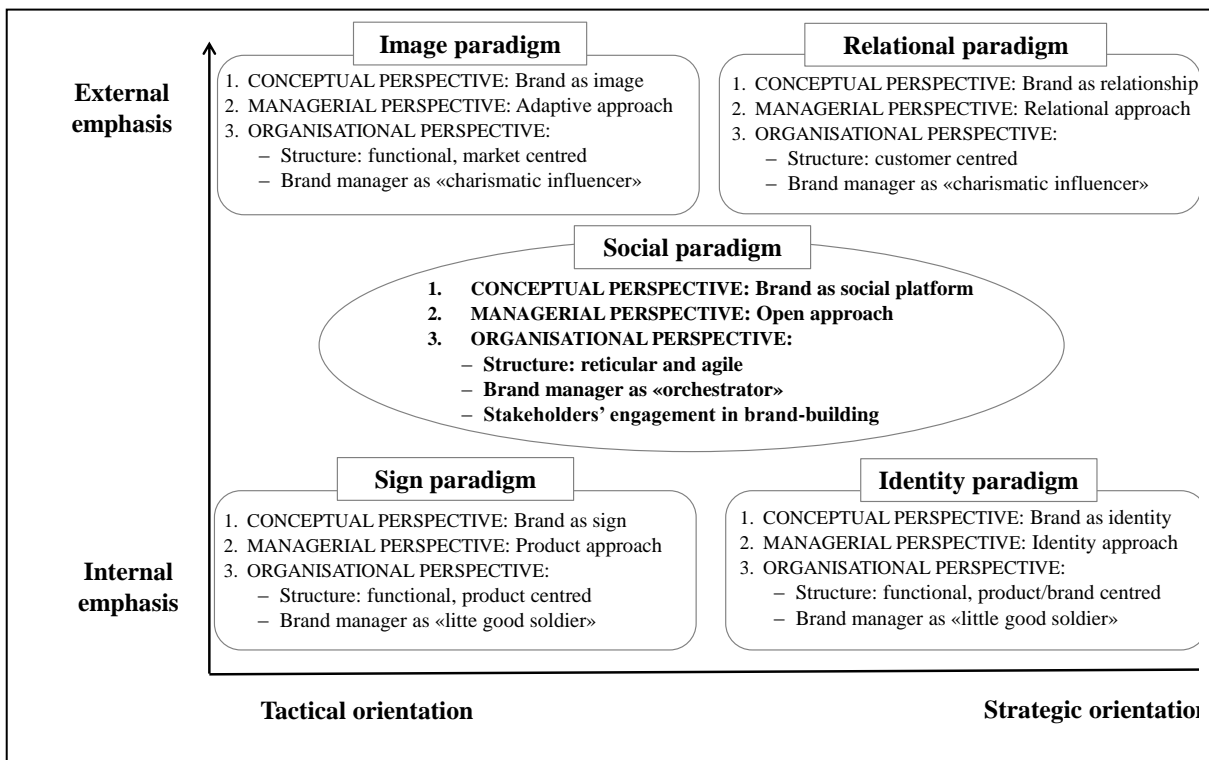

Figure 1 - Paradigmatic phases of branding evolution: An integrative conceptual framework.

In the light of the key research perspectives on the evolution of branding (e.g. conceptual, managerial and organisational) and based upon the aforementioned managerial dimensions of internal/external emphasis and strategic/tactical orientation, we developed a broad interpretative framework representing in an integrative manner the different paradigmatic phases of branding evolution (i.e. sign, image, identity, relational and social paradigm) from a theoretical and managerial standpoint (Figure 1).

*Innovative branding aspects related to digitisation*

The outcome of the content analysis consists in the interpretation of the directions of change and, more specifically, the innovative branding aspects that are closely related to digitisation. As table 2 shows, the directions of change are identified by the combination between the research perspectives on the evolution of branding (i.e. conceptual, managerial and organisational) and the main characteristics of digital marketing contexts (i.e. hyper-connectivity and openness). The specific innovative branding aspects are defined by the combination of the abovementioned dimensions.

	Main characteristics of marketing digital contexts	
	Hyper-connectivity	Openness
Research perspectives on the evolution of branding		
Conceptual perspective (brand as a ...)	Nexus of a global network that includes online and offline worlds	Social engagement platform for stakeholders
Managerial perspective (brand management concerns ...)	Multi-way social processes, both internally and externally oriented	Open approach; integration between strategic and tactical levels; co-creation; stakeholders' engagement; negotiation of meanings; influence management; risk management
Organisational perspective (organising branding is based on ...)	Brand manager as "orchestrator"; network-based structures	Agility, fluidity, inside-out and outside-in capabilities, adaptive capabilities, managerial and entrepreneurial capabilities, new roles

Table 2 - *Innovative branding aspects related to digitisation.*

In particular, thanks to hyper-connectivity and openness, the brand becomes a social engagement platform for stakeholders (Ramaswamy and Ozcan, 2016), representing a nexus of a hybrid network between online and offline worlds. The managerial approach becomes open and multi-way (Vernuccio, 2014), based on negotiating meanings (Gensler et al., 2013) and managing influence (Fournier and Avery, 2011). Increasingly more network-based, agile and flexible, the organisation has at its heart a "new" brand manager, who orchestrates a variety of internal and external capabilities (De Swaan Arons, 2014), while at the same time incorporating new nodes: consumers and other stakeholders.

## CONCLUSIONS

On the theoretical front, this review makes multiple contributions. The comprehensive literature review of the past fifty six years has first and foremost enabled us to establish how branding has evolved according to three key research perspectives (i.e. conceptual, managerial and organisational). Gaining insight from thematic content analysis, we developed a broad interpretative framework representing in an integrative manner the different paradigmatic phases of branding evolution (i.e. sign, image,

identity, relational and social paradigm), from a theoretical and managerial standpoint. Moreover, we have contextualised the most recent changes brought about by the digital revolution within the aforementioned perspectives and in the long term branding evolution. Innovative aspects directly connected to digitisation have thus emerged under conceptual, managerial and organisational profiles. Findings shows the fact that this long evolution has been non-linear and multi-path, with the current branding profiles yet to be researched fully (Aaker, 2015; Louro and Vieira Cunha, 2001).

From an academic point of view, the results make a serious contribution to the brand literature, offering researchers a broad and integrated vision of an evolutionary path that to date has mainly been examined in a fragmentary way (Low and Fullerton, 1994; Laporte *et al.*, 2016). Furthermore, this overview provides researchers an initial integrated analysis on the conceptual, managerial and organisational challenges of branding in the light of the main characteristics of marketing digital contexts. In terms of academic implications, our findings provide marketing scholars with a cogent basis for identifying and developing future lines of research on the manifold innovative aspects of branding under the three perspectives. More specifically, based upon our results, researchers are invited to develop theoretical and empirical studies on under-researched emerging areas, such as the brand as social engagement platform for stakeholders, the brand management inspired by an open approach and the brand manager as “orchestrator” in network-based structures.

As for the practitioners, this work provides a first positive contribution towards developing greater awareness on the substantial innovations which should be implemented with regard to thought systems, managerial practices and organisational solutions for effective brand management in the age of digital revolution. In front of the challenges posed by hyper-connectivity and openness, managers should redesign branding under the perspectives aforementioned, rethinking: 1) the brand concept (as a nexus of a global network that includes online and offline worlds and adds a social engagement platform for stakeholders); 2) the brand management (as a multi-way social process inspired by an open approach); and 3) the brand organisation (with brand managers as orchestrators operating in agile and fluid organisations).

One limitation of the current work is linked to the extreme amplitude of the time span that has been taken into consideration, which does not allow studying deeply on more specific aspects related to the different paradigm phases. Moreover, we only examined English-language academic publications, assuming that this type of article represent suitably business reality. Therefore, we strongly believe that these limitations can easily be overcome by future research, analysing a wider range of publications.

## REFERENCES

- Aaker, D.A. (1996), "Measuring brand equity across products and markets", *California management review*, Vol. 38 No 3, pp. 102-120.
- Aaker, D.A. (2015), "Four ways digital works to build brands and relationships", *Journal of Brand Strategy*, Vol. 4 No. 1, 37-48.
- Aaker, D.A. and Joachimstahler, E. (2000), *Brand leadership*, Free Press, New York, NY.
- Aaker, J.L. (1997), "Dimensions of brand personality", *Journal of marketing research*, Vol. 34 No 3, pp. 347-356.
- Balmer, J.M.T. and Greyser, S.A (2006), "Corporate marketing: integrating corporate identity, corporate branding, corporate communications, corporate image and corporate reputation", *European Journal of Marketing*, Vol. 40 No. 7/8, pp. 730-741.
- Bauman, Z. (2013), *Liquid modernity*, John Wiley & Sons, New York, NY
- Belk, R., and Costa, J.A. (1998), "The mountain man myth: A contemporary consuming fantasy", *Journal of Consumer Research*, Vol. 25 No. 3, pp. 19-33.
- Belk, R.W. (2013), "Extended Self in a Digital World", *Journal of Consumer Research*, Vol. 40, n. 3, pp. 477-500.
- Berthon, P., Holbrook, M.B. and Hulbert, J.M. (2003), "Understanding and Managing the Brand Space", *MIT Sloan Management Review*, Vol. 44 No. 2, pp. 49-54.
- Braun, V. and Clarke, V. (2006), "Using thematic analysis in psychology", *Qualitative research in psychology*, Vol. 3 No. 2, pp. 77-101.
- Bresciani, L. and Ewing, M. (2015), "Brand building in the digital age: The ongoing battle for customer influence", *Journal of Brand Strategy*, Vol 3 No. 4, pp. 322-331.
- Brinker, S. and McLellan, L. (2014), "The Rise of the Chief Marketing Technologist", *Harvard Business Review*, Vol. 92 No. 7/8, pp. 82-85.
- Brodie, R.J. (2009), "From Goods to Service Branding: An Integrative Perspective", *Marketing Theory*, Vol. 9 No. 1, pp. 103-107.
- Brodie, R.J., Hollebeek, L.D., Jurić, B. and Ilić, A. (2011), "Customer engagement: Conceptual domain, fundamental propositions, and implications for research", *Journal of Service Research*, Vol. 14 No. 3, pp. 252-271.
- Burmann, C. (2010), "A call for 'user-generated branding'", *Journal of Brand Management*, Vol 18 No. 1, pp. 1-4.
- Cayla, J. and Arnould, E. J. (2008), "A cultural approach to branding in the global marketplace", *Journal of International Marketing*, Vol. 16 No. 4, pp. 86-112.
- Christodoulides, G. (2009), "Branding in the post-internet era", *Marketing Theory*, Vol. 9 No. 1, pp. 141-144.
- Copeland, M.T. (1923), "Relation of consumers' buying habits to marketing methods", *Harvard business review*, Vol. 1 No. 3, pp. 282-289.
- Day, G.S. (1994), "The capabilities of market-driven organizations", *Journal of Marketing*, Vol. 58 No. 4, pp. 37-52.
- Day, G.S. (2011), "Closing the Marketing Capabilities Gap", *Journal of Marketing*, Vol. 75 No. 4, pp. 183-195.
- Denegri-Knott, J., Zwick, D. and Schroeder, J.E. (2006), "Mapping Consumer Power: An Integrative Framework for Marketing and Consumer Research", *European Journal of Marketing*, Vol. 40 No. 9-10, pp. 950-971.
- De Chernatony, L. and Dall'Olmo Riley, F. (1998), "Defining a 'brand': Beyond the literature with experts' interpretations", *Journal of Marketing Management*, Vol. 14 No. 5, pp. 417-443.
- De Swaan Arons, M., van den Driest, F. and Weed, K. (2014), "The Ultimate Marketing Machine", *Harvard Business Review*, Vol. 92 No. 7/8, pp. 54-63.
- Erdem, T., Keller, K.L., Kuksov, D. and Pieters, R. (2016), "Understanding Branding in a digitally empowered world", *International Journal of Research in Marketing*, Vol. 33 No. 1, pp. 3-10.
- Floridi, L. (2011), *The philosophy of information*. Oxford University Press, Oxford.
- Fournier, S. and Avery, J. (2011), "The uninvited brand", *Business Horizons*, Vol. 54 No. 3, pp. 193-207.
- Gensler, S., Völckner, F., Liu-Thompkins, Y. and Wiertz, C. (2013), "Managing brands in the social media environment", *Journal of Interactive Marketing*, Vol. 27 No. 4, pp. 242-256.
- Giesler, M. (2012), "How doppelgänger brand images influence the market creation process: Longitudinal insights from the rise of botox cosmetic", *Journal of Marketing*, Vol. 76 No. 6, pp. 55-68.
- Graffigna, G. and Gambetti, R.C. (2015), "Grounding consumer-brand engagement", *International Journal of Market Research*, Vol. 57 No. 4, pp. 605-629.
- Gregory, A. (2007), "Involving stakeholders in developing corporate brands: The communication dimension", *Journal of Marketing Management*, Vol. 23 No. 1-2, pp. 59-73.
- Hatch, M.J. and Schultz, M. (2010), "Toward a theory of brand co-creation with implications for brand governance", *Journal of Brand Management*, Vol. 17 No. 8, pp. 590-604.
- Ind, N. and Bjerke, R. (2007), "The Concept of Participatory Market Orientation: An Organisation-Wide Approach to Enhancing Brand Equity", *Journal of Brand Management*, Vol. 15 No. 2, pp. 135-145.
- Hatch, M.J. and Schultz, M. (2010), "Toward a theory of brand co-creation with implications for brand governance", *Journal of Brand Management*, Vol. 17 No. 8, pp. 590-604.

- Kapferer, J.-N. (1992), *Strategic Brand Management: New Approaches to Creating and Evaluating Brand Equity*, The Free Press, New York, NY.
- Keith, R.J. (1960), "The Marketing Revolution", *Journal of Marketing*, Vol. 24 No. 3, pp. 35-38.
- Keller, K.L. (1993), "Conceptualizing, Measuring, and Managing Customer-Based Brand Equity", *Journal of Marketing*, Vol. 57 No. 1, pp. 1-22.
- Kerr, G., Mortimer, K., Dickinson, S. and Waller, D.S. (2012), "Buy, boycott or blog: Exploring online consumer power to share, discuss and distribute controversial advertising messages", *European Journal of Marketing*, Vol. 46 No. 3, pp. 387-405.
- Kotler, P. (1991), *Marketing Management: Analysing, planning, implementation and control*, 7th ed., Prentice-Hall International, Englewood Cliffs, New Jersey.
- Kozinets, R.V. (2014), "Social Brand Engagement: A New Idea", *GfK Marketing Intelligence Review*, Vol. 6 No. 2, pp. 8-15.
- Laporte, M.-E., Aimé, I. and Berger-Remy, F. (2016), "Is the brand manager system doomed to disappear in the age of data?", in *Marketing in the age of data proceedings of European Marketing Academy Annual Conference, Norway, 2016*, RK Grafisk, Oslo, pp. 1-8.
- Louro, M. and Vieira Cunha, P. (2001), "Brand Management Paradigms", *Journal of Marketing Management*, Vol. 17 No. 7-8, pp. 849-875.
- Low, G.S. and Fullerton, R.A. (1994). "Brands, Brand Management, and the Brand Manager System: A Critical-Historical Evaluation", *Journal of Marketing Research*, Vol. 31 No. 2, pp. 173-190.
- Merz, M. A., He, Y. and Vargo, S. L. (2009), "The evolving brand logic: a service-dominant logic perspective", *Journal of the Academy of Marketing Science*, Vol. 37 No. 3, pp. 328-344.
- Mühlbacher, H. and Hemetsberger, A. (2008), "What the heck is a brand? An attempt of integration and its consequences for research and management", in *Proceedings of the 7th International Congress of Marketing Trends 2008 Venice*, ed. Jean-Claude Andreani and Umberto Collesei, Paris-Venice Marketing Trends Association, pp. 1-26, available at: [http://www.marketing-trends-congress.com/sites/default/files/papers/2008/2008\\_fr\\_Muhlbacher\\_Hemetsberger.pdf](http://www.marketing-trends-congress.com/sites/default/files/papers/2008/2008_fr_Muhlbacher_Hemetsberger.pdf) (accessed 20 July 2009).
- Muñiz Jr, A.M. and O'guinn, T.C. (2001), "Brand community", *Journal of Consumer Research*, Vol. 27 No. 4, pp. 412-432.
- Papacharissi, Z. (2011), *A networked self: identity, community and culture on social network sites*, Routledge, New York, NY.
- Park, C.W., Jaworski B.J. and MacInnis D.J. (1986), "Strategic brand concept-image management", *Journal of Marketing*, Vol. 50 No. 4, pp. 135-145.
- Pitt, L.F., Watson, R.T., Berthon, P., Wynn, D. and Zinkhan, G. (2006), "The penguin's window: Corporate brands from an open-source perspective", *Journal of the Academy of Marketing Science*, Vol. 34 No. 2, pp. 115-127.
- Quinton, S. (2013), "The community brand paradigm: A response to brand management's dilemma in the digital era", *Journal of Marketing Management*, Vol. 29 No. 7/8, pp. 912-932.
- Ramaswamy, V. and Ozcan, K. (2016), "Brand value co-creation in a digitalized world: An integrative framework and research implications", *International Journal of Research In Marketing*, Vol. 33 No. 1, pp. 93-106.
- Singh, S. and Sonnenburg, S. (2012), "Brand performances in social media", *Journal of Interactive Marketing*, Vol. 26 No. 4, pp. 189-197.
- Tranfield, D., Denyer, D. and Smart, P. (2003), "Towards a methodology for developing evidence-informed management knowledge by means of systematic review", *British Journal of Management*, Vol. 14 No. 3, pp. 207-222.
- Vernuccio, M. (2014), "Communicating corporate brands through social media: An exploratory study", *International Journal of Business Communication*, Vol. 51 No. 3, pp. 211-233.
- Vernuccio, M. and Ceccotti, F. (2015), "Strategic and organisational challenges in the integrated marketing communication paradigm shift: A holistic vision", *European Management Journal*, Vol. 33 No. 6, pp. 438-449.
- Webster, J. and Watson, R. T. (2002), "Analysing the past to prepare for the future: Writing a literature review", *MIS Quarterly*, Vol. 26 No. 2, pp. xiii-xxiii.



# EFFSAMWMIX : AN EFFICIENT STOCHASTIC MULTI-ARMED BANDIT ALGORITHM BASED ON A SIMULATED ANNEALING WITH MULTIPLICATIVE WEIGHTS

Villari, Bobby Chaitanya; Abdulla, Mohammed Shahid

Indian Institute of Management Kozhikode Institute of Technology, Kerala, India

## ABSTRACT

SAMWMIX, a Stochastic Multi-Armed Bandit (SMAB) which obtains a  $O(\log T)$  where  $T$  being the number of steps in the time horizon, is proposed in the literature. A blind-SAMWMIX which incorporates an input parameter, which has better empirical performance but obtains a regret of the order  $O(\log^{1+2\alpha} T)$ . Current work proposes an efficient version of SAMWMIX which not only achieves a regret of order  $O(\log T)$  but also exults a better performance. A proof for the same is given in this work. The proposed effSAMWMIX algorithm is compared with KL-UCB and Thompson Sampling (TS) algorithms over rewards which follow distributions like Exponential, Poisson, Bernoulli, Triangular, Truncated Normal distribution and a synthetic distribution designed to stress test SMAB algorithms with closely spaced reward means. It is shown that effSAMWMIX performs better than both KL-UCB & TS in both regret performance and execution time.

*Keywords: stochastic multi-armed bandit; stochastic processes; reward distributions; optimization;*

## INTRODUCTION

Decision making under uncertainty is a challenge in a turbulent environment. Partial feedback from the environment leads to incomplete information giving rise to uncertainty. The agent has to learn sequentially (i.e. in many iterations) by relying only on reinforcements with partial feedbacks obtained due to the previous decision. Thus, the decision maker should *explore* the entire set of available decision choices in an attempt to improve the knowledge about the problem's current solution and *exploit* the currently available knowledge on the problem's solution choices to choose the best choice. Multi-Armed Bandits (MAB), a family of Machine Learning algorithms, are tailor-made to handle such explore-exploit problem situations[1]. The

MAB problem is a sequential decision-making task where the decision maker (*agent*) decides to choose (*pull*), at each time step, an action (*arm*) from a pool of  $M$  actions - based on some informed choosing strategy (*policy*). With the aim of maximizing the average payoff from this exercise in the long-run, the *agent* examines these payoffs to continuously improve the *policy* and decide on the future selection of arms. Alternatively, the same can be seen as a regret minimization problem where the regret is the difference between *rewards* of an oracle policy that chooses the best arm in every time step and the rewards of the learned MAB policy. It is known that in  $T$  pulls,  $O(\log T)$  regret is the lowest possible regret an MAB algorithm can achieve and thus the desirable target.

The Upper Confidence Bound (UCB) class of MAB algorithms, both in the stochastic and contextual settings, is considered a benchmark. However, in both settings, UCB requires a 'pick the best arm' behavior, which is performed by explicitly picking the maximum among the  $N$  arms. The metrics associated with each arm will, however, change from pull to pull. This makes the per-step complexity of the UCB class of algorithms  $O(T)$ . The proposed SMAB algorithm effSAMWMIX differs in avoiding maximization and instead picking a 'Soft-Maximum' via a Boltzmann Exploration structure. Since the 'Soft Maximum' is encoded inside a probability vector, the generation of an arm's index using this probability vector contributes to a  $O(\log T)$  complexity - which makes the algorithm very competitive if  $T$  happens to be large. This advantage is over-and-above the improved precision of SAMWMIX and its variants due to a theoretical result[2] that bounds the 'finite sample regret' (i.e. the probability of choosing the wrong arm in each pull).

In a previous work, the authors proposed Gamma Optimized SAMWMIX(GO-SAMWMIX) [3] with a simple heuristic improvement over the original. The bounds on this algorithm largely remain the same as that of original but GO-SAMWMIX is reported to have better effectiveness than its predecessor in terms of the number of times the best of the choices are chosen by the algorithm over a given time horizon  $t$ . This work proposes an efficient version of SAMWMIX which not only obtains a regret of  $O(\log T)$  but also has a better performance in terms of efficiency i.e. the number of times the best action is pulled and thus lowering the regret or maximizing the cumulative reward over the horizon  $t$ . This work compares the performance of effSAMWMIX vis-à-vis that of the state-of-the-art KL-UCB algorithm [4] and Thompson Sampling(TS) algorithm[5, 6] which is seen to gain prominence in this decade. The tests are done over rewards which follow distributions like Exponential, Poisson, Bernoulli, Triangular and Truncated Normal distribution's and a synthetic distribution designed to

stress test the algorithm with closely spaced reward means  $\mu$ . (see section IV). effSAMWMIX has achieved a superior performance as detailed further in this paper.

## MULTI-ARMED BANDITS- A REVIEW

### The Multi-Armed Bandit(MAB) problem in brief

A MAB problem is a sequential decision-making problem with discrete time steps or horizon  $T$ . The agent chooses an action in every time step from a set of  $N$  possible actions. Then the environment will provide the reward pertaining to action  $i$  at time step  $t < T$ . Thus process continues in the following way.

1. *Agent chooses action  $I_t$  & thus interacts with environment*
2. *Environment provides the rewards  $x_{i,t} \in [0,1]$  for  $t \in \{1, T\}$  and reward  $x_{i,t}$*
3. *Observing this reward,  $x_{i,t}$ , the agent tries to maximize the cumulative reward i. e.  $\sum_{t=1}^T x_{I_t,t}$  by the time step  $T$*

Fig.1. The MAB problem

For a general MAB, it is to be noted that the rewards could follow any distribution but are to be bounded by  $[0,1]$ . An agent is tested to achieve a highest cumulative reward or lowest cumulative regret to be graded better. Imposing additional assumption on the generalized MAB problem will lead to a variant, of our interest, called the Stochastic Multi-Armed Bandit (SMAB).

### The Stochastic Multi-Armed Bandit (SMAB)

In SMAB settings it is assumed that the reward  $x_t$  follows a fixed distribution  $v_i$  on  $[0,1]$  unknown to the agent. The reward of each action  $i$  is independent of the rewards it obtained from any other time horizon (or pull) and independent of rewards of other actions [7]. This means that the rewards  $\{X_t^i\}_{i \in N}$  are assumed to be i.i.d from  $v_i$  and all the rewards of  $K$  choices (arms) are also independent of each other.

In addition to Stochastic settings, an adversarial setting [8] that exists for MABs which is not the setting for the algorithms studied in this work.

### Performance Measures for an SMAB

In an SMAB (also for any MAB) setting, an algorithm is evaluated based on the cumulative reward or the cumulative regret obtained due to the agent's decision-making processes over the time horizon. , regret  $\mathcal{R}$  is a measure of how far the performance of contended algorithm is compared to an oracle policy that knows how to pick the best possible action in every each time step  $i$  in horizon  $\mathcal{H}$ . For all CMABs, regret  $\mathcal{R}$  is a central conceptual variable to be considered and concentrated towards obtaining a logarithmically changing regret over time horizon. During experimentation the regret  $\bar{\mathcal{R}}$  is plotted against horizon  $\mathcal{H}$  so as to observe and compare with algorithms reported or contended against.

An expected payoff regret or simply expected regret  $\bar{\mathcal{R}}$  is defined as follows

$$\bar{\mathcal{R}} = \sum_{t=1}^T \left( \max_{i=1,2,\dots,N} E[X_t^i] \right) - \sum_{t=1}^H X_t^{t_t}$$

Thus  $\bar{\mathcal{R}}$  is the difference between the payoff of an optimal arm as selected by an oracle policy (in expectation over the arm's distribution) and the actual payoff obtained by the MAB policy in contention. Since in real time environment, the oracle policy might not be known in advance,  $\bar{\mathcal{R}}$  happens to have significance only in simulated environments where the testing is done to evaluate the algorithm's performance.

### THE *effSAMWMIX* ALGORITHM

The *effSAMWMIX* algorithm is based on SAMWMIX[2] which indeed is based on a variant of simulated annealing called Simulated Annealing with Multiplicative Weights(SAMW).The regret is calculated as given below. As mentioned earlier, the SAMWMIX and its variants use a 'Soft-Maximum' via a Boltzmann Exploration structure. Since the 'Soft Maximum' is encoded inside a probability vector, the generation of an arm's index using this probability vector contributes to a  $O(\log K)$  complexity – which makes the algorithm very competitive if  $K$ , the number of available arms, happens to be large. This binds the finite sample regret which is the probability of choosing a wrong action in each pull.

The *effSAMWMIX* algorithm chooses the arms by calculating and maintaining a vector  $\phi_t^j$  where  $j \in [1, K]$  are the number of arms available and  $t \in [1, T]$  is the time horizon. The  $\phi_t^j$  is given below.

$$\phi_{k+1}^j = (1 - \gamma_k) \frac{\phi_k^j e^{\sum \eta_t \bar{X}_k^j}}{\sum_{j=1}^N \phi_k^j e^{\sum \eta_t \bar{X}_k^j}} + \frac{\gamma_k}{N} \quad (1)$$

(1) is similar to (10) of [2] since it represents a Boltzmann exploration schema. The learning component which is the step-size  $\gamma_t$  and the inverse temperature parameter is given below.

$$\gamma_k = \frac{N(4 + (d + d_k))}{k(d + d_k)^2 - (d + d_k - 2d^2)} \quad (2)$$

$$\eta_k = \frac{1}{\frac{N}{\gamma_k} + 1} \log \left( \frac{1 + d \left( \frac{n}{\gamma_k} + 1 \right)}{\frac{2N}{\gamma_k} - d^2} \right) \quad (3)$$

The construction of proof is based on the definition of an expected regret which is defined as the expected cumulative loss incurred due to not playing the best possible arm  $a_t^*$  during the iteration  $t$  where  $t \in [1, T]$ . The calculation of the maximum expected regret is put below.

$$\begin{aligned} \text{Maximum Regret of MAB} &= \text{Max}_{1 \leq j \leq N} E[\sum_{t=1}^T (X_t^i - X_t^{jt})] \\ &= E[\sum_{t=1}^T (X_t^1 - X_t^{jt})] \\ &= \sum_{t=1}^T [E(X_t^1 - X_t^{jt})] \\ &= \sum_{t=1}^T E[E(X_t^1 - X_t^{jt}) / \mathcal{F}_{t-1}] \\ &= \sum_{t=1}^T E \left[ \sum_{j=2}^N \Delta_j \phi_t^j \right] \\ &= \sum_{t=1}^T \left[ \sum_{j=2}^N \Delta_j E[\phi_t^j] \right] \end{aligned}$$

Figure 2. Calculation of Maximum Expected Regret

The proof for logarithmic regret is similar to that of SAMWMIX and thus can be documented similarly. Since  $\sum_{p=1}^T (\Delta_i/p) = \log(T)$ , obtaining an upper bound of  $O\left(\frac{1}{T}\right)$  on expectation  $E\{\phi_t^i\}$  for any suboptimal arm implies a logarithmic regret in effSAMWMIX. From the following set of equations, we derive the value of  $\gamma_k$  which essentially differentiates the effSAMWMIX from SAMWMIX.

By altering the Boltzmann exploration schema of SAMWMIX from

$$\phi_{t+1}^j = (1 - \gamma_t) \frac{\phi_t^j e^{\sum \eta_t \bar{X}_t^j}}{\sum_{j=1}^N \phi_t^j e^{\sum \eta_t \bar{X}_t^j}} + \frac{\gamma_t}{N}$$

which is (10) of [2] to that of effSAMWMIX which is

$$\phi_{t+1}^j = (1 - \gamma_t) \frac{e^{\sum \eta_t \bar{X}_t^j}}{\sum_{j=1}^N e^{\sum \eta_t \bar{X}_t^j}} + \frac{\gamma_t}{N}$$

where  $\eta_k = \frac{1}{\frac{N}{\gamma_k} + 1} \log \left( \frac{1+d(\frac{N}{\gamma_k}+1)}{\frac{2N}{\gamma_k} - d^2} \right)$

if  $K_p = d, C_p = \frac{N}{\gamma_p} + 1, \sigma_p^2 = 2 * \frac{N}{\gamma_p} - d^2$ , then

$$\eta_p = \frac{1}{C_p} \log \left( \frac{1 + C_p K_p}{\sigma_p^2} \right)$$

The regret is defined as  $\bar{R} = \sum_{t=1}^T [\sum_{j=2}^N \Delta_j E[\phi_t^j]]$

But  $\phi_{t+1}^j = (1 - \gamma_t) \frac{e^{\sum \eta_t \bar{X}_t^j}}{\sum_{j=1}^N e^{\sum \eta_t \bar{X}_t^j}} + \frac{\gamma_t}{N}$

Thus  $\bar{R} = \sum_{t=1}^T \left[ \sum_{j=2}^N \Delta_j E \left[ (1 - \gamma_t) \frac{e^{\sum \eta_t \bar{X}_t^j}}{\sum_{j=1}^N e^{\sum \eta_t \bar{X}_t^j}} + \frac{\gamma_t}{N} \right] \right]$   
 $= \sum_{t=1}^T \left[ \sum_{j=2}^N \Delta_j E \left[ (1 - \gamma_t) \frac{e^{\sum \eta_t \bar{X}_t^j}}{\sum_{j=1}^N e^{\sum \eta_t \bar{X}_t^j}} \right] \right] + \frac{\gamma_t}{N}$

Since  $e^{\sum \eta_1 \bar{X}_t^1} \leq \sum_{j=1}^N e^{\sum \eta_t \bar{X}_t^j}$ , the following equation (4) holds true.

$$(1 - \gamma_t) \frac{e^{\sum \eta_t \bar{X}_t^j}}{\sum_{j=1}^N e^{\sum \eta_t \bar{X}_t^j}} + \frac{\gamma_t}{N} \leq (1 - \gamma_t) \frac{e^{\sum \eta_t \bar{X}_t^j}}{e^{\sum \eta_1 \bar{X}_t^1}} + \frac{\gamma_t}{N} \quad (4)$$

Considering the following inequality

$$e^{\sum_{k=1}^{K-1} \eta_k \bar{X}_k^j} * e^{\eta_k (d_k) * (\bar{X}_t^j + d_k)} \leq \sum_{j=1}^N e^{\sum_{k=1}^K \eta_k (d_k) \bar{X}_k^j} \quad (5)$$

be true for every  $i$  including  $i = 1$  to  $N$  and if  $a_k$  is the winner arm in  $k_{th}$  iteration, (5) can be written as follows

$$e^{\sum_{k=1}^{K-1} \eta_k \bar{X}_k^{a_k}} * e^{\eta_k (d_k) * (\bar{X}_t^{a_k} + d_k)} \leq \sum_{j=1}^N e^{\sum_{k=1}^K \eta_k (d_k) \bar{X}_k^j} \quad (6)$$

Fetching  $\eta_p$  from SAMWMIX [2]

$$\eta_p^{samwmix} = \frac{1}{C_p} \log \left( \frac{1 + C_p K_p}{\sigma_p^2} \right) \text{ where } k_p = d$$

$$\eta_p^{samwmix} = \frac{1}{C_p} \log \left( \frac{1 + C_p d}{\sigma_p^2} \right)$$

Analogous to SAMWMIX we define  $\eta_p^{effsamwmix}$  as

$$\eta_p^{effsamwmix} = \frac{1}{c_p} \log \left( \frac{1+c_p(d+d_p)}{\sigma_p^2} \right) \quad (7)$$

Getting the notations back incorporating  $d_k$ , i. e.

$$\eta_p^{effsamwmix} = \eta_p(d_p), \text{ parameterized by } d_k$$

$$\eta_p(d_p) = \frac{1}{C_p} \log \left( \frac{1 + C_p(d + d_p)}{\sigma_p^2} \right)$$

$$\phi_{p+1}^j = (1 - \gamma_p) e^{\sum_{p=1}^K \frac{-K_p^2}{2\sigma^2 + K_p C_p}} + \frac{\gamma_t}{N}$$

To obtain logarithmic regret, the summation term in exponent should be a logarithmically increasing entity. Hence we equate it to  $\log K$

$$\sum_{p=1}^K -\frac{K_p^2}{2\sigma^2 + K_p C_p} = -\log K$$

which implies that  $\frac{K_p^2}{2\sigma^2 + K_p C_p} = \frac{1}{k}$  (8)

Since  $K_p = (d + d_k)$ , equation (8) is rewritten as

$$\frac{(d + d_k)^2}{2\left(\frac{2N}{\gamma_k} - d^2\right) + (d + d_k)\left(\frac{N}{\gamma_k} + 1\right)} = \frac{1}{k}$$

Thus  $\gamma_k = \frac{N(4+(d+d_k))}{k(d+d_k)^2 - (d+d_k-2d^2)}$

Thus an exploration parameter  $\gamma_k = \frac{N(4+(d+d_k))}{k(d+d_k)^2 - (d+d_k-2d^2)}$  will aid effSAMWMIX in achieving a logarithmic regret  $\log T$  over the horizon  $T$ . The pseudocode for effSAMWMIX algorithm is put below

**Algorithm 1 effSAMWMIX SMAB algorithm**

Input : Rewards Vector  $G_t$ , set of Arms  $N$ , number of rounds  $T$

1. Using  $G_t$  Calculate  $d = \min \Delta(\mu_1, \mu_2 \dots \mu_N)$  where  $\mu_i$  is the reward mean of Arm  $i$ .
2. Calculate
  - a.  $C_0 = N + 1; \sigma^2 = 2 * N;$
  - b.  $\eta_0 = \frac{1}{c_0} \log \left( \frac{1+c_p*d}{\sigma^2} \right)$
  - c.  $startIter = ((4 + d) * N + d)/d^2$
3. for  $i = 1, \dots, N$  do
  - a. Obtain reward  $X_{t=i}^i$
  - b. Initialize  $\phi_t^i = \eta_0 * \left( \frac{startIter}{N} \right) * \left( \frac{X_{t=i}^i}{N} \right)$
  - c. Initialize pull count for arm  $a^i$  as  $p_i=1$
4. for  $t = (startIter + 1 + N), \dots, (startIter + T)$  do
  - a. Obtain random probability  $r$
  - b. Choose an arm  $i$  as winner if  $\sum \phi_t^i > r$  and store reward  $G_{t-startIter}^i = a_t^*$  and normalize the reward using its probability  $\hat{X} = a_t^*/\phi_t^i$

- c. Update  $p_i = p_i + 1$
- d. for  $d_t = 1, \dots, \frac{t - \text{startIter}}{T - N}$  in steps of  $d_{tstep}$  do
- i. Calculate  $k_t = d + d_t$ ;
  - ii.  $\gamma_{ttemp} = ((4 + k_t) * N + k_t) / (t * k_t^2)$
  - iii.  $C_t = \left(\frac{N}{\gamma_{ttemp}}\right) + 1$  and  $\sigma_{ttemp}^2 = 2 * N / \gamma_{ttemp}$
  - iv.  $\eta_t = \frac{1}{C_t} \log\left(\frac{1 + C_t * k_t}{\sigma_{ttemp}^2}\right)$
  - v.  $\sum \phi_{ttemp}^i = \sum \phi_t^i + e^{\sum \eta_t \bar{X}_t^i}$
  - vi. If  $e^{\sum \eta_t * (d_t * \bar{X}_t^i) + \eta_t * (d_t * \bar{X}_t^{a_t})} > \sum \phi_{ttemp}^i$  then assign  $d_{ttrue} = d_t - d_{tstep}$
- e. Assign
- i.  $K_t = d_t + d_{ttrue}$
  - ii.  $\gamma_t = ((4 + k_t) * N + k_t) / (t * k_t^2)$
  - iii.  $C_t = \left(\frac{N}{\gamma_{ttemp}}\right) + 1$  and  $\sigma_t^2 = 2 * N / \gamma_{ttemp}$
  - iv.  $\eta_t = \frac{1}{C_t} \log\left(\frac{1 + C_t * K_t}{\sigma_t^2}\right)$
- f. Now update  $\phi_{t+1}^j$  using (1) which is

$$\phi_{t+1}^j = (1 - \gamma_t) \frac{e^{\sum \eta_t \bar{X}_t^j}}{\sum_{j=1}^N e^{\sum \eta_t \bar{X}_t^j}} + \frac{\gamma_t}{N}$$

Output :  $\phi$  vector

---

## EMPIRICAL EVALUATION OF *effSAMWMIX*

*effSAMWMIX* is currently being compared to the performance of KL-UCB and TS. We chose KL-UCB for that it is prominently cited and compared to in MAB literature. Similarly, TS is gaining prominence[9] in the scientific fraternity in this decade. Also, *effSAMWMIX* has performed better than its predecessors GO-SAMWMIXM and SAMWMIX which in turn has as superior performance over UCB1 algorithm. This work reports the performance of *effSAMWMIX* vis-à-vis to that of KL-UCB and TS over the following reward distributions. The main purpose of these numerical experiments using various reward distributions is to compare the performance in terms of cumulated regret and the number of times the arm with the best mean reward (best arm henceforth) is pulled.



### Customized Synthetic Distribution (CuSyn)

It is known that the mean reward of any arm influences the decision making of an SMAB. The closer the mean rewards of the available arms, the difficult it should be for an SMAB algorithm to latch on to the best arm for that iteration. A Customized Synthetic Distribution (CuSyn) is designed with an input parameter that allows distributing the rewards of the arms so that the minimum reward mean's difference between any two arms is controlled. For example, using 0.1 as a parameter, the arms' reward distributions will be placed so that the closest of the arms will have their reward means differing only by 10%. This ensures control over the closeness of the arms and allows for stress testing the algorithm.

### A few other Reward distributions

Taking clues from [10], reward distributions of the arms are set so that their means are in an exponential distribution or a Bernoulli distribution. The algorithms are tested with arms that follow a Triangular Distribution [11] and a Normal distribution truncated to be bounded between [0,1] (Truncated Normal Distribution henceforth). The results of the numerical experiments are put below.

### Design of the Experiment

Numerical experiments are performed on effSAMWMIX, KL-UCB and Thompson Sampling (TS) algorithms using the computational software package MATLAB. All the distributions are to have rewards  $\hat{x} \in (0,1)$  and the rewards are i.i.d for all the five arms ( $K = 5$ ) in consideration. The time horizon is set to be 2000 pulls ( $T = 2000$ ) and each run of the code is called an experiment. 100 such experiments are conducted and the results are averaged to remove any randomness in the results. The results are put below when the rewards followed each of the distributions named below.

- MEASURED CPU TIME FOR ALGORITHMS.

CPU Time for each rewards Distribution	Algorithm ( time in milliseconds)		
	effSAMWMIX	KL-UCB	Thompson Sampling
CuSyn	66.69	199.68	363.45
Triangular	57.98	195.90	343.45
Truncated Normal	65.20	201.85	357.60
Bernoulli	66.54	196.23	353.98
Poisson	65.26	201.17	360.01

Exponential	67.53	200.51	360.53
-------------	-------	--------	--------

Customized Synthetic(CuSyn) Distribution

The cumulative regret accumulated by effSAMWMIX is the lowest as shown in Fig.1. effSAMWMIX has chosen the best possible arm the most number of times (see Fig.2.) and thus aggregated to a lower regret compared to KL-UCB and TS.

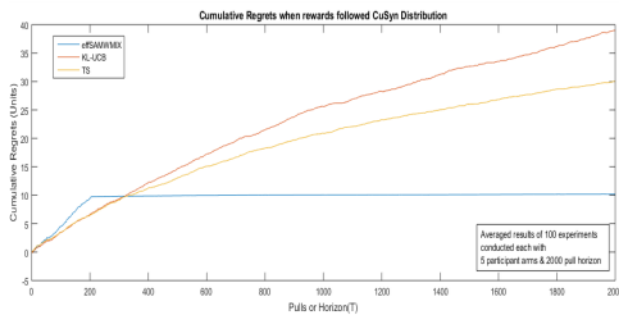

Fig 1. Comparison of cumulative regrets when the rewards followed a Customized Synthetic Distribution.

Also, the average time taken, to run an experiment with effSAMWMIX is about 67milliseconds which is the lowest (See Table.1). Thus effSAMWMIX is both effective (lower regret) and efficient (lower computation time) of the three algorithms.

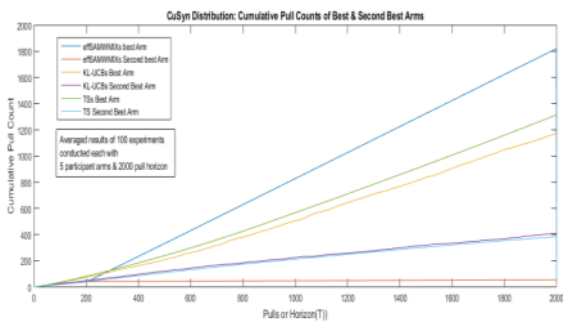

Fig 2. Comparison of best arm's Pull Count when the rewards followed a Customized Synthetic Distribution.

Triangular Distribution

effSAMWMIX performed better than the other two algorithms both in terms of efficiency and effectiveness. The cumulative regret accumulated by effSAMWMIX is the lowest as shown in Fig.3.

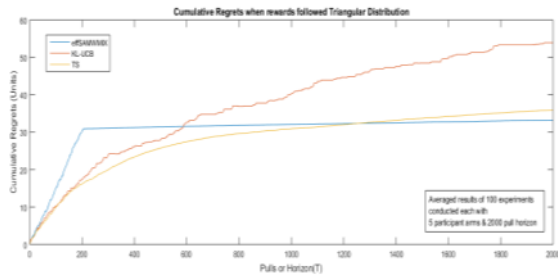

Fig 3. Comparison of cumulative regrets when the rewards followed a Triangular Distribution

effSAMWMIX has chosen the best possible arm the most number of times (see Fig.4.) and thus aggregated to a lower regret compared to KL-UCB and TS. Here also the average time taken to run an experiment with effSAMWMIX is about 58 milliseconds which is the lowest (See Table.1) of that of the three algorithms.

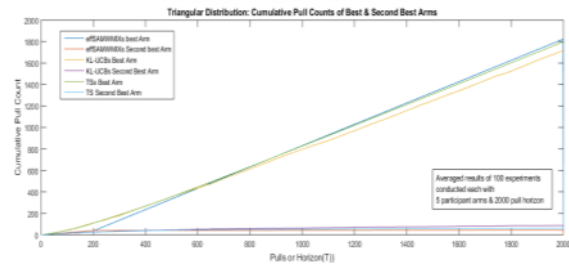

Fig 4. Comparison of best arm’s Pull Count when the rewards followed a Triangular Distribution.

Truncated Normal Distribution

effSAMWMIX’s performance is superior to other two algorithms when the mean of arms’ rewards followed a Truncated Normal Distribution.

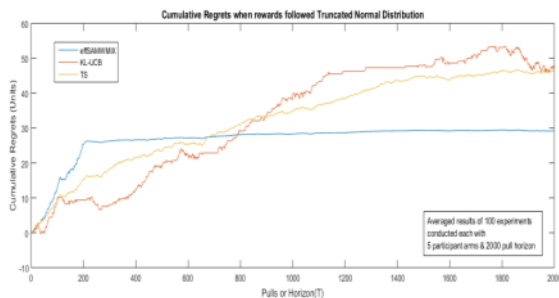

Fig 5. Comparison of cumulative regrets when the rewards followed a Truncated Normal Distribution

effSAMWMIX is superior both in effectiveness and efficiency (see Fig.5 & Fig 6)

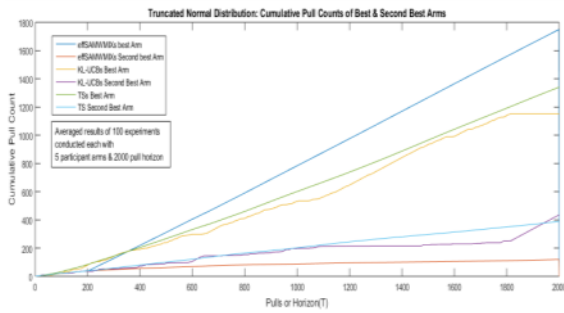

Fig 6. Comparison of best arm’s Pull Count when the rewards followed a Truncated Normal Distribution.

Bernoulli Distribution

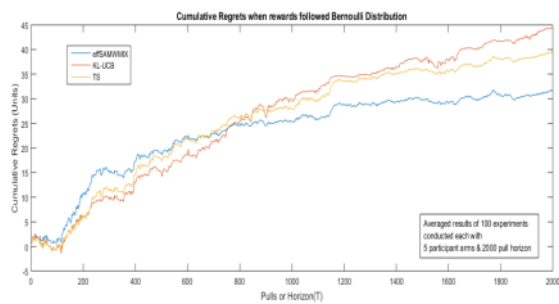

Fig 7. Comparison of cumulative regrets when the rewards followed a Bernoulli Distribution

When the mean of arms’ rewards followed a Bernoulli distribution the performance results are favorable to effSAMWMIX both of effectiveness and efficiency (see Fig.7 & Fig 8)

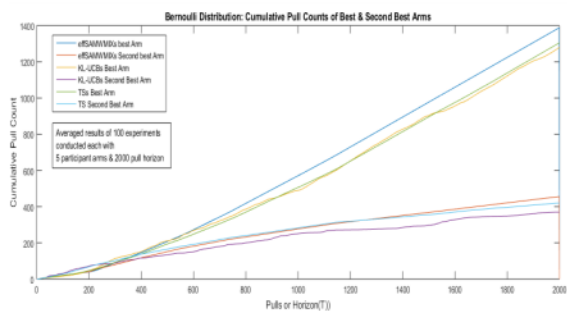

Fig 8. Comparison of best arm’s Pull Count when the rewards followed a Bernoulli Distribution.

Poisson Distribution

effSAMWMIX performed better than the other two algorithms in terms of time efficiency.



Fig 9. Comparison of cumulative regrets when the rewards followed a Poisson Distribution

TS has performed better than both KL-UCB and effSAMWMIX (see Fig.1 & Fig.2.) even though TS’s time efficiency is the lowest of the three (see Table .1.).

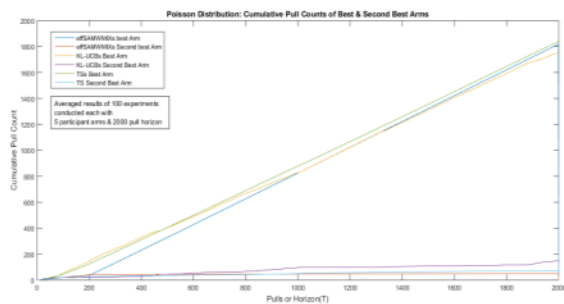

Fig 10. Comparison of best arm’s Pull Count when the rewards followed a P Distribution.

Exponential Distribution

The time efficiency of effSAMWMIX is still the best among the algorithms in comparison but the regret of KL-UCB is the lowest.

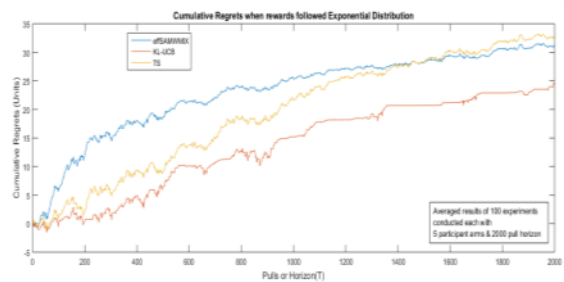

Fig 11. Comparison of cumulative regrets when the rewards followed an Exponential Distribution

While effSAMWMIX achieved a lower regret than that of TS, KL-UCB has the best regret when the rewards followed an Exponential distribution.

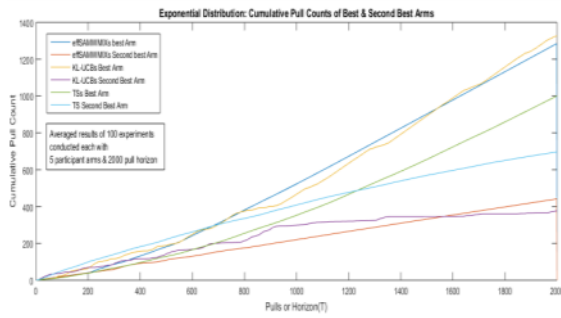

Fig 12. Comparison of best arm's Pull Count when the rewards followed an Exponential Distribution.

## CONCLUSIONS AND FUTURE DIRECTIONS

The proposed SMAB algorithm effSAMWMIX is compared with the KL-UCB and Thompson Sampling MAB algorithms. The tests are run when the available arms follow the various distributions mentioned in the preceding sections. In all the cases, effSAMWMIX achieved a better time efficiency than those in comparison. Except for when the arms' rewards followed either an Exponential distribution or a Poisson distribution, effSAMWMIX outperformed KL-UCB and TS in terms of effectiveness i.e. with a minimum of the cumulative regret achieved over the horizon. In the case when the arms' rewards followed an exponential distribution, KL-UCB achieved the lowest regret while effSAMWMIX ranked second. And in the Poisson distribution case, effSAMWMIX performed next to Thompson Sampling SMAB.

The effSAMWMIX obtains a *logarithmic* regret which is a desirable property for an SMAB algorithm. Also effSAMWMIX has a faster execution time and has the best regret performance among the three algorithms and in all the cases in discussion. In future, the authors intend to check the applicability of this algorithm by extending it to incorporate contextual information so as to address the explore-exploit problems that are common in any real-world business environment like that of a News article recommendation or cold-start problems in ecommerce domain.

## REFERENCES

- 1 Vargas, A.M.: 'Linear Bayes policy for learning in contextual-bandits', Expert Systems with Applications, 2013, 40, (18), pp. 7400-7406

- 2 Abdulla, M.S., and Bhatnagar, S.: 'Multi-armed bandits based on a variant of Simulated Annealing', *Indian Journal of Pure and Applied Mathematics*, 2016, 47, (2), pp. 195-212
- 3 Bobby Chaitanya, V., & Mohammed Shahid A: 'Bandit Algorithms for Contextual Advertising: An Evaluation of SOFTMIX algorithm over the benchmark Yahoo! FrontPage Today Dataset.'. Proc. 2nd Pan I.I.M World Management Conference, Kozhikode, India2014, November pp. Pages
- 4 Garivier, A., and Cappé, O.: 'The KL-UCB Algorithm for Bounded Stochastic Bandits and Beyond', in Editor (Ed.)^(Eds.): 'Book The KL-UCB Algorithm for Bounded Stochastic Bandits and Beyond' (2011, edn.), pp. 359-376
- 5 Kaufmann, E., Korda, N., and Munos, R.: 'Thompson sampling: An asymptotically optimal finite-time analysis', in Editor (Ed.)^(Eds.): 'Book Thompson sampling: An asymptotically optimal finite-time analysis' (Springer, 2012, edn.), pp. 199-213
- 6 Thompson, W.R.: 'On the likelihood that one unknown probability exceeds another in view of the evidence of two samples', *Biometrika*, 1933, 25, (3/4), pp. 285-294
- 7 Robbins, H.: 'Some aspects of the sequential design of experiments': 'Herbert Robbins Selected Papers' (Springer, 1985), pp. 169-177
- 8 Auer, P., Cesa-Bianchi, N., Freund, Y., and Schapire, R.E.: 'Gambling in a rigged casino: The adversarial multi-armed bandit problem', in Editor (Ed.)^(Eds.): 'Book Gambling in a rigged casino: The adversarial multi-armed bandit problem' (IEEE, 1995, edn.), pp. 322-331
- 9 Agrawal, S., and Goyal, N.: 'Analysis of Thompson Sampling for the Multi-armed Bandit Problem', in Editor (Ed.)^(Eds.): 'Book Analysis of Thompson Sampling for the Multi-armed Bandit Problem' (2012, edn.), pp. 39.31-39.26
- 10 Kaufmann, E., Cappé, O., and Garivier, A.: 'On Bayesian Upper Confidence Bounds for Bandit Problems', in Editor (Ed.)^(Eds.): 'Book On Bayesian Upper Confidence Bounds for Bandit Problems' (2012, edn.), pp. 592-600
- 11 Kotz, S., and Van Dorp, J.R.: 'Other Continuous Families of Distributions with Bounded Support and Applications' (World Scientific, 2004. 2004)

**PORTFOLIO CHOICE DECISION MAKING WITH *NBP-EFFSAMWMIX*:  
A STOCHASTIC MULTI-ARMED BANDIT ALGORITHM USING NAÏVE  
BANDIT PORTFOLIO APPROACH**

Villari, Bobby Chaitanya; Abdulla, Mohammed Shahid FPM Student, IT & Systems Area  
Indian Institute of Management Kozhikode Institute of Technology, Kerala, India

**ABSTRACT**

**Portfolio Selection Problem (PSCP) is actively discussed in financial research. The choice of available assets poses the need for exploration and the objective to maximize the portfolio payoffs makes the PCP an explore-exploit decision-making problem. Multi-armed bandit algorithms (MAB) suit well for such problems when applied as the decision engines in Naïve Bandit Portfolio algorithms (NBP). An NBP's performance varies by varying the MAB inside the algorithm. In this work we test a Stochastic Multi-Armed Bandit (SMAB) named *effSAMWMIX*, which we proposed in a previous work of ours, to solve the PCP. We compare the performance of *effSAMWMIX* vis-à-vis KL-UCB, Thompson Sampling algorithm and the benchmark Market Buy & Hold strategy. We tested the algorithms on simulated and real-world market datasets. We report our results where *effSAMWMIX*, applied as the decision-making engine of NBP, has achieved better cumulative wealth for all portfolios when compared to the competing SMAB algorithms.**

*Keywords: Portfolio Selection Problem, Multi-Armed Bandit, Geometric Brownian Motion*

## 1 INTRODUCTION

Decision making under uncertainty has always been a challenge to a decision maker. A Portfolio Selection Problem (PSP) often encounters such uncertainty due to the



changing economic and political environments. The fast proliferation of the information, on Internet-based modern day economies, imposes a need to make a quick decision based on the available but limited information. Many business problems including the Online Portfolio Selection Problem (OPSP) could require simultaneous optimization and the best choice identification. OPSP has been widely discussed in Computational Finance (Borodin and El-Yaniv 2005; Fiat 1998; Li and Hoi 2014; Mohr and Schmidt 2013; Schmidt, Mohr and Kersch 2010).

To solve any PSP, the investor decides on a strategy to allocate the available (finite) wealth among the available choice of assets. Every asset is a diverse investment opportunity and the realization of the asset allocation strategy builds a portfolio. An asset is risky if the prices of the asset are uncertain and such riskiness needs to be incorporated into the portfolio allocation process. The time between any two portfolio allocation decisions is called a period. If there is only one decision during the whole investment period, it is called a Single-Period PSP. A multi-period PSP requires sequential decision-making over the time horizon of investment and thus is proposed as an online decision-making problem. Investor's during the decision making is to optimize an objective decision which could be the Return on Investment (RoI) or Risk of losing wealth (Risk) or a combination of both (Risk & Return). Thus portfolio decision making could also involve the management of Risk and maximize the RoI. The following section briefly discusses the PSP and introduces a Machine Learning (ML) perspective of the OPSP problem.

## **2. OPSP & MACHINE LEARNING ALGORITHMS**

In the academic literature, OPSP is addressed in two ways. The first one considers the risk management into the objective function and thus the performance measure will be quantified by the Cumulative Wealth (CW) achieved or the net risk of the decision with respect to the achievable wealth. Such performance measures are seen from Markowitz's seminal work (Markowitz 1952) and also in Sharpe's work (Sharpe 1966). A few other works followed similar risk management measures

until recently in 2011(Lisi 2011),(Rockafellar and Uryasev 2000).It can be observed that these ideas are characterized by building statistical models of the asset prices in the market. The input to these statistical models requires a forecasting model in some form(DeMiguel, Martín-Utrera and Nogales 2015).The forecasting model, in turn, requires a calibration based on historical data of asset prices(Sharpe 1963) or market capitalization data (Fama and French 1992).

The second way of addressing the OPSP is based on utilizing the modern day computing infrastructure along with intelligent ML techniques that include Neural Networks or Reinforcement Learning Algorithms(Shen, Wang, Jiang and Zha 2015). ML Algorithms are solely based on the empirical observations motivated by dynamic rise and fall of the asset prices. Algorithms (alternatively Strategies) like Follow-the-Winner(Agarwal, Hazan, Kale and Schapire 2006; Li and Hoi 2014), Follow-the-Loser(Li and Hoi 2012) etc. are a couple of those which make use of such dynamic price changes. In brief, an ML Algorithm's approach to OPSP is to concretely explore the available information of past asset prices and based on its indigenous technique, provide a suggestion as to how the portfolio allocation be done for the next period. The algorithm typically intends to maximize the cumulative wealth at the end of the multi-period investment horizon.

To analyze the performance of an OPSP strategy, the algorithm is run on a simulated data such as that obtained by simulating stock prices using Geometric Brownian Motion (GBM)(Marathe and Ryan 2005) and then on real-time market data obtained from standard datasets available from various sources(Bruni, Cesarone, Scozzari and Tardella 2016). It is to be noted that though it is fast to obtain the results by running the algorithm and thus easier to compare the performance with other strategies, the quality of the results heavily depends on the quality of the input data. Hence to avoid the dependency on the same, it is common that the performance of an algorithm is compared to a benchmark algorithm(Mohr, Ahmad and Schmidt 2014) which could be optimal in the hindsight. The Buy-and-Hold(Li and Hoi 2014) could

be one such benchmark algorithm which the performance of an ML based OPSP algorithm is compared with.

This work considers using a Reinforcement Learning algorithm called effSAMWMIX which is a Stochastic Multi-Armed Bandit (SMAB) algorithm. We employ effSAMWMIX to build a Naive Bandit Portfolio (NBP) similar to Shen et.al's work (Shen, Wang, Jiang and Zha 2015) and compare the same with NBPs that implement standard SMABs like UCB (Auer and Ortner 2010), KL-UCB (Garivier and Cappé 2011) and Thompson Sampling (Agrawal and Goyal 2012; Kaufmann, Korda and Munos 2012; Thompson 1933). We compare the performances over a multitude of simulated and benchmark datasets to analyze the results. The following section introduces SMAB and how an NBP is constructed.

### **3. STOCHASTIC MULTI-ARMED BANDITS & NAIVE BANDIT PORTFOLIO ALGORITHM**

An SMAB typically deals with an explore-exploit problem scenario where there are a set of available choices and the decision maker has to decide on only one of the choices can be opted. This is similar to that of a Portfolio Selection problem except that in a typical MAB, the payoffs of the action other than the chosen action in that round remain unknown. But for a PSP, the data is available as the asset prices for the previous time period are known to the decision maker.

#### **A Stochastic Multi-Armed Bandit**

A Multi-Armed Bandit (MAB) problem is a sequential decision-making problem which spans over a horizon of decision-making rounds ( $T$ ). In each round  $t$  the decision maker chooses an action  $a_t$  from among a set of  $K$  action choices that are available and obtains a reward  $r_t^{a_t} \in (0,1)$  for choosing arm  $a_t$  in round  $t$ . The choice is based on an objective function that maximizes the overall reward or cumulative wealth (CW) from the decision making process. Alternatively the objective function could be to minimize the Regret ( $R_t$ ) which is the difference between the highest

possible reward and the CW obtained by the algorithm up to that round of decision making. (Lai and Robbins 1985; Robbins 1985).

Thus, the cumulative reward of a MAB is  $CW = \sum_{t=1}^T E(r_t^{a_t})$  (1)

Let the maximum possible reward be  $v^*$  and hence maximum reward for such an oracle policy is  $T * v^*$ .

Then the regret of the MAB algorithm is given by  $R_T = T v^* - \sum_{t=1}^T E(r_t^{a_t})$  (2)

A general MAB has no restrictions on the reward distribution. But a Stochastic Multi-Armed Bandit (SMAB) problem imposes an assumption that the rewards of each of the available action choices (arms) follow a fixed distribution  $v_i$  on  $[0,1]$  unknown to the SMAB algorithm. Also the reward of each action  $i$  is independent of the rewards it obtained from any other time horizon (or pull) and independent of rewards of other actions (Robbins 1985). This means that the rewards  $\{X_{i,t}\}_{t \in \mathbb{N}}$  are assumed to be independent and identically distributed (i.i.d) from  $v_i$  and all the rewards of  $K$  choices (arms) are also independent of each other. While there are a few other MAB settings like the adversarial MAB (Auer, Cesa-Bianchi, Freund and Schapire 1995) where the environment chooses the rewards so as to minimize the CW, we deal with SMABs with the rewards following the assumption stated above.

### A Naive Bandit Portfolio strategy

A Naive Bandit Portfolio (NBP) implements an SMAB inside as a decision-making engine. The inputs to the SMAB are the time horizon  $T$ , number of available arms  $K$  where each arm represents a portfolio or asset, the time period between the decisions  $\Delta t$  which could be a day for daily returns or a week for weekly returns or month or an year.  $r_t^{a_t}$  is the reward obtained when an asset  $a_t$  is chosen in time period  $t$  and  $CW_t$  is the cumulative wealth obtained until the round  $t$ .

The gross return on  $i^{th}$  asset in round  $t$  is denoted by  $r_t^i$  and is obtained as given below

$$r_t^i = P_{t,i}/P_{t-1,i} \quad (3)$$

where  $P_{t,i}$  is the price of the asset  $i$  at time  $t$ . Thus the returns in round  $t \in (1, T)$  over the time for the portfolio with  $K$  arms can be given as  $\mathbf{R}_t = (r_{t,1}, r_{t,2}, r_{t,3} \dots \dots r_{t,K})^T$ . The portfolio investment decision

over is the determination of the weights proportionate to which each the investment is budgeted over the assets available to the investor. Thus the weights vector at time  $t$  which is represented as

$$\omega_t = (\omega_{t,1}, \omega_{t,2}, \omega_{t,3} \dots \omega_{t,K})^T \quad (4)$$

Thus  $\omega_{t,i}$  which is the invested wealth percentage on the  $i^{th}$  asset in round  $t$  is determined by the SMAB algorithm.

$$\sum_{i=1}^K \omega_{t,i} = 1 \quad (5)$$

Also for an SMAB to operate,  $r_t^i \in (0,1)$  which means that the rewards are to be normalized and then given as the input to the algorithm. This is a critical condition to be imposed on the dataset in order to use any SMAB on an OPSP. Another critical aspect is the introduction of a parameter  $\tau$  indicating the rolling-horizon settings (Shen, Wang and Ma 2014), which is the number of periods of data prior to the current decision making period, the algorithm should consider while calculating the necessary input parameters like the mean return, standard deviation and the Sharpe ratios ( $SR$ ). Thus for an NBP, the return for an asset  $i$  in round  $t$  is given as  $r_t^i = SR_t^i$  (6)

Where 
$$SR_t^i = \left( \frac{\mu_t^i}{\sigma_t^i} \right)_{\tau} \quad (7)$$

The  $\tau$  denotes the rolling-horizon time period. For example,  $\tau = 120$  indicates that the mean ( $\mu$ ) and standard deviations ( $\sigma$ ) of the past 120 time periods is taken in to consideration for calculating  $SR_t^i$ . Then to get the  $SR_t^i \in [0,1]$  normalize the  $SR_t^i$  for based on data for every asset  $i$  in period  $t$ .

$$nSR_t^i = \frac{SR_t^i - \min(SR_t^{(i=1 \text{ to } K)})}{\max(SR_t^{(i=1 \text{ to } K)}) - \min(SR_t^{(i=1 \text{ to } K)})} \quad (8)$$

The Naive Bandit Portfolio algorithm's pseudocode is put below.

**Inputs** :  $K$  (assets),  $T$  (time horizon),  $\Delta t$ ,  $\mathbf{R}_t$ ,  $\tau$

**for**  $i = 1$  to  $(T - \tau)$  **do**

Step-1: Estimate the average return  $\mu_t^i = E(R_t)$  based on previous  $\tau$  periods

Step-2: Estimate the standard deviation  $\sigma_t^i = \sqrt{\lambda_t^i}$  where

$\lambda_t^i$  is the variance of asset  $i$ 's returns for the past  $\tau$  periods

Step-3: Using (7) Calculate the  $SR_t^i$  matrix for every asset for rounds  $t = \tau$  to  $T$ .

Step-4: Using (8) Normalize the  $SR_t^i$  matrix so that every  $nSR_t^i \in [0,1]$  for round  $t = \tau$  to  $T$ . This  $nSR_t^i$  is the adjusted Reward function

Step-5: Provide  $nSR_t^i$  as the input for the SMAB algorithm

which could be UCB1, KL – UCB, Thompson Sampling or effSAMWMIX

Figure 1: A Naive Bandit Portfolio (NBP) algorithm

From the Step 5 of NBP algorithm (Figure 1), it is seen that an SMAB is implemented to compute the weights vector for any round  $\epsilon [1, T - \tau]$ . Current work compares the performance of the proposed effSAMWMIX SMAB with UCB1, KL-UCB and, Thompson Sampling (TS) algorithms. The functioning of each of these algorithms is put below.

### The UCB1 algorithm

UCB1 is among those first generation algorithms that update and consider both exploration and exploitation components in a same surrogate UCB parameter (Auer, Cesa-Bianchi and Fischer 2002). Consider the following UCB1 parameter to be updated in every iteration for every arm  $ucb_t^i = \max\left(\bar{x}_t^i + \sqrt{\frac{2\ln(t)}{n_i}}\right)$  where  $\bar{x}_t^i$  is the empirical mean of observed reward of arm  $i$  until round  $t$  and  $n_i$  is the total number of times arm  $i$  is played until round  $t$ . This UCB estimate is similar to  $ucb_i = \operatorname{argmax}(\bar{\mu}_i) + \mathcal{P}_i$  for any round  $i$ . While  $\operatorname{argmax}(\bar{\mu}_i) = \max(\bar{x}_t^k)$  is the exploitation component,  $\mathcal{P}_i = \sqrt{\frac{2\ln(k)}{n_i}}$  is the exploration bonus. Thus the optimistic guess parameter will get updated simultaneously with knowledge related to both exploration and exploitation. The UCB1 algorithm can be written as follows

Initialization : Play (execute) each arm once and obtain rewards  $x_i$

Further , play the arm that satisfies  $\operatorname{argmax}\left(\bar{x}_t^i + \sqrt{\frac{2\ln(t)}{n_i}}\right)$  in that round

$n_i$  is number of times that particular arm is played so far

$t$  is the current round

$\bar{x}_t^i$  is the average reward for arm  $i$  at round  $t$

Figure 2:UCB1 algorithm

### The KL-UCB algorithm

KL stands for Kullback-Leibler divergence and KL-UCB (Garivier and Cappé 2011) differs from UCB1 in the padding function  $\mathcal{P}_i$  which is derived by employing KL divergence. The authors reported improved regret bounds for KL-UCB where  $\mathcal{P}_i$  incorporates the distance between estimated reward distributions for the arms when calculating the UCB parameter. The algorithm is put below.

Initialization : Play (execute) each arm once and obtain rewards  $x_i$

Further , play the arm that satisfies  $\operatorname{argmax}_i(n_i \cdot d(\mu_i, M)) \leq \log t + c \log \log t$  in that round

$n_i$  is number of times that particular arm is played so far

$i$  is the arm

$$d(\mu_i, M) = \mu_i \log\left(\frac{\mu_i}{M}\right) + (1 - \mu_i) \log\left(\frac{1 - \mu_i}{1 - M}\right)$$

Figure 3: KL-UCB algorithm

### The Thompson Sampling algorithm

Thompson Sampling (TS) heuristic was proposed by Thompson (Thompson 1933) in 1933 but remained less popular compared to other MAB algorithms for the lack of proofs on the regret bounds which were given very recently (Agrawal and Goyal 2012). Also, the proof for logarithmic regret to

Thompson sampling has come only recently (Kaufmann, Korda and Munos 2012). It can also be argued that TS cannot be ignored for the lack of proofs on the regret for its empirical performance (in simulated environments) outperformed a few well known MAB algorithms for example UCB. Hence this work considers TS as a competent algorithm to compare with the effSAMWMIX. The TS algorithm is given below

Initialization:

Set  $\alpha, \beta$  which are the prior parameters for Beta distribution

Set  $S_i = 0, F_i = 0 \forall_i$  where  $S_i$  is success counter and  $F_i$  is Failure counter

Loop: For every round  $t = 1, \dots, T$  do

For every arm  $k = 1, \dots, K$  do

Draw  $\theta_i$  according to  $Beta(S_i + \alpha, F_i + \beta)$

Draw an arm  $i = \text{argmax}_i \theta_i$  and observe the reward  $r$

If  $r = 1$  then  $S_i = S_i + 1$

Else  $F_i = F_i + 1$

Figure 4: Thompson sampling algorithm

The effSAMWMIX algorithm

effSAMWMIX is based on SAMWMIX (Abdulla and Bhatnagar 2016). It differs from upper confidence bound like algorithms since it avoids searching for a maximum of a resulting parameter. Instead, it picks a 'soft-maximum' using a Boltzmann Exploration structure. It calculates a probability vector  $\phi_k$  over the set of  $K$  arms. This  $\phi_k$  is iteratively updated to obtain a  $\phi^*$  which associates maximum probability of 1 to the best arm  $a^*$  and 0 to the rest of the arms. The equation for  $\phi$  is put below

$$\phi_{t+1}^j = (1 - \gamma_t) \frac{e^{\sum \eta_t x_t^j}}{\sum_{j=1}^N e^{\sum \eta_t x_t^j}} + \frac{\gamma_t}{N} \quad (9)$$

Where  $\eta_t$  is similar to that of SAMWMIX except that it is parameterized by a  $d_k$  which is obtained by the utilization of a heuristic. Equation (9), put above, is the same as that of equation (10) in SAMWMIX's original proposition. effSAMWMIX obtains the superiority on how the learning parameter  $\gamma_t$  is calculated as put below.

$$\gamma_k = \frac{N(4+(d+d_k))}{k(d+d_k)^2 - (d+d_k - 2d^2)} \quad (10)$$

Further, the parameter  $d_k$  is obtained by using a heuristic to quickly converge without requiring a closed form of an equation. The effSAMWMIX algorithm is put below.

Input : Rewards Vector  $G_t$ , set of Arms  $N$ , number of rounds  $T$

Using  $G_t$  Calculate  $d = \min \Delta(\mu_1, \mu_2, \dots, \mu_N)$  where  $\mu_i$  is the reward mean of Arm  $i$ .

Calculate

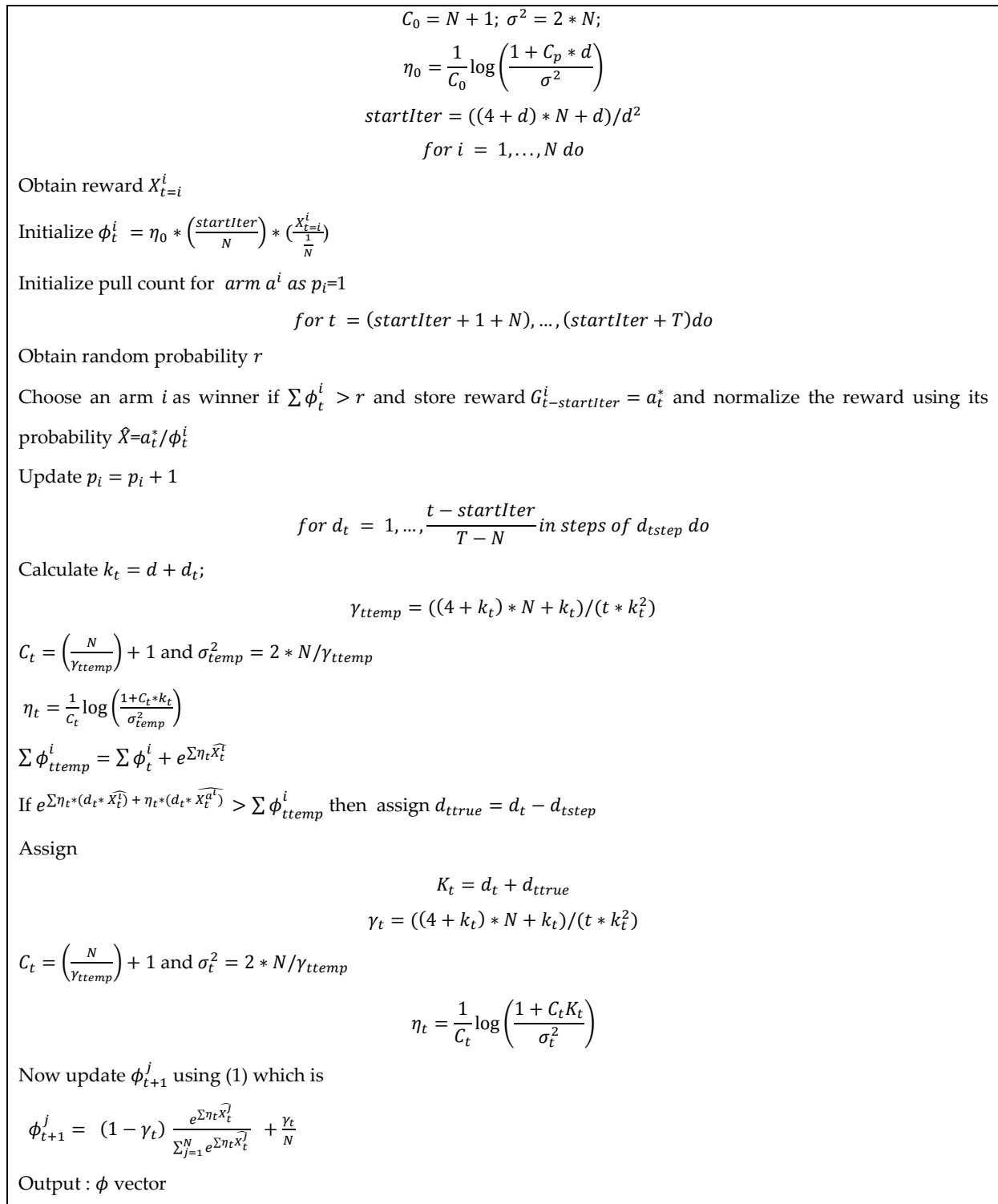

Figure 5: effSAWMIX algorithm

The performance of the four algorithms in the current context are compared against simulated GBM portfolios and real-world benchmark datasets as explained in the following sections.

#### 4. EXPERIMENTS



Experiments are conducted on both simulated datasets and real-world datasets. The simulated datasets are obtained by using Geometric Brownian Motion prediction techniques as explained below

### Stock prediction on Simulated Geometric Brownian Motion Datasets

Geometric Brownian Motion (GBM) is also known as Wiener Process in which the logarithm of a quantity that varies at random will follow a Brownian Motion (Wilmott 2000). GBM is formally a mathematical modeling technique that is often used to predict the short-term stock price movement (Ladde and Wu 2009). Since the stock price movement is often unpredictable the GBM's random walk model tends to predict the stock prices with reasonable accuracy (Fama 1995). This work considers the GBM technique to build a synthetic dataset to test the performance of the NBP algorithm that utilizes effSAMWMIX, UCB1, KL-UCB and TS as the SMAB engine for the NBP. The GBM dataset is generated using the daily closing prices which are the input for the GBM model. The returns are calculated for each asset using the following equation

$$R_i = \left( \frac{P_{i+1} - P_i}{P_i} \right) \quad (11)$$

Where  $P_i$  is the closing price of the asset on day  $i$ . If  $T$  is the total number of periods where the returns are calculated then the mean return  $\mu$  is calculated as follows

$$\mu = \frac{1}{T} \sum_{i=1}^T R_i \quad (12)$$

Also the standard deviation of all the returns  $\sigma$  is calculated as

$$\sigma = \sqrt{\frac{1}{T-1} \sum_{i=1}^T (R_i - \mu)^2} \quad (13)$$

If the price of stock at time  $t$  is  $S(t)$  and a random value generated at that time is denoted by  $X(t)$  then the  $S(t)$  is calculated using GBM as follows.

$$S(t) = S(0) * e^{[\mu - 0.5\sigma^2]t - \sigma[X(t) - X(0)]} \quad (14)$$

### Experimental Settings & Simulation results

From the S&P 500 Stock dataset (Bruni, Cesarone, Scozzari and Tardella 2016) we have randomly picked  $n$  stocks from the same so that the SMABs will have  $n$  choices (arms) to choose from. Each of the stocks have the periodic closing prices from November 2004 to April 2016. The  $\mu$  &  $\sigma$  are calculated for each of the  $n$  stocks and a new set of closing prices are predicted using GBM prediction equation (14). This newly generated stock price closing data will now be the dataset on which the NBP's performance is evaluated when the NBP uses a different SMAB for decision making process. The

naming convention for the GBM simulated portfolio dataset with 5 assets  $n = 5$  is GBM05 and that with 15 assets  $n = 15$  is GBM15. The results of the experiments on GBM05 and GBM15 datasets are put below. Also effSAMWMIX employed inside NBP is henceforth addressed as NBP-effSAMWMIX. Similarly, NBP-UCB1 indicates that UCB1 is employed inside NBP. The other two algorithms are denoted as NBP-KLUCB and NBP-TS where KL-UCB and TS are employed inside NBP respectively.

Table 1: Terminal Cumulative Wealth on GBM Datasets.

GBM Dataset	Cumulative Wealth(\$)				
	Market B&H Strategy	NBP-UCB1	NBP-KLUCB	NBP-TS	NBP-effSAMWMIX
GBM05	1.1735	1.3789	0.8623	1.5166	1.6213
GBM15	1.2881	1.4024	1.5597	1.7045	1.7867

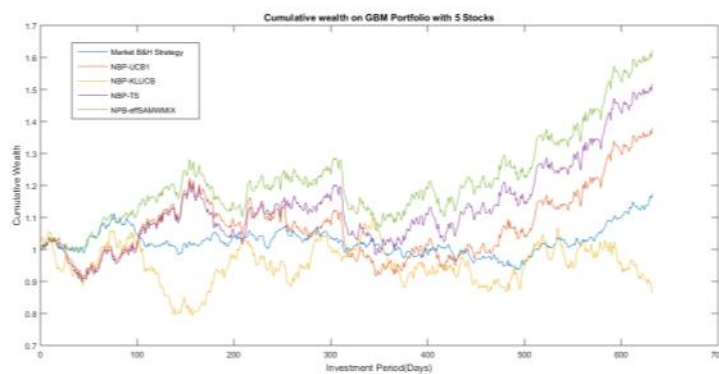

Figure 6: Cumulative wealth curves across the investment periods on GBM05 dataset

NBP-effSAMWMIX performed better than when NBP-UCB1, NBP-KLUCB, NBP-TS. Also, NBP-effSAMWMIX has acquired a better CW than the Market Buy & Hold Strategy(Li and Hoi 2014). Results are similarly favorable for NBP-effSAMWMIX when simulated portfolio consisted of 15 assets (see Fig.7.). The terminal cumulative wealth acquired per a unit investment is shown in Table 1.

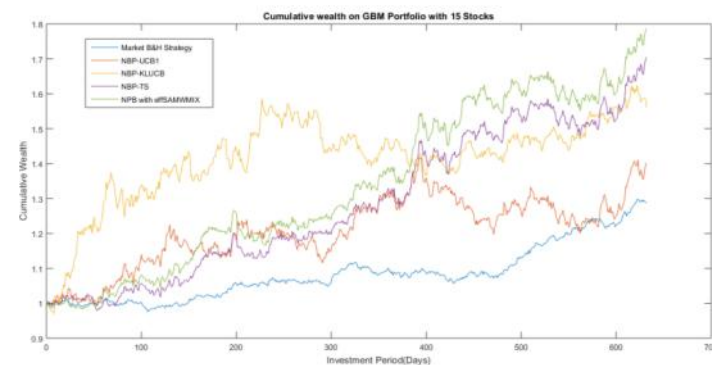

Figure 7: Cumulative wealth curves across the investment periods on the GBM15 dataset.

**Stock prediction on real-world benchmark datasets**

We choose benchmark datasets from (Bruni, Cesarone, Scozzari and Tardella 2016) and (Li, Sahoo and Hoi 2016) where the datasets are validated for the comparative performance of portfolio selection models. These datasets are generated using real-world price values obtained from major stock markets. They are reported to contain error-free cleaned data of weekly return values which are adjusted for dividends and stock splits. These publicly available datasets help in an unbiased comparison of the different NBP-SMAB portfolio selection strategies that are tested in this work. We chose these datasets to get a variety of data in terms of region, market type, the number of assets and the number of periods. For example, MSCI measures the equity market performance of global emerging markets and DJIA gives the stock market data from the USA which is a developed economy. Table 2. provides the details of the datasets under consideration for this work.

Table 2: Summary of the four benchmark datasets from real markets.

Dataset	Market	Region	Time Frame	# Periods	# Assets	Reference
DJIA	Stock	USA	01/14/2001 - 01/14/2003	507	30	(Li, Sahoo and Hoi 2016)
TSE	Stock	CANADA	01/04/1994 - 12/31/1998	1259	88	(Li, Sahoo and Hoi 2016)
NASDAQ100	Stock	USA	06/2002 - 04/2016(weekly)	596	82	(Bruni, Cesarone, Scozzari and Tardella 2016)
MSCI	Index	Global	01/14/2001 - 01/14/2003	507	30	(Li, Sahoo and Hoi 2016)

We report (Table 3.) the terminal cumulative wealth achieved by each of these algorithms over the four benchmark datasets mentioned above. Apparently, NBP-effSAMWMIX has achieved the highest cumulative wealth when compared to other NBP algorithms. Except in the case of NASDAQ100 dataset, NBP-effSAMWMIX has performed better than the Market Buy & Hold strategy as well.

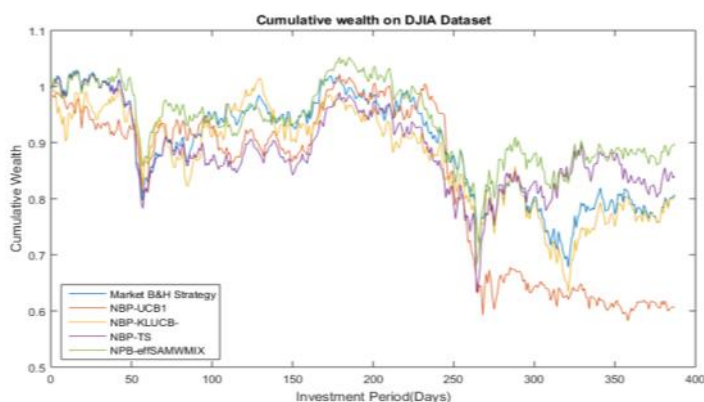

Figure 8: Cumulative wealth curves across the investment periods on DJIA dataset.

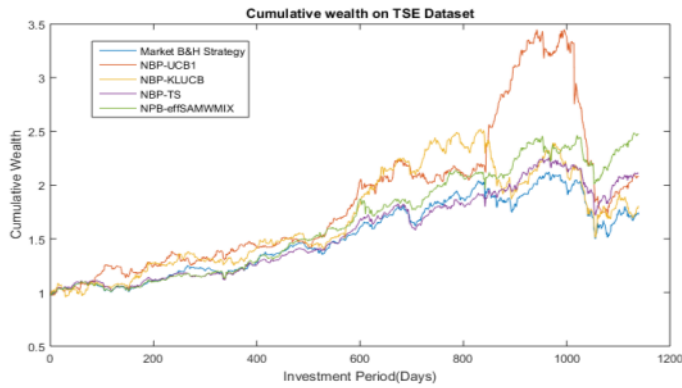

Figure 9: Cumulative wealth curves across the investment periods on TSE dataset.

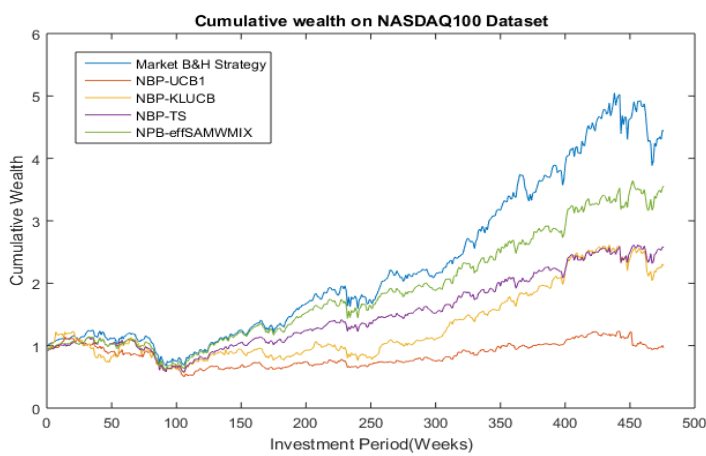

Figure 10: Cumulative wealth curves across the investment periods on NASDAQ100 dataset.

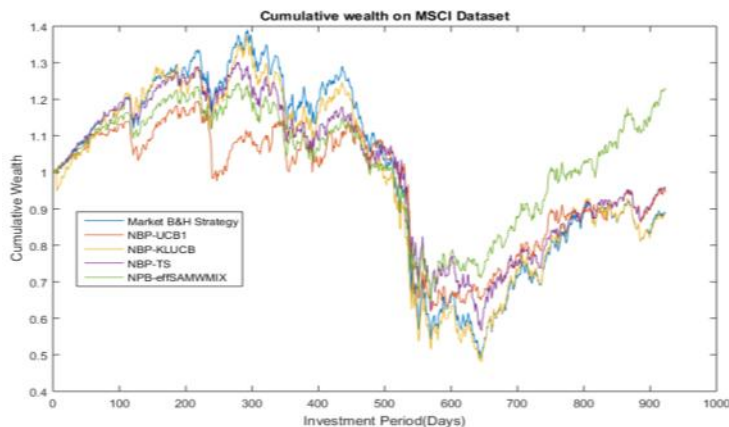

Figure 11: Cumulative wealth curves across the investment periods on MSCI dataset.

Figures 8-11 show the time series curves of the CW achieved over the investment periods. NBP-effSAMWMIX has performed comparatively with NBP-TS on DJIA and TSE datasets but has a distinguishably better performance on MSCI dataset. On the NASDAQ100 dataset, the Market Buy & Hold strategy is a clear winner from the early investment periods and none of the NBP algorithms

could match its performance. Except for this one case, NBP-effSAMWMIX achieved the highest wealth level in all the datasets including the simulated GBM datasets.

Table 3: Terminal Cumulative Wealth on Benchmark Datasets.

	Cumulative Wealth (\$)					
	Market Strategy	B&H	NBP-UCB1	NBP-KLUCB	NBP-TS	NPB-effSAMWMIX
DJIA	0.8072		0.6075	0.8049	0.8409	0.8989
TSE	1.7444		2.0738	1.8071	2.1057	2.4685
NASDAQ100	4.4363		0.9646	2.2802	2.5782	3.5590
MSCI	0.8907		0.9456	0.8865	0.95573	1.2263

## 5. CONCLUSION

In this work, we report the implementation of the effSAMWMIX inside of a Naive Bandit Portfolio algorithm. effSAMWMIX which has a regret of  $O(\log T)$ , where  $T$  is the number of iterations (Boby, 2016 #179), is shown to perform better than KL-UCB and Thompson Sampling on a few popular reward distributions. This work intends to exploit this advantage (of effSAMWMIX's performance) over competing SMAB algorithms reported in the literature. Along with NBP-effSAMWMIX, the NBP versions of KL-UCB and Thompson Sampling are evaluated for the first time in literature. We report the cumulative wealth data on both simulated and benchmark real-world datasets so as to concretely report the empirical performance of the proposed algorithm. The performance on NASDAQ100 dataset opens up the need to further assess the dataset so as to analyze why none of the NBP algorithms could beat the Market Buy & Hold strategy while they could in the rest of the cases. This could be because NBP does not consider asset correlations while making the decision. To further this work, we intend to do an Orthogonalization of the portfolios in order to remove the correlation and evaluate the performance of effSAMWMIX in such a scenario.

## REFERENCES

- Abdulla, Mohammed Shahid, and Shalabh Bhatnagar, 2016. Multi-armed bandits based on a variant of Simulated Annealing, *Indian Journal of Pure and Applied Mathematics* 47, 195-212.
- Agarwal, Amit, Elad Hazan, Satyen Kale, and Robert E Schapire, 2006. Algorithms for portfolio management based on the newton method(ACM).
- Agrawal, Shipra, and Navin Goyal, 2012. Analysis of Thompson Sampling for the Multi-armed Bandit Problem.
- Auer, Peter, Nicolo Cesa-Bianchi, and Paul Fischer, 2002. Finite-time analysis of the multiarmed bandit problem, *Machine Learning* 47, 235-256.
- Auer, Peter, Nicolo Cesa-Bianchi, Yoav Freund, and Robert E Schapire, 1995. Gambling in a rigged casino: The adversarial multi-armed bandit problem(IEEE).
- Auer, Peter, and Ronald Ortner, 2010. UCB revisited: Improved regret bounds for the stochastic multi-armed bandit problem, *Periodica Mathematica Hungarica* 61, 55-65.
- Borodin, Allan, and Ran El-Yaniv, 2005. Online computation and competitive analysis(cambridge university press).

- Bruni, Renato, Francesco Cesarone, Andrea Scozzari, and Fabio Tardella, 2016. Real-world datasets for portfolio selection and solutions of some stochastic dominance portfolio models, *Data in Brief* 8, 858-862.
- DeMiguel, Victor, Alberto Martín-Utrera, and Francisco J Nogales, 2015. Parameter uncertainty in multiperiod portfolio optimization with transaction costs, *Journal of Financial and Quantitative Analysis* 50, 1443-1471.
- Fama, Eugene F, 1995. Random walks in stock market prices, *Financial Analysts Journal* 51, 75-80.
- Fama, Eugene F, and Kenneth R French, 1992. The cross-section of expected stock returns, *The Journal of finance* 47, 427-465.
- Fiat, Amos, 1998. *Online Algorithms: The State of the Art* (Lecture Notes in Computer Science).
- Garivier, Aurélien, and Olivier Cappé, 2011. *The KL-UCB Algorithm for Bounded Stochastic Bandits and Beyond*.
- Kaufmann, Emilie, Nathaniel Korda, and Rémi Munos, 2012. *Thompson sampling: An asymptotically optimal finite-time analysis*(Springer).
- Ladde, GS, and Ling Wu, 2009. Development of modified geometric Brownian motion models by using stock price data and basic statistics, *Nonlinear Analysis: Theory, Methods & Applications* 71, e1203-e1208.
- Lai, Tze Leung, and Herbert Robbins, 1985. Asymptotically efficient adaptive allocation rules, *Advances in applied mathematics* 6, 4-22.
- Li, Bin, and Steven CH Hoi, 2012. On-line portfolio selection with moving average reversion, arXiv preprint arXiv:1206.4626.
- Li, Bin, and Steven CH Hoi, 2014. Online portfolio selection: A survey, *ACM Computing Surveys (CSUR)* 46, 35.
- Li, Bin, Doyen Sahoo, and Steven CH Hoi, 2016. OLPS: a toolbox for on-line portfolio selection, *Journal of Machine Learning Research* 17, 1-5.
- Lisi, Francesco, 2011. Dicing with the market: randomized procedures for evaluation of mutual funds, *Quantitative Finance* 11, 163-172.
- Marathe, Rahul R, and Sarah M Ryan, 2005. On the validity of the geometric Brownian motion assumption, *The Engineering Economist* 50, 159-192.
- Markowitz, Harry, 1952. Portfolio selection, *The Journal of finance* 7, 77-91.
- Mohr, Esther, Iftikhar Ahmad, and Günter Schmidt, 2014. Online algorithms for conversion problems: a survey, *Surveys in Operations Research and Management Science* 19, 87-104.
- Mohr, Esther, and Günter Schmidt, 2013. How much is it worth to know the future in online conversion problems?, *Discrete Applied Mathematics* 161, 1546-1555.
- Robbins, Herbert, 1985. *Some aspects of the sequential design of experiments*(Springer).
- Rockafellar, R Tyrrell, and Stanislav Uryasev, 2000. Optimization of conditional value-at-risk, *Journal of risk* 2, 21-42.
- Schmidt, Günter, Esther Mohr, and Mike Kersch, 2010. Experimental analysis of an online trading algorithm, *Electronic Notes in Discrete Mathematics* 36, 519-526.
- Sharpe, William F, 1963. A simplified model for portfolio analysis, *Management science* 9, 277-293.
- Sharpe, William F, 1966. Mutual fund performance, *The Journal of Business* 39, 119-138.
- Shen, Weiwei, Jun Wang, Yu-Gang Jiang, and Hongyuan Zha, 2015. *Portfolio choices with orthogonal bandit learning*(AAAI Press).
- Shen, Weiwei, Jun Wang, and Shiqian Ma, 2014. *Doubly Regularized Portfolio with Risk Minimization*.
- Thompson, William R, 1933. On the likelihood that one unknown probability exceeds another in view of the evidence of two samples, *Biometrika* 25, 285-294.
- Wilmott, P, 2000. *Quantitative Finance (vols. I and II)*(Wiley, Chichester, West Sussex, England).

## WHAT COMES FIRST, THE CHICKEN OR THE EGG: THE UNDERPINNING TECHNOLOGY OR BUSINESS MODEL?

Vinaik, Rubal; Zubac, Angelina

Strategy Link  
Central Queensland University

### ABSTRACT

This conceptual paper uses the extant technology and innovation management, strategic management, and strategic entrepreneurship literatures to derive a modification of the Itami and Nishino (2010) systems-based business model framework. Its objective is to provide insight at a firm level into how business model and technology change occurs as part of the global business ecosystem through learning at the firm level. It explicates how this learning is affected by four inter- and intra-firm effects, including those emanating from the global business ecosystem, as well as the rate of innovation learning across multiple levels. The paper argues that the question of what comes first, the underpinning business model or technology depends on what was learned about the firm's (potential) place within the global business ecosystem, how this knowledge is used and the innovation life-cycle. This points to why some firms fall out of the global business ecosystem, changing its diversity mix. We conclude with a discussion of some of the paper's more powerful implications for research and practice.

*Keywords: business model; innovation; innovation system learning; technology trajectory; profit model; business system; business ecosystem; capabilities, business model life-cycle*

### INTRODUCTION

In the first part of the paper, the following extant literatures are briefly summarized and their key points highlighted: the business models, technology trajectories, technology disruption, value chain convergence, market convergence/disruption, hyper-competition, partnering and networks, and knowledge and big data literatures. In the next section, we describe Itami and Nishino's (2010) business model framework. We also derive our modified version of it using key principles from the theories highlighted in the literature review. In the following section, we go into more detail about the components of the innovation systems used by individual firms, concluding that the way in which they evolve depends on how managers access and assess endogenous and exogenous forms of knowledge, that is, that knowledge that informs the business model design and technologies of the

firm over time. In the last section, we conclude that though the business model literature and the technology change literature variously alternate between arguing that technologies are underpinned by business models and evolve accordingly while business models are underpinned by technology change and evolve accordingly, which is analogous to the chicken and egg problem, what comes first is not clear-cut; it all depends on what there is to learn from the global business ecosystem, the firm's ability to engage with it and the capacity to learn at the firm. It was also concluded that the rate of innovation that occurs within and outside of the firm's boundaries is the result of continuous learning, and those firms that cannot learn effectively and implement the 'right' learnings drop out of the global business ecosystem. This has a number of implications, including the fact that business model and technology decisions involve learnings from multiple levels over time.

## LITERATURE REVIEW

The business model literature is a relatively new literature (Demil & Lecocq, 2010). This literature can be split into three broad categories of research: the static view, which involves understanding different taxonomies and typologies of business models, and also how business models are defined in practice and theory; the dynamic and/or longitudinal view of business models, which involves understanding the impact of learning and the strategies learning stimulates about business models; and a systems or boundary-delineating view of business models, which involves understanding the linkages between the global business ecosystem and its business model related subsystems.

In the static view, business models have been variously defined but mostly in systems terms where the system's objective is to create customer value using firm resources and, in turn, creates (non-)monetary forms of value for the firm (Baden-Fuller & Haefliger, 2013). In the dynamic and/or longitudinal view, the way in which the different components of business models are made to function is what gives business models their power over time, including the ability to create new versions of products or innovate them within a given set of strategic and operational constraints, that is, while using the recipe analogy, as they relate to the dish to be served up to customers (Baden-Fuller & Morgan, 2010). In a system or boundary view, business models are usually conceptualized in activity terms. This is particularly useful when understanding the business model as a vehicle for understanding how the full spectrum of activities undertaken at the firm should tie in with the pertinent activities of the global business ecosystem (Zott & Amit, 2010).

In summary, "business model choice determines the nature of complementarity between business models and technology and the paths to monetization. A poor choice can lead to low profits, a good choice to superior profits" (Baden-Fuller & Haefliger, 2013: 422).



Research on technology trajectories has been manifold. A large amount of this research has focused on the way in which technology development occurs within the firm but also how the firm is impacted by technology developed from without its boundaries. The consensus is that technology development occurring within the firm and as an outcome of the global business ecosystem involves two-way knowledge flows. Dosi (1982: 147) associates technology trajectories with the notion of a technology paradigm, since one cannot explain technology change fully without making this association.

Following on from the previous section on technology trajectories, technology trajectories can be defined in two ways according to the intensity and the nature of the change in technology involved, that is as *sustaining* or *disruptive*. (Christensen & Bower, 1996).

There are a number of drivers that contribute to convergence of value chains in the global business ecosystem. These include the emergence of common and dominant platforms (Pfaffman & Stephan, 2001), the reality that global efficiency is a function of national competitive advantage (Porter, 1990), and the strategic responses that occur within the domain of the firm when market/industry convergence is evident (Wirz, 2001).

When managers (everywhere) strategize they now have to consider the consequences of national competitive advantages becoming more marked. Sometimes this leads to the decision to relocate to another country or invest in a greenfield venture or acquire another firm to ensure the firm has a presence in a country that is strategically important, including the ability to gain access to a complementary or strategic technology rapidly (Pfaffmann & Stephan, 2001).

Likewise, markets have also been disrupted and forced to converge because firms everywhere are more able to than ever before pursue cost innovation strategies. In the last decades, the Internet and the demand for digital products and services it has stimulated has intensified the rate of change in global markets. The Internet has changed the way business is conducted forever. There is increased demand and supply of new digital forms of content, e-commerce platforms, streamlined and simple digital services and connectivity. Markets continue to disintermediate too as a result of the flexibility the Internet has provided firms of all sizes (Wirze, Schilke & Ullrich, 2010). In addition to the digitalization of world markets, intelligent network structures and the convergence of media structures have led to profound change. Firms have adopted common platforms as a result of the ready availability of these technologies, regulations and customers expecting firms to use common platforms (Wirz, 2001).

In the past, managers assumed it was possible to sustain a competitive advantage once the firm had achieved market dominance. However, globalization, the widespread adoption of proven business methods, continual innovation in technology, and new concepts in information technology have

created a situation where the old model of management, once an advantage was achieved, is no longer relevant (D'Aveni & Gunther, 1994). A series of temporary advantages essentially is a proxy for a sustainable competitive advantage in this modern era (D'Aveni, Dagnino & Smith, 2010). This means that managers must invest in their firm's resource base knowing that transient advantages via "disruptive strategic moves" may in the long-run be all that is possible to achieve (Thomas & D'Aveni, 2009:415). In addition to the abovementioned forces, hypercompetition has also been caused by deregulation across sectors (Wirz, 2001).

Globalization has led to the acceptance that business can rarely take place without some partnering and networking. This is reflected in the strategic partnering/network literatures, which confirms firms need to eschew the parochial, particularly in regard to how they configure their value chain with global partners. All kinds of partnering and network arrangements have been studied in the partnering and network literatures. Strategic alliances and constellations are undertaken to give the firm prominence and give it access to diverse forms of information, particularly information that is entrepreneurial (Koka & Prescott, 2008).

In recent times, 'big data' has emerged as another important way in which firms can benefit, from possessing and utilizing performance differentiating forms of knowledge. Big data in general terms is "large and varied data that can be collected and managed" (George, Osinga, Lavie & Scott, 2016: 1493).

#### *Summary of the literature review*

The literature review confirms Dosi's (1982: 158) view that "the establishment of a defined technological paradigm is likely to be paralleled by a process of 'internalization' within companies of the so-called 'externalities' related to the innovative activity, capitalizing on the previous experience of attempts, successes and failures, etc.: within an established technological paradigm the fluid market structure characterized by the 'heroic entrepreneurship' often described in the literature on new industries is likely to disappear."

Likewise, it confirms that business models are highly manipulable but also that "the typical assumption that a radically improved product or service offering will, over time, automatically lead to increased profits for the innovating firm(s) ignores the enormous problems that firms face in working out the interdependencies between business model choice and technology effectiveness." The choice of business model cannot be made without clarifying what might be commercially viable as part of a global business ecosystem, as well as the technologies that the firm should invest in to create customer value. Thus, business models mediate the link between technology and firm performance. Developing

the right technology is a business model decision regarding openness and user engagement (Baden-Fuller & Haefliger, 2013: 419, 422).

## ITAMI AND NISHINO'S (2010) BUSINESS MODEL FRAMEWORK: THE BASIC MODEL AND OUR MODIFIED VERSION

In this section, we discuss and build upon Itami and Nishino's (2010: 364) business model framework, which is systems based. Itami and Nishino (2010: 364) define a business model as composing two elements: "a business system and a profit model. A profit model "is a pattern of the firm's intention about how it will make a profit in its given business." It summarizes the way in which the firm will achieve its financial goals and differentiate itself from its competitors. A business system, on the other hand, is the "system of works" that the firm uses to deliver value to its target customers through its products and services. While the latter often gains the higher profile, the former is arguably the real 'meat' of a firm's business model. Not only does it act as the 'system of works' that actually produces and delivers the firm's products or services, it is also the locus where a firm can learn about its operations and the behaviors of its suppliers and customers." Because the Itami and Nishino framework incorporates learning, it too suggests that managers will move from one mental frame to another of what the business model should constitute, that is, what it is at the current time and should be in the future as determined by the strategy and the dynamic capabilities<sup>3</sup> required to realize it. Although it is acknowledged that not all firms have strategies though they will all have a business model (DaSilva & Trkman, 2014).

In Itami and Nishino's framework the learning system of the organization is a sub-system of the business system, as is the delivery system, as shown in **Figure 1**. The learning system is the means by which the business system can be rationalised. Its focus is the longer term strategic use of knowledge. It is that part of the business system that renders the business system more than just a delivery system.

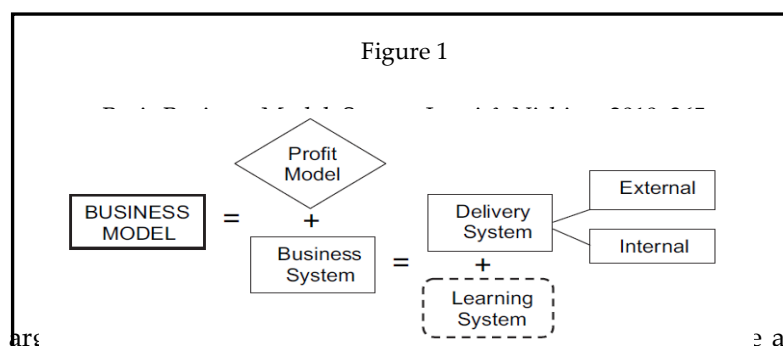

Itami and Nishino argue that the business system is where learning takes place and accumulation and development of core invisible assets. This is because the business system is where learning takes place about the firm's delivery system, which is a system that gathers data from within the firm itself and from outside of its boundaries. They are referring to the whole value chain system the firm uses and

engages here. In Itami and Nishino's framework the firm's core invisible assets are continually in a state of change as a result of the learning that originates from the business system. (It is clearly taken as a given in their article that core invisible assets are dynamic capabilities; dynamic capabilities make it possible for firms to keep pace with changes in markets and they derive their power from the knowledge they represent.)

The business system in broad terms is comprised of: "(1) the division of labor between the firm and its trading partners (typically a decision between outsourcing and internal procurement) (2) internally, how should the firm organize its in-house working system and (3) externally, how it should control the activities of its trading partners" (Itami & Nishino, 2010: 365-366). As indicated, Itami and Nishino apply value chain logic. They also explicate the learning system that must underpin it for the firm to be effective and, critically, innovative in the longer-term. In other words, the business system is more than just about operational activities; it is about value creation, value appropriation and learning. The firm benefits the most from its learning system if it ensures it uses its learning to build its core invisible asset base. See **Figure 2**.

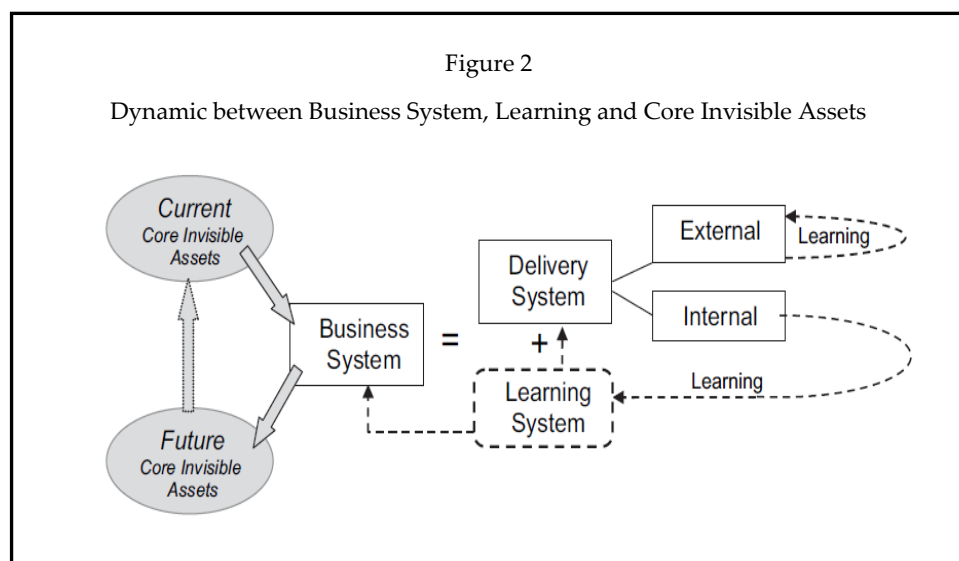

Notwithstanding the power of the Itami and Nishino framework, we believe that the framework could be enriched by considering four learning-based inter- and intra-firm effects, including those emanating from the global business ecosystem:

1. Innovation outcomes toward global business ecosystem efficiency;
2. Innovation diversity determinants (within and outside firm);
3. Knowledge asymmetries and the big data phenomenon; and
4. The innovation system.

These are discussed below and their relationships illustrated in **Figure 3**.

1. *Innovation outcomes toward global business ecosystem efficiency*

Global and national business theories and practice:  
bridging the past with the future

ISSN: 2547-8516  
ISBN: 978-9963-711-56-7

The literature review highlighted the fact that the business model literature has approached the problem of explaining and defining business models from three perspectives: the static, dynamic or longitudinal, and systems view. The literature review also confirmed that when talking about business models but also technology change, trajectories of technology innovation, etc. there is necessarily a two-way flow of knowledge between the firm and the global business ecosystem. Disruptive technology change will disrupt the existing business models in the global business ecosystem, which means that individual firms that do not ride the wave of change do not survive.

This is illustrated in **Figure 3** which shows that at a global level managers must pay attention to the knowledge flows coming from the global business ecosystem. **Figure 3** suggests change is a two-way process when it comes to technology and business model change.

2. Innovation diversity determinants (within and outside firm)

In the literature review it was determined that the rate of innovation is captured by the S-curve, and this explains the rate by which technology is able to be used and its life-cycle prior to any significant structural breaks, indicating technology disruption (Christensen & Bower, 1996). In terms of sustaining and disruptive change, when this occurs this means the S-curve that was relevant is no longer the source of value creation. It is this event that makes it necessary for firms, in the focal ecosystem to change (business model and/or technology). Those firms that cannot change will not survive or will evolve into something entirely different.

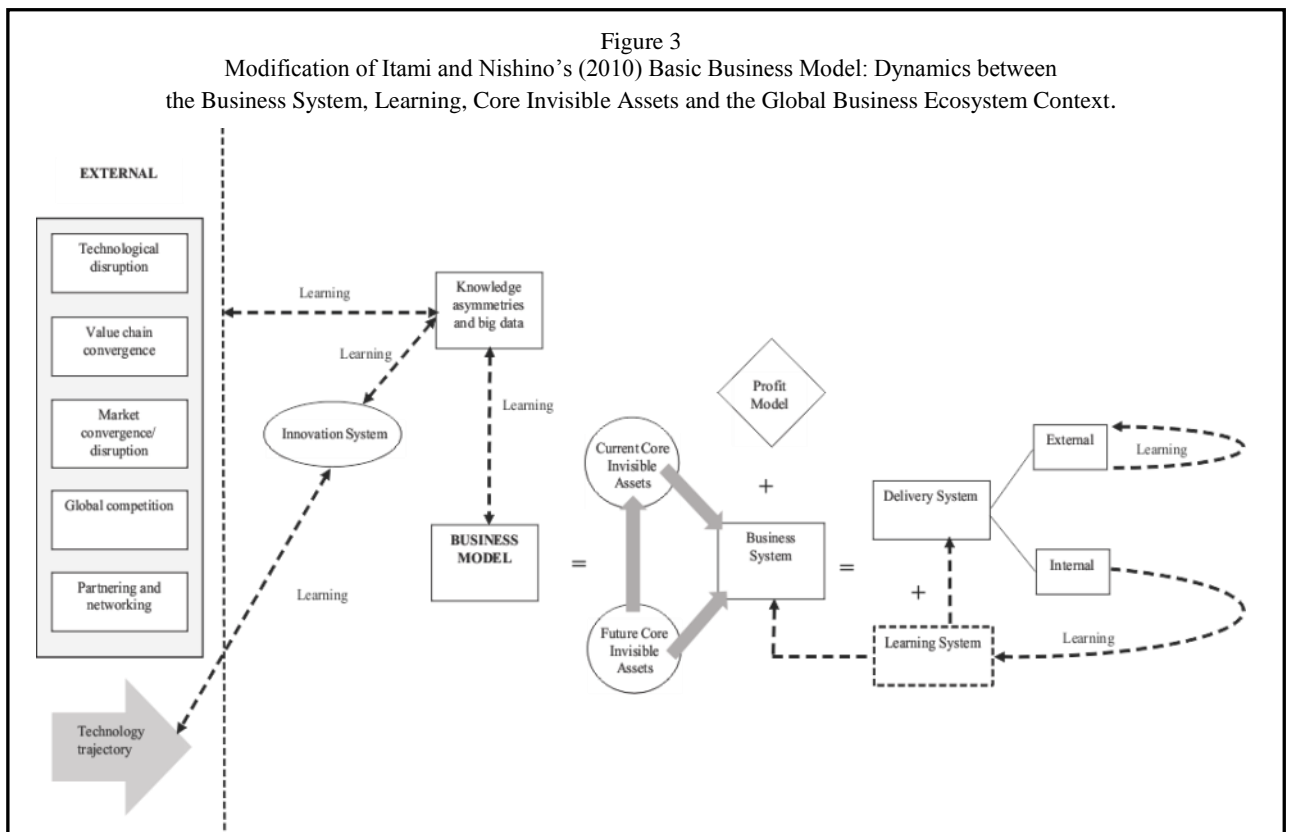

Another way of saying all of the above and as **Figure 3** illustrates, the factors that stimulate innovation diversity within the global business ecosystem itself - the technological disruptions that are currently prevalent, and the degree of value chain convergence, market convergence/disruption, global competition, and partnering and networking occurring within the business ecosystem – lead to widespread change. Thus, diversity is the result of learning. It is also the product of change occurring at individual firms and spilling out to other firms in the global business ecosystem (as a result of endogenous processes). Obviously, as a rule of thumb, individual firms will have a much smaller ability to influence but they will nonetheless influence. In regard to endogenous change that occurs within individual firms this is change that originates from the innovation system at the firm.

### 3. *Knowledge asymmetries and the big data phenomenon*

In the literature review section, which highlighted how knowledge relating to technology creates (dis)advantaging asymmetries and that the big data phenomena is intensifying the rate at which innovation is necessary, it is clear that more knowledge management and data mining capabilities are needed than ever before. This is illustrated in **Figure 3** which shows that not only is knowledge (data) accessed and analysed from the global business ecosystem but that knowledge (data) is accessed and analysed at the firm level, that is, as it relates to the business model of the firm at the current time and in the future.

### 4. *The innovation system*

The literature review and as highlighted in the previous three subsections confirms the innovation system firms use can be described as the means by which firms recombine knowledge or generate new knowledge to identify novel opportunities from within and from outside the firm's boundaries. This is possible because it is made up of three knowledge-based components:

1. Business model innovation;
2. Technology change or technology innovation; and
3. Learning from and during innovation from assessing knowledge, including knowledge which was derived from big data; this is illustrated in **Figure 3**.

## **RATE OF INNOVATION IN THE GLOBAL BUSINESS ECOSYSTEM: A FIRM LEVEL (MANAGERIAL) VIEW**

In the previous section, we explained how the Itami and Nishino (2010) framework could be enriched by considering four inter- and intra-firm effects as described in the previous section.

The power of this is that we can get real insight into how firms that succeed and remain competitive in the global business ecosystem contribute to innovation globally, that is, the upward trend in innovation. This can be described as the rate of innovation that occurs within and outside of the firm's boundaries as a result of continuously learning. The assumption is that those firms that cannot learn effectively drop out of the global business ecosystem or morph.

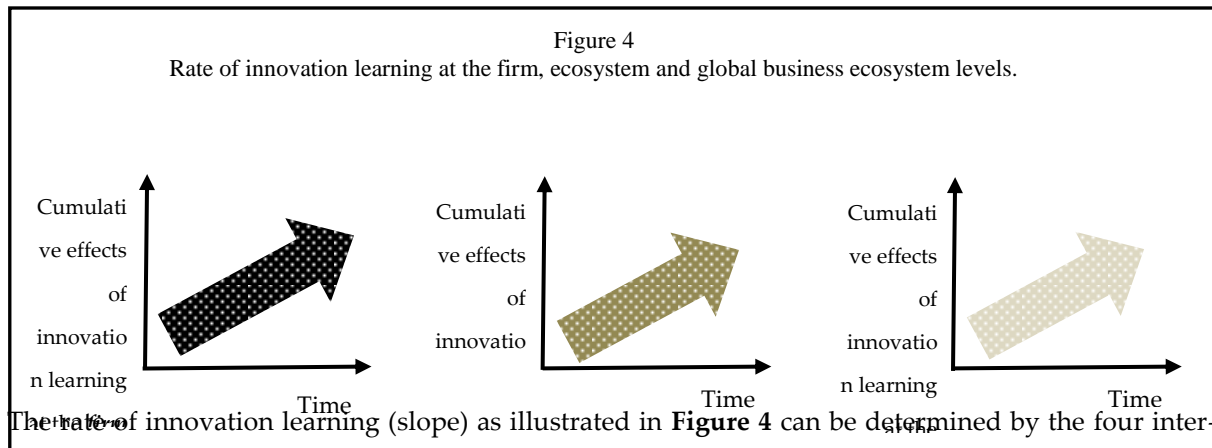

and intra-firm effects and defined as follows:

$$Y = Y_1 + Y_2 + Y_3 + Y_4,$$

Whereas,

Y = Rate of innovation learning

Y<sub>1</sub> = Innovation outcomes toward global business ecosystem efficiency

Y<sub>2</sub> = Innovation diversity determinants (within and outside firm)

Y<sub>3</sub> = Knowledge asymmetries and the big data phenomenon

Y<sub>4</sub> = The innovation system

This equation suggests that the rate of innovation learning is the result of all the four factors coming into play and the fact that the three systems (at the firm, ecosystem and global business ecosystem levels) are interdependent. It demonstrates that though it is cognitively useful to have a static approach or even dynamic/longitudinal approach when thinking about business models and the effects of technology change, or vice versa, a system approach that incorporates learning is most useful when thinking about different time horizons. The way in which value is created will be dependent on learnings that tell managers what should be the focus/foci at any one time.

## CONCLUSION AND IMPLICATIONS

This paper developed the Itami and Nishino (2010) framework, which was a high-level systems explication of business models taking learning into account. Though potentially very powerful in its own right, the Itami and Nishino model only focussed on how managers continually learn about the

business system with an emphasis on how managers continually learn about the delivery system (which is a subsystem of the business system). In other words, their framework is focussed on explaining how learning occurs in regard to value chain activities. This means their framework did not provide insight into how business models change in response to change that is not value chain-centric, including global business ecosystem-centric change.

Neither did it provide insight into what comes first, that is, decisions about changing or innovating the business model or decisions about changing or innovating the technologies taken up and used at the firm level. The reality is that these learning processes and decisions thereof require managers not to just engage with value chain partners but to engage in learning activities about the whole global business ecosystem, including the specifics of the ecosystem that most concerns the firm. In other words, using Darwinist principles to analogise, over long periods of time one can see the overall effect of change, that is, the business models and technologies that emerged to be dominant, but what might be most interesting is the interplay of individual factors that lead to natural selection.<sup>5</sup> This kind of equifinality is worthy of further exploration quite clearly. Just like the chicken and the egg problem, we know that they evolved together to some extent within the ecosystem but at some point a happenstance affecting one or both of them occurred that explained the problem of which came first or achieved pre-eminence.

To reiterate, although our discussion provides insight into what occurs in the global business ecosystem, the objective of this paper was not to explain the whole global business ecosystem or, in other words, provide a macro level explanation of how innovation occurs but to provide insight into the way in which individual firms gather data and then change their business model, as well as the technology they decide to use and develop.

The business model literature and the technology change literature variously alternate between arguing that technologies are underpinned by business models and evolve accordingly while business models are underpinned by technology change and evolve accordingly. As indicated, this is analogous to the chicken and egg problem about what comes first. Our framework is a step toward understanding what might be the answer here in regard to business models and technology change, and which comes first. Thus, in addition to the concept of a technology trajectory, which has been studied extensively, the concept of a business model life-cycle, including one that develops alongside different technology trajectories, may need to be developed as a construct and studied in detail.

As a conceptual piece, bearing in mind that no empirical work using our framework has been undertaken yet, our paper suggests that the what comes first decision is learning based and over time business models and technology necessarily (mostly) evolve together, that is, in the long-run.



Presumably, the managers of a firm at start-up stage must make two either/or decisions in the first instance: should the focus be on the choice of business model or the choice of technology? When we are talking about firms that are mature and part of a global business ecosystem success could be contingent upon the ability to see where the firm sits within the global business ecosystem and to what extent it can contribute to the richness of diversity within it. In this paper, this was elaborated upon in **Figure 4** where the rate of innovation that occurs within and outside of the firm's boundaries as a result of continuous learning was depicted, supporting our argument that learning is essential for global business ecosystem relevance.

#### *Implications for theory and research*

This paper contributes to a number of literatures, including the technology and innovation management, strategic management, and strategic entrepreneurship literatures. It has the potential to be a basis for learning much more about how firms learn about customers and make decisions about investing in capabilities to achieve business model outcomes and different technologies, and the iterative nature of this learning process, including how managers translate their learnings about customer value into new capabilities able to deliver on different dimensions of customer value. The modified framework in our paper focuses on the iterative nature of learning about business models and technology trajectories, as well as their various drivers; it provides the means for understanding how learnings about customer value creation can be used to help managers decide how to change their firm's business model and invest in technology.

Likewise, our modified framework can be used to help researchers better understand how the four inter- and intra-firm effects affect business model and technology change decisions, including across different time horizons. The business model life-cycle is a new concept and considerable scope exists to develop it via the abovementioned literatures. It may also be the situation that in different countries, etc. the way in which managers make decisions as a result of learning about these effects are significantly different, as well as the notion of a business life cycle. This too could lead to a rich research agenda.

The paper also highlighted the fact that big data has added another layer to the learning processes at firms; it has changed what it means to develop a dynamic capability. The modified framework could be used as a starting point for embarking on research that provides insight into the strategic implications of knowledge asymmetries and, in particular those that are the result of different capacities to make sense of big data. In this regard it could contribute to theory of the firm research using the knowledge-based view of the firm as its starting point (Grant, 1996; Spender, 1996). It could

also lead to greater focus on the customer value-oriented marketing information system from a strategic and/or technology and innovation management research perspective.

#### *Implications for management*

The implications for managers are potentially vast. However, in the first instance, it is clear that the modified framework and what it implies about the rate of innovation learning at the different levels as defined in this paper, and depicted in **Figure 3** and **Figure 4**, respectively, could make it easier for managers to understand: (1) timing issues about decisions to change the business model and/or the technology at the firm; (2) when the global business ecosystem or the ecosystem that most concerns the firm is about to change drastically; (3) the importance of big data and developing capabilities to take advantage of it; (4) how to better learn about the firm's systems and the systems of partners, etc.; and (5) better cope with hyper-competition.

## REFERENCES

- Baden-Fuller, C and Haefliger, S. (2013), "Business models and technological innovation", *Long Range Planning*, Vol. 46, pp. 419-426.
- Baden-Fuller, C. and Morgan, M.S. (2010), "Business models as models", *Long Range Planning*, Vol. 43, pp. 156-171.
- Christensen, C.M. and Bower, J.L. (1996), "Customer power, strategic investment and the failure of leading firms", *Strategic Management Journal*, Vol. 17, pp. 197-218.
- DaSilva, C.M. and Trkman, P. (2014), "Business model: What it is and what it is not", *Long Range Planning*, Vol. 47, pp. 379-389.
- D'Aveni, R.A. and Gunther, R. (1994), *Hypercompetition: Managing the dynamics of strategic maneuvering*, The Free Press, New York.
- D'Aveni, R.A., Dagnino, G.B. and Smith, K.G. (2010), "The age of temporary advantage", *Strategic Management Journal*, Vol. 31, pp. 1371-1385.
- Demil, B. and Lecocq, X. (2010), "Business model evolution: In search of dynamic consistency", *Long Range Planning*, Vol. 43, pp. 227-246.
- Dosi, G. (1982), "Technological paradigms and technological trajectories: A suggested interpretation of the determinants and directions of technical change", *Research Policy*, Vol. 11, pp. 147-162.
- George, G., Osinga, E.C., Lavie, D. and Scott, B.A. (2016), "Big data and data science methods for management research", *Academy of Management Journal*, Vol. 59, No. 5, pp. 1493-1507.
- Itami, H. and Nishino, K. (2010), "Killing two birds with one stone: Profit for now and learning for the future", *Long Range Planning*, Vol. 43, pp. 364-369.
- Koka, B.R. and Prescott, J.E. (2008), "Designing alliance networks: The influence of network position, environmental change, and strategy on firm performance", *Strategic Management Journal*, Vol. 29, pp. 639-661.
- Pfaffmann, E. and Stephan, M. (2001), "How Germany wins out in the battle for foreign direct investment: Strategies of multinational suppliers in the car industry", *Long Range Planning*, Vol. 34, pp. 335-355.
- Porter, M. (1990), *The Competitive Advantage of Nations*, Free Press, New York.
- Thomas, L.G. and D'Aveni, R. (2009), "The changing nature of competition in the US manufacturing sector, 1950-2002", *Strategic Organization*, Vol. 7, No. 4, pp. 387-431.
- Wirz, B.W. Schilke, O. and Ullrich, S. (2010), "Strategic development of business models: Implications of the Web 2.0 for creating value on the Internet", *Long Range Planning*, Vol. 43, pp. 272-290.
- Wirz, B.W. (2001), "Reconfiguration of value chains in converging media and communications markets", *Long Range Planning*, Vol. 34, pp. 489-506.
- Zott, C. and Amit, R. (2010), "Business model design: An activity system perspective", *Long Range Planning*, Vol. 43, pp. 216-226.

## LEGITIMACY THEORY AND SUSTAINABILITY REPORTING.

### EVIDENCE FROM ITALY.

**Vitolla, Filippo; Rubino, Michele**

Lum University, Casamassima (BA), Italy

#### ABSTRACT

*Which information is contained in the socio-environmental and sustainability reports? How does the industry to which firms belong to affect the sustainability reports? In this paper we aim to evaluate the wideness of sustainability reports and to verify, with respect to the Legitimacy Theory, its impact on the industry in which the firm operates. The analysis was carried out on a sample of companies listed on the Italian Stock Exchange in 2015.*

*The idea of analysing the sustainability reports is linked to two tightly interrelated aspects: the relevant criticalities of the management of the social dimension, in view of the company's success, and the growing relevance of voluntary disclosure systems; the second aspect is concerned, the way to manage the communication activities affects in a notable way the relationship with the stakeholders, and consequently, the whole balance of the company and the possibility of a long period of success. The specific choice of analyzing the Italian companies derives from the fact that particularly in Italy, and in general in the non-Anglophone countries, there is no established literature on the theme.*

*Keywords: Italian Companies, Legitimacy Theory, Sustainability Reporting*

#### INTRODUCTION

Which information is contained in the socio-environmental and sustainability reports? How does the industry to which firms belong to affect the sustainability reports? In this paper we aim to evaluate the wideness of sustainability reports and to verify, with respect to the Legitimacy Theory, its impact on the industry in which the firm operates.

The idea of analysing the sustainability reports is linked to two tightly interrelated aspects: the relevant criticalities of the management of the social dimension, in view of the company's success, and the growing relevance of voluntary disclosure systems. With reference to the first aspect, it is necessary to highlight the presence of a series of factors that have deeply modified in a structural way the socio-economic context in which the economic operators are working. As far as the second aspect is concerned, the way to manage the communication activities affects in a notable way the relationship with the stakeholders, and consequently, the whole balance of the company and the possibility of a long period of success. The specific choice of analyzing the Italian companies derives from the fact

that particularly in Italy, and in general in the non-Anglophone countries, there is no established literature on the theme. Moreover, having considered the influence of national macro-context sustainability, it is interesting to verify whether there is a supranational convergence of the effects caused by a relevant factor, and what is the industry with respect to the reports' content.

The analysis was carried out on a sample of companies listed on the Italian Stock Exchange in 2015; the choice only involved the listed companies according to two basic reasons: the first was the data accessibility, the data is easily available in listed companies, the second was connected to the voluntary disclosure processes which are generally more developed and structured in the companies which have access to capital market. In order to assess the impact connected to industry it belongs to a character connection analysis was carried out, with the aim of detecting the existence of a link of any nature between the industry and the content in the sustainability report. In particular, in order to analyse the report's content the following elements have been taken into account: an introductory part; the economic aspects; social aspects and environmental aspects. Our work is organized as follows: in the second paragraph we analysed the literature about the Legitimacy Theory, which is the spectrum in which the paper moves; in the third paragraph we described the methodology used; in the fourth paragraph we analysed and interpreted the results obtained; in the fifth paragraph we proposed our conclusions.

## **LITERATURE REVIEW: THE LEGITIMACY THEORY**

This theory refers to a contract between society and companies, whereby the latter adopt socially oriented behaviours in order to gain social approval (Guthrie e Parker, 1989). The existence of a social contract between the companies and society is fundamental to the purpose of legitimation (Mathews, 1993). Such contract is stipulated, though in abstract terms, between the companies and the individuals that make up a local community. The local community supplies to the company the natural and human resources; the companies produce, for the community, the goods and services and they generate waste. The contract is based on mutually beneficial exchanges. The terms of this social contract reflect the social expectations on the management of the company. Such expectations can be explicit or implicit: the former about the firm's compliance with the laws and regulations; the latter, the interests of the community in the firm's activity (Deegan et al., 2000). The legitimacy of a firm could be threatened by the breach of explicit and implicit terms of the contract. A loss of the legitimacy creates serious hazards that might endanger the survival of the firm. In the literature, two different kinds of Legitimacy Theory can be found. The first variable has as object the individual firm. From this point of view the firm enacts choices and actions aimed at filling the gap of legitimacy, in order to hit the desired level (Lindblom, 1994). Generally, the actions implemented aim to increase, to

preserve and restore company legitimacy, that is a necessary condition to effectively operate in the social and economic context of reference. The undertaking of socially oriented actions, among which the implementation of specific reporting systems, is instrumental in order to achieve the objective of legitimacy. The second variable concerns the legitimacy of the capitalist system as a whole. In this case the development of social reporting processes is functional to the systemic legitimacy of entire industries and countries (Gray et al., 1996). Naturally legitimacy processes change from firm to firm, in space and in time, due to the different social contexts in which the companies work. In the last twenty years many studies on social and environmental reporting have adopted the Legitimacy Theory to interpret and explain practices of disclosure that are put in effect by the firms (Guthrie e Parker, 1989; Patten, 1992; Adams et al., 1998; Tsang, 1998; Campbell, 2000; Wilmshurst e Frost, 2000; Deegan et al., 2002; Milne e Patten, 2002; Newson e Deegan, 2002; O'Donovan, 2002; O'Dwyer, 2002). Among the first significant contributions it is worth mentioning the essay by Guthrie e Parker (1989) that aimed at verifying the relationship between social and environmental events and the activity of voluntary disclosure of an Australian firm (BHP Ltd) over a long-term frame (100 years, from 1885 to 1985). The results did not confirm the existence of this relationship and were considered unsuitable to support the Legitimacy Theory. Deegan et al. (2002), in a later essay, attributed the failed confirmation of the hypothesis to mistakes, by Guthrie and Parker (1989), in the measuring of the variables used to represent social and economic phenomena and the omission of significant events. The results of analysis carried out on the same firm (BHP Ltd) from 1983 to 1997, supported the Legitimacy Theory and demonstrated the link between the media attention and the activity of social- environmental of disclosure. Relevant studies that have proved the validity of the Legitimacy Theory include: Patten (1992), Tsang (1998), Wilmshurst e Frost (2000), Milne e Patten (2002), O'Donovan (2002).

O'Dwyer's essay (2002) is significant because he has tried to explore the manager's feelings about social and environmental reporting systems. The research results underscored the influence of the external context over voluntary disclosure, even if in a completely different way from the early hypotheses: in Ireland the community persuaded the managers not to implement social- environmental reporting methods, in view of the low disposition of the Irish citizens to communicate positive results. The voluntary disclosure of positive information about the firm's activity was considered absolutely self-defeating, in terms of legitimacy, because the social and economic context of reference felt this activity instrumental to the achievement of the firm's economic goals. Certainly, the Legitimacy Theory has the merit of putting together the implementation of the reporting systems of sustainability and the dynamics of the external context.

In particular, it seems interesting to evaluate if, depending on the extent and the contents of the sustainability reports, the Legitimacy Theory can be applied to the single firm, to specific industries

or, if, on the contrary, it concerns the whole set of firms; the resulting research question is then the following:

RQ: Can the extent and the contents of sustainability reports change because of the industry the firm belongs to?

## METHODOLOGY

With respect to the objective of the work and to the research aim we selected a random sample of 50 companies listed in the Milan stock exchange which issue a sustainability report (or similar reports, such as social reports, environmental reports and integrated reports). The firms have further been grouped in 4 different industries according to the prevailing activity each one carries out: Consumer, Energy & Utilities, Financial, Industrial. For each sample company we verified the presence of the information linked to the following 35 items, grouped in four categories: Introductory part (Letter by the CEO/President; Corporate Governance; History; Methodological Note; Vision & Mission; Corporate Values & Culture, Firm Activities; Internal Control System; Reading Guide; Key); Economic aspects (Info about the financial situation; Financial Report; Value added; Financial Indicators; Share Indicators); Social Aspects (Customers; Local Community; Suppliers; Stakeholders; State and Institutions; Creditors & Banks; Media; Future Generations); Environmental Aspects (Environmental Management Tools; Environmental Training; Environmental Certifications; Environmental Research and Innovation; Remediation & Redevelopment works; Raw material consumption; Water consumption; Energy consumption; Biodiversity; Polluting emissions; Water drainage; Waste). To each sample company we assigned a value of 1, corresponding to all those items the information of which is present in the sustainability report; we assigned a value of 0 corresponding to all those items the information of which is not present in the sustainability report. To identify any statistically significant relationship between the industry type and each of the items, we built a dataset in which for each item we reported the percentage frequency of the information (both on the overall level and on the single industry).

To do this, we used the Chi-squared test of independence that, unlike correlation, can also be used when one or more of the two variables under examination are categorical. Moreover, being a non parametric statistics, it is robust with respect to the distribution of the data. It is worth noting, however, that the test does not allow to make claims about the direction of causality between the two variables but only that they are to some extent related to each other, namely, that certain categories of the first variable match certain categories of the second one more frequently than it would be observed if the two variables were independent.

Formally, let  $X$  and  $Y$  be two variables having, respectively,  $h$  and  $k$  number of categories. Suppose we have a sample of  $n$  observations organized in the following Contingency Table (Table 1):

		Y						Total
		$y_1$	$y_2$	...	$y_j$	...	$y_k$	
X	$x_1$	$n_{11}$	$n_{12}$	...	$n_{1j}$	...	$n_{1k}$	$n_{1.}$
	$x_2$	$n_{21}$	$n_{22}$	...	$n_{2j}$	...	$n_{2k}$	$n_{2.}$
	...	...	...	...	...	...	...	...
	$x_i$	$n_{i1}$	$n_{i2}$	...	$n_{ij}$	...	$n_{ik}$	$n_{i.}$
	...	...	...	...	...	...	...	...
	$x_h$	$n_{h1}$	$n_{h2}$	...	$n_{hj}$	...	$n_{hk}$	$n_{h.}$
	Total	$n_{.1}$	$n_{.2}$	...	$n_{.j}$	...	$n_{.k}$	$n$

**Table 1:** Contingency Table

If the distribution of  $Y$  does not vary with the categories of the  $X$  (and vice versa), then the two variables are independent. More precisely, in this case, the conditional distributions  $Y|(X = x_i)$  will not vary with  $i = 1, 2, \dots, h$ . This implies that conditional frequencies  $n_{ij}/n_{i.}$  are constant. Similarly, the conditional distributions  $X|(Y = y_j)$  will not vary with  $j = 1, 2, \dots, k$ , and then the conditional frequencies  $n_{ij}/n_{.j}$  are constant as well. Then:

$$\frac{n_{ij}}{n_{i.}} = \frac{n_{.j}}{n} \Leftrightarrow n_{ij} = \frac{n_{i.} n_{.j}}{n} \quad (1)$$

This equation allows to compute the theoretical frequencies, that is precisely the frequencies that would be observed in the case of independence of the two variables. The chi-square index,  $X^2$ , is based on the differences between observed and theoretical frequencies and is given by:

$$X^2 = \sum_{i=1}^h \sum_{j=1}^k \frac{(n_{ij} - n_{ij}^*)^2}{n_{ij}^*} = n \left( \sum_{i=1}^h \sum_{j=1}^k \frac{n_{ij}^2}{n_{i.} n_{.j}} - 1 \right) \quad (2)$$

where  $n_{ij}^*$  denotes the theoretical frequencies calculated by (1). In the event of independence, the observed frequencies coincide with the theoretical ones and then  $X^2=0$ . Conversely, in the case of maximum dependence, it can be shown that  $X^2 = n \times \min[(h-1), (k-1)]$ . This occurs when each category of  $X$  corresponds to one and only category one of  $Y$ .

The independence between the two variables can be tested by considering the following system of hypotheses:

$$\left\{ \begin{array}{l} H_0: X \text{ e } Y \text{ are independent} \end{array} \right.$$

$H_1: X \text{ e } Y \text{ are not independent}$

The test statistic is given by (2) and, under the null hypothesis  $H_0$ , it is distributed according to a  $\chi^2$  with  $g = (h-1)(k-1)$  degrees of freedom.

## ANALYSIS OF THE RESULTS

The report contents can be classified in the following sections (Table 2):

- introductory part;
- economic aspects;
- social aspects;
- environmental aspects.

The analysis we carried out highlights the fact that a large percentage of documents includes the letter by the CEO or by the president (94% of the analysed sample companies). Concerning the general information of the document, the methodological note shows the highest frequency percentage (86%); little popular both the key (32%) and the reading guide (18%). As far as the company profile is concerned, the information about performed activity reveals the highest percentage frequency (94%), followed by vision & mission (82%), corporate values & culture (74%) and history (64%). Finally, a large percentage of companies issuing the document provides information on the governance (90%) and on the internal control systems (88%). These data underscore, firstly, the companies' intention to make their documents more credible. Moreover, the data show that the documents are generally issued in order to facilitate their reading and the understanding of the reports by the stakeholders. The results indicate, then, the tendency to give some information on the company's identity and to describe a fourth dimension of sustainability, i.e. governance in line with the evolution of reporting towards the EEGS systems (*Economic, Environmental, Governance, Social*).

With reference to the economic aspects, the prospect of value added is the highest percentage item (88%); the presence of the economic performance is also high (84%), of the share indicators (70%) and of the financial indicators (68%). Less frequent is the presence of the financial reports (26%), probably to avoid a duplication of the information found in the annual reports.

With reference to the social aspects, the results of the research highlight the presence, in the reports, of sections devoted for the large part to the categories of stakeholder. Local community 98%; Suppliers 94%; Clients 90%; Stakeholders 84%; State 80%; less than one company in two provides information on Creditors and Banks (40%) and Media (38%). Very low (8%) was the percentage of the sections devoted to future generations: the relative field of observation has the tendency to coincide with the



one concerning the environmental dimension, much more used to describe the company's commitment with future generations.

As far as the environmental aspects are concerned, the analysis points out that the large majority of the sample companies (86%) issuing the report provide information about the tools of environmental management used, such as those for structuring the programs, for the assessment and recording of the effects of the productive activity and of the products made, for the operative control (monitoring and correction), for defining the organizational routines, for auditing and reviewing the adopted systems. The percentage (72%) of documents about the indications on the environmental certifications held is also very significant. The percentages about the companies which report on data concerning specific training (40%), about research and environmental innovation (24%) and about the remediation and rehabilitation put in place (14%) are smaller. With specific reference to the impacts, the analysis shows that almost all the companies provide information about consumption: energy, 96%, water, 94%, raw materials, 82%; high percentage frequency also for items related to the output: waste, 90%, polluting emissions, 86%. The only exception being the water discharges: only 40% of the reports contains information in on this issue.

With reference to the introductory part, the industry analysis shows that the Energy & Utilities companies are less inclined to provide qualitative information regarding the company's profile; the narrative part about the corporate identity, instead, seems more developed in the *Financial* industry. However, there are no statistically significant relationships between the specific industry and content of the introductory part of the report, with the exception of the methodological note which displays a connection with the industry, significant at 5% (those being part of the Industrial e Financial industry reveal an increased predisposition in drafting the methodological note).

Concerning the economic aspects, the analysis of the industry reveals a lower frequency of the item in the Industrial sector, in view of the nature of the their activities and the consequent probable focus on the other dimensions of sustainability. However, also in this regard, there are no statistically significant relationships between the specific industry and content of the report; only the relationship between value added and specific industry displays a statistical significance at 5%.

Concerning the social aspects, Energy & Utilities and Financial companies are those which include the highest number of categories of stakeholders in their reports; the companies of the Industrial sector, instead, include the lowest number of specific sections devoted to it on average. The results also show a certain degree of sectorial heterogeneity concerning the individual categories of stakeholder. However, also in this case, there are no statistically significant relationships between the content of the report and the specific industry; the only statistically significant relationship (10%) is the relationship between the specific industry and the presence of sections devoted to the media (the Financial

companies are more inclined to provide information concerning the media, probably due to the social role they play).

With reference to the environmental themes, the analysis shows the tendency to a higher accountability on the issue of environmental management of the Energy & Utilities and Industrial companies, probably related to the significant effects of their activities on the environment. In this case there is a particularly significant number of relationships between industry and environmental aspects in the reports: environmental certifications (significance at 1%); environmental research and innovation (significance at 1%); land reclamation/drainage works (significance at 1%); biodiversity (significance at 1%); polluting emissions (significance at 1%); water discharges (significance at 5%); This is linked to the different impact that the environmental issues could have on the individual companies in relation to their activity and, then, accordingly, to the industries they belong to (certainly, Energy & Utilities e Industrial sectors are more sensitive to the environmental issues than the other ones).

As far as the research question is concerned, it is evident that most of the firms draft a full and inclusive sustainability report, irrespective of the industry they belong to. The empirical analysis supports the theory of legitimacy, where it highlights that the companies search for the consensus within the context of reference through the publication of information which go beyond the regulatory requirements. In the view of the Legitimacy Theory (Lindblom, 1994), for listed companies, the increased pressures coming from the external environment also have to be considered, given their importance in terms of both positive and negative impacts, on the context considered as a whole. In this perspective, the purpose of sustainability reporting is to fill the legitimacy gap until the desired level is achieved (Lindblom, 1994), pursuing the objective of increasing, maintaining and restoring the consensus by the stakeholder. Their consensus is a necessary condition in order to act effectively in the socio-economic context in which they operate. Communication is the most important element for the legitimation within the reference environment and for the approval of the stakeholder (Gray et al., 1996). Being socially responsible is not enough to legitimize oneself, it is also required to communicate the objectives, the actions and the results obtained (Newson e Deegan, 2002; De Villiers e Van Staden, 2006). Accordingly, sustainability reporting is an aspect of particular importance for the legitimacy processes, contributing to improve the transparency in the relationships and to increase the credibility and the confidence between the community and the stakeholders.

Our empirical research confirms that there is a relationships between industry and content of sustainability reporting, although it is limited to the environmental aspects.

Several studies have generally highlighted the influence of the industry over the socio-environmental and sustainability reports (Verrecchia, 1983; Cowen et al., 1987; Ness e Mirza, 1991; Beliveau et al.,

1994; Gray et al., 1995; Morris, 1997; Adams et al., 1998; Clarke e Gibson-Sweet, 1999; Hoffman, 1999; Bowen, 2000; Line et al., 2002; Archel, 2003; Brammer e Millington, 2006; Jenkins e Yakovleva, 2006). The influence of the industry on the sustainability reporting systems, according to the existing literature, can be linked to two factors (Branco e Rodrigues, 2008): the environmental relevance of the activities carried out by the firm and its proximity to the consumer. Many have been the research studies (Ness e Mirza, 1991; Morris, 1997; Clarke e Gibson-Sweet, 1999; Hoffman, 1999; Bowen, 2000; Line et al., 2002; Archel, 2003) that have demonstrated the higher tendency towards sustainability disclosure by the firms operating in particularly critical industries under an environmental perspective (oil industry, mining industry, metallurgical industry, chemical industry and paper making industry). It is necessary, in a Legitimacy Theory perspective, to consider the increasing pressures that the context is putting on the firms with a strong social and environmental significance (Cowen et al., 1987; Patten, 1991; Milne e Patten, 2002; Parsa e Kouhy, 2008) which determines a stronger commitment in their reporting activities, in order to legitimize themselves in a society and the community. According to this theoretical framework, the statistical insignificance of the industry compared to other dimensions of sustainability reporting (introductory part, economic elements, social elements) could be motivated by the growing importance of voluntary disclosure which makes firms communicate on sustainability issues regardless of their criticalities and individual activity, in order to reduce the context hostility even when it is not connected to industry specificity.

## CONCLUSIONS

This work aimed at analysing the content of sustainability reports verifying whether their wideness varies according to the industries in which the companies operate. Based on the theory of legitimacy the companies adopt systems of voluntary disclosure in order to keep and widen the consensus within the local community. In this view, the companies make communicative choices and actions in order to fill the legitimacy gap, until they the level they wish is reached. The empirical analysis supports the Legitimacy Theory, in cases where the companies search for consensus through the publication of information concerning not only the financial aspects, but also the social and environmental ones. In terms of legitimacy, for the sample companies, the main pressures are those by the financial markets, which push them to a wider transparency in their relationships.

Sustainability reporting becomes particularly important in the legitimacy processes, contributing to the enhancement of credibility and building trust with the local community and with the stakeholders. Naturally, the processes of legitimacy change from firm to firm, in space and time, since the social contexts in which they operate are different.

On this basis, our empirical research confirms the existence of a relationship between the industry and the content of the sustainability reports, albeit restricted to the environmental aspects.

In a Legitimacy Theory perspective it is necessary to refer to the main pressures that the context exerts on the companies with a strong social and environmental relevance which determines their greater commitment to the reporting activities, in order to legitimize themselves in society and the local community.

The results obtained are the basis for two managerial implications that must be considered together: in the industries that are particularly critical from an environmental point of view, voluntary disclosure represents an essential element of legitimacy; it is necessary, however, not to consider those reports as a formal tool of legitimacy, that would make the information homogenous in the different companies regardless of the effective informative needs of the stakeholders.

Item	% Frequency	% Frequency Consumer	% Frequency Energy & Utilities	% Frequency Financial	% Frequency Industrial	$\chi^2$	P-value
INTRODUCTIVE PART							
Letter by CEO/President	94,00	91,67	100,00	94,12	88,89	3.7301	0.292
Corporate Governance	90,00	100,00	91,67	88,24	77,78	2.3316	0.506
History	64,00	83,33	66,67	58,82	44,44	3.7682	0.288
Methodological Note	86,00	83,33	66,67	94,12	100,00	8.9497	0.030 (**)
Vision & Mission	82,00	83,33	58,33	94,12	88,89	4.6943	0.196
Corporate values & culture	74,00	75,00	41,67	88,24	88,89	6.2308	0.101
Firm activities	94,00	100,00	100,00	88,24	88,89	5.1370	0.162
Internal control system	88,00	83,33	91,67	88,24	88,89	0.4250	0.935
Reading guide	18,00	16,67	25,00	23,53	0,00	2.6422	0.450
Key	32,00	16,67	58,33	17,65	44,44	5.0227	0.170
ECONOMICS ASPECTS							
Info about the financial situation	84,00	91,67	83,33	70,59	100,00	2.3634	0.500
Financial report	26,00	16,67	16,67	29,41	44,44	1.1991	0.753
Value added	88,00	91,67	91,67	100,00	55,56	10.4180	0.015 (**)
Financial indicators	68,00	66,67	83,33	70,59	44,44	0.8750	0.831
Share indicators	70,00	83,33	66,67	70,59	55,56	1.0701	0.784
SOCIAL ASPECTS							
Customers	90,00	100,00	91,67	100,00	55,56	8.7760	0.032 (**)
Local Community	98,00	91,67	100,00	100,00	100,00	3.3150	0.346
Suppliers	94,00	91,67	91,67	100,00	88,89	2.0306	0.566
Shareholders	84,00	83,33	83,33	100,00	55,56	3.7890	0.285
State & Institutions	80,00	83,33	91,67	82,35	55,56	4.2017	0.240
Creditors & Banks	40,00	41,67	66,67	23,53	33,33	6.1351	0.105
Media	38,00	16,67	41,67	64,71	11,11	7.3583	0.061 (*)
Future Generations	8,00	0,00	25,00	5,88	0,00	5.4511	0.142
ENVIRONMENTAL ASPECTS							
Environmental Management Tools	86,00	91,67	91,67	82,35	77,78	3.1134	0.374
Environmental Training	40,00	25,00	58,33	35,29	44,44	3.2218	0.359
Environmental Certifications	72,00	83,33	100,00	29,41	100,00	25.5787	0.000 (***)
Environmental Research and	24,00	8,33	66,67	5,88	22,22	13.5614	0.004 (***)

Innovation							
Remediation & Redevelopment works	14,00	0,00	50,00	0,00	11,11	18.1591	0.000 (***)
Raw material consumption	82,00	91,67	66,67	82,35	88,89	1.3061	0.728
Water consumption	94,00	91,67	100,00	88,24	100,00	3.7301	0.292
Energy consumption	96,00	91,67	100,00	94,12	100,00	1.6046	0.658
Biodiversity	54,00	66,67	91,67	29,41	33,33	11.5301	0.009 (***)
Polluting emission	86,00	91,67	100,00	64,71	100,00	11.7246	0.008 (***)
Water drainage	38,00	66,67	58,33	11,76	22,22	10.5633	0.014 (**)
Waste	90,00	91,67	91,67	88,24	88,89	1.9957	0.573

Statistical significance:

(\*\*\*) 1%

(\*\*) 5%

(\*) 10%

**Table 2:** Results

## REFERENCES

- Adams C.A., Hill W.Y., Roberts C.B. (1998), «Corporate social reporting practices in western Europe: legitimating corporate behaviour», *British Accounting Review*, 30(1), pp. 1-21
- Archel P. (2003), «La divulgación de la información social y medioambiental de la gran empresa española en el período 1994-1998: situación actual y perspectivas», *Revista Española de Financiación y Contabilidad*, 32(117)
- Beliveau B., Cotterill, M., O'Neill, H.M. (1994), «Predicting corporate social responsiveness: a model drawn from three perspectives», *Journal of Business Ethics*, 13(9)
- Bowen F. (2000), «Environmental Visibility: A Trigger of Green Organizational Response?», *Business Strategy and the Environment*, 9(2), pp. 92-107
- Brammer S., Millington A. (2006), «Firm size, organizational visibility and corporate philanthropy: an empirical analysis», *Business Ethics: a European Review*, 15(1)
- Branco M.C., Rodrigues L.L., (2008), «Factors Influencing Social Responsibility Disclosure by Portuguese Companies», *Journal of Business Ethics*, 83(4)
- Campbell D. (2000), «Legitimacy theory or managerial reality construction? corporate social disclosure in Marks and Spencer Plc corporate reports, 1969 - 1997», *Accounting Forum*, 24(1)
- Clarke J., Gibson-Sweet M. (1999), «The use of corporate social disclosures in the management of reputation and legitimacy: a cross-sectoral analysis of UK Top 100 Companies», *Business Ethics: a European Review*, 8(1)
- Cowen S.S., Ferreri L.B., Parker L.D. (1987), «The impact of corporate characteristics on social responsibility disclosure: a typology and frequency-based analysis», *Accounting, Organizations and Society*, 12(2)
- De Villiers C., Van Staden C.J. (2006), «Can less environmental disclosure have a legitimising effect? Evidence from Africa», *Accounting, Organizations and Society*, 31(8)
- Deegan C., Rankin M., Tobin J. (2002), «An examination of the corporate social and environmental disclosures of BHP from 1983-1997: a test of legitimacy theory», *Accounting, Auditing & Accountability Journal*, 15(3)
- Deegan C., Rankin M., Voght P. (2000), «Firms' disclosure reactions for major social incidents: Australian evidence», *Accounting Forum*, 24(1)
- Gray R., Kouhy R., Lavers S. (1995), «Constructing a research database of social and environmental reporting by UK companies», *Accounting, Auditing and Accountability Journal*, 8(2)
- Gray R., Adams C., Owen D. (1996), *Accounting and accountability: changes and challenges in corporate social and environmental reporting*, Prentice Hall International, Hemel Hempstead
- Guthrie J.E., Parker L.D. (1989), «Corporate social reporting: a rebuttal of legitimacy theory», *Accounting and Business Research*, 9(76)
- Hoffman A.J. (1999), «Institutional evolution and change: environmentalism and the U.S. chemical industry», *Academy of Management Journal*, 42(4)
- Jenkins H.M., Yakovleva N. (2006), «Corporate social responsibility in the mining industry: exploring trends in social and environmental disclosure», *Journal of Cleaner Production*, 14(3-4)
- Lindblom C.K. (1994), «The implications of organizational legitimacy for corporate social performance and disclosure», paper presented at the Critical Perspectives on Accounting Conference, New York
- Line M.H., Hawley H., Krut R. (2002), «Development in global environmental and social reporting», *Corporate Environmental Strategy*, 9(1)
- Mathews M.R. (1993), *Socially responsible accounting*, Chapman Hall, London
- Milne M.J., Patten D. (2002), «Securing organizational legitimacy: an experimental decision case examining the impact of environmental disclosures», *Accounting, Auditing & Accountability Journal*, 15(3)
- Morris S. (1997), «Environmental pollution and competitive advantage: an exploratory study of U.S. industrial-goods manufacturers», *Academy of Management Conference Proceedings*, Academy of Management, New York
- Ness K.E., Mirza A.M. (1991), «Corporate social disclosure: a note on a test of agency theory», *British Accounting Review*, 23(3)
- Newson M., Deegan C. (2002), «Global expectations and their association with corporate social disclosure practices in Australia, Singapore, and South Korea», *The International Journal of Accounting*, 37(2)
- O'Donovan G. (2002), «Environmental disclosures in the annual report: extending the applicability and predictive power of legitimacy theory», *Accounting, Auditing & Accountability Journal*, 15(3)
- O'Dwyer B. (2002), «Managerial perceptions of corporate social disclosure: an Irish story», *Accounting, Auditing & Accountability Journal*, 15(3)
- Parsa S., Kouhy R. (2008), «Social reporting by companies listed on the alternative investment market», *Journal of Business Ethics*, 79(3)
- Patten D.M. (1991), «Exposure, legitimacy and social disclosure», *Journal of Accounting and Public Policy*, 10(4)

- Patten D.M. (1992), «Intra-industry environmental disclosures in response to the Alaskan oil spill: a note on legitimacy theory», *Accounting, Organizations and Society*, 17(5)
- Tsang E. (1998), «A Longitudinal Study of Corporate Social Reporting in Singapore», *Accounting, Auditing and Accountability Journal*, 11(5)
- Verrecchia R. (1983), «Discretionary disclosure», *Journal of Accounting and economics*, 5
- Wilmshurst T., Frost G. (2000), «Corporate environmental reporting: a test of legitimacy theory», *Accounting, Auditing and Accountability Journal*, 13(1)



## THE SOLAR PV SECTOR. EVOLUTION AND GROWTH OF INNOVATION IN THE SECTORAL SYSTEM

Xue, Han<sup>1</sup>; Jorge, Niosi<sup>2</sup>

<sup>1</sup>CIRST, UQAM

<sup>2</sup>Department of management and technology, Université du Québec à Montréal, Canada

### ABSTRACT

This paper discusses the product life cycle (PLC) and the industry life cycle (ILC) and sectoral systems of innovation (SSI) theories about the evolution of innovation in solar photovoltaics. PLC-ILC predicts that, over time, firms invest more efforts in process innovation, while the number of firms and the rate and diversity of product innovation eventually wither. In the sectoral innovation system perspective, taking into account that high-tech sectors are variation intensive, and that they receive institutional (public) support, the opposite may be true: over time innovation increases, new products appear, and products become more complex, by the addition of new functionalities, different applications to new market segments, and the arrival of different types of innovators. We contend that the SSI theoretical model can explain evolutionary patterns in many high-tech sectors, including biotechnology, ICT and nanotechnology. This paper is about industrial variation in the solar PV sector, and rapid growth of its market.

*Keywords: sectoral innovation systems, product and industry life cycles, solar photovoltaics*

### INTRODUCTION

There are two basic models to study industry evolution: industry life cycle models (ILC), based on the product life cycle (PLC) and history-friendly models (Malerba, 2007). Since the late 1960s, several studies using the PLC- ILC model have pointed to the fact that a large number of industries follow a life cycle in which a radical innovation and the related entry of small new producers that introduce new products is followed by demand growth, a greater emphasis on process innovations and a selection process which ultimately leads to a concentrated market structure, and the decline of innovation (Abernathy and Utterback, 1978; Utterback, 1994). But it has been convincingly indicated that that the dynamic sequences are different from one industry to another (Klepper, 1997; Geroski, 2003, Malerba, 2007). Thus, individual-industry case studies are necessary to see the real industrial dynamics, particularly in high-technology sectors such as biotechnology, information technologies, nanotechnology and solar photovoltaics; these sectors became noticeable after the PLC had adopted

its canonical form in the 1960s and 1970s. In the meantime, some cases studies have been developed, using history friendly models, for example the computer industry (Malerba et al., 1999, 2001), the pharmaceutical industry (Malerba and Orsenigo, 2002), as well as for other industries such as software and chemicals.

This paper explores the contours of the solar photovoltaic sector, a high-tech one that, like other science-based industries, shows uninterrupted innovation from its modest start in the 1950s to the present day. Like aerospace, biotechnology, ICT, and nanotechnology, the solar PV sector does not see innovation stagnate and decline, as argued by the PLC-ILC approaches, but on the contrary, it shows continuous novelty and its branching into new paths and the creation of new products for new markets. The institutional environment, and particularly the public policy one, can explain the “anomaly”. Such institutional milieu is absent in the PLC-ILC perspective, but is a central element in the innovation systems approach.

## 1. THE SOLAR PV SECTOR

In the solar PV sector we can find several periods. The first one was – after the creation of the solar cell converting sunlight into electricity in the Bell Labs in 1954 - its application into satellites and aerospace products that require electrical supply out of grid production. The United States hosted the main inventors and innovators in such companies as Hoffman Electronics, Signal Corporation, Communications Satellite Corporation, and Raytheon. The first solar cell powered satellite was launched in 1958 and was a total success (Perlin, 2002). At this time, specialised companies produced most solar cells and innovation.

In a second wave of innovation, in the 1960s and 1970s new types of innovators appeared; they were companies producing pocket calculators, and other electronic material such as Canon, Sharp and Toshiba in Japan, RCA and Texas Instruments in the United States. At the same time, some large energy companies, such as Exxon, and then ARCO in the United States became interested in solar energy for powering offshore oil and gas exploration and production. In Europe, Telefunken and other firms involved in the production of satellites became interested in solar PV technologies and conducted R&D and innovation. Australia also invested in solar PV in order to power telecommunications equipment in remote zones. The new wave of applications brought new innovators, most of them being both users and manufacturers.

The cost of producing solar energy declined as novelties piled up and new innovators launched their inventions in the market. A third wave of innovation arrived in the late 1980s and 1990s, were earthly applications boomed. Rooftop solar panels and the first solar power plants connected to the grid appeared in California. Western European countries such as Germany, Italy and Spain adopted policy

incentives, mostly feed-in tariffs (FIT) to increase the production of photovoltaic energy and reduce pollution through the use of clean technologies.

In the present, fourth wave, several Asian countries such as China, Taiwan, Japan and South Korea have taken the relay. Not only they manufacture the majority of solar PV equipment, but they are also implementing incentives to produce more photovoltaic energy at home. However, the United States is still the most innovative country, and China and Taiwan do not produce the most advanced solar equipment but rely on economies of scale; thus the rapid increase in adoption of both rooftop and grid-connected solar panels “crowds out” the most advanced but more expensive US-produced equipment. Yet, the US Department of Energy (through its National Renewable Energy Laboratory) predicts that in 2020 solar PV energy will be competitive almost everywhere with conventional sources of energy (US DoE, 2010). It is already competitive in most areas of Spain, Portugal, Italy, California, Texas and large portions of Africa and Central and South America.

In addition to these user-manufacturer innovators, universities and government laboratories have for over sixty years contributed to the development of the solar PV technology. Among them, If at the beginnings of the sector the University of Delaware was a major contributor, later on the National Renewable Energy Laboratory in the United States, the Fraunhofer Institute in Germany, the University of New South Wales School of Photovoltaic and Renewable Energy Engineering and its ARC Photovoltaics Centre of Excellence, the MIT Photovoltaics Research Laboratory and others have become more prominent.

## 2. THEORIES AND HYPOTHESES

The analysis of the evolution of industries has been captured by the PLC-ILC set of models for several decades. In these models, innovation starts centred in products, then product innovation declines and process innovation takes the relay. But after a certain number of years, both product and process innovation decline, the industry concentrates and it often moves to countries where the labour force is cheaper. This is the story of textiles, garment, furniture, in the past, and now bicycles, car, electrical equipment and other industries today. In the PLC-ILC theories, innovation is the result of the search activity of a particular group of firms, who are at the same time users and manufacturers. Companies produce novelty to integrate it in their product lines.

Governments have an occasional role in the process but usually they keep their hands off the product life cycle. Klepper, the father of the ILC theory, makes it very clear:

“In summary, apart from an occasional influence of the government/military, the evolution of the six products through their formative eras largely conforms with the PLC.” (Klepper, 1997)

On the contrary, the group of innovation system models that Malerba and others have pioneered, are

more attentive to the specific contours of each set of industries or sectors, where particular cost structures, natural or built competitive advantages, particular policy incentives or market sizes and structures can affect the evolution of the sector. The type of models allows for different sequences in the role of innovators, different types of demand structures and knowledge flows, and different institutional settings. The general argument that we put forward here is that science-based industries and sectors (SBIS) show a fairly different set of evolutionary patterns compared to more traditional industries. In SBIS, product variation is overwhelming, the branching out of new industries and the rise of new market segments is widespread. Thus, SBIS are more prone to innovation cascades than low and medium-tech industries (Niosi, 2015).

This paper argues – like Lundvall (1992) Malerba (2004), Nelson (2005), Niosi (2010) and others have done in the past – that institutions play a key role in the development of high-tech industries. This role has specifically been studied in biotechnology (McMillan et al, 2000, Whitley, 2003), in computers and software industries (Mowery, 1996), and nanotechnology (Roco and Bainbridge, 2005; Niosi & Reid, 2007). Governments subsidize these industries in order to improve human health, industrial competitiveness, and aiming at other societal benefits. They do it through public laboratories (think at the National Institutes of Health or the New Renewable Energy Lab in the United States), through academic subsidies to R&D, and through multiple incentives to private-sector innovation, including reimbursable and non-reimbursable subsidies, tax credits for R&D, and others, including subsidized tariffs.

In addition, increasing variation is a characteristic of one type of industries, as opposed to Schumpeter Mark I and Schumpeter Mark II sectors, as well as PLC-ILC sectors. The following insert summarizes the argument.

**Insert: Four stylized cases of industry evolution**

		Initial conditions	
		Concentrated	Dispersed
Long-term trend	Increased concentration	or	Schumpeter Mark II industries, following Malerba and Orsenigo, 1996 Cases: satellites, space launchers
	Increased dispersion	or	Cases: Semiconductors, solar PV technologies, computer and telecommunications equipment (variation-intensive industries following Niosi and Saviotti)
			Increasing returns industries (Kaldor-David-Arthur sectors) Cases: pharmaceutical drugs, computer software services (Schumpeter Mark I industries, following Malerba and Orsenigo, 1996) Cases: biotechnology R&D services, professional equipment manufacturing

Based on Niosi, 2000

### 3. SOME DEFINITIONS AND METHODOLOGY

#### 3.1. Definitions

In order to describe industry evolution in the most precise way, the following concepts are defined for the paper:

---User innovators are the companies who directly benefit from the use of the new technology. In our case, some firms produce solar PV cells, panels and other complementary equipment, but also conduct R&D and patent at least some of the results of their R&D investment. Thus companies such as Boeing, Canon, EXXON, or Siemens are user innovators. Public laboratories and universities, as well as specialised small and medium sized enterprises conducting research and patenting, or those that install panels for individual or industrial companies and do not conduct research are not user innovators. In our definition, users and manufacturers may coexist under the same roof and within the same enterprise (Block et al, 2016).

---Integrator: solar cells are the heart of the solar photovoltaic systems, but are not the final product for most users. Other companies integrate the solar PV technologies into their products (i.e. Solar panels) and then sell to the consumers via EPC (engineering, procurement and contractor) firms; these users include producers of solar roof panels, clocks, watches, pocket calculators, satellites, aircraft, mechatronics lightning equipment used in highways, telecommunications equipment and the like.

---Related diversification: the large companies usually spin-off dedicated firms to produce the solar PV products to the end consumers in other applications;

--Mass market: the end consumers are individuals and commercial organizations that buy solar panels for houses, industrial firms or highways; also, companies producing portable electronic products such as clocks, and pocket calculators.

--Niche market: the end consumers are in such special industries as aircraft, satellites, or other specific products.

--Specialized manufacturer: they are manufacturers just focusing on solar PV cell or solar panels manufacturing, without other focus or integration plan.

-- Feed-in-Tariffs (FIT); "A feed-in tariff (FIT) is an energy supply policy that promotes the rapid deployment of renewable energy resources. A FIT offers a guarantee of payments to renewable energy developers for the electricity they produce. Payments can be composed of electricity alone or of electricity bundled with renewable energy certificates. These payments are generally awarded as long-term contracts set over a period of 15-20 years." (US DoE, 2010) Those FIT are used not only to create incentives for the adoption of solar PV technologies, but also for wind and other renewable energies. They were adopted in Germany, Italy, Spain, Japan, and lately in China. In the USA, six states have implemented such tariffs.

### **3.2. Sampling and data collection**

In order to review the industry evolution of the solar PV industry in terms of innovation, the patent data in United States Patent and Trademark Office (USPTO) are employed as the sample selection criteria. The data in USPTO are selected because the United States assignees own nearly 50% of the solar PV patents, and innovators based in Japan, Germany, Taiwan or the Popular Republic of China also patent their inventions in the United States in order to protect them from potential infringers.

The key words selected for collecting the patents are the "solar cell", "solar cells", "photovoltaic cell" and " photovoltaic cells".

The samples are established in three categories:

1. The earliest assignees in the solar PV;
2. The top 10 biggest patent assignee companies; and
3. The top 10 biggest manufacturers specialized only in the solar PV cells and other solar system components such as solar high-tech glass, and solar energy storage systems.

For each samples in the above groups, we explore the information from their websites and the open information including the internet, the reports and the journals to find the major business, the solar PV business and their marketing positioning.

Table 3 shows that large firms (over 500 employees) dominate technology invention in the solar PV sector. This is true for all major metropolitan areas except for Taiwan, where the three largest clusters have the Industrial Technology Research Institute (ITRI) as the main owner of solar PV technology.

Since the 1980s, ITRI has become a major inventor in the area of semiconductors, and solar cells are specialized semiconductors. A capability ITRI developed in one sector of the microelectronics industry could be transferred to another sector of the same industry, for a different application.

**Table 3: Solar PV patents by metropolitan areas and type of assignee**

Metropolitan areas and prefectures	Large firm	Small firm	University	PROs	Individual inventors	Number of patents
Great S. Francisco	219	124	15	10	1	369
Greater L. Angeles	190	32	9	7		238
Greater Boston	77	27	21	1		126
Washington DC	6			88		94
New York, NY	70	8				78
Princeton, NJ,	50		5			55
Albuquerque, NM	52			2		54
Delaware Valley	38		14		1	53
Seattle	52			1		53
Dallas	43			2	3	48
Tokyo Pref.	216			1		217
Nara Pref.	209			1	1	211
Kanagawa Pref.	184		1	1	2	188
Kyoto Pref.	151			1		152
Osaka Pref.	105			2		107
Hyogo Pref.	73			2		75
Shiga Pref.	48					48
Munich	99	5	2	16		122
Frankfurt/Rhine	42					42
Seoul	128			15		143
Taipei	16		16	42		74
Taoyuan/Zhongli	7		3	32		42
Hsin-Chu	9		11	28		48
Total	2084	196	97	194	8	2637

Source; USPTO

## OUR HYPOTHESES

From the survey of these two major approaches about industry evolution, as well as authors considering variation in industry structure over time, we have drawn the following hypotheses.

**Hypothesis 1:** the decline in product innovation and the number of firms is not universal as argued by the PLC-ILC theory. In “variation-intensive sectors” (most science-based industries) the opposite is true (Niosi 2000). The number of products tends to increase over time, as new applications and new components appear, and economies of scope settle (See also, Saviotti, 1996)

**Hypothesis 2:** In SBIs, including the solar PV sector, product variety increases as new complementary

technologies enlarge the number of users and market niches. In science-based industries, variation is overwhelming. The new complementary technologies include mechatronics (i.e. sun-tracking devices), energy storage devices (accumulators, batteries), new high-tech solar glasses, new types of solar cells, and other related equipment, allowing buildings to switch from one type of energy (such as solar PV) to another such as grid provided electricity. New firms appear to grab these technical opportunities.

**Hypothesis 3:** Incentive policies have a major impact on the rate and direction of innovative activity in the sector. They come from public R&D laboratories, targeted policies such as FIT, and others.

Policies have generally been assigned a modest role in PLC-ILC theories, but they have a major one in sectoral innovation system models and historical descriptions of the growth of SBIS.

## RESULTS

Figure 1 shows the recent exponential growth of innovation in the solar PV sector. Such growth started in the 1990s and keeps on rising today. This growth is partly due to government incentives to solar PV adoption, but also the decline of solar equipment due to solar R&D in private firms, academic and public research organizations. The development of complementary technologies has made solar PV increasingly attractive.

**Table 2. Timetable for solar energy policies in the different countries**

\Country	Germany	Italy	Japan	USA
Year				
1991	1,000 PV Rooftop program			
1992				Energy Federal Policy Act
1994			Official launch of New Sunlight Plan	
1998	100,000 PV rooftop program			1,000,000 PV Rooftop program
2000	Renewable Sources Act	Energy	Green Procurement Law	
2001		10,000 PV rooftop program		
2002			Law on new energy for power generation	
2004	Revised Act on Renewable Energy Law			



2005		Conto Energia, 1st version	Revised Energy Law
2007		FIT introduced Conto Energia, 2nd version	
2008	Newly Revised Act on Renewable Energy Law		PV industry Subsidy policy restarted
2010		Conto Energia, 3rd version	10,000,000 PV rooftop Program
2011	Decreased Feed-in Tariff for 3 times	Conto Energia, 4th version	Renewable energy Law
2012		Conto Energia, 5th version	FIT introduced
2013		Abolition of Conto Energia, 5th version	

**Figure 1: Solar cell publications and US patents granted by year, 1954-2013**

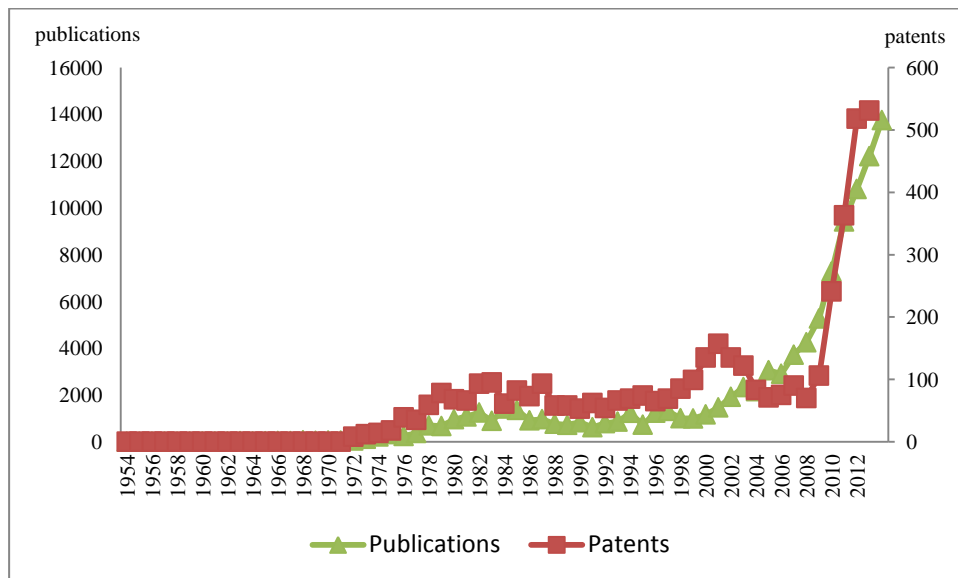

Source: Scopus & USPTO

We have found different uses of solar PV technologies in an increasing number of products such as

- Satellites, aircraft,
- Oil and gas offshore production facilities
- Calculators, watches, and other portable products
- Flat roof rigid panels for individual houses or industrial plants
- Sun-tracking solar systems using mechatronics

- Grid-connected systems (solar parks, photovoltaic power stations)
- Green solar cities
- Emerging technologies
  - Concentrator photovoltaics
  - Floatovoltaics
  - Grid integration systems
  - High-tech glass
  - Solar energy storage

The solar sector thus includes several different industries, and is characterized by large variation, and increasingly complex products. If at the origins, solar panels were covered with ordinary glass, were fixed and unable to track sun movements, today they are becoming increasingly complex products incorporating high-tech glass, mechatronics, and sophisticated inverters transforming direct current into alternate current. Most of these products are supported by the state through national research institutes, academic research, FIT, and the usual panoply of financial support of OECD and emerging country governments for R&D and innovation.

## CONCLUSION

We have put together different pieces of research that analyse the evolution of a new sector. The most cited, and decades-old one, is the PLC-ILC approach, proposed in the 1960s by Raymond Vernon at Harvard University and developed by Steve Klepper at Carnegie Mellon in the 1990s. Both see products being launched in the richest countries where the first imitators also grow. These new products consequently adjust themselves to market conditions, through innovation until a dominant design emerges. At this moment, product innovation starts receding while process innovation increases. The new product is exported to less affluent countries where a second cohort of imitators appears. Economic concentration rises and large firms dominate the industry. The entire industry tends to be delocalized to emerging countries where costs are lower than in the original innovating country. The solar PV sector is also being delocalized towards Asia (China, South Korea and Taiwan). Yet, the sectoral innovation system proposed by Malerba (2002) and by Malerba and Orsenigo (1996) argues that the institutions, the markets and the technological conditions under which they are born shape sectors. Thus the history-friendly models proposed by Malerba and Orsenigo do not contradict the PLC-ILC approach, but add an important element: the role of governments in the shaping of the process.

Also, most often sectors are seldom composed by just one industry or one product. The solar PV sector involves a large number of industries from semiconductors to glass, mechanical and other.

In addition, several authors (Niosi, 2000; Saviotti, 1996) have noted the phenomenon of rapid product variation, a phenomenon that does not disappear in science-based industries and sectors, as argued by the PLC-ILC approach, but on the contrary, increases over time, and so does product innovation. Also, product variation induces growth by the expansion of industries (Metcalf et al, 2006), that translates into aggregate economic growth. Finally, Saviotti and Pyka (2004) argued that economic growth occurs most often by the creation of new sectors. The solar PV sector is a brand new one composed by several industries.

## REFERENCES

- Abernathy, W.J., Utterback, J.M. (1978): "Patterns of innovation in technology", *Technology Review*, 80 (7): 1–47.
- Block, J., J. Henkel, T. G. Schweisfurth, A. Stiegler (2016): "Commercializing user innovations by vertical diversification: the User-Manufacturer innovator", *Research Policy*, 45: 244-259.
- Flamm, K. (1988): *Creating the computer: government, industry and high technology*, The Brookings Institution, Washington, D.C.
- Geels, F. W., (2004): "From sectoral systems of innovation to socio-technical systems: Insights about dynamics and change from sociology and institutional theory", *Research Policy*, 33: 897-920.
- Geroski, P.A. (2003): *The Early Evolution of Markets*, Oxford University Press, New York.
- Han, X., Niosi, J (2015): "Star scientists in PV technology and the limits of academic entrepreneurship", *Journal of Business Research* 69 (5); 1707-1711.
- Klepper, S. (1996): "Entry, exit, growth and innovation over the product life cycle. *American Economic Review* 86, 562–583.
- Klepper, S. (1997): "Industry life cycles", *Industrial and Corporate Change* 6, 145–181.
- Liao, S.W., Xu, H.J. (2012): "Comparison the governmental policies for PV industry, regional and industrial economics", *China Business, Economic Theoretical Research*, 11: 15-17
- Malerba, F. (2007). *Innovation and the dynamics and evolution of industries: Progress and challenges*. *International Journal of Industrial Organization*, 25(4), 675-699
- Malerba F., Orsenigo L. (1996): "The dynamics and evolution of industries", *Industrial and Corporate Change* 5(1): 51–88.
- Malerba, F., Nelson, R., Orsenigo, L., Winter, S. (1999): "History friendly models of industrial evolution: the computer industry", *Industrial and Corporate Change* 1, 3–41.
- Malerba, F., Nelson, R., Orsenigo, L., Winter, S., 2001: "Competition and industrial policy in a history friendly model of the evolution of the computer industry" *International Journal of Industrial Organization* 19, 635–664.
- Malerba, F., Orsenigo, L., 2002: "Innovation and market structure in the dynamics of the pharmaceutical industry and biotechnology: towards a history friendly model", *Industrial and Corporate Change* 11 (4), 667–703.
- McMillan, G. S., F. Narin and D. L. Deeds (2000) *An analysis of the critical role of public science in innovation: the case of biotechnology*. *Research Policy*, 29: 1-8.s
- Metcalf, J.S., Foster, J., R. Ramiogan (2006): "Adaptive economic growth", *Cambridge Journal of Economics*, 30 (1): 7-32.
- Mowery, D. (Ed.)(1996) *The International Computer Software Industry. A Comparative Study of Industry Evolution and Structure*, Oxford and New York, Oxford University Press.
- US Department of Energy (2010): *The history of solar*, 12 pages. [https://www1.eere.energy.gov/solar/pdfs/solar\\_timeline.pdf](https://www1.eere.energy.gov/solar/pdfs/solar_timeline.pdf)
- Nelson, R. R. (2005) *Technology, Institutions and Economic Growth*, Cambridge, MA, Harvard University Press.
- Niosi, J. (2000): "Science-based industries: a new Schumpeterian taxonomy", *Technology in Society*, 22: 429-444.
- Niosi, J. (2010): *Building national and regional systems of innovation*, Cheltenham, Elgar.
- Niosi, J., Reid, S. E. (2007): "Biotechnology and nanotechnology: science-based industries as windows of opportunity for LDCs?" *World Development*, 35 (3) 2007: 426-438.
- Perlin, J. (2002): *From Space to Earth. The History of Solar Electricity*, Harvard University Press, Cambridge, MA.

- Rocco, M. C., Bainbridge, W. S. (2005): "Societal implications of nanoscience and nanotechnology: maximizing human benefit", *Journal of Nanoparticle Research*, 7: 1-13.
- Sahu, B. K. (2015): "A study on global solar PV energy developments and policies with special focus on the top ten solar PV power producing countries", *Renewable and Sustainable Energy Reviews*. 43(6), 621–634.
- Saviotti, P.P. (1996): *Technological Evolution, Variety and the Economy*, Elgar, Cheltenham, Chapter 5.
- Saviotti, P.P., Pyka, A. (2004): "Economic growth by the creation of new sectors", *Journal of Evolutionary Economics*, 14: 1-35.
- Utterback, J.M. (1994) *Mastering the Dynamics of Innovation*. Harvard Business School Press, Boston, MA.
- Von Hippel, E. (2005): *Democratizing innovation: The evolving phenomenon of user innovation*, The MIT Press, Boston, MA.
- Whitley, R. (2003): "Competition and pluralism in the public sciences: the impact of institutional frameworks on the organization of academic science", *Research Policy*, 32 (6): 1015-1029.

## APPENDIX

**Table 1: Four periods in the development of the solar PV technology**

Period	Years	Most innovative nation	Most innovative organizations	Cases
The birth of the technology	1950s- 1960s	United States	Dedicated solar cell producers	Hoffman Co., and Communications Satellite Corp.
The first commercial applications	1960s-1970s	United States, Germany, Japan	Mainly users- manufacturers, but also public labs and universities	Canon, Seiko, Sharp, Toshiba (JP), ARC, Boeing, Exxon, RCA Texas Instruments (USA), Telefunken (DE)
Large scale applications	1980-1990	United States, Germany, Japan	User innovators manufacturers, dedicated solar equipment manufacturers; Public labs and universities	MiaSole, Solarex, Solopower SunPower Corp.
Wide adoption of solar PV and entry of new component innovators	2000->	United States, Germany, Japan South Korea, China, Taiwan	User innovators manufacturers, Dedicated solar equipment firms. Public labs and universities	First Solar, Solo Power, Solarex, Evergreen Solar, Solaria (US), Samsung, LG (SK), Canon, Sharp, Toshiba (JP)

**Table 5. The inventors of the solar cell technologies till 1976**

Patent assignees till 1976	Year of the first patent in solar cell	Founded Year	Specialized industry	Roles in the industry	Number of patents till 1976
Lockheed Martin	1972	1912	Aerospace	Integrator	1
Rockwell International	1972	1928	Mechanical engineering & aircraft & satellite	Integrator	1
Communications Satellite	1973	1962	Satellite	User	12
Raytheon	1973	1922	Defense contractor	Integrator	9
Motorola, Inc.	1973	1928	Telecommunications	Integrator	2
Toshiba	1974	1875	Electrical Equipment	Integrator	2
Seiko Group	1974	1881	Instrument, watch	Integrator	2
US Government labs	1975	1975	R&D	User	7
Dow Corning Corporation	1975	1943	Chemicals, silicon derived polymers	Integrator	3
RCA Corporation	1976	1919	Electronics (ceased operation in 1986)	Integrator	5
Texas Instruments Incorporated	1976	1951	Electronics, semiconductors	Integrator	3
Alcatel-Lucent	1976	1872	Telecommunications equipment	Integrator	2
Hughes Aircraft Company	1976	1932	Aerospace and defense	Integrator	2
Bell Lab	1976	1925	Telecommunication	Integrator	2
The Boeing Company	1976	1916	Airplanes, rockets and satellites	Integrator	1
General Electric	1976	1892	Power generation	Integrator	1
Dresser Industries, Inc.	1976	1880	Energy and resources	Integrator	1
Westinghouse Electric	1976	1886	Nuclear power company	Integrator	1

**Table 6. Top 10 patents assignees and specialized mass-market manufacturers**

Top 10 User firms in terms of patents in solar PV	Number of patents in solar PV until 2013		Top 10 solar PV firms in terms of patents in solar PV	Number of patents in solar PV until 2013
Canon	207		SunPower Corp.	64
Sharp	91		SoloPower, Inc.	46
Samsung Group	84		MiaSole	26
Applied Materials	81		Solarex Corp.	21
E. I. du Pont de Nemours	78		Evergreen Solar	13
Boeing	65		Mobil Solar Energy Corp.	12
Mitsubishi Group	64		Solexel	12
Siemens, AG	63		Solyndra	9
Sanyo Electric Co.	63		Solaria Corp.	8
Raytheon	52		Stion Corp.	6

Source: USPTO

## **BOOK OF CONFERENCE ABSTRACTS**



## IC AND ENABLING FACTORS FOR STARTUPS IN A BUSINESS ECOSYSTEM PERSPECTIVE

**Abbate, Tindara<sup>1</sup>; Accordino, Patrizia<sup>2</sup>; La Rocca, Elvira Tiziana<sup>1</sup>; Rupo, Daniela<sup>1</sup>**

<sup>1</sup>Department of Economics, University of Messina, UNIME, Messina, Italy

<sup>2</sup>Department of Political and Juridical Sciences, University of Messina, UNIME, Messina, Italy

### ABSTRACT

The creation and development of startups have been the focus of scientific contributions aimed to explore and identify the key success factors having a significant impact on their creation, survival and performance (e.g., Gilmore et al., 2004; Schutjens and Wever, 2000; Watson et al., 1998).

Considering the areas that in the earlier years have achieved the best results in the birth and the development of innovative startups, we can identify several factors responsible for the success or the failure of new ventures. Some of these factors are related to the capability of the entrepreneur to attract, combine and develop IC. A more comprehensive analysis, however, should consider the external conditions which can influence (positively or not) the environment chosen to root and to start a new business.

External conditions can be investigated adopting the perspective of business ecosystems. Moore (1993) creates the term “business ecosystem” and Iansiti and Levien (2004) underline that “*like biological ecosystems, business ecosystems are formed by large, loosely connected networks of entities. Like species in biological ecosystems, firm interacts with each other in complex ways, and the health and performance of each firm is dependent on the health and performance of the whole. Firms and species are therefore simultaneously influenced by their internal capabilities and by their complex interactions with the rest of the ecosystem.*” (p. 35).

Startups can contribute to economic growth through different ways, such as diverse innovation paths/processes, new technologies and know-how, original resource combinations, new entrepreneurial culture and new competencies and capabilities (Malone, 2003; Wong et al., 2005). In fact, these factors are assuming a relevant role in entrepreneurship and innovation, helping to job creation, technological progress, high level of creative work, internationalization and alternative forms of employment (ESM, 2016).

Exploring IC in the business ecosystem perspective, the paper intends to examine the roles and the contributions of several “enabling” factors, which can differently influence the creation and development of innovative startups. The most significant of these are the commitment of institutions and organizations that are able to sharpen the skills relevant for new entrepreneurship; simplification

of rules and granting incentives; enhancing the intellectual capital of entrepreneurship and accessible financing methods.

The adopted perspective is coherent with the conclusions of a public consultation launched by the European Union summarized in the *Startup and Scale up initiative* that has identified which enabling factors the Member States could enforce to realize a suitable business ecosystem, supporting the growth and the development of innovative startups.

By exposing a theoretical framework this paper intend to derive some relevant implications for management, to strengthen and improve the main enabling factors, and for policy makers, to encourage and sustain new entrepreneurship.

*Keywords: startups, business ecosystem, enabling factors, new entrepreneurship, incentives, patent box, inspiring entrepreneurs, educational institutions, financing methods.*

## REFERENCES

- Autio E., Kenney M., Mustar P., Siegel D.A., & Wright, M. (2014). Entrepreneurial innovation ecosystems and context. *Research Policy*, 43(7), 1097-1108.
- Bagarotto E.M. (2015), Considerazioni critiche sul regime fiscale delle start-up innovative, *Diritto e pratica tributaria*, 535-552.
- Boria P., (2014), *European tax law: institutions and principles* Milano, Giuffrè. 177-192.
- Bates T. (1990). Entrepreneur Human Capital Inputs and Small Business Longevity, *The Review of Economics and Statistics*, Vol. 72, No. 4, pp. 551-559.
- Davenport, T. H. (2006). Competing on analytics. *Harvard Business Review*. 84, 1, 98.
- Elert N., Henrekson M. & Stenkula M., (2017) Institutional reform for innovation and entrepreneurship. An agenda for Europe, *Springer Briefs in Economics O.A.*, from <http://www.springer.com/series/8876> 25-86.
- European Commission (2016 - 733 Final) Communication from the Commission to the European Parliament, the Council, the European Economic and Social Committee and the Committee of the Regions, Strasbourg. from <http://eur-lex.europa.eu/legal-content/EN/>.
- Iansiti, M., & Levien, R. (2004). *Keystones and dominators: Framing operating and technology strategy in a business ecosystem*. Harvard Business School. Boston.
- Lindholm Dahlstrand A. & Stevenson L. (2010) Innovative entrepreneurship policy: linking innovation and entrepreneurship in a European context, *Annals of Innovation & Entrepreneurship*, 1: 5602 - DOI: 10.3402/aie.v1i1.5602.
- Mason C., & Brown, R. (2014). *Entrepreneurial Ecosystems and Growth Oriented Entrepreneurship*. OECD, 1–38. Retrieved from <https://www.oecd.org/cfe/leed/Entrepreneurial-ecosystems.pdf>.
- Morris L.H, & Liguori E. (2016). *Annals of Entrepreneurship Education and Pedagogy*. Edward Elgar Publishing, Cheltenham, pp. 1–419: UK, Northampton, MA, USA.
- Peltoniemi, M. (2005). *Business ecosystem: a conceptual model of an organization population from the perspectives of complexity and evolution*. Tampere: e-Business Research Center. Research Reports.
- Piantavigna P. (2014), Start up innovative e nuove fonti di finanziamento, *Rivista di Diritto Finanziario e Scienza delle Finanze*, 264 -275.
- Rui Baptista R., Karaöz M., Mendonça J. (2014). The impact of human capital on the early success of necessity versus opportunity-based entrepreneurs. *Small Business Economics* 42, 831–847.
- Siegel, D. S., Wessner, C. (2012). Universities and the success of entrepreneurial ventures: Evidence from the Small Business Innovation Research Program. *Journal of Technology Transfer*, 37(4), 404-415.
- Stewart, T.A. (1997), *Intellectual Capital. The new wealth of organizations*, London.
- Vicini Ronchetti Alessandro (2016)  
European rules and tax incentives to the development of the patents: first considerations on the "patent box".

Rassegna

tributaria

fasc. 3 671 - 697

Wang, X.A., & Wan, W.P. (2013). Explaining the Variance in Underpricing among Venture Capital-Backed IPOs: a Comparison Between Private and Corporate VC Firms. *Strategic Entrepreneurship Journal*, 7(4), 331-342.

Watson, K., Hogarth-Scott, S., & Wilson, N. (1998). Small Business Start-ups: Success Factors and Support Implications. *International Journal of Entrepreneurial Behaviour and Research*, 4, 3, 217-238.

Wilson, K.E., & Silva, F. (2013). Policies for Seed and Early Stage Finance: Findings from the 2012 OECD Financing Questionnaire, *Technology and Industry Policy Papers*, n. 9, Organisation for Economic Cooperation and Development.

## MARKET DOCTRINE (MD), CREATIVITY, AND NEW PRODUCT PERFORMANCE IN INTERNATIONAL MARKETS

Abboud, Amer; Shoham, Aviv

Department of Business Administration, University of Haifa, Haifa, Israel

### ABSTRACT

Market doctrine (MD) is a relatively new concept in the marketing literature. When first introducing, Challagalla, Murtha, and Jaworski (2014; CMJ hereafter) defined MD as "a firm's unique principles, distilled from its experiences, which provide firm-wide guidance on market-facing choices" (p. 4). Thus, MD ensures consistent decisions across firms' departments. MD's importance was recognized by the *Journal of Marketing*, which bestowed the 2014 Harold H. Maynard Award on the authors, citing their paper as the most significant contribution to marketing theory and thought of that year.

CMJ viewed marketing creativity as an outcome of MD. Such creativity, in tandem with new product creativity, is an antecedent of new product performance (Im and Workman 2004). Thus, given that MD is a new concept with a potential impact on the success of new products, it is important to study this relationship.

### RESOURCE BASED VIEW

According to the resource-base-view (RBV), a firm can achieve a sustainable competitive advantage (SCA) by controlling resources that are rare, valuable, inimitable, non-tradable, and non-substitutable, as well as firm-specific (Barney 1999).

### MARKET DOCTRINE

MD provides guidelines to firms that face marketing challenges. It constitutes a common firm-wide approach for marketing-related decision-making. When firms use them, employees tend to rely on MDs' guidance rather than on personal tendencies, cultural customs, or ideologies (Bailey and Maltzman 2008). CMJ described MD as four sets of principles. Principles should (1) be firm-specific (2), be experienced-based, (3) guide firm-wide marketing decision-making, and (4) include market-facing choices.

Four elements contribute to the development of MD. The first is international diversification, Related-product, decentralization of marketing authority, and decentralization of marketing activities. Regarding MD's consequences, it improves the consistency of decision-making processes and leads to enhanced marketing-program creativity, reduced marketing impulsivity, enhanced perceived value of

marketing, and better international performance.

## NEW PRODUCT CREATIVITY (NP CREATIVITY)

New product innovation (creativity) was identified as "the key to firms' marketplace success, profit and survival" (O'cass and Sok 2014, p. 156). NP creativity enables firms to develop new products in response to changes in customer needs *and* to continuously create and embed enhanced value in their products (Ngo and O'Cass 2009). Therefore, continuous renewal of market offerings (in the form of NPs) is required in order to achieve market superiority. NP creativity provides a platform for the development of new products with beneficial attributes that closely matches customers' needs, resulting in superior performance (Kohli and Jaworski 1990; Shoham 2002; Slater and Narver 1995).

## NEW PRODUCT PERFORMANCE (NPP)

New product performance is an outcome of creative processes (Calantone and Cooper 1981). Im and Workman (2004) renamed NPP as NP success, which can be viewed as leading to better market (relative market share, relative sales) and financial outcomes (relative return of investment; in general, profits, market share, sales, return on investment, relative profitability) (Cavusgil and Zou 1994), as well as to customer satisfaction (Andrews and Smith 1996).

## SUMMARY

The discussion above leads to a model flowing from MD to Creativity and New Product Performance.

The model is depicted below.

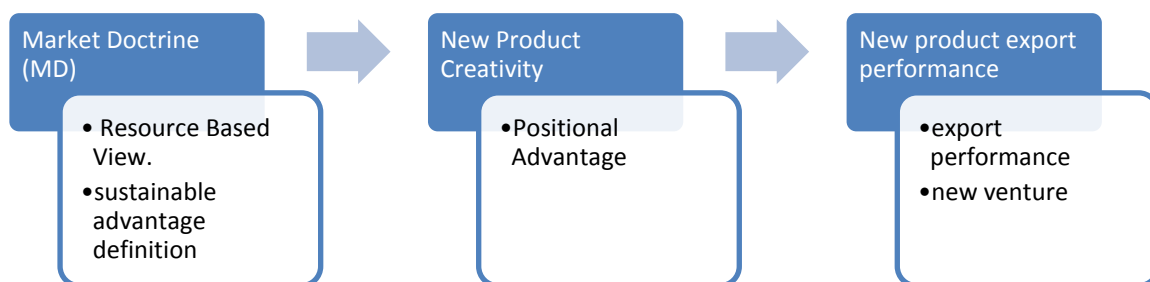

*Keywords: Resource Based View, Market Doctrine, New Product Creativity, New Product Performance*

## REFERENCES

- Andrews, Jon Lee and Daniel C. Smith (1996), "In Search of the Marketing Imagination: Factors Affecting the Creativity of Marketing Programs for Mature Products," *Journal of Marketing Research*, 23 (2), 174–87.
- Bailey, Michael Adam and Forrest Maltzman (2008), "Does Legal Doctrine Matter? Unpacking Law and Policy Preferences on the U.S. Supreme Court," *American Political Science Review*, 102 (3), 369–84.

- Barney, Jay B. (1999), "How a Firm's Capabilities Affect Boundary Decisions," *Journal of Management*, 40 (3), 137–45.
- Calantone, Roger J. and Robert G. Cooper (1981), "New Product Scenarios: Prospects for Success," *Journal of Marketing*, 45 (2), 48–60.
- Challagalla, Goutam, Brian R. Murtha, and Bernard Jaworski (2014), "Marketing Doctrine: A Principles-Based Approach to Guiding Marketing Decision-Making in Firms," *Journal of Marketing*, 78 (4), 4–20.
- Im, Subin and John P. Workman, Jr. (2004), "Market Orientation, Creativity, and New Product Performance in High-Technology Firms," *Journal of Marketing*, 68 (4), 114–38.
- Kohli, Ajay K. and Bernard Jaworski (1990), "Market Orientation: The Construct, Research Propositions, and Managerial Implications," *Journal of Marketing*, 54 (4), 1–18.
- O'Cass, Aron and Liem Ngo (2009), "Achieving Customer Satisfaction via Market Orientation, Brand Orientation, and Customer Empowerment: Evidence from Australia," *Australian and New Zealand Marketing Academy, conference paper*
- Shoham, Aviv and Gregory M. Rose (2002), "Export performance and Market Orientation: Establishing an Empirical link," *Journal of Business Research*, 55 (3), 217–25.
- Slater, F. Stanley and John C. Narver (1995), "Market Orientation and the Learning Organization," *Journal of Marketing*, 59 (3), 63–74.
- Sok, Phyra and Aron O'Cass (2014), "The Role of Intellectual Resources, Product Innovation Capability, Reputational Resources and Marketing Capability Combinations in Firm Growth," *International Small Business Journal*, 32 (8), 996–118.
- Zou, Shaoming, Charles R. Taylor and Gregory E. Osland (1998), "The EXPERF Scale: A Cross-National Generalized Export Performance Measure," *Journal of International Marketing*, 6 (3), 37–58.

# DEROGATION EFFECT OF USING SUCCESSFUL VERSUS ATTRACTIVE SPOKESPERSON IN ADVERTISING: A COMPARATIVE STUDY BETWEEN THE NETHERLANDS AND BRAZIL

Adıgüzel, Feray<sup>1</sup>; Buranello, Renata<sup>2</sup>

<sup>1</sup>Department of Business and Management, LUISS Guido Carli University, Rome, Italy

<sup>2</sup>Consumer Marketing Skincare at Philips, Amsterdam, The Netherlands

## ABSTRACT

This research focuses on comparison of derogation effects of using successful versus attractive male spokesperson in advertising on male consumers in two culturally different countries -Netherlands and Brazil. According to the results, when a male consumer compares himself to attractive male spokespersons, the attitude towards the ad is significantly positive; when he compares himself to successful male spokespersons, the attitude toward the ad is significantly negative. Thus, men who compare themselves with a successful spokesperson do show a similar derogation effect as women who compare themselves with an attractive model. This is not the case for men who compare themselves with an attractive spokesperson. Brazilians showed more negative attitude towards the ad than the Dutch did if they compare themselves to a spokesperson. However, among non-comparers, Brazilians were more positive towards all ads than the Netherlands were. Therefore, the derogation effect occurs for Brazilians among comparers, but not among non-comparers.

## INTRODUCTION

Message delivered by a physically attractive source will tend to be more persuasive than the one by a less physically attractive source (Petty et al. 1983). However, the use of highly attractive spokespersons might backfire (Bower, 2001): the use of highly attractive models in an ad leads to derogation of the ad and of the brand. The reason was explained by the social comparison theory (Festinger, 1954). According to this theory, consumers compare themselves with idealized advertising images. The idealized images in ad raise the individuals' comparison standards for attractiveness and lowers satisfaction with their own attractiveness (Richins, 1991). This lower satisfaction leads to negative attitude towards the ad, resulting in lower purchase intention (Bower, 2001). However, Bouwer's study included only females and mixed results stemming from comparison to highly attractive models on advertising effectiveness. That is why we want to retest the effects of exposure to attractive models in ads on ad effectiveness for males. Besides, we wonder how using a successful male spokesperson influences ad effectiveness and which derogation effect –attractive versus successful male spokesperson needs an attention of companies. Gulas and McKeage (2000) found that

exposure to advertising containing idealized images of financially successful males reduced male viewers' level of self-esteem. However, this study investigated only negative effects in terms of self-perceptions, but not advertising effectiveness. More importantly, they did not investigate whether exposure to an attractive versus successful spokesperson causes higher derogation. That is what the contribution of this study to marketing knowledge.

Success plays an important role in how men see themselves. Whilst men select their partners based on physical attractiveness, women select partners based on their social power and their financial ability (Willis and Carlson, 1993). Therefore, financial success can be considered an important feature of males. Moreover, besides attractiveness, social status among boys is also associated with high expected earning power (Dong et al., 1996). This leads to wondering whether financial success is for men what attractiveness is for women.

On top of these, we compare the derogation effects in two culturally different countries: Brazil and the Netherlands. There are two main reasons of these choices. First, globalization has increased the importance of understanding whether the same advertising strategies of developed economies can be also used in emerging economies. So far, a few studies indicate that consumers from economies in transition have different attitudes regarding advertising than do consumers from developed countries (Feick and Gierl, 1996). With respect to advertising the influence of cultural differences is very pervasive since "as a form of social communication, advertising is considered to be particularly reflective of culture" (Hong et al., 1987). Second, these two countries are strikingly different in terms of Hofstede cultural dimensions. Brazil is more collective, masculine country with higher power distance. All these dimensions can reflect on how people view a successful person and it is therefore expected that Brazilian consumers exhibit higher levels of derogation toward a successful person in an ad than Dutch consumers.

The research objective is therefore to investigate the level of derogation effect caused by exposure to a successful versus an attractive male spokesperson while controlling social comparison. Additionally, cross-country differences of consumers towards an ad with a specific spokesperson will be investigated. This will be useful for companies when deciding whether to adapt a specific ad to a different culture or to change it completely. The results of this research will make it possible to know which type of spokesperson will be more effective for an ad, and thus the type of spokesperson that can generate higher likability and success for the ad.

## **METHODOLOGY**

Four fictional ads were created: 1) a successful and attractive male spokesperson, 2) a successful and non-attractive male spokesperson, 3) a non-successful but attractive spokesperson, and 4) an average



looking and not successful spokesperson. The participants were exposed to one ad of four experimental conditions randomly (2x2 between-subject design). The data was gathered with an online survey from only males. A total of 257 respondents, 131 Dutch and 126 Brazilians, were used in the analyses.

## FINDINGS

The empirical findings indicate when a male consumer compares himself to an attractive male spokesperson, ad attitude is significantly positive; when he compares himself to a successful male spokesperson, ad attitude is significantly negative. Thus, men who compare themselves with a successful spokesperson do show a similar derogation effect as women who compare themselves with an attractive model. This is not the case for men who compare themselves with an attractive spokesperson. Brazilians indicate more negative ad attitude than the Dutch do if they compare themselves to a successful spokesperson. However, Brazilians are more positive towards all ads than the Netherlanders among non-comparers. So, the derogation effect occurs for Brazilians among comparers, but not among non-comparers.

*Keywords: Attractive/Successful spokesperson, Social Comparison, Derogation effect, Cultural Differences, Advertising Effectiveness*

## REFERENCES

- Bower, A. (2001) "Highly Attractive Models in Advertising and the Women Who Loathe Them: The Implications of Negative Affect for Spokesperson Effectiveness," *Journal of Advertising*, Vol. 30, No. 3, pp. 51-63.
- Dong, Q., Weisfeld, G., Boardway, R.H. and Shen, J. (1996) "Correlates of Social Status Among Chinese Adolescents," *Journal of Cross-Cultural Psychology*, Vol. 27, No. 4, pp. 476
- Festinger, L. (1954) "A Theory of Social Comparison Processes," *Human Relations*, Vol. 7, No. 2, pp. 117-140.
- Feick, L. and Gierl, H. (1996) "Scepticism about advertising: A comparison of East and West German consumers," *International Journal of Research in Marketing*, Vol.13, No.3, pp.227-235.
- Hong, J. W., Muderrisoglu, A. and Zinkhan, G.M. (1987) "Cultural differences and advertising expression: a comparative content analysis of Japanese and US magazine advertising," *Journal of Advertising*, Vol. 16, No. 1, 55-62
- Gulas, C. and McKeage, K. (2000) "Extending Social Comparison: An Examination of the Unintended Consequences of Idealized Advertising Imagery," *Journal of Advertising*, Vol. 29, No. 2,17-28.
- Petty, R. E., Cacioppo, J.T. and Schumann, D. (1983) "Central and Peripheral Routes to Advertising Effectiveness: The Moderating Role of Involvement," *Journal of Consumer Research*, Vol. 10, No. 2, pp. 135-146.
- Richins, M. (1991) "Social Comparison and the Idealized Images of Advertising," *Journal of Consumer Research*, Vol. 18, No. 1,71-83.
- Willis, F. and Carlson. R. (1993) "Gender, Social Class, and Time," *Sex Roles*, Vol. 29, pp. 387-404

## INTERNATIONAL DIFFERENCES IN SPORT EVENT SPONSORSHIP EFFECTIVENESS

Adıgüzel, Feray<sup>1</sup>; Kennett, Christopher<sup>2</sup>

<sup>1</sup>Dept. of Business and Management, LUISS Guido Carli University, Rome, Italy

<sup>2</sup>Dept. of Technology Management, LaSalle-Universitat Ramon Llull, Barcelona, Spain

### ABSTRACT

Major sports events such as the Olympic Games and FIFA World Cup have achieved global reach through extensive media coverage and the involvement of multinational sponsors. Sports provide a highly attractive mix of drama, emotion and information that attract very loyal customers: sports fans. The need to engage sports fans in meaningful ways that involve sponsors has been an ongoing focus of sports marketing research. However, relatively few studies have focused on how the effectiveness of sport event sponsorship might differ internationally and across national cultures.

Our field-based study offers an important extension to current research. Specifically, we conducted an international survey of Euroleague Basketball's fans and gathered data from 4365 respondents across ten European countries to identify country-specific patterns. The questions in the survey included fan demographics, behaviour, opinions and attitudes towards sponsors. We conducted multilevel modelling using individual and country level variables and investigated the determinants of sponsorship effectiveness, namely brand affect, and the differences among them.

The findings indicated the positive effect of perceived fit, sponsor brand familiarity, attitude sponsorship, brand association, event involvement, the success of fan's team, the number of traditional media used to follow games, and finally product/brand category usage on brand affect. Team loyalty, sport involvement, age and gender have a negative effect on brand affect. From our findings, when sport involvement and team loyalty increase, brand affect decreases. When a sport consumer uses traditional media to follow the Euroleague, brand affect increases. Interestingly, we did not observe the same effect for new media. There were differences in the effects of perceived fit and brand familiarity across countries. When country's indulgence increased, brand affect also increased while the opposite effect was observed for masculinity. There were significant differences in brand affect across ten countries based on fixed effect model. We further explain cross-cultural differences in sponsorship effectiveness and additionally provide several implications for marketers.

### INTRODUCTION

Major sports events have become an integral part of the global entertainment industry through increasing exposure through multiple media channels. These events, such as the Olympic Games and

FIFA World Cup or the regular fixtures in the NBA or English Premier League, are used by commercial sponsors to reach large live audiences and clearly defined customer segments as part of wider marketing and communication strategies. Worldwide spending on sport sponsorship has reached to \$62.8 billion in 2017, and along with the sales of media rights is one of the key revenue streams for sports organizations (IEG, Statista, 2017). Sponsorship in sports has been the focus of numerous studies, many of which focus on consumers' ability to recall sponsors' brands and the Return On Investment (ROI) that sponsorship provides sponsors (Deitz et al., 2013). The literature to date reveals a concern for the relative effectiveness of sponsorship as a promotional strategy and whether the high priced deals at the top end of the industry provide value for money. However, the effectiveness of sports sponsorship in terms of cross-cultural comparison has received little attention by scholars to date. Indeed, sports marketing research literature have mainly focused on the antecedents of effectiveness which can be listed as: perceived sponsorship fit (Simmons and Becker-Olsen, 2006); attitude toward sponsorship (Meenaghan and Shipley, 1999); sport involvement (Gwinner and Bennett, 2008); familiarity with the sponsoring brand (Chanavat and Martinet, 2009). Although sponsorship has attracted a lot of interest in the academic world so far, research of sponsorship effectiveness concerning multiple countries is rare up to this point (Meng-Lewis et al., 2013; Lee and Mazodier, 2015; Séguin et al., 2005). Most studies concentrate on the domestic region of the sponsored property (i.e. the country where an event is hosted or where a team comes from) and limited to generalizability.

Our study is based on a sample of 4365 respondents from an international survey of Euroleague Basketball's fans conducted in 2015 and provides new insights on: 1) sponsor equity in terms of brand affect in ten different countries in an international sports league, and 2) the role of several antecedents of sponsor equity (perceived fit, sponsor brand familiarity, involvement with the event, sport, and team, attitude towards sponsor, the success of fan's team, traditional/new media, product/brand usage, age and gender) in an international sponsorship. The study was conducted in the context of the Euroleague Basketball, which is the leading professional basketball competition in Europe comprising teams from up to eighteen countries. The findings provide insights for sponsors and sports organizations and inform decision-takers as to the level of standardization of their sponsorship-linked marketing communications by revealing to which extent consumers' attitudes to and perceptions of sponsorship differ between countries.

We conducted multilevel modelling using individual and country level variables and compared the results to fixed/random effect and multiple linear regression analysis. We observed significant differences in brand affect across ten countries using fixed effect model. Using the multilevel model, we concluded that there are differences in effects of perceived fit and brand familiarity across ten

countries. When Hofstede's culture dimension "masculinity" increased, brand affect decreased. However, when indulgence increased, brand affect also increased. The most important variable explaining brand affect was perceived fit. The significant positive effects on brand affect were perceived fit, sponsor brand familiarity, attitude sponsorship, brand association, event involvement, the success of fan's team, the number of old media to follow games, sponsor brand category usage. The negative effects on brand affect were team loyalty, sport involvement, age and gender. That is, when sport involvement and team loyalty increases, brand affect decreases. While the usage of traditional media increased brand affect, interestingly we did not observe the same effect for new media.

*Keywords: Sponsorship, brand affect, cross-cultural, fit, brand familiarity, involvement, new media, multilevel model, masculinity, indulgence*

## REFERENCES

- Chanavat, N., and Martinet, G. (2009), "Sponsor and sponsees interactions: Effects on consumers' perceptions of brand image, brand attachment, and purchasing intention", *Journal of Sport Management*, Vol. 23, No. 5, pp. 644-670
- Gwinner, K., and Bennett, G. (2008), "The impact of brand cohesiveness on brand fit in a sponsorship context", *Journal of Sport Management*, Vol. 22, pp. 410-426.
- Meenaghan, T., and Shipley, D. (1999), "Media effect in commercial sponsorship", *European Journal of Marketing*, Vol. 33, No. 3/4, pp. 328-347
- Simmons, C. J., and Becker-Olsen, K. L. (2006), "Achieving marketing objectives through social sponsorships", *Journal of Marketing*, 70, pp. 154-169
- Meng-Lewis, Y., Thwaites, D., and Pillai, K.G. (2013), "Consumers responses to sponsorship by foreign companies", *European Journal of Marketing*, Vol. 47, No. 11/12, pp. 1910-1930
- Deitz, G.D., Evans, R.D., and Hansen, J.D. (2013), "Sponsorship and shareholder value: A re-examination and extension", *Journal of Business Research*, Vol. 66, No. 9, pp. 1427-1435
- Lee, R. and Mazodier, M. (2015), "The roles of consumer ethnocentrism, animosity, and cosmopolitanism in sponsorship effects", *European Journal of Marketing*, Vol. 49, No. 5/6, pp. 919 – 942
- Séguin, B., Lyberger, M. R., O'Reilly, N., and McCarthy, L. (2005), "Internationalising ambush marketing: a comparative study", *International Journal of Sports Marketing & Sponsorship*, Vol. 6, No. 4, pp. 216-230

# IMPULSIVE BUYING AND SHOPPING MOTIVATIONS IN EMERGENT AND MATURE MARKETS

Adıgüzel, Feray

Department of Business and Management, LUISS Guido Carli University, Rome, Italy

## ABSTRACT

This research examines the influence of shopping motivations on impulse buying behaviour and compares these effects in emergent and mature markets. Shopping is becoming a gradually hedonic activity worldwide with an increasing number of multichannel buying opportunities. Unexpectedly, the research on the relations between shopping motivations and impulse buying does not exist, yet. Impulsive buying behaviour is a widely recognized phenomenon in mature markets. It is even estimated that 40 percent of all money spent is through impulse buying. While impulse buying has been much studied in mature markets, especially in the U.S., there have been a few studies in emergent markets. Data were collected from 520 female shopping mall visitors in four countries representing two mature markets (the Netherlands and Germany) and two emerging markets (Turkey and Russia) and analysed with structural equation modelling. There were significant differences in the effect of gratification, adventure, value, and quality seeking motivation on impulse buying, but not the ones of role play, social and idea. Adventure and gratification motivation influenced positively impulse buying both markets. Value motivation negatively influenced impulsive buying in mature markets, but opposite of it in emerging markets. Value motivation was not hedonic in mature markets; however it was both hedonic and utilitarian value in emerging markets. The effect of quality seeking motivation on utilitarian value was only significant in emerging markets. We additionally discuss several implications for marketers.

## INTRODUCTION

As a phenomenon of modern society, more and more purchase decisions result from consumers spontaneously giving in to a sudden "urge to buy" (Rook, 1987). For instance, in the United States, even about 62% of supermarket sales and 80% of luxury-goods sales were estimated as a result of impulsive buying (Agins, 2004). Thus, we can state that impulse buying is an essential source of profits of retailers. Recently, some researchers have begun to ask "when" and "why" impulse buying occurs (Vohs and Faber, 2007). Our study contributes to this stream by examining shopping motivations that cause impulse buying. Shockingly, none of the existing studies on impulse buying have been investigated the relationship between shopping motivations and impulse buying so far. Additionally, most of the studies about the precursors of impulse buying have been conducted only in

mature markets, especially in the United States. In fact, the importance of emerging economies on profits of multinational brands has been gradually increasing. More than 80% of the world's consumers live in emerging markets and transitional economics (ECMs) (Steenkamp and Burgess, 2002). Many emerging countries have been experiencing large changes in their retail environment parallel to their steadily rising income levels as a result of continuing economic growth.

Shopping motivations influence key retail outcomes, namely loyalty, positive word of mouth, and satisfaction with the retailer (Jones et al., 2006). Shoppers differ significantly in terms of why they shop, what they look for, how they evaluate shopping experience, how they shop and purchase. Culture and economic welfare may have a strong influence in what aspects of shopping consumers find important (Kacen and Lee, 2002). There is a strong need to understand how consumers behave in emergent markets and especially, understanding their shopping motivations and whether these motivations differ from consumers' motives in mature markets is essential. In practice, which motivations cause impulse buying in emergent and mature markets can be beneficial for multinational companies to understand whether they need different marketing strategy than the ones from mature markets. Since we conceptualize that shopping motivations can contain both hedonic and utilitarian value, some motivations might be hedonic in mature markets, but utilitarian in emergent markets; so that some motivations can influence impulse buying while not in other market. The current study fills in this gap and contributes to literature by investigating hedonic and utilitarian motivations in both markets and comparing the effects of them on impulse buying. This study focuses on both utilitarian, namely quality seeking motivation and hedonic, namely adventure, social, gratification, idea, role, and value motivations which are conceptualized by Arnold and Reynolds (2003) in a mature market (i.e. USA).

## **METHODOLOGY**

Data were collected in shopping malls from only female shoppers in four countries, representing two leading Western mature markets (the Netherlands and Germany) and two important emerging markets (Russia and Turkey). After testing the cross-cultural invariance (configural and metric invariance) with multi-group confirmatory factor analysis, we examined the equivalence of structural paths in two markets with the chi-square difference tests on multi-group structural equation model (LISREL 8.8; Jöreskog & Sörbom, 1999).

## **FINDINGS**

Our findings indicated that there are significant differences in the effect of gratification, adventure, value, and quality seeking motivation on impulse buying, but not for role play, social and idea ones. While the effect of gratification on impulse buying in mature markets was larger than the one in emergent ones, the effect of adventure on impulse buying in emergent markets was larger than the one in mature ones. Interestingly, value motivation negatively influenced impulse buying in mature markets, but no significance observed in emergent ones. This is due to the fact that value motivation was both utilitarian and hedonic value in emergent markets, while it was more utilitarian than hedonic value in mature markets. Social, idea and role play motivation were hedonic value in mature markets, but they were not in emergent markets. Quality seeking was significantly utilitarian in emergent markets, but neither hedonic nor utilitarian in mature ones.

*Keywords: Impulse buying, gratification, value, role play, adventure, social, quality seeking, structural equation model, emergent markets*

## REFERENCES

- Agins, T. (2004), "For men, fancier pants—and pricier boxers", *Wall Street Journal*, September 3, pp. 12.
- Arnold, M.J., and Reynolds, K.E. (2003), "Hedonic shopping motivations", *Journal of Retailing*, Vol. 79, pp.77-95.
- Jones, M. A., Reynolds, K. E., and Arnold, M. J. (2006), "Hedonic and utilitarian shopping value: Investigating differential effects on retail outcomes", *Journal of Business Research*, 59, pp.974–981.
- Jöreskog, K. G., and Sörbom, D. (1999), *LISREL 8 user's guide*. Chicago: Scientific Software International.
- Kacen, J.J., and Lee, J.A. (2002), "The influence of culture on consumer impulsive buying behaviour", *Journal of Consumer Psychology*, Vol. 12, No. 2, pp. 163-176
- Rook, D. W. (1987), "The Buying Impulse", *Journal of Consumer Research*, Vol. 14, No. 2, pp. 189-199.
- Steenkamp, J.B.E.M. and Burgess, S.M., (2002). "Optimum stimulation level and exploratory consumer behavior in an emerging consumer market", *International Journal of Research in Marketing*, Vol. 19, No. 2, pp.131–150.
- Vohs, K.D. and Faber, R.J. (2007), "Spent resources: Self-regulatory resource availability affects impulse buying", *Journal of Consumer Research*, Vol. 33, pp. 537-547.

## THE IMPACT OF EXISTENTIAL GUILT APPEAL ON CONSUMER INTENTION TO PURCHASE CAUSE-RELATED PRODUCT OR TO DONATE TO CHARITY

Adomaviciute, Karina; Urbonavicius, Sigitas; Urbutyte, Ieva

Marketing department, Vilnius University, Vilnius, Lithuania

### ABSTRACT

Charity support behavior increasingly attracts more and more debates of researchers in the scientific literature. The interest in this topic is also encouraged by charity organizations which are constantly looking for ways of attracting more support for their sponsored charity types and projects. An advertising campaign is one of the most important elements for the existence of charitable organization (Burt, 2012). In order to make it more effective different appeals are used. Guilt appeals are commonly used by charity organizations to evoke donation to charities (Huhmann and Brotherton, 1997). Moreover, a huge number of research had examined the impact of guilt appeals on charitable donations (Lwin and Phau, 2014; Hibbert *et al.*, 2007; Basil *et al.*, 2006; Bozinoff and Ghingold, 1983). The critical question is whether the existential guilt appeal differently impacts the most analysed types of charity related behaviour: direct donation to charity and purchase of cause – related product. Previous studies did not analyse this relationship.

The purpose of this paper is to examine the impact of existential guilt appeal on consumer intention to donate or to buy cause-related product. The study included two steps: a pilot study in order to find the suitable form of an advertisement to be used as a stimulus for inducing existential guilt, and the main quantitative study. Online survey and non-probability (convenience) sampling were used for the main study. This study is based on a survey of 374 respondents from Lithuania. Respondents received an advertising message designed to induce existential guilt and reported their behavioural intentions provoked by this manipulation.

Results confirmed that existential guilt had direct positive impact on both charity related consumer behaviour forms: purchase of cause-related product and donation to charity. However, this relationship was stronger in the case of direct donation to charity.

The analysis enriches a scientific knowledge gap in the consumer choice between donation to charity and purchasing cause-related product. Most researches analyse only one of behavioural cases, that is: which factors determine either the donation to charity, or consumer intention to purchase cause-related product, though the two behaviours include certain similarities. This study provides new insights into the knowledge about similarity between the donation to charity and purchasing cause-related products, confirming the importance of existential guilt in both instances. From the managerial



perspective, it was confirmed that existential guilt induced by advertising helps raise funds both by direct donations and by cause-related purchasing. Moreover, the results confirmed previous studies suggesting that negative emotional appeals are considered as an effective way to lead to a greater intention to donate to charity (Chang and Lee, 2009; Anik *et al.*, 2011).

**Keywords:** *cause-related marketing, cause-related product, existential guilt, donation to charity.*

## REFERENCES

- Anik, L., Aknin, L. B., Norton, M. I., Dunn, E. W. (2011), "Feeling good about giving: The benefits (and costs) of self-interested charitable behavior", in Oppenheimer, D., Olivola, C. (Ed.), *The science of giving: Experimental approaches to the study of charity*, Taylor & Francis, New York, pp. 3-14.
- Basil, D. Z., Ridgway, N. M., Basil, M. B. (2006), "Guilt Appeals: The Mediating Effect of Responsibility", *Psychology & Marketing*, Vol. 23, No. 12, pp. 1035-1054.
- Bozinoff, L. and Ghingold, M. (1983), "Evaluating guilt arousing marketing communications", *Journal of Business Research*, Vol. 11, pp. 243-255.
- Burt, C. D. B. (2012), "The importance of trust to the funding of humanitarian work", in Carr, S. C., MacLachlan, M. and Furnham A. (Ed.), *Humanitarian work psychology*, Palgrave-Macmillan, Basingstoke, UK, pp. 317-331.
- Chang, C. T. and Lee, Y. K. (2009), "Framing charity advertising: influences of message framing, image valence, and temporal framing on charitable appeal", *Journal of Applied Social Psychology*, Vol. 39, No. 12, pp. 2910-2935.
- Hibbert, S., Smith, A., Davies, A. and Ireland, F. (2007), "Guilt Appeals: Persuasion Knowledge and Charitable Giving", *Psychology and Marketing*, Vol. 24, No. 8, pp. 723- 742.
- Huhmann, B. A. and Brotherton, T. P. (1997), "A content analysis of guilt appeals in popular magazine advertisements", *The Journal of Advertising*, Vol. 26, No. 2, pp. 35-4.
- Lwin, M. and Phau, I. (2014), "An exploratory study of existential guilt appeals in charitable advertisements", *Journal of Marketing Management*, Vol. 30, pp. 1467-1485.

# IMPACT OF STRESS AND JOB SATISFACTION ON MENTAL WELL BEING OF HEALTHCARE PROFESSIONALS

Aggarwal - Gupta, Meenakshi<sup>1</sup>; Vatharkar, Poonam<sup>2</sup>

<sup>1</sup>Organizational Behavior and Human Resource Management, Indian Institute of Management, Indore, India

<sup>2</sup>Organizational Behavior and Human Resource Management, University of Mumbai, Mumbai, India

## ABSTRACT

## INTRODUCTION

The job of healthcare professionals is highly regarded (Mechanic, 2003) but stressful (Firth-Cozens, 2003). Many occupational stressors like long/ odd working hours leading to poor sleeping habits, high performance expectations, and time pressures contributes to higher stress levels on physicians (Clever, 2002).

Excessive level of stress leads to reduced feeling of mental well-being (Chandraiah *et al.*, 2003). Many studies have shown that healthcare professionals have high rate of mental health problems like anxiety (Kroenke *et al.*, 2007) and depression (Firth-Cozens, 2006). Due to odd working hours, unpredictability of work commitments and lack of control over professional life, doctors also face high level of work family conflicts. It again affects their mental well being. (Elston, 2009; Hughes and Bozionelos, 2007).

Job satisfaction is regarded as an attitudinal variable and considers the extent to which people like or dislike their jobs (Spector, 1997). The issue of job satisfaction of physicians is very crucial since it affects not only their own health, but also health of their patients (DiMatteo *et al.*, 1993). Previous research suggest that job satisfaction of physician leads to greater productivity, better patient care and their own health and mental well being. (Judge *et al.*, 2001). In addition to job satisfaction, career satisfaction (Parasuraman *et al.*, 1996) also forms an important element of the way health care professionals view their work. The study is undertaken to understand if stress, work family conflict, career and job satisfaction of physicians have an impact on their mental well being.

## LITERATURE REVIEW AND HYPOTHESIS

Due to nature of job, healthcare professionals have to face multitude of occupational stressors. Number of studies have found that stress in doctors is inversely related to their job satisfaction. (Cooper, 1989; Richardson, 1991). Excessive stress among healthcare professionals is harmful to themselves, as it creates conflicts between various life roles, contributing to the feeling of "overload"

and reduced physical and mental well being (Sekaran, 1983; Greenhaus & Parasuraman, 1986). Thus, it is hypothesized that

*H1 - If perceived stress of physicians is high, their mental well being, global job satisfaction and career satisfaction will be low.*

Due to numerous reasons like long working hours and emergency on call services, medical profession is vulnerable to work interference in family life. This work family conflict has adverse impact on well being of physicians (Elston 2009). Job dissatisfaction is regarded as indirect cost due to work family conflict. (Quick, *et al.*, 1997)

*H2 - If work family conflict of physicians is high, their mental well being, global job satisfaction and career satisfaction will be low.*

Previous research has found that, job satisfaction is related to health and mental well being of employee. (Rathi and Rastogi, 2007). When job dissatisfaction increases, it boosts feeling of burnout, which ultimately leads to reduced mental well being (Arnetz *et al.*, 1987).

*H3 - If global job satisfaction and/or career satisfaction of physicians is high, mental well being will also be high.*

In fact, if the job satisfaction or career satisfaction is high, it may help physicians to cope with various stressors and support their well being (Bliese *et al.*, 2017). It is expected that

*H4 - Global job satisfaction and/or career satisfaction will mediate between perceived stress and mental well being.*

*H5 - Global job satisfaction and/or career satisfaction will mediate between work family conflict and mental well being*

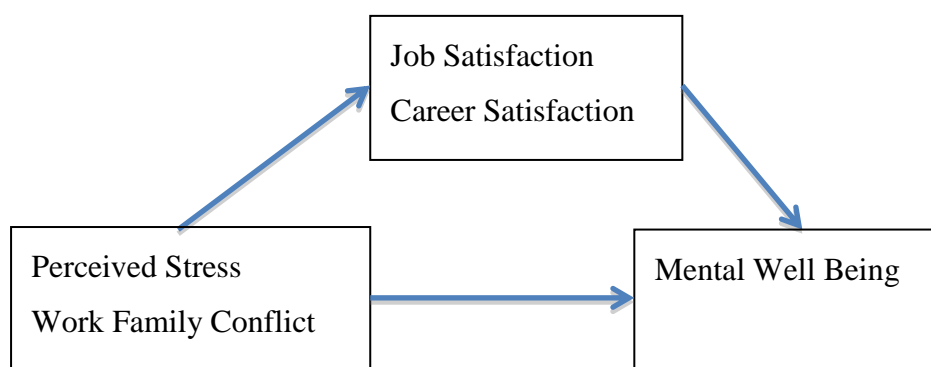

Figure 1: Research Model

## METHODS

*Sample* – Data was collected through a survey form 100 senior health professionals. Respondents were contacted either personally or via e mail and were explained the purpose of the questionnaire and

ensured confidentiality of responses. Of the 600 questionnaires that were distributed/ emailed, 100 arrived by the data analysis deadline date and/or were usable.

### Measures

*Mental Well Being (MWB)* was measured with a 14-item scale developed by Tennant *et al.* (2007). *Global Job Satisfaction (GJS)* and *Career Satisfaction (CS)* were measured using scale reported by Linzer *et al.*, (2000). This scale measures 13 aspects of job satisfaction. For the purpose of this study, two sub scales – 5-item Global job satisfaction and 4-item Career satisfaction were considered. *Perceived Stress (PS)* was measured using 14 items scale by Cohen *et al.* (1983). *Work Family Conflict* was measured using a 5 item scale developed by Netemeyer *et al.* (1996). All scales had reliabilities above 0.70 (Table 1).

## ANALYSES AND RESULTS

Mean, standard deviations and correlations are reported for all variables in table 1. Moderate to strong correlations are found between mental well being, global job satisfaction, career satisfaction and perceived stress. Work family conflict does not show correlation with mental well being and perceived stress of physicians.

Table 1- Mean, Std. Deviation and Zero Order Correlations among study variables

Variables	Mean	Standard Deviation	MWB	GJS	CS	PS	WFC
Mental Well Being	3.85	.73	0.92				
Global Job Satisfaction	3.75	.84	.500**	0.79			
Career Satisfaction	3.52	.81	.387**	.634**	0.70		
Perceived Stress	1.96	.76	-.389**	-.374**	-.218*	0.76	
Work family conflict	3.50	1.74	-.172	-.365**	-.448**	.033	0.92

\* $p < .05$     \*\*  $p < .01$

The results of hierarchical multiple regressions (controlling for gender, age & educational qualification) shows H1, H2 and H3 were supported though perceived stress did not significantly predicts career satisfaction. Since WFC did not appear to be significantly correlated with MWB, we could not test for mediation (H5 not supported). Results of Sobel Test for mediation reports that global job satisfaction partially mediates between perceived stress and mental well being of physicians ( $Z = -2.944$ ,  $SE = 0.058$ ,  $p$  value  $< .01$ ). However, career satisfaction did not play a mediating role (H4 partially supported).

## DISCUSSION

This study suggests that the nature of work for physicians may require them to manage stress and various time and resources related challenges. However, Structuring the work environment and

context may help them cope with these stressors and ensure that their well-being is not negatively impacted.

*Keywords : Mental well being, perceived stress, job satisfaction, career satisfaction, work-family conflict*

## REFERENCES

- Arnetz, B.B., Hörte, L.G., Hedberg, A., Theorell, T., Allander, E. and Malker, H. (1987), "Suicide patterns among physicians related to other academics as well as to the general population", *Acta Psychiatrica Scandinavica*, Vol. 75 No. 2, pp. 139-143.
- Bliese, P, Edwards, J, & Sonnentag, S. (2017), "Stress and well-being at work: A century of empirical trends reflecting theoretical and societal influences", *Journal Of Applied Psychology*, Vol. 102 No. 3, pp. 389-402,
- Chandraiah, K., Agrawal, S.C., Marimuthu, P. and Manoharan, N. (2003), "Occupational stress and job satisfaction among managers", *Indian Journal of Occupational and Environmental Medicine*, Vol. 7 No. 2, pp. 6-11.
- Clever, L.H. (2002), "Who is sicker: patients—or residents? Residents' distress and the care of patients", *Annals of Internal Medicine*, Vol. 136 No. 5, pp. 391-393.
- Cohen, S., Kamarck, T. and Mermelstein, R. (1983), "A global measure of perceived stress", *Journal of health and Social Behavior*, pp. 385-396.
- Cooper, C.L., Rout, U. and Faragher, B. (1989), "Mental health, job satisfaction, and job stress among general practitioners", *British Medicine Journal*, Vol. 298 No. 6670, pp. 366-370.
- DiMatteo, M.R., Sherbourne, C.D., Hays, R.D., Ordway, L., Kravitz, R.L., McGlynn, E.A., Kaplan, S. and Rogers, W.H. (1993), "Physicians' characteristics influence patients' adherence to medical treatment: results from the Medical Outcomes Study", *Health Psychology*, Vol. 12 No. 2, pp. 93-102.
- Elston, M.A. (2009), *Women and Medicine: The Future*, London: Royal College of Physicians.
- Firth-Cozens, J. (2003), "Doctors, their wellbeing, and their stress", *British Medical Journal*, Vol. 326 No. 7391, pp. 670-671.
- Greenhaus, J.H. and Parasuraman, S. (1986), "Vocational and organizational behavior, 1985: A review", *Journal of Vocational Behavior*, Vol. 29 No. 2, pp.115-176.
- Hughes, J. and Bozionelos, N. (2007), "Work-life balance as source of job dissatisfaction and withdrawal attitudes: An exploratory study on the views of male workers", *Personnel Review*, Vol. 36 No. 1, pp. 145-154.
- Judge, T.A., Thoresen, C.J., Bono, J.E. and Patton, G.K. (2001), "The job satisfaction–job performance relationship: A qualitative and quantitative review", *Psychological Bulletin*, Vol 127, pp. 376-407.
- Kroenke, K., Spitzer, R.L., Williams, J.B., Monahan, P.O. and Löwe, B. (2007), "Anxiety disorders in primary care: Prevalence, impairment, comorbidity, and detection", *Annals of Internal Medicine*, Vol. 146 No. 5, pp. 317-325.
- Linzer, M., Konrad, T.R., Douglas, J., McMurray, J.E., Pathman, D.E., Williams, E.S., Schwartz, M.D., Gerrity, M., Scheckler, W., Bigby, J. and Rhodes, E. (2000), "Managed care, time pressure, and physician job satisfaction: Results from the physician work life study", *Journal of General Internal Medicine*, Vol. 15 No. 7, pp. 441-450.
- Mechanic, D. (2003), "Physician discontent: Challenges and opportunities", *JAMA*, Vol. 290 No. 7, pp. 941-946.
- Netemeyer, R.G., Boles, J.S. and McMurrian, R. (1996), "Development and validation of work–family conflict and family–work conflict scales", *Journal of Applied Psychology*, Vol. 81 No. 4, pp. 400-410.
- Quick, J.C., Quick, J.D., Nelson, D.L. and Hurrell Jr, J.J. (1997), *Preventive Stress Management in Organizations*. American Psychological Association.
- Rathi, N. and Rastogi, R. (2007), "Meaning in life and psychological well-being in pre-adolescents and adolescents", *Journal of the Indian Academy of Applied Psychology*, Vol. 33 No. 1, pp. 31-38.
- Richardson, K.M. and Rothstein, H.R. (2008), "Effects of occupational stress management intervention programs: a meta-analysis", *Journal of Occupational Health Psychology*, Vol 13 No. 1, pp. 69-93.
- Sekaran, U. (1983), "How husbands and wives in dual-career families perceive their family and work worlds", *Journal of Vocational Behavior*, Vol. 22 No. 3, pp. 288-302.
- Spector, P.E. (1997), *Job Satisfaction: Application, Assessment, Causes, and Consequences* (Vol. 3). Sage publications.

Tennant, R., Hiller, L., Fishwick, R., Platt, S., Joseph, S., Weich, S., Parkinson, J., Secker, J. and Stewart-Brown, S. (2007), "The Warwick-Edinburgh mental well-being scale (WEMWBS): development and UK validation", *Health and Quality of Life Outcomes*, Vol. 5 No. 1, pp. 63.

Parasuraman, S., Purohit, Y.S., Godshalk, V.M. and Beutell, N.J. (1996), "Work and family variables, entrepreneurial career success, and psychological well-being", *Journal of Vocational Behavior*, Vol. 48 No. 3, pp. 275-300.

## FAMILY BUSINESS EFFICACY AND PERFORMANCE

AL Kayid, Wejdan Saeed; Zhongqi, Jin; Ramakrishnan, Sumeetra; Priporas, Costas

The Business School, Middlesex University, London, United Kingdom, UK

### ABSTRACT

This research examines the concept of family business efficacy which can provide a better understanding of the role of family business efficacy beliefs in delivering success and providing high levels of family firm performance, Through the concepts of family and collective efficacy and by exploring relevant antecedents of FBE from various domains. In this context, it is relevant to study the family business sphere from social and psychological perspective using the social cognitive approach. Family business efficacy as a construct has not been studied before; this study will therefore define and develop a scale.

The concept of family business efficacy is theoretically generated from the efficacy theory proposed by Bandura (1977). The focal purpose of this development is to understand the family firm's productivity from an organisational psychology perspective, specifically from Bandura's social cognitive approach. Self-efficacy theory is central to Bandura's view and is related to a person's perception of their ability to reach a goal. Therefore, Bandura (1977) defines self-efficacy as " the extent or strength of one's belief in one's own ability to complete tasks and reach goals" . Self-efficacy is widely applied in different fields, including business, education, psychology, media and medicine.

To address the research objective, a mixed method research design will be adopted, following Churchill's (1979) paradigm to develop a reliable measurement scale. A qualitative method will be applied in the early stages of the research, in order to understand in depth the nature of the research problem. It will also help to improve the research model and hypothesis. This research intends to apply the collective efficacy scale to different overlapping organisations and the social capital of individuals as well as groups, to highlight the relationship between the overall efficacy of families and family businesses. Therefore, a quantitative approach will be also used to measure each construct established on the basis of the existing literature. The data will be gathered in family-owned businesses in the UK and Saudi Arabia, focusing on founders and CEOs of different levels and industries of family firms.

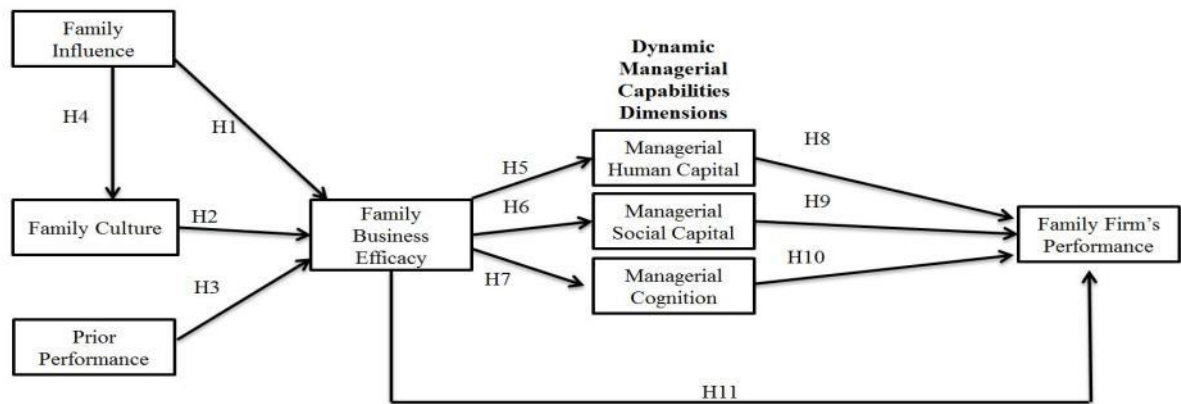

**Fig.1 Conceptual model**

*Key words: Social cognitive approach, efficacy beliefs, family businesses.*

## REFERENCE

- Bandura, A., 1977. Self-efficacy: toward a unifying theory of behavioral change. *Psychological review*, 84(2), p.191.
- Churchill Jr, G.A., 1979. A paradigm for developing better measures of marketing constructs. *Journal of marketing research*, pp.64-73.



## ESTIMATION OF MANAGERIAL DISCRETION IN ACCRUALS USING FIRM LIFE CYCLE

Almand, Andrew<sup>1</sup>; Cantrell, Brett<sup>2</sup>; Dickinson, Victoria<sup>2</sup>

<sup>1</sup>School of Business, Henderson State University, USA

<sup>2</sup>E. H. Patterson School of Accountancy, University of Mississippi, USA

### ABSTRACT

Detecting earnings management commonly involves the estimation of discretionary accruals, i.e. accounting estimates that are subject to managerial discretion. Discretionary accruals are modeled as total accounting accruals less expected, or normal, accruals. This indicates that the measurement of the discretionary portion of accruals relies on a fully-descriptive model of the normal accruals generating process. Moreover, a sample of firms used to estimate “normal” accruals necessitates that the firms within that sample are sufficiently homogenous with respect to the overall earnings process and the economic fundamentals that govern that process.

When normal accruals estimates are misspecified, discretionary accruals are also measured with error, which reduces the power to detect earnings management. Thus, increasing the homogeneity of the sample of firms used to determine the normal accrual process (Ecker et al., 2013; Zarowin 2015) enhances estimations of normal accruals and detection of earnings management. While prior literature has used industry and/or size to group firms, we propose firm life cycle stage as another economic characteristic upon which to organize firms. Refining the grouping of firms to increase sample homogeneity allows financial statement users, as well as regulators, to develop more accurate expectations about normal accruals, which lead to better estimates of discretion. The improvement in estimates of potential earnings management leads to better understanding of earnings quality and, as a result, a more efficient allocation of resources.

We use a combination of simulated and actual earnings management to compare earnings management detection ability using several common models of discretionary accruals and across varying estimation partitions of firms (i.e., year, industry, size, life cycle stage, and multiple combinations of those characteristics). Specifically, we seek to complement the prior literature by examining an alternative fundamental characteristic, firm life cycle stage, in place of (and in later tests in addition to) industry and size. We posit that firms in similar life cycle stages face similar strategic concerns, managerial pressures, growth prospects, etc. and expect the similarity in these factors to drive homogeneity in the “normal” accruals generating process. To measure these strategic concerns, pressures and prospects, we identify firm-specific life cycle stage using the cash flow pattern proxy developed by Dickinson (2011).

We predict homogeneity within each life cycle stage ultimately reduces measurement error in estimating the discretionary portion of accruals by capturing the magnitude of managerial pressure to use discretion to achieve earnings targets conditional on the various stages of operating performance and economic growth (i.e, life cycle). We also assert that industry and/or size characteristics do not fully capture these stages of performance. Dickinson (2011) demonstrates that firm life cycle is not merely an industry effect or linearly related to firm size, and thus represents a different construct. Therefore, we suggest that using life cycle to organize firms will improve the homogeneity of the accruals estimation procedure and the resulting measurement of managerial discretion over and above industry or size alone.

We examine the efficacy of firm life cycle stage to improve the estimation of discretionary accruals using several models. Common discretionary accruals models include the Jones model (Jones 1991) and the modified Jones model (Dechow et al.,1995). Stubben (2010) models discretion based on the receivables accrual to capture premature recognition of revenue as revenue management is the most prevalent form of earnings management found in the Security and Exchange Commission's (SEC) Accounting and Auditing Enforcement Releases (AAERs).

To conduct our tests, we simulate earnings management in varying estimation groupings (industry, size, life cycle, and a combination thereof) across the three discretionary accruals models to determine whether life cycle stage improves homogeneity of the normal accruals process for both revenue and expense manipulation. We find that estimating managerial discretion by firm life cycle stage produces estimations with less bias and measurement error than estimates modeled either in the cross section or by industry or size. Next, we investigate whether life cycle stage improves estimation models in instances of actual accrual manipulation using AAER data and find that varying types of accruals management are more easily detected in certain life cycle stages. While detection varies for expense and revenue manipulation by life cycle stage, overall, we find firm life cycle stage improves the homogeneity of estimation samples and thus the detection of earnings management for the majority of the population.

Finally, and perhaps more critically, we examine the rejection rates by life cycle stage when no manipulation is present. We find the revenue model to be misspecified for all life cycle stages and the Jones models to be misspecified for all stages other than growth when life cycle measures are not included. The revenue model over-identifies introduction and decline firms, while under-identifying growth, mature and shake-out firms as manipulators. The Jones and modified Jones models over-identify introduction, shake-out, and decline firms while under-identifying mature firms. Including firm life cycle information remediates or improves the misspecification resulting in better-performing models. Thus, including firm life cycle information not only decreases Type II errors, but also reduces

Type I errors. Collectively, the results offer strong support that firm life cycle increases sample homogeneity and enhances model performance.

It is important for financial statement users and other interested parties (e.g., auditors, standard setters, regulators, and researchers) to understand how and to what extent managers use discretion when estimating accounting earnings. Refining the sample selection on which to estimate the accruals generating process increases the accuracy of the identification of manipulators. This study contributes to the literature by providing a more complete picture of which firms manage earnings and how that earnings management relates to particular economic circumstances. In turn, this knowledge aids standard setters in revising existing standards or requiring additional disclosures to increase the faithful representation of financial reporting.

**Keywords:** *accruals, life cycle, earnings management, industry-adjusted*

## REFERENCES

- Dechow, P., Sloan, R. and Sweeney, A. (1995), "Detecting earnings management", *The Accounting Review*, Vol. 70 No. 2, pp. 193-225.
- Dickinson, V. (2011), "Cash flow patterns as a proxy for firm life cycle", *The Accounting Review*, Vol. 86 No. 6, pp. 1969-1994.
- Ecker, F., Francis, J., Olsson, P., & Schipper, K. (2013), "Estimation sample selection for discretionary accruals models", *Journal of Accounting and Economics*, Vol. 56, pp. 190-211.
- Jones, J. (1991), "Earnings management during import relief investigations", *Journal of Accounting Research*, Vol. 29 No. 2, pp. 193-228.
- Stubben, S. (2010), "Discretionary accruals as a measure of earnings management", *The Accounting Review*, Vol. 85 No. 2, pp. 695-717.
- Zarowin, P. (2015), "Estimation of discretionary accruals and the detection of earnings management", *The Oxford Handbook of Strategy Implementation*.

## EXPLORING THE EFFECTS OF BRAND COMMUNITY CENTRIC MODEL ON FANDOM AND BRANDOM OF FOOTBALL FANS

Alon, Anat Toder; Shuv-Ami, Avichai

The School of Business Administration, Peres Academic Center

### ABSTRACT

### INTRODUCTION

Football (soccer) clubs have emerged as significant brand communities that provide a complex social context in which multiple relationships are formed, and where media concerns, branding practices and financial interests collide with fan enthusiasm and community affiliation (Hewer, Gannon & Cordina, 2015). The need to understand and leverage sports fans-brand relationships has become especially critical for sports marketers dealing with marketplaces characterize by increasing commercialization (Crawford, 2004). Although there is a growing research corpus on the cultural and social aspects of football club fandom (e.g., Healy & McDonagh, 2013; Guschwan, 2012), researchers do not have a good understanding of the various levels of relationships that shape these communities. Thus, although many sport clubs strive for the brand genuineness, marketing competence and fans commitment that strong fandom provides, not many comprehend what it takes to achieve such advantages.

### CUSTOMER-CENTRIC MODEL OF BRAND COMMUNITY

McAlexander, Schouten and Koenig (2002) suggested that brand community from a customer-experiential perspective is a fabric of relationships in which the customer is situated. Employing the basic premises of the customer-centric model of brand community, our study measured four sports fans-centric relationships: *Fans-Fans Relationships*, *Fans-Management (firm) Relationships*, *Fans-Team (brand) Relationships*, and *Fans-Product (sport, e.g., football) Relationships*. Following McAlexander, Schouten and Koenig (2002), it is assumed that the more each relationship is internalized as part of the fan's life experience, the more the sports fan is integrated into the brand community and the more loyal the fan is in consuming the sports team brand.

### BRANDOM VERSUS FANDOM

Nowadays, the majority of the sports teams around the world are not community-based organizations as it used to be in the past, but rather they are commercialized corporations with business orientation

(Crawford, 2004). Following Guschwan (2012), this study approaches sports team supporters from two lenses:

(1) The Brandom lens, which defines supporters as loyal customers and potential commodities. Guschwan (2012) offered the term brandom to describe the pseudo-fan culture engineered by brand managers eager to cultivate consumer loyalty. Accordingly, sports team support is considered as a consumption activity, since it involves the choice and preference of one alternative over the other, which is reflected in purchasing tickets for specific games and seasonal subscriptions, attending a team's games, connecting to dedicated sports channels, and purchasing merchandise. Branding creates an identity for a sports club and differentiates the sports club from competitors (Schilhaneck, 2008). Thus, building sports club brand equity involved the consideration of intangible factors, such as: actual or aspirational fans imagery, the type of personality the sports club portrays, the feeling that the sports club tries to elicit in fans, and the type of relationship it seeks to build with its fan base (Keller, 2003).

(2) The Fandom lens, which understands supporters as agentic meaning-producers who use fandom for their own uses. According to Guschwan (2012), "Participatory fan culture ... offers freedom of expression and a measure of independence" from the club management "and the hegemony of the market that brandom lacks" (p.26). Indeed, Healy and McDonagh (2013) emphasize the culture and value co-creative roles played by football fans. The communal-social aspect is at the heart of fandom. Thus, fandom can allow individuals the opportunity to feel a sense of togetherness and cohesion with fellow supporters (Fillis & Mackay, 2014).

## RESEARCH METHODOLOGY

The current research employed a survey to examine the impact that different levels of fans-centered relationships have on sport team supporters' brandom and fandom and the effect of these constructs on brand loyalty and intentions to attend games. The respondents in the were 776 Israeli football fans.

## RESULTS

The hypothesized modal was analyzed with AMOS 18.0 structural equation modeling (Arbuckle, 2009) using the maximum-likelihood estimation method. It was demonstrated that all four types of fan relationships were significantly correlated with each other, and in general, the correlations between fans-product relationship and the other three types of relationships were weaker than the correlations between the other types of relationships. In addition, it was demonstrated that three of the four types of relationships significantly predicted both brandom and fandom, and fans-product relationships had the strongest effects on both of these variables. Only the fans-management relationships were not

linked to brandom and fandom. Brandom also significantly predicted levels of fandom, and both these variables predicted both loyalty and intentions to attend games.

## DISCUSSION

The findings of this study reveal important theoretical implications. First, the focus of the current study on understanding the social and cultural context of sport clubs as brand communities has the potential to reframe and revitalize some of the basic knowledge on sports clubs loyalty and fans experiences. In addition, following Guschwan (2012), this study has juxtaposed the language of fandom with the language of branding. Moreover, this study deviated from previous research on sports club fandom by distinguishing different levels of fans-centered relationships and by investigating the impact that these different relationships have on sport team supporters' brandom and fandom and the effect of these constructs on brand loyalty and intentions to attend games. In addition, the current study provides some significant managerial implications. Providing that the current study emphasizes that fan-product relationship play a significant role in fan identification (Fandom) and sports club's brandom, it is recommended that managers should allocate major resources on activities that enhance fan-product relationships in order to increase fan identification, loyalty and repatronage intention.

## REFERENCES

- Arbuckle, J. (2009). *Amos 18 user's guide*. Armonk: SPSS Incorporated.
- Crawford, G. (2004). *Consuming Sport: Fans, Sport and Culture*, London ; New York: Routledge.
- Fillis I. & Mackay C. (2014). Moving beyond fan typologies: The impact of social integration on team loyalty in football. *Journal of Marketing Management*, 30, 334-363.
- Guschwan, M. (2012). Fandom, brandom and the limits of participatory culture. *Journal of Consumer Culture*, 12, 19-40.
- Healy J.C. & McDonagh P. (2013). Consumer roles in brand culture and value co-creation in virtual communities. *Journal of Business Research*, 66, 1528-1540.
- Hewer, P., Gannon M., & Cordina R.. (2015). Discordant fandom and global football brands: 'Let the people sing'. *Journal of Consumer Culture*, 1-20.
- Keller, K. L. (2003), *Brand Synthesis: The Multidimensionality of Brand Knowledge*, *Journal of Consumer Research*, 29, 595-600.
- McAlexander, J. H., Schouten J.W., & Koenig H. F. (2002). Building brand community, *Journal of Marketing*, 66, 38-54.
- Schilhaneck, M. (2008). Brand management in the professional sports club setting. *European Journal for Sport and Society*, 5, 43-62.

**AN ASSESSMENT OF CUSTOMER RETENTION WITH SELF-SERVICE  
TECHNOLOGY: A COMPARATIVE STUDY BETWEEN INTERNET BANKING  
AND MOBILE BANKING IN SAUDI ARABIA**

**Alsiehemy, Ali; Battor, Moustafa; Pantano, Eleonora; Dennis, Charles**

The Business School, Middlesex University London, UK

**ABSTRACT**

Self-service technologies (SSTs) are systems that allow customers to independently access banking services at a time and a place of their choice. Such technologies have been widely integrated into banking logistical systems to raise the geographical coverage, decrease labour costs and provide customers with a better service, thereby enhancing their satisfaction and retention.

However, the retention of SSTs is not ideal, especially in developing countries, and the growth in the adoption of such technologies is still sluggish. Therefore, several studies relating to SSTs have been conducted, and numerous factors have been examined and many theories formulated. However, there is still a need to select a theoretical framework that is appropriate for the customer (i.e. individual consumer) context. Furthermore, in Saudi Arabia, there are a limited studies examining the use of SSTs (e.g. Internet banking and Mobile banking), but none examining retention. Thus, the fundamental aim of this thesis is to propose and examine a conceptual model that best explains the key factors influencing Saudi customers' retention of SST banking channels: Internet banking and Mobile banking. The conceptual model proposed was based on the Technology Acceptance Model (TAM) and Expectation Confirmation Theory (ECT). This was extended by adding perceived risk and culture as an external factors.

TAM proposes that users' behavioural satisfaction determines their acceptance and adoption of new technologies. In turn, behavioural satisfaction is determined by users' perceptions of the technology, namely usefulness and ease of use. Perceived usefulness is the extent to which individuals consider that using a specific technology will result in improving their productivity. Perceived ease of use, on the other hand, is the degree to which people think that using a specific technology requires minimal effort (Venkatesh et al, 2003). The second theory used is Expectation Confirmation Theory (ECT), the expectation-confirmation paradigm has been one of the most robust theories established in this regard (Churchill and Surprenant, 1982). Its objective is to provide an insight into consumer satisfaction and repurchasing behaviour of a product or service. ECT hypothesises that the satisfaction of a consumer to repurchase a product or service is determined by his or her level of satisfaction with it. This level of satisfaction, on the other hand, is determined by two things: firstly, the initial consumer expectations

(pre-purchase expectation), while the second determination is after-purchase differences found between initial expectations and the performance of the product or service (confirmation).

Following a positivist paradigm, this study will employ a quantitative data collection method as it is the most suitable research paradigm for the current study (Bhattacharjee, 2012; Orlikowski and Baroudi, 1991) for these reasons: First, the SST is a mature research field, where there are several theories and models that have been well-validated; they therefore can be used to explain individual perception towards technology (Orlikowski and Baroudi, 1991; Venkatesh et al., 2003; 2012). In other words, the existence of strong theoretical foundations (e.g. TAM, UTAUT, TPB, TRA, and ECM) allows the researchers to pick up the relevant factors, either dependent or independent, that could be used to predict individuals' intention and perception towards emerging systems (Orlikowski and Baroudi, 1991; Venkatesh et al, 2003; 2012). With regard to the current study, as presented in Chapter 3, the conceptual model and research hypotheses comprised in this model are based on existing theory (TAM), ECM model and other factors derived from SST literature (i.e. perceived risk and culture).

Second, the focus of the current study is on conducting an objective test for the main factors influencing consumers' continuous intentions and use of SSTs. This is more likely to be attained by adopting the positivist approach, which usually has a higher degree of objectivity in methods and in researchers (Bhattacharjee, 2012; Bryman and Bell, 2007; Easterby-Smith et al., 2002; Orlikowski and Baroudi, 1991). The main factors included in the proposed model have been selected according to theoretical and logical justification, not the researcher's beliefs and thoughts. The current study uses an online questionnaire, allowing respondents to answer the questions separate from the researcher, and such data is more objective and would not be affected by the researcher's own beliefs.

Thus, a quantitative approach was selected as an appropriate approach to the nature and aim of this study. Structural equation modelling (SEM) will be conducted using AMOS 21 to analyse the data that will be collected from the field online survey questionnaires to a convenience sample of Saudi banking customers. The model fitness and the constructs' validity and reliability will be tested, followed by the validation of the conceptual model and research hypotheses. The results will be explained thoroughly to show the significant and insignificant relationships in the conceptual model.

This study makes an important contribution by applying TAM and ECT to examine new technology (SSTs) in a new context (Saudi Arabia). By including perceived risk and culture alongside the TAM and ECT constructs and adding new relationships. Further, in an attempt to address the lower usage rate of SSTs, this study will offer Saudi banks some guidelines for designing and marketing SST channels in order to enhance their acceptance and retention by Saudi customers.



Keywords: Self-Service Technology, Customer Retention

Figure 1: Proposed Research Model

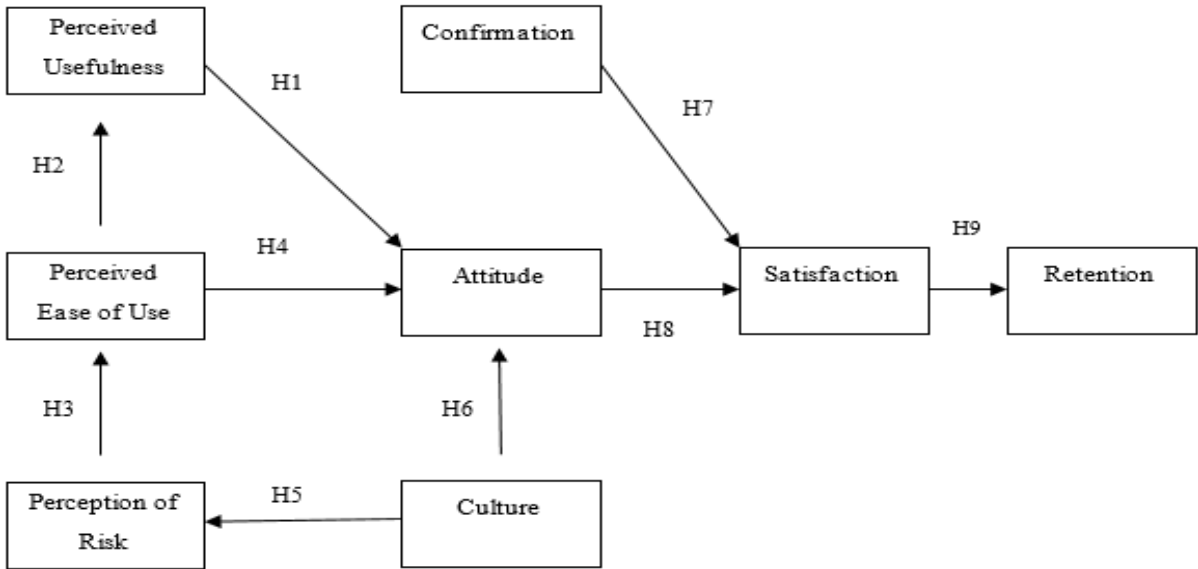

Source: The researcher

## INTENSIFYING THE POWER OF THE PORTUGUESE LANGUAGE: COMMUNICATING ON SCIENCE

Alves, Gisela; Martins, Moisés de Lemos

CECS, University of Minho, Braga, Portugal

### ABSTRACT

Given the European overseas expansion of the 15<sup>th</sup> and 16<sup>th</sup> century, Portugal has been considered a pioneer country in globalization together with the Portuguese language have a vast impact on an economic, financial, political and cultural level. The aim of this paper is to identify and intensify the power of the Portuguese language in the communication of science, understand the way that the Portuguese language impacts on scientific dissemination and how editors of Portuguese journals may improve the impact factor of their journals.

We propose to analyse three scientific journals in which Portuguese is the official language of scientific dissemination and three scientific journals in which English is the official language of scientific dissemination. The journals have the highest scientific impact according to the Google Scholar metrics.

Methodologically, this is a qualitative analysis as well as a documental analysis which checks different sources and a quantitative analysis; a mixed methodology.

The implications of this research will occur at the level of the features that contribute to a better and more visible scientific dissemination. We hope that the results will define strategies which will allow one to make the most of the importance that is represented in the diversity and richness of the Lusophone cultures and arts to intensify their representation in the European Union and the world. The aim of this paper is to provide the features that editors of Portuguese journals should demand in order to make their journals better qualified in international rankings.

This paper aims to comparatively research 6 scientific journals in two different languages, with a scientific impact, in order to understand which features, have an impact in their dissemination, thus contributing to fill in this gap.

*Keywords: Language of science; Strategic Communication; Lusophony; globalization.*

### REFERENCES

Alves, G. (2014). O Impacto da cultura e qualidade do relacionamento na cooperação entre as empresas exportadoras e distribuidores locais. Dissertação de Doutoramento em Marketing e Estratégia, Universidade do Minho, Braga.

- B., M. (1994), "Enjeux Économiques de la Valorisation de la Langue Française et du pluri-linguisme", *LangueFrancaise.Org*, Dossiers, Articles, Mars, [http://www.langue-francaise.org/Articles\\_Dossiers/Enjeux\\_economique.php](http://www.langue-francaise.org/Articles_Dossiers/Enjeux_economique.php)
- Bastos, N. (2014). *Língua portuguesa e lusofonia*. Educ- Editora da PUC-SP.
- Calvet, A. and Calvet, L-J. (2011). *Baromètre Calvet des langues du monde*, in *Portalingua: Observatoire des langues dans la connaissance* (<http://www.portalingua.info>).
- Galito, M. S. (2006). *Impacto económico da língua portuguesa enquanto língua de trabalho*.
- Ghemawat, Pankaj (2001). *Distance still matters the hard reality of global expansion*. *Harvard Business Review* (September 2001): 137-47.
- Hofstede, G. (1984). *Culture's consequences: International differences in work-related values*. Abridged edition. Newbury Park, CA: Sage Publications.
- INTERNET WORLD STATS (2016), "Internet Users by Language", IWS – Usage and Population Statistics, The Internet Coaching Library, <http://www.internetworldstats.com/stats7.htm> (Viewed in 11.07.2016)
- Ivo, C. (2006). *O museu da língua Portuguesa na estação da luz*. *Comunicação e Educação*, Ano XI, 3, set./dez 2006 : 435-444.
- Kotler, P. (2006). *Administração de Marketing*. 12<sup>o</sup> ed. São Paulo: Pearson Prentice Hall.
- Lewis, M. P. (2009). *Ethnologue: Languages of the World*, 16.<sup>a</sup> ed., Dallas, SIL International
- Luiz, M. John (2015). *The impact of ethno-linguistic fractionalization on cultural measures: Dynamics, endogeneity and modernization*. *Journal of International Business Studies* 46,1080-1098.
- Martins, M. L. (2014). *Parte I- Língua portuguesa lusofonia*. in Bastos, N. (2014). Educ- Editora da PUC-SP.
- Martins, M. L. (2015). *Lusofonia e interculturalidade- Promessa e Travessia*. Edições Húmus.
- Martins, M.L. (2015). *A liberdade académica e os seus inimigos*. *Comunicação e Sociedade*, 27, 405–420.
- Middleton, V. T. C. (2002) *Marketing de Turismo: teoria e prática*. Tradução da 3<sup>a</sup> Ed. Rio de Janeiro: Campus.
- Obadia, C. (2008). *Cross-border inter-firm cooperation: The influence of the performance context*. *International Marketing Review* 25(6): 634-650.
- Observatório da língua Portuguesa (2010) (<http://lingua-lp.sapo.pt>)
- Ostler, N. (2005). *Empires of the world: A language history of the World*, New York, Harper.
- Reto, L. (Ed.) (2012). *Potencial Económico da língua portuguesa*. Lisboa: Texto Editores.
- Serra, P. (2016). *O ( des ) conhecimento recíproco dos investigadores ibero-americanos de Ciências da Comunicação*, 3, 57–68.
- Sojka, Jane and Tansuhaj, Patriya S. (1995). *Cross-cultural consumer research: a twenty-year review*, in - *Advances in Consumer Research* Volume 22, eds. Frank R. Kardes and Mita Sujan, Provo, UT: Association for consumer research: 461-474.
- Taras, V., Steel, P., and Kirkman, B. L. 2015. *Does country equal culture? Beyond geography in the search for cultural entities*. Working paper, University of North Carolina at Greensboro.
- Tjosvold, D. (1988). *The goal linkage approach to interaction between organizational groups*. *International Journal of Management* 5: 201-208
- Venaik, S. and Midgley, D.(2015) *Mindscapes across landscapes: Archetypes of transnational and subnational culture*. *Journal of International Business Studies* 46:1051-1079

## HOW TRUST AND COOPERATION HAVE AN IMPACT ON INTERNATIONAL BUSINESS: A CASE STUDY

Alves, Gisela

CECS, University of Minho, Braga, Portugal

### ABSTRACT

**PURPOSE-** The purpose of this paper is to examine how trust and cooperation have an impact on international business. First, the author examines how trust affects cooperation and how cooperation affects trust. The aim is to study if there is retro-feeding between trust and cooperation and how it affects international business.

**DESIGN/METHODOLOGY-** In terms of the methodology, the author chose a qualitative analysis: a case study of a shoe exporting company. Interviews with the manager/CEO of the exporting company and the employee in charge of the exporting activities were carried out to obtain answers for the research questions. This study used a qualitative methodology, an inductive method, the paradigm was constructive and different sources were checked. **FINDINGS-** Trust is reflected on cooperation and cooperation is reflected on trust. There is retro-feeding between trust and co-operation. The empirical findings largely support the conceptual framework. As expected, trust is reflected on cooperation and cooperation is reflected on trust. Most importantly, the author also found a significant interaction effect between the retro-feeding of trust and cooperation.

**PRACTICAL IMPLICATIONS-** Relationship Marketing, trust and cooperation have become an important strategic priority for managers. This study allows managers to make more informed decisions regarding the cooperation initiatives of their organizations and establish international successful business relationships.

**ORIGINALITY/VALUE-** This study connects trust literature with cooperation literature, both of which are very important in relationship marketing literature. This study addresses a gap in the literature in relation to issues of trust and cooperation. Viewed through a signaling theory lens, this study provides new insights as to how positive and negative trust and cooperation messages and behavior may help or hurt the firm.

*Keywords: Cooperation, Trust, International Business, Relationship Marketing*

### REFERENCES.

- Akrout, H., Diallo, M. F., Akrou, W., and Chandon, J.-L. (2016). Affective trust in buyer-seller relationships : a two-dimensional scale. *Journal of Business & Industrial Marketing*, 31(2), 260–273. <https://doi.org/10.1108/JBIM-11-2014-0223>
- Alves, G. (2014). O Impacto da cultura e qualidade do relacionamento na cooperação entre as empresas exportadoras e distribuidores locais. Dissertação de Doutoramento em Marketing e Estratégia, Universidade do Minho, Braga.
- Alves, G. (2015). Relationship quality, cooperation and performance: The specific case of Portuguese companies operating in Angola. *Dynamic Relationships Management Journal*, 4(2), 23–38. <https://doi.org/10.17708/DRMJ.2015.v04n02a02>
- Al-Weshah, G., Alnsour, M. Al-Hyari, K., Alhammad, F. and Algharabat, R. (2013). Electronic networks and relationship marketing: Qualitative evidence from Jordanian travel agencies, *Journal of Relationship Marketing* 12: 261-279.
- Brodie, R. (2017). Enhancing theory development in the domain of Relationship Marketing: How to avoid the danger of getting stuck in the middle. *Journal of Services Marketing*, 31(1).
- Cambra-Fierro, J. J. and Polo-Redondo, Y. (2011), Postsatisfaction factors affecting the long-term orientation of supply relationships. *Journal of Business & Industrial Marketing* 26 (6): 395-406.
- Chabowski, B. R., Samiee, S., and Hult, G. T. M. (2015). Cross-national research and international business: An interdisciplinary path. *International Business Review*, 26(1), 89–101. <https://doi.org/10.1016/j.ibusrev.2016.05.008>
- Chang, S.-H., K.-Y. Wang, W.-H. Chih, and W.-H. Tsai (2012). Building customer commitment in business-to-business markets. *Industrial Marketing Management* 41(6): 940–950.
- Diefenbach, T. (2009). Are case studies more than sophisticated storytelling? : Methodological problems of qualitative empirical research mainly based on semi-structured interviews. *Quality and quantity* 43(6): 875-894.
- Gummerus, Johanna; Koskull, Catharina Von and Kowalkowski, C. (2017). Relationship Marketing : Past , Present and Future. *Journal of Services Marketing*, 31(1). <https://doi.org/10.1108/JSM-12-2016-0424>
- Gummesson, E. (2017). From Relationship Marketing to Total Relationship Marketing and Beyond. *Journal of Services Marketing*, 31(1).
- Gupta, A. and Sahu, M. (2012). A Literature review and classification of relationship marketing research. *International Journal of Customer Relationship Marketing and Management* 3 (1): 56-81.
- Kim, S., J. Hibbard, and S. Swain (2011). Commitment in marketing channels: Mitigator or aggravator of the effects of destructive acts? *Journal of Retailing* 87(4): 521–539.
- Lagrosen, S. and Lagrosen, Y. (2012). Trust and quality management: Perspectives from marketing & organisational learning. *Total Quality Management & Business Excellence*. 23 (1): 13-26
- Martins, M. L. (2015). Lusofonia e interculturalidade- Promessa e Travessia. Edições Húmus.
- Miocevic, D. (2016). The antecedents of relational capital in key exporter-importer relationships An institutional perspective. *International Marketing Review*, 33(2), 196–218. <https://doi.org/http://dx.doi.org/10.1108/MRR-09-2015-0216>
- Miquel-Romero, J. M., Caplliure-Giner, E. M. and Adame- Sánchez, C. (2014). Relationship marketing management: Its importance in private label extension. *Journal of Business Research* 67: 667-672.
- Moriarty, J. (2011) *Qualitative Methods Overview*. Methods Review 1. NIHR School for Social Care Research. London: UK
- Raciti, M. M., and Dagger, T. S. (2017). Relationship marketing: looking backwards towards the future. *Journal of Services Marketing*, 31(1), 1–8. <https://doi.org/10.1108/08876045199500001>
- Saleh, M. A., Ali, M. Y. and Andaleeb, S. S. (2014). Explaining industrial importers' commitment from an emerging market perspective: theoretical and managerial insights, *Journal of Business & Industrial Marketing* 29(1): 45-62.
- Sheth, J. (2017). Revitalizing Relationship Marketing. *Journal of Services Marketing*, 31(1). <https://doi.org/dx.doi.org/10.1108/JSM-11-2016-0397>

## MULTI-CHANNEL AND OMNICHANNEL MARKETING: THE NEW TRENDS IN DIGITAL MARKETING COMMUNICATIONS

Amirkhanpour, Monaliz<sup>1</sup>; Vrontis, Demetris<sup>2</sup>

<sup>1</sup>Faculty of Business, Education and Professional Studies (BEPS), University of Gloucestershire, Cheltenham, UK

<sup>2</sup>Distance Learning Unit, University of Nicosia, Nicosia, Cyprus

### ABSTRACT

Minsker (2014) and Heinze et al. (2017) believe that traditional marketing campaigns are becoming obsolete after the widespread propagation of digital technologies such as social media and mobile devices which transform passive brand consumption to active brand engagement and passive consumers to active digital consumers. Snyder (2011), Amirkhanpour et al. (2014), Yadav et al. (2015), and Lamberton and Stephen (2016) believe that mobile marketing fails as an isolated channel; it works best when integrated with other digital channels especially social media to form a multi-channel marketing strategy. In multi-channel marketing, marketers directly invest in several channels such as social media, email, mobile apps, a physical and/or online store to target customers. Smith (2017) states that the goal of multi-channel marketing is to build a strong and unique marketing strategy for each channel to target customers based on their specific preferences (Figure 1).

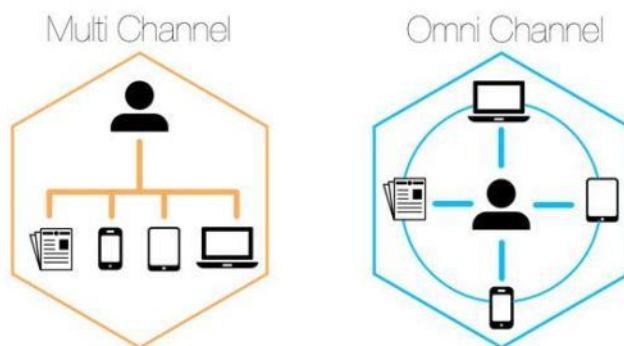

Figure 1: Illustration of Multi-Channel and Omnichannel Marketing

Source: Smith (2017)

As shown in Figure 1, omnichannel marketing is an advanced form of multi-channel marketing with a balanced approach. This form of marketing views the entire business experience from the customers' perspective because it keeps the customer at the centre of its business model by seamlessly coordinating positive customer experience across multiple channels. Marketers are increasingly combining mobile marketing with social media to deepen their interactions with consumers because it is estimated that by 2023, more than a billion people will access their favourite social networks using smartphones. Therefore, marketing campaigns should pay extra attention to this fundamental

transition by first understanding the preferences of their digital customers (Charlesworth, 2015; Vrontis et al., 2016; Brown, 2017; Hogberg, 2017).

The purpose of this research is to investigate the role and importance of the new trends in digital marketing communications especially within the mobile marketing domain. This will be achieved by exploring the significance of adopting a multi-channel or omnichannel marketing approach; investigating the role of social media and advanced mobile devices such as smartphones in selecting the appropriate marketing strategy; and proposing a conceptual framework towards its utilization in the wider context of strategic marketing. The research at this stage of development is theory-based and enhanced by secondary data. Theoretical considerations from the literature are further conceptually developed to construct a mobile marketing provisional framework for empirical validation. Furthermore, the research presents some gaps and inconsistencies which were identified by the researchers during the systematic review of qualified literature sources. The most important research gap is that the topic of mobile marketing via smartphones has attracted little attention even though it is important to both marketing executives and marketing researchers, but marketers are simply basing their decisions on anecdotal case studies and reports published in the popular press (Persaud and Azhar, 2012). Moreover, there is no commonly accepted framework for mobile marketing because a proper conceptualization of mobile marketing is still missing. Vrontis et al. (2016) and Smith (2017) state that there is no agreement on an explicit definition of mobile marketing that captures the true nature of the phenomenon. Therefore, the scope of mobile marketing is still vague. The mobile marketing domain requires continual researcher attention due to the rapidly changing nature of the technology infrastructure and the business environments because the existing strategies and business models can quickly become obsolete due to the emergence of new technologies and consumer trends (Oztas, 2015; Seema and Joyce, 2015). Although there is substantial progress in the field of mobile marketing, academic research is still in its infancy and can offer fruitful research avenues.

Methodologically, the research is theory based and enhanced by secondary data. The theoretical findings are further conceptually developed to construct a digital marketing provisional framework which will be mainly based on mobile marketing communications. Both the framework and its underlying theoretical foundation will be primarily validated through interviews with specialists and customer online surveys. The interviewees act as controls and enhancers of the theoretical development and framework. The research outcomes do add to the growing knowledge concerning mobile marketing and its role as a new digital channel in brand innovation. Furthermore, they will set the basis for a more refined understanding through a more comprehensive perspective on the topic.

*Keywords: marketing communications, digital marketing, digital channels, multi-channel marketing, omnichannel marketing, social media marketing, mobile marketing, digital consumers*

## REFERENCES

- Amirkhanpour, M., Vrontis, D. and Thrassou, A. (2014), "Mobile Marketing: A Contemporary Strategic Perspective", *International Journal of Technology Marketing (IJTM) - Special Issue on Building New Business Models for Success*, Vol. 9, No. 3, pp. 252-269
- Brown, R. (2017), "Location-based marketing: the pitfalls and promise of retail campaigns", [Internet] *Mobile Marketer* Available from: <http://www.mobilemarketer.com/news/location-based-marketing-the-pitfalls-and-promise-of-retail-campaigns/440927/> [Accessed 24 April 2017]
- Charlesworth, A. (2015), *An Introduction to Social Media Marketing*, Routledge
- Heinze, A., Fletcher, G., Rashid, T. and Cruz, A. (2017), *Digital and Social Media Marketing: A Results-Driven Approach*, New York: Routledge Taylor and Francis Group, pp. 3-63
- Hogberg, K. (2017), "Challenges of Social Media Marketing – An Explorative International Study of Hotels", *International Journal of Technology Marketing*, Vol. 12, No. 2, pp. 127-141
- Lamberton, C. and Stephen, A. T. (2016), "A thematic exploration of digital, social media, and mobile marketing: research evolution from 2000 to 2015 and an agenda for future inquiry", *Journal of Marketing: AMA/MSI Special Issue*, Vol. 80, pp. 146-172, DOI: 10.1509/jm.15.0415
- Minsker, M. (2014), *The Road to Omni-Channel Marketing Success*, CRM Magazine, pp. 20-24
- Oztas, Y.B.B. (2015), "The increasing importance of mobile marketing in the light of the improvement of mobile phones, confronted problems encountered in practice, solution offers and expectations", *Procedia Social and Behavioural Sciences*, Vol. 195, pp. 1066-1073
- Persaud, A. and Azhar, I. (2012), "Innovative mobile marketing via smartphones: are consumers ready?", *Marketing Intelligence and Planning*, Vol. 30, No. 4, pp. 418-443
- Seema, V. and Joyce, J. (2015), "Consumer attitudes toward mobile marketing and its impact on customers", *International Journal of Information, Business and Management*, Vol. 7, No. 2, pp. 44-62
- Smith, S. (2017), "A brief look at multichannel vs omnichannel marketing" [Internet], *Customer Think*, Available from: <http://customerthink.com/a-brief-look-at-multichannel-vs-omnichannel-marketing/> [Accessed 17 May 2017]
- Snyder, M. (2011), "Get Started in Mobile Marketing: 4 Insights to Guide your Strategy", *Marketing Sherpa's Top 5 Mobile Marketing Case Studies and How To's* [Internet]. Marketing Sherpa LLC Available from: <http://www.sherpastore.com> [Accessed 4 March 2012]
- Vrontis, D., Thrassou, A. and Amirkhanpour, M. (2016), "B2C smart retailing: a consumer-focused value-based analysis of interactions and synergies", *Technological Forecasting and Social Change*, <http://dx.doi.org/10.1016/j.techfore.2016.10.064>
- Yadav, M., Joshi, Y. and Rahman, Z. (2015), "Mobile social media: the new hybrid element of digital marketing communications", *Procedia Social and Behavioural Sciences*, Vol. 189, pp. 335-343



## MEASURING THE ECONOMIC EFFECTS OF TOURISM: THE CASE STUDY OF ITALY

**Andreottola, Francesco; Massaro, Maria Rita**

<sup>1</sup>National Research Council of Italy, Institute for Research on Innovation and Services for Development (IRISS-NCR), Naples, Italy

<sup>2</sup>Dept.of Business Systems and Operations, University of Bedfordshire Business School, Luton, UK

### ABSTRACT

Tourism plays a relevant role in increasing the national GDP while fostering the local economies (Cortés-Jiménez, 2008; Economics, 2016; Polo & Valle, 2008; Rosignoli et al., 2013; Seetanah, 2011; UNWTO, 2013; Zhang et al., 2007). According the WTTC, the international tourism revenues in 2016 reached 2.306 billion dollars (WTTC, 2017) representing the 3.1% of the global GDP. This data is forecasted to rise by 3.8% to USD 2,394.2bn in 2017. Tourism represents a very peculiar industry since its offering includes a combination of different products and services; in fact, the opportunity to combine and diversify the basket of goods offered to tourists generates incomes over many sectors (Archer, 1984; Candela & Figini, 2012; Frechtling, 2013; Murillo et al., 2013). Tourists' per capita expenditure doubles or even triplicates when adding to the overnight costs the amount they spend making purchases on the territory (Europa Inform, 2004). Nevertheless, despite its importance for the national economies, it is problematic to estimate its impact for the lack of appropriate and exhaustive methodologies.

Due to the cultural and artistic richness and the variety of its landscapes, tourism is of high relevance also in Italy where the most reliable and acknowledged tourism data sources are those provided from Italian National Institute of Statistics (ISTAT) and from the Bank of Italy's Italian Exchange Office (UIC). There are also important surveys carried out from public organizations like the National Tourism Observatory (ONT), the Regional Observatories on Tourism or conducted by private institutes like the Tourism Studies Center (CST) in Florence, the International Center of Studies on Tourism (CISSET) in Venice, the Italian Touring Club, Unioncamere's National Tourism Research Institute (ISNART) and the private research center Mercury – Turistica.it. However, according the OCSE reports (2011), the Italian statistics are patchy, unreliable, not timely, neither detailed; as a consequence, they are of little are unsuitable and insufficient to provide a measurement of the overall impact that tourism has on the national economy.

In order to overcome these limits, different methods have been proposed such as the "Tourism Satellite Account" (TSA); thus in 2012 ISTAT set up the 'Italian Conto Satellite sul Turismo' (CST). The CST allows to measures the revenues generated by the touristic demand of services and goods while considers in details the components of the touristic demand and how this is related to other industries.

The CTS is designed according to the QMR 2008 standards developed by Eurostat, the United Nations Statistics Division, OCSE and UNWTO and consists of 10 indexes of which the Italian CST takes into account only the first 6. On the demand side CST considers inbound tourism, domestic tourism, outbound tourism and the internal tourism. On the supply side, CST takes into account the internal production and the added value by branch of activity. Finally, putting together the data on the internal touristic consumption together with those on the touristic supply, the CST determines the VAT of the tourism industry. Thanks to the CST, in 2010 it is calculated that the added value produced by the tourism related industries was € 82.833 million, corresponding to the 6% of the entire Italian added value. Tourism in Italy represents the 76, 8 % of the entire VAT, underlying how this sector is important (ISTAT, 2012).

Through a desk research and secondary data analysis, the paper discusses and compares the potentialities and limits of the official statistics and those offered by the CST methodology.

The finding outlines that CTS system overcomes some of the limitations of the existing statistics, but only measures the direct effects of tourism on other sectors, while it is still not possible to estimate the economic effects of tourism, in particular the indirect revenues. The reasons are many: a) the available official statistics does not fully capture the entire economic impact, as they cannot estimate the actual tourists' consumption; b) the tourism sector is a synthetic industry (Candle and Figini, 2012) that is tourists' demand for goods and services is satisfied by the offering from traditional and heterogeneous industries; c) the demand for tourist goods and services in a territory is difficult to distinguish from the demand for goods and services of residents; d) statistics cannot take into account when the local consumers became local visitors.

The main contributions of this work are: a. to provide an extensive and systematic overview on the existing official statistics, highlighting their features, potential and limits; b. to understand advantages and drawbacks of the TSA approach as implemented by the Italian CST.

The research outcome supports researchers and practitioners in identifying the tool that better fits with their information needs; the review, mapping the existing methodologies, supports also the private and public operators and the government in their decision-making and in the elaboration of effective business and policy strategies.

*Keywords: Tourism, Economic Impact, Tourism Satellite Accountant, Italy.*

## REFERENCES

Archer B.H., 1984, Economic impact: Misleading multiplier, *Annals of Tourism Research*, vol. 11, n. 3, pp. 517-518.  
Candela G., Figini P., 2012, *The Economics of Tourism Destinations*, Springer, Verlag Berlin Heidelberg.

- Cortés-Jiménez I., 2008, Which Type of Tourism Matters to the Regional Economic Growth? The Cases of Spain and Italy, *International Journal of Tourism Research*, vol. 10, pp. 127-139.
- European Travel Commission, (2016), *European Tourism In 2016: Trends & Prospects*, Brussels.
- Frechtling D.C., 2013, *The Economic Impact of Tourism. Overview and Examples of Macroeconomic Analysis*, UNWTO, Madrid.
- ISTAT, 2012, The first tourism satellite account, *Statistiche - Report*. Retrived from [http://www.istat.it/en/files/2012/09/Statistiche\\_Report\\_CST\\_inglese.pdf?title=The+First+Italian+Tourism+Satellite+Account+-+4+Jul+2012+-+Full+text.pdf](http://www.istat.it/en/files/2012/09/Statistiche_Report_CST_inglese.pdf?title=The+First+Italian+Tourism+Satellite+Account+-+4+Jul+2012+-+Full+text.pdf)
- OCSE, 2011, *Studi OCSE sul Turismo*, OECD, Italy.
- Polo C., Valle E., 2008, "An assessment of the impact of tourism in the Balearic Islands", *Tourism Economics*, vol. 14, n. 3, pp. 615-630.
- Seetanah B., 2011, Assessing the Dynamic Economic Impact of Tourism for Island Economies, *Annals of Tourism Research*, vol. 38, n. 1, pp. 291-308.
- Rosignoli S., Conti E., Viviani A., 2013, "Local Impact of Tourism: The Case of Tuscany", *Italian Journal of Regional Science*, vol.12, n.3, pp.89-110.
- UNWTO, 2013, *Annual Report 2012*.
- World Travel & Tourism Council, 2017, *Travel & Tourism. Economic Impact 2017 World*, London.
- Zhang J., Madsen B., Jensen-Butler C., 2007, "Regional Economic Impacts of Tourism: The Case of Denmark", *Regional Studies*, August, vol. 41.6, pp. 839-853.

## THE STATE OF UNIVERSITY – BUSINESS COOPERATION IN GREECE

Angelopoulou, Konstantina<sup>1</sup>, Tsoukatos, Evangelos<sup>2</sup>

<sup>1</sup>School of business, University of Nicosia, Cyprus

<sup>2</sup>School of Management and Economy, University of Applied Sciences of Crete, Greece and School of business, University of Nicosia, Cyprus

### ABSTRACT

This study aims to measure the level of University-Business Cooperation (UBC) in Greece from the perspective of the Higher Educational Institutions (HEIs). In addition the study investigates the factors influencing UBC and the level of development of the mechanisms that support and promote UBC, coming from strategies and policies of the HEIs.

### INTRODUCTION

The interactions between HEIs and Business have been described in the "Triple Helix" theory, according to which the linking of university-industry-government, is considered an important driver of knowledge-based economies, fostering innovation and economic development (Etzkowitz & Leydesdorff, 2000). In addition to teaching and research, universities are increasingly expected to take on technology transfer and commercialization as part of their mission (Rasumsen, 2006). Universities' relationships with industry are formed through a series of sequential transactions though the mechanisms of technology transfer, such as sponsored research, licenses, spin-off firms and the hiring of students (Bercovic & Feldman, 2006).

In the framework of European Union's growth strategy there is a clear emphasis on the development of linkages between Universities and Business, as a necessary contribution for the development and competitiveness of the European economy (European Commission, 2006). The "Innovation Union" flagship initiative of Europe 2020 Strategy, aims to improve framework conditions and access to funding for research and innovation so as to ensure that innovative ideas can be turned into products and services that create growth and jobs (European Commission, 2010). Moreover, in the context of EU cohesion policy Member States are invited to translate the EU targets to national targets and develop national strategies for economic growth and innovation.

University Business Cooperation (UBC) is defined as all types of direct and indirect, personal and non-personal interactions between HEIs and business for reciprocal and mutual benefit, including "Collaboration in R&D", "Commercialization of R&D results", "Mobility" (academics, students, business professionals), "Curriculum development", "Lifelong learning", "Entrepreneurship" and "Governance" (Davey et al., 2011). UBC was first investigated in 2011 at a European level (Davey et al., 2011). The

present study is being carried out for the first time at national level, covering the period of 2010-2015, during which several actions were implemented under the governmental policy for research and innovation.

## METHODOLOGY

The main research question is the situation of UBC in Greece, including the main factors influencing UBC and the mechanisms that support UBC, from the perspective of the Higher Educational Institutions. For the quantitative research method, a structured questionnaire was addressed to Academics and HEI representatives of all Greek Higher Educational Institutions, during January to May 2016. Of the entire sample of 242 respondents, 214 (88,4%) of them are Academics and 28 (11,6%) HEI representatives. Concerning the area of knowledge-research, 68,2% of the total respondents work in the field of engineering and natural sciences, 17% in the field of health and agricultural sciences, while 13,6% in the field of social sciences. For the extent of UBC development, units of measurement were used for each type of cooperation.

Table 1: Types of Cooperation in UBC and units of measurement

Type of Cooperation	Unit of Measurement	Type of Cooperation	Unit of Measurement
1.Cooperation in R&D	Number of Contracts/Research Contracts (under national/European/business funding)	2.Commercialization of R&D results	Number of patents/disclosures of inventions /licensing/spin-offs
3. Mobility (Academic-Student)	Number of movements (Temporary or permanent movement from HEIs to business and vice versa)	4.Curriculum development	Number of educational programs (courses, modules etc. by delegates from business and universities)
5.Lifelong learning	Number of educational programs (adult education, permanent / continuing, involving the acquisition of skills, knowledge attitudes and behaviours by HEIs' delegates	6.Entrepreneurship	Number of actions (for developing innovative thinking & entrepreneurship culture within the HEI)
7.Governance	Numbers of participants (business leaders and/or academics involved in decision-making boards of HEIs and firms) (correspondingly)		

The units of measurement were categorized into 3 groups each of which corresponds to a cooperation level (low, moderate, high). The questions addressed to Academics for the 5 types of UBC since the extent lies primarily with Academics' initiatives and willingness. For the next 2 types the questions addressed to HEI representatives since the extent of UBC lies with HEI's policies. Concerning factors (drivers, benefits and barriers), influencing UBC, respondents were asked to rate different factors through a 5 -point Likert scale. Referring to mechanisms that support UBC are including the

structures and approaches HEIs put in place in order to enhance UBC, as well as specific actions and operational activities undertaken by HEIs to support UBC. Respondents were asked to rate different mechanisms through a 5 -point Likert scale. A paired-samples t-test was conducted for the significance of the means difference.

## RESULTS

The results show that during the last five years, 55,8% of the academics of Greek higher educational institutions have cooperated with business in one at least type. The extent of UBC is mostly low for the 5 types, "*Collaboration in R&D*", "*Commercialization of R&D results*", "*Mobility*", "*Curriculum development*" and "*Lifelong learning*", while is medium for the 2 types of "*Entrepreneurship*" and "*Governance*".

Table 2. : Total view of UBC

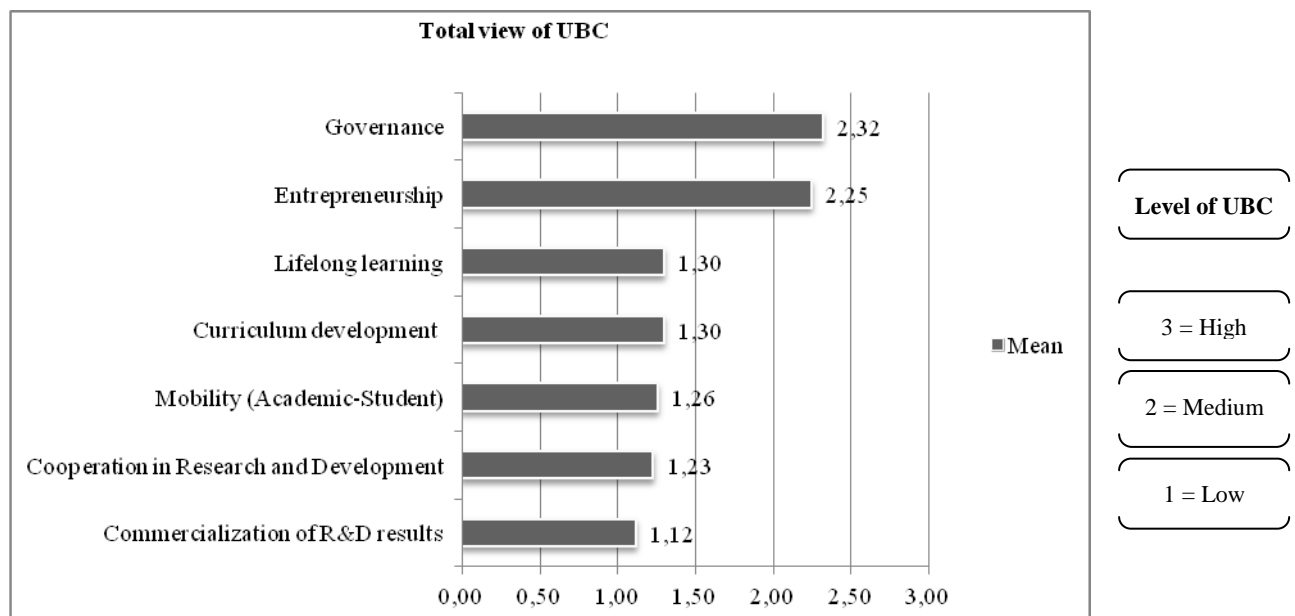

By comparing the above results with that of the European study, it seems that the results are similar, except for "*Collaboration in R&D*" and "*Mobility*" which are in a medium level, at European study. Concerning factors influencing UBC there are slight differences in the perception between Greek and European HEIs. The Drivers related to "*Access to funding resources*" and "*Employment opportunities for students*" are perceived to be of high importance in facilitation of UBC in Greece, while "*Mutual trust, Commitment and Respect*" are perceived to be highly important at European level. "*Bureaucracy within or external to the HEI*", "*Lack of financial resources of the business*" and "*Business lack awareness of HEI research activities/capabilities*" are identified to be the most important Barriers in developing UBC for Greek HEIs, while "*Lack of funding for UBC*" (either external or of HEI and business) is considered the most important at European level. Finally, for both Greek and European level "*Improvement of employability*

*of future students*" and *"Improvement of productivity at local and regional level"* are perceived to be the most important Benefits from developing UBC. Concerning mechanisms developed by HEIs' strategies, at European level seem to be a better level of development, with *"Career Offices"* and *"Alumni networks"* as the most developed structures, in a medium level, while operational activities such as *"Collaboration activities facilitating student interaction with business"* and *"Entrepreneurship education to students"* are the most prevalent activities. In Greece the above Structures and Operational Activities are also the most developed but in a lower level.

## CONCLUSIONS – DISCUSSION

In generally we could argue that the results of the study are promising for Greek HEIs. More than 55% of Academics cooperate with business in Greece, while they perceive there are important drivers and benefits in developing UBC. However, it seems that HEIs should focus more efforts on existing or developing mechanisms for supporting UBC. Except from the objective metrics of this study, qualitative elements should be taken into account since every type of cooperation needs different level of procedure difficulty to achieve. Also a similar study from the perspective of business should be valuable for comparison and deeper UBC understanding. It is expected that the study's findings will prove significant to those who are directly involved in this process, but especially for policy makers for development and innovation.

**Keywords:** *Universities, University–Business Cooperation, Technology Transfer, Entrepreneurship*

## REFERENCES

- Bercovitz J., Feldmann M., (2006) Entrepreneurial Universities and Technology Transfer: A Conceptual Framework for Understanding Knowledge-Based Economic Development, *The Journal of Technology Transfer*, 31, pp. 175–188.
- Davey, T., Baaken, T., Galan Muros, V., Meerman, A., (2011) "The State of European University -Business Cooperation", Science-to-Business Marketing Research Centre.
- Etzkowitz H., and Leydesdorff L. (2000) "The dynamics of Innovation: From National Systems and "Mode 2" to a Triple Helix of University-Industry-Government relations", *Research Policy*, 29, pp. 109-123.
- European Commission (2006), "Putting knowledge into practice: A broad-based innovation strategy for the EU", (COM2006) 502, Brussels.
- European Commission (2010), "EUROPE 2020: A strategy for smart, sustainable and inclusive growth", (COM2010) 2020, Brussels.
- Rasmussen E., Moen Ø, Gulbrandsen M. (2006), "Initiatives to promote commercialization of university knowledge", *Science Direct, Technovation* 26, pp. 518–533.

# **AUTONOMY, INNOVATION MATURITY AND INTRAPRENEURSHIP AS DRIVERS OF INNOVATION MANAGEMENT PROCESSES: EVIDENCE FROM THE WATER SECTOR**

**Annunziata, Eleonora<sup>1</sup>; Pellegrini, Chiara<sup>1</sup>; Rizzi, Francesco<sup>2</sup>; Frey, Marco<sup>1</sup>**

<sup>1</sup>Institute of Management, Scuola Superiore Sant'Anna, SSSA, Pisa, Italy

<sup>2</sup>Department of Economics, University of Perugia, UNIPG, Perugia, Italy and Institute of Management, Scuola Superiore Sant'Anna, SSSA, Pisa, Italy

## **ABSTRACT**

Water utilities are, by nature, adverse to risks of innovation. Despite that, the adoption of sustainable innovation by water utilities has the potential to improve environmental performance as well as open up new business opportunities. As a consequence, a great variety exists in the way water utilities internally develop innovation management processes that facilitate the adoption, introduction and development of innovation in their business operations.

Based on literature review and empirical data drawn from eleven case studies of Italian, Israeli and Spanish water utilities, this paper explores the factors that influence initiation, adoption and post adoption of innovation management processes. The study disentangles how external factors, i.e. regulation, market forces and environmental resilience, stimulate the adoption of innovation, and how organizational and individual factors drive the further development of innovation management processes. Among these factors, autonomy, innovation maturity and intrapreneurship differentiate water utilities in pro-active, reactive or hybrid. This categorization reflects diversity in both organizational policies and sustainable innovation management processes.

The study shows that the need to solve single contingencies is not a key driver for the implementation of innovation management processes, which instead depend on the organizations' capabilities to respond proactively to external pressures.

## **REFERENCES**

- Damanpour, F., & Gopalakrishnan, S. (1998). Theories of organizational structure and innovation adoption: the role of environmental change. *Journal of Engineering and Technology Management*, 15(1), 1-24.
- Damanpour, F. (1987). The adoption of technological, administrative, and ancillary innovations: Impact of organizational factors. *Journal of management*, 13(4), 675-688.
- Frambach, R. T., & Schillewaert, N. (2002). Organizational innovation adoption: A multi-level framework of determinants and opportunities for future research. *Journal of business research*, 55(2), 163-176.
- Fuenfschilling, L., & Truffer, B. (2014). The structuration of socio-technical regimes—Conceptual foundations from institutional theory. *Research Policy*, 43(4), 772-791.
- Khanagha, S., Volberda, H., Sidhu, J., & Oshri, I. (2013). Management innovation and adoption of emerging technologies: The case of cloud computing. *European Management Review*, 10(1), 51-67.



- Oliveira, T., & Martins, M. F. (2011). Literature review of information technology adoption models at firm level. *The Electronic Journal Information Systems Evaluation*, 14(1), 110-121.
- Quezada, G., Walton, A., & Sharma, A. (2016). Risks and tensions in water industry innovation: understanding adoption of decentralised water systems from a socio-technical transitions perspective. *Journal of Cleaner Production*, 113, 263-273.
- Rogge, K. S., Schleich, J., Haussmann, P., Roser, A., & Reitze, F. (2011). The role of the regulatory framework for innovation activities: the EU ETS and the German paper industry. *International Journal of Technology, Policy and Management*, 11(3-4), 250-273.
- Santos-Vijande, M. L., & Álvarez-González, L. I. (2007). Innovativeness and organizational innovation in total quality oriented firms: The moderating role of market turbulence. *Technovation*, 27(9), 514-532.
- Sawang, S., & Unsworth, K. L. (2011). Why adopt now? Multiple case studies and survey studies comparing small, medium and large firms. *Technovation*, 31(10), 554-559.
- Tutusaus, M., Schwartz, K., & Smit, S. (2016). The ambiguity of innovation drivers: The adoption of information and communication technologies by public water utilities. *Journal of Cleaner Production*, 1-7.
- Verhoest, K., Peters, B. G., Bouckaert, G., & Verschuere, B. (2004). The study of organisational autonomy: a conceptual review. *Public administration and development*, 24(2), 101-118.
- Volberda, H. W., Van Den Bosch, F. A., & Mihalache, O. R. (2014). Advancing management innovation: Synthesizing processes, levels of analysis, and change agents. *Organization Studies*, 35(9), 1245-1264.
- Weber, D. M., & Kauffman, R. J. (2011). What drives global ICT adoption? Analysis and research directions. *Electronic commerce research and applications*, 10(6), 683-701.
- Waarts, E., Everdingen, Y. M., & Hillegersberg, J. (2002). The dynamics of factors affecting the adoption of innovations. *Journal of Product Innovation Management*, 19(6), 412-423.

# MANAGEMENT OBJECTIVES IN M&A DECISIONS: A DEPARTURE FROM RATIONALITY?

Arnold, Nicole<sup>1</sup>, Bengoa, S. D.<sup>2</sup>

<sup>1</sup>University of Gloucestershire, Cheltenham, UK

<sup>2</sup>University of Applied Management Studies, Mannheim, Germany

## ABSTRACT

## INTRODUCTION

Strategic decision-making (SDM) has been part of numerous research and theoretical discussion (Zafirovski, 2008, Shephard and Rudd, 2014, Mitchell et al., 2011, Rahman and De Feis, 2009). More recently, the debate departs from pure rational models accepting that executive's traits, behaviours, experiences, and values affecting the strategic outcomes (Greve, 2013, Magni, 2009, Cohen and Kudryavtsev, 2012). Especially in mergers and acquisitions (M&A) research indicates that merger activity as well as, the underlying organizational motives for the investment' decision is at least bounded rational (Camerer et al., 2004). This emphasizes the view that those who make the strategic M&A decision might impose potential behavioural effects. Thus, the current research directs the perspective towards personal characteristics of the decision-maker and examines factors associated with a cognitive-experiential perception in strategic M&A decisions.

As suggested by earlier research, cognitive aspects of strategy formulation e.g. hubris (Liu and Xie, 2011, Haynes et al., 2010), overconfidence (Ferris et al., 2013, Dittrich et al., 2005), narcissism (Rosenthal and Pittinsky, 2006) and emotions (Lerner et al., 2015, Seo and Feldmann Barrett, 2007), are frequently underrepresented in strategic (investment) decision-making models. At the same time, it exists extensive research on bounded rationality and administrative behaviour (Harstad and Selten, 2013, Lee, 2011, Magni, 2009, Gigerenzer, 2016a). Therefore, the research aims to expand existing theoretical approaches of non-rational decision-making into the field of strategic decision in the specific organizational context of M&A. The study focusses on accessing executive's decision-making behavior and the cognitive-experiential factors influencing it. It seeks to support the argument of managers' personal characteristics e.g. inspiring strategy formulation and decision (Finkelstein et al., 2009) and explores these characteristics within the specific complex field of M&A. This overarching qualitative research contributes to a new holistic perspective, since almost all of the existing mainstream literature applied quantitative methods by analyzing single factors separately.

## LITERATURE REVIEW

Cognitive experiential theory (CET) is used as the basic theoretical framework for this research and expanded into the field of strategic M&A decisions. It was introduced by Epstein (1973, 2016) as an implicit self-theory, i.e. it directs people's behaviour and they prosper and adapt automatically through continuous experience, including self, other people as well as the impersonal and their interaction. Supporting the basic assumptions of non-rational executive's behaviour in this study, CET has particularly incorporated adaptive unconscious action, i.e. the experiential system, besides the rational system.

Focussing on strategic decision in M&A investment, the literature review shows that explanations of merger activity over time as well as, organizational strategic processes allow for managerial discretion. Additionally, recent research departs more and more from the overall rational models of SDM. Mergers occur in periodic waves with particular characteristics and different amplitudes for each cycle. Beside neoclassic concepts (Gort, 1969, Jovanovic and Rousseau, 2002) there emerged behavioural models that identified positive relation between merger activity and misvaluations (Tobin, 1969, Shleifer and Vishny, 2003, Rhodes-Kropf and Viswanathan, 2004, Gugler et al., 2012) as well as, managerial discretion and optimistic beliefs of the buyer (Petmezas, 2009, Morellec and Zhdanov, 2005). While current research does not provide for a full or more holistic explanation of the phenomenon, it indicates, that more emphasis shall be placed on the potential effects on M&A activity, that may arise from organizational behaviour, moreover from the actual decision maker's strategic M&A decision.

Besides the notion of the decision-maker acting economically rational, the administrative man (Simon, 1997) with cognitive limitations, has gained a position in social sciences. Emergent concepts include risk and uncertainty (Tversky and Kahneman, 1981, Kahneman and Tversky, 1979, Bruhin et al., 2010), heuristics (Gigerenzer and Gaissmaier, 2011, Gigerenzer, 2016b, Kahneman et al., 1982), hubris (Liu and Xie, 2011, Haynes et al., 2010, Hiller and Hambrick, 2005, Roll, 1986), upper echelons (Bromiley and Rau, 2015). Additionally, agency motives (Grinstein and Hribar, 2004) as well as, political behaviours of the top management team (Bailey and Peck, 2013). At the same time personal characteristics and the organizational and personal environment as well as private and professional experiences influencing the person, including culture (Doidge et al., 2007, Li et al., 2013) and behavioural patterns (Hofstede et al., 2012) are considered to influence ones actions.

It is shown that literature only allows for a set of models and management theories but social sciences have missed to provide a comprehensive view of environmental, organizational conditions, and the individual capacities of the decision maker. Conclusively, this research supports the view that there is a requirement of integrating cognitive-experiential elements of CET into rational strategic decision-

making. It examines under which conditions experiential factors specifically effect executive`s economic rationality in strategic M&A decisions as well as potential interdependencies between the individual factors.

## **METHODOLOGY**

The investigation uses a qualitative and exploratory approach to reveal the facets of behavioural, non-rational motivation in strategic M&A decisions. Qualitative research uncovers subjective meaning where social reality constitutes particular, culturally and historically derived meaning and relevance structures determining the behaviour of the people experiencing it (Greenfield et al., 2007). A qualitative approach is uniquely suited to explore new avenues (Amis and Silk, 2007, Macenzie and Knipe, 2006, Marshall and Rossmann, 2011, Wertz, 2011) of human experience and social perception in behaviourally affected M&A decisions since participants are permitted to express meaning and relevance in their own words rather than being restricted to 'predetermined categories' created by a researcher in relation to hypothesized cognitive characteristics. Also, this methodology corresponds to both the complex context of the research and its central questions, where in-depth investigation of individuals' psychological constructions illuminate individuals' varied understandings, tacit processes and hidden beliefs in the context of their surrounding environment of exogenous economic flows and endogenous organisational behaviour.

## **CONCLUSION**

This research is part of a doctoral thesis and currently work in progress. Once results are available, this study provides for a new perspective in SDM and organizational behaviour. The findings shall provide for a more precise formulation of the social phenomena of behavioural perspectives in M&A investment decision-making and shall motivate scientists to take a more holistic view by integrating cognitive, experiential and social behaviours in their theoretical models. Additionally, it helps practitioners to become more aware of their behaviours to improve their business practice and power in decisive strategic decision formulation.

*Keywords: bounded rationality, cognitive experiential theory, decision-making, mergers and acquisitions, non-rationality, organizational behaviour, personality, strategic decisions.*

## **REFERENCES**

AMIS, J. M. & SILK, M. L. 2007. The Philosophy and Politics of Quality in Qualitative Organizational Research. *Organizational Research Methods*, 11, 456-480.

- BAILEY, B. C. & PECK, S. I. 2013. Boardroom Strategic Decision-Making Style: Understanding the Antecedents. *Corporate Governance: An International Review*, 21, 131-146.
- BROMILEY, P. & RAU, D. 2015. Social, Behavioral, and Cognitive Influences on Upper Echelons During Strategy Process: A Literature Review. *Journal of Management*, XX.
- BRUHIN, A., FEHR-DUDA, H. & EPPER, T. 2010. Risk and Rationality: Uncovering Heterogeneity in Probability Distortion. *Econometrica*, 78, 1375-1412.
- CAMERER, C. F., LOEWENSTEIN, G. & RABIN, M. 2004. *Advances in Behavioral Economics*, Princeton, Princeton University Press.
- COHEN, G. & KUDRYAVTSEV, A. 2012. Investor Rationality and Financial Decisions. *The Journal of Behavioral Finance*, 13, 11-16.
- DITTRICH, D., GÜTH, W. & MACIEJOVSKY, B. 2005. Overconfidence in Investment Decisions: An Experimental Approach. *The European Journal of Finance*, 11, 479-491.
- DOIDGE, C., KAROLYI, G. A. & STULZ, R. M. 2007. Why do countries matter so much for corporate governance? *Journal of Financial Economics*, 86, 1-39.
- EPSTEIN, S. 1973. The Self-Concept Revisited Or a Theory of a Theory. *American Psychologist*, 28.
- EPSTEIN, S. 2016. *Cognitive-Experiential Theory. An Integrative Theory of Personality*, Oxford, UK, Oxford University Press.
- FERRIS, S. P., JAYARAMAN, N. & SABHERWAL, S. 2013. CEO Overconfidence and International Merger and Acquisition Activity. *Journal of Financial and Quantitative Analysis*, 48, 137-164.
- FINKELSTEIN, S., HAMBRICK, D. C. & CANNELLA, B. 2009. *Strategic Leadership. Theory and Research on Executives, Top Management, Teams, and Boards*, Oxford, New York, Oxford University Press.
- GIGERENZER, G. 2016a. Rationality without Optimization: Bounded Rationality. In: MACCHI, L., BAGASSI, M. & VIALE, R. (eds.) *Cognitive unconscious and human rationality*. Cambridge, MA: MIT Press.
- GIGERENZER, G. 2016b. Towards a Rational Theory of Heuristics. In: FRANTZ, R. & MARSH, L. (eds.) *Minds, models, and milieu: Commemorating the centennial of birth of Herbert Simon*. New York: Palgrave Macmillan.
- GIGERENZER, G. & GAISSMAIER, W. 2011. Heuristic Decision Making. *Annual Review of Psychology*, 62, 451-482.
- GORT, M. 1969. An Economic Disturbance Theory of Mergers. *Quarterly Journal of Economics*, 83, 624-642.
- GREENFIELD, B. H., GREENE, B. & JOHANSON, M. A. 2007. The use of qualitative research techniques in orthopedic and sports physical therapy: Moving towards postpositivism. *Physical Therapy in Sport*, 8, 44-54.
- GREVE, H. R. 2013. Microfoundations of Management: Behavioral Strategies and Levels of Rationality in Organizational Action. *The Academy of Management Perspectives*, 27, 103-119.
- GRINSTEIN, Y. & HRIBAR, P. 2004. CEO Compensation and Incentives: Evidence from M&A Bonuses. *Journal of Financial Economics*, 73, 119-143.
- GUGLER, K., MUELLER, D. C. & WEICHELBAUMER, M. 2012. The determinants of merger waves: An international perspective. *International Journal of Industrial Organization*, 30, 1-15.
- HARSTAD, R. M. & SELTEN, R. 2013. Bounded-Rationality Models: Tasks to Become Intellectually Competitive. *Journal of Economic Literature*, 51, 496-511.
- HAYNES, K. T., CAMPBELL, J. T. & HITT, M. A. 2010. Greed, Hubris and Board Power: Effects on Firm Outcomes. *ACAD MANAGE PROC*, 1, 1-6.
- HILLER, N. J. & HAMBRICK, D. C. 2005. Conceptualizing Executive Hubris: The Role of (Hyper-)Core Self-Evaluations in Strategic Decision-Making. *Strategic Management Journal*, 26, 297-319.
- HOFSTEDE, G., HOFSTEDE, G. J., MAYER, P., SONDERMANN, M. & LEE, A. 2012. *Denken, Globales Handeln. Interkulturelle Zusammenarbeit und globales Management*, München, Verlag C.H. Beck.
- JOVANOVIC, B. & ROUSSEAU, P. L. 2002. The Q-Theory of mergers. *American Economic Review Papers and Proceedings*, 198-204.
- KAHNEMAN, D., SLOVIC, P. & TVERSKY, A. 1982. *Judgement Under Uncertainty: Heuristics and Biases*, New York, Cambridge University Press.
- KAHNEMAN, D. & TVERSKY, A. 1979. Prospect Theory: An analysis of decision under risk. *Econometrica*, 47, 263-292.
- LEE, C. 2011. Bounded Rationality and The Emergence of Simplicity Amidst Complexity. *Journal of Economic Surveys*, 25, 507-526.
- LERNER, J. S., VALDESOLO, P. & KASSAM, K. S. 2015. Emotion and Decision Making. *Annual Review of Psychology*, 66, 799-823.
- LI, K., GRIFFIN, D., YUE, H. & ZHAO, L. 2013. How does culture influence corporate risk-taking? *Journal of Corporate Finance*, 23, 1-22.
- LIU, H. & XIE, L. 2011. CEO Hubris, Firm Investment and Firm Performance. *Psychology Research*, 05, 68-72.

- MACENZIE, N. & KNIPE, S. 2006. Research dilemmas: Paradigms, methods and methodology. *Issues In Educational Research*, 16, 193-205.
- MAGNI, C. A. 2009. Investment decisions, net present value and bounded rationality. *Quantitative Finance*, 9, 967-979.
- MARSHALL, C. & ROSSMANN, G. B. 2011. *Designing Qualitative Research* Thousand Oaks, SAGE Publications.
- MITCHELL, J. R., SHEPHERD, D. A. & SHARFMAN, M. P. 2011. Erratic Strategic Decision: When and Why Managers are Inconsistent in Strategic Decision Making. *Strategic Management Journal*, 32, 683-704.
- MORELLEC, E. & ZHDANOV, A. 2005. The dynamics of mergers and acquisitions. *Journal of Financial Economics*, 77, 649-672.
- PETMEZAS, D. 2009. What drives acquisitions? Market valuations and bidder performance. *Journal of Multinational Financial Management*, 19, 54-74.
- RAHMAN, N. & DE FEIS, G. L. 2009. Strategic decision-making: models and methods in the face of complexity and time pressure. *Journal of General Management*, 35, 43-60.
- RHODES-KROPF, M. & VISWANATHAN, S. 2004. Market valuations and merger waves. *Journal of Finance*, LIX, 2685-2718.
- ROLL, R. 1986. The Hubris Hypothesis of Corporate Takeovers. *Journal of Business*, 59.
- ROSENTHAL, S. A. & PITTINSKY, T. L. 2006. Narcissistic leadership. *The Leadership Quarterly*, 17, 617-633.
- SEO, M. Y.-G. & FELDMANN BARRETT, L. 2007. Being Emotional during Decision Making - Good or Bad? An empirical investigation. *Academy of Management*, 50, 923-940.
- SHEPHARD, N. G. & RUDD, J. M. 2014. The Influence of Context on the Strategic Decision-Making Process: A Review of the Literature. *International Journal of Management Reviews*, 16, 340-364.
- SHLEIFER, A. & VISHNY, R. W. 2003. Stock market driven acquisitions. *Journal of Financial Economics*, 32, 265-275.
- SIMON, H. A. 1997. *Administrative Behavior. A Study of Decision-making Processes in Administrative Organisations*, New York, Free Press.
- TOBIN, J. 1969. A General Equilibrium Approach To Monetary Theory. *Journal of Money, Credit and Banking*, 1, 15-29.
- TVERSKY, A. & KAHNEMAN, D. 1981. The Framing of Decisions and the Psychology of Choice. *Science*, New Series, 211.
- WERTZ, F. J. 2011. A Phenomenological Psychological Approach to Trauma and Resilience. In: WERTZ, F. J., CHARMAZ, K., MCMULLEN, L. M., JOSSELYN, R., ANDERSON, R. & MCSPADDEN, E. (eds.) *Five Ways of Doing Qualitative Analysis*. New York: Guilford Press.
- ZAFIROVSKI, M. Z. 2008. Classic and Neoclassic Conceptions of Rationality: Findings of an Exploratory Survey. *The Journal of Socio-Economics*, 37, 789-820.

## COMMUNICATION SKILLS OF ENTRY-LEVEL ACCOUNTANTS IN GREECE

Asonitou, Sofia<sup>1</sup>; Tourna, Eleni<sup>1</sup>; Koukouletsos, Kostas<sup>2</sup>, Touloumis, Konstantinos<sup>1</sup>

<sup>1</sup>Business Administration Department, Athens University of Applied Sciences, Athens, Greece

<sup>2</sup>Computer Engineering Department, Piraeus University of Applied Sciences, Athens, Greece

### ABSTRACT

The aim of the present study is to explore the communication skills and tasks of the entry-level accountants (ELAs) in Greece. Prior research worldwide and in Greece has proven the gap between the generic skills of accounting graduates and the skills required by employers (Hassall et al., 2001; Willcoxson et al., 2010; Yap and Yong, 2014; Andre and Smith, 2014). Research in Greece has revealed analogous results (Mandilas et al., 2014; Asonitou, 2014, 2015) however no study has so far examined the needs of local industry regarding the communication requirements for entry-level accountants as already investigated in other settings (Hassall et al., 2010; Siriwardane and Durden, 2014). This study adapts the questionnaire of Siriwardane et al. (2015) for the Greek context and explores the results and their implications for the local environment. The instrument is addressed to experienced accounting practitioners of international and national firms, who have supervised ELAs in order to survey the frequency of communications tasks performed by ELAs, the importance of the identified communication skills and attributes, and the ELAs communication skills and performance. The study unveils implications for the accounting education in undergraduate, graduate and professional level.

*Keywords: accounting education, communication, skills, competences, industry needs, entry-level accountants*

### REFERENCES

- Andre, S. M. and B. L. Smith (2014), "Enhancing the Undergraduate Accounting Curriculum to Augment Core Competencies", *Advances in Accounting Education: Teaching and Curriculum Innovations*, Vol. 15, pp. 59-78.
- Asonitou, S. (2014) "Embedding generic employability skills in Greek Accounting Education Studies: impediments and development", Unpublished PhD, Sheffield Hallam University, Business School
- Asonitou, S. (2015), "Barriers to the Teaching of Skills in the Greek Higher Education Accounting Courses: Insight from Accounting Teachers", *International Journal of Strategic Innovative Marketing*, Vol. 3, pp.14-26
- Hassall, T., Joyce, J., Montano, A. J. L., and Anes, D. A. J. (2001), "The employers' priorities, Vocational skills and capabilities for management accountants", *Industry and Higher Education*, pp. 421-429
- Hassall, T., Joyce, J., Ottewill, R., Arquero, J., and Donoso, J. (2000), "Communication apprehension in UK and Spanish Business and accounting students", *Education and Training*, Vol. 42, No 2, pp. 93-100
- Mandilas A., Kourtidis, D. and Petasakis, Y. (2014), "Accounting Curriculum and market needs", *Education and Training*, Vol. 56, No. 8/9, pp. 776-794
- Siriwardane, H. P., Low, K. – Y., and Blietz, D. (2015), "Making entry-level accountants better communicators: A Singapore-based study of communication tasks, skills, and attributes", *Journal of Accounting Education*, Vol. 33, pp. 332-347
- Siriwardane, H. P and Chris H. Durden (2014), "The Communication Skills of Accountants: What we Know and the Gaps in our Knowledge", *Accounting Education*, Vol. 23, No, pp. 119-134

Willcoxson, L., Wynder, M., and Laing, K. G. (2010), "A Whole-of-program Approach to the Development of Generic and Professional Skills in a University Accounting Program", *Accounting Education: An International Journal*, Vol. 19, No1/2, pp. 65-91

Yap, C., Ryan, S., and Yong, J. (2014), "Challenges Facing Professional Accounting Education in a Commercialised Education Sector", *Accounting Education: An International Journal*, Vol. 23, No 6, pp. 562-581



## **IMPACT OF CORPORATE GOVERNANCE MECHANISM ON FIRM PERFORMANCE: EVIDENCE FROM AN EMERGING MARKET**

**Ataay, Aylin**

Galatasaray University, Management Department, Istanbul Turkey

### **ABSTRACT**

The last decade has witnessed an explosion in the number of studies on the corporate governance around the world. Much corporate governance research has been grounded from agency theory. The central premise of agency theory is that executives as agents of shareholders (principals) may engage in self-serving behavior that can be inconsistent with the shareholders' wealth maximization objectives. To constrain or mitigate this managerial opportunism, shareholders may use a diverse range of corporate governance mechanisms, including monitoring by boards of directors or large outside shareholders. In addition, equity-based managerial incentives may also help to align the interests of agents and principals. Finally, managerial opportunism can be constrained by external markets, such as the threat of takeover, product competition, and managerial labor markets.

A mounting number of investigations correspondingly struggles to comprehend cross-national differences in corporate governance. However, such approaches remain problematic because institutions modify the basic principal-agent relationship in ways that require specific contextualization. Institutions matter for corporate governance because these create different sets of incentives or resources for monitoring, as well as embody different sets of values and normative understandings about the nature of the firm. The specific conditions of the "Anglo-Saxon model" constitute the exception rather than the rule when looking at Continental Europe, East Asia, India, and emerging economies in other regions such as Turkey. For example, Turkey has a particularly different system of corporate governance from Anglo-Saxon and continental Europe countries counterparts. In addition to the highly concentrated ownership structure, few dominant shareholders control Turkish listed firms. This situation, together with the absence of a practical market for external corporate control due to the low level of development of capital markets, the lack of dual organic structures of internal governance and the low level of legal protection available to minority shareholders may significantly facilitate the controlling shareholders to obtain extra benefits at the expense of minority shareholders, substitute control with executive compensation and weaken managerial power of executives.

Current study aim to investigate complementarities and substitutions between different corporate governance mechanisms in listed companies and their effects on firm performance in

Turkey. Current academic studies have tended to focus on particular aspects of corporate governance in isolation. Our aim is to look at corporate governance mechanisms holistically as a system of interdependent elements, and to better understand how drivers of 'good' corporate governance are supported or substituted by other complementary mechanisms. More specifically, the ownership concentration, board leadership structure, board size and composition, managerial shareholdings, institutional shareholdings, and family shareholdings are investigated. Some early evidence reveals that the proportion of independent directors on the board is negatively related to the percentage of family shareholdings. Board size shows a significant negative relation with all the CG mechanisms except the firm performance (ROE). The finding that the family controlled firms have lower debt ratio than the institutionally controlled firms. The capital market seems to complement the institutional shareholdings, family shareholdings, and ownership concentration in monitoring the CEO and board of directors.

## REFERENCES

- Aguilera, R. A., I. Filatotchev, H. Gospel and G. Jackson (2008). 'An organizational approach to comparative corporate governance: costs, contingencies, and complementarities', *Organization Science*, 19, pp. 475–492.
- Bruton, G., I. Filatotchev, S. Chahine and M. Wright (2010). 'Governance, ownership structure and performance of IPO firms: the impact of different types of private equity investors and institutional environments', *Strategic Management Journal*, 31, pp. 491–509.
- Carpenter, M. A. and J. D. Westphal (2001). 'The strategic context of external network ties: examining the impact of director appointments on board involvement in strategic decision-making', *Academy of Management Journal*, 44, pp. 639–660.
- Carpenter, M. A., T. G. Pollock and M. M. Leary (2003). 'Testing a model of reasoned risk-taking: governance, the experience of principals and agents, and global strategy in high-technology IPO firms', *Strategic Management Journal*, 24, pp. 803–820.
- Daily, C. M. and D. R. Dalton (1992). 'The relationship between governance structure and corporate performance in entrepreneurial firms', *Journal of Business Venturing*, 7, pp. 375–386.
- Daily, C., D. Dalton and N. Rajagopalan (2003). 'Governance through ownership: centuries of practice, decades of research', *Academy of Management Journal*, 46, pp. 115–158.
- Dalton, D. R., C. M. Daily, A. E. Ellstrand and J. L. Johnson (1998). 'Meta-analytic review of board composition, leadership structure, and financial performance', *Strategic Management Journal*, 19, pp. 269–290.
- Dalton, D. R., C. M. Daily, J. L. Johnson and A. E. Ellstrand (1999). 'Number of directors and financial performance: a meta-analysis', *Academy of Management Journal*, 42, pp. 674–686.
- Fama, E. F. (1980). 'Agency problems and the theory of the firm', *Journal of Political Economy*, 88, pp. 288–307.
- Fama, E. F. and M. C. Jensen (1983). 'Separation of ownership and control', *Journal of Law and Economics*, 26, pp. 301–325.
- Filatotchev, I. and K. Bishop (2002). 'Board composition, share ownership and underpricing of UK IPO firms', *Strategic Management Journal*, 23, pp. 941–955.
- Hermalin, B. and M. Weisbach (2003). 'Boards of directors as an endogenously determined institution: a survey of the economics literature', *Economic Policy Review*, 9, pp. 7–26.
- Jensen, M. (1993). 'The modern industrial revolution, exit, and the failure of internal control systems', *Journal of Finance*, 48, pp. 831–880.
- Jensen, M. C. and W. H. Meckling (1976). 'Theory of the firm: managerial behavior, agency costs, and ownership structure', *Journal of Financial Economics*, 3, pp. 305–360.
- Mizuchi, M. (1983). 'Who controls whom? An examination of the relationship between management and boards of directors in large American corporations', *Academy of Management Review*, 8, pp. 426–435.

- Ramdani, D. and A. van Witteloostuijn (2010). 'The impact of board independence and CEO duality on firm performance: a quintile regression analysis for Indonesia, Malaysia, South Korea and Thailand', *British Journal of Management*, 21, pp. 607–626.
- Rediker, K. J. and A. Seth (1995). 'Boards of directors and substitution effects of alternative governance mechanisms', *Strategic Management Journal*, 16, pp. 85–99.
- Shleifer, A. and R. Vishny (1997). 'A survey of corporate governance', *Journal of Finance*, 52, pp. 737–783.
- Zahra, S. A. and J. A. Pearce (1989). 'Boards of directors and corporate financial performance: a review and integrative model', *Journal of Management*, 15, pp. 291–334.

## WOMENOMICS: IS THE WORKFORCE READY?

Averianova, Irina<sup>1</sup>; Nae, Niculina<sup>2</sup>

Faculty of Communication, Nagoya University of Commerce and Business (NUCB), Nagoya, Aichi, Japan

### ABSTRACT

In 2013, Japanese Prime Minister Shinzou Abe launched a series of reforms to revitalize Japan's lagging economy and to infuse it with much needed workforce. One ambitious part of Abe's stated policy, referred to as "womenomics", attempts to avert the disaster of an "inverted socio-economic pyramid", with a diminishing number of workers supporting a growing number of retirees, by enabling wider participation of women in the workforce. There are two main factors underpinning this policy. On the one hand, the work potential of Japanese women is gravely untapped, as less than two thirds of them are employed outside the home. On the other hand, the Japanese society, at large, strongly adheres to the traditional gender-role distribution, according to which woman's place is at home, not in the workplace. This is reflected in conservative, sexist employment practices and an insufficient support system for working families with children. While some government measures, as envisioned by womenomics, are imperative, no less significant is the need for social transformation coming from "the bottom-up", that is reconsidering the traditional norms defining the society's attitudes towards working women.

The present study addresses these particular problems and offers insights, with regards to women's participation in the workforce, into the attitudes and expectations of male and female undergraduate students attending a Japanese business university. Although young people's opinions indicate a certain shift away from traditional views, the reality in the workplace is still likely to abate these expectations, hindering the country's progress towards "womenomics."

*Keywords: Womenomics, Abenomics, Women workforce participation, Japanese society*

## LINKING CONSUMER BEHAVIOR, VIRAL MARKETING AND CINEMATOGRAPHY: A PRACTICAL APPLICATION FOR NGOS

Avgeropoulou, Katerina; Melanthiou, Yioula; Papasolomou, Ioanna

University of Nicosia, Cyprus

### ABSTRACT

The purpose of this research is to examine the link between Consumer Behavior Theory, Viral Marketing, and Videography/Cinematography, in order to understand how certain practices and tools can increase consumer engagement. This is particularly important for organizations like NGOs, since as literature suggests, NGOs' use of social media, can significantly increase consumer engagement and thus activation and action through content that causes high emotional arousal either positive (fun, laughter) or negative (suspense, anxiety) (Falsafi et al., 2011; Berger & Milkman, 2011). Due to the nature of NGOs and the impact that they seek to have in society, by using a powerful medium such as video (cinematography) in social media platforms (viral marketing) they can engage consumers (consumer behavior) and ultimately achieve their active involvement assisting therefore towards NGOs' mission achievement. The research method that was used to collect data for this study was Netnography since it is considered to be the most appropriate in examining online content (La Rocca et al., 2014) and understanding consumer behavior in the online world (Sandlin, 2007). Four video/marketing campaigns that went "viral" on YouTube were selected for observation and analysis of both audiovisual and textual content, as well as observation and analysis of consumers' reaction<sup>1</sup> to these viral videos. The selection of the particular videos was based on their success and popularity documented in the literature (Mohr, 2014). The findings of this research enabled the researchers to develop a framework where specific and realistic recommendations are all combined. This framework may be used by NGOs (and not limited to) for developing their online content aiming for high consumer appeal and engagement and ultimately succeeding in their mission and enhancing their reputation. In addition to the practical implications of this research, theoretical contributions have also been made since this three-tier link between consumer behavior, viral marketing and cinematography had not been investigated previously. This study is of course not free from limitations however clear future research directions are provided for further suggested research to address these limitations and progress further with the topic at hand.

*Keywords: YouTube, Consumer Behavior, Viral Marketing, Audiovisual Synesthesia, Content Appeal, Cinematography*

---

<sup>1</sup> Shares, likes, dislikes, views, comments

## REFERENCES

- Berger, J. and Milkman, K. (2012). What Makes Online Content Viral?. *Journal of Marketing Research*, 49(2), pp.192-205.
- Falsafi, P., Khorashad, S. and Khorashad, L. (2011). Psychological Analysis of Alfred Hitchcock's Movies. *Procedia - Social and Behavioral Sciences*, 30, pp.2520-2524.
- La Rocca, A., Mandelli, A. and Shehota, I. (2014). "Netnography approach as a tool for marketing research: the case of Dash-P&G/TTV".
- Mohr, I. (2017). Going Viral: An Analysis of YouTube Videos. *Journal of Marketing Development and Competitiveness*, 8(3), pp.43-48.
- Sandlin, J. (2007). "Netnography as a consumer education research tool", *International Journal of Consumer Studies*, 31 (3), pp. 288-294

# ESCAPE EXPERIENCES IN LIGHTHOUSE TOURISM: A PHOTO ELICITATION PERSPECTIVE

Azevedo, António J. A.

School of Economics and Management, University of Minho, Braga, Portugal

## ABSTRACT

The lighthouse tourism which has been flourishing in several coastal areas provides the ideal scenario for escape experiences. This paper aims to discuss the implicit meanings, symbolisms and emotions evoked by lighthouses, in particular those related with recreational storm chasing, “land’s ends” pilgrimage and gaze upon dystopic places. Using a qualitative approach, the classification of “lighter” dark tourism product is supported by filmography content analysis, photo-elicitation and lighthouses promotion websites. Several case-studies were discussed providing support for a taxonomy of motives for engaging (dark) lighthouse experiences: risk recreation; isolation and loneliness; pilgrimage; ship wrecking; memorials; dystopia; and “ice palaces” gaze. Public decision makers, maritime authorities and tourism operators may acknowledge the theoretical and practical contributions provided by this paper and develop innovative escape experiences thus giving more “energy” to these peripheral regions.

## INTRODUCTION

This paper aims to discuss the symbolism of lighthouses and all their implicit ingredients which can make them a tourism product segment with a relevant attraction power and economic value.

Just a few weeks before the conclusion of this article, the news of the opening of the first lighthouse adapted to hotel in Spain (at Pancha<sup>1</sup> island, Lugo) and the reopening of the "Semaforo" in Finisterra (Galicia, Spain), have reinforced the relevance of the theme of this paper. These are two examples among the 7742 lodgings named with the “lighthouse” word and evaluated by *Tripadvisor* website besides the 4307 restaurants and 19 tours related with lighthouses. In the website [www.bookalighthouse.com](http://www.bookalighthouse.com) it is possible to book a lighthouse from the 67 options in Europe, in Africa (2), North America (6) or Australia (1). England is the country with the higher number (40) of lighthouses being promoted.

What kind of thoughts and emotions are elicited when you see a lighthouse?

---

<sup>1</sup> [http://elpais.com/elpais/2017/01/25/paco\\_nadal/1485345397\\_929449.html](http://elpais.com/elpais/2017/01/25/paco_nadal/1485345397_929449.html)

## LITERATURE REVIEW

According to the Pine II and Gilmore's grid (1988), tourists may engage four different types of experiences realms depending of the level of participation (active versus passive) and the space-time framework (absorption versus immersion). Living in a lighthouse is an *escape* experience as the tourist (actively and by immersion) "plays" the role of the lighthouse keeper.

This type of experience provides the ideal scenario which awakes several motivators: sensation seeking mechanisms such as the risk recreation associated to storm chasing thrill (Xu et al, 2012) or the attraction/gaze for death sites or dystopic places (also designated as *darktourism*).

Considering that in the literature the author did not find any paper that explicitly analyzes the lighthouse thematic within the dark tourism context, this paper gives a relevant contribution to fill this gap and introduces an innovative concept of (dark) lighthouse tourism. Moreover, limited discussions of meanings have been ascribed to marine environments (Wynveen, Kyle & Sutton (2010), therefore this paper will also discuss the gaze upon lighthouses photos, and the emotions and thoughts elicited or induced by lighthouse films.

The concept of *dark tourism* or *thanatourism* was primarily defined by Foley and Lennon (1996, p.198) as "the presentation and consumption (by visitors) of real and commodified death and disaster sites". Later Stone (2006, p.151) proposed the dark tourism spectrum as classification methodology for the supply in dark tourism comprising several layers or stages which can be gradually represented by a continuum framework from "darkest to lightest".

Therefore the author will claim that lighthouses may be classified as *lighter dark tourism* product according to Stone's spectrum, since this category has all the necessary features usually associated to dark tourism. Lighthouses elicit unconscious thoughts and emotions which are implicitly related with death and can be intentional promoted by tourism operators as suggested by Sharpley (2009). The lighthouses are usually located in the coastal areas and islands which have a higher propensity for occurring disasters such as ship wrecks (for instance, the Coast of Death/ "Costa da Morte" in Galicia, Spain).

Therefore the visit to a lighthouse, or its use as lodging, is aligned with the claims of Stone and Sharpley (2008, p.586) who developed a model that aimed to conceptualize dark tourism as an opportunity to face "mortality moments" but within a distance and environment perceived as safe, allowing the "social neutralization" and "de-sequestration" of death and its reconceptualization.

## METHODOLOGY AND FINDINGS

The relationship between risk/death and lighthouses is also supported by the 2016's filmography. In order to demonstrate that relationship this paper will use a qualitative methodology which includes:



a) a content analysis of the synopses of several recently released films; b) the interpretation and semiotic processing of some lighthouses photos in order to build a taxonomy of explicit/implicit meanings.

The symbolism of lighthouses comprise several aspects that are deeply discussed later in the literature review section: a) the lighthouse as a landscape element; b) the risk recreation factor; c) the emotion contagion provoked by lighthouses; c) the lighthouses located in “lands’ ends” as “power spots” and dark tourism products;

Finally this paper will also present some case studies of routes based on the lighthouse’s thematic to highlight the design of dark tourism experiences: a) the hiking route “Camino dos Faros” in the Galician coast.; b) the lighthouses route in Brittany (France); c) the Lake Michigan lighthouses’ route; d) Other iconic lighthouses used as lodging.

*Keywords: Lighthouse tourism; dark tourism; risk recreation; escape experiences; pilgrimage; dystopia.*

## REFERENCES

- Foley, M., & Lennon, J. (1996). JFK and dark tourism: heart of darkness. *Journal of International Heritage Studies*, 2(4), 198-211.
- Pine II, B.J., & Gilmore J.H. (1998). Welcome to the experience economy. *Harvard Business Review*, 76 (4), 97-105.
- Sharpley, R. (2009). Shedding light on dark tourism: an introduction. In R. Sharpley, & P. R. Stone (Eds.), *The darker side of travel: The theory and practice of dark tourism* (pp. 3-22). Tonawanda: Channel View.
- Stone, P., & Sharpley, R. (2008). Consuming dark tourism: a thanatological perspective, *Annals of Tourism Research*, 35(2), 574-595.
- Stone, P. R. (2006). A dark tourism spectrum: towards a typology of death and macabre related tourist sites, attractions and exhibitions. *Tourism*, 54 (2), 145-160.
- Xu, S., Barbieri, C., Stanis, S. & Market, P. (2012). Sensation-Seeking Attributes Associated with Storm-Chasing Tourists: Implications for Future Engagement. *International Journal of Tourism Research*, 14, 269–284.
- Wynveen, C., Kyle, G. & Sutton, S. (2010). Place Meanings Ascribed to Marine Settings: The Case of the Great Barrier Reef Marine Park. *Leisure Sciences*, 32(3), 270-287.

## DO COUNTRY-SPECIFIC FACTORS AFFECT THE VALUE RELEVANCE OF BRAND VALUE? AN EMPIRICAL ANALYSIS

Bagna, Emanuel<sup>1</sup>; Dicuonzo, Grazia<sup>2</sup>; Perrone, Andrea<sup>2</sup>; Dell'Atti, Vittorio<sup>2</sup>

<sup>1</sup>Department of Economics and Management, University of Pavia, UNIPV, Pavia, Italy

<sup>2</sup>Department of Economics, Management and Business Law, University of Bari Aldo Moro, UNIBA, Bari, Italy

### ABSTRACT

Intangible assets and especially brands are considered as determinants of firm value. Due to their growing importance, consulting firms (e.g., Interbrand, Brand Finance and Millward Brand) publish annual reports on estimated brand values. Prior literature find that the brand values provided by independent parties are reflected on stock prices and therefore they are value relevant (Bart et al., 1998). The results prove that these non-accounting values represent a source of information for investors. However, the relationship between brand values and stock prices could differ across countries. Previous studies reveal that the value relevance of accounting variables diverges on a country basis and identify several country-specific factors which affect the information content of accounting variables. These factors are referred to the legal system, the accounting regulation and the financial system (market-oriented vs bank-oriented) of the different countries. To our knowledge, no studies test the effect of country-specific factors on the value relevance of non-accounting information. The aim of this study is to investigate whether the value relevance of brand values provided by third independent parties differs across countries. Furthermore, we test if all country-specific factors examined affect the relationship between stock prices and non-accounting information. The analysis is based on a sample of brand values provided by Interbrand, Brand Finance and Millward Brand (BrandZ). These brands are owned by companies listed in different stock markets. This work has both theoretical and practical contributions. It fills the gap in the literature by providing evidence about the influence of country-specific factors on the value relevance of non-accounting information. Also, the results could help investors in their decision-making process, providing more tools to analyse the ability of stock prices to capture non-accounting information in different institutional context.

*Keywords: value relevance, brand, brand value, intangible assets, country-specific factors, cross country, market oriented, bank oriented, Ohlson model, stock price*

### REFERENCES

Alford, A., Jones, J., Leftwich, R. and Zmijewski, M. (1993), "The relative informativeness of accounting disclosures in different countries", *Journal of Accounting Research*, Vol. 31, pp. 183-223.

- Ali, A., and Hwang, L. S. (2000), "Country-specific factors related to financial reporting and the value relevance of accounting data", *Journal of Accounting Research*, Vol. 38, pp. 1-21.
- Arce, M. and Mora, A. (2002), "Empirical evidence of the effect of European accounting differences on the stock market valuation of earnings and book value", *European Accounting Review*, Vol. 11 No. 3, pp. 573-599.
- Barth, M.E., Clement, M.B., Foster, G. and Kasznik, R. (1998), "Brand Values and Capital Market Valuation", *Review of Accounting Studies*, Vol. 3 No. 1, pp. 41-68.
- Cahan, S.F., Emanuel, D. and Sun, J. (2009), "The effect of earnings quality and country-level institutions on the value relevance of earnings", *Review of Quantitative Finance & Accounting*, Vol. 33, pp. 371-391.
- Ohlson, J.A. (1995), "Earnings, book values, and dividends in equity valuation", *Contemporary Accounting Research*, Vol. 11 No. 2, pp. 661-687.

## **A COMPARATIVE CROSS COUNTRY ANALYSIS OF BANK MARKETING STRATEGIES DURING THE CURRENT GLOBAL FINANCIAL CRISIS**

**Balomenou, Chrysanthi; Akriviadi, Amalia**

Faculty of Social Sciences, Post Graduate Program in Banking, Hellenic Open University, Patrai, Greece

### **ABSTRACT**

#### **GENERAL REMARKS**

The current economic and financial crisis has caused a number of changes in financial markets and societies around the globe and has largely affected the behaviour of individual consumers. As a consequence, the relationship between commercial banks and their customers has also been affected by this fluctuating environment. Indeed, the median bank customer is gradually transforming his preferences, influenced by the transformations in the banking and financial markets as well as the profound changes which take place at the macroeconomic environment almost every day. The present paper analyses, both from a theoretical and from an empirical viewpoint, the behaviour of bank customers during the current crisis from a marketing perspective. Our research, which relies upon a formalised questionnaire, focuses on the Greek and the Luxemburgish banking sectors with the purpose to present, examine and compare the various marketing strategies which bank marketers follow in the two countries. Our main purpose is to gauge (by applying a binary logistic regression methodology), the degree to which the crisis has affected the demand and supply of the existing banking products and services, and to evaluate (via chi-squared Pearson correlation test), how marketers have reacted (or should react) to this sort of changes in order to help banks to stay afloat. According to our main findings, the Greek banks face more serious challenges compared to those that their Luxembourgish counterparts do. In particular, bank customers in Greece have a higher level of insecurity, as most of them have -partly or fully- withdrawn their deposits from the banks with which they have long-standing relationships. In contrast, the customers of Luxembourgish banks hold close ties to their primary banks regardless of the crisis. Arguably, marketers in both banking markets are called to meet the newly-developed needs of bank customers and promote the relevant products as appropriate, resorting to innovative strategies which will take the emerging financial and socioeconomic conditions into serious consideration. A series of this sort of products and techniques are proposed and described in our study.

#### **THEORETICAL BACKGROUND**

The undergoing economic and financial crisis has exerted a significant impact on financial markets, economies, and societies worldwide, contributing to deep and profound transformations in consumer behaviour worldwide (Kotler P., et al, 2009).

The bank-customer relationship has been largely affected by the crisis, since the latter has seriously hit the banking sector.

The median bank customer behaviour has been changed to a large degree; the preferences, needs and objectives of bank customers have been influenced by the rapid changes that have taken place in the financial, but also in the broader economic environment (Special issue on consumer confidence in financial services after the crunch: new theories and insights, 2009).

The effects of the crisis on bank marketing management (**Kotler P., Keller K.L., (2012)**

Insecurity/Uncertainty

Aggressive customer → conservative customer

Reduction of the marginal propensity to consume

Increase of the marginal propensity to save

Other substantial changes due to the crisis:

"Credit" and confidence shock → significant changes and upheavals in the market of banking products and services (Akinbami, F., 2011).

## **AIM OF THE PAPER**

The main objective of the paper is the following:

To assess the extent to which the crisis has affected the preferences and altered the behaviour of bank customers and how this, in turn, has affected bank products and services from a marketing viewpoint.

In order to achieve the aforementioned goal, we focus on:

the Greek and the Luxembourgish banking environments, presenting and comparing the various marketing strategies and policies of bank marketers in these two European countries.

the post-marketing strategies, capable of promoting a set of modern banking services in the light of the crisis.

## **RESEARCH QUESTIONS**

In which degree differentiated the demands of bank customers for the existing bank products and services (mainly regarding deposits) in the examining two Eurozone economies with different economic backgrounds and also with differences in their banking environments.

Is there any need to search and find new, modern marketing strategies based on the experience of the recent financial and economic crisis?

## **RESEARCH METHODOLOGY 1**

In order to evaluate the extent to which the crisis has affected the choices and, in general, the behavior of banking customers in two Eurozone countries with different economic status and performance: Greece and Luxembourg, we adopted the following research methodology:

Qualitative approach/analysis based on a 'in-house' questionnaire in Greek and English. The survey took place from early January to late March 2013 and our sample were 190 bank customers in Greece and Luxembourg. In addition, we run a binary logistic regression analysis to empirically examine our main arguments based on our survey (qualitative) data. More specifically, we construct our logit regression model, based on the correlation tests we run, by applying the standard chi-squared Pearson correlation test. Actually, we test 2 hypotheses: a)H0: the examined variables are not correlated and b)H1: the two variables are correlated with each other.

## **RESULTS 1**

The main revealing results by our empirical results are the following:

All the variables of our model are associated with a statistically significant relationship with the dependent variable in both regressions (i.e., for the Greek and the Luxembourgish banks).

Those individuals who have withdrawn their money (even for one day) from a bank other than their main bank during the crisis, are more likely to have withdrawn their funds from the main banks as well. This holds true for both depositors in Greek banks and the depositors in Luxembourgish banks (i.e., in both regressions).

The same phenomenon holds true for survey participants who have transferred money to some banking institution abroad.

Those who have requested or to be requested renegotiation of the terms of their mortgage loan in the near future from the main bank because they have been affected by the crisis, they have not proceeded to (fully or partly) withdraw their deposits from their main bank.

When respondents, both in Greece and Luxembourg, most trust a foreign bank, then it is more likely to have withdrawn their deposits from the main bank.

## **RESEARCH METHODOLOGY 2**

For checking if there any need to search and find new, modern marketing strategies based on the experience of the recent financial and economic crisis, taking under consideration the results of our applied research we elaborated a qualitative analysis relying on the innovative Bank marketing strategies in view of the crisis. In order to realize this analysis we use as a case study the Luxemburgish Banks.

## RESULTS 2

In Luxembourg, we passed from product marketing to individualised marketing. Thus, we can say that in this case the Individualised marketing and product planning in practice concentrated on (Banque International a Luxembourg, 2013) :

Non-flat interest rate in some of the banking products offered: marketers are designing customized products which individual characteristics based on the individual customer needs.

Cross-selling activities.

In other words, in Luxembourg the bank marketers adopted the Strategy 1:1, which was launched in 1994 by Don Peppers, Martha Rogers and Dorf Bob in their book entitled "The One to One Field Book" and has become imperative, since the customization of the banking products helps to strengthen customer loyalty and faith and creates the environment for higher future returns.

In Luxembourg we can, also, observe (Banque et Caisse d'Epargne de l'Etat Luxembourg , 2013) :

A re-evaluation of consumer trends and desires, combined with defensive marketing strategies instead of aggressive ones.

An implementation of interactive strategies between bank customers and the bank focussing on:

The bank needs to adopt a more customer-oriented approach, which will be promoted through interactive strategies between the customer and the same.

Implementation and use of the so-called 'digital channels'.

The bank marketers through interactive strategies can, on the one hand, recover the lost confidence in their relationships with their customers on an individual basis and, on the other hand, to improve and customer their services to the new needs and desires of their customers.

As regards the advertising and budget setting (Srinivasan, R.,et all., 2011):

The banking institutions that maintained their budget for promoting products and services largely unchanged during the crisis ended up with less losses in terms of customer numbers.

Further, those institutions gain ground faster in terms of market shares during the recovery phase of the economy than those that decided to impose cuts in advertising budgets.

## OVERALL CONCLUSIONS AND IMPLICATIONS

From all the above mentioned it is obvious that (Pastore-Reiss, E., 2012) :

After the crisis, the individual customer holds the handlebar.

Marketers should offer the 'product and services maps' to each of their customers showing him/her the path that he/she wishes to follow.

These 'maps' should include alternative products that would primarily meet the needs and the objectives of each individual customer.

More than ever, we must now focus on the quality of customer service, because under the new market conditions is not sufficient to maintain the existing clientele but also to establish a long-term relationship.

The bank marketers should comprehend the new consumer/customer behaviour and transform bank marketing as appropriate for the shake of their banks and for contributing to the recovery and the sustainability of the entire banking system.

## **SUGGESTIONS FOR FURTHER RESEARCH**

### **METHODOLOGY (1)**

We will use a logistic model which will capture the difference on Greek and Luxembourgish customers who have withdrawn their deposits from the above country banks. The logistic model will be conditional on different factors each time we run a regression in order to see which of these are more important for the bank owners. In addition, we will split the dataset to two periods in order to capture the impact of the pre- and post- crisis period on bank deposits.

One criterion which will be used will be the examination of funding integration, through the importance of factors, on the on-going attitude of customers, in order to compare their behavior during the two periods of investigation. Is there a similar pattern in the behavior of customers between Greek and Luxembourgish banks or Luxembourgish banks have affected less the withdrawn behavior of their customers? Do the Greek and Luxembourgish bank customers feel more uncomfortable with the banking system in Greece and Luxembourg?

### **METHODOLOGY (2)**

If this is the case, we will measure the reaction of Greek and Luxembourgish bank customers on their process of getting their deposits to other countries. In particular, we would like to estimate whether these countries is, for example, Switzerland taking into account integration between foreign Greek and Luxembourgish deposits in Switzerland in comparison to domestic Greek and Luxembourgish banking. This approach will reveal whether foreign Greek and Luxembourgish bank customers are



more closed to the domestic Greek and Luxembourgish banking system or they prefer other banking systems for their deposits regarding their overall deposits.

### **METHODOLOGY (3)**

Co-integration methodology will be applied in order to uncover different or similar patterns among the two country bank systems, one in Greece or Luxembourg and the other one abroad.

The dataset which will be collected is not only qualitative but also quantitative. We will measure the degree of banking integration through the quantitative dataset. While, in contrast, both the qualitative and quantitative dataset will be used in logistic conditional regression. Thus, we will create a questionnaire for the qualitative dataset, and quantitative dataset will be collected from Bankscope in order to run the two aforementioned methods.

*Keywords: financial crisis; bank marketing; banking products; bank customers, bank marketers, marketing analysts, survey and sampling methodologies, cross country case study (Luxembourg, Greece), marketing strategies, innovation,*

### **INDICATIVE REFERENCES**

- Akinbami, F., 2011, Financial services and consumer protection after the crisis. *International Journal of Bank Marketing*, vol.22, Issue 2
- Banque International a Luxembourg: available at: <https://www.bil.com/fr/particuliers/Pages/default.aspx>, Accessed March 2013.
- Banque et Caisse d'Epargne de l'Etat Luxembourg available at : <https://www.bcee.lu/> Accessed March 2013.
- Bjerke B., Hultman C., (2002), *Entrepreneurial Marketing*, Edward Elgar Editions, UK
- Kotler P., Keller K.L., (2012), *A framework for marketing management*, Pearson Education, ed.5, New Jersey
- Kotler P., Keller, K., Manceau, D., Dubois, B., (2009), *Marketing Management*, 13 ed. Pearson Education, France
- Lovelock, C., Wirtz, J., (2004), *Services Marketing*, 5th ed., Pearson, Prentice Hall
- Pastore-Reiss, E., (2012), *Les 7 clés du marketing durable.*: Eyrolles, Paris
- Peppers.D., Rogers, M., Dorf, B., (1994), "The One to One Field Book", Bantam Doubleday Dell Publishing Group
- Srinivasan, R., Lilien, G.L., Sridhar, S., 2011, Should Firms Spend More on Research and Development and Advertising During Recessions? *Journal of Marketing*, Vol. 75, Issue 3
- Special issue on consumer confidence in financial services after the crunch: new theories and insights, (2009), *International Journal of Bank Marketing*, Vol. 27 Issue: 5 , available at: [www.emeraldinsight.com/doi/.../ijbm.2009.03227eaa.00...](http://www.emeraldinsight.com/doi/.../ijbm.2009.03227eaa.00...) , accessed March 2013.

# **THE CRUCIAL ROLE OF LENDER OF LAST RESORT AS ONE OF THE MAJOR MEANS OF THE BANKING SAFETY NET, ESPECIALLY IN CRISIS AND RECESSION PERIODS**

**Balomenou, Chrysanthi**

Faculty of Social Sciences, Post Graduate Program in Banking, Hellenic Open University, Patrai, Greece

## **ABSTRACT**

The main objectives of this, mainly, theoretical paper are: a) to highlight the importance of Lender of Last Resort, because without a lender of last resort financial stability is not possible and systemic financial crises get out of control. b) to stress the attention on the fact that Classic LOLR principles should be reviewed in light of Great Recession and c) to examine/compare the role of the central banks, especially FED and ECD in providing lender of last resort/emergency liquidity assistance (LOLR/ELA) and consequently, to analyze the Quantitative vs Credit easing that they are providing relatively, in crisis periods.

Thus, this paper seeks to assess the importance of banking system liquidity, generally but especially in financial crises and how the responsible authorities (in our case, at a national level, central banks and at an international one (ECB and FED)), may deal with it. Further more, this paper examines challenges in effectively implementing the lender-of-last-resort function in the EU single financial market. Briefly highlighted are features of the EU financial landscape that could increase EU systemic financial risk. Briefly described are the complexities of the EU's financial-stability architecture for preventing and resolving financial problems, including lender-of-last-resort operations. The paper examines how the lender-of-last-resort function might materialize, by ECB vs FED during a systemic financial disturbance affecting more than one EU-US member state. Further more the paper identifies challenges and possible ways of enhancing the effectiveness of the existing architecture of ECB.

This scientific work is divided into 2 parts. In the first part, the function of a lender of last resort is analysed. In addition, it is presented the role of a lender of last resort that has been amended with the fundamental changes of the financial system that took place during the last 30 years and especially during the recent global financial crisis and its bad effects. While, in the second part, are presented the dimensions that the Fed and the ECB take over the function of lender of last resort in order to investigate, via a comparison analysis whether there are existing any differences between both euvres or not. Actually, the interventions made by the Fed and the ECB are described and judged in a detailed way.

Traditionally, discussion of the role of the lender of last resort has focused on the national economy, without regard for international complications, whereas, the contemporary one concentrated on the international context of it.

The arising by the aforementioned goals of the paper, research questions are focusing on how liquidity problems during the current crisis have differed from the past and in what way were, are and would be solved, through the central banks at national level– ECB – FED at international one, acting as Lenders of Last Resort in the former and the revised form, respectively. The subprime crisis has brought back to light proposals to regulate banks' liquidity as a complement to solvency regulations. Based on several past and recent academic relevant researches, I suggest that liquidity regulations might indeed be a way to limit the pressure on Central Banks in favor of liquidity injections during crisis periods. Another crucial question is the allocation of responsibilities between the Central Banks and the Banking Supervisors in international level in the management of banking crises. Financial crises have become more frequent over the last two decades than they were previously. So, in the second part of the paper, I try to illuminate the fierce debate over how the monetary authorities (FED and ECB) handle and should handle these crises by bringing together a selection of characteristic writings on the subject and by reflecting the relevant viewpoints. In the same part another crucial arising research question is how the ECB – FED respond to the great dilemma "efficiency versus stability" in the financial /banking system and its regulatory framework and in a broader way "growth versus development" in the socioeconomic system, especially in the second phase of the crisis (2010-2012) where the main features of the crisis weren't similar and the crisis took another turn with epicentre in the euro area and the ECB response shifted to another level, than the Fed's one.

.Regarding the methodological adopted approach, in order to answer the aforementioned research questions: Given that, as I mentioned, initially, this is a theoretical paper, I apply a qualitative analysis basing on the following methods, per part: In the first part, via a comprehensive literature review, I elaborate a qualitative analysis divided in 2 periods (before crisis, in periods of normalcy and in crisis periods: a) a historical analysis of the function of the classic role of Lender of Last Resort, and its definition, b) a Contemporary Analysis, of the international Lender of Last Resort in its revised version implementing in crisis periods, ba) Detailed comparative analysis of its main principles in periods of economic growth vs economic crisis, c) Comparison analysis between LoLR-ELA (Emergency Liquidity Assistance) and EFSM (European Financial Stability Fund).

Financial crises have become more frequent over the last two decades than they were previously. So, in the second part of the paper, I try to illuminate the fierce debate over how the monetary authorities (FED and ECB) handle and should handle these crises by bringing together a selection of characteristic

writings on the subject and by reflecting the relevant viewpoints (literature review). Moreover, I elaborated comparative analysis, in terms of the following interventions of the ECB-FED: a) Risk Management vs Standard Economic Policy, b) Credit Easing vs Quantitative Easing c) Conventional vs Unconventional monetary policy d) Rules vs. Discretion in Monetary Policy. Finally, trying to evaluate the effectiveness of each solution, I conducted a Swot Analysis, focused on: a) What is the efficiency of the handled policies of ECB and FED (i.e. Strengths), b) what are the Weaknesses in adopting Conventional instead of Unconventional monetary policies applied by the ECB and the Fed, during crisis times in terms of liquidity – Credit. b) What prospects for monetary policies applied by ECB and FED (i.e. opportunities) c) What risks of the policies of ECB and FED carried out (in other words, (Threats). But due to the qualitative type of the research, it should be pointed out that it is difficult to evaluate the effectiveness of each solution.

Thus, according to the main finding of the qualitative, per part, research:

In the first part we can observe that: During a financial crisis a central bank should lend comprehensively, at low interest rates. It should also accept poor collateral, and save systemic, relevant institutions even if these are insolvent, however, the owners of such institutions should not be rescued. (Herr, H, 2014). Reputation and confidence are and were at the core of what LOLR/ELA operations aim to achieve. In this sense, the revision of the traditional principles ought to mitigate the issues of “stigma” (resulting from a perception that only the desperate go to the LOLR/ELA). (Campbell, A. & Lastra R, 2009, p.496). In any case, given that the longer a crisis lasts the more severe its effects are and according to Aditya Chakraborty (2008): “At the end of the tunnel of a financial crisis lies not light, but the gloom of recession. As surely as smoke follows fire, what comes after a financial meltdown is an economic downturn”. The repair of the financial system is a major priority for governments around the World. Besides, according to Ben Bernanke, (cited in (Campbell, A. & Lastra R, 2009, p.497). “[H]istory demonstrates conclusively that a modern economy cannot grow if its financial system is not operating effectively.” Central banks and public authorities can claim that if they are to assist an institution in “a rainy day” they should regulate that institution in “a sunny day.” Hence, regulation and protection tend to be mutually reinforcing. So, the importance of a clear mandate and a set of enabling rules for the central bank with regard to financial stability, in particular with regard to its LOLR/ELA operations contributes positively to the safeguard of confidence and has a positive reputational effect. From all the above, it is obvious that all the proposing reforms could contribute to a more effective and efficient function of the LOLR, provided that they will be combined with the appropriate reforms and restructuring strategies of the Banking and generally financial system.

As far as the results addressed to the second part, revealing from the qualitative comparative analysis between ECB –FED and in some way the BoE, briefly : Different economic and financial structures require different crisis responses. Different crises also require different tools and resources. The first ‘stage’ of the financial crisis (2007 -2009) was similar on both sides of the Atlantic, and the response was also quite similar. The second stage of the crisis is unique to the euro area. Increasing financial disintegration within the region has forced the ECB to become the central counterparty for the entire cross border banking market and to intervene in the sovereign bond market of some stressed countries. The actions undertaken by the ECB, however, have not always represented the best response, in terms of effectiveness, consistency and transparency. This is especially true for the (Securities Markets Program) (SMP): by de facto imposing its absolute seniority during the Greek PSI (Private Sector Involvement) , the ECB has probably killed its future effectiveness. Furthermore, we can argue that concerning the arising great dilemma: efficiency versus stability in the financial /banking system and its regulatory framework, from our research it is obvious that when we have an effective banking system the relevant rules are ineffective, on the contrary when it is crisis prone the relevant legislative framework is stable. This dilemma is resembling to another great one that can be found in the field of regional science: efficiency versus equity. (Konsolas, N, 1997). So, in our examining situation, the FED undertook massive asset purchases financed by central bank money, the so-called Quantitative Easing (QE). A similar approach was followed by the Bank of England (BoE). While the Federal Reserve and the BoE have done QE, the ECB had to respond to an increasing financial disintegration within the region. The ECB has been forced to become the central counterparty of the entire cross border banking market and to intervene in the sovereign bond market of some stressed countries. Therefore, its main policy approach can be qualified as ‘credit easing. In the assessing procedure of the effectiveness of the two approaches it emerges that while the ECB has responded massively to the crisis (LTRO (longer-term refinancing operations ) and SMP (Securities Market Program)), it has also tried to minimise its own risk. Alas, this implies that its policy cannot be fully effective. This approach is significantly different from the one chosen by the FED, who showed its willingness to take on credit risk in order to provide relief to private investors, which therefore could recover quickly. Consequently, in this way FED supports the entrepreneurship and reinforces both the economic growth and development. The ECB makes a distinction between interest rate policy, which guides macroeconomic variables (growth, inflation), and unconventional policy, the objective of which is to prevent a liquidity crisis and to ensure the stability of the banking and financial system. So, we can say, that in a way the ECB is following more a by rules monetary policy. On the other hand, Fed, for its part, sees unconventional policy as an extension of interest rate policy, with the aim of easing monetary conditions further. Thus, as it is obvious, the FED’s policy could be

considered as more discretionary one. Besides, The difference between the two policies is found in the fact that the increase in the ECB's balance sheet to a great extent is the result of "actions" by the banks (demand for liquidity at the LTROs), while that of the Fed results from its own willingness to buy securities. Furthermore, the Fed carries out outright purchases of securities, while the ECB grants liquidity via refinancing operations (collateral). In addition, the objectives pursued by the ECB are to prevent a liquidity crisis, help the banks and thus dampen the risk of a credit crunch. The Fed, for its part, explicitly states that its actions aim to make monetary conditions more accommodating in order to boost the economy (via a fall in long-term interest rates, stimulus for stock markets, etc.). Finally, in order to declare more the research output and specify the metrics used to measure the participating Central Bank's own risk. I quote 2 characteristic comparative diagrams, per crisis period, where are indicated the following: a) In the first figure, referring to the 1<sup>st</sup> crisis period are presented the Total Assets/Liabilities of ECB, FED and BoE, showing that increase in the ECB balance sheet, during this period looks small with only 170%. While, over the same period, the Fed's expansion has been of the order of 230% and in the UK, (BoE) it reached 300%. b) In figure 2, related to the 2<sup>nd</sup> crisis period, it is presented Central banks' Securities purchase as % of GDP (Gross Domestic Product). In this figure, we can observe, how the purchases made by ECB under the two open market operations (i.e. Securities Markets Programme – SMP- and Covered Bond Purchase Program- CBPP appear very limited in comparison to the QE (Quantitative Easing) undertaken by the FED and the BoE. So, it is verified that the statistics are in accordance with the theoretical – qualitative findings of my research.

*Keywords: financial crisis; recession periods, former/classical LOLR, revised LOLR, banking safety net, constructive ambiguity, moral hazard, crisis lender, crisis manager, rescue aid, constructive plans.*

## INDICATIVE REFERENCES

- Campbell Andrew & Lastra Rosa "Revisiting the Lender of Last Resort" *Banking & Finance Law Review*, 24.3: (Jun 2009): p.453-497
- Herr, Hansjörg "The European Central Bank and the US Federal Reserve as Lender of Last Resort" *Panoeconomicus*, 61.1 (2014): p. 59-78
- Wood, Geoffrey E, "The lender of last resort reconsidered" *Journal of Financial Services Research*, 18, 2,3; (Dec 2000): p.203-227

# SMES, SOCIAL MEDIA AND INTERNATIONALIZATION: AN EXPLORATIVE RESEARCH

Bartoloni, Sara; Pascucci, Federica

Department of Management, UNIVPM, Ancona, Italy

## ABSTRACT

### OBJECTIVE AND RESEARCH QUESTION

Removing the geographical distance between seller and buyer, the online channel has made more feasible for SMEs to become international and to operate on a global level (Sinkovics et al., 2013). In this scenario, social networks, such as Facebook, are attracting more and more attention from both researchers and practitioners, due to their great potential to conduct marketing activities internationally (del Carmen Alarcon et al., 2015). These tools are known to create new direct relationship channels with customers, to promote products and brands through E-word of mouth, to raise brand awareness and loyalty (Vernuccio, 2010), both at a domestic and an international level.

However, implementing an international social media strategy is not so simple as it seems. In fact, even if creating a Facebook account is a simple and low-cost operation, there are some issues that cannot be ignored, such as the “cultural problem”. Internet has not removed the “psychic distance” among people of different countries and the cultural variables profoundly influence users’ expectations, online preferences and behaviors. In literature, the issue of the cultural adaptation has been deepened in particular with reference to the corporate web site (Singh and Pereira, 2005); a lot of studies have shown that the *localization* of the content and the structure of the web site influences its own performance, in terms of superior usability, trust and conversion rate (Bartikowski and Singh, 2013). The same multilingual and cultural problems could be found also in the social media area (Tsai and Men, 2014). Moreover, cultural norms impact on the choice of the social network platform to use: in some countries, such as China or Russia, people prefers to use local platforms, for example Qzone or VKontakte. This means that a company will need to customize social media aspects of its marketing strategy to fit and accommodate national differences.

From a systematic literature review about this topic a gap has emerged: studies about social media use in the international marketing strategies of firms are scarce, especially as regards to the SMEs. We found only three studies that dealt with this topic (Berthon et al., 2012; Munar, 2012; Yang and Wang, 2015). So, in order to close this gap, the purpose of this study is to explore the social media use of SMEs in an international marketing context. In particular, the research question is the following:

*Have Italian SME been using social media in their international marketing strategies and, if so, how do they use them to communicate with foreign customers?*

## METHODOLOGY

Since the topic is mostly unknown and in congruence with the explorative nature of the research purpose, a qualitative methodology has been chosen and in particular the *multiple case studies method* has been implemented (Stake, 1995; Yin 2003). Through the “*purposeful sampling*” technique, we selected n.7 Italian SMEs of Food and Beverage industry, that are “information rich cases”, following the “*theoretical saturation*” principle (Eishenardt, 1989). We chose this industry because it is one of the most representative of Made in Italy, it is export-oriented (SACE, 2016) and because of its level of attractiveness abroad, especially online (Fondazione Symbola – Unioncamere – Fondazione Edison, 2015).

We collect the data through face to face semi-structured interviews, specifically investigating the languages adopted, the presence of targeted foreign accounts, the use of customized content and the main barriers faced by firms in foreign social media activities.

## MAIN FINDINGS

✓ In general, the use of social media channels seems to be unplanned and improvised, without a clear strategy in mind. In the majority of the cases (n.5) they are internally managed and there is not a specific editorial plan for the content publication (with two exceptions). The main purpose of this presence is to promote brand and to gain visibility abroad.

✓ The empirical evidence shown a limited propensity to adapt the social media presence, both in terms of language and content. In 5 out of 7 cases the firms have implemented a single Italian page, where some English contents are rarely published. In these cases, the localization issue is not perceived as relevant, showing a significant gap between the suggestions of theory and the practice. In only two cases some forms of adaptations have been implemented. Firm F has adapted the platform to the target country – they use Facebook for Italian market and Twitter for USA. Firm G adopts a so called “multi-local strategy”, but with a peculiarity: the country-pages are managed by the foreign local dealers and not by the firm directly.

✓ The motivations of this scarce adaptation are the same for all the firms. First of all, they don't perceive the need to communicate to foreign customers in a differentiated manner, depending on their cultural traits, even if they are aware of the cultural differences. Second, they complain about the lack of human resources with adequate competences to dedicate to the social media management at the international level. Connected to this, there is the issue of inadequate external services supply, as



perceived by the firms. Thirdly, the small size and the consequent lack of financial resources are other factors that prevent the investigated firms to use and adapt social media to the foreign customers.

✓ A scarce knowledge of the possible localization strategies by the investigated firms has emerged. They seem to ignore the existence of hybrid strategies, such as the “glocal approach”, that entail lower costs and complexity than the complete localization, and so are more suitable for their size and resources.

✓ The presence of a marketing department, the firm’s size (micro, small or medium) and the export rate seems to not influence the social media approach in international marketing.

*Keywords: social media, international marketing, SMEs, food&beverage, localization, standardization.*

## REFERENCES

- Bartikowski B., Singh N. (2013), “Should all firms adapt websites to international audiences?”, *Journal of Business Research*, Vol.67, N. 3, pp. 246-252.
- Berthon, P. R., Pitt, L. F., Plangger, K., & Shapiro, D. (2012), “Marketing meets Web 2.0, social media, and creative consumers: Implications for international marketing strategy”, *Business horizons*, Vol.55, N. 3, pp. 261-271.
- Del Carmen Alarcón M., Rialp A., & Rialp J. (2015), “The Effect of Social Media Adoption on Exporting Firms’ Performance”, *Entrepreneurship in International Marketing (Advances in International Marketing)* Emerald Group Publishing Limited, Vol.25, pp.161-186.
- Eisenhardt, K. (1989), “Building theories from case study research”, *Academy of Management Review*, Vol.14, N.4, pp.532–550.
- Fondazione Symbola, Unioncamere, Fondazione Edison, “I.T.A.L.I.A. - Geografie del nuovo Made in Italy - Rapporto 2015.
- Munar, A. M. (2012), “Social media strategies and destination management”, *Scandinavian Journal of Hospitality and Tourism*, Vol.12, N.2, pp.101-120.
- Singh, N., & Pereira, A. (2005), *The culturally customized web site: Customizing web sites for the global marketplace*, Elsevier Butterworth-Heinemann, Oxford.
- Sinkovics N., Sinkovics R, & Jean R., (2013) "The internet as an alternative path to internationalization?", *International Marketing Review*, Vol. 30 Iss: 2, pp.130 – 155.
- Stake R.E. (1995), *The art of case study research*, Sage Thousand Oaks.
- Tsai W., & Men L., (2014), “Consumer engagement with brands on social network sites: A cross-cultural comparison of China and the Usa”, *Journal of Marketing Communication*, pp.1-20.
- Vernuccio M. (2010). *I Social Media e il loro impiego nelle strategie di Corporate branding: un’indagine esplorativa*. *Micro & Macro Marketing*, 2, 189-214.
- Yang, X., & Wang, D. (2015), “The Exploration of Social Media Marketing Strategies of Destination Marketing Organizations in China”, *Journal of China Tourism Research*, Vol.11, N.2, pp.166-185.
- Yin, R. (2003), *Applications of case study research*, Sage Publications Inc, London.

## THE SOCIAL RESPONSIBILITY IN BANKING: REVIEW AND RESEARCH PERSPECTIVES

**Bellomo, Mario Filippo Paolo; La Rosa, Fabio**

Economics and Law Faculty, "Kore" University of Enna, Enna, Italy

### ABSTRACT

This paper proposes a review concerning the topic of social responsibility in banks. In the backdrop of the economic crisis which is still ongoing, companies are requested to align with the directives and, more generally, with the values of social responsibility.

The compliance to social responsibility nevertheless cannot only be seen as a commandment imposed from the top and far removed from the competitive business environment which is passively adapted to, but rather as an opportunity for diversification and competitive advantage (Birindelli *et al.*, 2015). Such problem is exacerbated in the banking sector, in which the elements of competitive differentiation are often ephemeral and volatile, since they are based on price (in the loans and services context) and performance (in the management of deposits).

This paper focuses on six areas, which have been extensively analyzed by the national U.S. and European literature in the banking sector, in details: I) the relationship between attention to social responsibility and incomes or stock performance of banks; II) the effects of cultural, ethnic and gender variables on social responsibility indicators; III) social responsibility and its impacts in terms of customer satisfaction; IV) the compilation of rankings of bank operators, on the basis of results achieved in terms of social responsibility; V) the relationship between attention to social responsibility and degree of self regulation and cooperation; VI) the relationship between attention to the liability and legal enforcement on a national scale.

The study proposes to deepen some critical issues, in order to offer ideas for new research into yet unexplored areas.

As regards the first and third area, literature shows as people may not believe in an explicit trade-off between being profitable and meeting legal, ethical, and discretionary responsibilities anymore. Yet, banking industry surveys have highlighted a mismatch between consumer satisfaction and massive spending on CSR programs. Indeed, it is evident the omission of research on the differential impact of CSR initiatives on consumer satisfaction. Given both the increasing investment in CSR strategies, and the fact that customer satisfaction mediates firm market value, more awareness of the hierarchy of customer-preferred CSR initiatives is needed in order to enable banks to adapt their CSR programs, to not only benefit community, but also to improve customer satisfaction (McDonald *et al.*, 2008).

In reference to the second area, literature confirms significant differences in CSR across cultures even

within one single internationally operating organization; meeting such differences does not come at the expense of economic performance levels or legal limitations (Van den Heuvel *et al.*, 2014). The most important question arising from this issue is whether CSR-oriented organizations will survive in the long term in the whirlpool of supercapitalism (Reich, 2007) and hypercompetition (D'Aveni, 1994), strongly emphasizing shareholder satisfaction. Further research on the differences in CSR across various cultures should be undertaken, incorporating various populations in different countries, through multinational banks with branches across different countries since often researches are focused only on one nation located banks.

In reference to the fourth area, literature underlines that these approaches have the advantage of being quite transparent and objective, as they are based on publicly available information on websites of banks and supranational bodies and reporting specialized NGOs. The biggest flaw of these researches is the limited number of banks for which reports are available, since there is a generalized problem of insufficient disclosure in CSR activities (Scholtens, 2009).

As regards the fifth and sixth areas, data confirm that financial firms in countries with stronger legal enforcement measures engage in more CSR activities, but interestingly, those firms in countries with stronger shareholders' rights engage in less CSR activities.

Furthermore financial firms in countries with more cooperative employer–employee relations, will be more CSR minded; self-regulation in the financial industry has a significantly positive effect on CSR. A financial firm, adopting either the Equator or Wolfsberg Principles, will be an attractive investment for socially responsible investors (Hsiang-Lin *et al.*, 2009).

*Keywords: Social responsibility, performance, regulation, legal enforcement, corporate governance*

## REFERENCES

- Birindelli, G., Ferretti, P., Intonti, M. and Iannuzzi, A.M. (2015), "On the drivers of corporate social responsibility in banks: evidence from an ethical rating model", *Journal of Management and Governance*, Vol. 19, pp. 303–340.
- D'Aveni, R.A. (1994), *Hypercompetition: Managing the dynamics of strategic maneuvering*, Free Press, New York, NY.
- Hsiang-Lin, C., Hsiang-Hsuan, C. and Tzu-Yin C. (2010), "On the Determinants of Corporate Social Responsibility: International Evidence on the Financial Industry", *Journal of Business Ethics*, Vol. 93, pp. 115–135.
- McDonald, L.M. and Rundle-Thiele, S.R. (2008), "Corporate social responsibility and bank customer satisfaction: a research agenda", *International Journal of Bank Marketing*, Vol. 26 No. 3, pp. 170-182.
- Reich, R.B. (2007), *Supercapitalism: The transformation of business democracy, and everyday life*, Alfred A. Knopf, New York, NY.
- Scholtens, B. (2009), "Corporate Social Responsibility in the International Banking Industry", *Journal of Business Ethics*, Vol. 86, pp. 159–175.
- Van den Heuvel, G.G.A., Soeters, J.M.M.L. and Goessling, T. (2014), "Global business, global responsibilities: Corporate social responsibility orientations within a multinational bank", *Business & Society: A Journal of Interdisciplinary Exploration*, Vol. 53 No. 3, pp. 378-413.

## A CHOICE OF SOCIALLY RESPONSIBLE INSTRUMENTS: SME STUDY IN 6 COUNTRIES

**Belyaeva, Zhanna<sup>1</sup>; Lopatkova, Yana<sup>1</sup>; Kislyak, Nadezhda<sup>1</sup>; Rudawska, Edyta<sup>2</sup>**

<sup>1</sup>Graduate School of Economics and Management, Ural Federal University, GSEM-UrFU, Yekaterinburg, Russia

<sup>2</sup>Faculty of Economics and Management, The University of Szczecin, Szczecin, Poland

### ABSTRACT

Nowadays socially responsible strategies are first associated with big corporations. In the meantime SMEs are more flexible to respond to changes in society and the environment. One of the reason that the sustainable strategies of SME are questioned that there is a lack of data and transparency over the globe.

This abstract pinpoints current trends in socially responsible instruments that SME in 6 countries use in the framework of corporate social responsibility. We differentiate country-level CSR-SME models and outline the selected models using qualitative and quantitative methods. We have measured the factors providing the key motivation for owners to invest in socially responsible actions using a sample of 750 SME in food industry in 6 countries of a diverse economic, social and cultural level of development: Russia, Poland, Great Britain, Germany, Spain, and Croatia. The main aim of the research is to develop a new knowledge about the relation between the scope of socially responsible strategies application in SMEs and a degree of socio-economic development of the selected country. The study implies the following methodology: 1) survey among representatives of small and medium-sized businesses through online questioning and interviewing; 2) descriptive research and statistical analysis; 3) comparative analysis of results in different countries.

Comparative analysis of small and medium-sized businesses in Russia and Europe allows us to assess the socio-economic differences and differences in the actual state of implementation of the project idea between countries that participate in the project.

The main issue applies to the identification of the way socially responsible strategies and CSR tools are used in SMEs. The research revealed what a socially responsible strategy for SMEs in different countries means (table 1).

*Table 1. The difference between the concepts of defining a socially responsible strategy in different countries*

Country	Socially responsible strategy is	
Poland	Honest communication (integrity, efficiency)	Implementation of activities designed to meet the needs of customers, achieving business goals and realization of social and
Croatia	Conducting ethical activity (according to laws and regulations)	
Russia	Offering environmentally friendly and safe products/services for customers	

Spain	Offering environmentally friendly and safe products/services for customers	environmental objectives at the same time
Germany	Offering environmentally friendly and safe products/services for customers	
United Kingdom	1) Conducting ethical activity (according to laws and regulations) 2) Offering environmentally friendly and safe products/services for customers	

Participants were asked to assess the challenges facing the business. On average for all countries the main tasks facing the business in the next 3-5 years are: attraction and retention of clients, creating a strong corporate image and positive reputation, preservation of personnel

The questionnaire was compiled by the international research team and translated into 6 languages. After pilot testing we have adjusted the questionnaire for local use. The questionnaire consists of 4 parts: the place of socially responsible strategies in the overall business strategy; level of manager’s awareness in CSR (understanding of terminology, difficulties and benefits of introducing a socially responsible strategy); using the tools of a socially responsible strategy based on marketing mix: product, price, distribution, communications and employees; descriptive statistics of companies: firm size, turnover from sales, period of operation etc. Participants were asked to evaluate the tools they use within their socially-oriented strategy in 5 areas of the marketing mix. The comparative results are shown in figure 1.

Figure 1. The importance of the main directions of the implementation of socially responsible enterprise strategy in the countries under study

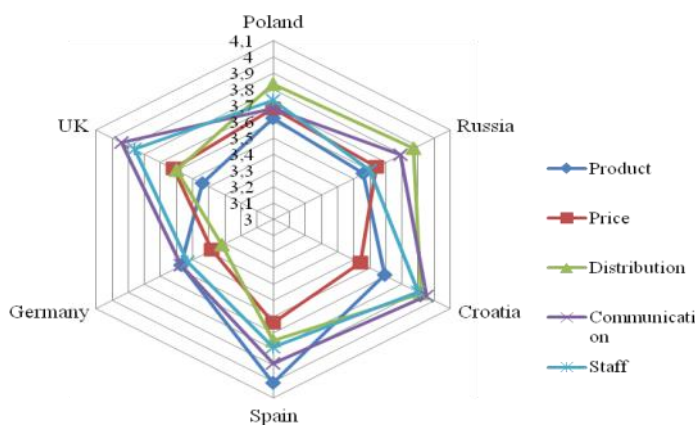

The binary model used to conduct the probability analysis between application CSR strategy and influence factors (representative’s knowledge about socially responsible strategies; manager’s attitudes towards the concept; marketing experience, etc.). This tool will allow us to describe the relation between the scope of socially responsible strategies application in SMEs and a degree of socio-

economic development of the selected country. Thus, this set of methods allows obtaining qualitative and quantitative data. Hence, it makes possible to fully and from different sides consider the problems of the study and draw more precise conclusions. It was also proposed to assess the benefits that enterprises receive through the introduction of CSR. A descriptive study was based on average values. The formula for the binary choice model is shown below. Test results are presented in the table 2.

$$\rho(\text{practice}) = F(\beta_1 0 + \beta_1 1 \times \text{mission} + \beta_1 2 \times \text{term} + \beta_1 3 \times \text{staff} + \beta_1 4 \times \text{turnover} + \beta_1 5 \times \text{origin} + \beta_1 6 \times p4_31b + \beta_1 7 \times \text{gdppc}),$$

where mission is an existence of mission; term - knowledge of CSR terminology; staff - number of staff; turnover - net turnover; origin - the age of the firm; P4\_31b - selling goods / services on the Internet; Gdppc - GDP of the country, \$/1000.

Table 2. Results of testing models of binary choice

Factors	Coefficient	Marginal effects	The impact on the likelihood of socially responsible strategies
Mission	0,678*** (0,121)	26,5%	The presence of a mission increases the probability of using SO-strategies
Terminology	0,849*** (0,121)	32,8%	Knowledge of CSR terminology increases the likelihood of using SO-strategies
Staff	-0,013 (0,091)	-0,4%	Does not affect
Turnover	0,043 (0,1)	1,6%	Does not affect
Origin	0,241*** (0,092)	9,6%	More likely that older companies apply to social responsibility practices
Selling goods / services on the Internet	0,235*** (0,076)	9,3%	It is more likely that the company will have a socially responsible strategy if there are sales in the Internet
GDP of the country, \$/1000	0,013** (0,006)	0,5%	The increase in GDP increases the likelihood of social responsibility of companies in the country

The theoretical and practical implications include: 1) a new assessment method of the socially responsible concept, 2) identification of CSR development determinants and its use motives, 3) recognition of the actual state of implementation of this idea in the chosen markets, 4) CSR implementation scenario in 6 countries.

*Keywords: CSR-strategy, SME, food industry, Russia, Poland, Croatia, Spain, Germany, England*

## CONSUMER-BRAND ENGAGEMENT THROUGH WEBSITE STIMULI

**Bilro, Ricardo; Loureiro, Sandra Maria Correia**

Marketing, Operations and General Management Department, Instituto Universitário de Lisboa (ISCTE-IUL) and Business Research Unit (BRU/UNIDE), Lisbon, Portugal

### ABSTRACT

#### RESEARCH AIMS

Previous studies concerning consumer engagement have been dedicated to conceptualize the construct and proposing scales to measure it (Van Doorn et al. 2010; Bolton 2011; Bijmolt et al. 2010; Brodie et al. 2011; Hollebeek et al. 2014). Yet, further research has been suggested in those studies regarding antecedents and outcomes of online consumer engagement. The following questions remain open: what drives consumers to be online engaged? And what are the outcomes of being online engaged? The aim of the current research is to contribute to the fulfillment of this gap in the literature, analyzing which dimensions of online stimuli with websites exercise more effect on online engagement and which of this dimensions' most influence brand advocacy.

#### THEORETICAL BACKGROUND

Previous research attempt to consider and suggest several factors, such as customer involvement (e.g., Hollebeek et al. 2014), employee engagement in offline context (e.g., Pansari & Kumar 2016), or even customer purchase process, incentivized referrals, social influence and knowledge sharing, as related to customer engagement. Brodie et al. (2011) also consider that customer engagement occurs by interactive and co-creative customer experience with the focal agent. Therefore, the stimuli of the experience using websites to search for information and purchase the products may be a driver to customer engagement.

The current research aims to consider three stimuli of online experience influencing the customer engagement: information/content, interactive features, and design-visual appeal. According to Loureiro (2015), there is no standard method of evaluating websites and (Law et al. 2010, p.310) advance that 'researchers do, and should, choose the most appropriate approach for their research objectives, target markets, and stakeholders.' In this sense, this research is adopting the previously mentioned three stimuli following Loureiro (2015) and Han & Mills (2006), which are considered appropriate for measuring stimuli of online experience as antecedents of online consumer engagement.

Customer engagement has also been associated with consumer-brand connection and brand usage intention - the willingness to use again - (Hollebeek et al. 2014), or firm performance (Pansari & Kumar

2016), improved consumers' contributions to collaborative product development process or co-creation experiences or even brand referrals(e.g., Bijmolt et al. 2010; Sawhney et al. 2005). In this sense, we suggest that when customers are engaged to an online supplier brand, not only will be self-connected to the website and wish to use it again but will also recommend it to others customers' and excuse it if anything went wrong (brand advocacy).

## **HYPOTHESES**

Several studies have pointed out that comprehensiveness, uniqueness, accuracy, and entertainment value, as well as the timeliness of information/content, will increase customers' shopping experience (Aladwani & Palvia 2002; Kaynama & Black 2000). Therefore, the Information/Content dimension can be defined as the extent to which a user thinks that information/contents are useful, updated, and reliable (Park et al. 2007). Thereby:

H1: Information/content has a positive relationship with online engagement, that is, Cognitive processing (H1a), Affection(H1b) and Activation (H1c).

Interactive features of a website refer to items that generate a responsive behavior from online consumers such as sending inquiring emails or searching and planning through the website. These items allow consumers to engage in a certain manner to the website after a design-visual appeal has captured their attention and information/content have increased their interest in (Han & Mills 2006). In this sense, we propose:

H2: Interactive features has a positive relationship with online engagement, that is, Cognitive processing (H2a), Affection(H2b) and Activation (H2c).

An important test for online suppliers concerns about deciding the style and visual interest of the website in a way that it will enhance consumers' flow process and consider the online consumers' experience as well as goal-directed behaviors. Therefore, the design-visual appeal dimension refers to the proper use of color, graphics, image, and animations, that is, the organization and presentation of a website (Park et al. 2007). Thereby:

H3: Design-visual appeal has a positive relationship with online engagement, that is, Cognitive processing (H3a), Affection(H3b) and Activation (H3c).

As describe in the literature, brand advocacy can be perceived as the extent to which person actively recommend or support, relative to other brands, a specific brand within a product category to other customers (Badrinarayanan & Laverie 2013), as well as the consumers' behaviour intending to try new



products of the brand, spreading favourable word-of-mouth and being resilient to negative information (Pai et al. 2013). Therefore, we propose:

H4: The cognitive processing dimension of online engagement has a positive relationship with brand advocacy

H5: The affection dimension of online engagement has a positive relationship with brand advocacy

H6: The activation dimension of online engagement has a positive relationship with brand advocacy

## EXPECTED OUTCOMES

The current research intends to understand if the online consumer's experience creates stimuli that could generate online consumer engagement. It's our aim to find a causal relationship between stimulus and mentioned online engagement dimensions, e.g., to measure the relation between Interactive features and Cognitive processing or between Affection of engagement and Information\content. From what we can see so far, Information\content presents a very significant stimulus on cognitive processing and Information\content, and Design-visual appeal seems to have a significant effect on Activation. However, Interactive features need deeper understand concerning its effect on Activation. About the relationship between online engagement and brand advocacy, it is expected to understand and analyze which dimension (Cognitive processing, Affection, and Activation) most influence brand advocacy, as well as to recognize the influence of each one and its respective significance.

*Keywords: Information/Content, Interactive Features, Design-Visual Appeal, Online Engagement, Brand Advocacy.*

## REFERENCES

- Aladwani, A.M. & Palvia, P.C., 2002. Developing and validating an instrument for measuring user-perceived web quality. *Information and Management*, 39(6), pp.467–476.
- Badrinarayanan, V. & Laverie, D. a., 2013. The Role of Manufacturers' Salespeople in Inducing Brand Advocacy by Retail Sales Associates. *Journal of Marketing Theory & Practice*, 21(1), pp.57–70.
- Bijmolt, T.H. a. et al., 2010. Analytics for Customer Engagement. *Journal of Service Research*, 13(3), pp.341–356.
- Bolton, R.N., 2011. Customer Engagement: Opportunities and Challenges for Organizations. *Journal of Service Research*, 14(3), pp.272–274.
- Brodie, R.J. et al., 2011. Customer Engagement: Conceptual Domain, Fundamental Propositions, and Implications for Research. *Journal of Service Research*, 14(3), pp.252–271.
- Van Doorn, J. et al., 2010. Customer Engagement Behavior: Theoretical Foundations and Research Directions. *Journal of Service Research*, 13(3), pp.253–266.
- Han, J.-H. & Mills, J.E., 2006. Zero acquaintance benchmarking at travel destination websites: what is the first impression that national tourism organizations try to make? *International Journal of Tourism Research*, 8(6), pp.405–430.

- Hollebeek, L.D., Glynn, M.S. & Brodie, R.J., 2014. Consumer brand engagement in social media: Conceptualization, scale development and validation. *Journal of Interactive Marketing*, 28(2), pp.149–165.
- Kaynama, S.A. & Black, C.I., 2000. A Proposal to Assess the Service Quality of Online Travel Agencies: An Exploratory Study. *Journal of Professional Services Marketing*, 21(1), pp.63–88.
- Law, R., Qi, S. & Buhalis, D., 2010. Progress in tourism management: A review of website evaluation in tourism research. *Tourism Management*, 31(3), pp.297–313.
- Loureiro, S.M.C., 2015. The Role of Website Quality on PAD, Attitude and Intentions to Visit and Recommend Island Destination. *International Journal of Tourism Research*, 17(6), pp.545–554.
- Pai, D.C. et al., 2013. Corporate Social Responsibility and Brand Advocacy in Business-to-Business Market: The Mediated Moderating Effect of Attribution. *Journal of Business Ethics*, 126(4), pp.685–696.
- Pansari, A. & Kumar, V., 2016. Customer engagement: the construct, antecedents, and consequences. *Journal of the Academy of Marketing Science*, p.1–18. (forthcoming). Available at: <http://dx.doi.org/10.1007/s11747-016-0485-6>.
- Park, Y.A., Gretzel, U. & Sirakaya-Turk, E., 2007. Measuring website quality for online travel agencies. *Journal of Travel & Tourism Marketing*, 23(1), pp.15–30.
- Sawhney, M., Verona, G. & Prandelli, E., 2005. Collaborating to create: The internet as a platform for customer engagement in product innovation. *Journal of Interactive Marketing*, 19(4), pp.4–34.

# **DOES THE PRESENCE OF WOMEN IN SUPERVISORY BOARDS INFLUENCE FIRM PERFORMANCE?**

**Binder, B.C.K.**

School of Engineering, Pforzheim University, Pforzheim, Germany

## **ABSTRACT**

Many large companies in Europe include mainly men in supervisory boards and the women quota is often lower than 20 %. The present article looks at the companies of EURO STOXX 50 in the year 2015 and their success and tries to establish whether this success can be related to the percentage of female members in supervisory positions. It replicates in this way the study of Binder, Alonso-Almeida and Bremser (2016) which analysed the relationship between female's representation in the management board (executive board) and firm performance (measured by earnings before taxes - EBT) of the EURO STOXX 50 companies in 2014. It is in the same time an extension of the original study as the supervisory board is brought under scrutiny.

## **INTRODUCTION**

This article offers an insight into the relationship between the economic success of 50 European companies and the gender balance on supervisory boards. For this purpose the article builds upon existing literature in the field of KPIs, diversity management, supervisory boards, and women quota, etc. Thus, the paper can help investors or business owners to gain a thorough understanding of the current business environment.

## **LITERATURE REVIEW**

Women's presence in supervisory boards was a controversial issues in past decades. Beaufort and Summers (2013) identified at European level a 1.5% change of women representation in mainly male supervisory boards between 2009 and 2013. If women were already member in a supervisory board, the women quota was likely to increase further. According to the above study the average women quota in supervisory boards in Europe in 2013 was 7.9%. France stood out as a positive example with a women quota of 28.1% in 2013.

The study "Women matter. Gender diversity, a corporate performance driver" shows that companies with a higher proportion of women in top management perform better (McKinsey, 2007). Other authors signal rather the lack of evidence that female representation in supervisory boards improves profitability (Ferreira, 2014). In a study with 108 German large corporations which took place between

2009 and 2013, there was not enough evidence to indicate a significant relationship between gender diversity and firms' financial performance (Dick, 2015).

The present research focuses on the companies of the EURO STOXX 50 index, and aims at exploring whether there is a link between the EBT of these successful European companies and the number of women in supervisory boards. The following hypothesis is formulated and will be tackled in the following sections:

H1: Enterprises which have a higher gender quota in supervisory boards are more successful and achieve a higher EBT.

## METHODOLOGY

The EURO STOXX 50 Index was selected to represent the performance of the 50 largest companies among 19 supersectors in the year 2015. Moreover, EURO STOXX 50 index is one of the most liquid indices for the Eurozone and serves for benchmarking purposes. It represents the performance of only the largest and most liquid companies in a sector (STOXX Limited, 2016).

The current study looks at the number of women in supervisory boards as presented in the 2015 annual reports of the fifty EURO STOXX companies, and data regarding the EBT of each of the fifty companies was collected via financial websites.

## FINDINGS

The 50 EURO STOXX companies in Europe are located only in 7 countries and are active in no less than 16 economic sectors. In six out of the seven countries, the women quota in supervisory boards in 2015 was higher than 25% in average (see figure 1).

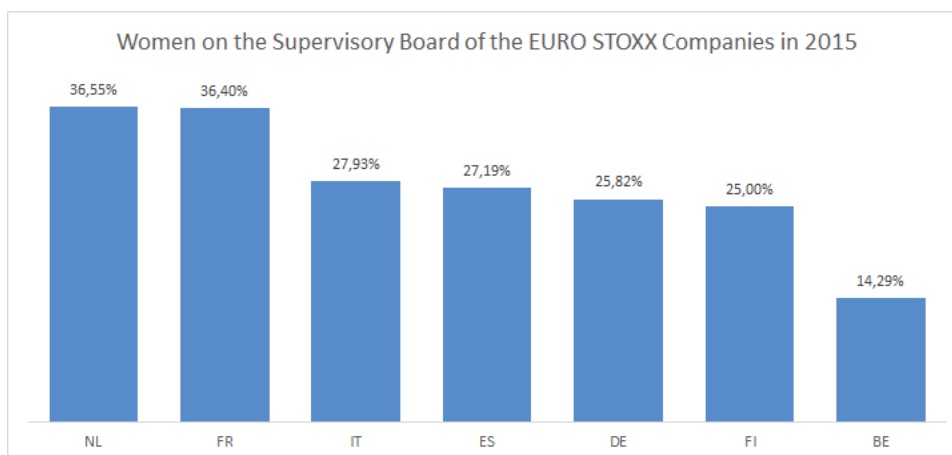

*Figure 1: Number of women on the supervisory board of EURO STOXX companies in 2015 in different countries*

*(Source: own representation – the information with regard to the number of women on the supervisory board was extracted from the 2015 annual reports of the respective companies)*

In contrast, only in two countries the women quota in management boards in the year 2014 was higher than 25% (Binder *et al.*, 2016). This shows that there are more women in supervisory boards than in management boards. If France and Germany, the countries with the highest number of companies in the EURO STOXX index are compared, one can see that France has a higher concentration of women in supervisory positions (36%) as well as a higher number of companies in the EURO STOXX index. However, these companies are less successful than the German companies in terms of EBT per employee. The German companies have a better EBT per employee although the women quota is lower when compared with that of French companies (26%). However, the 26 % women quota seems to lead to better results by EBT per employee in the top 10 companies compared to other German enterprises.

## DISCUSSION OF RESULTS AND CONCLUSION

The statistical analysis conducted in this study has shown that the raised hypothesis can be supported. Nevertheless, these findings should be treated cautiously. They do not imply that women in supervisory positions are more effective than men. With the exception of three companies, the supervisory boards of the other EURO STOXX 50 companies contain mainly male persons. The success of a company is also a result of the entire supervisory board, male and female alike.

*Keywords: women on corporate boards, firm performance, key performance indicators, gender quota, earnings before taxes*

## REFERENCES

- Beaufort V., Summers L., 2013. Women and Corporate Governance: Towards a New Model!, Research Center, ESSEC Working Paper 1312, 01 –44.
- Binder B.C.K., Alonso-Almeida M.M., Bremser K., 2016. Is enterprise success a women's topic, in: Proceedings of Euromed Conference 9, 267 – 278.
- Dick A., 2015. Female directors on German supervisory boards and firms' financial performance, University of Twente: Available at: [http://essay.utwente.nl/67308/1/DICK\\_BA\\_IBA.pdf](http://essay.utwente.nl/67308/1/DICK_BA_IBA.pdf) (accessed 31 March 2017).
- Ferreira, D., 2014. Board Diversity: Should we trust Research to Inform Policy? in: Corporate Governance: An International Review, (2014), 22(2), 1 - 4.
- McKinsey&Company, 2007. Women Matter: Gender Diversity, a Corporate Performance Driver. Available at: <http://www.raeng.org.uk/publications/other/women-matter-oct-2007> (accessed 31 March 2017).

# MARKETING DOCTRINE AS A PRECURSOR TO NEW PRODUCT DEVELOPMENT AND INTERNATIONAL PERFORMANCE: TOWARDS A TESTABLE THEORETICAL MODEL

**Boulos, Jumana Shukri; Shoham, Aviv**

Business Administration, University of Haifa, Haifa, Israel

## ABSTRACT

## INTRODUCTION

New product introductions have been commonly viewed as a key component of sustainable competitive advantage and as a vehicle for growing businesses profitably. However, most ideas for new products never get to the introduction phase and around 40% of new products of those introduced to the market fail to meet commercial objectives of the firms that launched them. In search of critical factors underlying new product success, we propose a model of new product performance utilizing Marketing Doctrine (MD hereunder), developed by Challagalla, Murtha, and Jaworski (2014) as a new concept that can help in advancing the understanding of success factors in developing new products. MD was defined as "a firm's unique principles, distilled from its experiences, which provide firm-wide guidance on market-facing choices". The conceptual model developed here is based on the notion that MD serves as an RBV resource. It leads firms to create new product development capabilities, through which they can develop innovative products, leading in turn to successful international market introductions and therefore to high international performance. The study should make an original contribution since it will provide a first empirical test of the relationship between MD and new product success.

Given the importance of successful new product introductions (Cooper 1979; Cooper and Kleinschmidt 1987; Yenipazarli 2014), considerable conceptual and empirical research has focused on new product success (NPS) factors. According to Cooper (1990), successful product innovations have payoffs in way of enhanced cash flows as well as in higher firm valuations by equity markets (Cooper 1990).

However, most ideas for new products never get to the introduction phase and around 40% of new products of those introduced to the market fail to meet commercial objectives of the business units that launched them (Crawford, 1977, 1987). Firms thus find themselves in a double bind. On one hand, they must innovate continuously and consistently to remain competitive, but on the other hand, innovation is risky and expensive. Thus, it is crucial to assess the role of critical factors underlying NPS (e.g., Cooper 1979; Cooper and Kleinschmidt 1987; Yenipazarli 2014).

In light of the above, we propose a model that utilizes MD (Challagalla, Murtha, and Jaworski 2014; CMJ hereunder) as an important precursor to the development and success of new products. CMJ (p. 7) defined MD as "a firm's unique principles, distilled from its experiences, which provide firm-wide guidance on market-facing choices".

While CMJ's paper was conceptual in nature, it provided some measure of support to the notion that greater use of MD enhances firms' performance, more so when competitive intensity is high. Moreover, their field research indicates that roughly 10% of fortune 500 firms have adopted this "principles-based" approach.

Based on CMJ's conceptualization of MD, we propose that it is a resource in the spirit of the Resource-Based-View theory (RBV hereunder) and use RBV-based arguments for explicating MD's role in contributing to NPS. RBV argues that resources satisfying four conditions (valuable, rare, inimitable and non-substitutable), contribute to the development of capabilities, which are sustainable competitive advantages (Barney 1991). MD satisfies the conditions underlying RBV theory thus serving as a basis for firms' capability for developing new products for international markets and through such a capability, contributes to international performance.

Our model is depicted in Figure 1. Based on the argument that MD serves as an RBV-like resource which meets the conditions required, it leads firms to create new product development capabilities, through which they can develop innovative products, leading in turn to successful international market introductions and therefore to high international performance. Testing empirically the integrative model shown in Figure 1 should help advance the marketing discipline understands of new product success factors.

The research will be based on a survey distributed to top managers of international Israeli companies. The sample will include companies from a wide cross-section of industries. Responses to the survey will be purchased from I-Panel, Israel's largest consumer panel company according to pre-specified conditions.

Statistical analyses will include descriptive statistics, correlations, reliability analyses (alpha coefficients), factor analyses, and regression models.

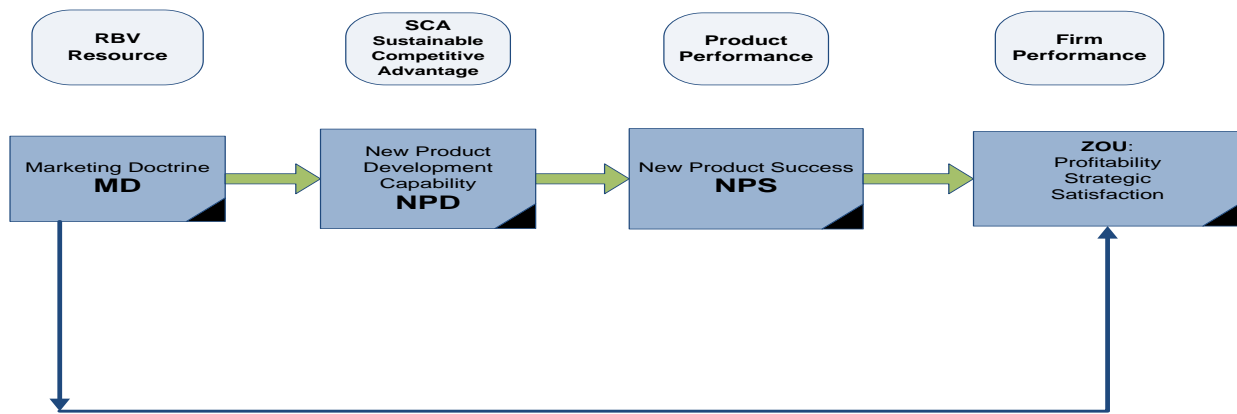

Figure 1. Proposed Research Model

**Keywords :** Marketing Doctrine, Resource-Based-View, New Product Success, International Performance.

## REFERENCES

- Barney, Jay B. (1991), "Firm Resources and Sustained Competitive Advantage," *Journal of management*, 17(1), 99-120.
- Challagalla, Goutam, Brian R. Murtha, and Bernard Jaworski (2014), "Marketing Doctrine: A Principle Based Approach to Guiding Marketing Decision Making in Firms," *Journal of Marketing*, 78(July), 4-20.
- Cooper, Robert G. (1979), "The Dimensions of Industrial New Product Success and Failure," *Journal of Marketing*, 4(3), 93-103.
- Cooper, Robert G. (1990), "Stage-Gate Systems: A New Tool for Managing New Products," *Business Horizons*, 33(3), (May-June), 44-54.
- Cooper, Robert G. and Elko J. Kleinschmidt (1987), "Success Factors in Product Innovation," *Industrial Marketing Management*, 16, 215-223.
- Crawford, C. Merle (1977), "Marketing Research and the New Product Failure Rate," *Journal of Marketing*, (41), 51-61.
- Crawford, C. Merle (1987), "New Product Rates: A Reprise," *Research management*, 30(4), 20-24.
- Yenipazarli, Arda (2014), "A Road Map to New Product Success: Warranty, Advertisement and Price," *Annals of Operations Research*, 226(1), 669-694.



## DOES MONEY BUY YOU HAPPINESS?

Bozcuk, Aslihan

Accounting and Finance, Department of Business Management, Akdeniz University, Antalya, Turkey.

### ABSTRACT

#### PURPOSE

Happiness has riveted many scholars since the times of Plato and Aristotle. There is a rich body of work that refers to happiness as a descriptive psychological term and an even colossally richer body of work that refers to happiness as a philosophical term. Regardless of the various approaches to defining the term, ask anyone you know if they are happy and they will have an answer for you. This provides the basic motivation for this research.

This study asks a simple question; “Does money buy you happiness?”. In doing so, it looks at the issue from a personal financial point of view and takes into account not just income but also a number of factors that might have an impact on the overall financial status of an individual. A novelty provided by this work is the inclusion of ‘hope’, or rather the lack of it, in the inquiry of the association between happiness and personal finances.

A basic search in SSCI<sup>1</sup> for the topic “happiness” brings 16,288 results, only 62 of which fall into the Business Finance category. Out of that 62, only 5 studies adopt the personal financial situation point of view. Hence this research is valuable in bridging the gap between happiness and personal finances through the novel inclusion of hope.

#### CONCEPTUAL FRAMEWORK

Happiness is defined by Aristotle as “the central purpose of human life” (Kraut, 2016). Also referred to as subjective well-being, happiness encompasses a broad number of elements relating to both physical and emotional well-being, such as good friends, wealth and power, to name a few. More recently, Wilson (1967) was the first to put together a comprehensive list of attributes a happy person possesses, which includes “young, healthy, well-educated, well-paid, extroverted, optimistic, worry-free, religious, married person with high self-esteem, job morale, modest aspirations, of either sex and of as wide range of intelligence” (p.294). These attributes carry quite a few common points with those originally suggested by Aristotle<sup>2</sup>.

---

<sup>1</sup> SSCI: Social Science Citation Index, Web of Science by Thomson Reuters.

<sup>2</sup> For a complete literature review, summarising more than 300 papers on the topic, please refer to Diener Et al.(1999) and Helliwell (2001).

The other pillar of this study, the lack of “hope” is defined as feelings about the future, loss of motivation and pessimistic expectations. Beck et al. (1974) constructed the Beck Hopelessness Scale (BHS), a well-established and widely-used instrument in quantifying hopelessness. It consists of a 20-item self-administered inventory, with ‘yes’ or ‘no’ answers, initially used in a clinical setup involving hospitalised patients who had recent suicide attempts. Recently, Pompili et al. (2016) use the BHS instrument in assessing the association between hopelessness, depression and subjective well-being.

## METHODOLOGY

A short questionnaire was administered in public places, usually city centres and shopping malls, in 10 different cities in Turkey. City selection was based on obtaining the widest possible array of economic, geographical and cultural differences. Question selection is based on Helliwell (2003) with modifications to reflect country-specific conditions and the addition of the BHS. Every third person was approached and invited to participate in the one-page, anonymous questionnaire including questions about their age, gender, marital status, number of children, chronic illnesses, education status, ownership of a house and a car, employment and pension status, happiness rated on a 10-point visual scale and the BHS inventory. There are 1.482 respondents with a rejection rate of 40.7%.

## FINDINGS

The average (min-max) happiness score is 6.08 (0-10), average age is 35 (19-75) and average Beck Score was 6.52 (0-20), respectively. 52% of the respondents are male.

Table 1. Univariate and Multivariate Regression Results

	Model 1		Model 2		Model 3*	
	Coeff.	P	Coeff.	P	Coeff.	P
Household Income	0.250	0.000			0.142	0.000
Beck Score			-0.472	0.000	-0.462	0.000
Work Status					-0.112	0.002
Adjusted R2	6.1%		22.1%		27.6%	
F	38.9		167.3		71.5	
P-value	0.000		0.000		0.000	

Dependent variable: Happiness Score. (\*) Forward Stepwise Regression including all variables.

Table 1 presents the results of the univariate and the multivariate regressions, with happiness as the dependent variable. All 3 models are statistically significant with a p-value of 0.000. In Model 1, household income is positive and significantly related with happiness. In model 2, as expected, there is a negative and significant relation between happiness and the Beck Score. While income alone can explain 6.1%, the beck score alone can explain 22.1% of the variability in happiness. Model 3, shows the results of the multivariate regression (forward stepwise) including all of the variables included in the

study. Income, the Beck score and work status together can explain 27.6% of the variability in happiness. Work status, defined on a 5-point scale from most to least job security, is negatively related with happiness.

Based on these findings, it is safe to say that, money does have a positive impact on happiness. However, taking into account all the demographic, financial, health and employment related variables included in this study, future prospects in terms of hope and job security, seem to have a much greater bearing on how happy we are.

*Keywords: Happiness, Income, Personal Financial Status, Hope, Beck Hopelessness Scale (BHS)*

## REFERENCES

- Beck, A. T., Weissman, A., Lester, D., and Trexler, L. (1974), "The measurement of pessimism: the hopelessness scale", *Journal of Consulting and Clinical Psychology*, Vol. 42(6), pp. 861-865.
- Diener, E., Suh, E.M., Lucas R.E., and Smith, H.L. (1999), "Subjective well-being: three decades of progress", *Psychology Bulletin*, Vol. 125, pp. 276-302.
- Helliwell, J.F. (2001), "Social capital, the economy and well-being", in Banting, K., Sharpe A., St-Hillaire, F. (eds.) *The Review of Economic Performance and Social Progress*, Institute for Research and Public Policy-Centre for the Study of Living Standards- Montreal, Canada, pp. 43-60.
- Helliwell, J.F. (2003), "How's life? Combining individual and national variables to explain subjective well-being", *Economic Modelling*, Vol. 20, pp. 331-360.
- Kraut, R. (2016), "Aristotle's Ethics", in Edward N. Zalta (ed.), *The Stanford Encyclopaedia of Philosophy* (Spring 2016 edition), Stanford University.
- Pompili, M., Innamorati, M., Lamis, D:A., Lester, D., Fiore, E.D., Giordano, G., Ricci, F., Erbutto, D., Tambelli, R., Balestrieri, M., Amore, and M., Girardi, P. (2016), "The interplay between suicide risk, cognitive vulnerability, subjective happiness and depression among students", *Current Psychology*, Vol. 35, pp. 450-458.
- Wilson, W. (1967), "Correlates of avowed happiness", *Psychological Bulletin*, Vol. 67, pp. 294-306.

# HRM-PATIENT ORIENTATION AND TEAMWORK CLIMATE LINKAGE IN HEALTH CARE INSTITUTIONS: THE ROLE OF CALLING AND PROSOCIAL MOTIVATION

Bučionienė, Ilona<sup>1</sup>; Goštautaitė, Bernadeta<sup>1</sup>; Žemyna Milašauskienė<sup>2</sup>

<sup>1</sup>Management department, ISM University of Management and Economics, Vilnius, Lithuania

<sup>2</sup>Lithuanian University of Health Sciences, Kaunas, Lithuania

## ABSTRACT

## INTRODUCTION

Although a weak patient orientation and a poor teamwork climate among healthcare professionals may have far-reaching implications, such as increased medical error and patient mortality (Sexton et al., 2006), their antecedents have been rarely studied in management research. This issue can be analyzed from organizational as well as from individual perspectives.

What are the organizational and individual mechanisms which lead to teamwork climate and patient orientation of healthcare professionals? Research covering individual and organizational factors influence on healthcare-relevant work outcomes such as teamwork climate and patient orientation has been scarce.

In this study we aim to analyze the role of human resource management system and healthcare professionals' calling and prosocial motivation in fostering teamwork climate and patient orientation in health care institutions.

## THEORETICAL APPROACH

From the organizational perspective, we propose that team-oriented human resources management practices may play an important role in hospitals through strengthening the teamwork climate, as providing of healthcare is based on a complex multidisciplinary collaboration in teams (Ang, Bartram, McNeil, Leggat, & Stanton, 2013; Leggat, Bartram, & Stanton, 2008). We rely on the configurational human resource management approach, which suggests that strategically designed human resource management systems with specific human resource management practices supporting and reinforcing each other, generate synergistic effects and lead to targeted employees' attitudes and behaviors (Subramony, 2009).

From the individual perspective, healthcare professionals' job is associated with personal calling, i.e. "work that a person perceives as his purpose in life" (Hall & Chandler, 2005, p.6), that satisfies his core values (Schabram, K. and Maitlis, S., 2017). Its source is an internal motivation (Hall & Chandler,

2005) and this work is expected to be intrinsically enjoyable, meaningful (Berg, Grant, & Johnson, 2010) and itself should lead to higher patient orientation.

Another important individual factor for patient orientation may be prosocial motivation. Prosocially motivated employees are driven not by inherent interest in the work itself, but rather by the need to expend effort to benefit other people (Grant, A.M., 2008) i.e. patients or colleagues. Therefore, prosocial motivation may have a positive impact on teamwork and patient orientation. Consequently, we can suppose that calling and prosocial motivation could be two important individual factors affecting healthcare professionals' patient orientation.

In our theoretical model (See Figure 1) we propose that prosocial motivation of healthcare professionals and team-oriented human resources management both increase patient orientation. We further suggest that the relationship between team-orientated human resource management practices and patient orientation is mediated by teamwork climate and moderated by calling.

Figure 1. Theoretical model

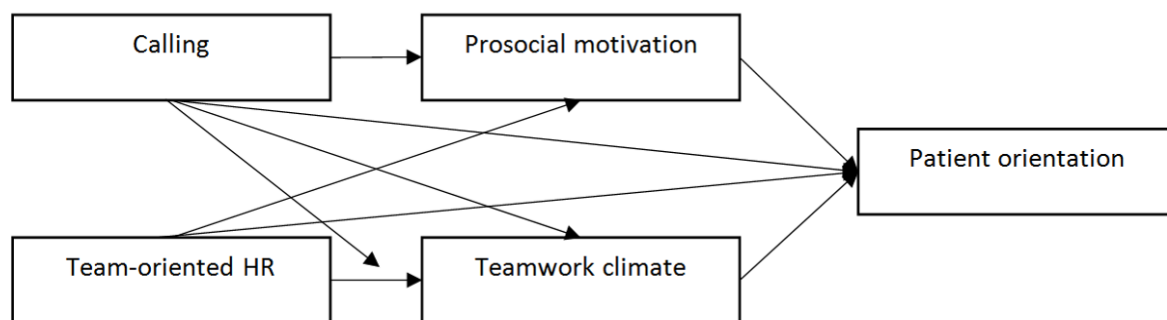

We test following hypotheses:

H1. Team-oriented HRM will be positively related to patient-orientation.

H2. Calling will be positively related to patient-orientation.

H3. Teamwork climate will mediate the relationship between team-oriented HRM and patient-orientation.

H4. Prosocial motivation will mediate the relationship between calling and patient-orientation.

H5. Calling will moderate the mediated relationship between team-oriented HRM and patient-orientation.

## RESEARCH DESIGN AND APPROACH TO DATA ANALYSIS

We conducted a survey of healthcare professionals (physicians and nurses) in 4 hospitals in Lithuania. A multiple regression analysis with MPLUS was calculated to test the proposed moderated-mediation model (Preacher, Rucker, and Hayes, 2007).

## **FINDINGS**

The results of the regression analysis showed that both calling and team-oriented HRM had positive effects on patient-orientation (H1 and H2 supported). Further, teamwork climate and prosocial motivation were also positively related to patient-orientation. Teamwork climate mediated the effect of team-oriented HRM and prosocial motivation mediated the effect of calling on patient-orientation (H3 and H4 supported). An investigation of direct and indirect effects revealed, that both direct effects were non-significant, indicating a full-mediation. Additionally, we observed a small but statistically significant indirect effect of team-oriented HRM on patient-orientation through prosocial motivation. An interaction of calling and team-oriented HRM had a negative regression coefficient, indicating that for employees with strong perceptions of calling the impact of team-oriented HRM on patient-orientation was weaker than for employees with weaker perceptions of calling (H5 supported).

## **ORIGINALITY/CONTRIBUTION**

The current research provides new insights into the linkage between human resource management practices and positive healthcare-related organizational outcomes, such as teamwork climate and patient orientation by illustrating the effects of individual prosocial motivation and calling. We contribute to the human resource management literature by shedding light on healthcare industry which is very specific and which has been under researched in previous studies.

## **THE PRACTICAL SIGNIFICANCE**

This research has profound managerial implications suggesting that teamwork climate in hospitals as well as patient orientation of healthcare professionals can be enhanced by team-orientated human resource management practices.

## **ACKNOWLEDGEMENT**

This research was supported by the Lithuanian Research Council (Project No. GER-17071).

*Keywords: patient orientation, human resource management, calling, prosocial motivation, health care institutions, health care professionals.*

## REFERENCES

- Ang, S. H., Bartram, T., McNeil, N., Leggat, S. G., & Stanton, P. (2013), "The effects of high-performance work systems on hospital employees' work attitudes and intention to leave: a multi-level and occupational group analysis" *The International Journal of Human Resource Management*, Vol.24 No.16, pp. 3086-3114.
- Grant, A.M. (2008), "Does intrinsic motivation fuel the prosocial fire? Motivational synergy in predicting persistence, performance, and productivity" *Journal of applied psychology*, Vol.93 No.1, pp.48-58.
- Hall, D. T., & Chandler, D. E. (2005). Psychological success: "When the career is a calling". *Journal of organizational behavior*, 26(2), 155-176.
- Leggat, S., Bartram, T., & Stanton, P. (2008), "Exploring the lack of progress in improving patient safety in Australian hospitals". *Health Services Management Research*, Vol.21 No.1, pp. 32-39.
- Preacher, K. J., Rucker, D. D., & Hayes, A. F. (2007), "Addressing moderated mediation hypotheses: Theory, methods, and prescriptions" *Multivariate Behavioral Research*, Vol.42 No.1, pp. 185-227.
- Sexton, J., Holzmueller, C., Pronovost, P., Thomas, E., McFerran, S., Nunes, J., Fox, H. (2006) "Variation in caregiver perceptions of teamwork climate in labor and delivery units" *Journal of perinatology*, Vol.26 No.8, pp. 463-470.
- Subramony, M. (2009), "A meta-analytic investigation of the relationship between HRM bundles and firm performance" *Human resource management*, Vol.48 No. 5, pp.745-768.
- Schabram, K. and Maitlis, S. (2017), "Negotiating the challenges of a calling: Emotion and enacted sensemaking in animal shelter work" *Academy of Management Journal*, Vol. 60 No. 2, pp.584-609.

# INNOVATION NETWORK DYNAMICS IN THE AEROSPACE CLUSTER IN TUSCANY

Capone, Francesco; Zampi Vincenzo

Dept. name of organization, name of organization, acronyms acceptable, City, Country

## ABSTRACT

In the debate on the new trends in innovation studies and the research and development (R&D) management of innovation networks (Kastelle and Steen, 2014; Dagnino et al., 2015), a significant amount of attention is being increasingly devoted to the role of similarity among partners in forming new relationships or partnerships (Molina-Morales, 2015; Ahuja et al. 2009).

Scholars of social network analysis have long discussed the concept of homophily (McPherson et al., 2001), which is the tendency of two partners that share some characteristics (sex, age, habits, etc.) to have a higher propensity to develop some kind of relationships (friendship, business, etc.). In recent years, literature on innovation studies and innovation networks has primarily focused more attention on the concept of proximity, particularly on what is known as cognitive proximity or geographical proximity (Molina-Morales, 2014; Boschma, 2005), especially paying attention to how the proximity between partners facilitates firms and networks' innovativeness (Muscio, 2006).

The debate on proximity is widespread, and some forms of proximity are perceived negatively as obstacles to collaborating or developing partnerships among firms and research centres or universities (Ben Letaifa and Rabeau, 2013; Broekel and Boschma, 2011).

Within the research on innovation networks, many authors have focused on these issues, discussing as many as five to seven different forms of proximity which encourage the formation of relationships and innovation (Knoben and Oerlemans, 2006; Boschma, 2005). Generally speaking, there are at least five forms of proximity that are recognized in the literature: geographical, cognitive, organisational, institutional and social proximity.

However, most contributions on proximity and innovation networks, at this time, are based mainly on case studies or qualitative analysis (Ritter and Gemunden, 2003; Knoben and Oerlemans, 2006) with only a few quantitative exceptions (Balland, 2012; Morrison et al., 2015; Molina-Morales, 2014; Presutti et al., 2012; Capaldo and Petruzzelli, 2014).

The aim of this study is to analyse the role of various forms of proximity in the formation of inter-organisational innovation collaborations and, specifically, to investigate how organisations have chosen their partners to form innovation networks. The paper focus on the aerospace cluster in Tuscany as a high technology business, composed by large and small and medium firms that develops innovation thanks to inter-organizational collaborations.



The work contributes to management and innovation network studies through a novel methodology for network analysis, Exponential Random Graph Models (ERGM), that allows to analyse large networks, and it also fits into the contemporary availability of big data to support management decisions and the analysis of competitive environments.

The methodology can be of interest in management and innovation network studies as it allows the analysis and measurement of the impact of different types of variables in very large networks composed of numerous organisations and relationships (Pina and Lazega, 2010; Broekel and Hartog, 2013). This application is particularly useful when it is necessary to investigate multidisciplinary inter-organisational networks in high-technology industries involving several national and international firms and organisations.

For these purposes, we adopt the novel statistical methodology of exponential random graph models (ERGMs) (Hunter et al., 2008) that allows us to investigate and provide statistical estimations of the structure of large networks.

This paper analyses innovation networks operating in the business of high-technology of aerospace industry in Tuscany. The aerospace industry is particularly interesting as is growing sector, where innovation happens thanks through inter-organizational networks. A questionnaires on innovation dynamics and collaborations have been administered to the firms operating in the aerospace cluster in Tuscany. A redemption rate of 75% permits to apply social network analysis to the answers on relationship dynamics.

Our results underline the importance of various forms of proximity in the formation of innovation networks. Moreover, the work points out managerial implications in innovation studies and R&D management in order to assist firms in choosing their partners and forming an innovation network.

*Keywords: innovation network, aerospace industry, cluster, tuscan, proximity, social network analysis*

## REFERENCES

- AHUJA G., POLIDORO J.R. MITCHELL W. (2009), "Structural homophily or social asymmetry? The formation of alliances by poorly embedded firms", *Strategic Management Journal*, vol. 30, pp. 941-958.
- BALLAND, P.A. (2012), "Proximity and the evolution of collaboration networks: Evidence from research and development projects within the Global Navigation Satellite System (GNSS) industry". *Research Policy*, vol. 46, n. 6, pp. 741-756.
- BEN LETAIFA S. RABEAU Y. (2013). "Too close to collaborate? How geographic proximity could impede entrepreneurship and innovation". *Journal of Business Research*, vol. 66, n. 10, pp. 2071-78.
- BOSCHMA R. (2005), "Proximity and innovation: A critical assessment", *Regional Studies*, vol. 39, n. 1, pp. 61-74.
- BROEKEL, T. HARTOG, M. (2013), "Explaining the structure of inter-organizational networks using exponential random graph models", *Industry and Innovation*, vol. 20, n. 3, pp. 277-295.

- CAPALDO, A., PETRUZZELLI, A. M. (2014), "Partner Geographic and Organizational Proximity and the Innovative Performance of Knowledge-Creating Alliances". *European Management Review*, vol. 11, n. 1, pp. 63-84.
- DAGNINO, G.B., LEVANTI, G., MINA' A., PICONE P.A. (2015), "Interorganizational network and innovation: a bibliometric study and proposed research agenda", *Journal of Business & Industrial Marketing*, vol. 30, n. 3/4, pp. 354 - 377.
- GRANOVETTER, M. (1973), "The strength of weak ties". *American Journal of Sociology*, vol. 78 , n. 6, pp. 1360-1380.
- HUNTER D.R., HANDCOCK M.S., BUTTS C.T. GOODREAU S.M., MORRIS M. (2008), "ERGM: A Package to Fit, Simulate and Diagnose Exponential-Family Models for Networks", *Journal of Statistical Software*, vol. 24, n. 3, p. 1-29.
- KASTELLE, T., STEEN, J. (2014), "Networks of innovation". In Dodgson, M., Gann D. M. and Phillips N. (Ed.), *The Oxford Handbook of Innovation Management* (pp. 102-120) Oxford, UK: Oxford University Press.
- KNOBEN J., OERLEMANS, L.A.G. (2006), "Proximity and inter-organizational collaboration: A literature review", *International Journal of Management Reviews*, vol. 8, n. 2, pp. 71-89.
- MCPHERSON, M., SMITH-LOVIN, L., COOK, J.M. (2001), "Birds of a Feather Homophily in Social Networks", *Annual Review of Sociology*, vol. 27, pp. 415-44.
- MOLINA-MORALES F.X., BELSO-MARTINEZ J. A., MAS-VERDÙ F., MARTINEZ-CHÀFER L. (2015), "Formation and dissolution on inter-firm linkages in lengthy and stable networks in clusters", *Journal of Business Research*, vol. 68, n. 7, pp. 1557-1562.
- MUSCIO, A. (2006). "Patterns of innovation in industrial districts: an empirical analysis". *Industry and Innovation*, vol. 13, n. 3., pp. 291-312.
- PINA-STRANGER A., LAZEGA E. (2010), "Inter-organisational collective learning: the case of biotechnology in France", *European Journal of International Management*, vol. 4, n. 6, pp. 602-620.
- POWELL W.W., GRODAL, S. (2005), "Networks of Innovators". *The Oxford Handbook of Innovation*, (pp. 56-85).
- PRESUTTI, M., BOARI, C., MAJOCCHI, A. (2011). "The Importance of Proximity for the Start-Ups' Knowledge Acquisition and Exploitation". *Journal of Small Business Management*, vol. 49, n 3, pp. 361-389.
- RITTER T., GEMUNDEN H. G. (2003), "Inter-organizational relationships and networks: An overview", *Journal of Business Research*, vol. 56, n. 9, pp. 691- 697.

## MANAGING ORGANIZATIONAL AND BRAND IDENTITY IN FAMILY FIRM: PRELIMINARY EVIDENCES FROM AN ITALIAN CASE

Casprini, Elena<sup>1</sup>; Ticci, Camilla<sup>2</sup>; Zanni, Lorenzo<sup>2</sup>

<sup>1</sup>Institute of Management, Scuola Superiore Sant'Anna, Pisa, Italy

<sup>2</sup>Department of Business and Law, University of Siena, Siena, Italy

### ABSTRACT

### INTRODUCTION

This paper explores how a family firm manages its identity, distinguishing between organizational identity and brand identity. Family firms represent an important type of organization worldwide and have attracted a lot of attention from both academics and practitioners. Most of research has focused on the characteristics of family firms especially with respect to internationalization and, more recently, innovation strategies, but least attention has been deserved to how family firms' peculiarities may influence marketing strategies (Micelotta and Raynard 2011; Reuer and Fischer 2010). In particular, little is known about how family firms manage their organizational identity and brand identity (Micelotta and Raynard 2011).

### LITERATURE BACKGROUND

The paper links two streams of research: that of organizational identity, usually adopted by organization and management scholars, and that of brand identity, widely adopted by marketing scholars and managers.

An organizational identity refers to "*organization members' collective understanding of the central, distinctive and enduring character of the organization*" (Micelotta and Raynard, 2011:198). For long time, organizational identity theorists have noted that organizational identity is *enduring*, i.e. "*an identity that remains the same over time*" (Gioia and Corely, 2000: 65), but also has a sense of continuity (Gioia and Corley, 2000). On the contrary, organizational identity scholars have noted that organizational identity changes over time. Gioia and Corley (2000), for example, introduce the concept of adaptive instability in organizational identity, sustaining that firms possess an identity, linked to its self-definition, and an image, derived from how third parties define the firm, and that the interrelationship between identity and image are mutually influencing and evolving over time.

On the other side, a brand identity refers to "*the consistent and targeted representations of the organization in its managed communication with external communication*" (Micelotta and Raynard, 2011:198). Extant research has noted that family firms tend to communicate their brand identity with

different strategies, such as family preservation, family enrichment and family subordination (Micelotta and Raynard 2011). Overall, brand management serves for bridging identity and image (Beck 2016), and empirical research notes that family-based brand identity influences competitive orientation and firm performance (Craig, Dibrell, and Davis 2008).

Bridging these two streams of research, the aim of this paper is to explore the mechanisms underlying how a family firm manages its organizational identity and brand identity.

## METHODOLOGY

We adopted a single case study design (Yin 2003). The single case of an Italian family firm has been analysed. Data were collected by in-depth interviews on two family- and two non-family members, direct observation derived from a six-month internship and secondary data sources, mainly corporate presentations and websites. Interviews were recorded and transcribed. We adopted the Gioia's methodology for analysing data and we use NVivo10 software for coding analysis (Gioia, Corley, and Hamilton 2013). Starting from quotes of the informants and the derived concepts, five themes (Organizational identity, Brand Identity; Preserving founder's style in products; Maintaining territory linkages; Smoothly Leveraging on new communication channels) and two aggregate dimensions (Identities; Professional managers actions) were identified.

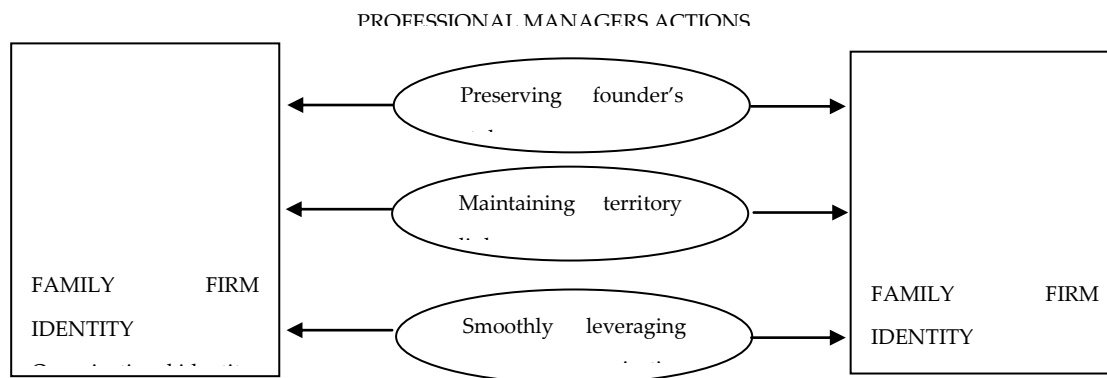

**Figure 1.** Professional managers actions and family firm's identities

## RESULTS AND DISCUSSION

Our case reveals that the family firm manages its organizational identity and brand identity through three mechanisms ("Professional managers actions"): (1) preserving founder's style in products, (2) maintaining territory linkages, and (3) smoothly leveraging on new communication channels. The case also stresses that these three mechanisms have been triggered by the professionalization of the family

firm. The professionalization of the family firm happens through second-generation family members and the involvement of nonfamily members. Figure 1 represents the findings of the case.

The paper presents limitations of qualitative approaches, often linked to a certain degree of subjectivity in developing codes. We suggest that multiple case studies might be carried on in order to theoretically generalize our results.

From a managerial point of view, our case suggests that in managing their identity, family firms have to distinguish between their organizational and their brand identities, and to create a fit among them via the three mechanisms introduced. Managing brand is important for competing, but in order to build a brand image family firms need to first developing their organizational identity.

*Keywords: organizational identity; brand identity; family firm; professionalization*

## REFERENCES

- Beck, S. (2016). "Brand Management Research in Family Firms - a Structured Review and Suggestions for Further Research." *Journal of Family Business Management* Vol. 6 No. 3, pp. 225-250.
- Craig, J. B., Dibrell, C. and Davis, P. S. (2008). "Leveraging Family-Based Brand Identity to Enhance Firm Competitiveness and Performance in Family Businesses." *Journal of Small Business Management*, Vol. 46 No. 3, pp. 351-371
- Gioia, D. A., Corley, K. G. and Hamilton, A. L. (2013). "Seeking Qualitative Rigor in Inductive Research: Notes on the Gioia Methodology." *Organizational Research Methods*, Vol. 16, pp. 15-31.
- Gioia, D. A. and Corley, K.G. (2000). "Organizational identity, image, and adaptive instability." *Academy of Management Review*, Vol. 25 No. 1, pp. 63-81.
- Micelotta, E. R. and Raynard, M. (2011). "Concealing or Revealing the Family ? Corporate Brand Identity Strategies in Family Firms." *Family Business Review*, Vol. 24 No. 3, pp. 197-216.
- Reuer, A. R. and Fischer, E. (2010). "Marketing (in) the Family Firm." *Family Business Review*, Vol. 24 No. 3, pp. 193-96.
- Yin, R. K. (2003). *Case Study Research. Design and Methods*. Thousand Oaks: SAGE Publications.

# **CRITICAL SUCCESS FACTORS OF THE MERGERS AND ACQUISITIONS PERFORMANCE: INTERRELATIONSHIP OF PLANNING STAGE (PRE- MERGER) AND INTEGRATION PROCESS (POST-MERGER)**

**Chew, Grace**

Business Administration, International School of Management, Paris, France

## **ABSTRACT**

This study addresses the neglected variables, such as due diligence analysis and cultural differences analysis at the pre-merger stage, and HR practices at the post-merger stage, and highlights gaps in the literature, by indicating the understanding of the important relationships between pre- and post-merger stages as a major area for improvement in mergers and acquisitions (M&A) research and organizational performance. The complicated nature of M&A situations has prevented M&A practitioners from achieving the maximum results after the M&A.

Different streams of research have studied different areas of the M&A stages. Historically, two main streams of management research have studied either pre- or post-merger integration stages. One stream, focusing on the pre-merger stage, examined the relationship between firm-level measures of financial performance and the strategic fit between buying and selling firms (Singh and Montgomery, 1988; Palich et al., 2000), with an emphasis on the potential synergy and added value of the acquisition to the buying company, in other words, on choosing the right merger. The other stream focuses on the post-merger stage, and examines the cultural fit of the buying and selling firms, and its impact on the success of the merged company (Chatterjee et al., 1992; Sarala and Vaara, 2010; Stahl and Voigt, 2008; Weber et al., 1996; Weber, 1996; Weber et al., 2011b). However, these studies pay little attention to cross-cultural management, despite the fact that cultural differences play an important role in the success or failure of M&A.

Different streams of research focus on different research levels. The strategic management literature has primarily focused on strategic analysis, which identifies characteristics of the two firms and looks into the best strategic fit to realize the maximum synergy potential and value creation in M&A. On the other hand, the organizational behavior literature has primarily focused on factors pertaining to the human side during post-merger integration. These include a focus on individual behavior and the processes during integration, such as top executives' commitment and turnover as a result of culture clashes (Lubatkin et al., 1999; Weber, 1996; Weber et al., 1996; Weber and Drori, 2011), structural changes (Ellis et al., 2012; Weber, Tarba, and Bachar, 2011), and HR practices, such as the different effects of training and communication on M&A success in various countries (Weber et al., 2012). Each stream of research focusing on different variables has led to inconsistent findings.

There are also two other streams of research focusing on different types of variables (context versus process). More researchers pay attention to the research of context variables at the pre-merger stage, while others focus more the process variables at the post-merger stage. Table 1 shows that context variables that have received high attention at the pre-merger stages include relatedness, cultural differences, buyer experience, and relative size in previous M&A. On the other hand, process variables that have been investigated, usually at the post-merger stages, include HR practices, level of integration, communication, and structural changes.

	Pre- merger	Negotiation	Post- merger
Context	Relatedness, Cultural Differences, Experience, Relative size		
Process			HR practices, level of Integration, Communication, Structural changes

*Table 1. Variables that received high research attention (Source: Handbook of research on mergers and acquisitions by Weber, 2013)*

Table 2 shows examples of variables that receive more research attention. However, among the differences between the two streams is that process variables, such as planning at the pre-merger stage, receive much less attention. Process variables, such as planning (including due diligence analysis and cultural differences analysis) at pre-merger stage and HR practices at post-merger stage, are the variables requiring further research (Weber, 2013). A recent article showed the role of cultural differences analysis in all M&A stages but most of the potential relationships are yet to be explored (Weber and Tarba, 2012).

	Pre-merger	Negotiation	Post-merger
Context	Trust	Cultural differences	Trust, identity, New culture
Process	Planning	Negotiation process	Integration approaches, HR practices, Cultural changes

*Table 2. Example of stages that may receive more research attention (Source: Handbook of research on mergers and acquisitions by Weber, 2013)*

Examples of hypotheses for this study are as follows:

H1: The higher the planning level the higher M&A performance

H2: The higher the planning level the higher the use of HR practices at post merger stage

H3: The higher the use of HR practices at post merger stage the higher M&A performance

*Keywords: mergers and acquisitions (M&A), cultural differences analysis, due diligence analysis, pre-merger, HR practices, post-merger, M&A performance*

## REFERENCES

- Chatterjee, S., Lubatkin, M. H., Schweiger, D. M., and Weber, Y. (1992), "Cultural differences and shareholders value: Explaining the variability in the performance of related acquisitions", *Strategic Management Journal*, Vol. 13, pp. 319–334.
- Ellis, K. M., Weber, Y., Raveh, A., and Tarba, S. Y. (2012), "Integration in large, related M&As: Linkages between contextual factors, integration approaches, and process dimensions", *European Journal of International Management*, Vol. 6(4), pp. 368–394.
- Montgomery, C.A., and Singh, H. (1984), "Diversification strategy and systematic risk". *Strategic Management Journal*. Vol. 5, pp. 181–191.
- Palich, L.E., Cardinal, L.B., and Miller, C.C. (2000), "Curvilinearity in the diversification performance linkage: An examination of over three decades of research", *Strategic Management Journal*, Vol. 21, No. 2, pp. 155–174.
- Sarala, R.M. and Vaara, E. (2010), "Cultural differences, convergence, and crossvergence as explanations of knowledge transfer in international acquisitions". *Journal of International Business Studies*, Vol. 41, pp. 1365–1390.
- Stahl, G.K. and Voigt, A. (2008), "Do cultural differences matter in mergers and acquisitions? A tentative model for examination", *Organization Science*, Vol. 19, No.1, pp. 160–176.
- Weber, Y. (1996), "Corporate culture fit and performance in mergers and acquisitions". *Human Relations*, Vol. 49, No. 9, pp.1181–1202.
- Weber, Y., Shenkar, O. and Raveh, A. (1996) 'National and corporate fit in mergers and acquisitions: an exploratory study', *Management Science* 4(8): 1215-1227.
- Weber, Y., and Drori, I. (2011), "Integration of organizational and human behavior perspectives on mergers and acquisitions: Looking inside the black box", *International Studies of Management and Organization*, Vol. 41, No 3, pp. 76–95.
- Weber, Y., and Fried, Y. (2011b), "The dynamics of employee reactions during post- merger integration process". *Human Resource Management*, Vol. 50, No. 6, pp. 777–781.
- Weber, Y., Tarba, S. Y., and Rozen B, Z. (2011). "Mergers and acquisitions performance paradox: The mediating role of integration approach", *European Journal of International Management*, Vol. 5, pp. 373–393.
- Weber, Y., Rachman-Moore, D., and Tarba, S. Y. (2012), "HR practices during post-merger conflict and merger performance". *International Journal of Cross Cultural Management*, Vol. 12, No 1, pp. 73–99.
- Weber, Y. (2013), *Handbook on research of mergers and acquisitions*. Edward Elgar Publishing Limited.



## FOOD WASTE REDUCTION AND SHELF LIFE EXTENSION: THE CASE STUDY OF OLIVE PATÈ

Chiara, Filomena<sup>1</sup>; Pellegrini, Giustina<sup>1\*</sup>; Contò, Francesco<sup>1</sup>

University of Foggia, Italy

### ABSTRACT

The food sector has to manage a number of complexities generally dealt within supply chain management, besides products perishability (Van der Vorst *et al.*, 2005). Actually, food scraps or losses represent irrational use of resources producing a negative direct impact on the income of entrepreneurs and consumers (Fiore *et al.*, 2015; Eriksson *et al.*, 2012); therefore a coordinated strategy that improves the entire supply chain efficiency is required. Fruits and vegetables usually account for the highest proportion of food waste in many developed countries (Stefan *et al.*, 2012). According to FAO (2013) the global carbon footprint (CF) of annual food wastage is about 3.3 Gt CO<sub>2</sub> equivalent (CO<sub>2e</sub>). The amount of annual food waste in Europe is estimated to increase from over 100 million tons in 2014 to about 126 million tons by 2020 (European Commission, 2016). Therefore, the efficient management of food waste along the supply chains is receiving a lot of attention by institutions (Boxstael *et al.*, 2014), especially given to perishable products that are among the most wasted food items within supply chains and households. In the recent past the most significant efforts in food science and technology have been addressed to extending the commercial life of food and beverages. In this context, however, very little or null attention has been paid to the possible positive contribution, coming from a shelf life extension (SLE) to the overall sustainability of a product supply chain (Amani and Gadde, 2015). Nevertheless, a shelf life extension can contrast food losses and the logistic distribution impacts.

In this regard the authors evaluate the shelf life extension impact on the entire olives derivate (olives patè) supply chain. Olives patè is a product obtained by the crush of table olives and the addition of EVOO. It has been proven that manufacture and agricultural practices such as fertilization contributed to the highest burdens in all impact categories and cropping systems (Martucci and Arcese, 2010; De Gennaro *et al.*, 2012). The selection of the aforementioned product was done considering the importance of olives, oil and derivate in Apulia region. These products are traditionally cultivated in the Mediterranean countries (Spain, Italy, Greece and Turkey, mainly) and, more recently, in America, Australia and the Middle East (IOC, 2016). In Mediterranean area, olive farming is crucial for the cultural heritage and the economy with significant social and environmental impacts. Furthermore, the selection of that product was influenced by the beneficial effects on human health due to all of the antioxidant properties of phenolic compounds.

Numerous studies regarding olive oil health benefits, have stimulated the interest of researchers focusing on recovery of such active compounds using pruning waste. In this regard, some researchers evaluated the addition of polyphenols, extracted from waste such as leaves in olive patè made with olives and extra-virgin olive oil). Therefore a dual function is achieved: reuse of waste and introduction of a new healthy product in the market. In addition, the antioxidant action of these active compounds allows to preserve the product, extend its shelf life and consequently reducing waste (in downstream of supply chain). The main objective of this study is to investigate which decisions may be altered/re-optimized because of longer shelf-life considering a minimization of CO<sub>2</sub> emission and economic impact. This could be done redesigning the single supply chain to verify what are the main processes along the product's supply chain that more contribute to waste reduction, economic and environmental sustainability:

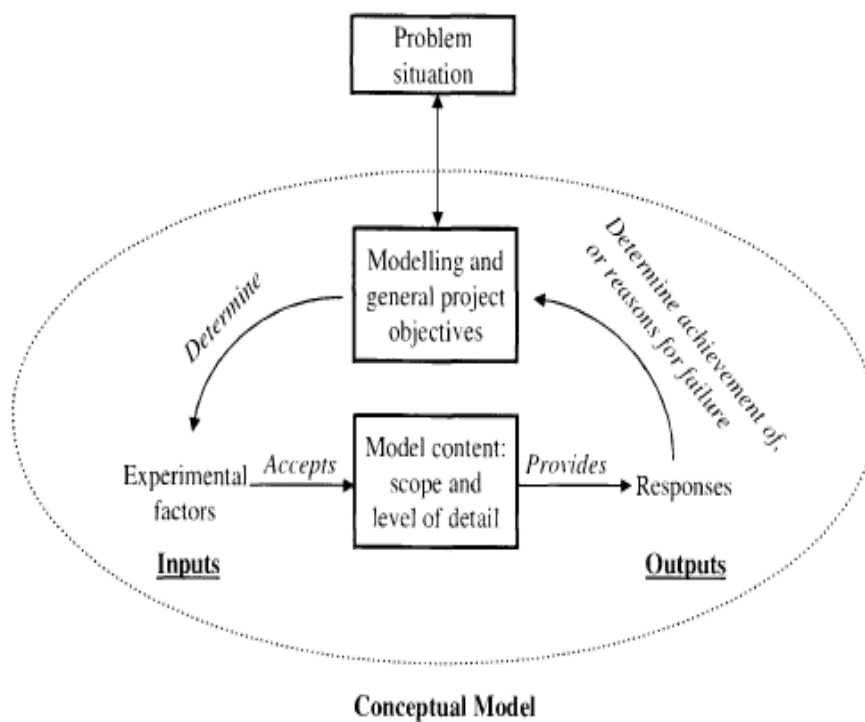

Figure 1- Framework for designing conceptual model

The expected results show that SLE seems to have a positive effect on the environment and economic sustainability considering the active compound recovery as well as food waste reduction.

*Keywords: healthiness, sustainability, waste-reuse, waste reduction, product's differentiation*

## REFERENCES

- Amani, P., & Gadde, L. E. (2015) "Shelf life extension and food waste reduction". Proceedings in Food System Dynamics, 7-14.
- Boxstael, S. Van, Devlieghere, F., Berkvens, D., Vermeulen, A., Uyttendaele, M. (2014) "Understanding and attitude regarding the shelf life labels and dates on pre-packed food products by Belgian consumers". Food Control, 137: 85-92.
- De Gennaro, B., Notarnicola, B., Roselli, L., Tassielli, G. (2012) "Innovative olive-growing models: An environmental and economic assessment" Journal of Cleaner Production, 28, pp. 70-80.
- Eriksson, M., Strid, I., Hansson, P.-A. (2012) "Food losses in six Swedish retail stores: Wastage of fruit and vegetables in relation to quantities delivered" Resources, Conservation and Recycling, 68, pp. 14-20.
- FAO (2013) Food wastage footprint: impacts on natural resources. Summary Report;
- Fiore M., Contò F., Pellegrini G. (2015) "Reducing Food Losses: A (Dis)-Opportunity Cost Model" Revue Of Studies On Sustainability, 1: 151-166.
- International Olive Oil Council (2016) Statistics data, available at <http://www.internationaloliveoil.org/> (accessed on November 2016).
- Martucci O., Arcese G. (2010) "The Environmental Certification of agri food products: LCA of the extravergin oil", in Proceedings of the 7th International Conference on LCA in the Agri-food Sector, Bari, Italy, 22-24 September Università degli Studi di Bari Settore Editoriale, BARI, pp. 283-228.
- Romero-Gámez, M., Castro-Rodríguez, J., Suárez-Rey, E.M. (2017) "Optimization of olive growing practices in Spain from a life cycle assessment perspective" Journal of Cleaner Production, 149, pp. 25-37.
- Stefan, V., van Herpen, E., Tudoran, A. A., & Lähteenmäki, L. (2013) "Avoiding food waste by Romanian consumers: The importance of planning and shopping routines" Food Quality and Preference, 28(1), 375-381.
- Van Der Vorst, J., Beulens, A., Van Beek, P. (2005) "Innovations in logistics and ICT in food supply chain networks" Innovation in Agri-Food Systems: Product Quality and Consumer, pp. 245-290.

## SITOGRAPHY

[http://ec.europa.eu/food/safety/food\\_waste/index\\_en.htm](http://ec.europa.eu/food/safety/food_waste/index_en.htm)

## A MODEL ON ANTECEDENTS OF DIGITAL PIRACY BEHAVIOUR

Christofi, Anna-Maria<sup>1</sup>; Coudounaris, Dafnis N.<sup>2</sup>

<sup>1</sup>Leeds Business School, Leeds Beckett University, Leeds, UK

<sup>2</sup>School of Economics and Business Administration, University of Tartu, Tartu, Estonia

### ABSTRACT

Internet technologies have spurred various unethical consumer activities. A very common illegal activity is digital piracy. This article uses qualitative data from 10 semi-structured interviews, to explore attitudes towards digital piracy of young adults, as well as to investigate what characterises the factors that lead them to eventually engage in digital piracy behaviour. This study is based on a convenient sample. It reveals that different moral views and social influences form dissimilar attitudes towards digital piracy. These influences were moderated by factors such as legislation, safety risk, availability of copied material, package offered and convenience of internet users. The study exposes the powerful trend of illegal downloading and gives a clear picture of the way attitudes can be shaped.

*Keywords: Digital Piracy, Digital Piracy Behaviour, Moral View, Social Influence, Music and software industry, Consumer Behaviour*

## DEVELOPMENT OF SOCIAL ENTERPRISE: DISTRIBUTION OF PROFIT OR NON-DISTRIBUTION CONSTRAINT?

Cosentino, Antonietta<sup>1</sup>; Di Stefano, Cristina<sup>2</sup>; Magistro, Angela<sup>1</sup>

<sup>1</sup>Dept. of Business Administration, Sapienza University of Rome, DEAP, Rome, Italy

<sup>2</sup>Dept. of Industrial and Information Engineering and Economics, University of L'Aquila, DIIE, L'Aquila, Italy

### ABSTRACT

The relation between partial distribution of earnings and development of social enterprises is a topic that has been debated in a small number of studies over the years. The first aim of this paper is to analyze the potential impact that the partial removal of the non-distribution constraint foreseen by the Italian third sector reform could generate on the Italian social enterprises, especially in which ways it could affect the choices of the social enterprises on quality or efficiency of their production. The second purpose of the study is monitoring the effects on financial structure, ownership and governance of social enterprises that will be produced by the partial removing of non distribution constraint. We are going to look at the main economic and financial data of social enterprises before and after the approval of the reform, and qualitatively we are going to analyze their reaction to the reform. Finally we wish to verify if the social enterprise can become the most important model of no-profit commercial entrepreneurial.

Our theory is that the partial removal of the non-distribution constraint might trigger the interest of the investors in social enterprises, and might influence their choices regarding to the financing of contributing to their development, and supporting the growth of the entire third sector.

### THEORETICAL FRAMEWORK

The concept of social enterprise varies at a great extent in the international literature including a vast series of economic initiatives defined as social, and different legal forms. There is no single way to address the topic, and a unique definition of social enterprise cannot be identified.

Different authors tried to make a literature review on the topic analyzing the emergence of the idea in different contexts (Defourny and Nyssens, 2012; Kerlin, 2009), and identifying different schools of thought (Borzaga and Defourny, 2004; Anderson and Dees, 2006; Defourny and Nyssens, 2010; Hoogendoorn et al., 2010).

In the 1996, Salamon and Anheier conducted the first relevant survey on nonprofit sector comparing the nonprofit sector at international level.

EMES Network developed a conceptualization of social enterprise that may represent a framework grounded on different social, political and economic "traditions" (Defourny and Nissens, 2003).

Even if there is not an agreement between all the authors, Peredo and McLean have identified one common characteristic in all the definitions of the social enterprise: the "problem-solving nature" of social enterprise, that is its ability to produce social impacts (Peredo and McLean, 2006). Anderson and Dees (2006) also emphasized this concept, referring to a previous work of Young (1983); for the authors, indeed, the concept of social enterprise concerns more the outputs and the social impact produced than the incomes.

Defourny and Nyssens (2010), citing Young and Salamon (2002) specify that the notion of social enterprise in the European context is not strictly connected with the non-distribution constraint of profit, as it is in the Us context. In Europe, the final purpose of the activity carried out by the social enterprise and its governance are more important features to define a social enterprise. As in the literature there is not a single concept of social enterprise, therefore there is not a single concept of income. The latter is often misunderstood and considered as equivalent to return on equity, value created by the enterprise, and profit (Capaldo, 2013; Knight, 2012; Lee, 1994; Magistro, 2011; Marx, 1975; Schumpeter, 1934).

The legal forms adopted in the European countries are different; the first European law on this theme was adopted in Italy in 1991 (Law 381/1991 on Social Cooperation); then, a more general law focused on social enterprise was adopted in 2006 (Law 155/2006). The first law allows a limited distribution of income, whereas the second one forbids this distribution and introduces the non-distribution constraint. However, the third sector reform has recently removed the constraint for social enterprises (Law 106/2016).

## **PURPOSE OF THE WORK**

After having analyzed the literature on development conditions of non-profit organizations, we focus our work on the concept of profit that has been developed over the past centuries by economic and accounting theories to identify the possibility of distribution of profit as one of the most important conditions for the development of social enterprises.

For instance, Hansmann in his famous study "The role of Nonprofit Enterprise" notes that nonprofit organization can earn a profit, but the "nondistribution constraint", how he calls the prohibition on the distribution of profit (Hansmann, 1980: 838), is referred only to the "pure profits". According to Hansmann the pure profits are "earnings in excess of the amount needed to pay for services

rendered to the organization (...) and a nonprofit enterprise is free to pay reasonable compensation to anyone for labor or capital that he provides (Hansmann, 1980: 838).

The organization's legal commitment to devote the net earnings – in the meaning that we intend, as Hansmann's theory – to the production of services entails that the nonprofit producer is not encouraged to raise prices or cut quality of the production he makes.

On the other hand, "a system of regulation that discourages variable-return securities and investor control, and therefore makes it difficult to attract venture capital, is less of a liability" (Hansmann, 1980: 887).

We think it is true, and we follow the Hansmann's approach to answer the following research questions:

RQ1: Can the possibility to pay a reasonable earning to any person for labour or capital that he provides affect the choices of the social enterprises on quality or efficiency of their production?

RQ2: Which effects the partial removing of non distribution constraint can produce on financial structure, ownership and governance of social enterprises?

RQ3: Can social enterprise became the most important model of no-profit commercial entrepreneurial?

To supply our research queries, we have been measuring the effects of the recent third sector reform on social enterprises especially on their ownership and financial structure. Our analysis started at the end of 2016, and it has focused on financial statements of Italian social enterprises that are not social cooperatives. Our goal is measuring the impact of the recent reform on social enterprises looking at their main economic and financial data before and after the approval of the reform. To accomplish our goal, we are observing data adjustments that will occur during the next three years, since the entry into force of the implementing decrees of Law 106/2016.

Our aim is to demonstrate if and how the recent reform can contribute to the growth of social enterprises, especially if it can orient their production, market, financing and governance choices.

We focus on two items: the first one is the potential impact that the partial removal of the "non-distribution constraint" foreseen by the reform could generate on the size of equity if, as we think, a lot of social investors will be interested in underwrite additional capital in social enterprises.

The second one is monitoring the development of equity and if it can support the growth of social enterprise especially on capital-intensive sector, as public utilities.

We reckon that the removal of the non-distribution constraint might trigger the interest of additional investors in social enterprises, and that the entire third sector might receive greater support for its development.

To support and complete our analysis, we have been analyzing the reaction of the social enterprises to the reform to identify how they think the limited income distribution possibility will affect their future decisions. To accomplish this goal, we are conducting a qualitative analysis by administering surveys to the social enterprises of the different clusters.

## RESEARCH METHOD

We divided the entire population of Italian social enterprises – that are not social cooperatives – into classes, on the basis of two parameters: earnings and business sector. The aim of the clustering is to identify the groups of social enterprises on which the profit distribution possibility could have a greater potential impact. According to us, may be the social enterprises that have earnings higher than 3%.

Going a step further, we simultaneously clustered data units and variables (Anderberg, 2014). We obtained a restricted cluster composed by social enterprises operating in three sectors. Using the Ateco classification, we identified Education, Sanitary Care, Residential Social Services as the most interesting sectors for our research. In fact, our analysis showed that the enterprises operating in these sectors have obtained the highest earning. Furthermore, we have analyzed some measurements – as ROE, liabilities, labour cost, assets, net assets, leverage – of the social enterprises in the sample. All the data of the social enterprises have been acquired from the database Aida Bureau van Dijk; there are 338 units in the database. To divide the social enterprises population into clusters we used the Partitional Clustering method (Anderberg, 2014; Rand, 1971; Rokach and Maimon, 2005).

In order to evaluate the reaction of the social enterprises to the reform, we are carrying out a qualitative impact analysis (Tracy, 2012; Ritchie and Spencer, 2002) through the administration of semi-structured questionnaires to a sample of social enterprises of each cluster. To select the sample, we used a simple random sampling technique (Cochran, 2007) in each cluster, in order to minimize the risk of bias in selection. We picked up three clusters of 10-12 social enterprises for each, and more than forty questions to submit to the social enterprises managers. We are conducting individual in-depth interviews with them. For instance, we are asking if they think that the partial removing of the no-distribution constraint could damage the social mission of the firm, or which consequences may have the partial distribution of earnings, or if they will distribute the earnings, and if so, which consequence they will expect.



## ORIGINALITY/VALUE

Whereas twenty years ago the concept of social enterprise was rarely discussed, currently it is attracting increasing interest all over the world. Most studies are focused on the notion of social enterprise, his development, variety of legal form adopted, public policies, concept and dimensions of third sector, or in general, third sector performance measurement (Kerlin, 2009; Defoury and Nyssens, 2012, Bagnoli and Megali, 2011; Monzon and Chaves, 2008, Nyssens, 2006) .

On this regard, our study may contribute to the literature, considering the small number of studies on the specific subject (relationship between partial distribution of earnings and development of social enterprises). On one hand, it deepens on the relation among earning and funding, describing the potential impact of the reform on the possibility of the social enterprises to attract a larger number of equity investors, even institutional ones.

On the other hand, it shows to the investors the potentiality of the impact investing. They have been little interested in financing social enterprises so far; now, we reckon that the removal of the non-distribution constraint might trigger the interest of the investors in social enterprises, and that the entire third sector might receive greater support for its development.

## CONCLUSIONS

At this stage, we answered just one research query.

RQ 1: our empirical research shows that the social cooperatives have higher earnings than social enterprises. They have same mission and similar structure – except corporate ownership – operate in the same market, produce same services, but before the recent reform only social cooperatives could share net earnings. Our theory is that the distribution of net earnings influences choices regarding to the financing of production without this necessarily means that quality of production and efficiency of enterprise have to be reduced.

About RQ number 2 and 3, our research is ongoing.

*Keywords: social enterprise; income; profit; non-distribution constraint; Italian third sector reform; development of social enterprise.*

## REFERENCES

Anderberg, M.R. (2014), Cluster analysis for applications: probability and mathematical statistics: a series of monographs and textbooks (Vol. 19), Academic press.

- Bagnoli, L., & Megali, C. (2011). Measuring performance in social enterprises. *Nonprofit and Voluntary Sector Quarterly*, 40(1), 149-165.
- Borzaga, C. and Defourny, J. (2004), *The emergence of social enterprise* (Vol. 4), Psychology Press.
- Capaldo, P. (2013), *Reddito e capitale nell'economia dell'impresa*, Giuffrè Editore.
- Cochran, W. G. (2007), *Sampling techniques*, John Wiley & Sons.
- Dees, J.G. and Anderson, B.B. (2006), "Framing a theory of social entrepreneurship: Building on two schools of practice and thought", *Research on social entrepreneurship: Understanding and contributing to an emerging field*, Vol.1 No.3, pp. 39-66.
- Defourny, J. and Nyssens, M. (2010), "Conceptions of social enterprise and social entrepreneurship in Europe and the United States: Convergences and divergences", *Journal of social entrepreneurship*, Vol. 1 No.1, pp. 32-53.
- Defourny, J., and Nyssens, M. (2012), "The EMES Approach of Social Enterprises in a Comparative Perspective", working papers series no. 12/03, EMES European Research Network, Liege.
- Hansmann, H. B. (1980), *The role of nonprofit enterprise*, *The Yale law journal*, 89(5), 835-901.
- Hoogendoorn, B., Pennings, E. and Thurik, R. (2010), "What do we know about social entrepreneurship: An analysis of empirical research", report series ERS-2009-044-ORG, Erasmus Research Institute of Management (ERIM), Rotterdam.
- Kerlin, J. A. (Ed.). (2009), *Social enterprise: A global comparison*, Tufts University Press.
- Knight, F. H. (2012), *Risk, uncertainty and profit*, Dover Corporation, Inc.
- Lee, T. and Lee, T. A. (1996), *Income and value measurement*, International Thomson Business Press.
- Magistro A. (2011), *Profitto. Prove di dialogo tra economisti e aziendalisti*, Giappichelli Ed.
- Marx, K. (1975), *Il Capitale, Libro II e III*, Einaudi Ed.
- Monzon, J. L., & Chaves, R. (2008). The European social economy: concept and dimensions of the third sector. *Annals of Public and Cooperative Economics*, 79(3-4), 549-577.
- Nyssens, M. (2006). *Social enterprise. At the crossroads of market, public policies and*.
- Peredo, A. M. and McLean, M. (2006), "Social entrepreneurship: A critical review of the concept", *Journal of world business*, Vol. 41 No. 1, pp. 56-65.
- Rand, W. M. (1971), "Objective criteria for the evaluation of clustering methods", *Journal of the American Statistical association*, Vol. 66 No. 336, pp. 846-850.
- Ritchie, J. and Spencer, L. (2002), "Qualitative data analysis for applied policy research", *The qualitative researcher's companion*, Vol. 573(2002), pp. 305-329.
- Rokach, L. and Maimon, O. (2005), "Clustering methods", in Maimon, O. and Rokach, L. (Ed), *Data mining and knowledge discovery handbook* Springer US, pp. 321-352.
- Salamon, L. M., & Anheier, H. K. (1996). *The international classification of nonprofit organizations: ICNPO-Revision 1, 1996*. Johns Hopkins University Institute for Policy Studies.
- Schumpeter, J. A. (1934), *The theory of economic development: An inquiry into profit, capital, credit, interest, and the business cycle*, Vol. 55, Transaction publishers.
- Tracy, S. J. (2012), *Qualitative research methods: Collecting evidence, crafting analysis, communicating impact*, John Wiley & Sons.
- Young, D. R. and Salamon, L. M. (2002), "Commercialization, social ventures, and for-profit competition", in Salomon L. M. (Ed.) *The state of nonprofit America*, Brooking Institution Press, pp. 423-446.
- Young, D. R. (2013), *If not for profit, for what?*, (1983 Print Edition), Lexington Books.

# **A NEW PERSPECTIVE IN BUSINESS EVALUATION: MEASURING SOCIAL IMPACT VALUE. A CASE STUDY ON ITALIAN WORK INTEGRATION COOPERATIVES**

**Cosentino, Antonietta<sup>1</sup>; Bongiovanni, Laura<sup>2</sup>; Cesari, Alberto<sup>2</sup>; Di Stefano, Cristina<sup>3</sup>**

<sup>1</sup>Dept. of Business Administration, Sapienza University of Rome, DEAP, Rome, Italy.

<sup>2</sup>Isnet Association, Bologna, Italy.

<sup>3</sup>Dept. of Industrial and Information Engineering and Economics, University of L'Aquila, DIIE, L'Aquila, Italy.

## **ABSTRACT**

Social impact measurement, as well as the motivations that induce private entities to monitor their own social impact, are widely debated topics by scholars and practitioners. In this study, we focus on evaluation and social impact measurement among non profit organizations, specifically Italian work integrations cooperatives. We can demonstrate that the cooperatives obtain a net social value higher than Euro invested in the activities. We think that awareness about dimension of social value made can contribute to learn and promote the social cooperatives' purpose and improve their learning and self reflection on internal decision making process. In fact, to be useful, the measurement has not to comply rules, but to come from proactively behaviour to improve results and (social)performance.

In this sense, the social valuation process can be extended to every enterprise, not only social or non profit organizations, founding a business assessment system based also on the measurement of social impact generated by the enterprises, and not only on financial performance.

## **THEORETICAL FRAMEWORK**

Social impact measurement, as well as the motivations that induce private entities to monitor their own social impact, are widely debated topics by scholars and practitioners (Bengo et al. 2014). The goal of social impact measurement is usually twofold: to provide stakeholders – mainly funders – with information, and to use the results as an instrument to monitor and improve performance. Social impact is a multilevel and multidimensional concept (Nicholls et al. 2015). In order to measure it, different quantitative and qualitative methods (Hall 2012; Grieco et al. 2014) can be used, some of which are borrowed from profit-oriented business evaluation models (Gibbon e Dey 2011).

## **PURPOSE OF THE WORK**

The main purpose of our study is to measure the social impact generated by the Italian work integration cooperatives. We believe that resources invested by different stakeholders (public

administration, social cooperatives, disadvantaged groups, families, communities) produce a social value that is higher than inputs, irrespective of the effects generated by other employment inclusion policies.

A further aim of the present study, is to propose guidelines to policy makers and operators – specially social entrepreneurs – in order to raise awareness of the importance of social evaluation and of the accountability process.

Last but not least, another purpose of our research is contribute to extend a business assessment system based also on the measurement of social impact generated by the enterprises.

Future implications of this work are to address next researches on this topic in order to find out new variables other than traditional ones.

## **RESEARCH METHOD**

The analysis is carried out on the basis of the so-called “Theory of Change” (Drucker 1993; Dees 1998). We use the GECES guidelines, Sub-group on Impact Measurement – European Commission (GECES 2015), as borrowed by EVPa (Hendeberg 2012), and the SROI model – Social Return on Investment – (Social Impact Investment Task Force 2014) that uses both quantitative and qualitative analysis based on in-depth interviews.

The survey focuses on a sample of 144 work integration cooperatives. These cooperatives are part of the social enterprise panel surveyed by the Isnet Observatory on the Social Enterprise, and they represent the statistic reference population. The values obtained from the sample analysis are subject to a statistical inference on the whole universe of social cooperatives, type A and A + B, to obtain the social impact assessment for 2016.

The proxy data analysis is completed on approximately 20 open data sources.

## **ORIGINALITY/VALUE**

This is the first study in Italy carries out through an aggregate analysis to measure social impact value achieved by Italian work integration cooperatives.

Many existing studies focus on the evaluation of single projects or specific experiences, and adopt a vision focused on occasional activities rather than systematic ones.

Primary data provide a broad basis for economic and employment development policies that engage public and private investors which support high-impact social activities.

## PRACTICAL IMPLICATIONS

We believe that the results of this study are a useful starting point for the development of a business assessment system based not only on the evaluation of economic performances, but also on the social impact generated by the enterprises. This new evaluation framework can lead to two different outcomes. On the one hand, it can guide policy interventions, on the other hand it can promote initiatives of socially responsible investors.

*Keywords: social impact value; measuring social impact value; work integration initiative; work integration cooperatives; socially responsible investor; business assessment system; corporate social responsibility.*

## REFERENCES

- Bengo I., Arena M., Azzone G., Calderini M. (2016), "Indicators and metrics for social business: a review of current approaches", *Journal of Social Entrepreneurship*, Vol. 7 No. 1, pp. 1-24.
- Dees J.G. (1998), "The Meaning of 'Social Entrepreneurship'", Kauffman Foundation, available at: <http://www.redalmarza.cl/ing/pdf/TheMeaningofsocialEntrepreneurship.pdf> (accessed 10/04/2017).
- Drucker P.F. (1994), *Post-Capitalist Society*, Harper Business, New York.
- European Commission (2003), "EVALSED The resource for the evaluation of Socio-Economic Development. Evaluation guide", September 2013, Bruxelles, available at: [http://ec.europa.eu/regional\\_policy/sources/docgener/evaluation/guide/guide\\_evalsed.pdf](http://ec.europa.eu/regional_policy/sources/docgener/evaluation/guide/guide_evalsed.pdf) (accessed 20/04/2017).
- Gibbon, J. and Dey, C. (2011), "Developments in social impact measurement in the third sector: Scaling up or dumbing down?", *Social and Environmental Accountability Journal*, Vol. 31 No. 1, pp. 63-72.
- Grieco C., Micheline L., Iasevoli G. (2014), "Measuring Value Creation in Social Enterprises. A Cluster Analysis of Social Impact Assessment Models", *Nonprofit and Voluntary Sector Quarterly*, Vol. 44 No. 6, pp. 1173-1193.
- Hall, M. (2014), "Evaluation logics in the third sector", *VOLUNTAS: International Journal of Voluntary and Nonprofit Organizations*, Vol. 25 No.4, pp. 307-336.
- Hehenberger L. (2013), "Measuring & Managing Social Impact", paper presented at GECES Sub-group on Social Impact Measurement, March 1st, 2013, available at: [http://ec.europa.eu/internal\\_market/social\\_business/docs/expert\\_group/social\\_impact/presentation-hehenberger\\_en.pdf](http://ec.europa.eu/internal_market/social_business/docs/expert_group/social_impact/presentation-hehenberger_en.pdf) (accessed 15/03/2017).
- Mulgan G. (2010), "Measuring Social Value", *Stanford Social Innovation Review*, Vol.8 No.3, pp. 38-43.
- Nicholls A., Nicholls J., Paton R. (2015), "Measuring Social Impact", in Nicholls A., Emerson J., Paton R.(Ed.), *Social Finance*, Oxford University Press, Oxford.
- OECD (2015), "Policy Brief on Social Impact Measurement for Social Enterprises. Policies for Social Entrepreneurship", OECD / European Commission, Luxembourg, available at: <http://bookshop.europa.eu/en/policy-brief-on-social-impact-measurement-for-social-enterprises-pbKE0415192/> (accessed 10/03/2017).
- Social Impact Investment Task Force (2014), "Measuring impact. Subject paper of the Impact Measurement Working Group", September 2014, Bruxelles, available at: <http://www.socialimpactinvestment.org/reports/Measuring%20Impact%20WG%20paper%20FINAL.pdf> (accessed 03/04/2017).
- Zappalà G., Lyons M. (2009), "Recent approaches to measuring social impact in the Third sector: An overview", *CSI Background Paper No. 6*, Centre for Social Impact, Sidney, available at: [http://www.socialauditnetwork.org.uk/files/8913/2938/6375/CSI\\_Background\\_Paper\\_No\\_5\\_-\\_Approaches\\_to\\_measuring\\_social\\_impact\\_-\\_150210.pdf](http://www.socialauditnetwork.org.uk/files/8913/2938/6375/CSI_Background_Paper_No_5_-_Approaches_to_measuring_social_impact_-_150210.pdf) (accessed 07/02/2017).

## ANTECEDENTS OF BRAND EQUITY OF NORDIC UNIVERSITIES AND MODERATING EFFECTS

Coudounaris, Dafnis N.<sup>1</sup>; Kvasova, Olga<sup>2</sup>

<sup>1</sup>School of Economics and Business Administration, University of Tartu, Tartu, Estonia

<sup>2</sup>UCLan Cyprus, Larnaca, Cyprus

### ABSTRACT

The purpose of this study is to investigate the antecedent factors of brand equity used in another study by Dennis et al. (2016). The current study is based on four universities located in Estonia and Finland, i.e. the University of Tartu, Vaasa University, JAMK University of Applied Sciences and Aalto University. Furthermore, this study investigates the moderating effects of university innovative philosophy, industry innovation adoption and content of mission statement between brand attachment strength and commitment, trust and satisfaction. The research methodology is based on 172 surveys collected through an on-line questionnaire placed on the platform connect.ee, and students, members of staff and administrative employees were asked to complete this questionnaire. The findings of the study reveal that all relationships between antecedent factors i.e. internal reputation, brand image, brand meaning, brand identity, brand attachment strength, commitment, trust, and satisfaction with brand equity are positive and significant. In addition, three moderators play an important role in the model, namely the moderating effects of university innovative philosophy, industry innovation adoption and content of mission statement on the relationship between brand attachment strength and commitment in relation to brand equity. Finally, the study discusses the managerial implications and limitations of the study and future research directions.

*Keywords: Brand equity of universities, antecedent factors, moderating effects, university innovative philosophy/industry innovation adoption/content of mission statement*

## IS PUBLIC SUPPORT A BAD FOR THE DISSEMINATION OF CROWDFUNDING AMONG INNOVATIVE START UP FIRMS?

Cucari, Nicola; Ghi, Alessandra; Orlando, Beatrice; Renzi, Antonio

Dept. Management, Sapienza, Rome, Italy

### ABSTRACT

The role of government in innovation and technological development is really significant. A large literature evaluates the effect of state and local government programs in promoting innovation (Georghiou and Roessner, 2000; Klette *et al.*, 2000; Roper *et al.*, 2004). According to Hall (2008), start up firms need to be financed and venture capital financing is only a partial solution to this problem. Venture capital cannot provide a complete solution to the financing needs of new technology companies, especially in the early stages because it's focused only on certain industries and it can only be offered in amounts that are too large for many start ups and only works in developed IPO markets. As a result, a market failure exists, which demands government intervention. There are different reasons that allow a startup to use new financing methods, such as crowdfunding (CF). CF is an emerging and interesting fundraising practice for both companies and individual entrepreneurs. CF is a *"method for funding a variety of new ventures, allowing individual founders of for-profit, cultural, or social projects to request funding from many individuals, often in return for future products or equity"* (Mollick, 2014, p. 1). There is a significant difference between crowdfunding platforms and other forms of financing; the former has three specificities that may not be found together anywhere else (Giudici *et al.*, 2012): i) the presence of an enabling organization with which those seeking capital (initiators) and those in possession of capital (supporters) are affiliated; ii) direct interaction between entrepreneurs and investors; iii) emergence of social groups among investors and entrepreneurs. Researches, for example, agreed that entrepreneurs prefer those sources of finance that involve giving up less control and require lower servicing costs (Vanacker and Manigart, 2010). This would explain why entrepreneurs are likely to have a first preference for personal financial resources (Bruton *et al.*, 2015).

### SCOPE AND RESEARCH QUESTION

The crowdfunding literature focusing on the capital-seeking party is predominantly concerned with the motivations for crowdfunding and the determinants of success (Moritz and Block, 2014), also if *"funding success is a multifaceted concept"* (Ahlers *et al.*, 2015). Apparently, it seems to emerge a critical gap for what concern the financing of startup firms and the crowdfunding model. Therefore, we adopt a reverse logic: instead of questioning what factors drive the diffusion of crowdfunding among startup firms, we have decided to use the original standpoint of investigating if territorial specific

characteristics have a negative influence on the adoption of crowdfunding, and in particular if public assistance has a detrimental impact on the diffusion on new financing logics. To this regard, this study aims to answer the following research question: *“crowdfunding and public policy are alternative or converging instruments?”*

## LITERATURE REVIEW

With regard to the possible functions of crowdfunding, most publications can be divided into two broad categories: as a source of financial capital and, therefore, focused on its role as seed capital for start-up (for example Mollick, 2014; Schwienbacher and Larralde 2012, Ward and Ramachandran, 2010) or as a tool to support marketing activities and to test and validate the market potential of business ideas (Schwienbacher Lambert, 2010; Mollick, 2014; Belleflamme *et al.*, 2014; Hu *et al.*, 2015). Existing researches have identified a variety of factors that may directly or indirectly influence the funding success of a project. Researchers have found that some project properties and existence of images and video in project introduction are associated with funding success (Hekman and Brussee, 2013; Greenberg *et al.* 2013; Mollick, 2014). Others find that project properties, such as duration of the campaign and prestabilized funding goal, are associated with funding success. Others show that a project owner's social influence, proxied by the numbers of friends on social networks such as Facebook, has an impact on funding success (Mollick 2014). Furthermore, researches have found that there is a strong geographic component to the nature of projects, and funders are more likely to propose projects that reflect the cultural products of their geographic areas. In particular, geographical proximity to capital providers increase the likelihood of successful funding (Agrawal *et al.*, 2014). This shows a cross-cultural perspective of investors that suggests a geo-cultural segmentation of prospective users. In other words, cultural gaps seem to affect the willingness of interaction within the CF platforms. This gives a great importance to the social and cultural factor when investing in CF (Esposito De Falco *et al.*, 2015).

## RESEARCH DESIGN

Given the exploratory nature of the research, we use a *phenomenon-based research* which aim is to capture, describe and document, as well as conceptualise, a phenomenon (von Krogh *et al.*, 2012). As suggested by Doh 2015, the phenomenon-based research takes as a principal focus the ability to accurately and insightfully inform a real-world phenomenon. This methodology is strongly recommend in the entrepreneurship research (Wiklund *et al.*, 2011). Our exploration research is based on primary data on the phenomenon interviewing the managers of equity crowdfunding platforms and



public actors as well as the analysis of secondary data from Italian government and institutional reports (e.g. Italian Ministry of the Economic Development).

## RESULTS AND CONCLUSION

At a managerial level, we make an attempt to fill the literature gap for what concerns the relationship between crowdfunding and public support for high-tech start up firms. We argue that Regional characteristics deeply impact on factors such as: availability of financial resources; typology of financing source; entrepreneurial mindset toward financial source. In its turn, the capital structure, and, hence, the form of financing, influences innovative performances of start-ups (technological dominance, etc.). Moreover, equity crowdfunding seems poorly employed for venturing high-tech start-up over the preference for public commitment. In fact, especially when the technology is strategic for Regional-based reasons (e.g. is linked to infrastructure; it can foster Regional and social advancement, etc.), the main source of financing – or, at least, the most preferred one – is public funds. Our results open up to different research questions, as instance as: 1. What are the main cultural factors influencing the venture finance process? How are they linked to Regional characteristics? How they affect long run innovative performances in Regional clusters?

*Keywords: Crowdfunding, Start up firms, Public Support, Government Policy, Italian Context*

## REFERENCES

- Agrawal, A., Catalini, C., and Goldfarb, A. (2014). Some simple economics of crowdfunding. *Innovation Policy and the Economy*, 14(1), 63-97.
- Ahlers, G. K., Cumming, D., Günther, C., & Schweizer, D. (2015). Signaling in equity crowdfunding. *Entrepreneurship Theory and Practice*, 39(4), 955-980
- Belleflamme, P., Lambert, T. and Schwienbacher, A. (2014). Crowdfunding: Tapping the right crowd, *Journal of Business Venturing*, 29(5), 585-609
- Bruton, G., Khavul, S., Siegel, D., and Wright, M. (2015). New financial alternatives in seeding entrepreneurship: Microfinance, crowdfunding, and peer-to-peer innovations. *Entrepreneurship Theory and Practice*, 39(1), 9-26
- Doh, J. P. (2015). From the Editor: Why we need phenomenon-based research in international business. *Journal of World Business*, 4(50), 609-611
- Esposito De Falco, S., Vargas Sanchez A., and Cucari, N. "Social innovation practices: focus on success factors for crowdfunding," in Gummesson, E., Mele, C., Polese, F. (Eds.) (2015) ,*Service Dominant Logic, Network and Systems Theory and Service Science: Integrating three Perspectives for a New Service Agenda*", Proceedings of the "2015 Naples Forum on Service", Naples, Italy, Jun 2015)
- Georghiou, L., and Roessner, D. (2000). Evaluating technology programs: tools and methods. *Research policy*, 29(4), 657-678.
- Giudici, G., Nava, R., Rossi L. C., and Verecondo, C., (2012). "Crowdfunding: The New Frontier for Financing Entrepreneurship?" (October 5, 2012). Available at SSRN: <https://ssrn.com/abstract=2157429> or <http://dx.doi.org/10.2139/ssrn.2157429>
- Greenberg, M. D., Pardo, B., Hariharan, K., and Gerber, E. (2013, April). Crowdfunding support tools: predicting success & failure. In CHI'13 Extended Abstracts on Human Factors in Computing Systems (pp. 1815-1820). ACM.

- Hekman, E., and Brussee, R. (2013). "Crowdfunding and online social networks". 2nd Consortium on Applied Research and Professional Education. Manchester, UK. Utrecht, Netherlands: CARPE
- Hall B.H. (2008), *The Financing of Innovation*, on *Handbook of Technology and Innovation Management*. Scott Shane Case Western Reserve University ed. John Wiley & Sons Ltd, England. ISBN 978-1-4051-2791-2
- Hu, M., Li, X., and Shi, M. (2015). Product and pricing decisions in crowdfunding. *Marketing Science*, 34(3), 331-345.
- Italian Ministry of the Economic Development, General Directorate for Industrial Policy, Competitiveness and SMEs, *Synthesis of Policy in support of Innovative Start-ups*, February 4, 2016
- Klette, T. J., Møen, J., and Griliches, Z. (2000). Do subsidies to commercial R&D reduce market failures? Microeconomic evaluation studies. *Research Policy*, 29(4), 471-495
- Mollick, E. (2014). The dynamics of crowdfunding: An exploratory study. *Journal of business venturing*, 29(1), 1-16
- Moritz, A., and Block, J. (2014). Crowdfunding und Crowdinvesting: State of the Art der wirtschaftswissenschaftlichen Literatur. *ZfKE–Zeitschrift für KMU und Entrepreneurship*, 62(1), 57-89.
- Roper, S., Hewitt-Dundas, N., and Love, J. H. (2004). An ex ante evaluation framework for the regional benefits of publicly supported R&D projects. *Research policy*, 33(3), 487-509
- Schwienbacher A, and Larralde B. 2012. Crowdfunding of small entrepreneurial ventures. In Cummings D (ed.), *The Oxford Handbook of Entrepreneurial Finance*. Oxford University Press: Oxford; pp. 369–391
- Vanacker, T. R., and Manigart, S. (2010). Pecking order and debt capacity considerations for high-growth companies seeking financing. *Small Business Economics*, 35(1), 53-69.
- von Krogh, G., Rossi-Lamastra, C., and Haefliger, S. (2012). Phenomenon-based research in management and organisation science: When is it rigorous and does it matter?. *Long Range Planning*, 45(4), 277-298
- Ward, C., and Ramachandran, V. (2010, December). Crowdfunding the next hit: Microfunding online experience goods. In *Workshop on Computational Social Science and the Wisdom of Crowds at NIPS2010* (pp. 1-5).
- Wiklund, J., Davidsson, P., Audretsch, D. B., and Karlsson, C. (2011). The future of entrepreneurship research. *Entrepreneurship Theory and Practice*, 35(1), 1-9

## SHARING KNOWLEDGE TO INCREASE FOOD VALUE CHAIN: THE INTRODUCTION OF DSS BY SUPPLY CHAIN LEADER DRIVING FARMER'S MANAGERIAL CULTURAL CHANGE.

Cupertino, Sebastiano; Vitale, Gianluca; Riccaboni Angelo

Department of Business and Law, University of Siena, DISAG-UNISI, Siena, Italy.

### ABSTRACT

Main anthropic activities formally developed in terms of business processes, inevitably lead environmental and social consequences (IPCC, 2014). Therefore, managers, started to pay more attention to the overall corporate value created instead to the so limited profit maximization perspective (Elkington, 1994). In agri-food sector, in particular, strategic decisions making processes and yields goals have a direct and strong impact on soils, costs of production, GHGs emissions, water consumption (Miller, 2000), and human health. Moreover, these negative externalities are often combined also with: the current poor awareness of traditional farmers about environmental degradation (Merrilees 2005; Mccann 1997); a low level of advanced and sustainable business managerial capabilities (Phillipson et al. 2004); and the perception of farmers that sustainable practices could represent a costly measure, that can depress the farm economic performance, as not properly compensated by the markets (Menozzi et al. 2015). According to Hayman 2004 and Backus et al. 1997, this problems could be sometimes solved by the introduction of appropriate and valid support tools useful to drive farmers' decisions. To this end, we have analyzed the implementation of an appropriate Decision Support Systems (DSS) alongside a durum wheat supply chain. The trigger for the elaboration and implementation of a DSS comes from the firm leader of the supply chain analyzed. So, it is introduced the concept of "supply chain leader" (SCL) which, in our view, is a company nearer to final markets and bigger than the others, with major economical competence and skills, which has the task to implement an integrated supply chain management through the managing of the relationship with all suppliers in all phases of the supply chain (Defee, 2007). For a successful supply chain management, in fact, is required a cross-functional integration (Lambert and Cooper, 2000) while a strong co-operation along the supply chain represent an important guideline for sustainability actions and economic and environmental objectives to be achieved (Ilbery and Maye, 2005). Accordingly, SCL needs to increase trust and collaboration within the supply chain, activating a changing process characterized by sharing knowledge and skills useful to improve those managerial attitudes of both farmers and other partners positioned at many network levels. Generally, farmers are characterized by managerial weakness related to low entrepreneurial attitudes and skills (Pyysiäinen et al., 2006) which could produce a myopic business programming, measurement and control of the

socio-environmental impacts produced and the risks occurred. Considering these lacks, we found interesting analyzing how a SCL, which could be characterized by a typical sustainable business model, could lead a cultural managerial change at the farming level, through an unformalized capacity building process, based on the introduction of DSS with the aim to enhance the food value chain. This investigation pursues to analyze how the cultural change of farmers is driven by the knowledge created, shared and transferred by the SCL along the whole supply chain using a DSS tool. To this scope, we developed a case study identifying and analyzing those critical and virtuous issues of several steps of cooperation between typical chain actors, such as: a MED-Italian SCL in pasta production; a business innovative partner, such as ICT SME (external to the chain) and, ultimately, its suppliers, such as some Italian farmers. We first of all started to explain the cooperative virtuous cycle of transferring and sharing knowledge within chain partners defining our theoretical framework which reconsidered the Nonaka model (1990), shifting it from a single organization context (mono dimensional) to a three-dimensional perspective encompassing the whole network involved (see Figure 1).

**Fig. 1 – Re-adaptation of Nonaka Model (1990)**

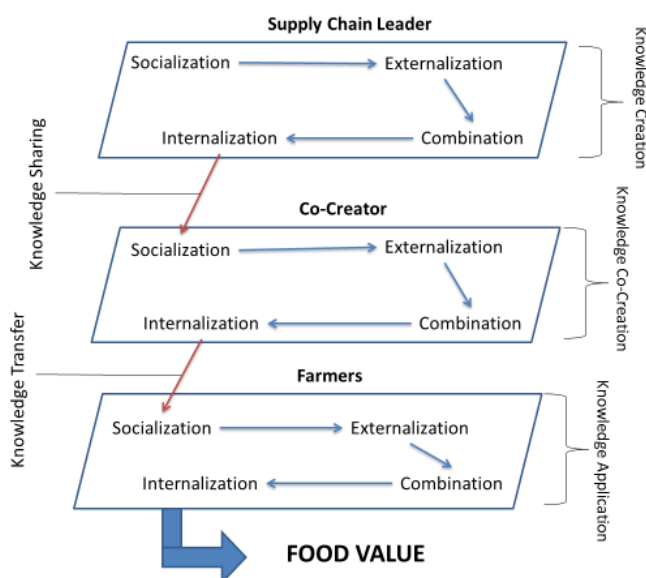

Secondly, adopting a qualitative analytical approach, we conducted interviews/surveys interacting with all chain actors in order to deeply investigate the mechanisms/issues which drive (or trap) the knowledge long and in supply chain, focusing on the potential and substantial role played by the introduction and use of a typical DSS tool. Finally, we found that a DSS could be defined both as an outcome of a knowledge creation process (given by a steady interaction between a SCL and its business partner) and as a useful managerial tool which supports the knowledge transfer from the SCL to its suppliers permitting to increase at the same time the level of sustainability for each chain members and of the overall food value chain.

*Keywords: Supply Chain Leader; Knowledge creation; Knowledge transfer; DSS; SECI model; Durum wheat supply chain.*

## REFERENCES

- Backus, G. B. C., Eidman, V. R., & Dijkhuizen, A. A. 1997. Farm decision making under risk and uncertainty. *NJAS wageningen journal of life sciences*, 45(2), 307-328.
- Defee, C.C., 2007. *Supply Chain Leadership*. PhD diss., University of Tennessee, 2007. [http://trace.tennessee.edu/utk\\_graddiss/148](http://trace.tennessee.edu/utk_graddiss/148)
- Elkington J., 1994. Towards the Sustainable Corporation: Win-Win-Win Business Strategies for Sustainable Development. *California Management Review*, Vol. 36 No. 2, Winter 1994; (pp. 90-100)
- Hayman, P. 2004. Decision support systems in Australian dryland farming: A promising past, a disappointing present and uncertain future. In *New directions for a diverse planet. Proceedings of the 4th International Crop Science Congress (Vol. 26)*.
- IPCC, 2014. *Fifth Assessment Report (AR5)*.
- Lambert, D.M., Cooper, M.C., 2000. Issues in supply chain management. *Industrial marketing management*, 29(1), 65-83.
- Mccann, E., Sullivan, S., Erickson, D., & De Young, R. 1997. Environmental awareness, economic orientation, and farming practices: a comparison of organic and conventional farmers. *Environmental management*, 21(5), 747-758.
- Menozzi D.; Fioravanti M.; Donati M. 2015. Farmer's motivation to adopt sustainable agricultural practices. *Bio-based and Applied Economics*, [S.l.], v. 4, n. 2, p. 125-147. ISSN 2280-6172.
- Merrilees, D., & Duncan, A. 2005. Review of attitudes and awareness in the agricultural industry to diffuse pollution issues. *Water Science and Technology*, 51(3-4), 373-381.
- Miller R.A., Richters (Firm) 2000: *Getting Started: Important Considerations for the Herb Farmer*. Otto Richter and Sons Limited.
- Nonaka, I., 1990. *Management of Knowledge Creation*. Tokyo: Nihon Keizai Shinbun-sha.
- Pyysiäinen, J., Anderson, A., McElwee, G., Vesala, K., 2006. Developing the entrepreneurial skills of farmers: some myths explored. *International Journal of Entrepreneurial Behavior & Research*, 12(1), 21-39.
- Phillipson, J., Gorton, M., Raley, M., & Moxey, A. (2004). Treating farms as firms? The evolution of farm business support from productionist to entrepreneurial models. *Environment and Planning C: Government and policy*, 22(1), 31-54.

## ENTREPRENEURSHIP AS A CONTEXTUAL PHENOMENA

Czarczynska, Anna<sup>1</sup>; Mosquera, José Luis Naya<sup>2</sup>

<sup>1</sup>Sustainable Development Center Kozminski University, Warsaw, Poland

<sup>2</sup>Área de Comercializa. e Investig. de Mercados, Dep. Análisis Económico y ADE, Facultad de Economía y Empresa, Universidad de A Coruña (UDC), Spain

### ABSTRACT

The paper is designed in the framework of contextual research, presenting a comprehensive approach to entrepreneurship competencies perform in the regional aspect. The main objective of the study is multicultural diagnosis of the level of competence conducive to adaptation of individuals functioning at the regional level, and to determine the overall pattern distinguished competence fundamental for entrepreneurship phenomena. Particular attention will be paid to the entrepreneurship competencies that create unique opportunities realising creativity and increasing the value of self-branding position. We are treated entrepreneurship in the context of evolutionary analysis, institutional analysis, and the time-geography. So perspective is different but complementary. Furthermore we use comparative analysis for different regions using sample groups from Spain and Poland to illustrate this phenomena in a different context.

We can observe growing importance of new ways to access critical resources like labour, influence, capital, assets or data. Value creation chain is also changing its pattern. Moving away from shareholders of profits to stakeholders of the company branding values is the moment of transition to niche-finders activity by including all stakeholders negotiation ability to the process of creating higher added value. A key element of transformation is a return to fundamental values such as trust, direct contact, or the natural environment is not detrimental to the character of goods and services consumed. Creativity is triggered by the values of the integrated unit activity in the area not only professional but also mental, emotional, physical, spiritual, cultural, social and environmental sustainability. The value in this approach is widely understood as an employer-stakeholder participation in sustainable growing of the region, far beyond the classic workers well-being. The implementation of the research output should primarily expand our knowledge of the important psychological and economic determinants that affect the functioning of entrepreneurs in particular regions.

*Keywords:* context, entrepreneurship, creativity, personal development, competencies, value creation

### INTRODUCTION

Global and national business theories and practice:  
bridging the past with the future

ISSN: 2547-8516  
ISBN: 978-9963-711-56-7

The paper describes new model of circular flow in economy as a consequence of new innovative business circulation. We can expect a few new elements in economy such as different organization, innovative performance, as well as different communication channels and ways of management. In this new economic model different assets determine the success of particular economic activity not necessary visible in accounting reports. Reputation, creativity and ability to exist in current social network become crucial values. Value creation competencies create unique opportunities to build new labour potential and cumulate assets thanks to the value creation. Uncountable measures like reputation and trust create real values in economy and allocate resources in much more efficient way. We have to "upgrade" existing meaning of economy as an exchange of goods and services in terms of money. Somehow we are coming back to the roots of economic exchange with enrichment of employees role and increasing the value added also better distributed across the society. In addition, the model shows the impact on collective intelligence performance and the speed of business development processes. New way of economic activity leverages the wisdom of crowds and change the way groups of people produce knowledge, generate ideas and make them actionable.

Recent E&Y study (E&Y, 2015) shows that creative industries, with 30 million jobs created worldwide, constitute an important driving force of the economic growth. In case of creativity sectors economic and non-monetary impact on regions, societies and entire nations, remains underestimated. The recent intensification of digitalization has influenced the way in which creativity put real impact of digitalization on different type of local creativity (E&Y, 2015).

## PERSONAL DEVELOPMENT

Entrepreneur cannot be ignorant in any area of life. This is a lifelong learning proficiency and art of getting more than we assumed. Skills important for Entrepreneurship we can observe during the Development Center experiments:

Hard	Soft
Analytical	Communication skills (conversation, presentation, entrepreneurship proficiency)
Product knowledge	Cultural awareness (diversity ability)
Communication channels	Creativity (out of the box thinking)
Ready for Innovation (R&D background)	'Small talk' ability (individual contact)
Strategic attitude	Self-esteem behaviour
Critical structure thinking (context understanding)	Ethics/Reputation – company branding awareness
Sustainability – consequence security	Personal Cohesion

Source: own observation based on Development Center Process

Some metrics in DC process are composed on the theory of planned behaviour. It incorporates three dimensions: 1. Desirability: whether participants perceive achieving their goals as desirable, 2. Feasibility: whether participants feel prepared of starting a negotiation process (they know what they

know, they know what they don't know) 3. Stability against pressure: whether participant would let their business environment, such as opponent or own organisation resistance, dissuade them from getting an agreement.

## **SELF-LEARNING SKILLS MAY AFFECT CREATIVITY POTENCIAL**

Entrepreneurship process has a power to build platform for cross-compliance organization culture as a management tool for companies struggling to make the transition from a production-based to a knowledge-based economy, in which value creation depends increasingly on ideas and innovation. Rising entrepreneurship potential profoundly influences attitudes and behaviours critical to high performance, it builds trust and releases ideas, so we can achieve even the most outstanding and difficult goals while gaining the empowered cooperation of people and companies affected.

The study describe the development model of the analysed competence and the determination of key competencies in the context of learning organisations transformed into teal organisations. Identification of core competencies would allow to design further research to support certain adaptive capacity of individuals and organizations, that subject the agility and creativity in the long term using the contextual approach. Individuals and organizations are engaged in collaboration that supports the development of emerging entrepreneurs. Expertise within and across organizations and the sector is recognized and leveraged, taking advantage of a professional environment that supports and enhances formal and informal learning. Strategic goals and outcomes regarding entrepreneurship development are identified and innovative plans to achieve those goals are developed and refined to reflect new circumstances and learnings.

## **REFERENCES**

- Ajzen, I. (1991). The theory of planned behavior. *Organizational Behavior and Human Decision Process*, 50(2), 179-211;
- Amabile, T. M. (1996). *Creativity in context*. Boulder, CO: Westview.
- Cohendet P., Grandadam D. and Simon L. (2010). *The Anatomy of a Creative City, Industry and Innovation*, Vol. 17, No. 1, pp. 91-111.
- Cohendet P., Grandadam, D. and Simon, L. (2011). *Rethinking Urban Creativity: Lessons from Barcelona and Montreal*. *City Culture and Society*, Vol. 2, no 3, p. 151-158.
- Cohendet, P. et Simon, L. (2015). Introduction to the special issue on creativity in innovation. *Technology Innovation Review*, vol. 5 n°7.
- Csikszentmihalyi, M. (1999). Implications of the systems perspective for the study of creativity. In R.J. Sternberg (Ed.), *Handbook of creativity* (pp. 313-335), New York: Cambridge University Press.
- Earnst & Young (2015). *Cultural Times: the first global map of cultural and creative industries*, retrieved from [http://www.ey.com/Publication/vwLUAssets/ey-cultural-times-2015/\\$FILE/ey-cultural-times-2015.pdf](http://www.ey.com/Publication/vwLUAssets/ey-cultural-times-2015/$FILE/ey-cultural-times-2015.pdf)
- Florida, R. (2002). *The Rise of the Creative Class* (New York: Basic Books).
- Krueger, N. F & Brazeal, D. V. (1994). Entrepreneurial potential and potential entrepreneurs. *Entrepreneurship Theory and Practice*, 18(3), 91-104.
- Laloux, F. (2014). *Reinventing organisations*. Nelson Parker



- Meusburger (2009). Milieus of Creativity: The Role of Places, Environments, and Spatial Contexts. In P. Meusburger, J. Funke and E. Wunder (Eds), *Milieus of Creativity. An Interdisciplinary Approach to Spatiality of Creativity*, pp. 97-153.
- Scott, A. J. (2006). Creative cities: conceptual issues and policy questions, *Journal of Urban Affairs*, 28(1), pp. 1–17.
- Sternberg, R. J. (2002). Smart people are not stupid, but they sure can be foolish: The imbalance theory of foolishness. In R. J. Sternberg (Ed.), *Why smart people can be so stupid* (pp. 232–242). New Haven: Yale University Press.
- Sternberg, R. J. (2003a). WICS: A model of entrepreneurship in organizations. *Academy of Management Learning & Education*, 2, 386–401.
- Sternberg, R. J. (2003b). *Wisdom, intelligence, and creativity synthesized*. New York: Cambridge University Press.
- Sternberg, R.E. and Lubart, R.I. (1999). The concept of creativity: Prospects and paradigms. In R.J. Sternberg (Ed.), *Handbook of creativity* (pp. 3-15), New York: Cambridge University Press.
- Yin RK (2003). *Applications of case study research (applied social research Methods)*. Series, 4th edn. Thousand Oaks: Sage Publications.

# THE PIVOTAL ROLE OF ORGANIZATIONAL LEARNING AS A LINK BETWEEN EXPORTER'S ORIENTATIONS AND CAPABILITIES AND BETWEEN INTERNATIONAL PERFORMANCES

Dahan, Gavriel <sup>1</sup>; Shoham, Aviv<sup>2</sup>

<sup>1</sup>School of Management, Western Galilee College, Acre, Israel

<sup>2</sup>Department of Business Administration, University of Haifa, Haifa, Israel

## ABSTRACT

Several organizational processes and characteristics have been used in the marketing literature to describe how firms should act and operate in order to identify and assimilate new knowledge. The process of identifying, assimilating, and applying useful new knowledge in organizations is an essential means by which firms adapt to changes in the competitive environment (Camisón and Forés, 2010). Following this recognition, we focused on organizational learning as a unique process that enables firms to reach a new external knowledge and consequently achieving competitive advantage. Accordingly, we developed an integrative model that contains market and innovation strategic orientations and their derived capabilities as antecedents for organizational learning's impact on firm international performance and behavioral outcomes.

## THE MODEL

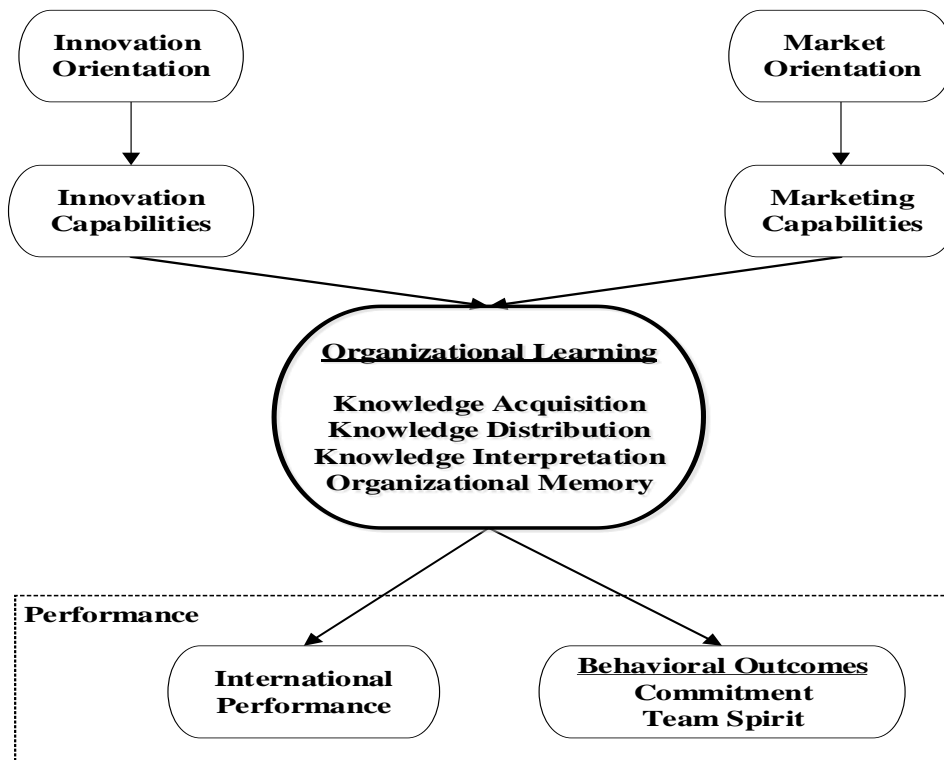

## ORIENTATIONS AND CAPABILITIES

*Orientations* refer to philosophical conceptions according to which organizations operate; *capabilities* represent a firm's accumulated knowledge and skills that enable it to enhance the value of its resources (Murray *et al.*, 2011). Prior studies have argued that firms should develop and use multiple orientations (Hakala, 2011) leading us to introduce strategic *market* and *innovation* orientations and their corresponding capabilities (*marketing* and *innovation* capabilities) as organizational learning's antecedents. Market and innovation orientations represent knowledge concepts. Marketing and innovation capabilities reflect the implementation of these orientations.

## ORGANIZATIONAL LEARNING

*Organizational learning* (OL) represents the development of knowledge within organizations in a manner that leads to behavioural change to improved performance (Crossan *et al.*, 1999; Fiol and Lyles, 1985). Following Jiménez-Jiménez and Sanz-Valle (2011), OL is conceptualized along four dimensions: knowledge acquisition, knowledge distribution, knowledge interpretation, and organizational memory. OL reflects the "capability within an organization to maintain or improve performance based on experience" (García-Morales, Jiménez-Barrionuevo, and Gutiérrez-Gutiérrez 2012, p. 1041).

## FIRM PERFORMANCE

Our model examines the impact of OL on two types of performance, namely *International Performance* and *Behavioral Outcomes*. Each of these reflects different level of consequences that derive from OL's implementation. Based on Zou, Taylor and Osland (1998), we conceptualized international performance as reflecting financial, strategic, and satisfaction components. Behavioral outcomes of firm performance reflect the degree to which individual members feel a sense of pride in belonging to an organization. Following Jaworski and Kohli (1993), we used *commitment* and *team spirit* as reflections of behavioral outcomes.

## ANALYSIS AND RESULTS

We tested our hypotheses using maximum likelihood estimation in a Structural Equation Modelling (SEM) via AMOS24 software. The results indicate a goodness of fit for the full substantive model with  $\chi^2 = 738.29$ ,  $DF = 285$ ,  $\chi^2/DF = 2.59$ ,  $p = .00$ ,  $IFI = .94$ ,  $CFI = .94$ ,  $TLI = .93$ ,  $SRMR = .08$  and  $RMSEA = .07$ . Substantively, the data showed that market and innovation orientations affected marketing and innovation capabilities, respectively. In turn, marketing and innovation capabilities enhanced OL.

Finally, OL improved international performance and enhanced employees' commitment and team spirit.

We conclude that managers should follow the dicta of both orientations and their derived capabilities. Further, firms should respond to competitive threats by managing organizational learning in order to enhance the performance.

*Keywords : Market Orientation, Innovation Orientation, Marketing Capabilities, Innovation Capabilities, Organizational Learning, International Performance, Commitment, Team Spirit.*

## REFERENCES

- Camisón, C. and Forés, B. (2010), "Knowledge Absorptive Capacity: New Insights for Its Conceptualization and Measurement", *Journal of Business Research*, Vol. 63, No. 7, pp. 707-715.
- Crossan, M. M., Lane, H. W. and White, R. E. (1999), "An Organizational Learning Framework: From Intuition to Institution", *Academy of Management Review*, Vol. 24, No. 3, pp. 522-537.
- Fiol, C. M. and Lyles, M. A. (1985), "Organizational Learning", *Academy of Management Review*, Vol. 10, No. 4, pp. 803-813.
- García-Morales, V. J., Jiménez-Barrionuevo, M. M. and Gutiérrez-Gutiérrez, L. (2012), "Transformational Leadership Influence on Organizational Performance through Organizational Learning and Innovation", *Journal of Business Research*, Vol. 65, No. 7, pp. 1040-1050.
- Hakala, H. (2011), "Strategic Orientations in Management Literature: Three Approaches to Understanding the Interaction between Market, Technology, Entrepreneurial and Learning Orientations", *International Journal of Management Reviews*, Vol. 13, No. 2, pp. 199-217.
- Jaworski, J. B. and Kohli, A. K. (1993), "Market Orientation: Antecedents and Consequences", *Journal of Marketing*, Vol. 57, No. 3, pp. 53-70.
- Jiménez-Jiménez, D. and Sanz-Valle, R. (2011), "Innovation, Organizational Learning, and Performance", *Journal of Business Research*, Vol. 64, No. 4, pp. 408-417.
- Murray, Y. J., Gao, G. Y. and Kotabe, M. (2011), "Market Orientation and Performance of Export Ventures: The Process through Marketing Capabilities and Competitive Advantages", *Journal of the Academy of Marketing Science*, Vol. 39, No. 2, pp. 252-269.
- Zou, S., Taylor, C. R. and Osland, G. E. (1998), "The EXPERF Scale: A Cross-National Generalized Export Performance Measure", *Journal of International Marketing*, Vol. 6, No. 3, pp. 37-58.

## THE IMPACT OF INTERNAL AND EXTERNAL ORGANIZATIONAL ORIENTATIONS ON FIRM PERFORMANCE

Dahan, Gavriel<sup>1</sup>; Shoham, Aviv<sup>2</sup>; Asseraf, Yoel<sup>3</sup>

<sup>1</sup>School of Management, Western Galilee College, Acre, Israel,

<sup>2</sup>Department of Business Administration, University of Haifa, Haifa, Israel,

<sup>3</sup>Department of Marketing, Ruppin Academic Center, Emeq Hefer, Israel,

### ABSTRACT

Organizational orientations refer to philosophical underpinnings of organizational operations. Several orientations have been used in marketing research; some are internal, represented here by a learning orientation while others are external, represented here by a market orientation. Prior studies have argued that firms should develop and use multiple orientations (Grinstein, 2008; Hakala, 2011). Likewise, Noble, Sinha and Kumar (2002) argued that no single strategic orientation is universal in the sense that it leads to superior performance in all situations.

The major aim of this study is to examine which orientation (internal or external) is a stronger precursor of firm performance. Accordingly, we developed a model that includes both market and learning orientations and examines their impact on firm performance.

### THE MODEL

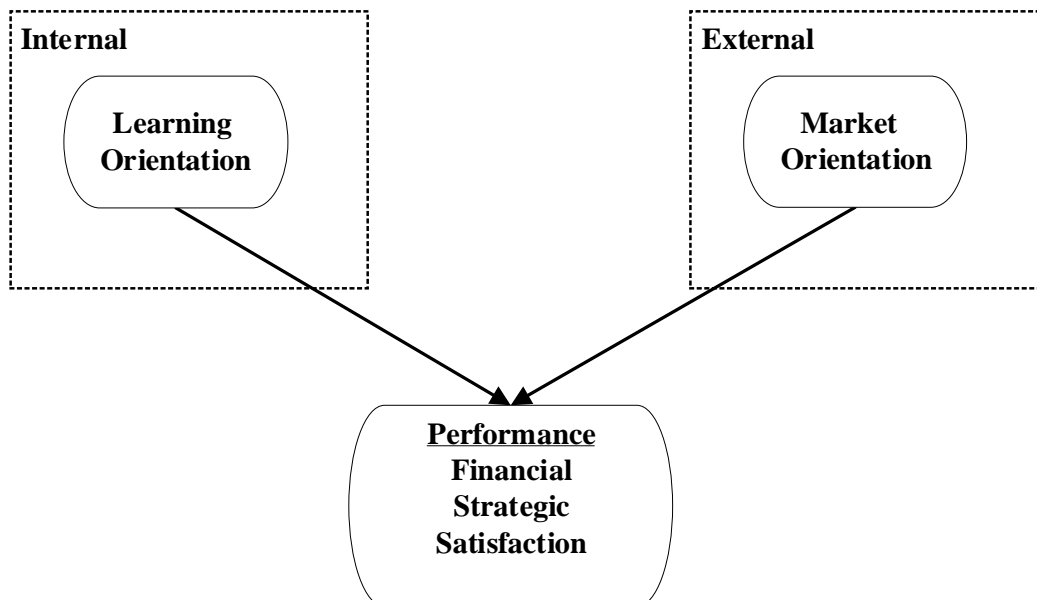

### LEARNING ORIENTATION

Global and national business theories and practice:  
bridging the past with the future

ISSN: 2547-8516  
ISBN: 978-9963-711-56-7

Learning orientation (**LO**) is an internal orientation, which focuses on the *Strengths* and *Weaknesses* components of a SWOT model. It implies that managers should focus internally in search of organizational directions and goals. One advantage of internal orientation is that managers and employees, who are intimately involved in a business, have valuable insights and experiences that can inform the optimization of organizational activities. Sinkula (1994) described LO as set of organizational values that influence the propensity of firms and its employees to create and use knowledge. Here, based on Hult, Ketchen and Arrfelt (2007), we conceptualized and operationalized LO as a uni-dimensional concept.

## **MARKET ORIENTATION**

Market orientation (**MO**) represents an external orientation, which focuses on the *Opportunities* and *Threats* components of a SWOT model. External orientations acknowledge the role of stakeholder groups (e.g., customers or competitors) that can potentially affect organizational performance. Two main conceptualizations have dominated the literature (Shoham, Rose and Kropp, 2005). The first approach follows Jaworski and Kohli (1993) in conceptualizing a market orientation as intelligence generation, intelligence dissemination, and market responsiveness. The second approach follows Narver and Slater (1990) in conceptualizing a market orientation as a combination of customer and competitor orientations and inter-functional coordination. Here, based on Pelham and Wilson (1996), we conceptualized MO as a uni-dimensional scale.

## **FIRM PERFORMANCE**

Following Zou, Taylor, and Osland (1998), performance was defined as three-dimensional with financial, strategic, and managerial satisfaction components. The financial dimension focuses on bottom-line outcomes such as sales and profits. The main thrust of strategic performance is that firms often have a set of strategic goals such as improved competitiveness, increased market share, and strengthened strategic position. The satisfaction dimension describes the extent to which the performance of the organization has met expectations. Subsequent analyses treated performance as a second-order construct.

## **ANALYSIS AND RESULTS**

The sample of this study based on 204 USA firms. Our regression model was significant ( $p < 0.01$ ) and explained 33.6% of the variance in overall performance. Both LO ( $\beta = 0.42, p < 0.01$ ) and MO ( $\beta = 0.19, p < 0.05$ ) were significant.

Substantively, the findings showed that both LO and MO affected firm performance. Notably, the impact of LO was much stronger than MO's. From a practical standpoint, top management should aspire to emphasize both orientations in the spirit of the arguments made by Grinstein (2008), Hakala (2011), and Noble, Sinha and Kumar (2002). However, to the extent that resources are limited, an internal focus based on organizational learning should lead to improved performance more than an external focus on outside stakeholders.

*Keywords : Market Orientation, Learning Orientation, Firm Performance.*

## REFERENCES

- Grinstein, A. (2008), "The Relationships between Market Orientation and Alternative Strategic Orientations: A Meta-Analysis," *European Journal of Marketing*, Vol. 42, No. 1/2, pp. 115-134.
- Hakala, H. (2011), "Strategic Orientations in Management Literature: Three Approaches to Understanding the Interaction between Market, Technology, Entrepreneurial and Learning Orientations", *International Journal of Management Reviews*, Vol. 13, No. 2, pp. 199-217.
- Jaworski, J. B. and Kohli, A. K. (1993), "Market Orientation: Antecedents and Consequences", *Journal of Marketing*, Vol. 57, No. 3, pp. 53-70.
- Hult, G. T. M., Ketchen D. J. Jr., and Arrfelt M. (2007), "Strategic Supply Chain Management: Improving Performance through A Culture of Competitiveness and Knowledge Development," *Strategic Management Journal*, Vol. 28, No. 10, pp. 1035-1052.
- Narver, J. C. and Slater S. F. (1990), "The Effect of a Market Orientation on Business Profitability," *Journal of Marketing*, Vol. 54, No. 4, pp. 20-35.
- Noble, H. C., Sinha R. K., and Kumar A. (2002), "Market Orientation and Alternative Strategic Orientations: A Longitudinal Assessment of Performance Implications," *Journal of Marketing*, Vol. 66, No. 4, pp. 25-39.
- Pelham, A. M. and Wilson D. T. (1996), "A Longitudinal Study of the Impact of Market Structure, Firm Structure, Strategy, and Market Orientation Culture on Dimensions of Small-Firm Performance," *Journal of the Academy of Marketing Science*, Vol. 24, No. 1, pp. 27-43.
- Shoham, A., Rose G. M., and Kropp F. (2005), "Market Orientation and Performance: A Meta-Analysis," *Marketing Intelligence and Planning*, Vol. 23, No. 5, pp. 435-454.
- Sinkula, J. M. (1994), "Market Information Processing and Organizational Learning," *Journal of Marketing*, Vol. 25, No. 1, pp. 35-45.
- Zou, S., Taylor, C. R. and Osland, G. E. (1998), "The EXPERF Scale: A Cross- National Generalized Export Performance Measure", *Journal of International Marketing*, Vol. 6, No. 3, pp. 37-58.

## ECONOMIC ANIMOSITY, NATIONALISM, AND COUNTRY IMAGE: "US VS. OTHERS" IN TIMES OF CRISIS

De Nisco, Alessandro<sup>1</sup>; Papadopoulos, Nicolas<sup>2</sup>; Napolitano, Maria Rosaria<sup>3</sup>; Mainolfi, Giada<sup>1</sup>

<sup>1</sup>Faculty of Economics, Università degli Studi Internazionali di Roma (UNINT), Rome, Italy

<sup>2</sup>Sprott School of Business, Carleton University, Ottawa, Canada

<sup>3</sup>Dipartimento DEMM, Università del Sannio, Benevento, Italy

### ABSTRACT

We live in difficult times. The current global environment is characterized by, among others, major financial crises, such as the global recession at the end of the previous decade and the more recent crisis of the Eurozone. Such developments have engendered tensions in Europe that in turn have affected the relationships between member states of the European Union (EU) and have led to a spread of "eurosceptic" sentiments. More specifically, over the past few years European countries along the Mediterranean including Greece, Italy, Cyprus, and Spain have experienced a surge of anti-German feelings in response to the restrictive economic and financial measures that Germany has imposed, or led the EU to impose, to stimulate recovery. According to numerous media reports, such measures were perceived in several EU members as intrusive and unfair, resulting in general political upheaval along with electoral gains for nationalist parties of the far-right or far-left (e.g., Lega Nord in Italy, Syriza in Greece) that leverage perceived strong anti-European views of the populace.

However, the effects of inter-country tensions are expressed not only in politics but also in cross-national business. The international marketing literature supports the notion that consumers' anger toward foreign countries which they perceive as hostile may affect their views toward products associated with them. Klein (2002) and her co-researchers introduced the concept of *consumer animosity* in 1998, defining it as "antipathy" arising from current or earlier economic or political/military events, and associated it to international buying behaviour, leading to a new research field that has been growing over the past two decades. Findings from this stream show consumers' lack of willingness to buy products from a country they perceive as hostile, but no substantive effect on their judgements of the quality of its products. This effect, which may appear paradoxical at first sight, reflects a key distinction between beliefs and feelings as antecedents of consumer intentions: one's intent to purchase (or not) products from an animosity target country, is driven more by the affective than the cognitive component of attitude. Studies have confirmed the impact of animosity on products in general as well as on specific product categories and on hybrid products (e.g., De Nisco et al., 2015).

Yet notwithstanding the growing interest in animosity, the field is still new and several gaps remain. In particular, research to date has focused more on political/military than economic animosity, and has dealt more with the interactions between country-specific animosity and generic



ethnocentrism than with other constructs that may be relevant (and perhaps even more so) to how animosity is understood. The objective of this study is to focus on *economic* animosity and explore its relationship not only with *ethnocentrism* but also with *nationalism* as determinants of consumer behaviour toward animosity target countries. The study is grounded on the notion that nationalism is particularly important in practice and research in both marketing and other fields, and may become even more so in the future. As noted by MacMillan (2014), most Europeans used to perceive themselves as part of the village or town where they lived, but, starting in the early 20<sup>th</sup> century, they "increasingly felt themselves to be German or French or British, part of something called a nation" (p. 11). This, then, was part of a new global phenomenon that has since had great (and often undesirable) consequences including, among others, the major cross-national conflicts that characterized the last one hundred years. In short, nationalism is generally thought to be a stronger affective reaction than ethnocentrism: the latter reflects in-group versus out-group *preferences* whereas the former actually leads to *disparaging* target out-groups (Druckman, 1994).

The study is motivated in part by wide-spread observations concerning the rise of nationalism within the EU, which seems to be one of the most visible consequences of disputes in the Eurozone. The study aims to provide an original contribution to the relevant fields by connecting three principal constructs: (1) *situational economic animosity*, which may result from a feeling among citizens of a nation that they are the subject of economic dominance or aggression by a hostile country arising from contemporary economic events; (2) *nationalism*, on which there is a relative dearth of research in the animosity field even though it has also been found to influence international buyer behaviour in general (Balabanis *et al.*, 2001); and (3) the well-established research stream of consumer views of various countries and their effects on intention to buy, which considers, among others, the distinction between *affective and cognitive consumer responses to country image* (Laroche *et al.*, 2005).

To address its objectives, the study posits a model that investigates three sets of relationships: first, the effect of *situational economic animosity* toward a foreign nation that is perceived as hostile on *ethnocentrism*, and of both of these constructs on *nationalism*; second, the direct and moderated effects of *animosity, ethnocentrism, and nationalism* on the *cognitive and affective* components of the *general country image* (GCI) and *product-country image* (PCI) of the animosity target country; and third, the direct and indirect impact of the preceding constructs, namely *animosity, ethnocentrism, nationalism, GCI, and PCI*, on the consumer's *behavioural intentions* toward products associated with the target country (product receptivity). The model was tested through a survey of 450 consumers in Greece, accessed through a professional online panel. They were asked to rate the image of Germany, the driver for a level of austerity that is widely perceived as deleterious to the wellbeing of their country. The scales for each of the constructs were drawn from well-established findings of earlier studies. The

structural model was tested with the maximum likelihood simultaneous estimation procedure and the main indices show that the data strongly fit the structural model.

The findings show a strong effect on most of the hypothesized paths, confirming the study's main thesis that economic animosity helps to raise ethnocentric feelings and, in turn, leads to nationalism, with all three of these constructs having a direct effect on the Greek consumers' receptivity toward purchasing German products. An exception was that animosity did not have an effect on product beliefs. This is in line with earlier studies, and in fact, strengthens the study's conclusions: as noted earlier, one may still "dislike" another country (affect) and not want to buy its products (intent), but may still feel the products are generally good (cognition) – a finding that buttresses the importance of measuring *nationalism* and its effects in the context of *situational* animosity. These findings help to advance our understanding of the interplay among the studied constructs, and, importantly, provide interesting and consequential insights that need to be taken into account by both researchers and practitioners especially in today's environment, given the potential effects of the resurgence of economic animosity and nationalism among European countries.

*Keywords: consumer animosity, nationalism, ethnocentrism, country image, country of origin effect, product-country image, Euro crisis*

## REFERENCES

- Balabanis, G., Diamantopoulos, A., Mueller, R. D. and Melewar, T. C. (2001). "The impact of nationalism, patriotism and internationalism on consumer ethnocentric tendencies". *Journal of International Business Studies*, Vol. 32, No. 1, pp. 157-175.
- De Nisco, A, Mainolfi, G., Marino, V. and Napolitano, M.R. (2015). "Effect of economic animosity on consumer ethnocentrism and product country images. A binational study on perception of Germany during the Euro crisis". *European Management Journal*, Vol. 34 No. 1, pp. 59-68.
- Druckman, Daniel (1994) "Nationalism, Patriotism, and Group Loyalty: A Social Psychological Perspective." *International Studies Quarterly*, 38(1), pp. 43-68.
- Klein, J. G. (2002). Us versus them, or us versus everyone? Delineating consumer aversion to foreign goods. *Journal of International Business Studies*, 33(2), 345-363.
- Laroche, M., Papadopoulos, N., Heslop, L. A. and Mourali, M. (2005). "The influence of country image structure on consumer evaluations of foreign products". *International Marketing Review*, Vol. 22, No. 1, pp. 96-115.
- MacMillan, M. (2014). *The war that ended peace: The road to 1914*. Penguin, Toronto.

# THE VALUE RELEVANCE OF CORPORATE SOCIAL RESPONSIBILITY IN THE EUROPEAN STOCK MARKETS: THE INFLUENCE OF STANDARD ETHICS RATING

Dicuonzo, Grazia; Ricciardi, Francesca; Dell'Atti, Vittorio

Department of Economics, Management and Business Law, University of Bari Aldo Moro, UNIBA, Bari, Italy

## ABSTRACT

Over the last years, the theme of corporate social responsibility (CSR) has continued to grow in importance and significance. This interest arises from the idea that firms engaging in socially responsible behaviour may gain competitive advantages, increasing their value. Although social reporting is not mandatory, investors are recognizing a great importance to environmental performance by choosing sustainable and responsible investments (Middleton, 2015). As a consequence, a great number of companies pays greater attention at sustainability themes, promoting a better relationship with stakeholders and ethical investments. To measure the level of social and environmental responsibility stakeholders often use ethical rating. Unlike the traditional credit rating, it is based on non-financial ratios.

The aim of this study is to investigate whether investors take into consideration the social and environmental performance, as proxied by Standard Ethics Rating, in making investment decisions. More specifically, we test whether the reputation for good sustainability is reflected in the market value. To test the hypothesis we follow the accounting based valuation model developed by Ohlson (1995). To define the level of sustainability performance we use the Standard Ethic Rating, which is published by the European sustainability agency "Standard Ethics". This rating "measures the level of adoption of international voluntary indications on corporate social responsibility and corporate governance, as well as the risk of corporate reputation". The empirical analysis is based on a sample of European companies listed on German, Italian, French, UK, Swiss and Belgian markets.

This study contributes to the extant literature in several ways. Firstly, we provide more evidence on the value relevance of reputation for sustainability, that is non-financial information. Secondly, we analyse the European context, differently from other works which examine the Dow Jones Sustainability Index in USA (Lourenco *et al.*, 2014; Lourenco *et al.* 2012). Thirdly, we assess the influence of Standard Ethics Rating, not yet investigated.

*Keywords: Value relevance, Corporate Social Responsibility, Rating, Standard Ethics, European context, Corporate Social Performance, Ohlson model, stock price.*

## **REFERENCES**

- Cheung, A. (2011). "Do stock investors value corporate sustainability? Evidence from an event study", *Journal of Business Ethics*, Vol. 99, pp. 145–165.
- Lourenco I. C., Branco M. C., Curto J. D., Eugénio T. (2012), "How Does the Market Value Corporate Sustainability Performance?", *Journal of Business Ethics*, Vol. 108, pp. 417-428.
- Lourenco I. C., Callen J. L., Branco M. C., Curto J. D. (2014), "The Value Relevance of Reputation for Sustainability Leadership", *Journal of Business Ethics*, Vol. 119, pp. 17-28.
- Middleton A. (2015), "Value relevance of firms' integral environmental performance: Evidence from Russia", *Journal of Accounting and Public Policy*, Vol. 34, pp. 204-211.

# PREDICTING THE PRESENT AND FUTURE OF AQUAPONICS WITH GOOGLE TRENDS

**Dos Santos, Maria José Palma Lampreia**

DINAMIA'CET—ISCTE—IUL, ESCS—IPL, Av. das Forças Armadas, Edifício, ISCTE, Lisboa, Portugal

## ABSTRACT

Aquaponics is an innovative scientific and professional area in Europe and across the world with increasing importance. However, despite the importance of aquaponics in Europe and in the world to promote safely and fresh foods, there is a gap because stakeholders, researchers and other professionals don't really know the actual development and increasing of importance this activity in Europe despite the enormous contribution of the Aquaponics Hub from COST FA 1305. To overcome this problem and to know about the status, trends and importance of aquaponics searching in Europe we conduct this work. The main goal is to analyse the aquaponics and aquaponics related terms search through Google trends tool across the European countries where the Aquaponics Hub from COST FA 1305 where present from 2014 to the present, in order to analyse the path of aquaponics and the contribute done by the Action COST FA 1305 and related research.

The methodology includes univariate and econometric models based on google trends from 2014 to the present.

The results high line confirms the increasing trends of aquaponics and aquaponics related terms across the Europe and European countries belongs to COST FA 1305, but there are significant differences among countries. In general, the results per country show a real increasing after the countries becoming member of the present action of the COST action or an increasing during the Action, but there are differences among countries country. As well the increasing of scientific papers indexed in SCOPUS or Web of Science was increasing.

## INTRODUCTION

Nowadays the increasing volumes of 'big data' reflecting various aspects of our present activities and represent a crucial new opportunity for scientists and experts to study the fundamental questions about the complex world we inhabit (Preis et al., 2013; Axtell, R. L. Zipf, 2001; King 2011; Vespignani, 2009; Perc, 2012; Petersen et al., 2012; Christakis et al., 2009).

On the other hand, research on innovative topics, whose technology is still in constant progress, development and improvement of efficiency on the use of inputs and the production of outputs like is the case of aquaponics in Europe, sometimes results in difficulties in obtaining data. These difficulties arise, or because there is no data available from private companies, or because either there are data

from other continents, or countries whose production systems do not allow comparability, or because the soil-climatic conditions, or technical-institutional-economic conditions (Goddek, et al. (2015; Dos Santos. 2016). Because they use different production techniques due to the difference in quality and quantity of inputs available *in loco*.

In today's world, information gathering often consists of searching online sources. Recently, the search engine Google tends has begun to provide access to aggregated information on the volume of queries for different search terms and how these volumes change over time, via the publicly available service Google Trends. In the present study, we investigate the intriguing possibility of analyzing search query data from Google Trends to provide new insights about the importance and the role of the Aquaponics Hub from COST FA 1305 in the growth and research of aquaponics and aquaponics related terms such as aquaculture and hydroponics in the world; Europe and European countries involved in this Action.

## LITERATURE REVIEW

According the Google trends search (2017) the world is paying increasing attention to aquaponics and aquaponics associated terms based on the figure 1 that presents the searching terms across the world. That date is based on google trends research between 2014 and 2016. Since the beginning of January 2004, Google has been collecting data on the number of search queries that it receives for various search terms. From these raw data, Google can then compile a weekly Google Trends query index for the number of searches completed for any particular search term (Hand, & Judge, (2012). Data provided by Google Trends are already normalized over each selected period and downloaded online in .csv format. The normalization process is reported as follows: "each data point is divided by the total searches of the geography and time range it represents, to compare relative popularity. The resulting numbers are then scaled to a range of 0 to 100" (Google Trends, 2016; Google Trends, 2017, Mavragani and Tsagarakis, 2016).

## METHODOLOGY

The methodology includes the Google Trends search from 2014-2016 at European; world and per country level search. After we use univariate analysis and econometric models namely an ARIMA model based on Choi and Varian (2009):

$$\ln y_t = \alpha_0 + \alpha_1 \ln y_{t-1} + \alpha_{12} \ln y_{t-12} + \beta x_t + u_t$$

## RESULTS AND DISCUSSION

Figure 1 presents the present and prevision of aquaponics across the world. The prevision of aquaponics and aquaponics related terms show an increasing trend in the future. Besides that, the searching of aquaponics at the present (from 2014-2016) presents more or less constant values at the world level. But at the same time in Europe aquaponics and aquaponics related terms presents an increasing trend (Fig. 2). This fact could not be separate from the importance and the ward scientific, professional and at politic level work developed by the Aquaponics Hub. These results were, as well, confirmed by the partial searching per country (in Annex 1) where the searching in aquaponics and aquaponics related terms show, in general an increasing in the Google trends search after the country becomes part of this Action, but the results vary depending the country.

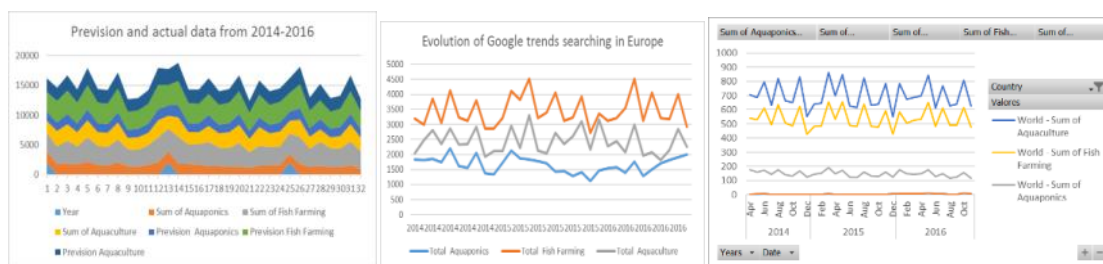

Fig.1 - World Google trends searching Fig 2 – Aquaponics searching in Europe Fig 3 – Aquaponics searching in World

*Keywords: ARIMA model; econometric model; google trends; aquaponics.*

## REFERENCES

- Axtell, R. L. Zip (2001). Distribution of US firm sizes. *Science*, 293, 1818–1820 (2001)
- Choi, H., & Varian, H. (2012), "Predicting the present with Google Trends". *Economic Record*, Vol.88(s1), pp. 2-9.
- Dos Santos, Maria José Palma Lampreia. (2016)."Smart cities and urban areas—Aquaponics as innovative urban agriculture." *Urban Forestry & Urban Greening* Vol. 20, pp. 402-406.
- Fehr, E. (2014). Behavioural science – "The economics of impatience". *Nature*, Vol. 415, pp. 269–272
- Goddek, S., Delaide, B., Mankasingh, U., Ragnarsdottir, K. V., Jijakli, H., & Thorarinsdottir, R. (2015). "Challenges of sustainable and commercial aquaponics". *Sustainability*, Vol. 7 No 4, pp. 4199-4224.
- Preis, T., Moat, H. S., & Stanley, H. E. (2013), "Quantifying trading behavior in financial markets using Google Trends". *Scientific reports*, Vol.3.
- King, G. Ensuring the Data-Rich Future of the Social Sciences (2011), *Science*, Vol. 331, pp. 719–721.
- Perc, M. (2012), Evolution of the most common English words and phrases over the centuries. *J. R. Soc. Interface* Vol. 9, pp. 3323–3328.
- Petersen, A.M., Tenenbaum, J. N., Havlin, S., Stanley, H. E. & Perc, M. (2012), "Languages cool as they expand: Allometric scaling and the decreasing need for new words". *Scientific Reports* Vol. 2, pp. 943.
- Christakis, N. A. & Fowler, J. H. *Connected* (2009), "The surprising power of our social networks and how they shape our lives", Little, Brown and Company.
- Vespignani, A. (2009), "Predicting the Behavior of Techno-Social Systems". *Science* Vol. 325, pp. 425–428.

## ANNEX 1 - AQUAPONICS AND AQUAPONICS ASSOCIATED AND RELATED TERMS IN DIFFERENT EUROPEAN COUNTRIES

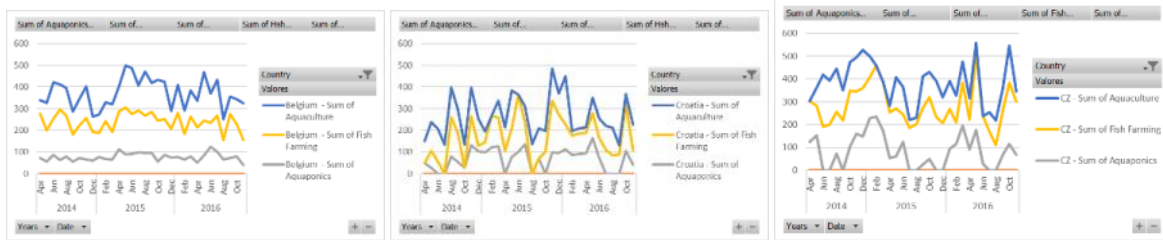

Fig.4 - Belgium Google trends searching Fig.5 - Croatia Google trends searching Fig.6 - CZ Google trends searching

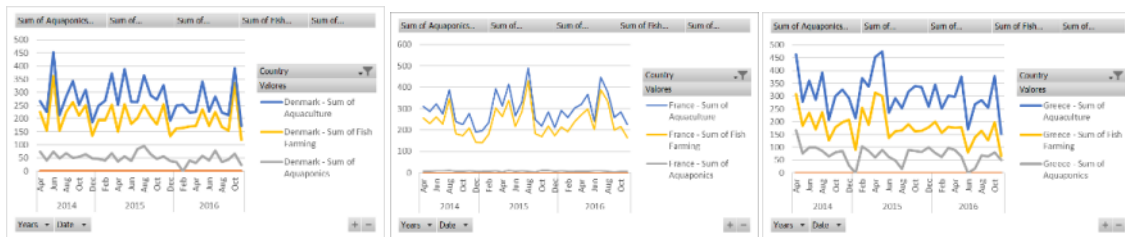

Fig.7 - Denmark Google trends searching Fig 8 - France Google trends searching Fig 9 - Greece Google trends searching

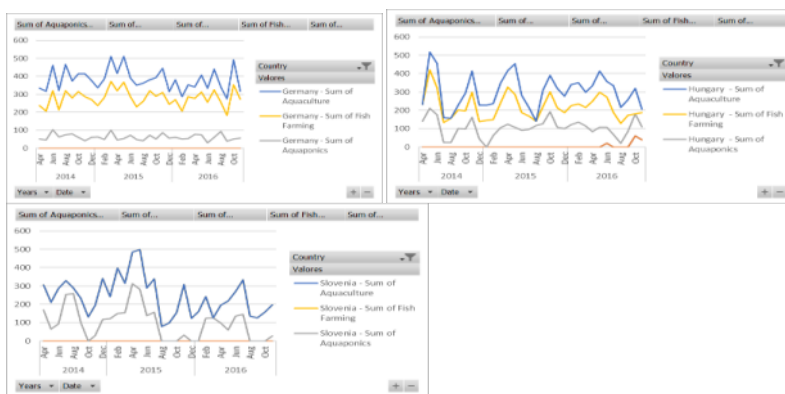

Fig 7 - Germany Google trends searching Fig 8 - Hungary Google trends searching Fig 9 – Slovenia Google trends searching

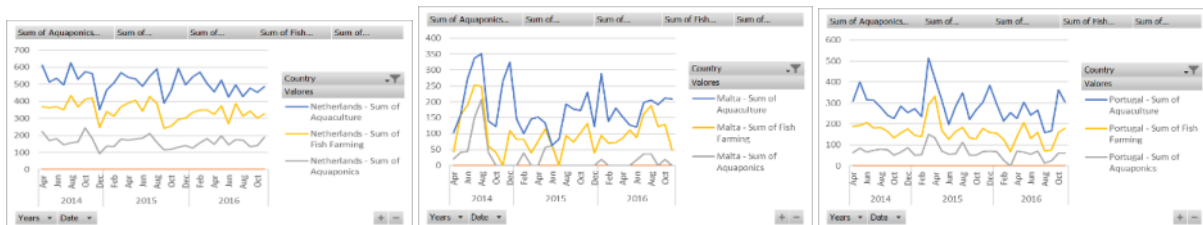

Fig 10 – Netherlands Google trends searching Fig 11– Malta Google trends searching Fig 12– Portugal Google trends searching



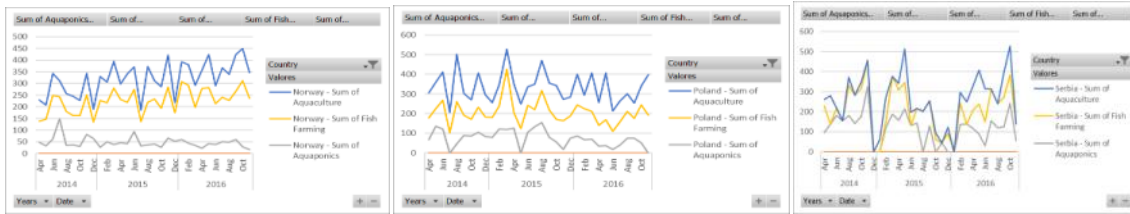
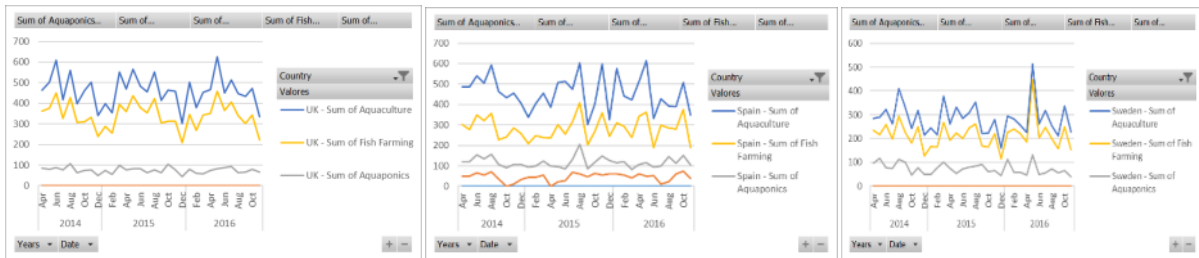

Fig 13–Norway Google trends searching Fig 14–Poland Google trends searching Fig 15 – Serbia Google trends searching



## COMMUNITY BASED BUSINESS MODEL PROPOSITION

**Drummond, Damon**

School of Management, Ritsumeikan Asia Pacific University

### ABSTRACT

This paper examines and proposes a new contemporary Community Based (CB) business model for sustainable community level competitive business. The paper shows how elements of this type of business model are both complex and divers compared to that for the enterprise firm. It also identifies significant CB determinants, such as, the quality and grade of clustering cooperation on the CB and how these significantly impact upon results. It applies this model and makes comparisons between Japan, Korea, Thailand and Indonesia.

One demonstrated limitation of the CB business model is making clear outcome scales, unlike the typical case, as CB models have both profitability and public interest as their goals which are not always compatible with each other.

Finally the paper reviews the CBs model for its applicability to sustainable value creation, stakeholders relationships and governance. The aim is to be able to apply this model to wide spectrum of CB business for future understanding and analysis.

*Keywords: Community Business, East and South East Asia Comparisons, Agrarian Rural Economic Lifestyles*

# EFFECT OF CULTURAL INTELLIGENCE AND PROFESSIONAL COMMITMENT ON WELL-BEING OF EXPATRIATES AND HOST COUNTRY NATIONALS

**Duyar, Veli Deniz; Erkuş, Ahmet**

Faculty of Economics, Administrative and Social Sciences, Bahçeşehir University, İstanbul, Turkey

## **ABSTRACT**

This research investigates the reasons of employee well-being of expatriates and host country nationals who are working at the same project teams on Information Technology field. Cultural intelligence of expatriates are generally used in international HRM to analyze its effect on the adaptation process, but there is no earlier study about its relationship with well-being of both expatriates and host country nationals working in the same environment. Employee well-being is measured on three levels (Life well-being, Work well-being, Psychological well-being). Not only the work bell-being but also life and psychological aspects of well-being is measured in order to see all types of influences on employees who are working with people from different cultures.

“Even with a low score of Cultural Intelligence, can Professional Commitment make employees satisfied about their inter-cultural assignments and still keep them happy?” was another question of the research, thus professional commitment of participants are also measured.

The research was made with 152 expatriates and 183 host country nationals in Turkey. Research questionnaires were English for expatriates and Turkish for host country employees. Questionnaires were distributed after one to one explanation of the research to each of the respondents who had mainly engineering background. The present study contributes to the cultural intelligence theory and has practical usefulness on international project assignments.

*Keywords: Cultural Intelligence, Professional Commitment, Employee Well-being, Expatriates, Host Country Nationals*

## “DELIBERATED INTUITION” IN STOCK PRICE FORECASTING

Endress, Tobias; Gear, Tony

University of Gloucestershire, Cheltenham, UK

### ABSTRACT

Group decision-making and stock price predictions are topics that are interesting for academic research as well as for business purposes. A myriad of studies have already been conducted to assess the quality of forecasts by financial analysts (Aiolfi, Rodriguez, & Timmermann, 2009; Bolliger, 2004; Clement, 1999; Fleischer, 2005; Roger, Roger, & Schatt, 2015; Stanzel, 2007), but in general these studies still show little evidence that it is possible to generate accurate predictions that in the long run create, after transaction costs, profits higher than the market average (Malkiel, 2007; Stanzel, 2007). This research project investigates group decision-making as an alternative approach to traditional financial analysis, based on Internet group decision-making, and follows the suggestion that a group decision is better than the decision of an individual (Page, 2008; Sunstein, 2008; Surowiecki, 2005). This approach can be seen as a variation of a group decision-making process as suggested by Kaplan (2001). The overall aim of the study is to explore, analyse and compare the quality of equity predictions of individuals and groups who are using the Internet in order to build theory of process. The research project follows a mixed-methods approach (Creswell, 2009; Johnson & Onwuegbuzie, 2004) in the form of a sequential study with a field experiment. Different groups—consisting of lay people, but also financial professionals—were formed purposefully in different group designs to generate equity forecasts. The field experiment was conducted following an e-Delphi approach with online questionnaires, and in-depth interviews with all participants. Data from financial analysts was used to compare the predictions from the groups with actual results of share prices (Endress, 2015).

The data from the experiment suggests that there are different variables, in terms of the individual characteristics of the participants, which indicated a significant impact on the quality of equity predictions. The predictions of some participants (e.g. “PID-S-plus” rated participants) are apparently of significantly higher accuracy (Endress & Gear, 2015). The findings from the study indicate that intuition plays a significant role in the decision-making process not only for lay people, but also for financial analysts and other financial professionals. However, there are observable differences in the intuitive decision-making of lay people and experts. While it was possible to observe that intuition is interpreted as “random guess” by poor predictors, it was found that good predictors base their intuition on several factors—even including fundamental and macroeconomic considerations. The findings of the experiments led to an explanatory model which we introduce as ‘Deliberated Intuition’ (Endress, 2017). The model of deliberated intuition which is proposed here views prediction as a

process of practice which will be different for each individual. The model proposes that a predictor will decide, consciously or semi-consciously, when they feel ready to rely on gut-feeling, or to undertake more analysis. Generally, it appears to contribute to a good prediction to think about the problem in different ways and with various techniques. The model may help to improve group settings and prediction quality. Apparently a combination of rational and intuitive techniques leads to better prediction quality.

*Keywords: Forecasting, decision-making, equity predictions, financial economics, intuition, online-groups, stock-trading*

## REFERENCES

- Aiolfi, M., Rodriguez, M., & Timmermann, A. (2009). Understanding Analysts' Earnings Expectations: Biases, Nonlinearities, and Predictability. *Journal of Financial Econometrics*, 8(3), 305–334. <https://doi.org/10.1093/jfinec/nbp024>
- Bolliger, G. (2004). The characteristics of individual analysts' forecasts in Europe. *Journal of Banking & Finance*, 28(9), 2283–2309.
- Clement, M. (1999). Analyst forecast accuracy: Do ability, resources, and portfolio complexity matter? *Journal of Accounting and Economics*, 27(3), 285–303. [https://doi.org/10.1016/S0165-4101\(99\)00013-0](https://doi.org/10.1016/S0165-4101(99)00013-0)
- Creswell, J. (2009). *Research design : Qualitative, quantitative, and mixed method approaches* (3th ed.). Thousand Oaks: SAGE Publications.
- Endress, T. (2017, March 28). *Quality of Stock Price Predictions in Online Communities – Groups or Individuals?* (Doctoral dissertation). University of Gloucestershire, Cheltenham.
- Endress, T. (2015). An e-Delphi Experiment of Quality of Equity Predictions in Online Groups. *Qualitative Research in Financial Markets*, Vol. 7 Iss. 2 pp. 136 - 158. Permanent link to this document: <http://dx.doi.org/10.1108/QRFM-05-2014-0014>
- Endress, T., & Gear, T. (2015). Stock Prices: Are Intuitive or Deliberate Persons Better Forecasters? *ECONOMICS & SOCIOLOGY*, 8(4), 43–50. <https://doi.org/10.14254/2071-789X.2015/8-4/3>
- Fleischer, J. (2005). *Die Performance von Analystenempfehlungen [The performance of analyst recommendations]* (1. Aufl.). Wiesbaden: Gabler.
- Johnson, R. B., & Onwuegbuzie, A. J. (2004). Mixed methods research: A research paradigm whose time has come. *Educational Researcher*, 33(7), 14–26.
- Kaplan, C. A. (2001). Collective intelligence: A new approach to stock price forecasting. In *IEEE INTERNATIONAL CONFERENCE ON SYSTEMS MAN AND CYBERNETICS* (Vol. 5, pp. 2893–2898).
- Malkiel, B. (2007). *A random walk down Wall Street : The time-tested strategy for successful investing* ([9th ed.]). New York: W.W. Norton.
- Page, S. E. (2008). *The difference : How the power of diversity creates better groups, firms, schools, and societies*. Princeton; Woodstock: Princeton University Press.
- Roger, P., Roger, T., & Schatt, A. (2015). Behavioral Biases in Number Processing: The Case of Analysts' Target Prices. *SSRN Electronic Journal*. <https://doi.org/10.2139/ssrn.2669451>
- Stanzel, M. (2007). *Qualität des Aktienresearch von Finanzanalysten : Eine theoretische und empirische Untersuchung der Gewinnprognosen und Aktienempfehlungen am deutschen Kapitalmarkt [Quality of equity research of financial analysts: A theoretical and empirical investigation of earnings forecasts and stock recommendations on the German capital market]* (1. Ed.). Wiesbaden: Dt. Univ.-Verl.
- Sunstein, C. (2008). *Infotopia : How many minds produce knowledge*. New York; Oxford: Oxford University Press.
- Surowiecki, J. (2005). *The wisdom of crowds* (1st Anchor books ed.). New York: Anchor Books.

# **THE IMPACT OF STUDYING IN A SOCIOECONOMICALLY DIFFERENT SOCIETY COMPARED TO THE HOME COUNTRY ON WORK RELATED VALUES: EVIDENCE FROM CYPRIOT WORKERS WHO WERE EDUCATED IN THE UK**

**Epaminonda, Epaminondas**

Management and MIS Department, University of Nicosia, Nicosia, Cyprus

## **ABSTRACT**

### **BACKGROUND**

This paper analyses the impact of education in a country that differs in key socioeconomic indicators compared to the home country on work related values. Studying this topic is considered theoretically interesting and important for two main reasons. First, because even though there are many studies that focus on the impact of the socioeconomic environment of a society on the importance of job characteristics, there seems to be a lack of studies on the values of workers who studied abroad in a socioeconomically different country compared to their home country and then returned home to work. Second, the above scenario is very common in the world today and results could potentially be generalised to several cases.

### **METHODS**

To achieve the objectives above, first, work related values of Cypriots who studied for more than four years in the UK were compared with respective values of Cypriots who did not study abroad through a values questionnaire and, second, interviews with Cypriots who studied in the UK focused on processes of value change during their time abroad. The number of correctly completed questionnaires of locally trained employees were 110 and those who were educated in the UK 100. Fifteen (15) interviews were conducted. Cyprus and the UK are considered ideal cases to be used for the question at hand because they differ on key sociocultural factors that influence work related values, i.e. national wealth, individualism, power distance, uncertainty avoidance. The differences in all four of these factors (national wealth and individualism higher in the UK, power distance and uncertainty avoidance lower) were likely to make intrinsic job characteristics, e.g. challenge, recognition and autonomy more important in workers who were educated abroad.

### **RESULTS**

Questionnaire results suggest that intrinsic job characteristics seem to be more important for workers who studied abroad while extrinsic job characteristics get higher scores in the group of locally trained employees in most of the items included in the questionnaire. More specifically, the importance attached by foreign trained employees to intrinsic items 'challenging job', 'training opportunities', 'the freedom to adopt own approach to the job' and the 'extent to which skills and abilities are being used' is higher than the importance given by locally trained employees. On the other hand, locally trained employees give more importance to extrinsic items 'security', 'pay' and 'fringe benefits' compared to foreign trained employees.

Analysis of interview results suggests that work related values of workers who spent time studying abroad have been influenced by a variety of factors, including foreign students' and tutors' attitudes and behaviour; foreign society's general attitude; and the education system abroad. Workers who studied abroad mentioned for example foreign students' job choices, comments, and attitudes toward educational work as factors that might have influenced their values. The processes that seemed to have been taking place were dissonance and internal and external accountability. Accountability refers to the need to justify one's thoughts and actions to significant others, and accountability pressures can be both external and internal. External pressures arise when the environment influences towards behaving in a particular way whereas internal changes occur when some modes of behaviour have been adopted by the individual and considered preferable compared to others. Being accountable to audiences with different values is expected to lead to dissonance, and by repeatedly resolving conflicts between diverse values, individuals move through the process of changing their values.

## CONCLUSIONS

This paper attempted to answer the question of whether there are differences in work related values between Cypriot workers who were educated in the UK and Cypriots who were not educated abroad, and analyse the process behind any observed changes in workers who were educated abroad. Results suggest, first, that there are differences in the values of these two groups of employees. Secondly, the process of change in the workers who studied abroad seems to involve primarily resolving conflicting values due to dissonance because of internal and external accountability. These findings add to the knowledge of the impact of education in a socioeconomically different society on work related values and may be relevant for organizations today that employ workers with diverse experiences in different socioeconomic contexts.

*Keywords: Work related values, change, culture, education, Cyprus, UK*

## INTERRELATIONS BETWEEN PERCEIVED ATTRIBUTES AND THEIR INFLUENCE ON PREFERENCE OF USER INTERFACES

Eytam, Eleanor

Industrial Engineering and Management, Sami Shamoon College of Engineering, Ashdod, Israel

### ABSTRACT

User interfaces (UI) are evaluated by potential users in order to conclude the quality of systems, and how well these systems are expected to support task completion. While traditional models emphasized the instrumental qualities such as usability and usefulness, contemporary models accentuate hedonic aspects of the UIs (e.g., Islam and Bouwman, 2016; Mahlke *et al.*, 2007). Hedonic needs are quality aspects that go beyond the instrumental value of a system. While instrumental attributes are aimed at fulfilling pragmatic needs, hedonic attributes emphasize the users' psychological well-being. In line with this approach, models depicting the system evaluation process include conceptually distinct aspects of UI evaluation: instrumentality, aesthetics, and symbolism (Rafaeli and Vilnai-Yavetz, 2004). Instrumentality refers to the usability and functionality of the system. Aesthetics refer to the sensual experience elicited by the visual design (Tractinsky, 2013). Finally, symbolism refers to the meanings and associations that are evoked by the system (e.g., Mahlke *et al.*, 2007; Tractinsky and Zmiri, 2006). While this paper agrees that all three aspects are theoretically distinct, it argues that perceived aesthetics and perceived symbolism may converge. In previous research these attributes were reported to be highly correlated. Mahlke *et al.* (2007) report a correlation of .54 while Tractinsky and Zmiri (2006) report a correlation of .72 between these attributes. Eco (2004) explains that in some periods in history these two concepts were considered synonymous. Unraveling the interrelations between these perceived attributes may help find remedies for data problems that may arise from their convergence, and help include both attributes in preference models.

In a series of five studies, a total of three hundred undergraduate students rated popular web pages, general control panels of information systems, and control panels of household appliances. Items measuring usability, functionality, aesthetics, and symbolism were generated based on a literature review (Rafaeli and Vilnai-Yavetz, 2004; Tractinsky and Zmiri, 2006) and assessed for reliability and validity. Separate exploratory factor analyses with maximum likelihood analysis extraction (eigenvalue > 1) method, and oblique rotation (direct oblimin with Kaiser Normalization) were applied to the responses. When eigenvalue was greater than 1, items were loaded on three distinct factors: usability, functionality, and a factor of aesthetics-symbolism. Imposing four factors did not indicate more than three clear factors. Items of both aesthetics and symbolism were loaded together on one factor. These results were replicated across five consecutive studies that tested attribute judgments to different



stimuli analyzed. When these factors were included in a regression model where preference was the dependent variable, both usability and aesthetic-symbolism factors were salient predictors of preference variance across all studies, regardless of the stimuli presented.

The paper concludes that although aesthetics and symbolism are defined in the literature as conceptually distinct (Rafaeli and Vilnai-Yavetz, 2004), when participants rated these attributes, they perceived them as similar. Thus, while usability and functionality items were loaded on two distinct factors, all aesthetics and symbolism items were loaded together on one factor. This strong association between aesthetics and symbolism is reported in other fields of research. Dion *et al.* (1972) reported that what is beautiful is good. Eagly *et al.* (1991) demonstrated that physically attractive people were judged as more intelligent. The implications of these findings are that people do not only associate between beauty and goodness, but rather they perceive beauty and goodness similarly. The managerial implications should therefore be, that a meticulous design of a product is crucial in order to make potential users appreciate its quality.

*Keywords: user interface, instrumentality, aesthetics, symbolism, preference model, multicollinearity*

## REFERENCES

- Dion, K., Berscheid, E. and Walster, E. (1972), "What is beautiful is good", *Journal of Personality and Social Psychology*, Vol. 24, pp. 285–290.
- Eagly, A. H., Ashmore, R. D., Makhijani, M. G. and Longo, L. C. (1991), "What is beautiful is good: a meta-analytic review of research on the physical attractiveness stereotype", *Psychological Bulletin*, Vol. 110, pp. 109–128.
- Eco, U. (2004), *On Beauty*, Secker and Warburg, London, UK.
- Islam, M. N. and Bouwman, H. (2016), "Towards user-intuitive web interface sign design and evaluation: A semiotic framework", *International Journal of Human-Computer Studies*, Vol. 86, pp. 121–137.
- Mahlke, S., Lemke, I. and Thüring, M. (2007), "The diversity of non-instrumental qualities in human-technology interaction", *mmi interaktiv*, Vol. 13, pp. 55–64.
- Rafaeli, A. and Vilnai-Yavetz, I. (2004), "Emotion as a connection of physical artefacts and organizations", *Organization Science*, Vol. 15(6), pp. 671–686.
- Tractinsky, N. (2013), "Visual Aesthetics", in Soegaard, M. and Dam, R. F. (Eds.), *The Encyclopedia of Human-Computer Interaction*. Aarhus, Denmark: The Interaction Design Foundation, available at: [http://www.interaction-design.org/encyclopedia/visual\\_aesthetics.html](http://www.interaction-design.org/encyclopedia/visual_aesthetics.html) (accessed 10 February 2017).
- Tractinsky, N. and Zmiri, D. (2006), "Exploring attributes of skins as potential antecedents of emotion in HCI", in Fishwick, P. A. (Ed.), *Aesthetic Computing*, MIT Press, Cambridge, MA, pp. 405–422.

# STUDENTS' PERCEPTIONS ON SMART CITY INITIATIVES: EVIDENCES FROM ITALY AND RUSSIA

Ferraris, Alberto<sup>1</sup>; Belyaeva, Zhanna<sup>2</sup>

<sup>1</sup>Department of Management, University of Torino and Laboratory for International and Regional Economics, Graduate School of Economics and Management, Ural Federal University.

<sup>2</sup>Graduate School of Economics and Management, Ural Federal University

## ABSTRACT

## INTRODUCTION

Smart cities are nowadays recognized as important “locus” of innovation. Many heterogeneous and different stakeholders such as firms (SMEs and MNEs), local governments, Universities and research centers co-develop “smart” innovations that aim at increasing citizens’ life quality. In this context, students have a major role to play in smart cities as part of the citizens of today and, mostly, of the society of the future (Vanolo, 2016). Their role can be instrumental in addressing societal issues and challenges in the implementation of smart city projects as because they are part of the citizens that represent the stakeholder to which every smart city projects should look as end user (Espejo and Mendiweso Bendek, 2011). However, very little is known about how citizens (and in particular students) perceive, and how they might respond to the opportunities that smart city technologies offer. This paper reports the results from a survey (n=200, pilot survey at this time) that took place in Italy and Russia. The University of Turin (Italy) was represented by the School of Management and Economics while the Ural Federal University (Russia) was represented by the Graduate School of Economics and Management. This contributes to the literature by providing a better understanding of the perceptions and behaviour of actual and future “smart” citizens about the possible deployment of smart city initiatives.

## BACKGROUND & RESEARCH OBJECTIVES

The planet has gone through a process of rapid urbanization over the past decades and nowadays more than 50 per cent of the world’s population is urban. Over the coming decades, the level of urbanization is expected to increase in all regions, with Africa and Asia urbanizing faster than the rest. Furthermore UN (2014) predicts that the world’s population living in urban areas will reach 66 percent by 2050. In this context, the search for more efficient organization of the city, and of its services, has led local and national governments, and supranational organisms to approach the management of cities in a more “smart” way (Scuotto et al., 2016). For example, the European Union

recognizes that the concept of smart city means smarter urban transport networks, upgraded water supply and waste disposal facilities, and more efficient ways to light and heat buildings (Caragliu et al., 2011). And it also encompasses a more interactive and responsive city administration, safer public spaces and meeting the needs of an ageing population<sup>1</sup>.

The spread of smart city's technologies and solutions looks like socio-technical transitions, since it requires the development of areas in which the collaboration between the various actors (such as governments, businesses and citizens) is facilitated (Ferraris and Santoro, 2014), in order to test and refine solutions aimed at scalability (Sandulli et al., 2016). The niche experimentation is crucial to promote the socio-technical change and the introduction of new technologies in society.

This experimentation require the participation of the stakeholders that will ultimately benefits from this new "smart" services, i.e. the citizens (Caragliu et al., 2011; Belyaeva, 2016). In this context, students (and theirs perceptions) have a major role to play in smart cities as part of the citizens of today and, mostly, in the society of the future. Despite the perceptions of the students are deeply analyzed and taken into consideration in other related fields, such as on the University social responsibility. This is the research gap that we would to fill up with this research.

So, the main aim at this study is to understand the perceptions of students of two different big Universities situated in Italy and Russia regarding the Smart Cities emerging phenomenon. This allow us to propose fresh insights in this emerging and relevant new stream of research from a new perspective of analysis. This paper may also help in building and aligning new curricula within Universities in order to better address the phenomenon of Smart Cities (Grimaldi and Fernandex, 2016). At the same time, some policy implications along with future line of research will be proposed based on the evidences of this survey.

*Keywords: Students' perceptions, Smart city, University involvement, Citizens involvement*

## REFERENCES

- Belyaeva, Z. (2016). Entrepreneurial Innovation and Stakeholder Relationship Management. In *Entrepreneurial Challenges in the 21st Century* (pp. 120-132). Palgrave Macmillan UK.
- Caragliu, A., Del Bo, C., Nijkamp, P. (2011), "Smart cities in Europe", *Journal of Urban Technology*, Vol. 18, No. 2, pp. 65-82.
- Carvalho, L. (2014), "Smart cities from scratch? A socio-technical perspective", *Cambridge Journal of Regions, Economy and Society*, Vol. 8, No. 1, pp. 43-60.
- Espejo, R., Mendiwelo Bendek, Z. (2011). An argument for active citizenship and organisational transparency. *Kybernetes*, 40(3/4), 477-493.
- Ferraris, A., Santoro, G. (2014) "Come dovrebbero essere sviluppati i progetti di Social Innovation nelle Smart City? Un'analisi Comparativa" *Impresa Progetto - Electronic Journal of Management*, Vol. 4, pp. 1-15.

---

<sup>1</sup> <https://ec.europa.eu/digital-single-market/about-smart-cities>

- Grimaldi, D., & Fernandez, V. (2016). The alignment of University curricula with the building of a Smart City: A case study from Barcelona. *Technological Forecasting and Social Change*, forthcoming.
- Sandulli, F., Ferraris, A., Bresciani, S. (2016). "How to select the right public partner in Smart City projects", *R&D Management*, DOI: 10.1111/radm.12250.
- Scuotto V., Ferraris A., Bresciani S. (2016) "Internet of Things: Applications and Challenges in Smart Cities. A case study of IBM smart city projects", *Business Process Management Journal*, Vol. 22 No. 2, pp. 357-367.
- uN (2014) Department of Economic and Social Affairs, Population Division "World Urbanization Prospects: The 2014 Revision, Highlights".
- Vanolo, A. (2016). Is there anybody out there? The place and role of citizens in tomorrow's smart cities. *Futures*, 82, 26-36.

## **ADOPTION OF RISK MANAGEMENT IN SMES: A SYSTEMATIC LITERATURE REVIEW**

**Ferreira de Araújo Lima, Priscila; Verbano, Chiara; Crema, Maria**

Department of Management and Engineering, University of Padova, Vicenza, Italy

### **ABSTRACT**

#### **BACKGROUND**

In the last years, Risk Management (RM) has been a major issue for companies to ensure their survival and overcome uncertainties to reach their goals. RM has considerable implications for competitiveness and business; it enables, for instance, the development of a strategy to reduce potential losses while exploiting new windows for opportunities (Radner and Shepp, 1996).

Notwithstanding, still nowadays, RM implementation in the companies is inconsistent (Faisal, 2007). Many firms lack knowledge, resources and reliable mechanisms to support their RM application, and this is particularly notable for Small and Medium-sized Enterprises (SMEs) (Brustbauer, 2014). SMEs are more vulnerable to risks and should be more engaged into applying RM (Alquier and Tignol, 2006).

SMEs are companies with limited resources and with more difficulties to overcome risks due to their limited size. As stated by many researchers, the literature has focused on large companies, leaving a lack of empirical evidence addressing small companies (Kim and Vonortas, 2014). There is a gap of research in RM in SMEs and few academic studies have addressed the theme (Rostami, 2015; Thun, 2011; Marcelino-Sadaba et al., 2013; Toulouva et al., 2016; Ellegaard, 2008), despite the increasing number of SMEs in Western economies.

Moreover, this lack of studies is relevant because SMEs are considered the backbone of EU countries' growth: they represent 99% of the enterprises and 67% of all employment in the EU (OECD, 2011). Therefore, improving SME's managerial knowledge and competencies is crucial to leverage the development of the whole economy (Hussain et al., 2006; Porter, 2006).

Knowing the importance of SMEs and the overmentioned significant gap in the literature, this research intends to collect and analyze the existing relevant studies on risk management applied in SMEs through a systematic literature review.

## OBJECTIVES

The aim of this research is to define the state of the art about RM applied to SMEs and identify the most relevant gaps in the literature. Once they are identified, it will be possible to determine the directions for future researches in the field. In order to do that, a database containing the significant published articles that address RM in SMEs has been built. The academic databases (DB) used in this search were Scopus and Web of Science Core Collection. Different set of keywords (mainly considering "Risk Management" and "SMEs", or "Small Business") were combined to extract the results.

A total of 621 papers were found, being 113 papers in Scopus and 508 in Web of Science. To narrow down the searching results, a selection process was performed using the following filters: exclusion of proceeding papers, editorial materials and notes; exclusion of articles that are not in English, exclusion of the duplicated articles obtained through the different queries and of the duplicated articles between both databases. To conclude the selection of papers, the abstract and, finally, the full-text of the papers were read, excluding those that did not regard RM in SMEs and those that were not scientific, obtaining a final database of 57 articles.

In order to assess the quality of the database that was built, the Journal Citation Reports Impact Factor (JCR-IF), the Scimago Journal Rank (SJR) and the "*Associazione Italiana di Ingegneria Gestionale*" (AiIG - Italian association of management engineering) ranking have been reported. Then, a descriptive analysis of the database was executed, which consisted of collecting the information regarding the year, the author, the country where the first author works, the country where the study has taken place and the type of research methodology adopted in each paper. Finally, a content analysis was performed using the variables RM stream (Verbano and Venturini, 2011, 2013), RM process phases (Rabechini and Carvalho, 2013; Cagliano et al., 2014) and the risk types (Casualty Actuarial Society, 2003; The Institutes - Risk & Insurance Knowledge Group, 2009), with the final intent to identify the existing gaps in the literature regarding RM in SMEs which will address potential future research.

## PRELIMINARY FINDINGS AND DISCUSSION

The database with the selected papers contains articles from 1994 until 2016, but only in the last four years a growing trend can be identified.

Almost 83% of the papers in the database are published in journals classified in the first 2 quartiles for JCR-IF; 58% are in the first two quartiles considering SJR; and 65% of the articles are on the top journals (gold and silver) referring to the AiIG ranking, certifying the high quality of the database. No particular journal is specifically devoted to the topic, but these two have published more articles than the others: Production Planning & Control (4 papers) and International Journal of Entrepreneurship

and Small Business (3). The 6 most cited articles (written by 5 different authors) correspond to 47% of all the citations in the database. These authors are: Labodova (2004), Faisal (2006; 2007), Finch (2004), de la Torre (2010) and Wu (2009). The first authors of the papers in the database work mostly in the United Kingdom (8), in Germany (6) and in the United States (5), while the most productive authors are Thomas Henschel, from Germany and Mohd Nishat Faisal, from India with 3 papers published each. More than half of the researches (52%) were applied in Europe, mainly in the United Kingdom and in Germany, while 22,2% were applied in Asia, mostly in India.

Regarding the research methodology, the great majority of the papers are empirical (89%), while 7% are conceptual and 4% are literature reviews. Among the empirical ones, 21 are surveys, 15 are case studies, 3 mix both the previous research designs, 9 are modeling tests and 1 is an action research.

Since the aim of this research is to define the state of the art related to RM in SMEs, it was also important to analyze which RM streams, risk types and RM phases have been studied. The main studied risk management streams are financial RM (25%), strategic RM (25%) and enterprise RM (23%). Less studied are the supply chain RM (12% of the papers) and project RM (11%), while the engineering RM stream is not studied in any of the articles and the disaster RM stream is focused on 2 papers only.

As for the risk types, the financial and operational ones are studied in 30% of the articles each, strategic risks are considered in 25% of the papers, while hazard risks are the less studied ones (15%). When considering the risk types and their subcategories, there is a clear evidence that the credit risk in the financial risk type is the most studied category among all, followed by the business operations risks in the operational risk type. Among the strategic risks, those linked with information technology are the most evident, while in the hazard ones the occupational risk is the most considered one.

As it was expected, due to the results obtained from the RM stream analysis, most of the researches took place in the financial sector and they are related to financial RM stream. When analyzing other industries and the correlated RM stream, it is also possible to notice the following relationships: Project RM in the construction industry, supply chain RM in the automotive industry and strategic RM in the financial and manufacturing industry.

Approximately 35% of the papers regard all the RM phases. The evaluation of risks is the most studied phase as it can be found in 33% of the articles, followed by the risk identification (30%). This may be due to the fact that identification and evaluation are the first two steps of the RM process, but it is also possible that the real reason is that, since these phases are considered by many authors to be the most critical ones, the SMEs have been putting more effort into implementing them. Other analysis will be conducted to deepen the literature review, in order to offer a complete synthesis for scholars interested in this topic and to highlight future research opportunities.

*Keywords: risk management, SMEs, systematic literature review*



## TOWARD DEVELOPING A PRACTICAL MODEL FOR SUCCESSFUL GENERATIONAL TRANSITION IN THE FAMILY BUSINESS

Flynn, JoAnn; Duesing, Robert J.

Department of Management, Georgia College and State University, Milledgeville, GA USA

### ABSTRACT

One of the most difficult challenges a family business faces is the transition from one generation of ownership to the next. Researchers continue to call for more exploration into the strategic activities necessary to foster a successful generational transfer of the family business (Jakiewicz et al., 2014; Bruce and Picard, 2006; Dalpiaz et al., 2014).

The need for focus on successful transition between generations in the family business has never been more important. Research indicates that within ten years, some 40% to 65% of family businesses in the U.S. will transition to the next generation, transition to new owners, or be closed (American Family Business Survey, 2007; DeTienne, 2010). And the issue of successfully orchestrating an ownership change is not confined to the US. Research indicates 100,000 family firms in Germany and 70,000 in Japan will likely transition annually, many without prospective successors within the family (Hauser et al., 2010; Kamei and Dana, 2012). Add to these figures the research that indicates only about 30% of family businesses will successfully transition to a second generation and 15% survive to the third generation (Ibrahim et al., 2001; Le Breton-Miller et al., 2004), and the magnitude of the impending transitions becomes clear.

This article proposes a simple yet theory-based three-phase structure to guide the work of preparing for a successful transfer of leadership across generations. Drawing from stakeholder theory (Harrison and Freeman, 1999), role theory (Katz and Kahn, 1978), boundary theory (Ashforth et al., 2000), family dynamics literature (Cooper and Kidwell, 2013; Sundaramurthy and Kreiner, 2008), and the literature on retirement dynamics (Muratore and Earl, 2010), the paper proposes that a successful transition from one generation of ownership to the next is contingent on three primary factors. First, the business must be organizationally strong and financially sound. Second, there must be a family dynamic with strong relationships free from drama. A third key factor centers on developing owners who are prepared both financially and emotionally for the transition to retirement and the next phase of their lives. The framework holds that if any one of these three areas is not strong and sound, the odds of a successful transfer of the business diminish significantly.

The article makes three important contributions to the literature on generational transition in the family business. First, the article pulls together the theoretical literature on generational transition

into a working model that can inform practical actions which may lead to increasing the odds of a successful transfer.

Second, the article also highlights the oft-ignored element of the owner's "self" in relation to retirement as a key factor for success in the generational transfer of the family business. This is as much of a psychological and emotional journey as it is a business journey, presenting significant complexities in the process.

Third, the article contributes to the family firm literature by emphasizing the focus on the family dynamics and the imperative need for the owner to identify and "clean up" any lingering family "messes" that are of his or her own making prior to exiting the organization.

This article lays the groundwork for management scholars to bring more focus to the construct of "successful transition" from both an applied and a theoretical framework. Our hope is that this article can encourage thought and help establish streams of empirical study to narrow the gap between research and reality in family business transitions.

***Key words: family business; transition; generational ownership changes; success in generational transition; management skills; retiring from the family business***

## REFERENCES

- American Family Business Survey (2007). Mass Mutual Financial Group, Kennesaw State University, Family Firm Institute, Springfield, MA.
- Ashforth, B.E., Kreiner, G.E. and Fugate, M. (2000), "All in a day's work: boundaries and micro role transitions", *The Academy of Management Review*; Vol. 25.3, pp. 472-491.
- Bruce, D. and Picard, D. (2006), "Making succession a success: Perspectives from Canadian small and medium-sized enterprises", *Journal of Small Business Management*, Vol. 44 No. 2, pp. 306-309.
- Cooper, J.T., Kidwell, R.F. and Eddleston, K.A., (2013), "Boss and parent, employee and child: work-family roles and deviant behavior in the family firm", *Family Relations*, Vol. 62 No. 3, pp. 457-471.
- Dalpiaz, E., Tracey, P. and Phillips, N. (2014), "Succession narratives in family business: the case of Alessi", *Entrepreneurship Theory and Practice*, Vol. 38 No. 6, pp. 1375-1394.
- DeTienne, D.R. (2010), "Entrepreneurial exit as a critical component of the entrepreneurial process: theoretical development", *Journal of Business Venturing*, Vol. 25 No. 2, pp. 203-215.
- Harrison, J.S. and Freeman, R.E. (1999), "Stakeholders, social responsibility, and performance: empirical evidence and theoretical perspectives", *Academy of Management Journal*, Vol. 42 No. 5, pp. 479-485.
- Hauser, H.E., Kay, R. and Boerger, S. (2010), "Firm successions in Germany from 2010 to 2014—with advanced estimation methods", *IfM Bonn: IfM-Materialien*, p. 198.
- Ibrahim, A.B., Soufani, K and Lam, J. (2001), "A study of succession in family firms", *Family Business Review*, Vol. 14, pp. 245-258.
- Jaskiewicz, P., Combs, J.G. and Rau, S. B. (2015), "Entrepreneurial legacy: toward a theory of how some family firms nurture transgenerational entrepreneurship", *Journal of Business Venturing*, Vol. 30 No. 1, pp. 29-49.
- Kamei, K. and Dana, L.P. (2012), "Examining the impact of new policy facilitating SME succession in Japan: from a viewpoint of risk management in family business", *International Journal of Entrepreneurship and Small Business*, Vol. 16 No. 1, pp. 60-70.
- Katz, D. and Kahn, R.L. (1978), *The Social Psychology of Organizations*, Wiley, Hoboken, NJ.
- Le Breton-Miller, L., Miller, D. and Steiner, L. (2004), "Toward an integrative model of effective FOB succession", *Entrepreneurship, Theory and Practice*, Vol. 28, pp. 305-328.
- Muratore, A.M and Earl, J.K., (2010), "Improving retirement outcomes: the role of resources, pre-retirement planning and transition characteristics", *Ageing and Society*, Vol. 35 No. 10, pp. 2100-2140.

Sundaramurthy, C and Kreiner, G. E. (2008), "Governing by managing identity boundaries: the case of family businesses", *Entrepreneurship Theory and Practice*, Vol. 32 No. 4, pp. 415-436.

**THE COST OF EQUITY OF *TOO BIG TO FAIL* BANKS (TBTF). A  
COMPARATIVE STUDY BETWEEN CAPM, THE METHOD BASED ON THE  
RECIPROCAL OF P/E MULTIPLE AND ACTUARIAL METHOD**

**Fontana, Stefano; Coluccia, Daniela; Solimene, Silvia; Rosati, Serena**

Dept. Business and Law, Sapienza University of Rome, Italy

**ABSTRACT**

The cost of equity is typically defined as the expected return that investors require to purchase common stock in a firm. It is therefore an important input for bank management when raising capital and making investment decisions and for investors when they value equity securities and construct their portfolios. The Capital Assets Pricing Model (CAPM) method remains the one most commonly used by practitioners and financial advisers to estimate a firm's cost of equity, as shown in surveys by Brunner et al (1998) and Graham and Harvey (2001).

This paper provides a comparative analysis of different methods for determining the cost of equity according the following methods: the Capital Assets Pricing Model, the Actuarial Method, (Oricchio, 2012), based on the probability of default (PD) and finally the method based on the "price to earnings" multiple (P/E), (Zimmer and McCauley, 1991).

This comparison has been carried out on 24 large international banks (the so called "Too Big to Fail") from 2012 to 2014.

The selected banks in the sample belong to eleven different countries.

The first phase was aimed at measuring the risk premium of the banks through the use of the CAPM method. This model estimating the parameter of the risk premium as resulting from the product of beta coefficient and the equity risk premium (ERP).

Beta factors, provided by the Datastream-Thompson Reuters Company, covered the period 2012 - 2014.

The second phase determined the probability of default of the selected banks, for a period of three years, providing estimates on the basis of the credit rating of each financial institution analyzed. This method is based on the use of 10 years cumulative PD from the Moody's database.

Finally, the "cost of equity" of selected banks was measured through the alternative approach based on the reciprocal of the multiple "price to earnings". However, an important assumption needs to be introduced in order to use this method for estimating a firm's cost of equity. This is that the current profit rates represent a good estimate of the expected long-term sustainable ones.

These three methods have been used during the overall analysis process, exclusively focusing on market data, and through these data it has been possible to estimate "the cost of equity".

A comparison has been carried out between three models in the following way:

- Determining the difference between the values obtained by CAPM method and the values resulting from the use of Actuarial Method;
- Determining the difference between the values obtained by CAPM method and the values resulting from the use of reciprocal of "price to earnings" multiple (P/E).

The trends of cost of equity, calculated with the three methods, were observed, and after such analysis, the results have been examined and possible differences of values have been explained.

*Keywords: cost of equity; CAPM, price to earning; probability of default*

## REFERENCES

- Altman E.I., Financial Ratios, Discriminant Analysis and Prediction of Corporate Bankruptcy, in Journal of Finance, n. 23, sett. 1968.
- Altman E.I., Hartzell J., Peck M., Emerging Markets Corporate Bonds: A Scoring System, Salomon Brothers Inc, New York, 1995.
- Amihud Y., Christensen B.J., Mendelson H., Further Evidence on the Risk-Return Relationship, in Research Paper, n. 1248, nov. 1992.
- Banz R.W., The Relationship Between Return and Market Value of Common Stock, in Journal of Financial Economics, n. 9, 1981.
- Basu S., The Relationship Between Earnings Yield, Market Value, and the Returns for NYSE of Common Stock, in Journal of Financial Economics, n. 12, 1983.
- Beaver W.H., Financial Ratios and Predictors of Failure, in Journal of Accounting Research, Supplement on Empirical Research in Accounting: Selected Studies, 1966.
- Black F., Beta and Return, in Journal of Portfolio Management, summer 1993.
- Black F., M. Jensen, M. Scholes, The Capital Asset Pricing Model: some empirical results, in Studies in the Theory of Capital Market, edited by Michael Jensen, Praeger, New York, 1972.
- Booth L., The capital asset pricing model: equity risk premiums and privately-held business, in Journal of Business Valuation, december 1999, pp. 87-114.
- Bruner R.F., Eades K.M., Harris R.S., Higgins R.C., Best practice in estimating cost of capital: survey and synthesis, in Financial Practice and Education, spring-summer, 1998, pp. 13-28.
- Cheung J., A probability based approach to estimating cost of capital for small business, in Small Business Economics, n. 12, march, 1999, pp. 331-336.
- Demirguc-Kunt A., Levine R., Stock market development and financial intermediaries: stylized facts, World Bank, in Policy Research Working Paper, n. 1462, 1995;
- Dyck A., Zingales L., Private benefits of control: An international comparison, working paper, dec. 2001, [gsbwww.uchicago.edu/fac/luigi.zingales/research/research.htm](http://gsbwww.uchicago.edu/fac/luigi.zingales/research/research.htm);
- Elton E.J., Gruber M.J., Mei J., Cost of capital using arbitrage pricing theory: a case study of nine New York utilities, in Financial Markets, Institutions & Instruments, vol. 3, n. 3, 1994, pp. 46-73.
- Falkenstein E., Boral A., Carty L.V., RiskCalc™ for Private Companies: Moody's Default Model, in Moody's Investors service, May 2000.
- Fama E.F., French K.R., The Cross Section of Expected Stock Returns, in Journal of Finance, n. 2, 1992.
- Fama E.F., French K.R., Common risk factors in the returns on stocks and bonds, in Journal of Financial Economics, n. 36, 1993.
- Fama E.F., MacBeth J.D., Risk, return, and equilibrium: empirical tests, in The Journal of Political Economy, n. 3, (May-June) 1973.
- P. Fernandez, P. Linares, I. Fernandez Acín, Market Risk Premium used in 88 countries in 2014: A Survey with 8,228 Answers, working paper, SSRN.
- Fernandez P., CAPM: An Absurd Model, in Business Valuation Review, Vol. 34, Spring 2015, pp. 4-23.

- Grossman R.J., Hansen M., CDS Spreads and Default Risk. Interpreting the Signals. Fitch Special report, 12 October 2010.
- Hamada R. S., Portfolio Analysis, Market Equilibrium and Corporate Finance, in *The Journal of Finance*, n. 24, 1969.
- Hardouvelis G., Malliaropoulos D., Priestly R., The impact of globalization on the equity cost of capital, Fondation Banque de France, working paper, March 2001, [www.banque-france.fr/gb/fondatio/papers/index.htm](http://www.banque-france.fr/gb/fondatio/papers/index.htm).
- Jagannathan R., Wang Z., The C.A.P.M is Alive and Well, in *The Fourth Annual Conference on Financial and Accounting*, Washington University, St. Louis, October 1-2, 1993.
- Jorion P., Goetzman W.N., Global stock markets in the twentieth century, in *Journal of Finance*, n. 54, 1999.
- King R., The cost of equity for global banks: a CAPM perspective from 1990 to 2009, *BIS Quarterly Review*, September 2009, pp. 59-73.
- Kurz M., Beltratti A., The equity premium is not a puzzle, in *Temi di Discussione*, n. 282, Banca d'Italia, 1996.
- La Porta R., Lopez-de-Silanes F., Shleifer A., Corporate ownership around the world, in *Journal of Finance*, aprile 1999.
- Lamfalussy A., I mercati finanziari europei, Einaudi, Torino, 1972.
- Lintner J., The valuation of risk assets and selection of risky investments in stock portfolios and capital budgets, in *The Review of Economics and Statistics*, n. 47, 1965.
- Maccario A., Sironi A., Zazzara C. Is Banks' Cost of Equity Capital Different Across Countries? Evidence from the G10 Countries Major Banks, SDA Boocconi, Milano, 2002.
- Mandekeler G.N., Ghon Rhee S., The impact of the degree of operating and financial leverage on systematic risk of common stock, in *Journal of Financial and Quantitative Analysis*, March, 1994, pp. 45-57.
- Markowitz H., Portfolio Selection, in *The Journal of Finance*, n.1, March 1952.
- Mehra R., Prescott E. C., The equity premium: a puzzle, in *Journal of Monetary Economics*, n. 15, 1985.
- Mehra R., The equity premium: why is it a puzzle?, working paper, Oct. 2000, [www.econ.ucsb.edu/~mehra/papers](http://www.econ.ucsb.edu/~mehra/papers).
- Mossin J., Equilibrium in a capital asset market, in *Econometrica*, n. 34, 1966.
- Ohlson J.S., Financial Ratios and the Probabilistic Prediction of Bankruptcy, in *Journal of Accounting Research*, n. 19, 1980.
- Oricchio G. Private Company Valuation. How Risk Reshaped Equity markets And Corporate Finance Valuation Tools, Palgrave-McMillan, New York, 2012.
- Pratt S.P., Cost of capital. Estimation and applications, J. Wiley & Sons, Hoboken, New Jersey, 2002.
- Reinganum M.R., Misspecification of Capital Asset Pricing: Empirical Anomalies Based on Earnings Yield and Market Values, in *Journal of Financial Economics*, n. 9, 1981;
- Roll R., A Critique of the Asset Pricing Theory's Tests: Part 1: On Past and Potential Testability of Theory, in *Journal of Financial Economics*, n. 4, 1977;
- Sharpe W. F., Capital asset prices: a theory of market equilibrium under conditions of risk, in *The Journal of Finance*, n. 19, 1964;
- Sholes M., Williams J., Estimating betas from nonsynchronous data, in *Journal of financial economics*, n. 5, 1977, pp. 309-327.
- Shumway T., Forecasting Bankruptcy More Accurately: A Simple Hazard Model, University of Michigan, Working Paper, July 1999;
- Thompson D.J., Sources of systematic risk to common stock, in *Journal of Business*, April, 1976,
- Zimmer, S. A., Robert N. McCauley, 1991, "Bank Cost of Capital and International Competition", *Federal Reserve Bank of New York Quarterly Review*, Winter, 33-59
- Zmijewski M.E., Methodological issues related to the estimation of financial distress prediction models, in *Journal of Accounting Research*, n. 22, 1984.

## RETAILERS' INVENTORY STRATEGY ON PURCHASING-CONSUMPTION CYCLE MODEL OF CONSUMERS

Fujimoto, Hisao

Department of Information Technology and Social Sciences, Osaka University of Economics, Osaka, Japan

### ABSTRACT

This paper explores the importance of consumers' inventory for distribution channels. For this purpose, this study approaches consumers' purchasing and consuming cycle, and the changing relationships between distribution channel members in Japan. In addition, this study based on a buying behavior model and the data of local consumers' buying behavior of Japanese consumers, focusing especially elderly people, suggests that Japanese consumers can offer opportunities to local small retailers.

Bucklin (1963) and Tamura (1982) defined that retailers provide "retail services" for consumers. According to them, these services can be classified into the following four types:

- (1) *Reduction of buying lots*
- (2) *Shortening of trading and delivering time*
- (3) *Assortment of goods*
- (4) *Providing of accessibility*

Consumers usually make their buying plans before the shopping trips. Considering whether their buying actions are done as designed or not is an important criterion, because the buying plan prescribes the consumption interval of goods.

The consumption interval consists of three time stages:

- (1) Time of decision to what goods or brands should buy.
- (2) Time of action to get goods.
- (3) Time of using and consuming the goods.

Especially, the first time stage is decisive on this issue, and two factors have effect on this stage. The first factor is the "sense of stock in house". If a consumer lays stress on the extent of the stock of goods in house, the buying plan on these goods is designed as a long-range and firm schedule. The second factor is the "synchronization of the consumption interval". In generally, a consumer buys many kinds of goods at one shopping, because the buying or trip cost per one goods can be decreased. The more a consumer purchases many goods at one time, the more he can be benefited over the shopping cost.

This paper uses two dimensions: “the axis of space” and “the axis of time”. The space axis is a criterion of judgment on consumer’s accessibility to retail store. At one side of this dimension is the “decentralization”, which means the store’s location to be decentralized in a given market area. When a consumer chooses a store located close to him, it reflects that he lays stress on the accessibility. At the opposite side is the “centralization”, which means the centralized retail location, as a commercial center or shopping center, at one district in a given market area. The type of consumption interval is determined by time dimension. When the interval is short, it is categorized as the “frequent buying”. If the interval is relatively long, it is assumed the “non-frequent buying”.

We describe following four types: (1) *Frequent centralization buying*, (2) *Frequent decentralization buying*, (3) *Non-frequent centralization buying*, (4) *Non-frequent decentralization buying*.

In order to explain the reasons that the number of small retailers could occupy the majority in Japanese retail structure for long time, some researchers have introduced several consumer behavior approaches. For example, Maruyama (1992) and Naryuu (1994) insist that Japanese consumers have a strong taste for fresh products, such as raw fish and fresh vegetables, instead of processed foods like canned or frozen foods. All the products are perishable, preserved only for a short period of time even in a refrigerator. They also argue that the average house space in Japan is generally narrow. Therefore, the cost of inventory stock of goods in house is rather high. Because of these points, they conclude that Japanese consumers go shopping frequently in small lots at each purchase. It leads to the retail structure with a large number of small retailers densely located near to residential area.

Their model apparently assumes that Japanese consumers carry out shopping by foot. However, motorization in Japanese society had been developed enough. As in other countries, many consumers use cars for daily shopping and go to giant retail stores beyond the local marketplace. It means that local small retailers in one district have to compete with giant stores located in the same district and/or outside of it.

The consumers’ shopping pattern, which can be grouped as the “frequent centralization buying” and the “non-frequent centralization buying”, can be supposed to have the effect to reduce the survival rate of local small retailers.

Retailers have to focus their attention on the particular consumer segments to develop effective strategies. In this paper, the authors tried to classify the consumer buying behavior as a base for developing strategies. As the result, consumers who carry out the “frequent decentralization buying” are congenial to small residential retailers. These consumers tend to complete their daily shopping within their local communities.

The study suggests that elderly consumers can be a promising segment to become potential customers for local small retailers. Their behavior can be classified into the “frequent



decentralization buying". They may be not so conscious of price, but conscious of high level services. Small retailers can provide them with many kinds of services as important social supports. Several small retailers already have begun to recognize the importance of elderly consumers and grapple with new retail services such as the convenient ordering and delivery systems. When retailers can serve to consumers' access and frequent buying, it can reduce the burden of consumers' stock keeping.

The economic activities involved in the consumer-retailer exchange are embedded in the community's social structure. Rural small retailers are encouraged to focus on a specific segment that has a majority in the community, and to increase their own involvement in community activities. Elderly consumers who have been considered as the economic and social minority will become the important segment of market and local small retailers in 21st century.

*Keywords: Purchasing-Consumption Cycle, Retailer' Inventory, Distribution Channel, Demand Forecast, Elderly consumers*

## REFERENCES

- Bergmann, J. (1998), Small Markets Are Attracting More Retailers, *Discount Merchandiser* 38 (May): pp.42-46.
- Betancrot, R. R., and Gautschi D. (1992), The Demand for Retail Products and the Household Production, *Journal of Economic Behavior and Organization* 17 (March): pp.257-275.
- Bucklin, L. P. (1963), Retail Strategy and the Classification Consumer Goods, *Journal of Marketing* 27 (January): pp.50-58.
- Kean, R. (1998), Effects of Community Characteristics, Business Environment, and Competitive Strategies on Rural Retail Business Performance, *Journal of Small Business Management* 36 (April): pp.45-57.
- Kim, B. and Park K. (1997), Studying Patterns of Consumer's Grocery Shopping Trip, *Journal of Retailing* 73 (winter): pp.501-517.
- Maruyama, M. (1992), Competitive Structure in Japanese Market (*Nihon Shijou No Kyouso Kouzou*), Soubunsha, Tokyo.
- Miller, N. J. and Kim S. (1999), The Importance of Older Consumers to Small Business Survival: Evidence from Rural Iowa, *Journal of Small Business Management* 37 (October): pp.1-15.
- Miller, N. M. (1986), Rural Retailing: The Last Frontier, *Chain Store Age Executive with Shopping Center Age* 62 (March): pp.18-20.
- Naryuu, T. (1994), Economic Theory of Marketing and Distribution (*Ryuutsuu no Keizai Riron*), Nagoya Daigaku Shuppan Kai, Nagoya.
- Tamura, M. (1982), The Distribution Industry (*Ryutuu Sangyou*), Nihon Keizai Shinbunsha, Tokyo.

## THE CHOICE OF CREATIVE COMMONS LICENSE

Gambardella, Massimiliano

University of Rome Link Campus, Rome, Italy

### ABSTRACT

With the advent of new technologies a set of alternative licenses, Creative Commons (CC) licenses, has emerged.

CC licenses are directly derived from Free *Libre* Open Source Software (FLOSS) licenses. FLOSS licenses and cultural works (video, music, texts, etc) under CC licenses share a common cultural, legal and digital heritage. Therefore, we assume that the motivation to participate in a FLOSS project or a CC project might be similar. Some authors have considered the existence of alternative incentives to classical monetary motivation. Indeed, in the case of attenuation of property rights and, by extension, of classical monetary motivations, other motivations like Reputation, Career concerns, Peer recognition, Sharing innovation, Activity itself, Ego gratification and Need, could incentivize users to participate in the creation of works (Johnson, 2002; Lakhani and Wolf, 2005; Lerner and Tirole, 2002; Valentinov, 2007; von Hippel, 2005, 1988).

For purposes of this study we define as organizational status the legal status of the creators. Possible organizational statuses are: For-Profit (firms and professionals), Nonprofit (associations), public administration (the government), and Informal (undetermined legal status).

The organizational status and the type of license are central to motivating users to contribute to a project (Colazo and Fang, 2009; Lerner and Tirole, 2005; Singh and Phelps, 2009; Stewart et al., 2006).

Using different combinations of clauses it is possible to create different licenses with different degrees of openness, in both production and dissemination.

The aim of this study is to explore the impact of the organizational status of creators on the openness of the chosen CC licenses.

To do that an empirical analysis of video under CC licenses was performed using an original database created from the Internet Archive.

For both the production and dissemination process, we investigate the impact of the organizational status of the creator on the degree of openness of the license by estimating an ordered logistic regression and marginal effects.

This study analyses the impact of the organizational status on the openness of the licenses.

According to the standard property rights approach, the regime of private property rights provides sufficient motivation for creators to produce works. As a consequence, creators should be more likely to use restrictive licenses. The results of this study suggest that in the case of products under non-restrictive property rights regimes, such as CC licenses, the opposite is observed

The results of this study show that licenses that are very open are more likely to be adopted by: For-Profit creators in production and dissemination, Nonprofit creators in dissemination only, and Informal creators in production only.

The results of our study suggest that, in order to attract contributions from users, creators adjust the degree of openness of the license to in order to their organizational status.

*Keywords: Creative Commons Licenses, Copyright, Property Rights, Openness, For-Profit, NonProfit, Organizational Status, Contribution*

## REFERENCES

- Colazo, J., Fang, Y., 2009. Impact of license choice on Open Source Software development activity. *J. Am. Soc. Inf. Sci. Technol.* 60, 997–1011.
- Johnson, J., 2002. Open source software: Private provision of a public good. *J. Econ. Manag. Strategy.*
- Lakhani, K.R., Wolf, R.G., 2005. Why hackers do what they do: Understanding motivation and effort in free/open source software projects. *Perspect. Free Open Source Softw.* 3–22.
- Lerner, J., Tirole, J., 2005. The Scope of Open Source Licensing. *J. Law Econ. Organ.* 21, 20–56.
- Lerner, J., Tirole, J., 2002. Some simple economics of open source. *J. Ind. Econ.* 50, 197–234.
- Singh, P.V., Phelps, C., 2009. Determinants of Open Source Software License Choice: A Social Influence Perspective. Available SSRN [Httpssrncomabstract1436153](http://ssrn.com/abstract/1436153).
- Stewart, K.J., Ammeter, A.P., Maruping, L.M., 2006. Impacts of license choice and organizational sponsorship on success in open source software development projects. *Inf. Syst. Res.* 17, 126–144.
- Valentinov, V., 2007. The Property Rights Approach to Nonprofit Organization: The Role of Intrinsic Motivation. *Public Organ. Rev.* 7, 41–55.
- von Hippel, E., 2005. *Democratizing Innovation*. MIT Press.
- von Hippel, E., 1988. *The sources of innovation*. Oxf. Univ. Press N. Y. 218.

**THE ROLE OF CENTRAL BANKS IN THE RECENT FINANCIAL CRISIS.  
CAUSES AND CONSEQUENCES OF THE CRISIS AND COUNTERMEASURES  
TAKEN**

**Georgakoulias, Athanasios; Koulakiotis, Athanasios**

School of Economic and Regional Studies, Department of Balkan, Slavic & Oriental Studies, University of Macedonia of Economic and Social Sciences, Thessaloniki, Greece.

**ABSTRACT**

The objective of this paper is to show the importance of central Banks' operations regarding the recent financial crisis. Firstly, we considered the existence of central banks and how their operation and administration enhance economic performance; how do central banks influence the everyday life of citizens. The targets and main role of central banks apart from the fact that they influence the fixing of interest rates, they also apply more extensively the monetary policy from different aspects, such as the FED combats credit contraction and ECB combats excessive credit expansion. How did Central Banks act in the Credit Mess in 2008 and how targets come in contrast between each other, as coping with by the Central Banking system? In this paper, we examined the instrument or better to say the mechanism of the Lender of last resort on behalf of the central banks and the crucial concept of Moral Hazard on behalf of borrowers, that is, the commercial banking system: what are the repercussions of it for the financial system? J. M. Keynes' proposals are examined and Milton Friedmans' views regarding credit creation, inflation and money supply. What were the features of the cases: Bear Stearns and Northern Rock during the crisis and how the mechanism of credit creation worked for borrowing and lending? J. M. Keynes' "Paradox of Thrift" and Minsky's "Paradox of Gluttony" are considered in relation to business profits.

Secondly, we considered the causes and consequences of the financial crisis and what countermeasures have been taken. The psychology of the investors and the perception of risk are reviewed during the period of August 2007-2009 and how the bond spreads and policy interest rates varied. A very important cause of the financial crisis was the lack of financial regulation which favored the "Affordability Products", the Subprime Mortgage Loans and the concept of low risk in relation to the low interest rates in the medium and long run period. The above "products" allowed households to pay the very high price of houses, because it was required by mortgages houses a very low or no deposit of money in the banks for financing or refinancing reasons. The main features of subprime borrowing, supported by low quality guarantees for coping with the higher credit risk. At the beginning of the financial crisis there was a mess; the installments were not paid for borrowed money, the arrears rate started to raise, something that neither lenders nor investors could expect.

Many mortgage lenders went bankrupt because of the very early defaults of borrowers, not paying even the first payment in banks for what they borrowed. Money Market Rates did not follow the Policy rates of the central banks as it usually was and this relationship stopped, in August 2007, between the two kind of Rates. Investors did not demand certain kinds of Mortgage-backed securities against liquidity and this situation created the shortage of funding for the lenders who depended on short-term money markets or on Securitization of the funds they lent for household mortgages.

As far as the Stock Market concerned, Banks' share prices fell sharply, when Lehman Brothers declared losses, from July 2007 and fell even more when Lehman Brothers failed. Customers lost their confidence, regarding the solvency of the above institution and they invested in safer securities like the US government bonds. The new classes of assets were affected by the change of the risky price.

Thirdly, there were large consequences on the matter of confidence: spending vanishes when companies and consumers do not trust and do not feel secure in the economic environment where they act and operate. Lack of adequate regulations converted the US mortgage crisis in a banking crisis in the north part of the continent and this crisis was extended into a global one. Many macroeconomic indicators deteriorated because of the intensification of the crisis (2007). There was an acute contraction of industrial output, and as a result the prices declined tremendously until the end of 2007. Borrowers found it difficult to honor their debts. In 2009, because of the down-turn of the world economic outlook bad loans rose, as a percentage of total lending, and profitability of banking sector decreased in USA, Europe and Japan.

Finally, as far as countermeasures are concerned, policy makers focused on banking system, especially central banks stimulated their economies by following an easy-going fiscal and monetary policy: an additional liquidity for the banks was provided for extra lending to economy. The restoration of the financial system was consisted of the support of the financial Institutions and financial Markets. Financial Institutions were guaranteed by the governments, for their funding through the issuance of debt. Some governments supplied capital to the banks and others helped the banks to reduce the grade of risk over the banks' assets underwritten in their balance sheets. Governments bought the assets of the banks outright by supplying liquidity to banks immediately.

Nevertheless, the financial system remained fragile as far as confidence is concerned, but some market indicators improved in March 2009. Money market spreads decreased greatly after what happened with the Lehman Brothers bankruptcy. Stock Exchanges partially returned back to reasonable levels after the US government released its detailed programs for de-risking the balance sheets of the banks. Reforms to the financial system were considered, in order to prevent similar crises again. Policies under discussion referred to the changes to the regulation of Credit Rating Agencies, the payment incentives of the Staff of the Financial Institutions and the regulation concerning the banks' capital

and liquidity. The Financial Stability Board and the Basel Committee on Bank Supervision developed the above-mentioned initiatives. Both groups membership expanded, in particular by major emerging economies.

The global financial system was facing a period of change. The easy conditions of Credit Markets excesses did not seem to return back soon. Credit conditions started to be tight and the finance for buying assets back became tighter.

As it is obvious from the above mentioned, the current research work, at the moment, is focused on a theoretical grounds. Consequently, the used methodological approach is a qualitative one, centralizing on the 4 aforementioned pillars/axons, relying, mainly, on the role of central banks during the recent global financial crisis and more specifically on the comparison analysis between the applied strategies of monetary policy, by FED and ECB.

*Keywords: financial crisis, moral hazard, credit driven bubbles bursts, monetary policy, credit creation, money supply.*

## REFERENCES

- Cooper, G. (2008), "The Origin of Financial Crises: Central Banks, Credit Bubbles and the Efficient Market Fallacy", Harriman House, Great Britain
- Demyanyk, Y. and Van Hemert, O. (2008), "Understanding the Subprime Mortgage Crisis", working paper 2007-05, Federal Reserve Bank of St. Louis, 19 August
- Ellis, L. (2009), "The Global Financial Crisis: Causes, Consequences and Countermeasures", available at <http://www.rba.gov.au/speeches/2009/sp-so-150409.html> (accessed 25 February 2017)
- Trichet, J.C. (2005), "Asset Price Bubbles and Monetary policy", available at <https://www.ecb.europa.eu/press/key/date/2005/html/sp050608.en.html> (accessed 15 February 2017)

## BANK COMPANY RELATIONSHIPS FOR STRENGTHENING AN INTERNATIONAL COMPETITION. ANALYSIS OF ITALIAN CONTEXT

Giacosa, Elisa<sup>1</sup>; Mazzoleni, Alberto<sup>2</sup>

<sup>1</sup>University of Turin, Department of Management, Turin, Italy

<sup>2</sup>University of Brescia, Department of Business Administration, Brescia, Italy

### ABSTRACT

In the current scenario, a disengagement of the banking system emerges, in addition to a cultural unpreparedness and economic, financial and patrimonial inadequacy of the companies, the presence of regulatory interventions lagging behind the companies' needs and a debt/capital market still underdeveloped in comparison to the potential demand.

Therefore, the objective of the paper is to suggest the Italian small and medium companies which funding resource would be the most appropriate to their particular economic, financial and patrimonial situation.

We referred to Giacosa and Mazzoleni (2016), who proposed a model that classifies the companies according to their profitability, capacity to repay financial debts and a growth.

From the analysis carried out in Italian context, it turned out that around 63% of Italian companies can recourse to the bank loans without problems, while in case of about 37% of companies an access to bank loan as the main source of funding is or will be limited..

It appears a relevance of the issue and necessity, from one hand (in medium-term) to change the management behavior and to try to conquer economic fundamentals consistent with banks' expectations. In the immediate future, the companies should improve to learn about and to use a non-bank financial instruments.

*Keywords: Bank system; small and medium enterprises; Italian context; financial structure*

## GLOBAL BANNING OF A DIFFUSED CONTROVERSIAL PRACTICE: DEINSTITUTIONALIZATION IN THE SOCCER INDUSTRY

Gurses, Kerem<sup>1</sup>; Giones, Ferran<sup>2</sup>; Mehtakumar, Kandarp<sup>3</sup>

<sup>1</sup>Department of Business and Management, LUISS Guido Carli University, Rome, Italy

<sup>2</sup>Mads Clausen Institute, University of Southern Denmark, Sonderborg, Denmark

<sup>3</sup>Department of Entrepreneurship, IESE Business School, Barcelona, Spain

### ABSTRACT

We study the deinstitutionalization of a controversial practice that had previously reached a level of international diffusion. We draw on international diffusion and deinstitutionalization theory to study the emergence and diffusion of the third-party ownership practice in the soccer industry. We use an inductive case study combining archival and interview data to study the determinants of the international diffusion of a controversial practice at a global scale, the contestation, and finally the deinstitutionalization process that resulted from the ban of the practice. We find that the opacity of the practice can be a diffusion driver, locally and at the international level, nevertheless the opacity also may lead to different meaning creation attempts and potential discursive battles between actors, and eventually to deinstitutionalization of the practice. This article advances our understanding of how controversial practices fare in different institutional environments.

### INTRODUCTION

The striker Radamel Falcao of Atletico Madrid, was transferred in 2011 to AS Monaco for a whopping fee of \$70 million. Atletico Madrid, despite being in financial trouble, had acquired Falcao from Oporto FC (Portuguese club) for \$45 million only a year ago, in 2010. How could a financially troubled club like Atletico have acquired the star player that helped them to generate an additional income of \$25 million? As the financial crisis hit Portuguese and Spanish soccer clubs, limiting their options to raise debt to bring in new talent, investment groups stepped in to help the clubs to participate in the lucrative European transfer market. The investment groups used an innovative practice common in Brazil and Argentina. The investor would alleviate the financial strain of the club in exchange of a share of the player's economic rights. The practice, known as Third Party Ownership (TPO) describes the arrangement that allows for a third-party ownership on a professional soccer player. As the practice diffused, it started to raise concerns in some of the soccer institutions in Europe (UEFA) on the possible manipulation by external investors in the fairness of the competitions and the transparency of the transfer market. As a result of a lengthy contestation process, FIFA (top international institution in soccer) instructed a global ban of the practice to take effect in 2015 (FIFA,



2015a). Prior research has explored the fate of institutionally contested new practices such as the one described above (Jung and Mun, 2016; Reinmoeller and Ansari 2016; Sanders and Tuschke, 2007; Briscoe and Murphy, 2012; Davis & Greve, 1997; Fiss, Kennedy, & Davis, 2012). However, much of this work conflates diffusion of these practices and their institutionalization (for exceptions, see Jung and Mun, 2016; Reinmoeller and Ansari 2016) although, recently few authors argued that these processes are analytically separate (Colyvas and Johnson, 2011). In addition, most of these studies shed light on how these practices evolved in a single institutional environment, providing little information on how they may fare in multiple institutional environments. Furthermore, we know very little about how key international constituents interpret and respond to the diffusion of institutionally contested practices due to differences of norms and values in their corresponding international context.

In order to follow the full life cycle of an institutionally contested practice in different institutional environments, we conducted an inductive study (Eisenhardt, 1989) documenting the advent of the third party ownership practice (TPO) in Latin America starting from the 2000s and its subsequent diffusion and deinstitutionalization in Europe in 2015 due to the contestation by key international constituents. To answer our multi-faceted research question, we combined archival documents and 17 interviews with key informants in the soccer industry. Our findings show that institutionally contested innovative practices may diffuse and get institutionalized within their local markets due to the effort of the diffusing actors, however, they may face contestation by other actors and international institutions when they are diffused to international markets, leading to their eventual deinstitutionalization. We uncover the mechanisms of diffusion and deinstitutionalization, and while doing that, we also provide a multi-faceted account of different institutional actors, some supporting, some opposing this practice. Furthermore, we depict that the opaqueness of the practice helped the diffusion process as predicted by the previous literature (Briscoe and Murphy, 2012, Reinmoeller and Ansari, 2016) but the opaqueness also allowed the opposing parties to construct negative interpretations of the practice within the field. The power imbalances between actors generates a hierarchical contestation process, which can lead to the deinstitutionalization of the practice.

Keywords: Deinstitutionalization, institutionalization, international diffusion, controversial practices

## REFERENCES

Briscoe, F., & Murphy, C. 2012. Sleight of Hand? Practice Opacity, Third-party Responses, and the Interorganizational Diffusion of Controversial Practices. *Administrative Science Quarterly*, 57(4): 553–584.

- Colyvas, J. A., & Jonsson, S. 2011. Ubiquity and Legitimacy: Disentangling Diffusion and Institutionalization. *Sociological Theory*, 29(1): 27–53.
- Davis, G. F., & Greve, H. R. 1997. Corporate Elite Networks and Governance Changes in the 1980s. *American Journal of Sociology*, 103(1): 1–37.
- Eisenhardt, K. M. 1989. Building Theories from Case Study Research. *Academy of Management Review*, 14(4): 532–550.
- FIFA. 2015a. Third-party ownership of players' economic rights FIFA's regulatory approach to TPO.
- Fiss, P. C., Kennedy, M. T., & Davis, G. F. 2012. How Golden Parachutes Unfolded: Diffusion and Variation of a Controversial Practice. *Organization Science*, 23(4): 1077–1099.
- Jung, J., & Mun, E. 2017. Does Diffusion Make an Institutionally Contested Practice Legitimate? Shareholder Responses to Downsizing in Japan, 1973–2005. *Organization Studies*.
- Reinmoeller, P., & Ansari, S. 2016. The Persistence of a Stigmatized Practice: A Study of Competitive Intelligence. *British Journal of Management*, 27(1): 116–142.
- Sanders, W. G., & Tuschke, A. 2007. The adoption of institutionally contested Organizational practices: The emergence of stock option pay in Germany. *Academy of Management Journal*, 50(1): 33–56.

## EMERGING-MARKET FIRMS' CROSS-BORDER ACQUISITION COMPLETION: INSTITUTIONAL IMAGE AND STRATEGIES

He, Xinming<sup>1</sup>; Zhang, Jianhong<sup>2</sup>

<sup>1</sup>Durham University Business School, Ushaw College, UK

<sup>2</sup>Nyenrode Business University, The Netherlands

### ABSTRACT

This study investigates the negative effect of the home country's institutional image on emerging-market multinationals' acquisitions, and how they can increase their acquisition completion by overcoming this effect. We propose that their foreign acquisition is more likely to complete if (1) the acquirer has an international footprint - it has inward internationalization experience or it acquires through overseas subsidiaries, and (2) it enters institutionally close markets. Using longitudinal data of 13,259 acquisitions between 1996 and 2012 by firms from ten major emerging economies. We empirically test our hypotheses. The findings have important implications for scholars, policymakers and managers.

*Keywords: emerging-market multinational, institutional image, foreign acquisition completion, country of origin, international footprint, FDI location.*

# CROSS-BORDER MERGER AMONG NORDIC BANKS – A LONGITUDINAL STUDY

Hyder, S. Akmal; Osarenkhoe, Aihie

Department of Business and Economic Studies, Faculty of Education and Business Studies, University of Gävle, Sweden

## ABSTRACT

Researchers have found that even international mergers are popular, they usually fail for its complexity. Recently few studies have tried with process perspective to penetrate into merger integration without much success. We argue that focus on pre- and post-merger stages is good but not enough to provide a total picture of the process. By using a longitudinal approach this study analyzes the establishment, development and consolidation of a cross-border merger between banks from four countries.

Based on theories on strategic motives and culture, a theoretical framework has been developed showing how merger process can lead to better competitiveness and performance. Data has been collected through semi-structured interviews with officials from the merging firms, and secondary materials during 1997-2015. The merger is described in four stages. The first stage deals with the initiation and establishment of the merger. Critical period and cultural clashes are covered in the next stage. The third stage concentrates on the development of synergy. The final stage reflects on how the process has consolidated and what result it has so far achieved.

## EMPIRICAL STUDY

### *Merging stage (1997-2000)*

This is a period when the mergers among the four Nordic banks from Sweden, Finland, Denmark and Norway took place. The founder CEO identified four specific motives: growth; flexibility; increased sales and synergies. When the banks entered they brought with different national and organizational cultures with them. Initially the differences were not perceived as a big issue due to the geographical closeness. But already in the first merger between Finland and Sweden, conflicting issues including language, decision making, organizational structure and implementation of decisions came out. In 1999, the management organized cultural seminars to identify and minimize gaps. With the inclusion of Danish and Norwegian banks, the official language was changed from Swedish to English to facilitate communication.

### *Critical stage (2001-2004)*

Several concrete motives including reduction of cultural and organizational gaps, integration of the diversified activities, delivery of synergies and application of best practices to generate most value for the clients had been set. For this, three issues were found important: (1) one Nordea business model; (2) one way of doing business and (3) developing one Nordea business support system. When internal decision-making started during 2001-2002, it was realized that merging partners had different opinions on decision-making and implementation. Due to national feeling and experience, partners considered their own solutions better than the other. In 2001, a group of executives from the four countries were assigned to identify what unique and successful concepts they had and how they could implement those solutions in the whole organization. Cost for different activities went up quickly and more time was engaged in solving differences.

#### *Development stage (2005 - 2010)*

Situation gradually improved in 2005 and onward due to cost reduction and internal efficiency. By the end of 2007, the number of systems used in Nordea was down to four. Retail banking was an important area of expertise at the Danish partner that came to be widely used elsewhere in Nordea. An effort was made to find ways how to implement a common retail banking system across the Nordic countries. Cultural differences, which were initially painful, made a substantial contribution to realization of synergy in Nordea. Slow Swedish processes speeded up due to pressure from the Finnish side, while the Swedish humanistic view became an important part of management to deal with customers and employees. The critical way of looking at things by the Danes got others thinking about the true complexities of international business and the need to be more cautious to remain competitive. The bank's post-merger activities concentrated on creating more value for the customers than the pre-merger partner banks had offered individually.

#### *Consolidation stage (2011 – 2015)*

The previous country managers had a limited focus. Over time the situation changed as activities were distributed according to functional areas, such as production, IT and business support, HRM, and accounting. All CEOs used different strategies to make the integration process successful without hampering financial position of the bank. The aim was to build one integrated bank. Harmonization and one way of doing things required top management to know how things were done in the four different countries. Having functional cross-border managers also required close contact with managers from other Nordic countries. The previous values – “focus, speed, and performance” – served their purposes, and the new values – “great customer experience, it's all about people, and one

Nordea team" – were introduced to unite the banks under the same umbrella and with the same identity.

## CONCLUSIONS

This study has shown how different banks engage in merger to become a new integrated organization. Although the potential of growth has been high, the process of achieving the goal is difficult. It is found that even cultural differences can play a complementary role if the merging partners work for the same goal and identity. This case suggests that managers must be dynamic and compromising to succeed in a merger of many partners.

*Keywords: strategic motives, national culture, organizational culture, competitiveness, performance, synergy, best practices*

## CUSTOMER RELATIONSHIP MANAGEMENT TECHNOLOGY USE OF SALESPEOPLE

Itani, Omar S.

Department of Hospitality Management & Marketing, Lebanese American University, Beirut, Lebanon

### ABSTRACT

In today's market, business-to-business organizations' are challenged with soaring competition and their success is more and more associated with effective implementation of technology such as CRM technology to support customer-centric and relational-focused business models. With that said, two major concerns are still raised up by B2B selling organizations and their sales forces regarding the use of CRM technology.

First, despite the importance of CRM technology, not all salespeople are using it optimally when deployed by their organizations. Thus, it is important to provide more answers on why salespeople differ in their use of CRM technology? Second, not all organizations and salespeople are convinced with the outcomes of CRM technology. For that, it is of great importance to find different ways to boost CRM technology outcomes. What are some of the managerial strategies that selling organizations can implement to enhance the outcomes of CRM technology used by salespeople? When CRM technology deployed fail, organizations face the possibility of high loss.

The purpose of this study is to address these concerns by developing and testing a model of different antecedents and outcomes of CRM technology. Specifically, the study examines (a) the effects of different orientations of salespeople on CRM technology use, and (b), in turn, the effect of such use on service behavior taking into consideration managerial-specific factors that may moderate the relationship. To test the model, time lagged and multi-sourced data were used. The findings support the relationships hypothesized between relational and transactional orientations, each individually, and CRM technology use. Further, the findings demonstrate that CRM technology use with support of job autonomy do enhance salesperson's service behavior.

*Keywords: Customer Relationship Management (CRM) Technology, Job Autonomy, Salesperson's Orientation, Service Behavior.*

## **TOURIST EXPERIENCE AND VIRTUAL REALITY: THE CASE OF NURAGICA PROJECT**

**Izzo, Filomena<sup>1</sup>; Solinas, Maria Carmela<sup>2</sup>; Pinna, Paolo Alberto<sup>2</sup>**

<sup>1</sup>Economics Department, University of Campania 'Luigi Vanvitelli', Capua, Caserta, Italy

<sup>2</sup>Sardinia Experience

### **ABSTRACT**

Cultural heritage comes alive if it can effectively communicate knowledge and contribute to the cultural development of society. Communication is therefore essential for disseminating knowledge to visitors, especially tourists. In this respect, information technology plays a key role in communicating with consumers in the heritage sector, offering a wide variety of channels through which information can be provided. In recent years, technological innovations capable of improving the level and quality of visitors' interactions with heritage, such as Virtual Reality (VR), have increased.

A recent survey on strategies implemented in major museums worldwide with regard to the digitization process, the use of these instruments and the reassessment of websites carried out by Axiell in 2016 for the Museums and the Web Conference shows that the use of integrated ICT applications had a significant impact on the public: 48% of the museums saw an increase in physical visits, 50% saw an increase in the number of visits to their websites, and 82.3% of the museums recorded an increase of social media visitors.

In this context, this paper describes the case of Nuragica Project, it is a joint project between Olbia Archaeological Museum, Sardinia Experience Company and different municipalities of Sardinia.

The paper takes an in-depth look at the opportunities provided by new information technologies to enhance the cultural heritage experience. In particular, the article examines information and communication technology (ICT) opportunities for museums, which can leverage these technologies to 'break free' and improve the accessibility and communication of their collections and exhibitions, establishing a more intense dialogue with the visitor (Cataldo, 2011; Cataldo & Paraventi, 2007; Hazan, 2011; Izzo, Mustilli, & Guida, 2015; Solima, 2014; Izzo, 2017a,b,c; Izzo & Deva, 2016). ICT enables the expansion of the customer base, complementing traditional cultural institutions in the performance of their educational duties and learning with new forms of active and participatory learning by the community. From this perspective, due attention is given to visitors' needs and expectations.

*Keywords: tourism, visitor experience, museum, cultural heritage, virtual reality, technology, experiential marketing, innovation, communication, Nuragica Project*



## REFERENCES

- Cataldo, L. (2011). *Dal Museum Theatre al Digital Storytelling. Nuove forme della comunicazione museale fra teatro, multimedialità e narrazione*. Milano: Franco Angeli.
- Cataldo, L., & Paraventi, M. (2007). *Il museo oggi. Linee guida per una museologia contemporanea*. Milano: Hoepli
- Hazan, S. (2011). The museum in the palm of your hand: Presenting the Israel museum through ICT. *Il Capitale Culturale*, 3,11–23.
- Izzo, F. (2017a). Gaming and Museum. *Journal of US-China Public Administration*, vol. 14, n.1, pp.57-67
- Izzo, F. (2017b). *Musei e tecnologie: valorizzare il passato per costruire il futuro*. Cedam: Milano.
- Izzo, F. (2017c). Museum Customer Experience and Virtual Reality: H. Bosch Exhibition Case Study. *Modern Economy*, n. 8, pp. 531-536.
- Izzo, F., Deva S. (2016). Experience in cultural tourism, the role of digital technology: the case of ArtTripper Uffizi Game Guide. *Book of Abstracts Consumer Behavior in Tourism Symposium 2016 Experiences, Emotions and Memories: New Directions in Tourism Research*. S. Volo & O. Maurer (Eds) Competence Centre in Tourism Management and Tourism Economics (TOMTE) School of Economics and Management, Free University of Bozen, Bruneck, Italy.
- Izzo, F., Mustilli, M., & Guida, M. (2015). *Realtà aumentata e valorizzazione dei beni culturali. Riflessioni sull'offerta culturale casertana*. Paper presented at the Sinergie Annual Conference, Termoli, July.
- Solima, L. (2014). Digital resources and approaches adopted by user-centred museums: The growing impact of the internet and social media. In L. Aiello (Ed.), *Management of cultural products: E-relationship marketing and accessibility perspective* (pp. 181–199). London: IGI Global.

## **PROJECTIFICATION OF THE NON-GOVERNMENTAL SECTOR IN POLAND**

**Jałocha, Beata; Bogacz-Wojtanowska, Ewa**

Faculty of Management and Social Communication, Jagiellonian University, Kraków, Poland

### **ABSTRACT**

### **INTRODUCTION**

Project management is one of the main forms of executing activities by non-governmental organisations (NGOs) and it has been used by them for many years (Lindenberg, 2001). The consequence of the widespread use of projects as the main method of implementation of the tasks is called projectification. This paper aims to contribute to the research on NGO sector projectification. The focus is set on the impact of projectification on working conditions in NGOs. This article is a part of a wider research project that deals with the issues of projectification in non-governmental sector. So far, partial results of the above mentioned research, which concerned the processes of projectification in social enterprises have been published (XXX, 2016). Next, we want to focus on investigating the phenomenon of projectification in various types of non-governmental organizations.

### **PROJECT MANAGEMENT IN NON-GOVERNMENTAL SECTOR**

Due to the distinctness of objectives of non governmental organizations and the plurality of stakeholders, projects conducted in the third sector are very diverse. However, professionalization of third sector entities in general, causes that many of them start acting like companies in regard to their managerial practices. This means that they adapt a range of business tools, including professional project management. Being very diverse, NGOs are also distinctive with regard to what standards, methods and techniques of project management they adopt as optimal. Even within one NGO various project management standards may appear – this may depend on client's requirements or expectations of external funding organisations. It is similar with project management instruments and techniques – some of them are more frequently and willingly used than others (Golini et al, 2015). Regardless of the project management maturity of an NGO, project management is not a solution to all the problems of management in the third sector organization. Projects tend to be increasingly criticized due to the fact that they e.g. limit planning of long-term goals of the organization, because managers are too focused on achieving short-term tasks and project indicators. In addition, as the experience of the of practitioners shows (Banaszak, 2015), projects can destructively affect the working conditions of employees in the third sector.

## **PHENOMENON OF PROJECTIFICATION**

Projectification is an issue more and more often subjected to scientific reflection (Midler, 1995; Packendorff & Lindgren, 2014). The most popular definition of this phenomenon says that, it is a process related with execution of an increasing number of tasks in a form of projects replacing long-term, repeatable activities. The presence of projectification had been at the beginning noticed at an organisation level, however, it soon turned out that it also applies to individuals and whole societies. Beside the general admiration of project work, it is not only about flexibility and freedom - on the contrary, it may bring a series of negative consequences for the people involved in it.

## **PROJECTIFICATION'S IMPACT ON POLISH NON-GOVERNMENTAL SECTOR AND PEOPLE INVOLVED IN ITS ACTIVITIES**

Projects are crucial for most non governmental organizations in Poland. We can observe a variety of indications which confirm projectification of this sector, e.g.: in case of Polish NGOs, more than 60% of their funding comes from the public sector. It means that all these money must be spent in the form of projects, because this is the only way public funding can be transferred to third sector (Adamiak et al, 2015). Majority of new jobs in the third sector is offered through projects, especially in recent years within the EU framework funding. One of the consequences of the dominance of project work in this sector is the lack of stability of employment. It manifests itself, among others, by prevalence of short term employment contracts over the contracts for an indefinite period. According to data, in 2008, the NGO sector in Poland employed about 71 thousand employees (Zielińska, 2012). However, the most popular forms of the job contracts in Polish NGOs are part time job contracts and new jobs are created mostly for the needs of projects. It means that majority of NGOs paid employees are hired only if the organization receives project funding and lack stable, continuous employment. Temporary employment for the period of projects is characterised by a limited time of employment and a specific relationship between the employee and the employer. Usually NGO employee does not take advantage of the terms of employment according to the same rules as in the case of persons who have permanent job contacts. Conditions characterizing the work of the precariat class to which temporary project workers are subject in the non governmental sector include also low remuneration, the lack of protection against the ceasing of employment and lack of access to welfare. This may cause that they became a part of the new class – projectariat (Banasiak, 2015; Szreder, 2016).

## **CONCLUSION AND FURTHER RESEARCH**

Projectification pervades all areas of organisational activities and surely has an impact on non-governmental sector and social NGOs operating therein, predominantly, by introducing a manner of distributing financial resources for development thereof through projects. Observation of pathological phenomena, such as the emergence of projectariat, is therefore extremely important. However, generally agreeing that projectification has plenty of negative effects, our previous research conducted in third sector also enables us to conclude that we still find organisations that benefit from this process and, at the same time, do not subject completely to negative effects thereof. Widespread projectification is therefore an ambiguous phenomenon, carrying not only positive but also negative effects. Hence, it is hard to unequivocally consider it as a pathological phenomenon, and at the same time one can not state that it has only positive dimension. To counter the pathological changes, phenomenon of projectification should be carefully identified through research. Although we can identify examples of research project work on NGOs or critical success factors of non-governmental projects, there is a research gap which we would like to address in further research project: very limited research on projectification of the non-governmental sector in Poland.

*Keywords: projectification, NGO, Polish NGO, projectification of NGOs*

## REFERENCES

- Adamiak, P., Charycka, B., Gumkowska, M. (2015), *Polskie organizacje pozarządowe*, Warszawa: Stowarzzenie Klon/Jawor.
- Banaszak, A. (2015), „Projektariat ma dość!”, NN6T Pismo postentuzjastyczne, <http://notesna6tygodni.pl/?q=projektariat-ma-do%C5%9B%C4%87> (accessed: 10 February 2016).
- XXX. (2016)
- Golini, R., Kalchschmidt, M., & Landoni, P. (2015), “Adoption of project management practices : The impact on international development projects of non-governmental organizations”, *International Journal of Project Management*, 33(3): 650-663.
- Lindenberg, M. (2001), “Are We at the Cutting Edge or the Blunt Edge? Improving NGO Organizational Performance with Private and Public Sector Strategic Management Frameworks”, *Nonprofit Management and Leadership*, 11(3): 247-270.
- Midler, C. “Projectification” of the Firm: The Renault Case, *Scandinavian Journal of Management* 1995; 11(4): 363-375.
- Packendorff, J., & Lindgren, M. “Projectification And Its Consequences : Narrow And Broad Conceptualisations”, *South African Journal of Economic and Management Sciences*, 2014; 17(17): 7-21.
- Szreder K., (2016), *ABC projektariatu. O nędzy projektowego życia*, Fundacja Bęc Zmiana, Warszawa.
- Zielińska, A. (2012), „Zarządzanie personelem w organizacjach pozarządowych z polski południowo-wschodniej”, *Zeszyty naukowe Politechniki Rzeszowskiej* nr 285(3/2012), 137-143.

**EMERGING MARKET MULTINATIONALS FROM LATIN AMERICA:  
ANALYZING THE INTERNATIONALIZATION PATTERNS AND M&AS  
CORPORATE STRATEGIES OF MEXICO'S LARGEST COMPANIES.**

**Jarque, Eduardo**

Japan Center for Latin American Studies (JCLAS), Fukuoka, Japan

**ABSTRACT**

In the past decade, multinationals from emerging market economies –the so called emerging-market multinational enterprises (EMNEs)– have taken an important role in the global economy (Ramamurti and Singh, 2009a); (Jarque, 2011); (Yaprak and Karademir, 2011). Understanding the way they emerge, grow and generate advantages to compete and succeed in domestic markets first and then internationalize (or the other way around, in some peculiar cases) has been of particular interest of scholars, since the generally accepted wisdom on traditional western multinational enterprises (MNEs) seems not to be useful to explain the phenomena of such successful global-firm players from the emerging world (Ramamurti and Singh, 2009b).<sup>1</sup> Utilizing a unique data set based on companies' annual reports and local leading financial publications; data from privatization of state-controlled enterprises; world merger and acquisitions (M&As) and financial data from the Mexican (BMV) and New York (NYSE) stock exchanges, this paper studies and compares the major internationalization patterns of M&As of Mexico's 2 largest, yet contrastingly different companies, world class leading firms in their respective industries (Mobile telephony and cement production) in perspective with the rest of the largest 20 indigenous business groups in Mexico over a 22-year period concluded in 2010. The companies analyzed here have become "emerging giants" competing at home (Ramamurti and Singh, 2009a). These companies, after establishing a dominate position in their home countries, have been able to access international capital markets and technology by making a series of strategic acquisitions (documented here) that allowed them to consolidate their respective industries regionally (in Latin America), and to become important world players.

---

<sup>1</sup> In line with the international business literature, we mean by western MNEs such multinational enterprises from Western Europe, USA, and, in this context, MNEs from Japan.

Table 1. Comparative Analysis of America Movil and Cemex

	America Movil	Cemex
Industry	Mobile Telephony	Cement
National Ranking (Mexico) Sales among all Companies, 2010	1	3
Ranking of Mexican Companies in terms of Sales <sup>1</sup>	1	2
Regional Ranking (Latin America)	1	1
World Ranking (in its industry)	3	4
Market Share in Mexico, 2011	53%	71%
World Presence (number of countries) :		
Latin America	16	8
USA	1	1
Europe	1	12
Southeast Asia	-	3
United Arab Emirates	-	1
Egypt	-	1
Total Sales/Mexico's GDP ratio (2009)	6.84%	1.66%
Total Sales/Mexico's GNI ratio (2009)	6.95%	1.68%
Listed in Stock Exchanges	Mexico, NY	Mexico, NY
Firm's Market Value/Total Market ratio (BMV) 2011		
Year of internationalization	1998	1989
Location of First Exports	Latin America	USA
Location of first FDI	Latin America	Spain
Foreign Revenues/Domestic Revenues ratio (in 2009)		
Average annual growth rate, Total sales 2000-2009	34.5%	19.5%
Average annual growth rate, International sales 2000-2009	64.8%	30.7%
Acquired Companies (Domestic and Foreign)		
1995-2000	1	-
2001-2005	27	2
2006-2012	29	7
Date of creation	1990	1906
Generation of the major Stock holder	1	3

Figure 1. International Revenues of the largest EMNEs from Mexico 1989-2009 (in millions of USD)

<sup>1</sup> Walmart de Mexico, the subsidiary in Mexico of the retailer Walmart, Inc. is the second largest company in terms of sales (again, excluding the Mexican state-controlled petroleum company, PEMEX).

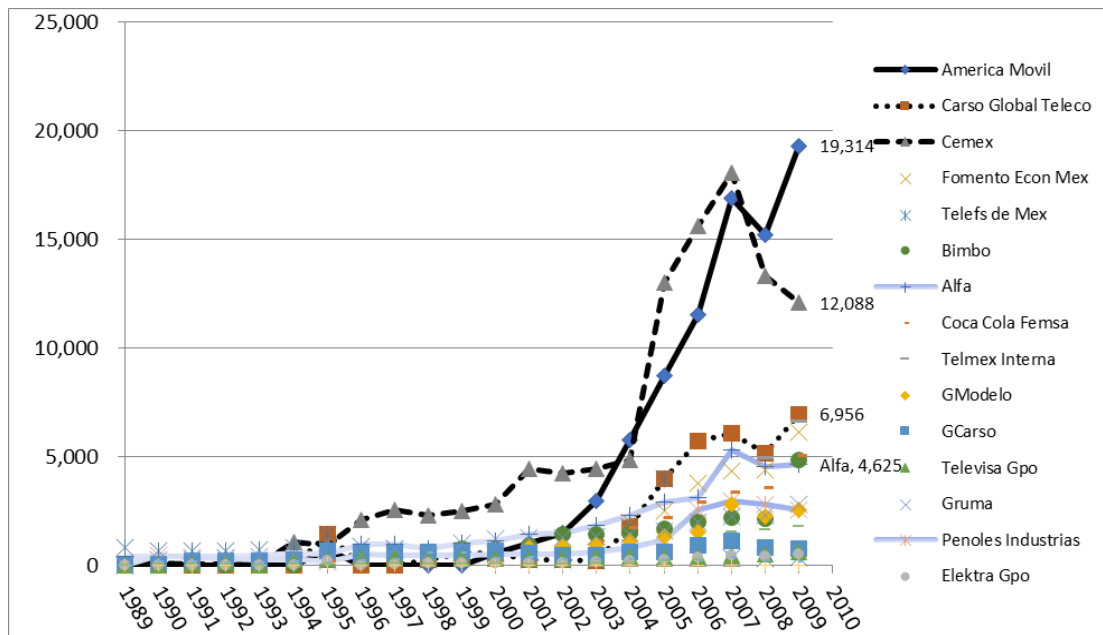

Data Sources: Companies financial reports, various years, Mexican Stock Exchange (BMV)

Figure 2. Acquisitions by Mexico’s largest EMNEs 1999-2011 (in millions of USD)

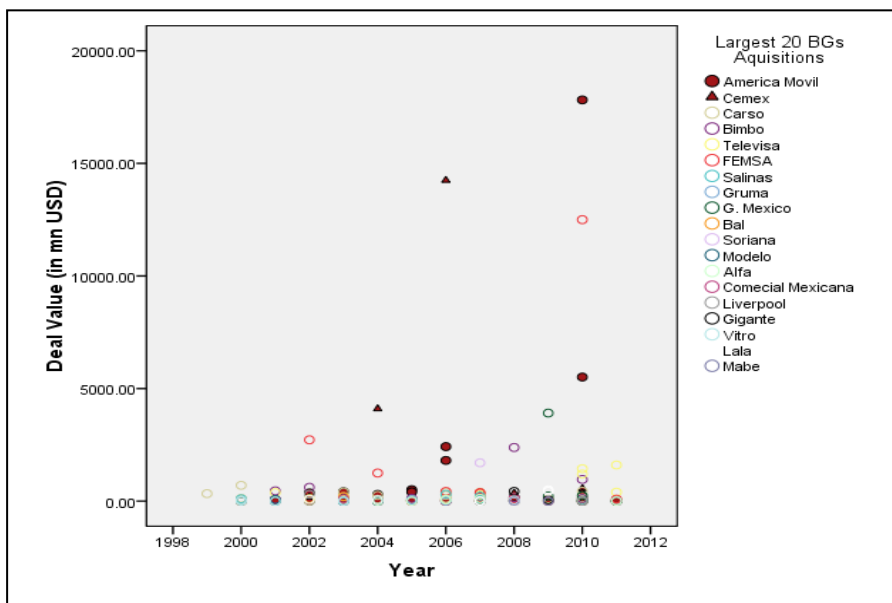

Data Sources: EMIS data base on M&As in emerging markets 1998-2011

Keywords: EMNEs, Latin America, M&As, Corporate Strategy

**REFERENCES**

JARQUE, E. Domestic Business Groups, Emerging Multinationals and Economic Development: An Overview of Mexico’s Largest Firms Over Time. 3rd International Journal of Arts and Sciences Conference, 2011 Boston, M.A.: International Journal of Arts and Sciences.  
 RAMAMURTI, R. & SINGH, J. V. 2009a. Emerging Multinationals in Emerging Markets, Cambridge and New York, Cambridge University Press.

- RAMAMURTI, R. & SINGH, J. V. 2009b. Why Study Emerging-Market Multinationals? Emerging Multinationals in Emerging Markets. Cambridge and New York: Cambridge University Press.
- YAPRAK, A. & KARADEMIR, B. 2011. Emerging Market Multinationals' Role in Facilitating Developed Country Multinationals' Regional Expansion: A Critical Review of the Literature and Turkish MNC Examples. *Journal of World Business*, 46, 438-446.



## AN INVESTIGATION OF WAITERS' OCCUPATIONAL IDENTITY (WOI): A LITERATURE REVIEW AND CONCEPTUAL FRAMEWORK

Jerez, M.J. ; Melewar, TC; Foroudi, P.; Stylidis, D.

The Business School, Middlesex University, London, UK;

### ABSTRACT

The creation of occupational identity includes mending, developing, reinforcing, preserving or reviewing current identities (Ashforth and Schinoff, 2016; Cameron and Spreitzer, 2011; Costas and Fleming, 2009; Snow and Anderson, 1987). Consequently, instead of considering the formation of identity as a simple procedure of embracing a work position, occupational identity is an interactive and problematic procedure (Pratt *et al.*, 2006). Most research has either focused on the merely operational qualities of worker's jobs, and has not considered waiting as a sub-sector in its own right (Fine, 1996; Newkey-Burden, 2009; Paules, 1991; Sehkara and Sevcikova, 2011; Sukhu *et al.*, 2017; Ukandu and Ukpere, 2011;). However, this research will provide an emphasis on waiters' sense of self and their identity in the place of work.

The suggested research conceptual framework investigates waiters' occupational identity, its antecedents (interaction, interferences, self-concept, authenticity, employer branding, inter-groups and stereotyping) and how this relationship, between antecedents and occupational identity, influences work engagement and employee turnover. Salience is used as a moderator of this relationship, to simplify the meaning of the stimuli (Figure 1).

**Figure 1: Research conceptual framework**

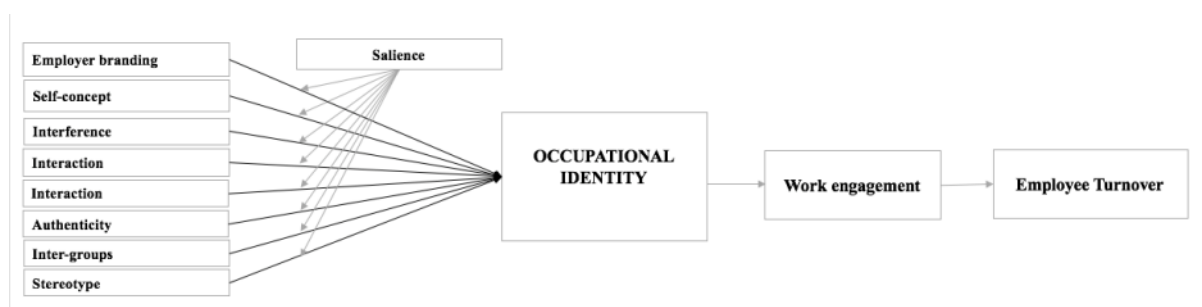

Source: Developed by the Researcher

The complication of the 'occupational identity' relationship between individuals and aspects of the social environment of the restaurant, strengthens the case for the use of mixed methodologies, where qualitative and quantitative methodologies are used concurrently to gather waiters' knowledge and to identify individuals' perceptions, unencumbered by "what we expect to find or what we have read in

the literature" (Creswell, 2013, p.48; Wild *et al.*, 2017). This is an argument that has given limited consideration to date (Nelson and Irwin, 2014). When it is essential to explain what establishes a phenomenon, qualitative methodology is more appropriate (Carson *et al.*, 2001; Khan, 2014). Focus groups will involve discussions with crucial participants, such as managers of marketing and human resources restaurant departments, as well as hospitality lecturers. Semi-structured in-depth face-to-face interviews will be managed including waiters as participants, who originate from Michelin-starred restaurants in London. These two approaches will contribute to the study of waiters' sense of self and in comprehending how waiters construct their own authenticity on the basis of an individual framework influenced by its antecedents.

Nevertheless, the main research technique in this investigation is the survey as the quantitative method, which will be guided to test the research hypotheses and the designed conceptual model; for this, a questionnaire will be distributed among waiters. The combination of quantitative and qualitative approaches might, therefore, contribute a richer scenario regarding the process of identity construction and the work environment of waiters, by obtaining the feelings and thoughts from waiters about their own work, as well as trustworthy and accurate data from the participants (Malhotra *et al.*, 2012).

The present study is significant because the importance of perceptions, such as identity and knowledge for forming specific job roles, is still under-examined in specific situations. Managers need to work with and understand the individual framework of waiters' innate in job roles because these have an influence upon principal interests, such as work engagement and turnover of waiting employees. The result of this research will contribute to the academic body of understanding for scholars, by examining the role of work in identity construction of waiters. This research endeavours to address the research gaps, particularly in the field of occupational identity construction (Jung, 2010; Loncaric, 1991; Van der Zee *et al.*, 2004; Walsh and Gordon, 2008). Moreover, this study will evaluate and present a model which defines the relationship between the constructs of occupational identity, the characteristics that influence occupational identity and its consequences.

The outcome of this research can contribute effectively when working with government policymakers to develop what is called 'working futures', a regularly updated forecast of skills in the UK labour market (Warhurst, 2017). With regard to possible managerial implications, one of the influences of employee turnover and work engagement is the negative judgement that society has of working in restaurants in the UK (Wildes, 2005). A possible solution within the research can be gained with the formation of an agentic role on the construction of occupational identities; this will provide the right characteristic model in order to maintain the principal abilities of an occupational identity intergroup.

Occupational identity is suitable to many significant areas in the restaurant sector, such as the quality of service delivered, which is a feature of massive competitive benefit in today's global market. Also, as some waiting staff are against globalisation and homogenisation (Cameron, 2001; Palmer, 2010), by recognising standardisation of the brand and the attractiveness of job authenticity, some potential outcomes can be offered.

*Keywords - Occupational identity, work engagement, employee turnover, waiters.*

## REFERENCES

- Ashforth, B. E. and Schinoff B. (2016). Identity under construction: How individuals come to define themselves in organisation. *Annual review of organisational psychology and organisational behaviour*, 3, 11-137.
- Cameron, D. (2001). Chefs and occupational culture in a hotel chain: a grid-group analysis. *Tourism and Hospitality Research*, 3(2), 103-114.
- Cameron, K.S. and Spreitzer, G.M. (2011). *The Oxford handbook of positive organizational scholarship*. New York: Oxford University Press.
- Costas, J. and P. Fleming (2009). Beyond dis-identification: A discursive approach to self-alienation in contemporary organizations. *Human Relations*, 62(3), 353-378.
- Fine, G. A. (1996). *Kitchens the Culture of Restaurant Work*. Berkeley, CA: University of California Press.
- Jung, B. F. (2010). *The Professional Master's Occupational Therapist: Developing an Emerging Professional Identity*. London: The University of Western Ontario.
- Khan, S. (2014). Qualitative research method – Phenomenology. *Asian social science*, 10(21) 298.
- Loncaric, M. A. (1991). Self-concept, occupational aspiration, and ego identity: a correlational study. Vancouver: University of British Columbia.
- Malhotra, N. K., Lee, O. and Uslay, C. (2012). Mind the gap: The mediating role of mindful marketing between market and quality orientations, their interaction, and consequences. *International Journal of Quality and Reliability Management*, 29 (6), 607-625
- Newkey-Burden, C. (2009). *Heston Blumenthal: The biography of the world's Most Brilliant Master Chef*. London: John Blake Publishing Ltd.
- Paules, G. F. (1991). *Dishing it out: Power and resistance among Waitresses in a New Jersey Restaurant*. Philadelphia PE: Temple University Press.
- Palmer, C.A., Cooper, J. and Burns, P.M. (2010). Culture, identity, and belonging in the 'culinary underbelly'. *International Journal of Culture*, 4(4), 311-326.
- Pratt, M. G., Rockmann, K.W. and Kaufmann, J.B. (2006). Constructing professional identity: The role of work and identity learning cycles in the customization of identity among medical residents. *Academy of Management Journal*, 49(2), 235-262.
- Sehkaran, S. N. and Sevcikova, D. (2011). 'All aboard': Motivating service employees on cruise ships. *Journal of Hospitality and Tourism Management*, 18(1), 70-78.
- Snow, D. and Anderson, L. (1987). Identity Work among homeless: the verbal construction and avowal of personal identities. *American Journal of Sociology*, 92(6), 1336-1371.
- Sukhu, A., Bilgihan, A. and Seo, S. (2017). Willingness to pay in negative restaurant service encounters. *International journal of hospitality management*, 65, 11-19.
- Ukandu, N.E. and Ukpere, W.I. (2011). *The Causes of Low Employee Motivation within Cape Town's fast food industry*. Cape Peninsula: University of Technology, Cape Town.
- Van der Zee, K., Atsma, N. and Brodbeck, F. (2004). The influence of social identity and personality on outcomes of cultural diversity in teams. *Journal of Cross-Cultural Psychology*, 35, 283-303.
- Walsh, K. and Gordon, J. (2008). Creating an individual work identity. *Human Resource Management Review*, 18(1), 46-61.
- Warhurst, C. (2017). How academics can work more effectively with government, <https://foresightprojects.blog.gov.uk/2017/02/07/how-academics-can-work-more-effectively-with-government> (Accessed 14 July 2017).

- Wildes, V. J. (2005). Stigma in food service work: How it affects restaurant servers' intention to stay in the business or recommend a job to another. *T&H Research*, 5(3), 213-233.
- Wild, D., Whiteman, B., Biggerstaff, D., McCarthy, K. and Szczepura, A. (2017). Qualitative research approaches used in UK nursing studies: An overview with examples. *Medicalfinder*. 50(3), 254-262.

## CYPRUS AND THE U.K.: DELIVERING NUTRITIONAL ADVICE SERVICES THROUGH DIGITAL TECHNOLOGY

Kakouri, Stella K.<sup>1</sup>, Scott, Peter<sup>2</sup> and Scott, Tamsin<sup>3</sup>

<sup>1</sup>Alasia Medical Centre, Nicosia, Cyprus

<sup>2</sup>School of Education, Leisure and Sport Studies, Liverpool John Moores University, Liverpool, U.K.

<sup>3</sup>AppLearn Ltd., Manchester, U.K.

### ABSTRACT

This extended abstract summarises a research proposal which aims to investigate a potential move into the international delivery of specialist nutritional advice on behalf of a consortium of independent nutritionists based in Cyprus.

The consortium operates out of a medical centre based in Nicosia, Cyprus. The nutritionists who are organised into the consortium are well qualified and experienced in their professional field and they offer specialisms within the general area of nutrition but they are confronted by a degree of market saturation for nutritional advice services in Cyprus. One logical response to this situation might be to extend the service into the international market through the use of digital technology. Such a service could be delivered on an individual basis via Skype or similar platforms.

As the consortium members are fluent in Greek and English opportunities may exist in market expansion into Greece and the United Kingdom (U.K.). The purpose of this particular research project is to undertake exploratory research into the potential U.K. market for Cyprus based nutritional advice.

The research question is, 'To investigate the potential for the delivery of nutritional advice via digital technology between Cyprus and the U.K.'

The proposed research can be termed marketing research as it is intended to inform business development.

A mixed method approach will be adopted involving questionnaires and a small number of online interviews. The approach will derive from the interpretivist tradition and will be broadly inductive in nature as such an approach is consistent with the use of a mixed-method approach (Saunders, Lewis and Thornhill, 2016). The proposed research can aptly be termed applied research (Easterby-Smith et al, 2012).

A report by the Health and Social Care Information Centre ([content.digital.nhs.uk](http://content.digital.nhs.uk)) states that obesity is a major public health problem in the U.K. due to its association with type 2 diabetes, hypertension and hyperlipidaemia which are all serious chronic diseases. The document reports that in 2014, 58% of women and 65% of men were overweight or obese in England. Poor diet and nutrition have been

recognised as major risk factors for ill health and premature death ([content.digital.nhs.uk](http://content.digital.nhs.uk)). This suggests that there is a compelling need for appropriate nutritional advice in England and the U.K.

Exactly comparable data from Cyprus is not available but according to the World Health Organization, estimates suggest that in 2008, 58.8% of the population was overweight and 25.5% were obese ([euro.who.int](http://euro.who.int)). The prevalence of being overweight was higher amongst Cypriot men at 66% than amongst Cypriot women at 52.1%.

These figures suggest that although the prevalence of being overweight or obese may be lower in Cyprus than in the U.K. (given that directly comparable figures are not available from the same year), nutritionists in Cyprus are likely to have experience of treating consultees facing similar challenges to those in the U.K.

Accurate comparative figures for the number of practising nutritionists and dieticians in the U.K. and Cyprus are also difficult to obtain. The London based Association for Nutrition, which is the custodian of a voluntary register of Registered Nutritionists and Registered Associate Nutritionists listed some 1970 registrants at the time of writing although some 10% of this number are thought to be overseas practitioners ([associationfornutrition.org](http://associationfornutrition.org)). The Association of UK Dieticians has 9,000 members ([bda.uk.com](http://bda.uk.com)). There are thought to be 500 nutritionists and dieticians in Cyprus but not all of these are registered with the appropriate body. The U.K. population numbered approximately 65 million in 2015 ([ons.gov.uk](http://ons.gov.uk)). By contrast the population of the Republic of Cyprus was approximately 848,000 in 2015 ([cyprusprofile.com](http://cyprusprofile.com)). Even allowing for considerable error these figures suggest that there are many more nutritionists and dieticians per head of population in Cyprus than there are in the U.K.

Cyprus is associated with the Mediterranean diet which has been linked with good health and a healthier heart ([nhs.uk](http://nhs.uk)). Cyprus based informed nutritional advice related to the Mediterranean diet could offer valuable health and other benefits to U.K. nationals and this research seeks to investigate whether there is a demand for such a service.

The research will utilise both primary and secondary sources. Secondary research will draw upon resources such as Mintel and Keynote which are both collections of market research information.

Niche marketing is an appropriate strategy for smaller organisations entering into international markets and several U.K. market segments may be worthy of investigation. These are Cypriot nationals living in the UK or those of Cypriot origin, people who have holidayed in Cyprus or who intend to holiday in Cyprus and young professionals in demanding jobs seeking nutritional advice on what kind of food to eat to reduce tiredness and increase work performance.

Another segment which may have an interest in pertinent nutritional advice is U.K couples planning to marry in Cyprus. The U.K. has witnessed dramatic growth in the number of couples who elect to marry abroad and Cyprus is a key destination for overseas marriages.

A 2013 survey by Liverpool Victoria (lv.com), the U.K.'s largest friendly society and a leading financial mutual organisation, reported that one in six British weddings now take place abroad. The survey found that 280,000 people had married abroad in the previous five years and that this represented a 20% growth rate over the previous decade. Cyprus was the fourth most popular destination for an overseas wedding after the U.S.A., Spain and Italy. The survey established that 3.7 million Britons (8% of the total population) had attended a wedding abroad in the previous 5 years and a further 11% had received an invitation to a future wedding. Overseas weddings tend to cost less than those conducted in the U.K. although the cost to wedding guests may be considerably greater. However a recent fall in the value of sterling versus the U.S. dollar and the euro may have impacted on the number of destination weddings.

Opportunities to add value to the nutritional advice service could be offered through packages which allowed couples (and/or their guests) to gain hands-on experience in the preparation of traditional Cypriot foods in atmospheric environments.

The proposed service delivery mechanism (Skype or similar) is likely to appeal to those who are comfortable with this technology.

Those who grew up with digital technology are known as 'digital natives' and those adults who have adopted new technologies as they have emerged are known as 'digital immigrants' (Prensky 2001, cited in Colbert, Yee and George, 2016). Both these groups are heavy users of technology and they are increasingly au fait with emerging technology and reliant on what it can deliver. Very large numbers of digital natives and digital immigrants are present in the U.K. and these groups are likely to be receptive to real-time communication platforms which permit consultations across international borders.

Facebook Business will be used to survey samples of the identified target audiences initially through the use of an online questionnaire. By using Facebook Business it will be possible to segment the audience by location, demographics, interests (based on the interests, hobbies and pages they 'like' on Facebook). Other information may be drawn from the samples' interests, activities, education and job titles, from their online purchasing behaviour, device usage and other activities. For instance, partner categories such as 'health and fitness', 'destinations' and 'weddings' could be selected under behaviours. It will then be possible to overlay additional targeting options such as men or women aged between 20 and 40 years of age.

Using this approach it should be possible to assess demand for an international nutritional advice service with some accuracy. In addition to asking questions designed to assess demand for the service the questionnaire will also seek to gauge attitudes towards remote face-to-face nutritional consultations. Once the preliminary data has been obtained the intention is to conduct semi-structured online interviews with a small purposive sample of informed individuals in the U.K. In parallel with the online research a series of nutritional consultations will also be carried out with a U.K. resident via Skype as a pilot study.

The research is expected to contribute principally to practice but it may also contribute in developing theory related to the entry of micro and small businesses into international markets.

*Keywords: Cyprus; United Kingdom; Nutritional, Digital; International Marketing; Mediterranean Diet*

## REFERENCES

- Association for Nutrition. Search the Register. Available at: <http://www.associationfornutrition.org/Default.aspx?tabid=92> [Accessed 7th June 2017]
- Association of UK Dieticians Journalist Information. Available at: [https://www.bda.uk.com/media/journalist\\_information](https://www.bda.uk.com/media/journalist_information) [Accessed 7th June 2017]
- Colbert, A., Yee, N., & George, G. (2016). The Digital Workforce and the Workplace of the Future. *Academy of Management Journal* (online) 59 (3) pp. 731-739. Available at: <http://eds.a.ebscohost.com/eds/pdfviewer/pdfviewer?vid=1&sid=74c4e66d-b07c-4019-bcfd-25104b3ca638%40sessionmgr4009&hid=4108> [Accessed 7th June 2017].
- Cyprus Profile. Cyprus at a glance. Available at: <http://www.cyprusprofile.com/en/country-information/at-a-glance> [Accessed 7th June 2017]
- Easterby-Smith, M. Thorpe, R., Jackson, P. and Lowe, A. (2012) *Management Research* 4th ed. London: Sage
- Health and Social Care Information Centre (2016) *Statistics on Obesity, Physical Activity and Diet, England 2016*. Available at: <http://content.digital.nhs.uk/catalogue/PUB20562/obes-phys-acti-diet-eng-2016-rep.pdf> {Accessed 7th June 2017}
- Liverpool Victoria (2013) One in six British weddings now take place abroad [online] 30th May 2013 Available at: <https://www.lv.com/about-us/press/article/weddings-abroad> [Accessed 7th June 2017]
- NHS Choices (2015) What is a Mediterranean diet? Available at: <http://www.nhs.uk/Livewell/Goodfood/Pages/what-is-a-Mediterranean-diet.aspx> [Accessed 7th June 2017]
- Office of National Statistics (2017) Overview of the UK population: March 2017. Available at: <https://www.ons.gov.uk> {Accessed 7th June 2017}
- Saunders, M. Lewis, P. and Thornhill, A. (2016) *Research Methods for Business Students* 7th ed. Harlow: Pearson Education Ltd.
- World Health Organization (2013) *Nutrition, Physical Activity and Obesity, Cyprus*. Available at: [http://www.euro.who.int/\\_data/assets/pdf\\_file/0004/243292/Cyprus-WHO-Country-Profile.pdf](http://www.euro.who.int/_data/assets/pdf_file/0004/243292/Cyprus-WHO-Country-Profile.pdf) [Accessed 7th June 2017]





# THE IMPACT OF SOCIAL MEDIA BRAND COMMUNICATION ON BRAND EQUITY FOR YOUNG CONSUMERS: INTERNATIONAL HIGH STREET FASHION BRANDING IN CHINA

Kan, Yuna; Dennis, Charles; Melewar, TC; Forouzi, Pantea

Department of Marketing, Branding and Tourism, Business School, Middlesex University, London, UK

## ABSTRACT

Due to the intense competition in the marketplace, nowadays, customers are exposed to numerous brands from across the world, and, therefore, building brand equity has become an important source of differentiation. Although research has demonstrated that marketing communication has a positive impact on brand equity, previous studies concerning the relationship between marketing communications and brand equity mainly focused on the traditional instruments of marketing communications, and only a few focussed on social media platforms (e.g. Schivinski and Dabrowski, 2015). Thus, identifying the relationship between this new means of communication and brand equity is vital. Social media offers an opportunity for consumers to talk to hundreds or even thousands of other consumers around the world, and, hence, is changing the traditional marketing communication as companies are no longer the sole source of brand communication. Therefore, some academic research has been conducted to differentiate between firm-generated and user-generated social media brand communication and examined the impact of these two forms of social media communication (e.g. Bruhn et al., 2012). These studies, however, consider firm-generated and user-generated social media brand communication as separate independent variables, whereas, in fact, firm-generated social media communication has a certain ability to influence consumer-to-consumer communications. Hence, it is crucial to investigate the co-creation of user-generated and firm-generated social media brand communication.

Moreover, for the past decade, China has become the focus of considerable business activities and has been receiving growing attention from academics and researchers. With the growing trend of globalisation and the progressive opening of China as a market, multinational corporations have entered China with increasing regularity, thereby bringing their brands and products to increasingly brand-conscious Chinese consumers. This is particularly so for young adult consumers, as, in China, young adult consumers have a higher propensity to spend (Stanat, 2006) with an increasing focus on fashion and brands (McEwen et al., 2006). Therefore, understanding the behaviour is crucial for businesses targeting this young adult consumer segment.

Accordingly, the objective of this study is to examine the relationships between the social media brand

communication and customer-based brand equity and the relationships between the customer-based brand equity dimensions. Therefore, this study adopts the mixed-method research design that is consisted of two phases. The first phase is using qualitative research method to gain a deeper insight into the notion of social media brand communication and customer-based brand equity and refine the conceptual model that has been developed on the basis of existent literature. In the second phase a main survey will be conducted to test the research hypotheses and the proposed conceptual framework.

**Keywords:** *Brand equity, Marketing communications, Social media, High street fashion*

## REFERENCES

- Aaker, D. A. (1991), *Managing Brand Equity: Capitalizing on the Value of a Brand Name*, The Free Press, New York, NY.
- Bruhn, M., Schoenmueller, V. and Schäfer, D. B. (2012), "Are social media replacing traditional media in terms of brand equity creation?", *Management Research Review*, Vol. 35 No. 9, pp. 770-790.
- Devereux, L., Melewar, T.C. and Foroudi, P. (2017), "Corporate identity and social media: existence and extension of the organization", *International Studies of Management & Organization*, Vol. 47 No. 2, pp. 110-134.
- Keller, K. L. (1993), "Conceptualizing, measuring, managing customer-based brand equity", *Journal of Marketing*, Vol. 57 No. 1, pp. 1-22.
- Kumar, A., Bezawada, R., Rishika, R., Janakiraman, R. and Kannan, P. K. (2015), "From social to sale: the effects of firm-generated content in social media on customer behaviour", *Journal of Marketing*, Vol. 80 No. 1, pp. 7-25.
- Mangold, W. G., and Faulds, D. J. (2009), "Social media: the new hybrid element of the promotion mix", *Business Horizons*, Vol. 52 No. 1, pp. 357-365.
- McEwen, W., Fang, X., Zhang, C. and Burkholder, R. (2006), "Inside the mind of the Chinese consumer", *Harvard Business Review*, Vol. 84 No. 3, pp. 68-76.
- Payal, S. K., Jayasimha K. R. and Ashish, S. (2013), "Brand-related, consumer to consumer, communication via social media", *IIM Kozhikode Society & Management Review*, Vol. 2 No. 1, pp. 43-59.
- Schivinski, B. and Dabrowski, D. (2015), "The impact of brand communication on brand equity through Facebook", *Journal of Research in Interactive Marketing*, Vol. 9 No. 1, pp. 31-53.
- Stanat, M. (2006), *China's Generation Y: Understanding the Future Leaders of the World's Next Superpower*, Homa & Sekey, Paramus.

## NATIONAL INNOVATION SYSTEM IN SMALLER NATIONS; THE CASE OF MONTENEGRO

Karadzic, Vesna<sup>1</sup>; Manijeh, Reyhani<sup>2</sup>

<sup>1</sup>Faculty of Economics, University of Montenegro, Podgorica, Montenegro

<sup>2</sup>Business School, University of Western Australia, Perth, Western Australia, Australia

### ABSTRACT

There is a global recognition that innovation is a key driver of international competitiveness. Since the 1980s attention has been given to the concept of the National Innovation System (NIS), in which a range of public and private institutions interact with each other to foster innovation and diffuse new technologies. The concept of the National Innovation System (NIS) emerged in the 1980s with the work of Freeman (Freeman, 1987) and Lundvall (Lundvall, 1998). It was the success of economies such as Japan, Germany and the United States in linking their public investment in research and development with the growth of successful technological innovation that triggered strong interest in the NIS concept (Lundvall, 2007). Interest in the NIS concept has continued steadily over the past 30 years, and is now officially recognised by many nations (OECD, 2006). In small nations however this is taking time to develop.

A key area of interest within NIS studies is the role played by universities in their interactions with industry. According to Lundvall (Lundvall, 2007) this nexus between industry and universities for the transfer of technological innovation has been based largely around the experience of the biotechnology and pharmaceuticals industries in the United States. The success of such networks elsewhere around the world has been less clear, although it has not stopped its emulation – with some success – in a number of other countries (OECD, 2012).

Since the 1970s governments throughout the industrialised world have launched a range of initiatives designed to link universities more closely with industry in the process of innovation. These initiatives generally seek to stimulate local economic development by encouraging universities to transfer out their technology to industry. Engaging the inventors in this commercialisation process has been viewed as important (Alexy and Joachim, 2008). This is due to the recognition that many new technologies are highly complex and may not be fully understood by industrial end-users (Linton and Walsh, 2004). Universities have been viewed as having a role to play in this technological development (Styles and Genua, 2008).

In the knowledge economy that has emerged over the past 20 years, universities, as major centres of learning and research, are becoming increasingly important as the source of ideas that can be turned into new products, processes and systems (OECD, 2012). This is particularly so in the enabling

technologies such as information and communications technologies (ICT), biotechnology and nanotechnology.

Innovation is the key to ensuring the long-term economic prosperity of any nation. A more complete understanding of business innovation and its management, particularly within government, enhances policy frameworks that may assist countries to achieve greater innovation success. In particular, it enables public policy to take a broader, more holistic view of the range of policy structures that influence business innovation, rather than a narrow focus on science and technology policy. Research managers often find themselves attempting to promote and facilitate industry engagement with universities while knowing relatively little about the nature of such relationships (Freeman and Soete, 2009). Of particular importance is the ability of academics to adopt a more entrepreneurial approach to the commercialisation of their research, with research findings that suggest a positive correlation between entrepreneurial activity and research productivity (Van Looy et al., 2011).

Despite its relatively small population, approximately 620 thousand people, Montenegro's university sector is active in collaborating with industry and the government encourages such plans. For example, University of Montenegro has been actively involved with PACINNO project (Cozza et al., 2016) which is a collaboration platform that connects into a single, regional innovation system the academic and research institutions, policy makers, and innovative companies of eight countries belonging to the Adriatic region (Albania, Bosnia-Herzegovina, Croatia, Greece, Italy, Montenegro, Serbia, Slovenia). Research shows that the level of received support through innovation incentives from the government, regional authorities and the EU is low and the total number of new PhD graduates, as to the total share of the active population, is significantly lower than the Region and the EU (Karadzic et al., 2016).

In Montenegro, there are several important factors that should provide the right conditions for the development of the National Innovation System. The most important factors are the development of human resources for research and development, and the education and training of the employees in the private sector. For this purpose, equipment for scientific research and appreciation for higher education is required. It is important for the university management to interact with industry and government for socioeconomic development which requires changes in the functions and structure of the universities and the development and functioning of Science and Research System in Montenegro. Research also points out that the most important for Montenegro is also: The formation and development of scientific human resources; Building of a scientific research infrastructure and entering more into the international scientific research cooperation (Tinaj et al., 2013).

*Keywords: Innovation Management, Innovation System, National Innovation System(NIS), Scientific Research, Science and Technology, Montenegro, Economy, Structure and Strategy.*

## REFERENCES

- Alexy, O., Joachim H. (2008). "Promoting the Penguin: Who is Advocating Open Source Software in Commercial Settings?", Center for Economic Policy Research (CEPR): 1-7.
- Cozza, C., Harirchi, G., Markovic Cunko A. (2016). "Innovation in the Adriatic Region". PACINNO Project:1-125.
- Freeman, C. (1987). "Technology Policy and Economic Performance: Lessons from Japan", London, Pinter:1-155.
- Freeman, C., and Soete, L. (2009) "Developing science, technology and innovation indicators: What we can learn from the past," *Research Policy* 38(4): 583-589.
- Karadzic, V., Drobnjak, R., Boskovic, V. (2016). "Innovation in the Adriatic Region", Chapter 7, Montenegro: 123-145
- Lundvall, B.-Å. (1998) "Why study national systems and national styles of innovations?" *Technology Analysis & Strategic Management* 10(4): 407-421.
- Lundvall, B.-Å. (2007) "National Innovation Systems—Analytical Concept and Development Tool," *Industry & Innovation* 14(1): 95-119.
- Linton, J. D., and Walsh, S.T., (2004). "Integrating innovation and learning curve theory: an enabler for moving nanotechnologies and other emerging process technologies into production." *R&D Management* 34(5): 517-526.
- OECD (2006) "Innovation and economic performance," *OECD Economic Surveys: Canada*, Organisation for Economic Cooperation & Development: 73-100.
- OECD (2012), *OECD Science, Technology and Industry Outlook 2012: Complete Edition*, Source OECD Industry, Services & Trade, 2012, 14, i-466(466)
- Tinaj S. (2013) "National Research and Innovation System in Montenegro", University of Donja Gorica, Presentation of national research and innovation system in montenegro - NEXT Project, 1-3
- Styles, C., and Genua, T. (2008). "The rapid internationalisation of high technology firms created through the commercialisation of academic research." *Journal of World Business* 43: 146–157.
- Van Looy, B., Landoni, P., Callaert, J., van Pottelsberghe, B., Sapsalis, E., and Debackere, K. (2011) "Entrepreneurial Effectiveness of European Universities: An Empirical Assessment of Antecedents and Trade-offs," *Research Policy* 40(4): 553-564.

## IDENTIFYING SUCCESS FACTORS IN FOOD EXPORTS: AN APPLICATION OF THE BEST-WORST SCALING METHOD

Karipidis, Philippos<sup>1</sup>; Chrysochou, Polymeros<sup>2</sup>; Karypidou, Ioanna<sup>3</sup>

<sup>1</sup>Department of Agricultural Technology –Agricultural Economics, Alexander TEI of Thessaloniki

<sup>2</sup>Department of Management, Aarhus University, Denmark

<sup>3</sup>Applied Economics and Finance, University of Macedonia, Thessaloniki, Greece

### ABSTRACT

Taking into consideration the major contribution of food exports in the development of Euro-Mediterranean economies, the present study aims to analyse export performance at firm level and assess the importance that food-exporting firms assign to drivers and barriers of export performance. Building on exploratory findings from an earlier study (Karipidis *et al.*, 2016), the present study examines two sets of factors connected with the primary production that are considered to impact export performance of food firms. This exploration is especially useful taking into account the structural characteristics of the Euro-Mediterranean agriculture, which is characterised by the small size of farm businesses and the overall conditions of the agricultural production. The first set of factors comprises of reasons that influence export performance positively (success factors), whereas the second includes those with a negative impact (barriers).

We adopted the Best-Worst scaling method (Marley and Louviere, 2005) due to its ability to provide a better discrimination of the factors analysed, and its simplicity that makes a significant contribution to practitioners. The method has been applied in the study of consumer preferences towards wine and other food products (Chrysochou *et al.*, 2012; Chrysochou, 2012; Cohen, 2009; Lockshin *et al.*, 2016; Rezaei *et al.*, 2016). We distributed our questionnaire to food exporting firms in Greece and across the following sectors: fruit and vegetables, wine, dairy, animal products and olive oil. The questionnaire included a list of performance measurement indices, the two lists of success factors and barriers, and questions related to the background of the firm. Our respondents were staff members of each exporting firm.

At the time of writing this abstract, data collection is taking place after sending electronically the questionnaire to more than five hundreds of food exporting firms. A preliminary analysis of responses from 59 completed answers shows that the Best-Worst method can be effectively implemented to identify the drivers of the food exporting firm performance. The preliminary results indicate that the big majority of exporting firms are small and too small and that they export their products in several export markets. Food exporters are viewing export performance to be composed of a set of seven indicators associated with entering in new markets, gaining of new customers, export volume and value, market position and profitability and the big majority of them perceive the performance to be

enhanced last three years. Among the most important success factors between the thirteen factors related to the primary production examined are raw product quality and safety, and quality controls exerted by firms in purchased products. In regards to the barriers, the most important factors between thirteen factors related to the primary production examined are the quality-related uncertainty of raw products, the high cost of purchasing and collecting products by farmers, and the high producer prices.

*Key words: Best-Worst scaling, export performance, barriers, food supply, primary production*

## REFERENCES

- Chrysochou, P. (2014), "Drink to get drunk or stay healthy? Exploring consumers' perceptions, motives and preferences for light beer", *Food Quality and Preference*, Vol. 31, pp. 156–163.
- Chrysochou, P., Krystallis, A., Mocanu, A. and Lewis, R. (2012), "Generation Y preferences for wine an exploratory study of the US market applying the best-worst scaling", *British Food Journal*, Vol. 114(4), pp. 516–528.
- Cohen, E. (2009), "Applying best-worst scaling to wine marketing", *International Journal of Wine Business Research*, Vol. 21 No. 1, pp. 8 – 23
- Karipidis, P., Chrysochou, P. and Karypidou, I. (2016), "Does the Greek food supply respond to the world challenges?" presented at 2nd International Conference on Development and Economy, Thessaloniki, Greece, 2016.
- Marley, A.A.J. and Louviere, J.J. (2005), "Some probabilistic models of best, worse, and best–worst choices", *Journal of Mathematical Psychology*, Vol. 49, pp. 464–480.
- Rezaei, J., Nispeling T., Sarkis J. and Tavasszy, L., (2016), "A supplier selection life cycle approach integrating traditional and environmental criteria using the best worst method", *Journal of Cleaner Production*, Vol. 135, pp. 577- 588.



## TITLE- DEVELOPMENT AND VALIDATION OF A SCALE FOR TEAM TASK ROLES, TEAM TASK TYPES AND TASK INTERDEPENDENCIES

Karve, Shailaja<sup>1</sup>; Pandey, Aparna<sup>2</sup>; Malankar, Shweta<sup>3</sup>

<sup>1</sup>K.J. Somaiya Institute of Management Studies and Research, Mumbai, India

<sup>2</sup>ITM University, Raipur, India

<sup>3</sup>Marsh India Insurance Brokers Pvt. Ltd, Mumbai , India

### ABSTRACT

This paper describes the development and validation of a scale for Team Task Roles, Team Task Types and Task Interdependencies. This scale is based on Mumford et al, (2006) team task roles. The authors opined that when individuals work in teams, they take on team roles, perform team tasks, and task have interdependencies.

The three constructs for the scale are Team Task Roles, Team Tasks and Task Interdependence. Team Task Role is unique behavior displayed by a team member for accomplishment of team goals in specific situations and responsibilities (Stewart et al, 2005). Team Tasks were classified by various researchers according to task features related to task structure, technology requirements, complexities, abilities required etc. for task completion (Devine, 2002). Team task interdependence is a distinct feature of the team tasks, as tasks are collective responsibility of the team members who use their shared or combined intellectual as well and technological resources for mutual as well as team benefit (Van der Vegt and Van der Vliert, 2002; Rossi 2008).

The scale covers five team task roles (Creator, Critic, Contractor, Contributor and Completer; Mumford et al, 2006), three team tasks types (idea generation, production and problem solving) and three task interdependencies (pooled, sequential and reciprocal) and the interplay between the three.

The following questions guided the research -

1. What Team Task Roles do the team members naturally adopt?
2. What is the relationship between Team Task Role and Team Task Type?
3. How do Team Task interdependencies influence Team Task Type?
4. What is the relationship of Team Task Role with Task Interdependency?

*Hypothesis: Team Task Role, Team Task type and Team task interdependency are interrelated.*

The nomological networks were examined amongst dimensions of Team Task Roles, Team Tasks and Team Task Interdependency by mapping each team interdependency type with each team task type and each team task role type (Figure 1).

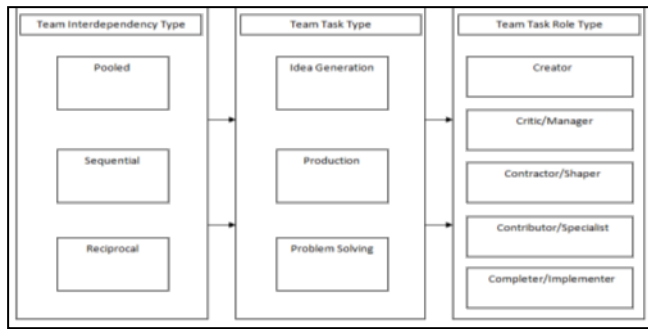

Figure 1: Nomological Network of the Dimensions of Team Interdependency, Team Tasks and Team Task Role

The authors developed an initial scale of 240 items and subjected it to reliability and validity tests. The definitions and situational possibilities of each task role (Mumford et al. (2006) and Hackman’s Task Definitions (1990) and Task Interdependencies (Thomson, 1967) formed the basis of the scale. Content validity to ensure qualitative instrument output for team task role, team task type and team interdependency items generated for the scale was done by a panel of experts including academicians, industry and language experts by convenience sampling. SME panel helped evaluate item pool compilation by Delphi technique for conformity and redundancy. Final restructuring and regrouping of item subsets was based on the feedback of SMEs and helped refine the item pool to 240 items to be tested for reliability analysis. Exploratory (EFA) and Confirmatory factor analysis (CFA) was done (Table 1). Cronbach alpha was computed for the scale 0.973 as well as the subscales. The purified scale items include (five Team Task Roles; three Team Task Types and three Team Interdependencies  $5*3*3= 45 *2 = 90$ ). The final scale with 90 items has a cronbach alpha reliability of 0.973 after CFA and is named as Team Task Roles and Task Interdependency Scale.

	Items	Items after Exploratory Factor Analysis	Items after Confirmatory Factor Analysis
Pooled	80	38	30
Sequential	80	42	30
Reciprocal	80	36	30

Table 1 – Initial Items, items after EFA, and items after CFA

The theoretical foundations this instrument is based on a conceptual model of the Team Task Roles of Team members as defined by Mumford et al (2006), Team Tasks and the interdependent nature of the tasks. It aims to be used for assessing the relationship between Team Task Roles, Team Tasks and Team Task Interdependencies. It can be used for diagnostic profiling of the Team members for task roles and be used for forming teams that require or display interdependent task responsibilities. Team members with complimentary capabilities can be selected for a particular team task, backed with an understanding of the core team task role and interdependent team task type requirements. This framework has distinct characteristics providing a definitive structure for the instrument at individual team task roles, team task types and task interdependency levels. It takes Mumford et al

(2006) research a step forward by outlining how individuals respond to different task types and task interdependencies and what role behaviour they display while performing these interdependent tasks. It displays its potential helpfulness by combining team task role knowledge with task types in interdependent work situations. The resultant model not only recognises the three main constructs and their unique contribution to team behaviour and effectiveness but also integrates the main theoretical framework by specifying their relationships and the implications of results for selection and team building are discussed. Incremental value to validity of the instrument may be gained by furthering research of team task role from compilation to sufficiency to proficiency/expertise.

*Keywords: Teams, Team Task Roles, Team Task Types, Task Interdependence*

## REFERENCES

- Devine, D. J. (2002). "A review and integration of classification systems relevant to teams in organizations". *Group Dynamics: Theory, Research, and Practice*, 6, pp. 291-310.
- Hackman, J. R. (Ed.). (1990). *Groups that work (and those that don't): Creating conditions for effective teamwork*. San Francisco: Jossey-Bass.
- Mumford T.V., Campion M.A. and Morgeson F.P. (2006), *Situational Judgment in Work Teams: A Team Role Typology*, in *Situational Judgment Tests: Theory, Measurement, and Application* (pp. 324-325), edited by J. A. Weekley and R. E. Ployhart, 2006, Mahwah, New Jersey: Erlbaum. by Lawrence Erlbaum Associates, Publishers.
- Rossi M.E. (2008), "The development and validation of the comprehensive team interdependence scale" (2008). *Graduate Theses and Dissertations* <http://scholarcommons.usf.edu/etd/481>
- Stewart, G. L., Fulmer, I. S. and Barrick, M. R. (2005). "An exploration of member roles as a multilevel linking mechanism for individual traits and team outcomes". *Personnel Psychology*, 58, pp. 343-365.
- Thompson, J. D. (1967). *Organizations in action*. New York: McGraw- Hill.
- Van der Vegt, G. and Van de Vliert, E. (2002). "Intragroup interdependence and effectiveness: Review and proposed directions for theory and practice". *Journal of Managerial Psychology*, 17, pp. 50-67.

## SPONTANEOUS VS. INDUCED CLUSTERS: NETWORKS AND COMPETITIVE ADVANTAGE

Kavadarlı, Altın; Öz, Özlem<sup>2</sup>

Department of Management, Bogazici Univ., Istanbul, Turkey

### ABSTRACT

Clusters, defined as a geographic concentration of interconnected businesses, suppliers, and associated institutions, have attracted increasing attention in the management literature (e.g. Beal and Gimeno, 2001; Öz, 2004; Porter 1998). In the strategic management literature, the term “cluster” has been popularized by Michael Porter (1998), who claims that clusters have the potential to affect competitive advantage in three ways; by increasing the productivity of the companies in the cluster, by driving innovation in the field, and by stimulating new business formation. Social capital theory, on the other hand, suggests that a firm’s external networks play a major role in contributing to its performance (Leenders and Gabbay, 1999). There is a growing literature that claims that the effectiveness of localized networks is related to social capital, which covers cultural norms of trust, cooperation and reciprocity (Fukuyama, 1995). The available literature also shows that a firm’s existing network enables it to establish new linkages through referrals by its current partners as well as the visibility that the network ties provide (Gulati, 1999).

This study aims to define the network patterns of firms in spontaneous versus induced clusters deriving from the cases of two hosiery clusters in Istanbul, located in Ikitelli Industrial Zone Corapcilar Sitesi (the induced cluster) and the Yesildirek district (the spontaneous cluster). As a sub-sector of the competitive Turkish clothing industry, the hosiery industry ranks the 2nd in the world hosiery production, just after China. According to ITC Trademap statistics, the Turkish hosiery industry is the 3rd largest exporter in this sector, with a share of 7.7%, following China and Italy. The Turkish hosiery industry exports its products to nearly 130 countries worldwide, and the EU, with a share of about 90%, is the most important market. Face-to-face, in-depth semi-structured interviews with hosiery firms located in the above stated two clusters in Istanbul (where the majority of manufacturers are located) provide both a general understanding of the existing network patterns and also how these networks help promote competitive advantage. An analysis of the linkages among hosiery firms in these clusters reveals that networks are denser in relative terms in the spontaneous cluster when compared to the induced cluster. The relations in the induced hosiery cluster are rather weak and resemble what Uzzi (1997) describes as market or arm’s length relations. Specifically, inter-firm relations in this cluster are characterized by low mutual dependence, a finding that implies being in the same location is not enough, in and of itself, to develop dense relations with the neighboring

firms. Firms in the spontaneous cluster, on the other hand, much emphasize the importance of linkages, especially with regard to the importance attributed to cooperation and trust, knowledge sharing as well as long-term ties. These dense interpersonal networks among firms in the spontaneous cluster have in turn created a strong base, generating knowledge spillovers and reinforcing competitive advantage. Moreover, the analysis conducted reveals that strong ties, in terms of time and energy invested in the relationship, are considered vital for firms in Yesildirek, the spontaneous cluster, whereas weak ties are seen as just acquaintances, a finding in line with Granovetter (1973).

*Keywords: clusters, networks, competitive advantage, textile industry, Istanbul*

## REFERENCES

- Beal, B. and Gimeno, J. (2001) "Geographic agglomeration, knowledge spillovers and competitive evolution", Academy of Management Proceedings (New York, Academy of Management), pp. 1-6.
- Fukuyama, Francis. (1995) "Trust: The social virtues and the creation of prosperity," 182-183.
- Granovetter, Mark S. (1973) "The strength of weak ties." American Journal of Sociology 78.6: 1360-1380.
- Gulati, Ranjay. (1999) "Network location and learning: The influence of network resources and firm capabilities on alliance formation." Strategic Management Journal 20.5: 397-420.
- Leenders, R. T. A. & Gabbay, S. M. (1999). An agenda for the future. In R. T. A. Leenders & S. M. Gabbay (Eds.), Corporate Social Capital and Liability (pp. 483-494). New York: Kluwer.
- Öz, Ö. (2004) Clusters and Competitive Advantage: The Turkish Experience, Palgrave MacMillan, New York and Basingstoke, Hampshire.
- Porter, M. E. (1998) On Competition, Harvard Business School Publishing, Boston.
- Uzzi, Brian. (1997) "Social structure and competition in interfirm networks: The paradox of embeddedness." Administrative Science Quarterly, 35-67.

## THE IMPACT OF DIGITAL NETWORKS ON MANAGERIAL DECISION MAKING: PRACTICALITIES AND PARADOXES

Kay, Avi

Jerusalem College of Technology (Lev Academic Center), Jerusalem, Israel

### ABSTRACT

A key element of management is to prepare for the future. This task has become increasingly difficult in this age of multiple disruptions. In order to navigate these disruption, decision makers are increasingly called upon to exhibit innovative processes and solutions. This research examines the potential role of digital networks in innovation. Specifically, it looks at the characteristics of these networks and the manner in which managers elicit, evaluate and engage in actions to mold optimal personal and organizational outcomes. Paradoxically, it seems that the very nature of digital networks and their by-products, simultaneously creates a situation in which managers have both potentially more and less discretion with regard to how they can act. Similarly, they seem to both increase and diminish chances that their actions will lead to desired outcomes. The first stage of this research program is to be the establishment of a background, theoretical understanding of the dynamics at play. Following that, the plan is to undertake empirical research within organizational settings.

### INTRODUCTION

A key element of management is to prepare for the future. This task has become increasingly difficult in this age of multiple disruptions: social, economic, spiritual, and technological. Indeed, if there is one thing that characterizes the current era, it is "disruption." The changes are coming "fast and furious" - creating what Bauman termed "liquid modernity" - "a situation in which the conditions under which its members act change faster than it takes the ways of acting to consolidate into habits and routines" (Bauman 2006, p.1).

As such, the need for decision makers to engage in innovative processes and solutions has become a progressively more crucial factor in the success or contemporary organizations. A central tool in the above are the emerging internet and digital networks. Lanier (2014) suggests that these ever more sophisticated digital networks will create a future that may seem unfathomable today. The exponential growth of digital networks and the information they contain will not only fundamentally change the developing future, but also the very way in which organizations - and those acting within them - respond to an unknown future.

Along the lines of work done by Leonardi and Barley (2008), Orlikowski (2009), **the purpose of this research is to examine *how* digital networks and their accompanying characteristics impact**

**the manner in which managers elicit, evaluate and engage in actions to mold optimal personal and organizational outcomes.** More specifically, this work will establish the background, theoretical understanding of the dynamics at play. At the next stage, empirical research will be done within organizational settings.

Organizations can be viewed as techniques of assembling and arranging resources to deal with those future problems that may emerge. The reconfiguration of organizational capacities to deal with the future is a central focus in the context of the proposed research. It seems that, in the spirit of Tsoukas (1997), *paradoxically*; the very nature of digital networks and their by-products, simultaneously creates a situation in which managers have both potentially *more* and *less* discretion with regard to how they can act as well; as well as increased and diminished chances that their actions will lead to desired outcomes. For the networks and information flowing through them may - among other things - both increase and ingrain organizational routines and/or diminish and disassemble such routines, as the mechanics and the messages they transmit lead to a situation in which standard operating routines are increasingly upended (Feldman, Pentland, D'Adderio and Lazaric 2016).

Weick (1979) noted that all managerial actions begin with "sensemaking" - the efforts of the individual to extract meaning from their reality. In terms of managerial decision-making, hierarchy and organizational structures provide, filter and "condense" information (be it via market research, human resource management etc.). Digitalization allows managers to "directly" access relevant information without necessarily relying on intermediates. Thus, it can be argued that digital networks can, perhaps, enhance one's understanding of the surrounding reality in that they provide the individual with much more timely information. As such, they may provide a much more complete picture of one's experiences and current reality, one that simply "makes more sense."

The information afforded by these digital networks (eg. the famous "big data") may also augment the ability to understanding what possible "futures" may exist. Beckert (2013) suggested that behavior is guided by subjective, self-created "fictionalized futures." These subjective "fictionalized futures" both rest on past experience and are fueled by hopes and apprehensions regarding open possibilities. On one hand, digital networks may improve imperfect assumptions regarding the future turning them into objective, "nearly perfect" (or at least, "much better") predictions. As such, they allow managers with the possibility of getting much larger ROI from actions. On the other hand digitalization might lead to less constructive "fictionalized futures" that are more impervious to change and reexamination, as autonomous computerized decisions are made.

Digital networks may have another, unexpected, effect on the ability to respond adequately to the future. First, the individual's actions and behaviors become increasingly more widely (and deeply) immortalized in digital network, a "sticky" type of digital identity (Beckert, 2013) may emerge -

leading to more difficulty to "back out" of previous ideas and decisions. These widely available digital identities may further impair the ability of managers to achieve their future goals in, yet, a different way. For, both various stakeholders with whom managers interacts (i.e. employees, superiors, customer etc.) and possible business "adversaries" may be able to access information that will curtail the ability of managers to successfully negotiate with or otherwise "outwit" the above. Those sharing the business arena with the managers may simply be better prepared to guess the "next move" of the manager.

Clegg (1990) suggested that the transition to the bureaucratization of organizations was seen as "irresistible and inevitable." The impact of technology seems to be following a similar pattern. The "more advanced technology becomes, the more all activity becomes mediated by information tools" (Lanier, p. 16). This mediation of our lives is likely to have both beneficial and detrimental effects on the ability of managers - and the organizations they lead - to optimally negotiate the present future and the future present that awaits.

*Keywords: digital networks, managerial decision making, technology and management, innovation*

## REFERENCES

- Beckert, J. (2013), Imagined futures: fictional expectations in the economy. *Theory and Society*, Vol. 42 No. 3, pp. 219-240.
- Bauman, Z. (2006), *Liquid Life*. Polity Press. Cambridge.
- Clegg, S. (1990), *Modern organizations: Organization studies in the postmodern world*. Sage. New York.
- Feldman, M. S., Pentland, B. T., D'Adderio, L., and Lazaric, N. (2016), "Beyond routines as things: Introduction to the special issue on routine dynamics",
- Lanier, J. (2014), *Who owns the future?* Simon and Schuster. New York.
- Leonardi, P. M., and Barley, S. R. (2008), "Materiality and change: Challenges to building better theory about technology and organizing", *Information and Organization* Vol. 18 No. 3, pp. 159-176.
- Orlikowski, W. J. (2009), "The sociomateriality of organisational life: considering technology in management research", *Cambridge Journal of Economics*, bep058.
- Tsoukas, H. (1997), "The tyranny of light: The temptations and the paradoxes of the information society", *Futures* Vol. 29 No., pp. 827-843.



## EMERGENCE OF COMPLEX NEW ARRANGEMENTS: THE STATE RESPONSES TO GLOBAL BUSINESS DIVERSITY

Kayasan, Oskar; Saghir, Nadine

European Research Centre, London, United Kingdom

### ABSTRACT

This paper examines the potential prospect of change in the state business undertakings in response to complex new environments. The establishment of an effective authority between state and business has been one of the key challenges in current dilemma of global socio-economic political crises. Global business involve the urgent new framework in state-business affairs in the world, especially in the west. At present, ongoing debate about the role of the state lies at the heart of development economics. Much of this debate has been and continues to be dominated by the idea of “market failure”. The early development theorists (Rosenstein-Rodan, 1943; Hirschman, 1970) pointed to market failure as a reason for comprehensive planning. The actual experiences of the developing countries, in the context of problems associated with government intervention, and theoretical arguments against the role of the state, led to the recognition of government failure as an impediment to development (von Hayek, 1967; Bauer, 1984; Little et al., 1970). More recently, de Soto (2000) has made the argument that the lack of property rights is the fundamental reason for developing economies being unable to develop successful business and economics models. This paper analyzes the main futures of global market mechanism and reasonable basis of change within entangle state business affairs. However, it concludes that in view of the current dilemma in both global markets and state-business affairs may require rather socio-political imbalances to perceive any profound changes.

*Keywords: Global business, state-business, diversify, affairs, entangle, state responses, business*

## **MARGINAL REVOLUTION: ROLE OF INTERMEDIARY IN INTEGRATION OF STREET VENDORS IN FORMAL ECONOMY**

**Kella, Chintan; Rimac, Tomislav; Gurses, Kerem; Turner, Karynne**

Department of Business and Management, LUISS Guido Carli University, Rome, Italy

### **ABSTRACT**

In this paper, using an institutional theory perspective, we contribute to the body of knowledge about the process of transition from informal to formal economy through the study of SEWA's involvement in empowerment of street vendors in India. By situating our research in the context of institutional voids and deep poverty, we draw attention to the role of intermediary in empowering of disempowered actors in an informal economy. Through our case study, we identify three processes through which the non-marginalized actor achieves empowerment of the street vendors: (i) creation of collective identity among street vendors; (ii) regulatory entrepreneurship that involves initiating and influencing creation of national laws regulating street vendor activities; and, (iii) making sure that the law becomes available and meaningful to the vendors.

### **INTRODUCTION**

Although there exists a diverse body of knowledge on informal economy, it still remains largely fragmented. Researchers working in various domains (e.g., anthropology, economics, sociology, etc.) have tried to understand the cause and effects of informal economies across the globe, so that possible solutions can be devised to transition it to formally economy. While sociology scholars have tried to explain informal economy with the perspective of empowerment or rather the lack of empowerment to participate in formal economy (Portes, Castells, & Benton, 1989), economists have tried to explain it from cost-benefit perspective for actors willing to enter and remain in informal economy.

Although the demography of actors participating in informal economy is similar across countries, the institutional arrangements and conditions differ substantially from country to country. Therefore, researchers have recently taken an interest in the informal economy from an institutional perspective (Ahlstrom & Bruton, 2006; Battilana, Leca, & Boxenbaum, 2009; Bruton, Ahlstrom, & Li, 2010; Bruton, Ahlstrom, & Obloj, 2008; Khanna & Palepu, 2010; Mair, Martí, & Ganly, 2007; Mair, Martí, & Ventresca, 2012; Stephan, Uhlander, & Stride, 2015; Webb, Ireland, & Ketchen, 2014) We build on existing research on institutions at various levels and the role they play for transition of informal economy towards a formal economy. Scholars have also started taking into account the importance of intermediaries and institutions at meso level, because of a large gap between the macro

level, consisting of state, legal frameworks, national financial institutions, and the micro level, i.e., individual, who are the actual actors in the informal economy (Battilana, Leca, & Boxenbaum, 2009; Lee & Hung, 2014; Mair et al., 2012; Seelos, Ganly, & Mair, 2006; Roelants, 2000). Studies so far have subtly established that role of meso level institutions is to reinforce informality (De Castro, Khavul, & Bruton, 2014) or at best to enable the marginalized citizens to access markets (Mair, Marti, & Ventresca, 2012; Martí & Mair, 2009; Seelos & Mair, 2007; Stephan, Patterson, Kelly, & Mair, 2016). While this is equally true depending on the meso institutions at work, with this study we present that such intermediaries at meso level can be crucial and highly effective in empowering the informal actors to move from informal to formal economy. Moreover, most existing studies tend to focus on either the meso level together with actors at the micro level, or the meso level and its relationship with the macro level (De Castro et al., 2014; Droege & Johnson, 2007; Roelants, 2000; Viterna & Robertson, 2015; Webb, Tihanyi, Ireland, & Sirmon, 2009), there is very little research on the bi-directional role of intermediaries at the meso level. The dual role that meso level intermediary can play to empower and improve the socio-economic conditions of the marginalized micro level actors and also to reshape the macro level, so that the government policies work for providing a better context for improving the conditions for marginalized actors is understudied.

Set in the context of India, its street vendors, the new Street Vendors act and the role of organization called Self Employed Women's Association (SEWA) which acts as an intermediary, we study the role and mechanism employed by this intermediary to disrupt institutionalized structures of inequality and thereby transition to formal economy. We conduct 286 structured interviews with the street vendors, 12 semi-structured interviews with the street vendor leaders, and 4 semi-structured interviews with the SEWA team. We combine these interviews with archival data, which consists of 64 reports from SEWA and other related sources. Through our case study, we identify three processes through which the non-marginalized actor achieves empowerment of the street vendors: (i) creation of collective identity among street vendors; (ii) regulatory entrepreneurship that involves initiating and influencing creation of national laws regulating street vendor activities; and, (iii) making sure that the law becomes available and meaningful to the vendors. Thus, the non-marginalized intermediary diminishes prevailing inequalities by spanning macro and micro institutional levels, formal and informal economy, and enabling poor to become full citizens able to use local resources, realize choices, and enjoy their rights enshrined in the legal system.

*Keywords: Informal economy, Social Entrepreneurship, Institutional Theory, Institutional Entrepreneurship, Empowerment, Regulation*

## REFERENCES

- Ahlstrom, D., & Bruton, G. D. (2006). Venture capital in emerging economies: Networks and institutional change. *Entrepreneurship Theory and Practice*, 30(2), 299–320.
- Battilana, J., Leca, B., & Boxenbaum, E. (2009). How actors change institutions: towards a theory of institutional entrepreneurship. *Academy of Management Annals*, 3(1), 65–107.
- Bruton, G. D., Ahlstrom, D., & Li, H. L. (2010). Institutional theory and entrepreneurship: Where are we now and where do we need to move in the future? *Entrepreneurship: Theory and Practice*, 34(3), 421–440.
- Bruton, G. D., Ahlstrom, D., & Obloj, K. (2008). Entrepreneurship in Emerging Economies: the Research Go in the Future. *Entrepreneurship Theory and Practice*, 32(January), 1–14.
- De Castro, J. O., Khavul, S., & Bruton, G. D. (2014). Shades of grey: how do informal firms navigate between macro and meso institutional environments? *Strategic Entrepreneurship Journal*, 8(1), 75–94.
- Droege, S., & Johnson, N. B. (2007). Broken Rules and Constrained Confusion: Toward a Theory of Meso-Institutions. *Management and Organization Review*, 3(1), 81–104.
- Khanna, T., & Palepu, K. (2010). Spotting and responding to institutional voids. Winning in emerging markets. A roadmap for strategy and execution.
- Lee, C., & Hung, S. (2014). Institutional Entrepreneurship in the Informal Economy: China's ShanZhai Mobile Phones. *Strategic Entrepreneurship Journal*, 8(1), 16–36.
- Mair, J., & Marti, I. (2009). Entrepreneurship in and around institutional voids: A case study from Bangladesh. *Journal of Business Venturing*, 24(5), 419–435.
- Mair, J., Martí, I., & Ganly, K. (2007). Institutional voids as spaces of opportunity. *European Business Forum*, 31(1), 34–39.
- Mair, J., Martí, I., & Ventresca, M. J. (2012). Building inclusive markets in rural Bangladesh: How intermediaries work institutional voids. *Academy of Management Journal*, 55(4), 819–850.
- Martí, I., & Mair, J. (2009). Bringing change into the lives of the poor: Entrepreneurship outside traditional boundaries. *Institutional Work: Actors and Agency in Institutional Studies of Organizations*, 92–119.
- Portes, A., Castells, M., & Benton, L. (1989). World underneath: The origins, dynamics, and effects of the informal economy. *The Informal Economy: Studies in Advanced and Less Developed Countries*. Johns Hopkins University Press, Baltimore.
- Roelants, B. (2000). Worker co-operatives and socio-economic development: The role of meso level institutions. *Economic Analysis*, 3(1), 67–83.
- Seelos, C., Ganly, K., & Mair, J. (2006). Social entrepreneurs directly contribute to global development goals. In *Social entrepreneurship* (pp. 235–275). Springer.
- Stephan, U., Uhlander, L., & Stride, C. (2015). Institutions and social entrepreneurship: The role of institutional voids, institutional support, and institutional configurations. *Journal of International Business Studies*, 46(3), 308–331.
- Viterna, J., & Robertson, C. (2015). New Directions for the Sociology of Development. *Annual Review of Sociology*, 41(1).
- Webb, J. W., Ireland, R. D., & Ketchen, D. J. (2014). Toward a greater understanding of entrepreneurship and strategy in the informal economy. *Strategic Entrepreneurship Journal*, 8(1), 1–15.
- Webb, J. W., Tihanyi, L., Ireland, R. D., & Sirmon, D. G. (2009). You Say Illegal, I Say Legitimate: Entrepreneurship in the Informal Economy. *Academy of Management Review*, 34(3), 492–510.

## SUPERVISOR COMMITMENT VERSUS ORGANIZATIONAL COMMITMENT

**Kidron, Aviv**

Dept. of Human Services, The Max Stern Yezreel Valley College, Yezreel Valley, Israel

### **ABSTRACT**

The purpose of this paper was to analyze the relationship between psychological contract fulfillment, empowerment, participative decision making and supervisor commitment, as well as affective commitment. Supervisor commitment is considered a mediating variable since it emphasizes the importance of the supervisor's role in the relationship between employees and the organization. The sample comprised of 522 employees from 11 organizations operating both in public and private sectors. Psychological contract fulfillment, empowerment, participative decision making are positively related to both supervisor commitment and affective commitment. Supervisor commitment was found the most significant predictor of affective commitment among employees. Supervisor commitment partly mediated the relationships between empowerment, psychological contract, participative decision making and affective commitment. The findings consistently accord with social exchange theory, which draws attention to the importance of the dyadic and interpersonal relationship between employees and their supervisor and the possibility that it leads to supervisor commitment. In practical terms, supervisors play a key role in upholding and maintaining the psychological contract and cultivating employee empowerment.

*Keywords: supervisor commitment, affective commitment, psychological contract, psychological empowerment, participative decision making,*

## THE BUSINESS MODEL CANVAS AS THE KEY TO A COMPANY'S SUCCESS

Klimova, Olena

Department of Finance, Accounting and Auditing, Donetsk State University of Management, DSUM, Mariupol, Ukraine

### ABSTRACT

The important management tool that simplistically describes the organization and operation of all activities aimed at creating the company's values is the business model. The quality business model allows determining the value preferences of consumers and finding ways to meet them with the aim of adding values of the company. In addition, as experience shows, commercial success often depends on technological innovations, namely on building optimal business models.

There are many definitions of a business model. The business model is a conceptual tool to study a complex object (business system) reflecting the logic of business. The business model is a brief description of how the company operates. The value here is that you can use a business model to ensure a strategic fit between various activities. The business model is a role model. The value is that it can be used to describe how a company should function. For one and the same technology, product or service there is a large number of business models. And is there a business model for maximum success?

From the standpoint of system approach, the instrument for visualization of the logic of a company's business model is the universal business model, so-called "canvas" (template) of the business model authored by Alexander Osterwalder and Yves Pigneur. Today it is the most popular solution in this area.

Having studied and analyzed the tens of universal business models of other authors, Osterwalder and Pigneur proposed a model the undoubted advantage of which was its original graphic solution, namely a matrix template, which they called The Business Model Canvas. Canvas is a schematic display on a single A4 page of the most important things for detailing of business processes, development scheme, plans, projects, startups. The canvas is a powerful tool for business modeling and innovation at the level of senior managers. Its potential is that it can capture a complete set of the most important elements of business modeling. Simply put, it displays them using visualization and simple charts, allowing managers to "create a business model on one sheet of A4 paper" (Coen et al., 2013).

Visually this template resembles a canvas, on which like part of a pattern for cutting fabric the components (in the author's terminology – blocks) of a business model are placed.

The Business Model Canvas consists of nine main blocks (components). We present them in the order adopted by the Y. Pigneur and A. Osterwalder: customer segments, value propositions, channels, customer relationships, revenue streams, key resources, key activities, key partners and cost structure (Osterwalder and Pigneur, 2010) (Figure 1).

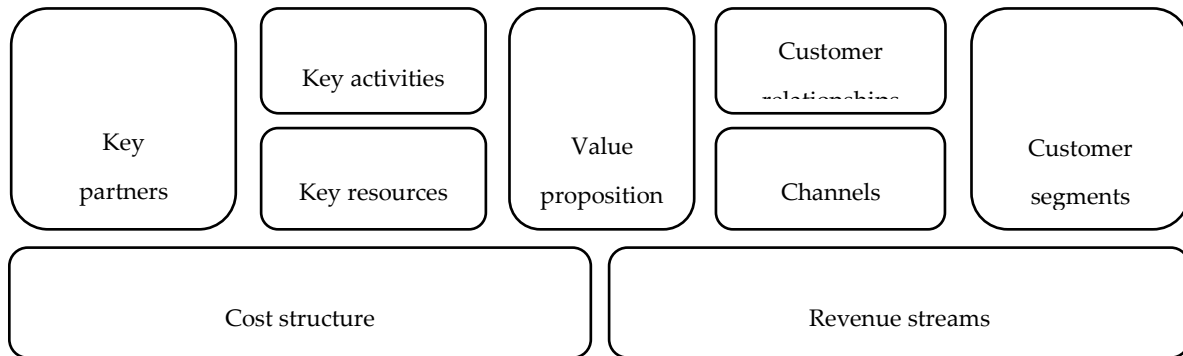

Figure 1. The Business Model Canvas

These blocks are grouped into four basic areas: consumers (clients), offer, infrastructure and profit formula. The presence of a selected client direction consisting of three components –“customer segments,” “channels” and “customer relationships” is, in our opinion, the main advantage of this model in the context of the objectives of the company for managing the client portfolio and client relations.

Thus, the Business Model Canvas is an overview on one page, which describes the current (or prospective) activities of the company and the steps to be taken. The visual format of this model is well suited to both already existing and new companies and provides a panoramic view of the whole business. Its uniqueness lies in the fact that all of the other business models require expensive and often inefficient solutions.

*Keywords: business model, tool, success, value, canvas, Osterwalder's business model, models of business evaluation.*

## REFERENCES

- Coen, L., Baida, Z. and Kouwenhoven, N. (2013), “Beyond the single window: Paving the way to collaborative border management,” WCO news, No. 72, pp. 50-53.
- Osterwalder A., Pigneur Y. Business Model Generation: A Handbook for Visionaries, Game Changers, and Challengers, John Wiley & Sons Inc., New Jersey, IL, USA.

## **ROLE OF DIGITAL COMMUNICATIONS IN SOCIAL SUPERMARKETS IN CROATIA**

**Knezevic, Blazenka; Skrobot, Petra; Delic, Mia**

Faculty of Economics and Business Zagreb, University of Zagreb, FEB, Zagreb, Croatia

### **ABSTRACT**

Social supermarkets emerged as the answer to economic crisis across Europe. Their main purpose is to serve those groups of customers which have low income or which are in severe material deprivation. They, mainly, collect donations in money, food and toiletries from traditional supply chains and distribute it for free or at extremely discounted prices to people in need. Holweg and Lienbacher (2011) define social supermarkets, narrowly, as food oriented retailers who sell food (not giving it for free) to a restricted group of people living in poverty. On the other hand, Maric and Knezevic (2014) emphasize that social supermarkets are a form of non-profit organizations which use the workforce of volunteers and generated income (if there is any) is used for charitable activities.

The purpose of social supermarket is twofold: (1) the poverty reduction through distribution of food and toiletries to needy people and (2) reduction of inefficiency in traditional (dominantly food) supply chains through removal of surpluses of produced food (and other goods).

Even though, the very purpose of social supermarkets is different in comparison to traditional retailers, their basic characteristics can be compared to traditional retail formats such as convenience shops, supermarkets and discount stores (for more details refer to Maric and Knezevic, 2014).

Intensive communication with users and donors increases operational efficiency of social supermarkets. The penetration of Internet and mobile phones within population in Croatia is in line with EU-28 average. Therefore, digital communication could become the vital part of communication mix in social supermarkets.

According to data available in Smigielska et al. (2016), digital communications already plays a significant role in promotional activities of social supermarkets. However, in literature, the scope and role of digital communication usage in social supermarkets is not adequately analyzed and described. Especially two types of digital communications are important for social supermarkets operation; those are web sites and social media.

The aim of this paper is to show how social supermarkets use digital communications for interaction with interested publics, primarily, users and donors. The primary research will include analysis of good practices in social supermarkets in Croatia. Firstly, the structure of social supermarkets' websites will be analyzed and compared. Secondly, the performance and the level of interactivity through social



media will be measured. Based on comparative analysis of good practices the conclusion about the intensity and importance of digital communication in social supermarkets operation will be derived.

*Keywords: digital communication, social supermarkets, web, social media, non-profit organizations*

## REFERENCES

- Holweg, C., Lienbacher, E. (2011), "Social Supermarkets – a New Challenge in Supply Chain Management and Sustainability", Supply Chain Forum, Vol. 23 No. 4, pp. 307-326.
- Maric, I., Knezevic, B. (2014), "Social Supermarkets as a New Retail Format Inspired by Social Needs and Philanthropy - Case of Croatia", in Kantarelis, D. (Ed.), Global Business & Economics Anthology, Business & Economics Society International, Danvers, MA, USA, pp. 278-286.
- Smigielska, G., Knezevic, B., Maric, I. (2016), "Social Supermarkets as the New Dimension of CSR and their Contribution to Sustainable Development", Handel wewnetrzny w Polsce 2011-2016, Vol. 2016, No. 3, pp. 329-344.

## **CUSTOMER ORIENTED STRATEGY AND BUSINESS PERFORMANCE: EVIDENCE FROM THE TOURISM AND HOSPITALITY INDUSTRY**

**Kriemadis,Thanos; Papaioannou, Alkistis; Rizos John; Koronios,Konstantinos**

Department of Sport Management, University of Peloponnese, Greece.

### **ABSTRACT**

#### **PURPOSE OF THE STUDY**

Customer orientation provides competitive advantage and increases profit of organizations (Shah, Rust, Parasuraman, Staelin & Day, 2006). Moreover, research has suggested that customer oriented strategy creates value for the customers and increases customers' loyalty (Macintosh, 2005, Shah et al.,2006) which in turn results in sales growth and hence firm performance (Asikhia, 2010). Since customer orientation affects customers' loyalty and satisfaction, customer oriented strategy has become an essential ingredient for the long-term success of the organizations (Matin, Jandaghi, Khanifar & Heydari, 2009). However, research regarding customer oriented strategy in tourism and hospitality industry is still limited.

The primary purposes of this study were: (a) to determine the extent to which customer oriented strategy is implemented to five-star hotels of Greece, and (b) to examine the relationship between customer oriented strategy used by Greek five-star hotels and business performance (profit, ROI, sales volume and market share).

#### **DESIGN/METHODOLOGY/APPROACH**

The research was addressed to to all five-star hotels of Greece (317 five-star hotels, which recognised by Hellenic chamber of hotels) and involved 317 experienced managers who were the most knowledgeable regarding marketing issues. Responses were received from 159 managers of 159 five-star hotels with a 50.2% response rate.

For the purpose of this study a 40-item questionnaire, was used (developed by Whiteley 1991) focusing on customer oriented strategy. The questionnaire was translated and modified by a panel of experts in the fields of hospitality marketing, business management and strategic marketing, in order to provide information on how managers see themselves in terms of the customer oriented strategy process, using a five point Likert scale. The reliability of the scale was found to be  $\alpha = .89$ . Also, the particular research used the subjective way of measuring performance. This means that managers were asked to evaluate the performance of their hotel in relation to their current years' objectives, in

relation to their last financial years' objectives and finally, in relation to their major market competitors on a five-point Likert scale. On each of the three bases, performance was judged against four criteria two financial (profit and ROI) and two market based (sales volume and market share). The above criteria were adapted from the literature (Terzoudis, 2011). The study was a quantitative design and the analysis was exploratory in nature. Descriptive statistics and Pearson correlation were used to examine variables relationship using SPSS software (version 22).

## FINDINGS

The results (means) indicated that customer oriented strategy is applied to a great extent from Greek five-star hotels ( $M=4.44$ ,  $SD=0.55$ ). Also, there were significant and positive relationships between the customer oriented strategy and business performance in the Greek five-star hotels. More specifically, customer oriented strategy had a significant and positive relationship with: (a) profit ( $r=.209$ ,  $p=.008$ ), (b) ROI, ( $r=.305$ ,  $p=.000$ ) and (c) market share ( $r=.218$ ,  $p=.006$ ), as measured by satisfaction levels in relation to current year's objectives. Furthermore, customer oriented strategy had a significant and positive relationship with: (a) ROI ( $r=.169$ ,  $p=.033$ ) and (b) market share ( $r=.171$ ,  $p=.031$ ), as measured by satisfaction levels in relation to last financial year's objectives. Finally, customer oriented strategy had a significant and positive relationship with: (a) profit ( $r=.256$ ,  $p=.001$ ), (b) ROI ( $r=.263$ ,  $p=.001$ ) and (c) market share ( $r=.191$ ,  $p=.016$ ), as measured by satisfaction levels in relation to their major market competitors' objectives. The findings of the present study are consistent with previous studies on customer oriented strategy and business performance, in service and business sector (Asikhia, 2010; Li & Zhou, 2010; Shah, et.al., 2006), and show that the level of customer oriented strategy which managers exercised in five-star hotels is related to the hotels' performance. The present findings add credence to the argument that customer oriented strategy is a major factor for tourism and hospitality business activity, because it provides the Greek five-star hotels with a better understanding of their customers, which subsequently leads to enhanced business performance (Asikhia, 2010; Li & Zhou, 2010).

## RESEARCH LIMITATIONS

The study was delimited to a questionnaire designed to collect data regarding customer oriented strategy according to Whiteley (1991).

The following were acknowledged as the limitations of the study:

- The honesty, accuracy, and objectivity of the respondents when completing the questionnaire
- The respondent's level of understanding of the customer oriented strategy vocabulary.

Follow-up studies should be done to the same sample in three to five years to investigate possible changes in the utilization of the customer oriented strategy process. Areas of further research could also include measuring the impact of customer oriented strategy on the satisfaction and loyalty of customers.

## **ORIGINALITY/VALUE**

This study is useful in extending the concept of customer oriented strategy to the tourism and hospitality industry. The study will be useful in helping managers to their further understanding of the customer oriented strategy process in their respective organization.

Keywords: Customer oriented strategy, tourism and hospitality industry, five-star/luxury hotels.

## **REFERENCES**

- [1] Asikhia, O. (2010), "Customer Orientation and Firm Performance among Nigerian Small and Medium Scale Businesses", *International Journal of Marketing Studies*, Vol.2 No.1, pp.197-213.
- [2] Li, J.J., and Zhou, K.Z. (2010), "How foreign firms achieve competitive advantage in the Chinese emerging economy: Managerial ties and market orientation" *Journal of Business Research*, Vol.63 No.8, pp. 856-862.
- [3] Macintosh, G. (2005), "Customer orientation, relationship quality, and relational benefits to the firm", *Journal of Services Marketing*, Vol. 21 No.3, pp.150-159.
- [4] Matin, H.Z., Jandaghi, G., Khanifar, H., and Heydari, F. (2009), "Designing a competent organizational culture model for customer oriented companies", *African Journal of Business Management*, Vol.3 No.7, pp. 281-293.
- [5] Shah, D., Rust, R.T., Parasuraman, A., Staelin, R., and Day, G. S. (2006), "The Path to Customer Centricity", *Journal of Service Research*, Vol. 9 No. 2, pp.113-124.
- [6] Terzoudis, Ch. (2011), "Strategic marketing planning process applied to the greek professional sport clubs", (Unpublished doctoral dissertation). University of Peloponnese, Sparta.
- [7] Whiteley, R.C. (1991), "The customer-driven company: Moving from talk to action", Addison-Wesley, Reading, MA.

## REMITTANCE BEHAVIOR OF PERMANENT MIGRANTS

Kushnirovich Nonna

Department of Economics and Management, Ruppin Academic Center, Emek Hefer, Israel

### ABSTRACT

The growing literature on remittances is mostly devoted to remittance behavior of temporary migrant/guest workers and the impact of their remittances on macroeconomic variables. However, little is known about the remittance behavior of permanent migrants, who brought their families to the host country and did not leave households behind in the country of origin. This study aims to fill the gap by focusing on the special case of migrant citizens in Israel who live there permanently. The study examines remittance behavior of immigrants, determinants of their propensity to remit, and investigates the relationship between immigrants' integration and maintaining social transnational ties focusing on their impact on remittance behavior.

The literature distinguished six main motives to remit (Rapoport and Docquier; 2005; de Haas; 2007): altruism (Agarwal and Horowitz, 2002; Lucas and Stark, 1985; Stark, 1991), exchange motive (Cox, Eser and Jimenez, 1998), inheritance motive (Hoddinott, 1994), strategic motive (Rapoport and Docquier, 2005; Stark, 1995), insurance and investment (Amuedo-Dorantes and Pozo, 2005; de la Brie`re et al., 2002; Holst et al., 2008; Stark, 1995; Thieme, 2006). Insurance and investment models are based on the theory of new economics of labor migration (NELM) developed by Stark (1991).

Alternative models of remittance behavior are based on a concept of globalization and transcontinental life of migrants. Persons can migrate permanently, but developed communication and transportation allow them to keep in touch with their former home countries over the years. Members of this group are often considered "transnationals", namely, persons who live in a host country but maintain social and economic ties with their country of origin (Glick-Schiller, 1999; Holst and Simpson, 2008; Sana and Massey, 2005).

Determinants of remittance behavior are widely discussed in the literature. Personal characteristics, such as age, migrant's income, education, and time since arrival may affect remittance decisions (Amuedo-Dorantes and Pozo, 2005; Durand et al., 1996; Fairchild and Simpson, 2008; Sana and Massey, 2005), as well as return intentions, and maintenance of transnational social ties (Carling and Hoelscher, 2013; Fokkema et al., 2013; Loschmann and Siegel, 2015). The level of integration into the host country also should affect remittance behavior of immigrants (Holst et al., 2008). However, the relationship between integration and remittances is not unequivocal. On the one hand, integration leads to weakening ties to the country of origin and its community; hence, it should negatively affect

remittances. On the other hand, integrated immigrants earn more, and larger income is associated with higher probability to remit.

Immigrants from some countries remit more than others (Durand et al., 1996; Lopez-Cordova, 2005). For example, Holst et al. (2008) found that permanent migrants from former Yugoslavian countries showed a higher propensity to remit than Italians did. The study of Durand et al. (1996) revealed that economic conditions in the sending communities are significantly related to migrants' remittances. According to Holst et al. (2008), "(Spaet)Aussiedlers", most of whom are migrants from the former Soviet states, show a higher probability to remit to their countries of origin, many of which are low-income economies.

This study developed a model of remittance behavior adjusted to the case of permanent migrant citizens. According to this model, remittance behavior of permanent migrants is affected by their socio-economic characteristics, migration experience, integration in the host country, maintaining social ties with the country of origin, and intentions to leave the host country. The model was tested on the data of the 2011 Immigrant Survey that was conducted by the Israeli Central Bureau of Statistics. The sample of the survey was representative of the population of immigrants in Israel and included 3,952 immigrants from the Former Soviet Union (FSU), Asia and Africa, and Europe and America. The data were collected via a postal survey questionnaire, internet and telephone interviews.

The study found significant differences in the likelihood of remitting between immigrants from different origins. FSU immigrants were more likely to remit than immigrants from the rest of the world. One possible explanation is that for FSU immigrants, economic aspirations were more important in their decision to migrate than for other groups of immigrants (Amit, 2010; Cohen, Haberfeld and Kogan, 2011). Permanent immigrants, who migrated for economic reasons, may be more inclined to remit because they want to support their relatives in the country of origin who could not migrate with them. The pattern of remittance behavior of FSU immigrants can be representative of other groups of immigrants worldwide, for whom economic and employment motives were important in their decision to immigrate.

Social integration in the host country had a positive impact on the propensity to remit, but the length of living in the host country has a negative effect. The findings of the study support the remittance decay theory. Overall, the study revealed that remittance behavior of migrant citizens who immigrated together with their nuclear families and have low likelihood to return to their countries of origin, is fueled by mixed motives: altruism and self-interest insurance. These motives are not necessarily exclusive and can intertwine. However, contrary to temporary short-term migrants, the altruism motive is dominant in the case of migrant citizens.

This study contributes to a better understanding of remittance determinants and provides a clearer view of the migrant's decision-making process. Understanding the differences in remittance behavior between different groups of immigrants can help clarify the various economic and financial roles that these groups play.

The study had some limitations. The data of the Immigrant Survey does not contain information about the sums of remittances, nor the remittance rates of the veteran Israeli population, thus preventing comparison with remittance rates of immigrants. The study revealed that immigrants' remittance rates drop with time, but the question whether they become equivalent to those of the veteran population or still remain higher remains unclear, and can be an issue for subsequent research.

*Keywords: Remittance Behavior, Immigrants, Altruism, Integration, Transnationalism*

## REFERENCES

- Agarwal, R. and Horowitz, A.W. 2002. "Are international remittances altruism or insurance? Evidence from Guyana using multiple-migrant households". *World Development*, 30 (11): 2033–2044.
- Amuedo-Dorantes, C., and Pozo, S. 2005. "On the use of differing money transmission methods by Mexican immigrants". *International Migration Review*, 39: 554–76.
- Cox, D., Eser, Z. and Jimenez, E. 1998. "Motives for private transfers over the life cycle: An analytical framework and evidence for Peru". *Journal of Development Economics*, 55: 57- 80.
- de Haas, H. 2007. *Remittances, Migration and Social Development. A Conceptual Review of the Literature*. Geneva: United Nations Research Institute for Social Development (UNRISD).
- de Haas, H. 2010. "Migration and development: A theoretical perspective". *International Migration Review* 44 (1): 227-264.
- de la Briere, B., Sadoulet, E., de Janvry, A. and Lambert, S. 2002. "The roles of destination, gender, and household composition in explaining remittances: An analysis of the Dominican Sierra". *Journal of Development Economics*, 68: 309–28.
- Durand, J., Kandel, W., Parrado, E. A. and Massey, D. S. 1996. "International migration and development in Mexican communities". *Demography*, 33: 249–64.
- Fairchild S.T. and Simpson, N. 2008. "A comparison of Mexican Migrant remittances across U.S. regions". *Contemporary Economic Policy*, 26 (3): 360–379.
- Hoddinott, J. 1994. "A model of migration and remittances applied to Western Kenya". *Oxford Economic Papers*, 46: 450-75.
- Holst, E. S. Schäfer, A. and Schrooten, M. 2008. *Bringing Home the Money: Xenophobia and Remittances - The Case of Germany*. Berlin: Deutsches Institut für Wirtschaftsforschung.
- Glick-Schiller, N. 1999. "Transmigrants and nation-states: Something old and something new in the U.S. immigrant experience". In *The Handbook of International Migration: The American Experience*, eds. Charles Hirschman, Philip Kasinitz, and Josh DeWind, New York: Russell Sage Foundation: 94-119.
- Lopez-Cordova, E. 2005. "Globalization, migration, and development: The role of Mexican migrant remittances". *Economia*: 217–56.
- Lucas, R.E.B. and Stark, O. 1985. "Motivations to Remit: Evidence from Botswana". *Journal of Political Economy*, 93: 901-918.
- Rapoport H. and Docquier, F. 2006. The economics of migrants' remittances. *Handbook of the economics of giving, altruism and reciprocity*, 2, 1135–1198.
- Sana, M. and Massey, D.S. 2005. "Household composition, family migration, and community context: Migrant remittances in four countries". *Social Science Quarterly* 86 (2): 509-528.
- Stark, O. 1991. *"The Migration of Labor"*. Cambridge, MA: Basil Blackwell.
- Stark, O. 1995. *"Altruism and Beyond"*. Oxford and Cambridge: Basil Blackwell.

Thieme, S. 2006. "Social networks and migration: Far West Nepalese labour migrants in Delhi". Münster: LIT Publishing House.



# INNOVATIVE SKILLS MANAGEMENT FOR THE AGRICULTURAL ENTREPRENEUR

Lachapelle, Nathalie

Business School, TELUQ University, University of Quebec, Quebec, Canada

## ABSTRACT

Entrepreneurship knowledge in the agricultural sector is limited. This contribution deals with the intrinsic links of the innovation process and management by the entrepreneur for the survival of his SME.

Our research aims at explaining the innovation process of Entrepreneurs by combining the different approaches in the field of Entrepreneurship presented in the Pyramid of Julien (2005) to the Knowledge Creation model of Nonaka and Takeuchi (1995). The theoretical framework is based on the model of Nonaka and Takeuchi but also fourteen other authors. The proposed conceptual framework incorporates three dimensions: 1) the Owner-Manager Entrepreneur, 2) the Organization and its Management of Knowledge, 3) the Environment, with its challenges and constraints. In order to test the conceptual framework, the Agricultural sector was chosen. Owners-Managers of Small and Medium-sized Enterprises (SME) have a specific Entrepreneurial culture, because this domain intrinsically imposes limits on product innovation due to its nature and Low Technological content. Yet little empirical research has been done in this industry to test the application of the Entrepreneurship disciplines in this sector. A multi-case methodology was developed for 11 SME producers and managers. The empirical study's analysis of results supports the different approaches, interdependencies and variables on which the four Triangles (Entrepreneur, Environment, Community, Time) that make up the Entrepreneurial Pyramid are based. This contribution deals with the intrinsic links in the Innovation Process and Management by the Producer-Manager Entrepreneur in order to ensure the survival of his SME. Future research perspectives are suggested to further integrate the fields of Entrepreneurship and Innovation Management.

*Keywords: Entrepreneur, Agricultural Entrepreneur, Owner-Manager, SME, Management, Managerial Skills, Knowledge Management, Innovation Process, Product Innovation.*

## REFERENCES

- De Bruyne, P. (1981), *Modèles de décision : Les rationalités de l'action*, Louvain-la-Neuve, Belgium.  
De Lauwere, C.C. (2005), "The role of agricultural entrepreneurship in Dutch agriculture of today", *Agricultural Economics*, Vol. 33, pp. 229-238.

- Filion, L.J. (1990), "Vision and Relations: Elements for an Entrepreneurial Metamodel", Tenth Annual Babson Entrepreneurship Research Conference, Babson College, MA., April 4-6.
- Filion, L.J. (2004), "Operators and Visionaries: Differences in the Entrepreneurial and Managerial Systems of Two Types of Entrepreneurs", *International Journal of Entrepreneurship and Small Business*, Vol. 1 No. 1, pp. 35-55.
- Filion, L.J. (2007), *Management des PME. De la création à la croissance.* (sous la direction de L.J. Filion), Éditions du Renouveau Pédagogique Inc., Québec, Canada.
- Filion, L.J. and Lima, E. (2011), "Le partage de la vision dans les très petites entreprises", *Entreprendre & Innover*, Vol. 9 No. 10, pp. 7-20.
- Jamrog, J.; Vickers, M. and Bear, D. (2006), "Building and sustaining a culture that support innovation", *Human Resource Planning*, Vol. 29 No. 3, pp. 9-19.
- Julien, P.A. (2005), *Entrepreneuriat régional et économie de la connaissance. Une métaphore des romans policiers.* Presses de l'Université du Québec, Québec, Canada.
- Mintzberg, H. and Westley, F. (2001), "Decision Making: It's Not What You Think", *MIT Sloan Management Review*, Vol. 42 No. 3, pp. 89-93.
- Nonaka, I. (1991), "The knowledge creating company", *Harvard Business Review*, Vol. 69, No. Nov-Dec, pp. 96-104.
- Nonaka, I. and Takeuchi, H. (1995), *The Knowledge-Creating Company: How Japanese Companies Create the Dynamics of Innovation*, Oxford University Press, New York, NY.
- Nonaka, I., Konno, N. and Toyama, R. (2001), Emergence of "BA": A conceptual framework for the continuous and self-transcending process of knowledge creation. In: Nonaka I. Nishigushi t. 2001. *Knowledge emergence: Social, technical and evolutionary dimensions of knowledge creation*, Oxford, pp. 3-29.
- Polanyi, M. (1962), *Personal Knowledge, Towards a Post-Critical Philosophy*, Harper Torchbooks, New York, NY.
- Polanyi, M. (1967). *The tacit dimension.* Routledge and Keoan Paul, London, GB.
- Popadiuk, S. and Choo C.W. (2006), "Innovation and knowledge creation: How are these concepts related?", *International Journal of Information Management*, Vol. 26, pp. 302-312.
- Simon, A.H. (1986). *Decisions Making and Problem Solving*, available at: [www.dieoff.org/p163.htm](http://www.dieoff.org/p163.htm), p. 1-37. (accessed 20 June 2012).
- Trienekens, J.; Van Uffelen, R.; Debaire, J. and Omta, O. (2008), "Assessment of innovation and performance in the fruit chain - The innovation-performance matrix", *British Food Journal*, Vol. 110 No. 1, pp. 98-127.
- Tuomi, I. (1999), *Corporate Knowledge: Theory and Practice of Intelligent Organizations*, Metaxis Arkadiankatu, Finland.
- Van der Veen, M. (2010), "Agricultural innovation: Invention and adoption or change and adaptation?", *World Archaeology*, Vol. 42, No. 1, pp. 1-12.

## FOR THE STUDY OF DEVELOPMENT GOVERNMENTAL STRATEGY TO SUPPORT THE ENTREPRENEURIAL EDUCATION IN GEORGIA

**Lekashvili, Eka**

Economic Policy Department at Iv. Javakhishvili Tbilisi State University, Tbilisi, Georgia

### **ABSTRACT**

At present Georgian Economy faces new challenges, among which is economic development and increased unemployment. Theoretical research (Solow, 1988, Romer, 1994, Mark Grant and Mac Millan , 2000, Aidis, 2005, and others) and practical experience prove that the development of entrepreneurship is the main solution to these problems. Propensity to entrepreneurship and entrepreneurial activities are different across countries. The positive job creation, innovation and competition effects gained from the development of entrepreneurship are further increased by economic growth gains, which are redistributed and controlled by the state. Generally, entrepreneurship and economic growth require that the need for economic education be generated. This goal can be achieved by means of effective educational and entrepreneurship development policies.

The goal of the research is to study entrepreneurship education problems in Georgia in frame of development governmental strategy.

The research objectives include: discussion of features of entrepreneurship in transitional period Georgia, based on which defined the policy instruments for transferring entrepreneurial way of thinking; Study the policy problems of transferring entrepreneurial education in Georgia; Make recommendations, based the experience of EU, for development governmental strategy to ensure entrepreneurship education in Georgia.

Development of entrepreneurship in Georgia was hindered underdevelopment of entrepreneurship education, absence of entrepreneurship culture which led to low quality of management and administration. Ineffective institutional reforms; imperfect entrepreneurship legislation, low degree of internationalization of functional levels of business; low tax culture and social responsibility, etc.

By categorizing these problems it becomes obvious that the development of competitive business and entrepreneurship activities are impeded by low level of entrepreneurship education and way of thinking.

Implementation of the European approach towards entrepreneurship education needs systematization of inter-relationships and promotion of research activities; sharing European experience in the field of entrepreneurship education; adoption of new teaching methods and learning materials in entrepreneurship courses; creation of the grounds for sustainable cooperation; creation of the grounds

for action plan for future cooperation; intensification of the academic ties and transnational relationships, etc.

In order to upgrade entrepreneurship quality and culture it is reasonable to interfere in educational system and implement entrepreneurship education initiatives. Improvement of entrepreneurship skills and potential needs: Formation of entrepreneurship culture; Educational support; Support for entrepreneurship-related institutions; Support for mentor initiatives; Education and life-long learning; Workforce flexibility and employment; Generation and implementation of high tech knowledge; Financial support; Support for research initiatives; Protection of patents and copyrights, etc.

Thus at the current stage studying the European experience in order to upgrade entrepreneurship education the state should resolve the following concrete tasks: Develop governmental strategy to support the entrepreneurship education and declare it as one of the priorities of the state policy; Develop national strategies of entrepreneurship and implement them at every step of education; Take adequate actions at public, regional and local administration levels; Form coordinating groups at the state level consisting of civil organizations, businesses, educational institutions, students and representatives of other organizations; Promote teacher and student mobility among countries, higher educational institutions and private sectors in order to enhance the development of entrepreneurship education; Promote entrepreneurship education projects within the programs supported by the European funds; Finance and support for the educational activities which contribute to the improvement of entrepreneurship education; Work out and implement flexible financial, fiscal, tax incentives for entrepreneur agents in order to build contacts with Universities; Implement practice-based learning in entrepreneurship education by engaging students into certain entrepreneurship projects; Organize information actions at schools and public areas for the popularization of entrepreneurship; Engage entrepreneurs into educational programs; stimulate close relationships of students with companies and entrepreneurs; Help entrepreneurs and business people to develop pedagogical skills on the part of educational institutions; Implement adequate programs for self-employment and starting enterprises, etc.

After the entrepreneurship activity optimization, the state can expand entrepreneurship by means of entrepreneurship development measures, subsidizing, entrepreneurship risk reduction, entrepreneurship potential growth, and support for innovation adoption, entrepreneurship popularization and use of other supportive tools.

*Keywords: Entrepreneurial Education; Development Strategy; Economy of Georgia; Transformation.*

## REFERENCES

- Aidis, R. (2005), "Entrepreneurship in transition countries. Centre for the Study of Economic and Social Change in Europe", SSEES, UCL: London, UK.
- "Entrepreneurship Education and Learning". Implementation of „Education and Training 2010“. European Commission. Work Programme. November, 2004.
- "Entrepreneurship Education: A Guide for Educators". European Commission. Bruxelles, Enterprise and Industry. June 2013.
- "Intelligent training needs assessment and open educational, Resources to foster entrepreneurship". Lifelong Learning Programme. KA3 - ICT Multilateral Projects, "Training needs identified in relation to entrepreneurship", 2014.
- Johannisson, B. (1991), "University training for entrepreneurship: A Swedish approach", *Entrepreneurship and Regional Development*, Vol.3 (1), pp.67-82;
- Lekashvili, E.(2015), "Entrepreneurial Way of Thinking and Its Development Challenges in Georgia". L'Association 1901 „SEPIKE“, Journal, Ausgabe 8,m Osthofen, Deutschland, Patiers, France, Los Angeles, USA. 31.03.15.pp. 121-126. ISSN 2196-9531; e- ISSN 2372-7438;
- Lekashvili E.(2017), International Assessments analyses of Systemic Transformation of Georgia's Economy, 17th Congress of WOSC „Science with and for Society – Contributions of Cybernetics and Systems“ , Sapienza University the Rome (Italy). 2017-01-25. (Abstract Books: B2-113).
- Romer, P.M. (1994), "The Origins of Endogenous Growth", available at: *The Journal of Economic Perspectives* .Vol. 8, No. 1, Winter, 1994. American Economic Association. pp. 3-22. (accessed 5 April 2017).
- Rahe, M. and Morales, (C. 2006), "Entrepreneurship. Entrepreneurial Skills". Report. EADA. R+D+I Department.
- Tautila, P. V. (2010)," Learning entrepreneurship in higher education", *Education and Training*, Vol. 52, No1, pp.48-61.
- Solow, M. (1988), "Growth Theory and After", available at: *The American Economic Review*.Vol. 78, No. 3, Jun., 1988. pp.307-317. (accessed 5 April 2017).
- Van Stel, A. Carree, M. Thurik, R. (2005), "The Effect of Entrepreneurial Activity on National Economic Growth", André van Stel, Martin Carree, Roy Thurik. *Small Business Economics*. April 2005, Volume 24, Issue 3, pp 311-321, (accessed 5 April 2017).

## AVAILABILITY OF CAR RENTAL AS AN ALTERNATIVE OF CAR OWNERSHIP

Leontyeva, Yulia<sup>1</sup>; Mayburov, Igor<sup>2</sup>

<sup>1</sup>Ural Federal University named after the first President of Russia B.N. Yeltsin, Russia

<sup>2</sup>Ural Federal University named after the first President of Russia B.N. Yeltsin, Russia; Far Eastern Federal University, Russia

### ABSTRACT

The article considers the issues of the availability of car rental in urban areas in different countries. An overview is done of scholarly work on the factors influencing people's decision whether to own and use a car. A conclusion is made that apart from the factor of cost the decision is shaped by the availability of alternative modes of transport. The authors prove that it is necessary to create an all-encompassing system of public transport that would provide alternative modes of transport, including taxis and car rental that target customers who are not prepared to give up personal cars. It is proven that the availability of car rental could serve as an alternative to car ownership for a certain part of people living in urban areas. The authors analyze types of car rental services and considers different levels of availability of the services to different categories of customers. The authors propose a method of conducting a comparative analysis of the availability of car rental services. The subject of the research is car rental services in three types of cities. The authors picked the cities with a high, medium and low intensity of private car use. The study assesses the cost of car rental in each city type under identical parameters of car brand and rental period and timing. A conclusion is made that there is a substantial difference in affordability and actual availability of car rental services. The authors substantiate an assumption that a wide range of car rental services and their affordability can be a significant alternative for city dwellers who do not use a car regularly. The article argues that car rental is not developed enough in Russian cities and analyzes factors that lead to the Russian cities lagging behind in adopting a systemic approach to the provision of such services. The aim of the research is to assess the availability of rental car and to establish the service availability factor as a crucial element of transport policy in urban areas that seeks to diversify modes of transport.

## THE EFFECT OF DIGITAL VARIABLES ON PERCEIVED EMPLOYABILITY IN AN ETHNIC MINORITY AND HEGEMONIC GROUP

Lissitsa, Sabina<sup>1</sup>; Chachashvili-Bolotin, Svetlana<sup>2</sup>

<sup>1</sup>School of Communication, Ariel University, Israel

<sup>2</sup>School of Social & Community Sciences, Ruppin Academic Center, Israel

### ABSTRACT

#### *Introduction*

Employability refers to an employee's chance of finding alternative employment, either on the internal or external labour market (Forrier & Sels 2003). As a result of fundamental changes in the labour market, such as the growth in temporary employment, globalization and new technologies, along with organizational restructuring and downsizing (De Witte 1999; Quinlan et al., 2001) employability has become a key element in work life (Silla et al., 2009).

The diffusion of information and communication technologies (ICTs) demands changing work skills, which has the effect of expanding employment opportunities while imposing new demands on disadvantaged groups (Garrido, Sullivan & Gordon, 2010). The situation may get worse because of the fast pace of new technological developments, shortened 'lifecycles' of ICT skills, and the need for continuous learning (CEPIS, 2006). However, the impact of ICT adoption on employability has not yet received proper attention.

The current research is aimed at addressing this lacuna by examining the extent to which different aspects of Information Technologies (IT) diffusion (digital skills and digital uses) have modified perceived employability in a unique Israeli context which is characterized by a deep divide between the Jewish majority and the Arab minority.

#### *Methods*

This study based on data from a nationwide Annual Social Survey which was conducted by Israel's Central Bureau of Statistics (CBS) using a representative sample of 7500 respondents. From the total sample, respondents aged 20-65 were filtered who were employed or self-employed. Our sample included 4,085 such respondents, of these 3,546 Jews and 539 Arabs.

#### *Analysis*

In order to understand which digital skills and uses, if any, might predict perceived employability, we ran an ordinal regression model in two stages. In the first stage we entered all demographic and labor

market variables. In the second stage digital variables were added. For a deeper understanding of the differences between Jews and Arabs in the effects of the independent and control variables on perceived employability, we conducted the regression analysis separately for Jews and Arabs.

### *Discussion*

Our important finding is that digital skills were positively correlated with perceived employability among both groups. Therefore ICT skills can be seen as '*gateway skills*' without which a person's likelihood of finding employment would be significantly reduced (Green et al., 2012; Garrido, Sullivan & Gordon, 2010). Moreover, in contrast to other powerful factors impacting perceived employability (objective economic situation and personal perceptions, occurrences in the employee's immediate private and organizational circle, personal traits) these factors can be altered with relative ease, if digital literacy becomes an important goal in the national agenda.

Our findings show the positive correlation between Internet use for study and perceived employability. Internet use for study provide users from the ethnic majority group with the opportunity to leave the cycle of failure by utilizing distance learning opportunities relevant for formal and informal education, which may increase employability in the short run and facilitate career advancement in the long run. However, among Arabs the effect of Internet use for study on the dependent variable was insignificant. We speculate that as a result of discrimination in the labor market, Arab respondents feel that the knowledge acquired through Internet use might not improve their chances in competition with the majority group.

Unlike the research literature, which indicates the effectiveness of "weak ties" (see Granovetter, 1983) in finding jobs, our findings show insignificant correlations between social media use and perceived employability in both groups. We can speculate that in the evaluation of their chances to find a comparable new job, employees base themselves on their human capital, labor market perception and perhaps on strong ties available offline, but not on weak ties created in the world of virtual reality. Another explanation may be that people are aware of the potential harm that exposing personal information in social networks may have on preserving current jobs and finding new employment, which offsets the usefulness of disseminating relevant information and developing weak ties that may assist in finding jobs.

Our findings show a negative correlation between e-mail use and perceived employability among Arabs and an insignificant association between these variables among Jews. In recent years, as social media have expanded, e-mail has become a more formal tool of communication, while social media have become staples of the more private sphere. We speculate that the negative correlation found among Arabs may be a strong negative reaction to multiple experiences of lack of responses



from potential employers to CVs sent by e-mail, as a result of discrimination in the labor market, which is reflected in lower perceived employability.

*Keywords: perceived employability; digital inequality; digital skills; digital uses; social media; Jews and Arabs in Israel; ethnic minority.*

## REFERENCES

- CEPIS (2006) ICT Skills Certification in Europe. Available at:  
[http://www.cedefop.europa.eu/etv/Upload/Information\\_resources/Bookshop/431/6013\\_en.pdf](http://www.cedefop.europa.eu/etv/Upload/Information_resources/Bookshop/431/6013_en.pdf)
- De Witte, H. (1999). Job insecurity and psychological well-being: Review of the literature and exploration of some unresolved issues. *European Journal of Work and Organizational Psychology*, 8(2), 155–177.
- Quinlan, M., Mayhew, C., & Bohle, P. (2001). The global expansion of precarious employment, work disorganization, and consequences for occupational health: A review of recent research. *Globalization and Occupational Health*, 31(2), 335–414.
- Forrier, A. and Sels, L. (2003). The concept employability: A complex mosaic. *International Journal of Human Resource Development and Management* 3(2), 102–124.
- Garrido, M., Sullivan, J. and Gordon, A. (2010). Understanding the links between ICT skills training and employability: an analytical framework. In *Proceedings of the 4th ACM/IEEE International Conference on Information and Communication Technologies and Development* (p. 15). ACM.
- Granovetter, M.S. (1973). The strength of weak ties. *American Journal of Sociology* 78: 1360-1380.
- Green, A.E., Li, Y., Owen, D. and de Hoyos, M. (2012). Inequalities in use of the internet for job search: similarities and contrasts by economic status in Great Britain, *Environment and Planning*, 44 (10), 2344-2358.
- Silla, I., De Cuyper, N., Gracia, F.J., Peiró, J.M. and De Witte, H. (2009) Job insecurity and well-being: Moderation by employability. *Journal of Happiness Studies* 10(6): 739-751.
- Sullivan, S.E. and Baruch, Y. (2009). Advances in career theory and research: a critical review and agenda for future exploration. *Journal of Management* 35 (6): 1542-1571.

# EXPOSURE TO BULLYING AND JOB BURNOUT: THE PROTECTIVE ROLE OF JOB RESOURCES

Livne, Yael; Goussinsky, Ruhama

Department of Human Services, Yezreel Valley College, Yezreel Valley, Israel

## ABSTRACT

## INTRODUCTION

Workplace bullying, defined as repeated inappropriate and hostile behavior intended to harm, intimidate, degrade or humiliate others (Einarsen et al., 2003), is a major work stressor, bearing destructive consequences for targets as well as organizations. It is a widespread phenomenon in organizations and is especially common in the healthcare sector (Zapf et al., 2011). Exposure to bullying is associated with a range of negative outcomes, including impaired work performance and employee burnout (Nielsen and Einarsen, 2012). The experience of burnout by health care professionals can negatively affect the quality of care provided to patients (Sharma and Dhar, 2016). Therefore, it is of special interest to examine how the harmful effect of workplace bullying can be reduced.

The present study adopts the Job-Demands-Resources (JD-R) theory (Bakker and Demerouti, 2014) to examine the relationship between workplace bullying and employee burnout, and the moderating role of control-related resources in this relationship. Drawing on this theory, it is first hypothesized that workplace bullying will be positively related to burnout, since it constitutes a job demand that elicits an energy depleting process. Second, it is hypothesized that job autonomy and occupational self-efficacy will moderate the positive relationship between workplace bullying and burnout, because they act as resources that increase employees' sense of control over their work tasks, therefore allow them to defend themselves more assertively in the face of bullying (Rousseau et al., 2014), and elicit effective coping (Pisanti et al., 2008).

The present research aims to investigate the role of control-related resources, i.e., job autonomy and occupational self-efficacy, in the relationship of workplace bullying and burnout among health care employees.

## METHODOLOGY

The study was conducted with two samples of healthcare employees in Israel; 309 workers of a mental health hospital from several occupational groups, and 105 students for bachelor's degree who were

employed as nurses in various settings. Data were collected using anonymous questionnaires which were filled out during work hours (in sample 1) or during class hours (in sample 2).

## FINDINGS

The hypotheses were tested using hierarchical regression analyses. First, workplace bullying predicted burnout dimensions even after controlling for negative affectivity in both samples ( $\beta = .25$ ,  $p < .001$  for emotional exhaustion and  $\beta = .28$ ,  $p < .001$  for depersonalization in sample 1;  $\beta = .26$ ,  $p < .05$  for emotional exhaustion and  $\beta = .24$ ,  $p < .05$  for depersonalization in sample 2). Second, workplace bullying significantly interacted with job autonomy in predicting emotional exhaustion in sample 1 ( $\beta = -.15$ ,  $p < .05$ ), and in predicting depersonalization in sample 2 ( $\beta = -.15$ ,  $p < .05$ ). Specifically, workplace bullying was more strongly related to emotional exhaustion for employees with lower rather than higher than average job autonomy. Finally, the interaction of workplace bullying and occupational self-efficacy showed a significant effect on depersonalization in sample 1 only ( $\beta = -.16$ ,  $p < .05$  in sample 1).

## IMPLICATIONS

This study adds to a growing body of literature suggesting that workplace bullying is a major stressor that detrimentally affects employees' well-being. Its main contribution is in pointing to the protective function of job autonomy and occupational self-efficacy as control-related resources that enable healthcare employees to reduce the detrimental effects of workplace bullying. Practically, the findings imply that to promote high-quality patient care, management should primarily act to prevent workplace bullying, alongside with increasing employees' job autonomy and occupational self-efficacy.

*Keywords: burnout, healthcare, job autonomy, occupational self-efficacy, workplace bullying.*

## REFERENCES

- Bakker, A.B. and Demerouti, E. (2014), "Job Demands–Resources Theory", *Wellbeing*, Vol. 3 Part 2, pp. 1–28.
- Einarsen, S., Hoel, H., Zapf, D. and Cooper, C.L. (2003), "The concept of bullying at work: The European tradition", In S. Einarsen, H. Hoel, D. Zapf & C. L. Cooper (Eds.), *Bullying and Emotional Abuse in the Workplace: International Perspectives in Research and Practice* (pp. 3–30), Taylor & Francis, London.
- Nielsen, M.B. and Einarsen, S. (2012), "Outcomes of exposure to workplace bullying: A meta-analytic review", *Work & Stress*, Vol. 26 No. 4, pp. 309-332.
- Pisanti, R., Lombardo, C., Lucidi, F., Lazzari, D. and Bertini, M. (2008), "Development and validation of a brief Occupational Coping Self-Efficacy Questionnaire for Nurses", *Journal of Advanced Nursing*, Vol. 62 No. 2, pp. 238-247.
- Rousseau, M.B., Eddleston, K.A., Patel, P.C. and Kellermanns, F.W. (2014), "Organizational resources and demands influence on workplace bullying", *Journal of Managerial Issues*, Vol. 26 No. 3, pp. 286-313.

Sharma, J. and Dhar, R.L. (2016), "Factors influencing job performance of nursing staff: mediating role of affective commitment", *Personnel Review*, Vol. 45 No. 1, pp. 161-182.

Zapf, D., Escartín, J., Einarsen, S., Hoel, H. and Vartia, M. (2011), "Empirical findings on prevalence and risk groups of bullying in the workplace", *Bullying and Harassment in the Workplace: Developments in Theory, Research, and Practice*, (pp. 75-105).

## LOVE AND RESPECT IN THE SOCCER INDUSTRY

Loureiro, Sandra Maria Correia<sup>1</sup>; Kaufmann, Hans Ruediger<sup>2</sup>

<sup>1</sup>Marketing, Operations and General Management Department Instituto Universitário de Lisboa (ISCTE-IUL) Business Research Unit (BRU/UNIDE) and SOCIUS, Lisbon, Portugal

<sup>2</sup>University of Applied Management Sciences, Mannheim, Germany

### ABSTRACT

#### PURPOSE

The aim of this study is to follow Roberts' concept of Lovemarks and develop a scale to measure Lovemarks brands, using soccer context industry. For scale development, we followed the Churchill's (1979) paradigm.

#### CONCEPTUALIZATION

Investing in consumer-brand relationships has become central to many brands seeking to build lasting and profitable links with their consumers (Pang, Keh, and Peng, 2009; Loureiro, 2015). The term Lovemark is associated, initially, with terms defined by Ahuvia (2005) as positive emotions such as brand response, brand connection, brand declarations of love. Carroll and Ahuvia (2006) also define brand love as an emotional bond between a consumer' satisfied by a particular brand, assigning the concept with the name of Love to the Brand. Albert, Merunka, and Florence (2008), on the other hand, argue that brand passion is supported by three dimensions: cognitive - brand idealization and its presence in the consumer mind; Emotional - desire, attraction and link between the consumer and the brand; Behavioural - where the positive word-of-mouth is inserted, the purchase of the brand at higher prices and the persuasion of other consumers to buy it.

Lovemarks transcend brands. They reach something beyond their good performance. They aim to reach the heart as well as the mind, creating an intimate and emotional connection with the consumer. According to Roberts (2005), if a brand is discontinued from the market, consumers find a substitute. If a Lovemark disappears, consumers will miss them. Roberts' (2005) theory point out two core faces of Lovemarks: love and respect. Love has been regarded as an emotion but also as a relationship (Batra *et al.*, 2012). The respect associated with a particular brand ensure the type of emotional relationship that consumers develop with a certain brand in relation to a competitor (Bergkvist and Bech-Larsen, 2010).

We employ the Batra et al. (2012) prototype model of love to measure brand love, which presents seven dimensions of love: passion-driven behaviours (passionate desire to use, willingness to invest

resources, things done in the past); Self-brand integration (desired self-identity, current self-identity, meaning of life, frequent thoughts); Positive emotional connection (intuitive fit, emotional attachment, positive emotions); Long-term relationship; Anticipate separation distress; Positive attitude valence (liking); and Attitudes held with high certainty and confidence. The authors use a grounded theory approach to capture the uncovered consumer-experienced features of the brand love prototype leading to a much more comprehensive and integrated understanding of how consumers experience brand love than past research.

Brand respect comprises five components: Brand performance, Brand heritage, Corporate reputation, Brand trust and Brand co-creation. Brand performance, therefore, represents a tool to analyse the consumer's experience, insofar as it evaluates the positive and / or negative physical and emotional benefits consumers have found in relation to the brand (Banerjee, 2008). Keller (2001) states that the consumer analyses and compares the value proposition of the brand with other competitors in the market and evaluates whether or not it holds a higher value. Brand heritage concept represents an overview of the past influencing long-term relationship, moments of the present and perspectives of the future (Urde et al., 2007).

Corporate reputation is built and fortified by representing a set of positive and / or negative ideas and impressions with stakeholders and allowing them to conclude about the company's identity (Walsh and Beatty, 2007). Brand trust reflects the assumptions of trustworthy, honesty and altruism that consumers ascribe to brands (Loureiro et al., 2012).

Co-creation represents a common experience between the company and the consumer, in which there are a definition and solution of the problem together based on the exchange of ideas and innovative experiences. The passive consumer is replaced by the creation of active value, giving space for the consumer to interact with this type of processes, supported by constructive criticism and efficient solutions for the creation and / or optimization of products (Prahalad and Ramaswamy (2004).

Regarding nomological validity and predictive validity, we employed Mystery, Intimacy, and Sensuality as antecedents and behavioural intentions as outcomes. Mystery brings together stories, metaphors, dreams and symbols and increases the complexity of relationships and experiences since people are drawn to the unknown and have the desire for discovery. Sensuality comes from the senses. These senses work together to alert and stimulate consumers to new sensations, creating new memories and memories. Intimacy, in turn, can generate empathy, commitment, and passion. This component creates loyalty relationships between the consumer and the brand that can be remembered over the long term regardless of whether the functions and benefits have disappeared or not. Lastly, we expected that behavioral intentions –purchase intentions, willing to pay and word of mouth- is an outcome of being in love and respect a brand (Loureiro, 2015; Xie et al., 2015).

The scale was developed in the context of soccer industry. Collective sports at a global level, and soccer- in particular- are made up of activities and events mostly based in the service sector, lived in small periods of time, that instil subjective attitudes and behaviours in their consumers and which have unforeseen results given the existing competitiveness (Underwood et al., 2001). Soccer, as a collective sport, represents the most popular sport in the world (Cayolla and Loureiro, 2014). A team sport generates a social experience in which the whole is greater than the sum of all its parts. Soccer can be worth around 250 billion dollars worldwide. This value generates competitiveness not only within each modality but also between different sports (Cayolla and Loureiro, 2014). Soccer represents a way of life. Several feelings can be generated for one person, and the same feeling can be conveyed by many people (Keller, 2003).

The connection among fans is related to their loyalty and commitment. A kind of religious cult is identified for the club, which can overcome insufficient performance phases, scandals and negative publicity in the media, high ticket prices, among others. The representation of the colours of the club, the identification of places as sacred (stadium, museum), the organization and dynamism of cheerleaders, the purchase of allusive products (scarves, equipment, balls) reveal a strong and stable connection between the club and the Its adherents (Pimentel and Reynolds, 2004). The good results and success of a team can be rapid, but the loyalty and commitment present in the brand-consumer relationship can be slow to develop (Gladden et al., 2001).

## DESIGN/METHODOLOGY/APPROACH

The process starts with an extensive literature review to identify the facets of Lovemarks regarding love and respect. We employed the short scale of eleven items provided by Batra et al. (2012) to measure brand love. Respect was conceptualized through five components based on Robert's (2005): co-creation, trust, heritage, performance, and corporate reputation. Each of these components was defined previously in the theoretical background.

We employed five items to measure co-creation based on Prahalad *et al.* (2004), four items for trust adapted from Chaudhuri *et al.* (2001), twelve items for measure heritage (Merchant and Rose, 2013), performance with three items (Luxton *et al.*, 2015) and corporate reputation with 16 items (Walsh and Beatty, 2007). In order to measure drivers and outcomes, we used four items to measure mystery, three items to measure intimacy, three items to measure intimacy adapted from Roberts (2005) and Fournier (1998). Finally, we employed four items to measure behavioural intentions based on Xie *et al.* (2015).

Three-month surveys (from February 15, 2016, until May 15, 2016) were carried out through the online platform Qualtrics. It is a free and duly authorized program when registering through the academic

email address of ISCTE-IUL (mmgrs@iscte.pt). The use of Qualtrics has proven to be a relevant option in that it provides an accessible use for both researchers and respondents. The survey consists of three parts, structured in order to make it easier for the respondent to read: first, the brand community to which he belongs is questioned, as well as the degree of affinity he/she feels to the same; Second, seven randomly organized blocks of items (69 in total) representing the constructs under study are carried out; Finally, certain personal data are requested so that a sociodemographic analysis can be carried out on the sample. The analysis of the items had as a method of classification the degree of agreement and disagreement on the same, using the Likert scale with 5 points (1 - totally disagree; 2 - disagree; 3 - neutral; 4 - agree; 5 - agree fully). Statistical analysis, in a research dissertation of this nature, represents a fundamental vehicle for the development of the exploratory study, making possible the analysis of the data as well as the collection of the necessary conclusions.

The data collected through the preparation of surveys were analysed in their entirety by the IBM SPSS Statistics 22 tool. It is a software that contributes to productivity improvement and decision making using analytical techniques. Through the Qualtrics program used to create the survey, it was possible to transfer the collected data automatically to SPSS having facilitated not only in the speed of the process but also in reducing the risk of error. A sample of 348 completed surveys was used from 500 collected, representing 69.6% of the total.

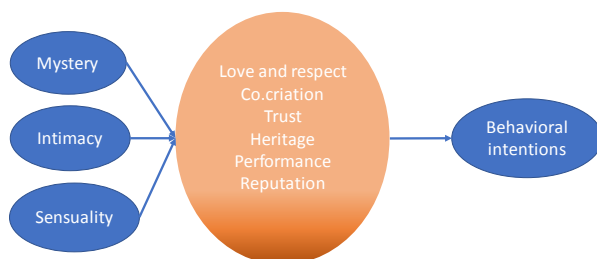

Figure 1. Nomological framework

## MAIN FINDINGS

Several aspects come from the study. First, sensuality stands out as the variable that best explains brand Love ( $\beta=0.836$ ,  $p< 0.001$ ), co-creation ( $\beta=0.486$ ,  $p< 0.001$ ), trust ( $\beta=0.728$ ,  $p< 0.001$ ), heritage ( $\beta=0.554$ ,  $p< 0.001$ ), performance ( $\beta=0.500$ ,  $p< 0.001$ ) and reputation ( $\beta=0.490$ ,  $p< 0.001$ ). Second, the three variables (mystery, sensuality, and intimacy) contribute to explain in 90.7% the variability of brand love, 62.5% the variability of co-creation, 76.5% the variability of trust, 70.7% the variability of heritage, 65.5% the variability of performance and 64.0% the variability of reputation. Third, Intimacy does not explain the variability of trust and performance significantly

Fourth, considering love and respect, brand love is the one to have the higher explanatory power on behavioral intentions ( $\beta=0.802$ ,  $p< 0.001$ ). However, 83,6% of the behavioural intentions are explained



by brand love and the five dimensions of respect. Heritage is the one with less explanatory power over behavioral intentions ( $\beta=0.144$ ,  $p<0.05$ ).

## PRACTICAL IMPLICATIONS

Today's brands should increasingly focus on consumer needs, their expectations and desires as a way to develop long-lasting emotional and sentimental ties and bonds. The brand that does it the best reaches a special place in the head and the mind of the consumer, being titled Lovemark.

The fact that a brand achieves this status allows it not only to create loyalty for the consumer but also to generate a deep relationship. This situation implies, above all, that the brand maintains its quality standards and that does not disappoint the consumer, always meeting their needs.

Achieving a Lovemark implies a constant building of emotional bonds beyond brand-consumer reason, as well as the creation of differentiating factors, sustained by symbolic, emotional, and intangible characteristics based on well-defined strategies. Sensuality and mystery are key factors in building love and respect. Yet, more than respect, it is the relational love (the deep passion connection) that leads consumers to keep in close contact with brands, for good and bad moments. These findings are quite important for brand management.

The present research was based on the behaviour of soccer club fans in Portugal, and it was interesting to analyse the pragmatism, desire, and passion demonstrated by the club fans. It would be interesting for marketing management to develop an analysis in another industry.

## ORIGINALITY/VALUE

As far as we know, this is the first attempt to provide a full scale to measure love and respect following Churchill's paradigm into the context of soccer industry. Even so, the scale must be tested and extended to other iconic brands in other industries.

*Keywords: Brand love, Brand performance, Brand heritage, Corporate reputation, Brand trust and Brand co-creation*

## REFERENCES

- Albert, N., Merunka D., and Valette-Florence, P. (2008), "When consumer love their brand: exploring the concept and its dimensions", *Journal of Business Research*, Vol. 61 No. 10, pp. 1062–1075.
- Banerjee, S. (2008), "Strategic brand-culture fit: A conceptual framework for brand management", *Journal of Brand Management*, Vol.15 No.5, pp. 312-321.
- Batra, R., Ahuvia, A. and Bagozzi, R. P. (2012), "Brand Love", *Journal of Marketing*, Vol.76 No.2, pp.1-16.
- Bergkvist, L. and Bech-Larsen, T. (2010). "Two studies of consequences and actionable antecedents of brand love", *The Journal of Brand Management*, Vol.17 No.7, pp. 504-518.

- Carroll, B. and Ahuvia, A. (2006), "Some antecedents and outcomes of brand love", *Marketing Letters*, Vol.17 No.2, pp. 79-89.
- Cayolla, R. and Loureiro, S. M. C. (2014), "Fans club brand relationship: football passion", *International Journal of Business and Globalisation*, Vol.12 No.1, pp. 82-97.
- Chaudhuri, A. and Holbrook, M. B. (2001), "The chain of effects from brand trust and brand affect to brand performance: the role of brand loyalty", *Journal of marketing*, Vol.65 No.2, pp. 81-93.
- Churchill, G.A. Jr (1979), "A paradigm for developing better measures of marketing constructs", *Journal of Marketing Research*, Vol.16No.1, pp. 64-73.
- Fournier, S. (1998), "Consumers and their brands: Developing relationship theory in consumer research", *Journal of consumer research*, Vol.24 No.4, pp. 343-353.
- Gladden, J. M., and Funk, D. C. (2001), "Understanding brand loyalty in professional sport: Examining the link between brand associations and brand loyalty", *International Journal of Sports Marketing and Sponsorship*, Vol.3 No.1, pp. 54-81.
- Keller, K. L. (2001), "Building customer-based brand equity", *Marketing Management*, Vol.10 No.2, pp. 14-19.
- Keller, K.L. (2003), "Brand synthesis: the multidimensionality of brand knowledge", *Journal of Consumer Research*, Vol.29 No.4, pp. 595-600.
- Loureiro, S.M.C. (2012), "Consumer-brand relationship: foundation and state-of-art", in Hans Ruediger Kaufmann and Mohammad Fateh Ali Khan Panni (editors), *Customer- Centric Marketing Strategies: Tools for Building Organizational Performance*, chapter 20 (pp. 413-434). IGI Global: Hershey, Pennsylvania, USA, pp. 413-434.
- Loureiro, S.M.C. (2015), "Loving and Hating Brands: Multiple Relationships between Consumers and Brands", in Hans-Ruediger Kaufmann (ed.). *Handbook of Research on Managing and Influencing Consumer Behavior*, chapter 18 (Section 3: Achieving Consumer "Involvement": A Multidisciplinary Effort). IGI Global: Hershey, Pennsylvania, USA, pp. 417-438.
- Loureiro, S.M.C., Kaufmann, H. R., and Vrontis, D. (2012), "Brand Emotional Connection and Loyalty", *Journal of Brand Management*, Vol.20 No.1, pp. 13-27.
- Pang, J., Keh, H. T. and Peng, S. (2009), "Effects of advertising strategy on consumer-brand relationships: A brand love perspective", *Frontiers of Business Research in China*, Vol.3 N<sup>o</sup>.4), pp. 599-620.
- Merchant, A., and Rose, G. M. (2013), "Effects of advertising-evoked vicarious nostalgia on brand heritage", *Journal of Business Research*, Vol.66 No.12, pp. 2619-2625.
- Pimentel, R. W., and Reynolds, K. E. (2004), "A model for consumer devotion: Affective commitment with proactive sustaining behaviors", *Academy of Marketing Science Review*, Vol.5No.5, pp. 1-45.
- Prahalad, C. K., and Ramaswamy, V. (2004), "Co-creation experiences: The next practice in value creation", *Journal of interactive marketing*, Vol.18 No.3, pp. 5-14.
- Roberts, K. 2005. *Lovemarks – the future beyond the brands*, New York: PowerHouse Books.
- Underwood R, Bond E and Baer R. (2001), "Building service brands via social identity: lessons from the sports marketplaces", *Journal of Marketing Theory and Practice*, Vol.9 No.1, pp. 1-13.
- Urde, M., Greyser, S. A. and Balmer, J. M. (2007), *Corporate brands with a heritage*. *Journal of Brand Management*, Vol.15 No.1, pp. 4-19.
- Walsh, G., and Beatty, S. E. (2007), "Customer-based corporate reputation of a service firm: scale development and validation.", *Journal of the Academy of Marketing Science*, Vol. 35 No.1, pp. 127-143.
- Xie, Y., Batra, R. and Peng, S. (2015), "An Extended Model of Preference Formation between Global and Local Brands: The Roles of Identity Expressiveness, Trust, and Affect", *Journal of International Marketing*, Vol.23 No.1, pp. 50-71.

## LOCAL COMMUNITY AND TOURISTS - PERCEPTIONS ABOUT THE IMPACTS OF TOURISM IN THE HISTORIC ZONE OF PORTO

Magalhães, Carla<sup>1</sup>; Marques, Isabel; Candeias, Maria Teresa

Faculty of Economics, Social Sciences and Business, Lusófona University of Porto, ULP, Porto, Portugal

### ABSTRACT

This investigation aims to study the perception that residents and professionals of the Historic Zone of Porto (HZP) have about Tourism in this area, taking into account the socioeconomic, cultural and environmental dimensions and following the analysis model of Andriotis (2003). For this purpose, a review of the literature on the subject was carried out and a questionnaire was applied to a sample of 287 workers and residents in the selected parishes of the HZP. The literature review allowed us to find three dimensions to be evaluated, adapted from the models of Andriotis (2003) and Dyera *et al* (2007): the interaction between tourists and residents and the socio-cultural development of the city, economic development and local employment and the environmental dimension. Through the analysis of the collected data, it was possible to draw some conclusions about the way residents and local professionals of HZP perceive tourism. First, by analyzing the socio-economic dimension in detail, it was possible to verify that the respondent sample had a positive reaction, emphasizing that the majority of respondents considered tourism as a promoter of development in all areas, including those that are not exclusively linked to this sector. The main advantages include attracting new investors, creating jobs or developing the local economy. On the other hand, some respondents react negatively to the presence of the tourist sector as they consider that the cost of living has risen dramatically, in particular in general expenses and in the price of housing. As far as the socio-cultural dimension is concerned, it is evident that, along with the socio-economic dimension, it is positive for the group under study. It should be emphasized that, in general, a large number of individuals agreed with the statement "Meeting people from other places helps to better understand the culture and society of other countries." The participants demonstrate pride in the traditional culture of Porto, when they see tourists in the city, and consider that the increase of tourism is creating a new dynamic of animation in the HZP. On the other hand, the item with less consensus concerns its participation in cultural events in the Center of Porto (standard deviation = 1,175). The analysis of the socioenvironmental dimension reveals less positive feedback compared to the other dimensions. They consider tourism an added value and think that Porto has the capacity to attract more tourists (the average of 4.24 reflects this opinion). It also has advantages in other aspects, such as the general improvement in the city, the revitalization of the historic center, the improvement of accessibility and means of transportation or the restoration of historical buildings in the city center. In general, through

this study, it was possible to verify that the sample surveyed evidences a positive perception regarding the development of tourism in the city, demonstrating that the local stakeholders of the HZP are pleased with the presence of companies and practices related to Tourism in this region. There is also an agreement on a larger scale regarding the socio-cultural dimension, proving that the community feels comfortable and open to the contact with other people and cultures. It was also tested the possibility of finding differences in the perception of the impact of Tourism in the HZP according to gender, age, place of work and place of residence. The results point out that there are no differences in the evaluation of tourism impact in relation to the studied factors. However, in the case of the perception about Animation and Culture this is more positive for who resides in the Center of the Porto but works outside this area of the city. Thus, the present study allows us to conclude that the respondents consider that Tourism in Porto is growing in a harmonious way with the city and had a direct influence on the overall improvement of the HZP. Respondents value positively the Tourism in the city, and the component that had a greater relevance in the positive perception about this activity in the city is the good interaction between tourists and residents that, taking into account the studies of Cohen (1984) and Kim, Uysal and Sirgy (2013, *apud* Vargas-Sánchez *et al*, 2014) may be due to the fact that the city of Porto is still at an early stage of tourism development, in which tourists are considered as an important part of social relations and by whom the local community feels a great proximity and appreciation, thus favoring the hospitality.

*Keywords: Tourism impact, Residents, Workers, Historic Zone of Porto, Perceptions.*

## REFERENCES

- Andriotis, K. and Vaughan, D. (2003), "Urban Residents' Attitudes toward Tourism Development: The Case of Crete", *Journal of Travel Research*, Vol. 42, pp. 172-185.
- Cohen, E. (1984), "The Sociology of Tourism: approaches, issues, and findings", *Annals Review of Sociology*, Vol. 10, pp. 373-392.
- Dyera, P., Gursoyb, D., Sharmaa, B. and Cartera, J. (2007), "Structural modeling of resident perceptions of tourism and associated development on the Sunshine Coast, Australia", *Tourism Management*, Vol. 28, No. 2, pp. 409-422, 2007.
- Vargas-Sánchez, A., Plaza-Mejía, M.A. and Porras-Bueno, N., (2014), "Residents' Attitude to Tourism and Sasonality", *Journal of Travel Research*, Vol. 53, No. 5, pp.581-696.

# STAKEHOLDER'S PERCEIVED REPUTATION OF LOCAL GOVERNMENT OF SOUTH AFRICA

Maleho, Lazarus Mohapi

Department Of Hospitality, Tourism And Public Relations Management, Vaal University Of Technology, South Africa

## ABSTRACT

The purpose of this study was to assess how internal (municipal employees) and external stakeholders (community members) of a South African district municipality perceive the corporate reputation of that municipality. Generally, the issues that have been pointed out to the municipalities by the disgruntled stakeholders have reportedly been in the areas of dissatisfaction with service delivery performance, from media reports of protest action, which impacts negatively on the reputation of the local government. To address this problem this study therefore used the Harris-Fombrun Reputation Quotient (RQ) to investigate stakeholders' perceived reputation of the Fezile Dabi District Municipality, formerly known as Northern Free State District Municipality and includes two towns in each of the four local municipalities, namely, Kroonstad, Steynsrus, Heilbron, Parys, Sasolburg, Orangeville, Villiers and Frankfort. Forty employees were randomly selected in the offices of the different municipalities and 240 participants from eight towns were conveniently selected. Questionnaires containing items based on the Fombrun's six Reputation Quotient dimensions were used. Three fundamental questions were asked and addressed in this study.

- What are the perceptions of *external stakeholders* (i.e. community members) with regard to the reputation of Fezile Dabi District Municipality (FDDM), as measured collectively in terms of the six dimensions of the Harris-Fombrun Reputation Quotient?
- What are the perceptions of *internal stakeholders* (i.e. municipality employees) with regard to the reputation of Fezile Dabi District Municipality (FDDM), as measured collectively in terms of the six dimensions of the Harris-Fombrun Reputation Quotient?
- What differences can be observed between *external stakeholders* (i.e. community members) and *internal stakeholders* (i.e. municipality employees) in terms of their perceptions of the Fezile Dabi District Municipality (FDDM)?

*Keywords: Corporate reputation, Public service, strategic communication, Public relations, Reputation management.*

## SMES FARMING SUSTAINABILITY: THE ROLE OF AGRIFOOD HUBS

Malindretos, George <sup>1</sup>; Moschouris Socratis<sup>2</sup>, Kinanlis Panagiotis<sup>1</sup>

<sup>1</sup>School of Environment, Geography and Applied Economics, Harokopio University, Athens, Greece

<sup>2</sup>Department of Industrial Management and Technology, University of Piraeus, Piraeus-Athens, Greece

### ABSTRACT

The main objective of this research concerns the sustainability performance with specific focus in the Agrifood industry. In particular, the Agrifood Hubs (AH) have contested over the last decades within the academic and public institutions as main enabler of the economic, social and environmental sustainability of SMEs in the dominated surrounding conventional agri-food system in developing countries.

The majority of research in SCM in the past focused on large organizations, while the benefits of SCM that can be realized by small businesses are not clear enough. Arend & Wisner (2005) have argued that SCM can provide quality, cost, customer service, leverage and even risk mitigation benefits. Provided properly integrating SMEs, barriers to internalization and competitiveness may be eliminated and pave the way for collaboration among supply chain partners (Hoppe, et al., 2010; Davidova, and Thomson, 2014). A road-map has been proposed to integrate supply chain strategies with the competitive strategies of SMEs for effective value chain management (Franklin et. Al., 2011). In the increasingly globalizing market, innovation and use of appropriate methods and processes with trustful co-operation can contribute overcome the barriers chain networks of SMEs and to the enhancement of the innovation capacity (Kühne et al., 2010; Porter and Kramer, 2011). To increase the small share due to lack of efficiency, the implementation of supply chain and supply chain management by SMEs will lower costs and increase efficiency.

In particular, although managers of small firms as a rule suggest that the majority of the benefits of SCM are within their reach and that the barriers to implementation do not intimidate them, they are not actively pursuing SCM as a strategic weapon. The best way to avoid this is to create the 'collaborative capabilities' for promoting SCM, for the choice among alternative holistic SCM strategies based on the small firm's participation (Fawcett et al., 2009; Oreszczyn et al., 2010; Diamond and Barham, 2012). The exploitation of synergies throughout the building-up of a value chain is critical for the sustainability goals of SMEs in the agricultural sector. New 'strategic thinking' can initiate collective innovation, leaving aside attitudes and practices dominated in the past. The on-going assessment is expected to be embedded by alignment of the 'triple line approach' of sustainability with the so-called 'three Ds' triangular analysis (Decentralization-Democracy-Development).

In this direction, AH provide knowledge and information for potential markets throughout the world and value adding services, promoting collaborative action/synergies and enabling market thus access particularly for SMEs through integrating agrifood supply chains, bridging small producers and the consumers—individuals and families as well as big buyers (Ploeg, et al. 2012). This is inescapable for escaping from inevitable agricultural abandonment: because, the globalization phenomenon has increased barriers to market access aggravating the farms' declining share of profit and the cost-price squeeze of commodity production (Breustedt and Glauben, 2007; European Commission, 2011; European Parliament, 2013; Berti and Mulligan, 2016; Schneider et al., 2016).

The main focus is given to the methodology and literature intermix concerning AH, in a shared knowledge driven research, to motivate "Responsible Research and Innovation" (RRI), with a dynamic interactive R&D process. This accommodates the SD UN concept and the advance of Logistics to integrated SSCM (Sustainable Supply Chain Management). Moreover, the paper through a critical literature review, presents different approaches/types of AH within the framework of sustainability, value supply chain and digital era. More specifically, it aims at a taxonomy analysis of the AH in terms of institutional, functional and other factors met in the literature of AH, while a holistic model of AH will be proposed, incorporating main principles and functional guidelines meeting sustainability imperatives, exploiting value supply chain technologies, methods and practices. (Bloom, and Hinrichs, 2011, Beckie et. al., 2012).

This study identification is in line with the demographic, economic and social prospects for the 2050 and the European Economic and Social Committee decision acting under Rule 29(2) of the Rules of Procedure, for "An EU Industrial Policy for the Food and Drinks Sector' adopted on 4 May 2015 (2015/C 332/04).

*Keywords: Agrifood Hubs, Responsible Research and Innovation, Sustainable Supply Chain Management.*

## REFERENCES

- Arend, R.J. and Wisner, J.D. (2005), "Small business and supply chain management: is there a fit?", *Journal of Business Venturing*, 20 (3): 403-436.
- Beckie, M.A., Huddart, E. and Wittman, H. (2012), "Scaling up alternative food networks: Farmers' markets and the role of clustering in western Canada", *Agriculture and Human Values*, 2012, 29, 333-345.
- Berti, G. and Mulligan, C. (2016), "Competitiveness of Small Farms and Innovative Food Supply Chains: The Role of Food Hubs in Creating Sustainable Regional and Local Food Systems", *Sustainability* 2016, 8(7), 616;
- Bloom, J.D. and Hinrichs, C.C. (2011), Informal and formal mechanisms of coordination in hybrid food value chains, *Journal of Agricultural Food System Community*, Dec. 2011, 1, 143-156.
- Breustedt, G. and Glauben, T. (2007), Driving Forces behind Exiting from Farming in Western Europe, *Journal of Agricultural Economy*, 2007, 58, 115-127.
- Davidova, S. and Thomson, K. (2014), "Family Farming in Europe: Challenges and Prospects. In-Depth Analysis.", Directorate General for Internal Policies, Policy Department B: Structural and Cohesion Policies, Agriculture and Rural Development: Brussels, Belgium, 2014.

- Diamond, A. and Barham, J. (2012), "Moving Food along the Value Chain: Innovations in Regional Food Distribution", U.S. Department of Agriculture, Agricultural Marketing Service: Washington, DC, USA, 2012.
- European Commission (2011). What Is a Small Farm; EU Agricultural Economic Brief, No. 2; Belgium, 2011
- European Parliament (2013). On the Future of Small Agricultural Holdings European Parliament: Strasburg, France,
- Franklin, A.; Newton, J.; McEntee, J.C. (2011), "Moving beyond the alternative: Sustainable communities, rural resilience and the mainstreaming of local food", *Local Environment*, 2011, 16, 771–788.
- Hoppe, R.A.; MacDonald, J.M.; Korb, P. (2010), "Small Farms in the United States Persistence Under Pressure; Economic Information Bulletin Number 63", USDA Economic Research Service: Washington, DC, USA.
- Kühne, B. and Gellynck, X. (2010), "Chain Networks as a Leverage for Innovation Capacity: The Case of Food SMEs", *International Journal on Food System Dynamics*, 4: 279-294.
- Oreszczyn, S., Lane, A. and Carr, S. (2010), "The role of networks of practice and webs of influencers on farmers' engagement with and learning about agricultural innovations", *Journal of Rural Studies*, 2010, 26, 404–417.
- Ploeg, J.D, Jingzhong, Y., Schneider, S. (2012), "Rural development through the construction of new, nested, markets: Comparative perspectives from China, Brazil and the European Union", *Journal of Peasant Studies*, 2012, 39, 133–173.
- Porter, M.; Kramer, M. (2011), "Creating Shared Value: How to reinvent capitalism and unleash a wave of innovation and growth", *Harvard Business Review*, 2011, 89, 62–77.
- Schneider, S., Salvate, N. and Cassol, A. (2016), "Nested Markets, Food Networks, and New Pathways for Rural Development in Brazil", *Agriculture*, 2016, 6(4).



## **THE RIGHT TO CONTAINING CLIMATE CHANGE (CCC)**

**Maniatis, Antonios**

University of Applied Sciences, Athens, Greece

### **ABSTRACT**

#### **INTRODUCTION: THE GROUP OF RIGHTS TO ENVIRONMENT, WATER AND CCC**

4G fundamental rights have begun to be recognized from about 1995 and on. Some dynamic modern groups are formed, comprising new and older components, like the ecological group “Environment, Water, Containing Climate Change (CCC)” (Maniatis, 2017). For instance, the 3G universal right to water has acquired an autonomous constitutional status through decision 1906/2014 of the Plenum of the Council of State in the Greek legal order.

We suppose that the right to CCC, is an autonomous 4G fundamental right.

#### **A JURISPRUDENTIAL REVOLUTION ON THE 4G RIGHT TO CCC**

The right to CCC was in the process of becoming a judicially protected right in an autonomous way against the general 3G right to the environment, shortly before the adoption of the Paris Agreement on Climate Change. According to the doctrine, the Climate Change Law was then gaining its own autonomy in the jagged context of Environmental Law (Nespor, 2015). According to the Oslo Principles on Global Climate Change Obligations, presented on 30 March 2015, as scientific evidence is constantly evolving and improving, lawmakers, policymakers and tribunals have a duty to inform themselves of and base their actions – in good faith and respecting justice and equity – on prevailing scientific knowledge and opinion. Threatened human rights include, but are not limited to, the right to life, the rights to health, water, food, a clean environment, and other social, economic and cultural rights, and the rights of children, women, minorities and indigenous peoples. Shortly afterwards, in June 2015, two judgments of national tribunals changed the history of climate law. Initially, the district Dutch tribunal of Aia imposed to the correspondent government to adopt stricter policies in the matter of climate change in order to protect the right of citizens to live in an environment unthreatened by climate alterations in the near future (Nespor, 2015). Holland till 2020 would achieve to limit down its greenhouse gas emissions to the maximum of 17% but this measure was insufficient in view of the importance of climate change, so the minimal reduction to achieve should be of 25%. The government cannot justify its inactiveness by making use of the argument that the solution in the climate change problem depends only to a very small extent on Holland. For the first time,

worldwide, a judicial authority considered that CCC is not reserved to the discretionary faculty of the political (legislative or executive) components of a State but is a resource of rights of citizens, which countries should respect. The last ten years before this sentence, the ecological movement realized that it was unable to persuade the international community to adopt a legally binding agreement to CCC and modified its strategy, by emphasizing on the judicial way in the interior of single sovereign States, to obtain what they did not manage to obtain by the international community. Besides, some days after the publication of the Dutch sentence, a judge of the USA emitted a sentence on the recourse of young students and ordered the Eco-logy Department of the State of Washington to reconsider their application, presented in 2014 and rejected by the Department. It was about a proposal for the adoption of measures to reduce the greenhouse gas emissions in the interior of the State, on the basis of the most reliable scientific data. The verdict, in line with the jurisprudence of Holland, signalizes that the youngsters are endowed with a right to live in the future in a healthy environment and that the Ecology Department had in no way disputed the data which had been offered by the students and shared by the international academic community, in the matter of damage resulting from climate change. In a comparable way, a law adopted by the Finnish Parliament on 6 March 2015 previews a reduction in gas effect emissions of 80% against 1990.

The United Nations Framework Convention on Climate Change entered into force on 21 March 1994 and has actually near-universal membership. Due to the date of entrance into force, the UNFCCC ties in with the 4G character of the correspondent right to CCC. Furthermore, the above-mentioned Paris Agreement, which was adopted on 12.12.2015 and entered into force on 4.11.2016, provides an opportunity for countries to cope with the threat of climate change by keeping a global temperature rise this century well below 2 degrees Celsius and to pursue efforts to limit the temperature increase to 1,5 degrees Celsius. However, we have to signalize that it makes no explicit mention to the human right to water, despite the aforementioned precedent of the Oslo Principles on Global Climate Change Obligations. The contribution of each State to achieve the worldwide goal of the Agreement is determined by all States separately and is called "Nationally Determined Contribution (NDC)". However, no mechanism has been previewed to force a State to set a target in its NDC by a specific date and no enforcement will be if a set target within a NDC is not met. There will be only a "name and encourage" plan. Unlike its predecessor, the Kyoto Protocol, which sets commitment targets endowed with a legal force, the Paris Agreement allows for voluntary and nationally determined targets.

In spite of this approach, the USA President announced in May 2017 the withdrawal of his country from the Paris Agreement, which inflicts 'severe energy restrictions' on the USA and 'punishes' it while 'imposing no meaningful obligations on the world's leading polluters'. This motivation is

wrong because the USA NDC was unilaterally offered by the previous national administration (not imposed by anyone) whilst India and China, singled out in President's speech, have NDCs that are different from this NDC not because the Paris Agreement imposes a prescriptive burden sharing arrangement on countries, but because these countries have different national circumstances (Rajamani, 2017). Anyway, due to legal reasons the USA will remain to the Paris Agreement until at least November 2020...

## **CONCLUSION: NEW RIGHT AND BRANCH OF LAW ON CLIMATE CHANGE**

In 1817 the invention of the bicycle was achieved, as a result of a climate change crisis. Two centuries later, a 4G right on the matter exists, which comes from international stage as it has been consecrated in the 1992 United Nations Framework Convention on Climate Change, put into force in 1994. In 2015, it was significantly promoted by pioneer jurisprudence whilst climate change law has recently gained its self-existence against the older branch of environmental law, through the Paris Agreement. Last but not least, it is recommended to explicitly recognize in Constitutions the universal right to CCC, like the right to water...

*Keywords:* Containing Climate Change (CCC), Environment, 4G rights, Right to water,

## **REFERENCES**

- Maniatis, A. (2017), "Judiciary and the Technological Rule of Law", in VIII Scientific and Professional Conference with International Participation (Tara), pp. 531-540.
- Nespor, S. (2015), "I principi di Oslo: nuove prospettive per il contenzioso climatico", *Giornale di diritto amministrativo*, 6, pp. 750-755 (in Italian).
- Rajamani, L. (2017), "Reflections on the US withdrawal from the Paris Climate Change Agreement", *EJIL*, <https://www.ejiltalk.org/reflections-on-the-us-withdrawal-from-the-paris-climate-change-agreement/>.

# ENTREPRENEURIAL THINKING AND ACTING IN GERMAN HOTELS – AN ANALYSIS FROM AN INDIVIDUAL AND ORGANIZATIONAL POINT OF VIEW

Männicke, Jörg<sup>1</sup>; Baierl, Ronny<sup>2</sup>; Freyer, Walter<sup>3</sup>;

<sup>1</sup>SRH University of Applied Sciences Berlin, Campus Dresden, Dresden, Germany

<sup>2</sup>Hochschule für Technik und Wirtschaft Dresden (HTW), Dresden, Germany

<sup>3</sup>Faculty of transport and traffic sciences “Friedrich List”, TU Dresden, Dresden, Germany

## ABSTRACT

The present study connects individual and organizational level of successful entrepreneurial acting in hardly predictable markets in order to deepen the understanding of the relation between individual thinking and organizational acting. A theoretically derived research model is empirically validated by using survey data from 316 hotel companies in Germany of all size. Our empirical finding is that the variety of entrepreneurial thinking from an individual point of view is a co-driver for a company's ability for entrepreneurial action together with the well-established organization related driver called Entrepreneurial Orientation. Moreover the different patterns within the entrepreneurial paradigm set do vary in their influence on entrepreneurial acting. This is relevant for entrepreneurship literature because it gives a better understanding of the entrepreneurial function which core element is described here as the relationship between entrepreneurial thinking at an individual and organizational level and the firm's capability to act.

## INTRODUCTION AND RESEARCH DESIGN

The literature on entrepreneurship shows the requirements for successful entrepreneurial acting from both the individual and the organizational point of view, since a new market or business entry, as the essential act of entrepreneurship, refers to actions that may be initiated by an individual, a small firm or the strategic unit of a large firm (Lumpkin and Dess, 1996). Thus, the entrepreneurial role stressed by Schumpeter can and must be performed whether by individuals, small groups or entire organizations (Miller, 1983) throughout a firm's life cycle. With this study we want to shed more light on the question how and to which extend individual and shared cognitions of (top) executive managers enter into firm's capabilities and activities that strengthen the firm's performance. We focus on this relation as an approximation to the entrepreneurial function behind the entrepreneurial act. This question matters since a firm's (new) entry may be considered as common but “its survival is not” (Sarasvathy, 2008, p. 123). Moreover this question is relevant for the literature on entrepreneurship ever since it emerged as the underlying core question of the Upper Echelons Theory

by Hambrick and Mason (1984). This theory is based on the premise of bounded rationality by saying that (top) executive managers act on the basis of their personalized interpretations, which are a function of their experiences, values and personalities.

The assumption that situations are not knowable but rather interpretable (Hambrick, 2007) is closely related to the learning theory of constructivism, which states that all human experience and learning is (partly) based on individual constructive activities, which are influenced by neuronal, cognitive and social processes (Glaserfeld, 1995). Hambrick and Mason (1984) used demographic characteristics of executive managers to approach the executive's cognitive frame. However, there has been a remarkable approach by Sarasvathy (2008) who describes entrepreneurial thinking at an individual level as a combination of effectuation and causation logic which both sum up in an entrepreneurial paradigm set. We consider the concept of entrepreneurial thinking by Sarasvathy as an appropriate and close approach to the executive's cognitive frame according to Hambrick and Mason. The proportion of both logics within the frame may vary significantly due to factors like personal preferences of the manager and the firm's life cycle (Sarasvathy, 2008), the organizational background and the branch of the firm (Brettel et al., 2014) and, thus, can be adopted and described for all kinds of manager in certain companies or branches.

A sub-idea of the Upper Echelons Theory states that leadership of a complex organization (like a company) is a shared activity (Hambrick, 2007). Thus, we must consider too concepts that describe dispositions for entrepreneurial thinking on a firm-level. We found this in the theory of Entrepreneurial Orientation (EO) (Miller, 1983; Lumpkin and Dess, 1996). EO is seen as a firm-level disposition to engage in proactive, risk-taking and innovative behaviors that lead to change in the organization or market place (Covin and Slevin, 1991).

Finally, we know from work psychology that (vocational) thinking regulates (vocational) acting (Arnold et al., 2016). Thus, the entrepreneurial expertise (Sarasvathy, 2008) on an individual level and firm-level influence the way a company acts. In this study entrepreneurial acting is represented by the concept of Absorptive Capacity (ACAP) by Cohen and Levinthal (1990). It is seen as a dynamic capability that enhances a firm's ability to gain and sustain a competitive advantage including knowledge creation and utilization (Zahra and George, 2002). We have chosen this concept for several reasons: First of all, it is well described in its ability to strengthen firm performance (Ebers and Maurer, 2014). Second, it is a very precise description of the firm's capability to act in the field of marketing and therefore it can be seen as a valid approximation to entrepreneurial acting on firm-level (Engelen et al., 2014). Third, it is theoretically inappropriate to link the entrepreneurial paradigm set directly to firm performance or firm success (Sarasvathy, 2008).

In order to reframe the entrepreneurial function, we include in our research model the relationship between entrepreneurial thinking on individual level and firm-level (entrepreneurial paradigm set and EO) and entrepreneurial acting (ACAP) and link it to firm performance, predicting that a wider variety of entrepreneurial thinking strengthens entrepreneurial acting which leads to a better firm performance. In order to address the combination of both the effectuation and causation logic to the entrepreneurial paradigm set, the construct of Brettel et al. (2012) was chosen. It consists of four components and each of them is a bipolar combination of both logics (means vs. goals, risk reduction vs. risk avoidance, uncertainty tolerance vs. certainty orientation, failure avoidance vs. success orientation).

Besides we include the recognized market ambiguities by (top) executive managers into the research model, because these ambiguities are considered as a strong driver for the use of effectuation logic among managers (Sarasvathy, 2008) and for the supportive effect of EO on firm performance (Engelen et al., 2014). They are likely to appear more often in rather dynamic and changing markets. The hotel market in Germany belongs to those: Its dynamic development results from growing number of market segments, concentration tendencies due to hotel chains and substitution tendencies due to private suppliers (IHA, 2016).

Finally, the following research model was theoretically derived:

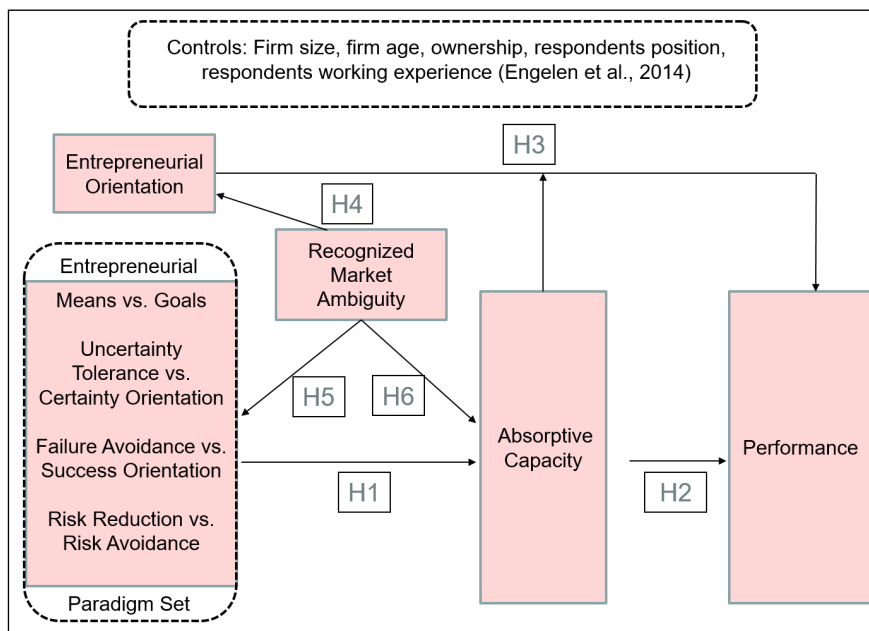

Figure 1. Research model

We assume first that the higher the variety of the entrepreneurial paradigm set gets the higher is the ACAP of the hotel (Hypothesis 1). Further we assume that the higher ACAP gets the higher is the firm performance (Hypothesis 2). We include the well-tested construct of EO by Miller (1983) in the

research model and assume that the higher EO gets the higher is the firm performance (Hypothesis 3a). Furthermore we argue that the higher EO gets the higher is the ACAP of the hotel (Hypothesis 3b). Finally, we assume that the stronger the realized market ambiguity gets the higher is the EO (Hypothesis 4), the higher is the variety of the entrepreneurial paradigm set (Hypothesis 5) and the higher ACAP gets (Hypothesis 6).

In applying this research model, we are able to address two questions to the literature, which are still underexplored: 1. How and to what extend does entrepreneurial thinking on individual level and firm-level influence the firm's capability for entrepreneurial action? 2. How and to what extend is this relationship influenced by realized market ambiguities at an individual level? This is important especially for branches which are considered to have a rather low level of entrepreneurial expertise but a rather high level of emerging market turbulences. Again this applies to the hotel market in Germany since the majority of its provider (small and medium sized hotels) are considered as rather conservative and little innovative.

## **METHOD AND RESULTS**

An online-questionnaire for hotel managers was designed. It contains seven chapters with a total of 32 questions which include all constructs from the research model. A pretest took place in September 2015 among 16 executive managers in top, middle and lower management positions in German hotels. As a result, we found out that participants took on average 15 minutes time for answering although the calculated duration was 20 minutes. In order to get a preferably valid overview about the chosen market we had to find a compromise between the intended depth of the survey and the estimated working time of potential participants. This was solved by programming a random sample of 4 items on average for each part of the complex construct architecture of ACAP, Entrepreneurial thinking and of EO. To reach enough participants all over the German hotel market the invitation link was spread via E-mail by trade-specific multiplier (such as HRS and DEHOGA), among general and other top managers. Between October 2015 and March 2016 a total of 316 filled questionnaires were collected. First, the sample composition was analyzed. An evidence for non-response-bias could not be found (Whitehead et al., 1993). Second, a descriptive statistic was prepared, a confirmatory factor analysis for every construct was made and construct intercorrelations were examined with satisfying results in each step. Then, different path models were shaped in order to test the validity of the research model. Two groups of path models were designed: one group to describe the relationship between entrepreneurial thinking and the capability for entrepreneurial action (as an approximation for the entrepreneurial function) and one group to describe the influence of realized market ambiguities on this relationship.

As a result the overall path model (Figure 2 and Table 1) shows that both the variety of entrepreneurial thinking and EO have a significant supportive effect on ACAP. Besides a significant positive effect of ACAP on firm performance occurs. The variety of entrepreneurial thinking was measured as the standard deviation of all means of the paradigm set. Since the model fit test shows an acceptable model quality both overall (RMSEA) and for its composition (SRMR) Hypothesis 1, Hypothesis 2 and Hypothesis 3b are supported while Hypothesis 3a is not supported clearly by our data (Hair et al., 2014).

Furthermore we found that the different components of the entrepreneurial paradigm set have a different influence on “ACAP” (Table 2): The pattern “Means vs. Goals” and “Failure Avoidance vs. Success Orientation” significantly support ACAP when the causation part gets higher and the effectuation part gets lower. The pattern “Uncertainty Tolerance vs. Certainty Orientation” significantly reduces ACAP under the same conditions. The pattern “Risk Reduction vs. Risk Avoidance” shows no significant effect on “ACAP”. Since the model fit test shows an acceptable model quality both overall (RMSEA) and for its composition (SRMR) these findings refine Hypothesis 1.

Finally, with the ongoing shaping of the second group of path models we found that the realized market ambiguities have a slight supportive effect on EO and, much weaker, on the variety of entrepreneurial thinking. Furthermore our results show no significant effect of the realized market ambiguities on ACAP or firm’s performance.

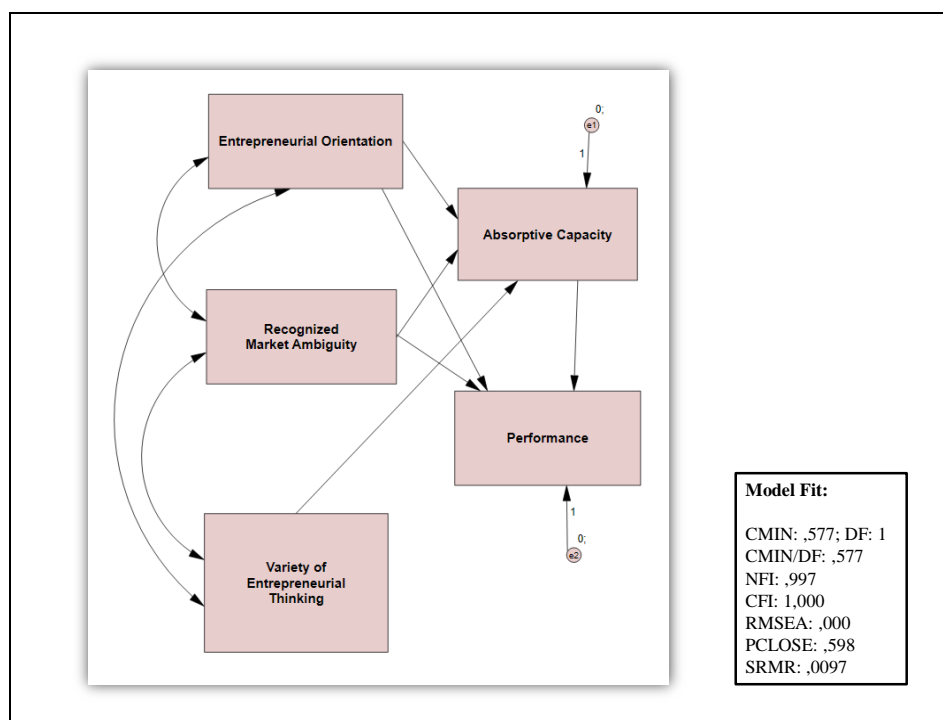

Figure 2. Path Model 1 about the entrepreneurial function without report of integrated controls



Path Model 1			Regression Weights			R-Square
			Standardized	C.R.	P	
ACAP	<---	EO	0,467	9,603	***	
ACAP	<---	Variety of Entrepreneurial Thinking	0,227	4,873	***	
ACAP	<---	Recognized Market Ambiguity	0,111	2,298	0,022	
Performance	<---	ACAP	0,285	4,545	***	
Performance	<---	EO	0,167	2,646	0,008	
Performance	<---	Recognized Market Ambiguity	-0,124	-2,248	0,025	
ACAP						0,379
Performance						0,189

Table 1. Summary of estimates for Path Model 1 without report of integrated controls

Path Model 1 (Detail)			Regression Weights			
			Estimate	Standardized	C.R.	P
ACAP	<---	Means vs Goals	0,176	0,182	3,786	***
ACAP	<---	Risk Reduction vs. Risk Avoidance	-0,002	-0,002	-0,039	0,913
ACAP	<---	Failure Avoidance vs. Success Orientation	0,188	0,200	4,126	***
ACAP	<---	Uncertainty Tolerance vs. Certainty Orientation	-0,127	-0,127	-2,782	0,009

Table 2. Subsidiary estimates for relationship between ACAP and entrepreneurial thinking in Path Model 1

## DISCUSSION AND LIMITATIONS

The results show for established hotel companies that the combination of effectuation and causation logic together with EO is able to enhance the firm's capability for entrepreneurial action. This is a promising first step to build a better understanding of the entrepreneurial function because we gained a more detailed understanding about certain components of the entrepreneurial paradigm set that strengthen or weaken the ACAP according to their causal or effectual shift. The role of ACAP as a mediator of the EO-performance-relationship is stressed here. Most importantly, the overall variety of causal and effectual shifts within the entrepreneurial paradigm set does strengthen the hotels ACAP.

With these results a more sophisticated analysis, description and evaluation of the firm's entrepreneurial function is provided. We conclude that in branches where casual shifts in entrepreneurial thinking dominate (especially the "orientation on goals and success") like in the German hotel market, effectual shifts are not absent or irrelevant. In fact when these shifts enrich the entrepreneurial paradigm set (especially "toleration of uncertainty") it leads to strengthening of the firm's ACAP which is one of the most important enabling factors for entrepreneurial action. That is why we state that companies in those branches should become more familiar with effectuation logic in order to be able to enlarge the variety of entrepreneurial thinking among their (top) managers and employees on an individual level in the first place.

Nevertheless our study faces different limitations due to the chosen methodological approach: All data from the questionnaire are self-referred and were not elevated objectively. Due to the temporary willingness for participation during the pretest we decided not to measure all constructs in full length

but to use random selection for items instead. Besides this is a single survey in the field that represent a snap-shot only. That is why we consider this approach as a first look on the surface of the entrepreneurial function that has to be deepen in further studies. First of all we recommend to measure all constructs in full length by using a smaller random sample in selected target markets. Then, we recommend to measure periodically after several years within these target markets in order to analyze and understand the effect of recognized market dynamics in changing market environments better.

*Keywords: Effectuation Logic, Absorptive Capacity, Entrepreneurial Orientation, Market Ambiguity, Upper Echelons Theory*

## REFERENCES

- Arnold, J. and Randall, R. et al. (2016), *Work Psychology: Understanding Human Behaviour in the Workplace*, Pearson, Harlow.
- Brettel, M., Bendig, D., Keller, M., Friedrichsen, N. and Rosenberg, M. (2014), "Effectuation in manufacturing: how entrepreneurial decision-making techniques can be used to deal with uncertainty in manufacturing", *Procedia CIRP*, Vol. 17, pp. 611-616.
- Brettel, M., Mauer, R., Engelen, A. and Küpper, D. (2012), "Corporate effectuation: Entrepreneurial action and its impact on R&D project performance", *Journal of Business Venturing*, Vol. 27, pp. 167-184.
- Cohen, W. and Levinthal, D. (1990), "Absorptive capacity: a new perspective on learning and innovation", *Administrative Science Quarterly*, Vol. 35 No. 1, pp. 128-152.
- Covin, J. G. and Slevin, D. P. (1991), "A Conceptual Model of Entrepreneurship as Firm Behavior", *Entrepreneurship Theory and Practice*, Vol. 16 No. 1, pp. 7-25.
- Ebers, M. and Maurer, I. (2014), "Connections count: How relational embeddedness and relational empowerment foster absorptive capacity", *Research Policy*, pp. 318-332.
- Engelen, A., Kube, H., Schmidt, S. and Flatten, T. C. (2014), "Entrepreneurial orientation in turbulent environments: The moderating role of absorptive capacity", *Research Policy*, Vol. 43, pp. 1353-1369.
- Glaserfeld, E. v. (1995), "A constructivist approach to teaching", in Steffe, L. P. and Gale, J. E. (Ed.), *Constructivism in education*, Routledge, New York, London, pp. 3-15.
- Hair, J.F., Black, W.C., Babin, B.J. and Anderson, R.E. (2014), *Multivariate Data Analysis*, Pearson, Harlow.
- Hambrick, D. C. (2007), "Upper Echelons Theory: An Update", *Academy of Management Review*, Vol. 32 No. 2, pp. 334-343.
- Hambrick, D. C. and Mason, P. A. (1984), "Upper Echelons: The Organization as a Reflection of Its Top Managers", *Academy of Management Review*, Vol. 9 No. 2, pp. 193-206.
- Hotelverband Deutschland (IHA) (2016), "Hotelmarktstudie 2016," Berlin.
- Lumpkin, G. and Dess, D. (1996), "Clarifying the entrepreneurial orientation construct and linking it to Performance", *Academy of Management Review*, Vol. 21 No. 1, pp. 135-172.
- Miller, D. (1983), "The correlates of entrepreneurship in three types of firms," *Management Science*, Vol. 29 No. 7, pp. 770-791.
- Sarasvathy, S. D. (2008), *Effectuation. Elements of Entrepreneurial Expertise*, Edward Elgar, Cheltenham (UK), Northampton (USA).
- Whitehead, J. C., Groothuis, P. A. and Blomquist, G. C. (1993), "Testing for non-response and sample selection bias in contingent value: Analysis of a combination phone/mail survey", *Economic Letters*, Vol. 41, pp. 215-220.
- Zahra, S. and George, G. (2002), "Absorptive capacity: a review, reconceptualization and extension", *Academy of Management Review*, Vol. 27 No. 2, pp. 185-203.

## **FREEDOM AND PROSPERITY: COMPARATIVE ANALYSIS OF POST-COMMUNIST NATIONS**

**Mardanov, Ismatilla**

Department of Management and Marketing, Harrison College of Business, Southeast Missouri State University, Missouri, USA

### **ABSTRACT**

Prosperity is possible only if political and economic freedom is ensured. Despite the overwhelming evidence from advanced nations, many countries disregard the best practices. The main reason is that those countries are governed by a small group of people who abuse power and benefit to a great extent from this abuse. Economic prosperity has its determinants: political and/or economic freedom. The competition among political forces in free societies helps find best solutions to contemporary problems. If one party is ineffective and inefficient, another is both effective and efficient. In terms of economic freedom, despite the liberal regulations, advanced nations are in a much better position than nations with authoritarian regimes. The reluctance of the majority of emerging and developing nations to focus on freedom and prosperity is the cause of massive poverty on almost every continent. Therefore, a study of the causes of prosperity remains one of the important topics. Based on the data on 27 post-communist nations (PCN), I analyzed the impact of political and economic freedom on economic prosperity in the two groups of PCN: politically free and not-free.

### **LITERATURE REVIEW**

Friedrich Hayek (1948) indicated that economic arrangements determine political decisions. So thought Karl Marx and Friedrich Engels (1848). Milton Friedman (1962) indicated that economic means determine political decisions and social life; however, political arrangements determine economic outcomes. Capitalism was the preferable economic system which is capable of utilizing freedom for prosperity, enacting maximum incentives and motivation to work. There is not much recent literature that discusses the freedom and prosperity linkages because it is obvious that free societies achieve much prosperity despite a huge income inequality gap. In developing countries, governments often fail to implement their own laws and regulations which are sometimes right. The literature indicates that political and economic freedom facilitate economic growth (Vega-Gordillo & Alvarez-Arce, 2003, and so many others). Obviously, economic growth leads to prosperity. The growth and status of GDP per capita indicate prosperity. Some other social variables such as education, women involvement, access to means of communication, and other variables help measure prosperity. Economic freedom is the key to prosperity (Faria & Montesinos, 2009).

## **HYPOTHESES**

Hypothesis 1: The free political system will be positively related to economic freedom more strongly than the not-free political system. Hypothesis 2a: The “civil liberties” attribute of political freedom will be positively related to economic prosperity in the free nation more strongly than in a not-free nation. Hypothesis 2a: The “political rights” attribute of political freedom will be positively related to prosperity in a free nation more strongly than in a not-free nation. Hypothesis 3: Economic freedom will be positively related to economic prosperity in a free nation more strongly than in a not-free nation.

## **METHODS**

I use the political freedom indices (the Freedom House), economic freedom indices (the Heritage Foundation) and Human Development data (the UN Development Program). Data for 2000, 2005, 2010, and 2014 were utilized. Correlations of these indices and the impact of political freedom indices on economic freedom indices as well as the impact of political and economic freedom indices on prosperity indicators were calculated. The advantages of the freedom indices are their objectivity in terms of actual state of freedom in respective countries, rather than what is written in laws that are always good and disregarded by local governments to a great extent in not free nations. The human development data include factual information about GDP per capita, GDP growth rates, education, gender issues, life expectancy, employment rates, trade data, and some other country parameters that measure life styles.

## **ANALYSES AND REPORTS**

Analyses indicate that political freedom is correlated positively with many more economic freedom sub-indices in free nations than in not-free nations in 2000-2014. Specifically, property rights and freedom from corruption are correlated positively with political freedom and civil liberties in the free nations. In not-free nations, these correlations were almost entirely absent. Political freedom indices (political rights and civil liberties) and prosperity indicators are not correlated in not free nations, except employment and political rights and civil liberties. Economic freedom indices are correlated with prosperity indices occasionally in not-free nations while in free nations they are correlated often and in systematic ways. Specifically, GDP per capita is correlated positively with freedom from corruption in free nations, but never in not-free nations. Fiscal freedom (pricing freedom) is significantly correlated with the majority of prosperity indices in free nations. In not-free nations, this index correlated with the employment rates only.

The effect of political freedom on economic freedom was significantly greater in free nations than in not-free nations. In these nations, political rights and civil liberties had a significant and positive impact on economic freedom indices, except the labor and fiscal freedom. In not-free nations political freedom mostly did not impact economic freedom with the exception of financial and trade freedom among ten economic freedom sub-indices. Hence, *Hypothesis 1* is supported. In terms of the relationships between political freedom and prosperity, in free nations, political freedom had a significant positive impact on the human development index, employment, access to mobile phones and Internet, as well as GDP per capita. In not-free nations, political rights and civil liberties had a significant positive impact on the employment rates only. Governments in unfree nations were focused on increasing employment rates as a function of political rights and civil liberties. It turns out that political rights and civil liberties are about employment only. Hence, *Hypotheses 2a and 2b are supported*. In free nations, many economic freedom indices had a significant impact on prosperity. Specifically, freedom from corruption did so there while in not-free nations that factor was insignificant because freedom from corruption does not exist. In these nations, financial freedom had a positive impact on prosperity; economic freedom had a significant positive impact on employment; and freedom from corruption affected education in a couple of years. *Hypothesis 3 is also supported*.

*Keywords: economic freedom, political freedom, prosperity, post-communist nations, emerging markets*

## REFERENCES

- Faria, H.J and Montesinos, H.M. (2009), "Does economic freedom cause prosperity?" Public Choice, Vol. 141, pp. 103-127.
- Friedman, M. (1962; 2002), Capitalism and Freedom, University of Chicago Press, Chicago, IL
- Hayek, F. (1944; 1994), The Road to Serfdom, University of Chicago Press, Chicago, IL.
- Marx, K. and Engels, F. (1948), The Communist Manifesto, International Publishers, New York, NY.
- Vega-Gordillo, M. and Alvarez-Arce, J. L. (2003), Economic Growth and Freedom: A causality study. Cato Journal, Vol. 23 No. 2, pp. 199-215.

## **BRAND EQUITY: A PROBABILISTIC APPROACH ON BRAND PREFERENCE**

**Martins, Marta; Brandão, Amélia; Santos, Luís Delfim**

Faculty of Economics, University of Porto, Porto, Portugal

### **ABSTRACT**

#### **1. INTRODUCTION**

The issue of Brand Equity has attracted much attention, both from an academic and a business management point of view (Aaker, 1996; Christodoulides and Chernatony, 2010; Keller and Lehmann, 2006; Yoo and Donthu, 2001). However, despite the unanimous opinion that the Brand Equity is an important intangible asset, the literature on this field is largely fragmented and inconclusive in terms of conceptual foundations, sources, essence and measures (Christodoulides and Chernatony, 2010; Davcik *et al.*, 2015; Oliveira *et al.* 2015). This paper aims to identify explanatory factors from the consumer's point of view, which have a greater influence (positively or negatively) on the probability of choosing a brand. An *Ordered Probit Model* methodology was carried out. This study examines the relationships between the Brand Equity dimensions (following Aaker's theoretical model: Brand Awareness; Perceived Quality; Brand Loyalty; Perceived Value; Brand Personality and Organizational Associations) and the probability of brand choice, which is used here as a proxy for Brand Equity.

#### **2. THEORETICAL BACKGROUND**

The importance of the concept of brand equity and, more particularly, its measurement is undoubtedly one of the most pertinent topics in the field of marketing, for both, scholars and for practitioners (Davcik *et al.*, 2015). Although, the estimation of brand equity and the quantification of the return on marketing activities in financial terms it remains the major challenge for brand managers (de Oliveira *et al.*, 2015). Two brand equity research streams are dominant: the customer-based and firm-based perspectives. Methodologies developed under the operationalization of CBBE can be classified as direct or indirect. Direct approaches attempt to measure the phenomenon directly, by focusing on consumers' preferences (e.g. Park and Srinivasan, 1994) or utilities (e.g. Kamakura and Russell, 1993; Swait *et al.*, 1993), while indirect approaches measure brand equity through its demonstrable manifestations (e.g. Yoo and Donthu, 2001; Pappu *et al.*, 2005; Christodoulides and de Chernatony, 2010).

#### **3. RESEARCH METHOD**

The study focuses on a category of FMCG, through four widely known beer beverages brands, in the Portuguese market: *Sagres*, *Super Bock*, *Heineken* and *Carlsberg*. Representing 92,2% of the total market in Portugal. In order to achieve the proposed goal, this research is supported by a quantitative methodology, a questionnaire survey, which was directed to consumers (current and potential) of beer, residents in Portugal. A Factor Analysis was conducted after data collected, following the estimation of the proposed econometric model. In this study, the dependent variable is "the probability of choosing the brand X at the next purchase occasion" and the classes used in the model range from 1 (representing "Very unlikely") to 5 (being "Very likely/Certain"). As we are considering an ordinal qualitative dependent variable, the model should be an ordinal regression model, as this avoids the assumption of constant distances between the variable classes (Maroco, 2007). For this purpose, we used the *Ordered Probit Model*. In this model, it is possible to model the observed responses considering a latent variable  $y_i^*$  which depends linearly of the independent variables  $x_i$ :

$$y_i^* = x_i' \beta + \varepsilon_i$$

where  $\varepsilon_i$  are independent and identically distributed random variables.

The quality of the model was analyzed, using a specific method: *Prediction Evaluation*.

#### 4. RESULTS

Regarding the adequacy of the sample to perform the Factor Analysis, the results of the widely used measure of KMO suggest that the data is adequately adjusted. Among the KMO results presented, one can see that, apart for the *Super Bock* brand (which has a higher KMO 0.8), all other subjects have an excellent KMO (greater than 0.9). In an overview, we can notice that organizational associations are not statistically significant, which makes sense because these are brands that present a brand management at the product level and separated from the corporate brand. Comparing the two brands of high penetration (*Super Bock* and *Sagres*) we can see that the most recently consumed brand strongly influences the probability of choosing that brand, a situation that does not happen with the brands of low penetration (*Carlsberg* and *Heineken*), in which the most recently consumed brand is not statistically significant. As a point in common, the constructs of loyalty, awareness and quality are statistically significant for all brands.

#### 5. CONCLUSIONS

This study concluded that there are significant differences between the brands in respect of the explanatory factors of the probability of choice. This study aims to contribute to a better academic and management knowledge on the topic of research, particularly by applying a methodology

uncommonly used in this research area, providing a refreshing and original insight into the problematic of Brand Equity. Additionally, from the management point of view, this study reveals some clues to the creation of more efficient marketing strategies.

*Keywords: brand equity, customer-based brand equity, brand choice, brand preference, consumer behaviour, purchase intentions, ordered probit model*

## REFERENCES

- Aaker, D. A. (1996), *Building Strong Brands*, New York ; London: Free Press.
- Christodoulides, G. and de Chernatony, L. (2010), "Consumer-Based Brand Equity Conceptualisation and Measurement: A Literature Review", *International Journal of Market Research*, Vol. 52, Nº 1.
- Davcik, N. S., Silva, R. V. d., and Hair, J. F. (2015), "Towards a Unified Theory of Brand Equity: Conceptualizations, Taxonomy and Avenues for Future Research", *Journal of Product and Brand Management*, Vol. 24, Nº 1, pp. 3-17.0.
- Kamakura, W. A. and Russel, G. J. (1993), "Measuring Brand Value with Scanner Data", *International Journal Research Marketing*, Vol. 10, March, pp. 9-21.
- Keller, K. L., and Lehmann, D. R. (2006), "Brands and Branding: Research Findings and Future Priorities", *Marketing Science*, Vol. 25, Nº 6, pp. 740-759.
- Maroco, J. (2007), *Análise Estatística com Utilização do SPSS*, Silabo.
- Oliveira, M. O. R., Silveira, C. S., and Luce, F. B. (2015), "Brand Equity Estimation Model", *Journal of Business Research*, Vol. 68, Nº 12, pp. 2560-2568.
- Pappu, R., Quester, P. G., and Cooksey, R. W. (2005), "Consumer-Based Brand Equity: Improving the Measurement - Empirical Evidence", *Journal of Product and Brand Management*, Vol. 14, Nº 3, pp. 143-154.
- Park, C. S., and Srinivasan, V. (1994). "A Survey-Based Method for Measuring and Understanding Brand Equity and Its Extendibility", *Journal of Marketing Research*, 31(2), 271-288.
- Swait, J., Erdem, T., Louviere, J., and Dubelaar, C. (1993), "The Equalization Price: A Measure of Consumer-Perceived Brand Equity", *International Journal of Research in Marketing*, Vol. 10, Nº 1, pp. 23-45.
- Yoo, B., and Donthu, N. (2001), "Developing and Validating a Multidimensional Consumer-Based Brand Equity Scale", *Journal of Business Research*, Vol. 52, Nº 1, pp. 1-14.



## INSTITUTIONAL PILLARS IN CSR IN THE RUSSIAN OIL INDUSTRY

**Mathews, Martin; Benyaminova, Alina**

Department of Marketing and Strategy, Westminster Business School, University of Westminster, London

### ABSTRACT

In this paper we attempt to evaluate the institutional factors at work in the adoption and implementation of CSR practices in the Russian oil industry. As such we contribute to the growing literature examining the evolution of CSR as a function of institutional forces (Campbell, 2007, Bice, 2015). An institutional approach to CSR practices provides a new analytical lens which opens up interesting avenues for scholarly inquiry, notably in examining different reasons for CSR implementation beyond the usual business case arguments such as the (unproven) link between CSR and performance, stakeholder and ethical models. Our aim in this article is to explore how social mechanisms such as social norms, mimetism and normative learning influence CSR, defined as social, environmental and economic behaviours, of Russian oil firms (Bice, 2015).

Institutional theory looks to inform how rules, regulations bound behaviours and helps distinguish multi-layered agent intrinsic conviction from external pressures (Bice, 2015). In other words institutional approaches take into account varying degrees of agency, from highly strategic actors to 'passive' objects of isomorphism (Cambell, 2007, Tempel and Walgenbach, 2007). From an institutional perspective, it is argued that 'CSR is located in wider responsibility systems in which business, governmental, legal, and social actors operate according to some measure of mutual responsiveness, interdependency, choice, and capacity' (Matten and Moon 2008, 407), hence the variation of CSR across countries and institutional contexts (Chapple and Moon 2005; Campbell 2007). This study employs Scott's three pillars of institutions; regulative, normative and cognitive to identify pressures on CSR actions (Scott 1995; Kostova and Roth, 2002).

According to a Bourdieusian perspective, human behaviour is influenced by the interplay of economic, social, cultural and symbolic elements. According to Bourdieu, individuals are motivated to engage in any practice that increases their economic, social, cultural and symbolic capital. Social practices are undertaken by individual managers to attain social power and improve their position in the organisational field. When considering the implementation of CSR projects, a Bourdieusian approach postulates that this behaviour is not driven by any economic impact as explained in instrumental approaches, nor by 'intrinsic rationality', as suggested by normative stakeholder theory (Aaken et al., 2013).

According to Bourdieu (2005) actors engage in practices to acquire monetary and non- monetary capital. He distinguishes between three types of capital; economic, cultural and social. Bourdieu

argues that unconsciously shared evaluation of various forms of capital is referred to as *illusio*. *Illusio* is described as an ideology explaining how individuals perceive the legitimacy of certain pro-social actions in a particular field (Abercrombie and Turner, 1978). This perspective provides a framework to examine why individual actors engage in CSR by underlining the interaction among economic and non-economic motives as well as recognising both micro- and macro-influences (Aaken et al., 2013). Bourdieu's theory as a theoretical framework broadens the research scope to emphasise on the interaction between actors and organisations fields in the CSR context.

Institutional theory explores how companies' choices are shaped by and negotiated in the institutional environment. In fact, institutional theory offers an explanation of individual and organizational behavior (Lee, 2008). Companies in different national contexts understand and apply CSR differently. This is explained by the contextualization of CSR in national institutional environment (Bashtovaya, 2014). Institutional theory is useful framework to understand how institutional environment influence CSR (Campbell 2007; Aguilera and Jackson 2010; Bashtovaya 2014).

Companies need more than material resources and technical information in order to survive and expand; they 'require social acceptability and credibility' (Scott 1995, 71). CSR is undertaken to improve perceptions of legitimacy by societal actors (Young and Makhija, 2014). Legitimacy is a generalised perception that a company's performance and actions are appropriate and desirable in socially constructed systems of definitions, values, norms and beliefs (Suchman, 1995). Organisations develop rational and pragmatic strategies in response to the public expectations (Kuznetsov et al. 2009). According to Scott (1995, 45) legitimacy reflects 'cultural alignment, normative support or laws', which diminishes the possibility of societal penalties.

This exploratory study aims to investigate the institutional forces which influence how managers in the Russian oil industry and in particular we examine which of Scott's (1995) institutional pillars seem to frame managers' perceptions and actions.

The data collection process began with semi-structured interviews with employees of Russian oil companies. Participants were drawn from different departments and backgrounds, to ensure the diversity of perspectives. Following Miles and Huberman (1994), qualitative content analysis technique is used to analyse the interviews to identify themes in the data. Interviews were transcribed and coded manually. Codes are labels assigned to segments of documents such as paragraphs, sentences, or words (Miles and Huberman, 1994). This helps to catalogue key concepts.

Many Russian managers in the oil industry seem to believe that CSR is the 'right' thing to do.

'I think you can't avoid this today. Civilized business cannot exist (*without CSR*), especially a big one, especially natural resources companies' Manager G.

CSR projects, particularly in northern and remote regions of Russia, has become an 'unwritten rule' that must be obeyed.

'There are unwritten rules that are most important than written rules. And you need to follow these rules more strictly than written.... So the same situation here, no need to regulate CSR, it should be as unwritten rule, but should be obeyed as any other written rule. Any oil or gas company should be socially responsible.' Manager G.

Perhaps this normative pillar is linked to a perception of the oil industry of being in need of reputation repair in Russia.

'Please understand, we all want to be good. Is it not nice enough to build a nursery, if you have money, if you have time.' Manager A.

'and there is moral aspect to this.' Manager E.

Managers frequently invoke reciprocity, or 'giving back' which has become a norm.

'It is important to understand that business especially manufacturing, working with resources, you interfere with the environment and nature. You need to compensate to people. When you come to operate in regions, it is important to give something back.' Manager A.

'Companies should be working to benefit country, employees, community; companies should carry a responsibility. Not only making money, getting the profits, getting up and leaving.' Manager N.

Manager O explains that companies need to obtain a licence to operate. However there is no legislation that makes companies to spend money on social matters. Although it would be 'quite strange if an oil company did not consider any charity activities'. This is an expected role of a company in society.

Manager O explains that companies are considered as social care-takers, which is explained by the Soviet heritage. During the soviet times, towns were built and developed around 'factories'. The companies had their operations in regions, which then would have become towns. Companies provided social benefits to the community in these towns.

'Energy companies cannot operate without providing support to the local community. It is impossible. In this situation, a company comes to a new region with a licence, which concludes that a company can start the drilling. And now imagine, that a company doesn't

have any social responsibility, and then starts drilling. This is just impossible! The local authorities will get involved, will get in touch with media, they will write everywhere stating they are not happy. Gubernator will explain that you can't act like this here. ... These are unwritten rules.' Manager O.

According to Scott (2001) normative systems define objectives and goals of the company, but also indicate appropriate ways to achieve these. Participants explain that there are social obligations and societal moral rules that each company have to conform to. By this, they explain companies need to meet expectations of internal stakeholders such as employees, and external such as community where the company wants to perform. This behaviour is considered to be morally appropriate, which directs further behaviour and how things should be done (North, 1990). The normative standards, which are widely, accepted by a society increase the likelihood of socially responsible behaviour. CSR programmes instigated by Russian oil firms are considered by managers as being 'normal', 'moral' and seem to be aimed at restoring trust between large companies and society as deep mistrust in the large companies continues in Russian society (Fifka and Pobizhan, 2014).

Our findings show that companies are now moving towards a normative model of CSR, rather than being influenced by the paternalistic approach that has continued in Russia during the recent transition period. Social obligation and societal moral rules play a role in driving the extent of CSR practices. Companies need to meet expectations of various stakeholders such as local government, local community and employees, which is considered as morally appropriate behaviour in the context. We conclude that although Russian oil companies operate in a political context where the State has extensive influence in economic performance, the normative social pressure and social mechanisms are effective drivers for CSR in post-communist economy.

This paper's contribution is to demonstrate how normative forces shape the of CSR practices in this industry. This sheds light on the institutional logics that underline CSR practices, and puts forward implications for managers and policy makers to construct more effective CSR strategies. CSR needs to be contextualised and constructed with greater local sensitivity, and a better understanding of the local CSR values.

## REFERENCES

- Aaken, D., Splitter, V., & Seidl, D. (2013). Why do corporate actors engage in pro-social behavior? A Bourdieusian perspective on corporate social responsibility. *Organization*, 20 (3), 349-371.
- Abercrombie, N., & Turner, B. (1978). The dominant ideology thesis. *British Journal of Sociology*, 29, 149-170.
- Aguilera, R. V., & Jackson, G. (2003). The cross-national diversity of corporate governance: Dimensions and determinants. *Academy of management Review*, 28 (3), 447-465.
- Bashtovaya, V. (2014). CSR reporting in the United States and Russia. *Social Responsibility Journal*, 10 (1), 68 - 84.

- Bice, S., (2015), corporate Social Responsibility as Institution: A Social Mechanisms Framework, *Journal of Business Ethics*, 1 - 18
- Bourdieu, P. (2005). *The Social Structures of the Economy*. France: Polity.
- Campbell, J. (2007). Why Would Corporations Behave in Socially Responsible Ways? An Institutional Theory of Corporate Social Responsibility. *Academy of Management Review* , 38 (3), 946-967.
- Chapple, W., & Moon, J. (2005). Corporate Social Responsibility (CSR) in Asia A Seven- Country Study of CSR Web Site Reporting. *Business Society* , 44 (4), 415-441.
- DiMaggio, P. J., & Powell, W. (1983). The iron cage revisited: Institutional isomorphism and collective rationality in organizational fields. . *American Sociological Review* , 48, 147-160.
- Fifka, M. S., & Pobizhan, M. (2014). An institutional approach to corporate social responsibility in Russia. *Journal of Cleaner Production* , 82, 192-201.
- Kostova, T., & Roth, T. (2002). Adoption of an organization practice by subsidiaries of multinational corporations: Institutional and relations effects. *Academy of Management Journal* , 45 (1), 215–233.
- Kuznetsov, A., Kuznetsova, O., & Warren, R. (2009). CSR and the legitimacy of business in transition economies: The case of Russia. . *Scandinavia Journal of Management* , 26 (1), 37- 45.
- Lee, M. (2008.). A review of the theories of corporate social responsibility: Its evolutionary path and the road ahead. *International Journal of Management Reviews* , 10 (1), 53- 73.
- Matten, D., & Moon, J. (2008). "Implicit" and "Explicit" CSR: A Conceptual Framework for a Comparative Understanding of Corporate Social Responsibility. *The Academy of Management Review* , 33 (2), 404-424.
- Miles, M.B., Huberman, A.M., (1994), *Qualitative Data Analysis*, Sage, Beverly Hills.
- North, D. C. (1990). *Institutions, Institutional Change and Economic Performance*. USA: Cambridge University Press.
- Scott, W. (1995). *Institutions and Organizations. Ideas, Interests and Identities*. Thousand Oaks, CA: SAGE.
- Scott, W. (2001). *Institutions and Organizations*. Thousand Oaks, CA: Sage Publications.
- Suchman, M. C. (1995). Managing Legitimacy: Strategic and Institutional Approaches. *Academy of Management Journal* , 20 (3), 571 - 610.
- Tempel, A., Walgenbach, P., (2007), Global Standards of Organizational Forms and Management Practices? What New Institutionalism and the Business-Systems approach can Learn from Each Other, *Journal of Management Studies*, 44, 1 - 24
- Young, S., & Makhija, M. (2014 ). Firms' Corporate Social Responsibility Behavior: An Integration of Institutional and Profit Maximization Approaches. *Journal of International Business Studies* , 45 (6), 670-698.

## VERNACCIA DI SAN GIMIGNANO: A BUSINESS-CASE ANALYSIS TO RE-POSITION AN ITALIAN ORIGIN LABELLED WHITE WINE

Mattiacci, Alberto<sup>1</sup>; Caratù, Myriam<sup>1</sup>; Fisichella, Chiara<sup>2</sup>

<sup>1</sup>Dipartimento di Comunicazione e Ricerca Sociale CORIS, Università La Sapienza, Rome, Italy

<sup>2</sup>Dipartimento di Marketing, comunicazione, comportamenti e consumi, Università Iulm, Milan, Italy

### ABSTRACT

As every sector nowadays, Italian wine industry is facing the international economic crisis; however, it can be described as "in good healthy" and with lots of opportunities in a dynamic perspective. Italy seems not a country for white wines, both for production and for economic values, but this sector has started to collect interesting growing exchange values. In this context, in 2016, the Consortium of the Vernaccia di San Gimignano G.I. celebrated the 50th anniversary of its foundation: it is time to make a balance and think (or re-think) at the future.

This study starts from the analysis of the context of the Italian wine sector, with particular focus on still white wines sector, to outline a re-positioning to the market of Vernaccia di San Gimignano G.I. To achieve this purpose, we conducted a qualitative field research (interviews to experts) and an analysis of productive and economic data in a comparative way.

Signals from the GDO system – a mirror for consumer trends – show some opportunities for white wines: biological, typical and local (km0) products; trends in health consciousness and wellness. The conjunction of these factors, together with the growth of e-commerce, offers considerable opportunities for Italian white wines. But, in this general framework, for Tuscan white wines the challenge is greater: the reputation of the *terroir* principally concerned with the production of red wines.

This research outlines a profile of light and shadow for Vernaccia di San Gimignano G.I., with unexpressed potential assets that invest not only wine production but the territory as a whole (Castagno,2016). The results of the interviews indicated that this wine is seen by local people – including political and economic institutions – as a secondary asset for tourism sector. Also some producers had a certain grade of scepticism about the potential economic value of this wine. The result is that today the Vernaccia di San Gimignano G.I. appears relegated to a passive niche in the Italian white wine's sector.

Tring to synthetize the volume and value's characteristic of the Vernaccia di San Gimignano G.I. we can say: 50 million of bottles; 10% of wine production is "reserve wine"; 720 hectares; 50% of the production bottled; 145 €/hl price for unbottled, among one of the highest in Italian still white wine sector; 5.9 million euro of production economic value (Ismea, 2016); ninth place in the ranking of bottled wines for

volume growth in the Italian GDO (Iri, 2016); a long documented historic wine; third place for awareness among Italian whites.

Then, Vernaccia di San Gimignano G.I. is a small production, geographically well-bounded and strongly identified with one of the major Tuscany historic city for tourism attractiveness. By contrast, no global wine player is present to create a successful commercial model, both wine and territorial, as in Montalcino for example (Mattiacci and Zampi, 2004); there is an insufficient quality reputation but a good awareness, that it is not properly activated. To conclude, the Vernaccia di San Gimignano G.I. seems to lie in a borderland between the “not yet” and “no more”: not a great wine, expression of the Tuscan ability to create excellent wines; no longer the “poor parent” of Chianti, but with still too many qualitative discontinuity problem and without a G.I. big player to be an example. The strategic path that we identify for this G.I is to define an active niche in the market of local still white wine, profiling an offer enhancing the distinctive characteristics of the grape variety (savory, minerality, etc.) and the extraordinary narrative potential given by its territorial heritage, a very important competitive factor (Rocchi and Gabbai, 2013; Moulard *et al.*, 2015; Spielmann, 2015).

On these two primary assets, we can engage other two for a narrative and explication enrichment; Vernaccia di San Gimignano: is the only Italian DOCG white wine produced only in one municipality; is a wine easy to pair with food.

The analysis we conducted allows us to consider as a target for Vernaccia di San Gimignano G.I. a “male” profile, structured as follows: wine lover; male with more than 35; whole meal consumption patterns. The point of difference would be: for the product, longevity and savory; for the name, history and biological product. The price would be differentiated by type. Last but not least, the brand promise: a “solid white wine”. The path must be developed in a medium/long period, acting to the local community and to external stakeholders.

*Keywords: re-position; awareness; origin labelled wine; wine assets; branding; terroir*

## REFERENCES

- Castagno A. (2016), Vernaccia di San Gimignano. Vino territorio memoria, Consorzio della Denominazione San Gimignano, San Gimignano.
- Iri (2016) Infoscan Census, available at: <http://www.vinaly.com/it/news/comunicati-stampa/torna-a-crescere-il-vino-venduto-nei-supermercati/> (accessed 30 July 2016).
- Ismea (2016), Tendenze Vino n.1, available at: <http://www.ismeaservizi.it/report-analisi-agroalimentare/tendenze> (accessed 13 April 2016).
- Mattiacci A., Zampi V. (2004) "Brunello di Montalcino: how a typical wine could revive a poor country-village", *British Food Journal*, Vol. 106 (10/11), pp. 767 – 778.
- Moulard J., Babin B. J., Griffin M. (2015), "How aspects of a wine's place affect consumers' authenticity perceptions and purchase intentions: The role of country of origin and technical terroir", *International Journal of Wine Business Research*, Vol. 27 (1), pp. 61-78.

- Rocchi B., Gabbai M. (2013), "Territorial identity as a competitive advantage in wine marketing: a case study", *Journal of Wine Research*, Vol. 24 (4), pp. 291-310.
- Spielmann N. (2015), "Anything but typical: how consumers evaluate origin products based on their cues", *International Journal of Wine Business Research*, Vol. 27(1), pp. 23-39.



## TOWARDS A ROUTE TO MARKET FRAMEWORK FOR EUROPE WIDE AMBIENT ASSISTED LIVING TECHNOLOGY SOLUTIONS

McConalogue, Eoghan; Davis, Paul

Dublin City University, Ireland

### ABSTRACT

The purpose of this paper is to highlight developments in ambient assisted living technology (AAL) so as to drive discussion towards a route to market framework for a European wide AAL solution.

Due to time restrictions and the nascence of research in the area of route to market frameworks for AAL technologies models being applied to AAL technology assessment a secondary research approach was employed for this paper (Bryman and Bell, 2007).

Ambient assisted living technologies (AAL) is an emerging technological area that can provide assistance and support to persons suffering various diseases. The development of AAL technologies comes at a significant time with respect to world age profiles (Novitzky et al. 2014). It is estimated that there will be two elderly people to every young person in the European Union by 2060, with 10% of the population estimated to be over the age of 80 by 2060 (Eurostat, 2011). In some cases, the change is more immediate. By 2010, 23% of the population of Japan was 60 years of age or older and it is predicted to reach 39% within the next 40 years (SBJ, 2011). This unavoidable increase in the age profile of the population brings with it particular concerns. As age profiles increase so too does the prevalence of diseases associated with older age, namely mild cognitive impairment and cardio vascular disease (Novitzky et al. 2014). Our health care systems must be equipped with technologies to tackle these concerns. Recently, two Horizon 2020 funded research projects set out to develop AAL technologies that focus on two particular types of disease; cardio vascular disease (CVD) and mild cognitive impairment (MCI). AAL technological solutions aim to allow users suffering from a disease to aspire to an improved quality of life (QoL). Those suffering might enjoy the comforts of their own home. In addition, the application of AAL technologies can reduce the economic burden that currently rests on stressed health care systems, caregivers and patients.

In order for the lifting of economic burden and the destressing of health care systems to be realised, it is imperative that knowledge is developed with regard to the best routes to market for AAL technology solutions. An initial literature review of the healthcare delivery systems of partner countries within said projects elucidates the various and fragmented systems across Europe. Individual partner countries show varied combinations of public and private sector health care delivery systems (WHO, 2016). While literature relating to technology assessment for the purpose of route to market distribution does exist, (Kidholm et al. 2012; Janssen et al. 2013; Cusack et al. 2009)

none address the issue in a European wide context, further more existent literature is lacking in specific contemplation of AAL technologies.

The two Horizon 2020 projects related to this paper present a timely opportunity to build on existing literature associated with route to market frameworks for AAL technologies. Both projects have required the bespoke development of cost benefit analysis tools, total cost of ownership tools and business models for an emerging area, in addition to a comprehensive literature review of partner country health systems. At project maturity both solutions will have trialled suitable business models and commercialisation routes. It is now envisioned for two case studies on the respective experiences to be developed. Its purpose being to document the route to market experience of the solutions, culminating in a route to market framework being developed that can be employed in future Europe-wide projects dealing with healthcare delivery systems.

*Keywords: Ambient assisted living, Commercialisation, Healthcare systems, Horizon 2020, Business Models, Framework*

## REFERENCES

- Bryman, A., & Bell, E. (2007). *Business Research Methods*. Oxford University Press.
- Cusack, C.M. et al., 2009. A Health Information Technology Evaluation Toolkit: 2009 Update. AHRQ Publication, (9), pp.1–59. Available at: [https://healthit.ahrq.gov/sites/default/files/docs/biblio/09\\_0083\\_EF.pdf](https://healthit.ahrq.gov/sites/default/files/docs/biblio/09_0083_EF.pdf) [Accessed April 24, 2017].
- Eurostat. (2011). Population projections. European Commission. Retrieved from [http://epp.eurostat.ec.europa.eu/statistics\\_explained/index.php/Population\\_projections](http://epp.eurostat.ec.europa.eu/statistics_explained/index.php/Population_projections)
- Janssen, R. et al., 2013. Developing evidence guidelines for eHealth small and medium-sized enterprises. *eTELEMED 2013: The Fifth International Conference on eHealth, Telemedicine, and Social Medicine*, 5(c), pp.92–95.
- Kamel, M.N. et al., 2011. Geo-enabled technologies for independent living : Examples from four European projects. , 23(September 2010), pp.7–17.
- Kidholm, K. et al., 2012. a Model for Assessment of Telemedicine Applications: Mast. *International Journal of Technology Assessment in Health Care*, 28(1), pp.44–51. Available at: [http://www.journals.cambridge.org/abstract\\_S0266462311000638](http://www.journals.cambridge.org/abstract_S0266462311000638).
- Novitzky, P., Smeaton, A. F., Chen, C., Irving, K., Jacquemard, T., O’Brolcháin, F., ... Gordijn, B. (2014). A Review of Contemporary Work on the Ethics of Ambient Assisted Living Technologies for People with Dementia. *Science and Engineering Ethics*. <https://doi.org/10.1007/s11948-014-9552-x>
- SBJ. (2011). *Statistical handbook of Japan 2011*. Statistics Bureau and the Director-General for Policy Planning of Japan: <http://www.stat.go.jp/english/data/handbook/index.htm>
- World Health Organisation 2016. *From Innovation to Implementation: eHealth in the WHO European Region* [Online]. Available from: <http://www.euro.who.int/en/publications/abstracts/from-innovation-to-implementation-ehealth-in-the-who-european-region-2016>

## HEDGE FUNDS PERFORMANCE TRACKING FOR CYPRUS, U.K. AND IRELAND

Mihai Yiannaki, Simona

Dept. of Accounting, Economics and Finance, European University Cyprus, Nicosia, Cyprus

### ABSTRACT

Hedge funds global assets under management have been consistently increasing and at the moment have a value of over three trillion dollars (Prequin, 2016). The current study performs a comparative analysis of 10 hedge funds performance in each of the three countries: Cyprus, as the local market and Ireland and United Kingdom as the countries leading the hedge funds European industry. The sample size of the hedge funds selected totals Assets under Management of over 258 million euro in Cyprus, over 90 billion euros in the U.K., and in Ireland over 29 billion euro, which represent a significant 121-billion-euro sample of this market worldwide.

The analysed period of active returns is 75 months all through January 2010 to March 2016 for each hedge fund against the monthly returns of several benchmark markets via their index, as alternatives for investments: FTSE 100, S&P 500, ISEQ ALL and EURO STOXX 50., based on databases which include: Morning Star, Financial Times, Hedge Fund Intelligence ECB, CCB and CySEC.

The study presents the legislative background of hedge funds operations in the European Union, U.K. and Cyprus, compared to the U.S., trying though to focus on the management performance comparisons including their risk appetite analysis.

The main part of the analysis has collected, analyzed and interpreted data regarding the funds under examination, using the commonly use statistical measures of mean and standard deviation. In addition to Tracking Error of the active returns, the study's methodological tools are the risk adjusted measures: the Sharpe ratio, its adapted version the Modigliani risk-adjusted performance measure  $M^2$ , and last but not least the Jensen's Alpha coefficient.

Several t tests confirm and rejected the hypothesis regarding the performance of the funds under examination relative to above mentioned benchmark markets as alternatives for investments. The study findings show a relative under-performance of the Cypriot Funds compared to UK and Ireland Funds, overall, all the funds outperformed most of the benchmark markets that were compared to. The study limitations are the biases of the strategy used for investment of each hedge fund and on the variation of their regulatory base.

*Keywords: hedge funds, active returns, tracking error, Modigliani Risk-Adjusted Measure, Jensen's alpha, Sharpe ratio, Cyprus, U.K., Ireland, investments.*

## REFERENCES

- Cyprus Stock Exchange, (2016), <http://www.cse.com.cy/en-GB/home/>
- Capocci, D. (2006). Comparative Analysis of Hedge Fund returns, EDHEC Business School of Lille-Nice
- Dai Na and Hany A. Shawky, (2012). Diversification Strategies and the Performance of Funds of Hedge Funds. Published at The Journal of Alternative Investments.
- Ernst, Young, (2015), Estimating risk-free rates for valuations, [http://www.ey.com/Publication/vwLUAssets/EY-estimating-risk-free-rates-for-valuations/\\$FILE/EY-estimating-risk-free-rates-for-valuations.pdf](http://www.ey.com/Publication/vwLUAssets/EY-estimating-risk-free-rates-for-valuations/$FILE/EY-estimating-risk-free-rates-for-valuations.pdf)
- Eureka Hedge, 2015, [http://www.eurekahedge.com/NewsAndEvents/News/1433/2015\\_Key\\_Trends\\_in\\_European\\_Hedge\\_Funds#lightbox\[eureka\]/0/](http://www.eurekahedge.com/NewsAndEvents/News/1433/2015_Key_Trends_in_European_Hedge_Funds#lightbox[eureka]/0/)
- European Union, Banking and Finance, (2013), [http://ec.europa.eu/finance/investment/alternative\\_investments/index\\_en.htm](http://ec.europa.eu/finance/investment/alternative_investments/index_en.htm)
- Financial Times, (2016), <http://www.ft.com/intl/cms/s/0/60666862-ec77-11e5-bb79-2303682345c8.html#axzz48q0nrq22>
- Gregoriou and Kooli. (2014). Ranking of the Largest 25 Hedge Funds during the 2009-2013 periods. Published at The journal of wealth management.
- Jacqueline Henn and Iwan Meier. (2005). Performance Analysis of Hedge Funds.
- KPMG Cyprus, (2014), The Alternative Investment Fund law, <http://www.kpmg.com/CY/en/industry/Documents/Investment-Funds-Law.pdf>
- London Stock Exchange, (2016) ,<http://www.londonstockexchange.com/exchange/prices-and-markets/stocks/indices/summary/summary-indices.html?index=ASX>
- Lucinda Shen, (2016), Hedge Fund Outflows Will Reach at Least \$25 Billion This Year <http://fortune.com/2016/04/22/hedge-fund-outflows-will-reach-at-least-25-billion-this-year/>
- Managed Fund Association, Hedge Funds Structure, <https://www.managedfunds.org/hedge-fund-investors/industry-fact-sheets/hedge-fund-structure/>
- Mihai Yiannaki, S. (2015). ETFs performance Europe- a good start or not?, 3rd Economics & Finance Conference, Rome, Italy, April 14-17, 2015 and 4th Economics & Finance Conference, London, UK, August 25-28, 2015, accessed from <http://www.sciencedirect.com/science/article/pii/S2212567115013465>
- Peter Lazaroff. (2016), What are Hedge Funds Good For, [https://blogs.cfainstitute.org/investor/2016/02/24/hedge-funds-what-are-they-good-for/?s\\_cid=eml\\_TopSocialContent](https://blogs.cfainstitute.org/investor/2016/02/24/hedge-funds-what-are-they-good-for/?s_cid=eml_TopSocialContent)
- Ph.D WALTER ASPADAREC, (2013). Investment Performance of Hedge Funds, Szczecin University.
- Preqin Global Hedge Fund Report, (2016), <https://www.preqin.com/docs/reports/2016-Preqin-Global-Hedge-Fund-Report-Highlights.pdf>
- Preqin, (2013), Preqin Special Report about Ucits Hedge Funds June 13, [https://www.preqin.com/docs/reports/UCITS\\_Hedge\\_Funds\\_Report\\_June\\_2013.pdf](https://www.preqin.com/docs/reports/UCITS_Hedge_Funds_Report_June_2013.pdf)
- Preqin, (2015), Preqin quarterly Hedge Fund Update 2015, <https://www.preqin.com/docs/quarterly/hf/Preqin-Quarterly-Hedge-Fund-Update-Q3-2015.pdf>
- PWC Cyprus, (2015), Setting up of an AIF in Cyprus, <https://www.pwc.com.cy/en/publications/assets/setting-up-alternative-investment-fund-cyprus-leaflet-english.pdf>
- Securities and Exchange Commission, Investors protection, (2013), [https://www.sec.gov/investor/alerts/ib\\_hedgefunds.pdf](https://www.sec.gov/investor/alerts/ib_hedgefunds.pdf)

## **BORN GLOBAL FAMILY FIRMS**

**Musso, Fabio; Francioni, Barbara; Masili, Giorgia**

Department of Economics, Society and Politics, University of Urbino Carlo Bo, Italy

### **ABSTRACT**

Family firms play a very important role in today's international markets, especially because, among small and medium size enterprises (SMEs), they cover a high percentage in different European countries (e.g., Donckels and Frohlich, 1991; Surdej and Wach, 2012). During the years there was a growing interest on family firms' internationalization (e.g., Graves and Thomas, 2008; Pukall and Calabrò, 2014). Some authors focused on discovering which variables influence the international expansion (Gallo and Sveen, 1991; Gallo and Garçia Pont, 1996; Zucchella et al., 2007; Calabrò et al., 2016). However, the majority of contributions have been concentrated on gradual/step-by-step/Uppsala model type internationalization (Graves and Thomas, 2008; Kontinen and Ojala, 2010), while few studies have been tailored on born global family firms (Wach, 2014). The principal aim of this study is to examine how family firm's characteristics and external factors can enable or limit the internationalization process of born global firms. To achieve our objective, we decided to adopt a multiple case study. Data were mainly collected through in-depth, face-to-face interviews with owners from two Italian born global firms located in Marche region. For data triangulation, we also collected data and information from other sources, such as annual reports, firms' homepage, and other documents (Vissak and Francioni, 2013). For examining the different aspects and factors influencing the internationalization of these firms, we decided to create a more comprehensive framework based on Gallo and Garçia Pont scheme (1996). In details, we considered three categories: strategic factors, family firms' organization characteristics, and top management features. All categories have been divided into elastic and rigid variables. Preliminary results showed that variables stimulating the internationalization process were mainly related to the owners' backgrounds and their past work experiences. Moreover, the presence of other businesses run by either the entrepreneur or his family members, for which relationships with foreign markets were already established, allowed growing up rapidly in international markets. Similarly, family members living abroad provided effective support in the search for foreign customers and made a valuable contribution to the firm's international expansion. Furthermore, although the entrepreneur was the main decision-maker in the majority of international strategic decisions, other family members showed a similar approach, to that of the entrepreneur, towards international activities. With specific reference to entry barriers, they were mainly associated with import rules and bureaucracy, and less with the family business characteristics. The paper represents just the beginning of an in-depth analysis through which

understanding the dynamic of born global internationalization among family firms, but it is one of the first contributes to the studies of born global family firms.

*Keywords: Internationalization, SMEs, Born Global, Family Firms*

## REFERENCES

- Calabrò, A., Brogi, M. and Torchia, M. (2016), "What does really matter in the internationalization of small and medium-size Family Businesses?", *Journal of Small and Business Management*, Vol. 54 No. 2, pp. 679-696.
- Donckels, R. and Frohlich, E. (1991), "Are family businesses really different? European experiences from STRATOS", *Family Business Review*, Vol. 4 No. 2, pp. 149-160.
- Gallo, M. A. and Garcia Pont, C. (1996), "Important factors in family business internationalization", *Family Business Review*, Vol. 9 No. 1, pp. 45-59.
- Gallo, M. A. and Sveen, J. (1991), "Internationalizing the family business: Facilitating and restraining factors", *Family Business Review*, Vol. 4 No. 2, pp. 181-190.
- Graves, C. and Thomas, J. (2008), "Determinants of the internationalization pathways of family firms: An examination of family influence", *Family Business Review*, Vol. 21 No. 2, pp. 151-167.
- Kontinen, T. and Ojala, A. (2010), "Internationalization pathways of family SMEs: psychic distance as a focal point", *Journal of Small Business and Enterprise Development*, Vol. 17 No. 3, pp. 437-454.
- Pukall, T. J. and Calabrò, A. (2014), "The internationalization of family firms: A critical review and integrative model", *Family Business Review*, Vol. 27 No. 2, pp. 103-125.
- Surdej, A. and Wach, K. (2012), "The dynamics of succession in family businesses in Poland - Empirical results", *Economia Marche Journal of Applied Economics*, Vol. 31 No. 2, pp. 109-128.
- Vissak, T. and Francioni, B. (2013), "Serial non linear internationalization in practice: A case study", *International Business Review*, Vol. 22, pp. 951-962.
- Wach, K. (2014), "Familianness and born globals: Rapid internationalization among polish family firms", *Journal of Intercultural Management*, Vol. 6 No. 3, pp. 177-186.
- Zucchella, A., Palamara, G. and Denicolai, S. (2007), "The drivers of the early internationalization of the firm", *Journal of World Business*, Vol. 42 No.3, pp. 268-280.

## THE EFFECT OF NEPOTISM / WASTA ON HR PRACTICES IN LEBANESE AND TUNISIAN COMPANIES

Nakhle, Samer F.<sup>1</sup>; Yahiaoui, Dorra<sup>2</sup>; Vrontis, Demetris<sup>3</sup>; Naddour, Fadi<sup>4</sup>

<sup>1</sup>Azm University, Lebanon

<sup>2</sup>Kedge Business School, France

<sup>3</sup>University Of Nicosia, Cyprus

<sup>4</sup>University Of Balamand, Lebanon

### ABSTRACT

It is sometimes a premise in Middle East and North African countries that empty positions are not always filled on the basis of capabilities, experiences, high standards and elevated expectations. As a result, the reputation and even the quality of organizations in such region are sometimes not at the level of developed countries. Numerous companies in Lebanon & Tunisia are under corruption and bankruptcy. Along with that, there was continuous pressure on the top administrations of few companies in both the public and private sectors to provide jobs and in some cases, employing two candidates for the same position. Hence, there was a lot of interference, favoritism, cronyism and nepotism while filling vacant positions. Nepotism, as considered by several researchers as a corruption practice, was a problematic phenomenon in these countries in both public and private sectors. In the absence of a connection with the employer, be it social or familial, the candidate has a small or in some cases no chance in getting the job. In fact, Nepotism is the act of showing favoritism to a member of a relative, a friend or a connection by offering him/her a job or a certain position (Arasly et al., 2006) There are two types of Nepotism, the horizontal nepotism happens between counterparts such as business partners, friends and colleagues, and the vertical nepotism which is related to the superior and subordinate relationships (Khatri and Tsang, 2003).

From HR point Nepotism carries numerous issues with it, as it is seen as a work that holds nonobjective standards of recruiting in light of kin relations rather than objective standards that focus on knowledge, experience, abilities and capabilities. Bute (2011) showed that nepotism has significant negative effect on job satisfaction, organizational commitment and practices of human resource management. If employees are in competition with a privileged individual, their probability of promoting is low (Abdalla et al., 1994). Thus, Nepotism if based on kinship can cause family struggles, conflicts between generations, weakened organizational commitment and turnover of competent and high quality managers (Ozler et al., 2007).

Other views often see nepotism as an advantage to the association where some companies rely on nepotism in order to get the work done; Other positive aspects of nepotism can be that if a person is appointed through nepotism by using his relations in the organization, then he can probably have a

shorter career development paths to go up to higher levels in the organization without the need to go through all the organizational routine steps. Another advantage is that hiring a friend/relative through nepotism means that you already know his capabilities and will allocate the correct task for every individual in view of the individual quality and weaknesses. Another issue is that a friend or family member may be familiar with the company and know how it function, so there is no need to spend as much time to train and mentor new employees with the work process in the company. Moreover, relatives and friends who are hired may possess a strong commitment to the company, where they might be ready to work additional hours or even ends of the week when important. Therefore, Nepotism is thought to be effective when it is utilized suitably. But when it causes irreconcilable situations, homogeneity and legitimate inconveniences, it is dealt with as inefficient nepotism (Khatri and Tsang, 2003).

In the Arab world, "*Wasta*" is the term used to refer to Nepotism/ social networks or connections (Cunningham and Sarayah, 1993). Historically, *Wasta* was used as a mean for managing relations between families and tribes in the Arab countries through the use of an intermediary usually referred to as the sheikh who would be called on to be the intercession or the *Wasta* between the conflicting parties (Cunningham and Sarayah, 1993). In fact, in these countries, there is a high need to establish trust so that business relationships can succeed. Trust is usually built at the personal level (Al-Hussan & Flether-Chen, 2014) and here "*Wasta*" plays a critical role (Al-Omari, 2008). It is clear that *wasta* affects heavily recruitment and selection among other HR practices. *Wasta* in the Arab world is also a critical component for career success (Singh et al., 2006).

While nepotism/*Wasta* has been a pervasive social phenomenon in every culture, prevailing in family businesses, the topic has majorly been a taboo for academic research. Although the phenomenon prevails in many organizations in Lebanon, Tunisia and the Middle East, the topic is still under researched. Most of the studies explore the factors behind nepotism in Arab countries including cultural, economic and social factors (Abdalla et al., 1998). There are no studies about nepotism/ *Wasta* in Lebanon and Tunisia and how it influences human resource practices.

Our research contributes to addressing the lack of researches dealing with the effect of nepotism on HR practices in Lebanese companies. The study is significant in the way it addresses the nepotism phenomena in Lebanese & Tunisian companies from different perspectives and shows how the different HR practices are influenced by this phenomenon. **Our research question will be: How does nepotism affect HR practices in Lebanese and Tunisian companies?**

To answer this research question, the qualitative research method was preferred as it focuses on meanings and understanding of a particular issue (Rubin &Rubin, 2005). Moreover, Nepotism as a



sensitive topic is a common phenomenon yet concealed and avoided to be discussed (Jones, 2013) which requires a different level of interaction than in quantitative method. We adopt the semi-structure interview technique (face-to-face interview). A thematic analysis is done to analyze the content of the interviews conducted with respondent from different organizational industries in order to avoid a single view perspective of nepotism. Each organization is represented by the HR manager or supervisor from the human resources department. 20 companies from the educational, health, banking, NGO, chemical, automotive, electronic, oil, agro-food, ceramic industry, garment sectors were surveyed in Lebanon & Tunisia. Among these companies 13 are locals and 7 Western Multinationals.

All organizations considered that nepotism as a practice may foster inequality between employees if applied. In both countries, it is still a practice mainly found in the public organizations where fraud and corruption prevail. On the other hand, some organizations in the private sector are developing awareness about nepotism as a possible challenge and implementing anti-nepotism rules and regulations. Unfortunately, some organizations specially the locals still have the ideology that if you are not an individual from a specific political gathering, religion, or if you are not connected to someone with authority to influence the recruiting process or the HR decision, then you face no chance in being recruited. They claimed that favored employees recruited through nepotism can demonstrate a highly-motivated work drive since they want to prove to their employer that recruiting them was the right choice. Most of Western companies interviewed mentioned indirectly the use of Wasta through the personal network during our investigation of their HR practices. All interviewees agreed that nepotism could lead to a decline in the company's and the HR department performance. They implied that it is an unprofessional act that can limit the HR's decisions thus limiting their work and demotivating their department. Regarding the anti- nepotism policy, few organizations had the policy implemented in their organizations. Some of the policies were mentioned in their internal regulation booklet and in other organizations it wasn't. Regarding organizations that apply anti-nepotism guidelines; all employees in their workplace had to submit a form, indicating the areas where their relatives are working. Only Western organizations are stricter in performing such mechanism than others.

Related to Khatri and Tsang, 2003, we notice a common use of horizontal Nepotism during the recruitment process through the use of personal network related to family, or friends belonging to the neighborhoods or to the school. The Wasta in this case is the only guarantee of trust and a predictability of others' reactions which confirm the research of Al-Hassan et al. (2014). While the vertical nepotism is much more used during a contract renewal, a promotion, or even for training request and salary or bonus bargaining. Other cultural dimensions play a big role in this latest case to

justify the mobilization of Wasta by the subordinates and its acceptance by the superior such as: compassion, emotional relationship, loyalty, etc.

Our research shows the negative impact that nepotism could have on the employees morale and attitudes, and on the organization in general by affecting its performance and slowing down its advancement in reaching the goals. It is seen as a problematic phenomenon that nepotism can destroy harmony and motivation among employees, offering inequity, unfairness, inefficiency and the lack of dedication and engagement to the work. Along with that, there is a tendency that conflict can occur especially when there are favored employees who are treated differently compared to their colleagues. The un-favored employees will be less satisfied and could engage in troublesome behavior which can affect the achievements of the organization and overall objectives. Such discontented employees will work below their optimal level, increase absenteeism and turnover (Ozler et al., 2007). Furthermore, employees will have a sense of insecurity where they might fear not having the opportunity to grow, develop or get promoted due to the absence of a connection with the stakeholders at their respective companies (Abdalla et al., 1994). Through this research we also confirm and describe the negative impact that could have Nepotism/wasta on different HR practices (Bute, 2011) such as recruitment, career management, training & development and compensation.

In order to start reducing this phenomenon in organizations, we advise human resources management to stay ethical and professional. HRM should know what role they have in an organization, the decision-making authority invested in them and be aware of the direct impact that could have nepotism /wasta on the organization performance as well as on its social climate. It is important for HRM to communicate with the CEO or manager on daily basis and trade information regarding employees and their progress.

*Keywords: Nepotism, Wasta, HR practices, Lebanon, Tunisia*

## REFERENCES

- Abdalla, H. F., Maghrabi, A. S., & Raggad, B. G. (1998), "Assessing the perceptions of human resource managers toward nepotism: A cross-cultural study", *International Journal of Manpower*, Vol.19, No.8, pp. 554-570.
- Abdalla, H. F., Maghrabi, A. S., & Raggad, B. G. (1994), "Assessing the effect of Nepotism on Human Resource Managers", *International Journal of Manpower*, Vol. 15 No. 1, pp. 60-67.
- Al-Hussan, F.B & Fletcher-Chen, C.C.Y. (2014), "Environmental factors influencing the management of key accounts in an Arab Middle Eastern context", *Industrial Marketing Management*, Vol.43, No.4, pp. 592-602.
- Al-Omari, J. (2008), *Understanding the Arab culture: A practical cross-cultural guide to working in the Arab world*, Hachette, London.
- Arasli, H., Bavik, A., & Ekiz, E. H. (2006), "The effects of nepotism on human resource management: The case of three, four and five star hotels in Northern Cyprus", *International Journal of Sociology and Social Policy*, Vol. 26, No.7/8, pp.295-308.
- Bute, M. (2011), "The effects of nepotism and favoritism on employee behaviors and human resources practices: A research on Turkish public banks", *Review of Public Administration*, Vol.5, No.1, pp. 158-208

- Cunningham, R. B. & Sarayah, Y. K. (1993), *Wasta: The hidden Force in the Middle Eastern Society*, Praeger Publishers, Westport, USA.
- Khatri, N. & Tsang W. K (2003), "Antecedents and consequences of cronyism in organizations", *Journal of Business Ethics*, Vol. 43, No.4, pp. 289-303.
- Jones, R. G. (Ed.). (2013), *Nepotism in organizations*, Routledge, New York.
- Ozler, H., Ergun, D. O. & Gumustekin, G. E. (2007), "Aile isletmelerinde Nepotizimin Gelism Evreleri ve Kurumsallasma", *Selcuk Universitesi Sosyal Bilimler Dergisi*, Vol.17, pp.437-450.
- Rubin, H. J., & Rubin, I. S. (2011), *Qualitative interviewing: The art of hearing data*, Sage, New York.
- Singh, V., Vinnicombe, S. and Kumra, S. (2006), "Women in formal corporate networks: an organizational citizenship perspective", *Women in Management Review*, Vol.21, No. 6, pp. 458-82.

## DOES FUND RAISING TRIGGER THE INTERNATIONALIZATION OF STARTUPS?

**Onetti, Alberto; Pisoni, Alessia**

Department of Economics, University of Insubria, Varese, Italy

### ABSTRACT

Recent studies about startup ecosystems - carried out with the purpose of identifying the European fast-growing companies - highlighted the emergent phenomenon of the “Dual Companies” for European ICT startups (Onetti, 2017; SEP 2015, 2017). According to these studies, dual companies are new ventures founded in one country that relocated abroad, shortly after inception, their headquarters – and, with that, part of their value chain – while maintaining a strong operational presence in the country of origin (Onetti 2017). Initial research shows that dual companies typically move to countries that have a more developed financial market with the goal of having access to capital (SEP, 2017).

Due to their fast pace of internationalization, these companies could be defined by academic literature as Born Globals/Global Startups (Oviatt and McDougall, 1994, 1995). Born Globals are often technology-oriented and go international from inception or very shortly thereafter not following “traditional” path of internationalization. In this perspective, dual companies could be considered as a subset of born global firms characterized by peculiar features.

The lack of financial resources is the most limiting factor for startups’ growth. Several studies highlight the crucial role played by equity financing in the survival and successful development of new high-growth ventures (Davila et al., 2003; Pisoni and Onetti, 2016; Talaia et al., 2016) and for their international expansion (Loustarinen and Gabrielsson, 2004; Laanti et al., 2007). It follows that a low availability of venture financing in the home country could encourage early internationalization of the new venture towards those countries where founders have more chances to get access to financial resources. Therefore, it could be of great importance to explore in-depth the characteristics of the fund raising path of the above-mentioned dual companies (i.e. number of rounds, time, amount, typology/nationality of investors) to better understand their international growth path. We specifically aim at understanding whether:

- 1) the international growth path for innovative new ventures is affected by the need of financial resources (and the lack of financial resources in the home country);
- 2) the geographical expansion of the new venture is correlated to the nationality of investors.

These aspects of analysis emerge as being largely overlooked by scholars, mostly focused on the phenomena of the early internationalization – mainly in terms of intensity or degree, speed of internationalization - rather than on the reasons behind and on related operational and structure-

related decisions. Drawing on this conceptual framework, we focus on technology-oriented born global startups that due to their small size, young age and ambitious expansion plans usually face significant financial constraints. As pointed out by Clarysse, Bruneel and Wright (2011), the growth paths for young technology-based firms result from structuring resource portfolios. The basis of this approach is in the resource dependence view (Pfeffer and Salancik, 1978), which posits that firms are dependent on externally controlled resources for their survival.

To investigate the proposed issue, we choose a multiple case study approach (Eisenhardt, 1989; Yin, 1994). Our approach is exploratory. Accordingly, the selected cases are first studied as standalone entities and then compared across cases. We analysed in-depth the characteristics of the funding rounds of the above-mentioned dual companies to better understand how the fund raising process and their international growth path are intertwined.

The multiple case analyses highlights how - for almost all the above analysed companies the Series A - the first major round of financing undergone after the seed capital - was backed and led by foreign venture capitals. Not surprisingly, companies declared that the purpose to pitch the business idea in foreign - mainly US - startup contests/competitions was "looking for funds". This aspect is relevant to our analysis since access to financial resources has been identified as a crucial barrier for young technology-based companies aiming at globalising their business early after inception (Luostarinen and Gabrielsson, 2004; Laanti et al., 2007; Gabrielsson et al., 2004; Cannone et al., 2014). In this respect, the cross-case analysis also highlights how in almost all cases the headquarters relocation in the US - specifically Silicon Valley - occurred early after inception (on average within 2/3 years since company foundation), but after - or almost concomitantly - obtaining/securing a funding round from a US investor. Furthermore, US investors providing initial funding to the company continued to invest in the same companies in the subsequent rounds, also together with other venture capital funds either from the US or from different countries.

It appears clear that a low availability of venture financing in the home country could trigger early internationalization of startups towards those countries where founders have more chances to get access to financial resources, either in terms of quantity and/or quality. The US represent a recurring destination, thus confirming previous research carried out on new technology-based born globals (Cannone et al., 2014).

Some limitations of this study must be remarked. Since this is a case-based study, the findings above summarized are limited to the qualitative research approach (e.g. case selection) and therefore one should be cautious in generalizing results beyond the startups analysed. Nevertheless, the study contributes to shed light on the issues that European ICT startups face in scaling-up in Europe due to the lack of adequate domestic (either national and European) funding. It also identifies novel paths of

international development that startup companies follow to deal with the obstacles that prevent them to grow rapidly in their home country.

## REFERENCES

- Cannone, G., Pisoni, A. and Onetti, A. (2014), "Born global companies founded by young entrepreneurs. A multiple case study", *International Journal of Entrepreneurship and Innovation Management*, Vol. 18 No. 2-3, pp. 210-232.
- Clarysse, B., Bruneel, J. and Wright, M. (2011), "Explaining growth paths of young technology based firms: structuring resource portfolios in different competitive environments", *Strategic Entrepreneurship Journal*, Vol. 5 No. 2, pp. 137-157.
- Davila, A., Foster, G., and Gupta, M. (2003), "Venture capital financing and the growth of startup firms", *Journal of Business Venturing*, Vol. 18 No. 6, pp. 689-708.
- Eisenhardt, K. (1989), "Building theories from case study research", *Academy of Management Review*, Vol. 14 No. 4, pp. 532-550.
- Gabrielsson, M., Sasi, V., and Darling, J. (2004), "Finance strategies of rapidly-growing Finnish SMEs: born internationals and born globals", *European Business Review*, Vol. 16 No. 6, pp. 590-604.
- Laanti, R., Gabrielsson, M., and Gabrielsson, P. (2007), "The Globalization Strategies of Business-to-Business Technology Industry", *Industrial Marketing Management*, Vol. 36, pp. 1104-1117.
- Loustarinen, R., and Gabrielsson, M. (2004), "Finnish perspective of international entrepreneurship", in *Handbook of Research on International Entrepreneurship*, edited by Dana, L.P., pp. 383-403, Cheltenham: Edward Elgar.
- Onetti A. (2017), *Study on Transatlantic Dynamics of New High Growth Innovative Firms*. DG for Research and Innovation – European Commission.
- Oviatt, B.M., and McDougall, P.P. (1994), "Toward a theory of international new ventures", *Journal of International Business Studies*, Vol. 25 No. 1, pp. 45-64.
- Oviatt, B.M., and McDougall, P.P. (1995), "Global start-ups: entrepreneurs on a worldwide stage", *The Academy of Management Executive*, Vol. 9 No. 2, pp. 30-44.
- Pfeffer, J., and Salancik, G.R. (1978), *The external control of organizations: A resource dependence approach*, New York: Harper and Row Publishers.
- Pisoni A., and Onetti A. (2016), *New venture growth From start-up to scale-up*, in Vrontis D., Bresciani S., Rossi M. (Eds.), "Managing Globalization. New Business Models, Strategies and Innovation", Cambridge Scholars Publishing, pp. 156-181.
- SEP – Startup Europe Partnership (2015), "SEP Monitor – From Unicorns to Reality, A Five-Country Comparison of European ICT Scaleups", No. 9, July 2015.
- SEP – Startup Europe Partnership (2017), *SEP Report "European Dual Companies – Scaleup migration?"*, June 2017.
- Talaia M., Pisoni A., and Onetti, A. (2016), "Factors influencing the fund raising process for innovative new ventures: an empirical study", *Journal of Small Business and Enterprise Development*, Vol. 23 No. 2, pp. 363-378.
- Yin, R.K. (1994), *Case Study Research: Design and Methods*, London: Sage.

## THE VISITOR EMOTIONAL EXPERIENCE AT A HERITAGE SITE: A CASE STUDY – THE AUSCHWITZ-BIRKENAU DEATH CAMP

Oren Gila<sup>1</sup>; Poria Yaniv<sup>2</sup>; Reichel Arie<sup>2</sup>

<sup>1</sup>The School of Business Administration, The College of Management Academic Studies, Rishon-Le’Zion, Israel

<sup>2</sup>Department of Hotel and Tourism Management, Guilford Glazer School of Business and Management, Ben Gurion University of the Negev, Be’er-Sheva, Israel

### ABSTRACT

The increasing number of visitors to sites of death and atrocities is a major growth engine in the tourism industry (Timothy & Boyd, 2006), yet little has been written about the onsite experience. Especially lacking is a conceptualization of the visitor experience as related to the emotional experience. The major limitations at the current state of the art in this area are:

1. The visitor experience has not been studied as a total hierarchical process.
2. Research on the emotional experience of tourism, especially heritage tourism, is sparse, with emphasis on positive emotions and fun seeking, ignoring negative emotions that could pertain to sites of death and atrocities.

These gaps led to a study of variables and behaviors linked with three timeframes: Pre-visit – motives for visiting, visitors’ perception of the significance of this heritage to their lives; Visit – emotional experience, the quality of experience; End of visit – perception of benefits gained from the visit.

The research hypotheses were investigated using a questionnaire (in Hebrew, English, German, or Polish) based on scales used in psychology and tourism: Self-perception of Heritage displayed – PSOH (Poria, Reichel, & Biran, 2006), meaning of life and the search for meaning (Steger et al., 2006), Positive Affect Negative Affect scale – PANAS (Watson, Clark, & Tellegen, 1988). Additional variables (e.g., motives for visit, quality of experience, and perception of benefits), were examined using questions based on the literature review and the preliminary qualitative stage (i.e. in-depth interviews with people planning to visit the site).

Participants were a quasi-randomly selected sample of 553 visitors age 18 and older, to the Auschwitz-Birkenau death camp in the summer of 2012. Participants received a questionnaire. The findings revealed an emotional duality, exposing the central role of negative emotions and their significant contribution to the perceived quality of the visit. This challenges a common notion in tourism research

which emphasizes positive emotions, and relates negative emotions to dissatisfaction with the visitor experience.

The findings indicate that the onsite experience is composed of an emotional experience, an intellectual one, an experience related to the visitor's identity, and an experience that affects one's worldview. The weight and importance of each of these experiences was linked to the visitor's perception of the heritage displayed onsite as their own.

The findings underscore the need to examine the relationship between the visitor and the visited object (Collins-Kreiner, 2010), and support the distinction between heritage tourists and visitors to heritage sites (Poria, Butler, & Airey, 2003).

The study revealed the perception of three benefits derived from the visit: (1) cognitive benefits – expanding the visitor's knowledge and better understanding the events that took place at the site; (2) heritage-related benefits – constructing the visitors' identity as related to the site and exhibits; and (3) moral benefits – visitors attribute the visit with an effect on their attitudes and moral perception. The moral benefits, which the present study was the first to reveal, are of major contribution to the management of the visitor experience as well as to the understanding of the personal and social role of heritage sites in modern society. This study challenges the current approach to the conceptualization of the visitor experience. Researchers should note that basing a theoretical approach to heritage tourism on a corpus of knowledge related to leisure and recreation may lead to mismanagement and misunderstanding of this compounding social phenomenon.

The findings and conclusions have far-reaching managerial implications. The complex visitors' experience requires adopting the experiential marketing approach, recognizing visitors' broad interests. Moreover, visitor segmentation can be based on identifiable preliminary variables.

*Keywords : Heritage, Heritage Tourism, Emotional experience, Auschwitz*

## REFERENCES

- Becker, E. (1997). *The denial of death*. New York, NY: Free Press.
- Collins-Kreiner, N. (2010). Researching pilgrimage: Continuity and transformations. *Annals of Tourism Research*, 37(2), 440-456.
- Poria, Y., Reichel, A., & Biran, A. (2006). Heritage site management: Motivations and expectations. *Annals of Tourism Research*, 33(1), 162-178.
- Poria, Y., Butler, R., & Airey, D. (2003). The core of heritage tourism. *Annals of Tourism Research*, 30(1), 238-254.



- Steger, M. F., Frazier, P., Oishi, S., & Kaler, M. (2006). The meaning in life questionnaire: Assessing the presence of and search for meaning in life. *Journal of Counseling Psychology, 53*(1), 80-93.
- Stone, P. (2009). Making absent death present: Consuming dark tourism in contemporary society.
- Stone, P. (2011). Dark tourism and the cadaveric carnival: Mediating life and death narratives at gunther von hagens' body worlds. *Current Issues in Tourism, 14*(7), 685-701.
- Timothy, D. J., & Boyd, S. W. (2006). Heritage tourism in the 21st century: Valued traditions and new perspectives. *Journal of Heritage Tourism, 1*(1), 1-16.
- Watson, D., Clark, L. A., & Tellegen, A. (1988). Development and validation of brief measures of positive and negative affect: The PANAS scales. *Journal of Personality and Social Psychology, 54*(6), 1063-1070.

## THE ROLE OF SELF AWARENESS AND SELF EFFICACY ON CAREER DECISION MAKING OF THE STUDENTS

Özek, Hande<sup>1</sup>; Ferraris, Alberto<sup>2</sup>

<sup>1</sup>Department of Business, Yenyuzuyl University, Istanbul

<sup>2</sup>Department of Management, University of Torino and Laboratory for International and Regional Economics, Graduate School of Economics and Management, Ural Federal University.

### ABSTRACT

### INTRODUCTION

The present study aimed at finding out the factors which are similar or different in the students' career decision making between two different culture (Italian and Turkish) and the relevance of self awareness and self efficacy on their choices. Thus, the research evaluated the Career Decision Making Self Efficacy Scale- Short Form (Betz et al. 1996; Chaney et al. 2007) and the Situational Self Awareness Scale (Govern and Marsch, 2001). Responses are collected from 291 undergraduate students of Yenyuzuyl University in İstanbul and University of Torino in Turin. The objective of this study is to reveal significant factors to develop self assessment, career awareness and goal setting competencies of the students in different cultural contexts.

Overall, we are willing to add value to the literature by pointing out that high situational self awareness and self efficacy could lead a more conscious attitude of decision making. Moreover, we also want to reveal the differences between two different cultures and among different demographical factors (such as grade, gender, ecc.) in career decision making. The research would give a more explanatory information about the factors that have an effect upon career decision making in university students.

### LITERATURE EVIDENCES & RESEARCH OBJECTIVES

There are significant number of studies about career in the literature as it is one of the main and essential subject in human life. Since the initial work of Hackett and Betz (1981), hundreds of studies have applied Bandura's (1977) theory of self-efficacy expectations to the field of career development and counselling (Betz et al., 2005). Bandura's (1977) concept of self-efficacy is "one of the most theoretically, heuristically, and practically useful concepts formulated in modern psychology" (Betz, Klein, & Taylor, 1996, p. 47; Chung, 2002). As originally proposed by Bandura (1977), self-efficacy expectations refer to a person's beliefs

concerning his or her ability to successfully perform a given task and can be useful in understanding and predicting behaviours. Overall, low self-efficacy could lead to avoidance, whereas stronger self-efficacy expectations could lead to approach behavior (Betz and Luzzo, 1996).

Career plays a central role in people's lives and it significantly impacts their economic and social status as well as emotional well being (Blustein, 2008). Providing guidance that can assist individuals navigate through the complex process of choosing a career can, therefore, help them to make better decisions (Gati et al., 2013). Today, the development of a career continues to be a priority and must be carefully addressed to effectively meet the career development needs of students (Hughey, and Hughey, 1999). So, preparing students for their future roles in the world of work has become increasingly important for educators generally. As a consequence, the need to understand better the factors that are effecting career decisions lead researchers to deepen the subject.

In our research we wanted to add a value to the literature by investigating the role of self efficacy and self awareness in career decisions of the students from different cultures. Regarding the first, Career Decision Making Self Efficacy (CDMSE) identifies the extent to which students have confidence (self-efficacy) in their ability to engage in educational and occupational planning and decision-making. The Taylor and Betz (1983) study identified five sub-scales: Self-Appraisal, Occupational Information, Goal Selection, Planning, and Problem Solving (Peterson and DelMas, 1998). Regarding the second, self-awareness is another fundamental element in shaping behaviours and implies "a deep understanding of one's emotions, as well as one's strengths and limitations and one's values and motives" (Goleman et al., 2002, p. 40). Self-awareness incorporates the self-reflection capacity and thoughtfulness that Covey (2004) declared as necessary to discover one's voice and, at the same time, incorporates the ability to understand one's true nature and the freedom to choose how one consciously wishes to respond to life (Caldwell, 2009). This study aims to prove that this ability has an effect also in the career decisions of the students.

Moreover, not only self-awareness and self-efficacy but also demographical and cultural factors can affect the decision making of the students about their careers. Many studies have found that personal factors, such as gender, ethnicity, social status, personality, identity, and self-reliance, played a role in individual differences in career decision-making self-efficacy (e.g. Fan, 2016). Individuals in different countries are likely to make their career decisions differently. While some of these differences are based on the system of higher education (such as choosing a major before applying to college rather than after one's first or

second year), other differences are more contextual, depending on the culture and its different expectations of the individual (Willner et al., 2015).

Concluding, in this research we aim at highlighting the effects of these variables on career decision making of undergraduate students in two different cultural contexts.

**Keywords:** Career decision making, Self Efficacy, Self Awareness, Self assesment.

## REFERENCES

- Bandura, A. (1977). Self-efficacy: toward a unifying theory of behavioral change. *Psychological review*, Vol.84 No.2, pp. 191-215.
- Betz, N.E., Luzzo, D. A. (1996), "Career Assessment And Career Decision-Making Self Efficacy Scale", *Journal Of Career Assessment*, Vol.4 No.4, pp. 413-428.
- Betz, N. E., Klein, K. L., & Taylor, K. M. (1996). Evaluation of a short form of the career decision-making self-efficacy scale. *Journal of Career Assessment*, Vol.4 No.1, pp. 47-57.
- Betz, E.N., Hammond, M.S., Multon, K. D. (2005), "Reliability And Validity Of Five-Level Response Continua Fort He Career Decision Self-Efficacy Scale", *Journal Of Career Assessment*, Vol.13 No.2, pp. 131-149.
- Caldwell, C. (2009), "Identity, Self-Awareness, and Self-Deception: Ethical Implications for Leaders and Organizations", *Journal Of Business Ethics*, Vol.90 pp.393-406.
- Goleman, D., Boyatzis, R. E., & McKee, A. (2002). *The new leaders: Transforming the art of leadership into the science of results*. London: Little, Brown.
- Covey, S.R. (2004) *The 8th habit: From effectiveness to greatness*. London: Simon and Schuster.
- Chaney, D., Hammond, M. S., Betz, N. E., & Multon, K. D. (2007). The reliability and factor structure of the career decision self-efficacy scale-SF with African Americans. *Journal of Career Assessment*, Vol.15 No.2, pp.194-205.
- Chung, Y.B. (2002), "Career Decision Making Self Efficacy And Career Commitment: Gender And Ethic Differences Among College Students", *Journal Of Career Development*, Vol.28 No 4, pp. 277-284.
- Fan, J. (2016), "The Role Of Thinking Styles In Career Decision-Making self-Efficacy Among University Students", *Thinking Skills and Creativity*, Vol.20, pp.63-73.
- Gati, Í.; Ryzhik, T., Vertsberger, D. (2013), "Preparing Young Veterans For Civilian Life: The Effects Of A Workshop On Career Decision-Making Difficulties And Self Efficacy", *Journal Of Vocational Behavior*, No.83, pp.737-383-
- Govern, J. M., & Marsch, L. A. (2001). Development and validation of the situational self-awareness scale. *Consciousness and cognition*, Vol.10 No.3, pp.366-378.
- Hackett, G., & Betz, N. E. (1981). A self-efficacy approach to the career development of women. *Journal of vocational behavior*, Vol.18 No.3, pp.326-339.
- Hughey, K.F, Hughey J.K.( 1999), "Preparing Students for the Future: Making Career Development a Priority", *Journal Of Career Development*, Vol.25 No.3, pp. 203-216.
- Peterson, S.L., DelMas R.C. (1998), "The Component Structure of Career Decision-Making Self-Efficacy for Underprepared College Students", *Journal Of Career Development*, Vol.24 No.3, pp. 209-225.
- Taylor, K. M., & Betz, N. E. (1983). Applications of self-efficacy theory to the understanding and treatment of career indecision. *Journal of Vocational Behavior*, Vol.22 No.1, pp.63-81.
- Blustein, D. L. (2008). The role of work in psychological health and well-being: a conceptual, historical, and public policy perspective. *American Psychologist*, Vol.63 No.4, pp.228.
- Willner, T., Gati, Í., Guan, Y. (2015), "Career Decision-Making Profiles And Career Decision-Making Difficulties: A Cross-Cultural Comparison Among US, Israeli And Chinese Samples", *Journal Of Vocational Behavior*, Vol.88, pp.143-153.

## ORGANIZATION STUDIES MEET FILM STUDIES: THE CASE OF ISTANBUL'S FILM CLUSTERS

Özlem, Öz<sup>1</sup>; Kaya, Özkaraçalar<sup>2</sup>

<sup>1</sup>Department of Management, Bogazici University, Istanbul, Turkey

<sup>2</sup>Department of Film and Television, Bahcesehir University, Istanbul, Turkey

### ABSTRACT

Organization of economic activity in space has attracted increasing attention in the management literature in recent decades, and as with the management literature in general, the literatures on organization theory and strategy are becoming richer in respect of studies related to geographic clusters (e.g. Beal and Gimeno, 2001; Öz, 2004; Porter 1998). We know, on the other hand, that the film industry as an economic activity tends to be concentrated geographically but there is limited, though a steadily growing, literature on the emergence of film clusters (e.g. Dudrah, 2006; Scott, 2005). We employ an interdisciplinary approach in this paper that merges the perspectives of organization studies and film studies to better understand the evolution patterns of Istanbul's film clusters. We tackle this challenging issue by concentrating on the production, exhibition and distribution ends of the sector. To this end, a detailed historical analysis is carried out by scrutinizing archival data, available statistical information on the sector as well as conducting in-depth interviews with the key actors of the sector.

For production, our analysis reveals that following the collapse of Yeşilçam -the historical center of İstanbul's film industry-, two new clusters, one located in the vicinity of the old center (Beyoğlu) and the other in a rising commercial district (Levent), have emerged since the mid-1990s. By zooming into the specifics of the workings of cluster path evolution (Henning et al., 2013) in this instance, we have been able to uncover the fact that forces of agglomeration gave birth to "twin paths" via a branching process (Martin and Sunley, 2006) in the case of İstanbul's film industry; one remembering and transforming the past and the other starting a new clustering in a novel destination. Exhibition, the last stage of film business in the production-distribution-exhibition chain, is by its nature - being the stage where the end product (film) finally reaches its customer (spectator)- dispersed rather than clustered while some concentrations are observed within its overall dispersion, as the main avenue of Beyoğlu had hosted a significant concentration of cinemas during the era of Yeşilçam even when cinemas had proliferated all around the city. In a similar vein, a concentration of cinemas is observed today in Levent as well when cinemas have penetrated even the distant suburbs of the city. The large-scale film studios and the technical equipment rental firms are typically located on the outskirts of the city mainly due to much lower rents compared to the ones in the city center. A more dispersed pattern

is also seen in the distribution end. "Being near the producers is not essential for us since we work with the finished product," says the Turkish representative of UIP. Other concerns such as having lower rents, spacious offices and parking slots as well as avoiding traffic jams seem to be of determining importance for the case of the distributors, making them more dispersed in the city in relative terms. This pattern confirms Martin's (2010) assertion that in many clusters, even those that have a high degree of specialization, there may be a number of activities, each with its own evolutionary path. Overall, we conclude that forces of globalization (e.g. improvements in transportation and communication technology) pulling towards a more scattered distribution of economic activity seem to have generated some dispersion for Istanbul's film sector but this could not change the fact that it all remains in Istanbul and does still show a clustered pattern, especially with regard to production.

*Keywords: organization studies, film studies, geographic clusters, film clusters, Istanbul*

## REFERENCES

- Beal, B. and Gimeno, J. (2001) "Geographic agglomeration, knowledge spillovers and competitive evolution", Academy of Management Proceedings (New York, Academy of Management), pp. 1-6.
- Dudrah, R. K. (2006) *Bollywood: Sociology Goes to the Movies*, Sage, New Delhi.
- Henning, M., Stam, E. and Wenting, R. (2013) "Path Dependence Research in Regional Economic Development: Cacophony or Knowledge Accumulation?" Papers in Evolutionary Economic Geography 12, No. 19. Utrecht: Utrecht University Urban & Regional Research Centre.
- Martin, R. and Sunley, P. (2006) "Path Dependence and Regional Economic Evolution." *Journal of Economic Geography*, No. 6, pp. 395-437.
- Öz, Ö. (2004) *Clusters and Competitive Advantage: The Turkish Experience*, Palgrave MacMillan, New York and Basingstoke, Hampshire.
- Porter, M. E. (1998) *On Competition*, Harvard Business School Publishing, Boston.
- Scott, A. J. (2005) *On Hollywood: The Place, The Industry*, Princeton University Press, Princeton and Oxford.

## EXPLORING ATTITUDES AND RESPONSIBLE BEHAVIOR TOWARDS THE PHYSICAL ENVIRONMENT AMONG ELEMENTARY SCHOOL STUDENTS IN GREECE

Melanthiou, Yioula<sup>1</sup>; Papasolomou, Ioanna<sup>1</sup>; Kountouros, Haris<sup>21</sup>

<sup>1</sup>Marketing Department, University of Nicosia, Cyprus

<sup>2</sup> Public Relations Officer, EPIO Athens, Greece

### Abstract

The paper discusses the effort for creating a 'new' consumer culture towards environmentalism through instilling environmental values and attitudes among elementary school children. The paper argues that cultural institutions such as schools can cultivate environmental attitudes and responsible behavior among students through the creation of knowledge and understanding regarding the importance of resource usage and environmental responsibility among consumers. The authors carried out an exploratory study with the aim of revealing whether the attitudes and behavior among Greek elementary school students towards resource (energy) use and recycling could be positively influenced as a result of their teachers' initiatives and guidance. The study focused on this specific age group since children represent the future custodians, planners, policy makers, of the environment and its issues. In addition, children's perceptions and attitudes can be more easily influenced and changed than those of adults. The study sought to explore whether their perceptions, attitudes and subsequently their behavior towards actions that demonstrate environmental consciousness such as careful consumption of electricity and water, recycling and the planting of trees could be positively influenced and nourished. Although the findings are preliminary they suggest that social initiatives can create a 'new' consumer culture which is more sensitive towards the protection of the physical environment.

Environmentalism is an organised movement of citizens and government agencies aimed at safeguarding and improving people's living environment (Kotler et al. 2005). It is perceived as an attempt to balance relations between humans and the various natural systems on which they depend in a way that fosters sustainability. It deals with the restoration and/or improvement of the natural environment, and may be referred to as a movement to control pollution or protect plant and animal diversity. According to Banerjee and McKeage (1994), "environmentalism" is enjoying a rebirth of interest in marketing and consumer behavior.

---

<sup>1</sup> The author writes strictly in his personal capacity and views and opinions expressed do not necessarily reflect those of the European Parliament.

The evolution of environmentalism is characterized by two phases. The first one was driven by environmental groups and consumers that were concerned by the various environmental disasters in the 1960s and 1970s, such as strip mining, forest depletion, acid rain, loss of the atmosphere's ozone layer, toxic waste and litter. Their concerns were also targeted towards the heightened health problems caused by bad air, polluted water and chemically treated food. The second phase was initiated by governments, which enforced laws and regulations during the 1970s and 1980s, controlling industrial practices that were impacting upon the natural environment. It is a fact that these legal regulation affected different industries in a dissimilar manner. For example, the car industry was required to introduce expensive emission controls in produced cars. The petroleum industry had to create new low-lead and unleaded petrol. At the same time, it is true that, typically, the industries affected most by environmental regulation were the greatest polluters. A third phase has now emerged, in which the corporate sector accepts responsibility of the environment, meaning that it pledges to act in a manner that does not endanger or harm the natural environment. Several corporations are beginning to adopt policies which encapsulate this environmental responsibility by focusing on the company's profitability whilst being mindful of their impact on the environment (and seeking to preserve the natural environment).

Be that as it may, environmentalism impacts upon people's personal values and behaviour. One could perhaps suggest that strong positive perceptions towards environmentalism can have a variety of consequence on a person's product and brand purchase choices, consumption behaviour and lifestyle in general. For instance, people with a strong positive attitude towards environmentalism can show a preference towards the purchase of green products. They can also exhibit changes in lifestyle, like walking or biking instead of driving, or repairing and reusing products instead of purchasing brand new products are also possible. Other consequences are activism (e.g. signing petitions), joining environmental organizations, and keeping abreast of current environmental developments. In general environmentalists are not hostile towards marketing and consumption, they expect however greater responsibility from people and organisations towards the physical environment. One could argue that environmentalists act as watchdogs and pressure groups guiding corporate behaviour towards greater sustainability.

In an era of growing corporate social and environmental responsibility, the role of various governmental, social and cultural institutions and actors are crucial in shaping people's values towards environmentalism. Specifically, schools and other educational institutions, a person's family, a country's legal framework, and voluntary initiatives aimed at protecting and 'restoring' the natural environment can play a critical role in creating a society with strong environmental values and,



therefore, behaviour. Instilling and nourishing a behaviour towards environmentalism at a young age can have implications for people's consumption choices and behaviour in adult years. To this end, the parents, family, the society, educational institutions, and the government have a responsibility and even obligation to create, build, nourish and sustain a new generation of environmentalists.

The overarching aim of the study was to investigate whether the students at an elementary school in northern Greece were able and willing to embrace environmental values and actively engage in activities that demonstrate environmental consciousness and responsibility such as saving energy, careful water consumption, the planting of trees in their school, and recycling in their classrooms and schools. In particular, the key objectives of the study were to identify the students' perceptions and attitudes towards the physical environment, the key reference groups and their impact on students' perceptions towards environmental responsibility, determine the key motives, which can encourage students to become more environmentally conscious in terms of energy consumption and finally a preposition towards protecting the physical environment can be cultivated at a young age.

The research was guided by case study methodology since it focused on exploring the attitudes and behavior of the students in an elementary school in Greece as well as their parents and teachers towards environmental responsibility. Data was collected from three groups of participants: elementary school students (83), teachers (30) and parents (34) in order to cross-examine their attitudes, perceptions and behavior and the influence exerted on each other towards creating attitudes that are conducive towards protecting the physical environment.

The research findings suggest that although the students' parents have never participated in actions that protect the physical environment, their students have actively participated in activities and initiatives such as planting trees and saving water, following their teachers' encouragement which suggests that environmentally responsible behavior can be learned. The study demonstrates the strong influence that social institutions such as schools and reference groups such as teachers have on shaping people's perceptions, attitudes and behavior. Reference groups such as teachers have the power to act as role models and guide their students' behavior towards environmentalism. These findings provide some preliminary evidence suggesting that governmental and social institutions should launch and manage initiatives and actions that aim at educating and motivating children and young adults to adopt more responsible behaviors towards the physical environment thus positively influencing the future generation of citizens and consumers towards greater environmental responsibility.

## **ACKNOWLEDGMENTS**

The authors would like to thank Ms Eleni Poppi for carrying out the data collection and analysis on which the abstract is based.

*Keywords: Environmentalism, environmental responsibility, responsible behavior, elementary school students, Greece.*

## **REFERENCES**

Bobby Banerjee and Kim McKeage (1994) , "How Green Is My Value: Exploring the Relationship Between Environmentalism and Materialism", in NA - Advances in Consumer Research Volume 21, eds. Chris T. Allen and Deborah Roedder John, Provo, UT : Association for Consumer Research, Pages: 147-152.

Kotler, P., Wong, V., Saunders, J. And Armstrong, G. (2005) Principles of Marketing, Pearson Education/Prentice Hall Editions: Essex.

# **THE EFFECTS OF DOWNWARD LINE EXTENSIONS ON CONSUMER BRAND ATTITUDE: THE CASE OF THE EUROPEAN PREMIUM AUTOMOTIVE MARKET**

**Pedrosa, Gabriel; Nobre, Helena**

DEGEIT, GOVCOPP, University of Aveiro, Portugal

## **ABSTRACT**

In the automotive arena, several brands and segments interact in one of the most competitive markets in the world. The dynamics of this competitive context pushes premium manufacturers to use downward brand extensions into the previously unexplored small car segments, seeking growth while using and preserving brand value. However, great care must be taken on downward line extensions to ensure success by a good acceptance of the extension and keep parent brand value (Aaker and Keller, 1990; Chun et al., 2015; Royo-Vela and Voss, 2015). The acceptance of an extension can be measured by the brand extension attitude, and one of the most relevant antecedents is the extension perceived fit (also referred to as congruity, similarity or typicality) (Allman et al., 2015; Boush and Loken, 1991; Kim et al., 2001; Kim and Yoon, 2013; Lei et al., 2008; Riley et al., 2015; Salinas and Chernatony, 2004; Volckner and Sattler, 2006). Specifically, in the automotive market, a high perceived fit is indicated by research as desirable to ensure a positive brand extension evaluation (Heath et al., 2011; Riley et al., 2013) – hypothesis 1 (H1). The ownership status also plays a role in brand extension evaluation as owners tend to be more demanding about the sustainability and exclusivity of the brand (Fu et al., 2009; Grewal et al., 2004; Kirmani et al., 1999; Lei et al., 2008; Royo-Vela and Voss, 2015). On the other hand, non-owners tend to be more positive towards a downward extension as it gives them easier access to the brand (Truong et al., 2008). Thus, it is here hypothesized (H2) that the ownership status has an effect on the brand extension attitude. Consumers displaying a status-seeking behavior may also show a negative attitude toward the brand extension due to the perception of loss of exclusivity (Heath et al., 2011; Kim et al., 2001; Lei et al., 2008; Riley et al., 2013). This question is even more relevant in highly visible and durable items, like automobiles (Grewal et al., 2004; Truong et al., 2008). As it is here hypothesized that a status-seeking attitude is a moderator of the relationship between perceived fit and brand extension evaluation.

## **RESEARCH DESIGN**

The hypothesis will be tested in an experimental research design with a 2 X 2 layout to test the effects of perceived fit (high or low) and ownership status (owner or non-owner) (e.g. Chun et al. 2015; Boush

& Loken 1991; Riley et al. 2013; Riley et al. 2015; Fu et al. 2009). A premium automobile brand will be used as a stimulus in the experience. The automobile brand will be selected within European brands without an available brand-extension in the supermini segment. The data will be collected through online questionnaires posted on European online automotive forums to further gather respondents who are typically more involved and enthusiastic with automotive brands.

## STUDY CONTRIBUTIONS

Research on line-extensions has been more limited in the literature than research on category extensions, although the topic proves to be relevant especially in cases of premium brands stepping down in high-visibility and durable items such as automobiles (Riley, Pina, & Bravo, 2015; Truong, Simmons, McColl, & Kitchen, 2008). This study aims to contribute to research and practice by (1) understanding further the consumer response to brand extensions, focusing on downward line extensions in premium automotive brands especially in the supermini segment and by (2) analyzing the role of consumer's need for status and ownership status in the attitude towards brand extensions.

## ACKNOWLEDGEMENTS

This research is supported by the FEDER funds through COMPETE 2020, from the Operational Program for Competitiveness and Internationalization (POCI), and by National Funds through FCT – Foundation for Science and Technology, within the financial support assigned to the research unity GOVCOPP (POCI-01-0145-FEDER-0085).

*Keywords: downward brand extension, automotive original equipment manufacturer, minicar segment, ownership effect, need for status, extension attitude, brand attitude, parent brand, European automotive market*

## REFERENCES

- Aaker, D. and Keller, K. (1990), "Consumer Evaluations of Brand Extensions", *Journal of Marketing*, Vol. 54 No. 1, pp. 27–41.
- Allman, H.F., Fenik, A.P., Hewett, K. and Morgan, F.N. (2015), "Brand Image Evaluations: The Interactive Role of Country of Manufacture, Brand Concept, and Vertical Line Extension Type", *Journal of International Marketing*, Vol. 24 No. 2, pp. 40–61.
- Boush, D. and Loken, B. (1991), "A Process-Tracing Study of brand extension evaluation", *Journal of Marketing Research*, Vol. 28 No. 1, pp. 16–28.
- Chun, H., Park, C.W., Eisingerich, A. and MacInnis, D. (2015), "Strategic Benefits of Low Fit Brand Extensions: When and Why?", *Journal of Consumer Psychology*, Vol. 25 No. 4, pp. 577–595.
- Fu, G., Ding, J. and Qu, R. (2009), "Ownership effects in consumers' brand extension evaluations", *Journal of Brand Management*, Vol. 16 No. 2, pp. 221–233.
- Grewal, R., Mehta, R. and Kardes, F.R. (2004), "The Timing of Repeat Purchases of Consumer Durable Goods: The Role of Functional Bases of Consumer Attitudes", *Journal of Marketing Research*, Vol. 41 No. 1, pp. 101–115.

- Heath, T.B., DelVecchio, D. and McCarthy, M.S. (2011), "The Asymmetric Effects of Extending Brands to Lower and Higher Quality", *Journal of Marketing*, Vol. 75 No. 4, pp. 3–20.
- Kim, C., Lavack, A.M. and Smith, M. (2001), "Consumer evaluation of vertical brand extensions and core brands", *Journal of Business Research*, Vol. 52 No. 3, pp. 211–222.
- Kim, J. and Yoon, H.J. (2013), "Association Ambiguity in Brand Extension", *Journal of Advertising*, Vol. 42 No. 4, pp. 358–370.
- Kirmani, A., Sood, S. and Bridges, S. (1999), "The Ownership Effect in Consumer Responses to Brand Line Stretches", *Journal of Marketing*, Vol. 63 No. 1, pp. 88–101.
- Lei, J., de Ruyter, K. and Wetzels, M. (2008), "Consumer Responses to Vertical Service Line Extensions", *Journal of Retailing*, Vol. 84 No. 3, pp. 268–280.
- Riley, F., Pina, J. and Bravo, R. (2013), "Downscale extensions: Consumer evaluation and feedback effects", *Journal of Business Research*, Vol. 66 No. 2, pp. 196–206.
- Riley, F., Pina, J. and Bravo, R. (2015), "The role of perceived value in vertical brand extensions of luxury and premium brands", *Journal of Marketing Management*, Vol. 31 No. 7-8, pp. 881–913.
- Royo-Vela, M. and Voss, E. (2015), "Downward Price-Based Brand Line Extensions Effects on Luxury Brands", *Business & Economics Research Journal*, Vol. 6, pp. 145–161.
- Salinas, E.M. and Chernatony, L. De. (2004), "The effect of brand extension strategies upon brand image", *Journal of Consumer Marketing*, Vol. 21, pp. 39–50.
- Truong, Y., Simmons, G., McColl, R. and Kitchen, P.J. (2008), "Status and Conspicuousness – Are They Related? Strategic Marketing Implications for Luxury Brands", *Journal of Strategic Marketing*, Vol. 16, pp. pp. 189–203.
- Volckner, F. and Sattler, H. (2006), "Drivers of Brand Extension Success", *Journal of Marketing*, Vol. 70, pp. 18–34.

## VALUE OF LISTED COMPANIES; ABNORMAL EARNINGS AND INNOVATIVENESS

**Philipson, Sarah**

University of Gävle, Sweden and Linnaeus University, Sweden.

### ABSTRACT

### CONSTRUCTS

#### ABNORMAL EARNINGS/MONOPOLY RENT

Goodwill has become an increasingly more important part of the valuation of companies. In a study of 528 companies on the London Stock Exchange (LSE), AbuGhazaleh, Al-Hares & Haddad (2012) found that the average share price was £5.21, while the average book value per share before goodwill was £0.79, and the average goodwill per share was £0.82 before goodwill impairment.

Goodwill has

*"...four components: (1) the write-up of the target firm's assets to fair market value (WRITEUP), calculated as the difference between the fair market value of the target firm's assets and their preacquisition book value; (2) the value of the target as a going-concern, or stand-alone, entity (GC), calculated as the difference between the target's pre-acquisition market value measured six days prior to the acquisition and the target's fair market value of assets; (3) the market's valuation of the synergistic value created by the acquisition (SYNERGY), calculated as the combined cumulative abnormal returns to the target and the acquirer for the 11 days centered on the acquisition announcement; and (4) any overvaluation of consideration and/or overpayment for the target (RESID), calculated as the purchase price less the sum of the preacquisition book value of the target's assets, WRITEUP, GC, and SYNERGY Current GAAP records as purchased goodwill on the acquirer's books only the aggregate of GC, SYNERGY, and RESID, if their total is positive." (Henning, Lewis & Shaw, 2000:375-376).*

It can be argued that points 2)-4) are the valuation of potential abnormal profits, and that the expectation of normal profits entails no market value above book value.

*"The internally generated goodwill corresponds to the overall value of not recorded intangible assets available to an enterprise. This can be measured through the capitalization of expected flows of abnormal earnings", Zaroni (2009:xi, cited after Paugam, 2011:351).*

In accounting literature this is normally measured by the neo-classical Ohlson model (Ohlson, 1995; Lundholm, 1995; Bernard, 1995; Feltham & Ohlson, 1995; Lo & Lys, 2000; AbuGhazaleh, Al-Hares, &

Haddad, 2012, among others), which calculates the value of the company as the net present value of future abnormal earnings. The Ohlson model updated the Gordon model (Gordon & Shapiro, 1956, after Lo & Lys, 2000) with the Miller & Modigliani model (Miller & Modigliani, 1961).

*"Abnormal earnings bear on the difference between market and book values, that is, they bear on a firm's goodwill."* Ohlson (1995:662)

However, the very fact that the model recognizes abnormal earnings, is a fundamental conflict within neo-classical theory, as they must abstract from its fundamental assumption of perfect markets. The Ohlson model is one of the most cited and respected models in the accounting literature, but it has one major flaw. Although the Ohlson model is an empirically well-validated *prediction* model, it fails to explain *why* these abnormal earnings exist. Classical economy gives such a fundamental explanation:

## INNOVATIVENESS

Innovation makes it possible to reach abnormal earnings, AE, during the time that the innovation has not been imitated by competitors. This temporary monopoly gives monopoly rent (Malthus, 1798/1970; Ricardo, 1817/1971; Marx, 1894/1981; Schumpeter, 1907; 1942; von Hippel, 1988).

*"Schumpeter argued that those who succeed at innovating are rewarded by having temporary monopoly control over what they have created. This control, in turn, is the lever that allows innovators to gain an enhanced position in the market and related temporary profits or "economic rents" from their innovations."* (von Hippel, 1988:43)

*"Innovators capture temporary rents from their successful innovations by first establishing some type of monopoly control over their innovation and then using this control to increase their economic return."* (von Hippel, 1988:58).

Monopoly rent is what in accounting literature is called abnormal earnings.

The Ohlson model assumes that normal earnings are capitalized in the equity of the firm. However the theory of monopoly rent shows that there are no such things as normal earnings in a market, where a firm can reap abnormal earnings. The monopoly rent situation arrives by the *re-distribution* of profit in the market place, so that other actors get no or subnormal earnings. The following image shows how in 2007 Nokia held the lions share (60%) of the profits in mobile phone market and in 2011 Apple has taken over the position (with 75% of the profits), with Nokia's profit reduced to zero. Three years later Nokia was no longer in the market..

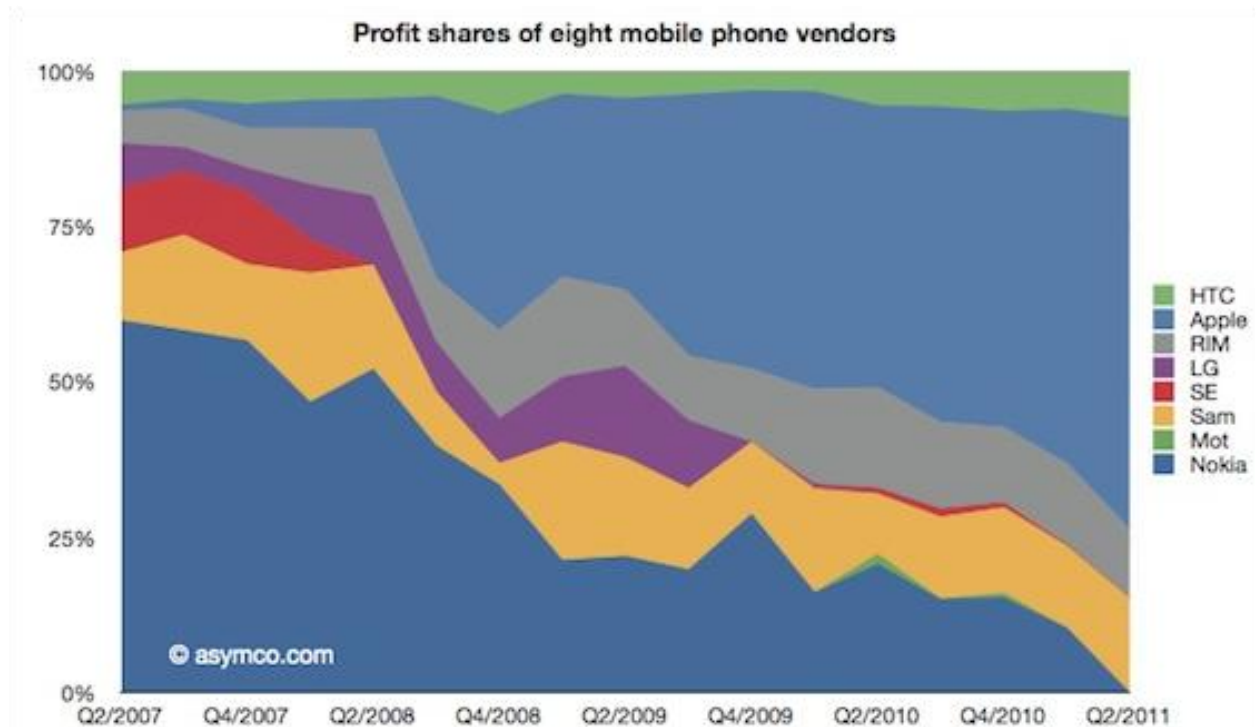

Figure 1. Profits in the mobile telephone terminal market, Asymco (2013-06-28).

This is one of the market dynamics that lead Marx (1894/1981) to suggest that the concentration of capital is an inherent tendency in capitalism. Glattfelder (2010) has given a modern validation of this, showing that 50 companies control 40% of global business. Fichtner, Heemskerk & Bernardo (2017) showed that three US companies control 40% of the US capital.

## CONSTRUCTS AND MEASUREMENTS

### *Market Value*

The value of the company is the average share price the 31 December each year, multiplied by the number of outstanding shares.

*"The increasing gap between firms' market and book value has drawn wide research attention to exploring the invisible value omitted from financial statements (e.g. Lev and Zarowin, 1999; Lev, 2001; Lev and Radhakrishnan, 2003). Lev (2001, p. 9) documented that, over the period of 1977-2001, the market-to-book value ratios of US Standard and Poors (S&P) 500 corporations increased from slightly above 1 to over 5, implying that about 80 per cent of corporate market value has not been reflected in financial reporting.."* (Chen, Cheng & Hwang, 2005:159)



### *Innovativeness*

Innovation includes products innovation, service innovation, experience innovation, marketing innovation, organizational innovations, and business model innovation. Innovativeness is a complex construct that has been 'measured' both by objective and subjective scales.

Innovativeness as a construct has been extensively studied (Midgley & Dowling, 1978; Olson, Walker Jr & Ruekert, 1995; Hurley & Hult, 1998; Mairesse & Mohnen, 2002; Hult, Hurley & Knight, 2004; Tuominen, Rajala & Möller, 2004; Salavou, 2004; Hurley, Hult & Knight, 2005; Laforet & Tann, 2006; Santos-Vijande & Álvarez-González, 2007). Hult et al. (2004:430) hold that "Innovativeness is defined here as the capacity to introduce of some new process, product, or idea in the organization..."

The 'ideal' construct for innovativeness are the risk taking in *the share of fixed production costs of total costs* (Marx, 1867/1970, 1894/1981). These are the costs that the firm has to take before it can sell any item of the product or service. When Apple designed the iPhone it had to take all the design costs on an 'architectural' level and for strategic components, like the development of the glass together with Corning, the development of the operative system and some key applications that would run on that system. (Isacsson, 2011). A large part of the marketing costs were also taken upfront, as the lifecycle of each product is so short. but to measure these its only possible with access to internal accounting data.

Typical measures of innovativeness are diverse; patents (Acs. & Audretsch, 1989; Acs, Anselin & Varga, 2002), Intellectual capital (Bontis, 1998; Bollen, Vergauwen & Schnieders, 2005), consumer innovativeness (Goldsmith & Hofacker, 1991), and innovation performance (Tangen, 2004).

*"R&D expenditure and advertising expenses, according to conservative accounting standards, are expensed as incurred, and thus are subtracted from the calculation of value added, which is the measure for firms' total output in the VAIC calculation. However, both R&D and advertising expenditures play an increasingly important role in business nowadays. R&D expenditure is generally considered the drive for technological advancements and firms' growth, and advertising expenditure is usually aimed at promoting the brand value of products and firms. Therefore, both expenditures, though expensed in financial reporting, should be viewed as asset-like investments." (Chen, Cheng & Hwang, 2005:162)*

Research of innovativeness has measured innovativeness by necessary antecedents, as research and development or patents and other intellectual property rights.

*"Research has approached innovation performance measurement from two perspectives: the measurement of R&D (Alegre et al., 2006; Chiesa and Frattini, 2009; Chiesa et al., 2009; Lazzarotti et al., 2011; Cruz-Cázares et al., 2013) and the measurement of technological innovation capability (cf. Capaldo et al., 2003). In addition, conceptual models have discussed the essential elements of innovation that should be measured (cf. Muller et al., 2005; Adams et al., 2006; Saunila and Ukko, 2012)." (Saunila, 2017).*

Measures like patents and R&D expenditure are problematic, as patents does not guarantee an ability to exploit these, as was the case with Xerox' shown inability or even interest to exploit them (Gassmann, Enkel & Chesbrough, 2010:214), as with today's frequent patent trolls (Magliocca, 2007). Hall, Jaffe & Trajtenberg (2005:33) show that

*"...the presumed link between self-citations and market value may weaken with the size of the patent portfolio."*

Hult et al. (2004) recognizes these limits with R&D costs and intellectual property rights as a measure of innovativeness and operationalizes instead innovativeness as a self-evaluation of three variables, *Market orientation* (referring to Narver & Slater, 1990; Day, 1994), *Learning orientation* (referring to Argyris & Schon, 1978; Fiol, 1985; Cohen & Sproull, 1996; Crossan; Lane, & White, 1999), and *Entrepreneurial orientation* (referring to Slater & Narver, 1993, 1995; Lumpkin & Dess, 1996). These variables influence on innovativeness is hypothesized to be modified by market turbulence (referring to Han et al., 1998; Hurley et al., 1998; Miller, 1983; Miller & Friesen, 1978; Zaltman et al., 1973), reflecting

*"...rapidly changing buyer preferences, wide-ranging needs and wants, ongoing buyer entry and exit from the marketplace, and constant emphasis on offering new products."* (Hult et al., 2004:432).

Even though Hult et al. (2004) recognize the modifying influence of turbulent markets, the destructive innovations of Schumpeter are difficult to identify:

*"...it can always be understood ex post; but it can practically never be understood ex ante..."*, Schumpeter (1947:150).

It is therefore highly unlikely that radical innovation is anticipated by the present market leaders. If the Nokia personnel had been interviewed a few years running up to Apple's introduction of the iPhone in mid-2007, they had hardly anticipated the change.

As Leonard-Barton (1992) states the *"...at the same time that they [the core capabilities] enable innovation, they hinder it. Therefore in their interaction with the development process, they cannot be managed as a single good (or bad) entity. They are not easy to change because they include a pervasive dimension of values, and as Weick (1979: 151) points out, 'managers unwittingly collude' to avoid actions that challenge accepted modes of behavior."*

## METHOD

In this research we will measure innovativeness with with the variables suggested by Hult et al. (2004), but with expert respondents instead self-evaluation. These experts will be identified by a systematic sample, based on Urban & von Hippel (1998).

## HYPOTHESES

The study will test the hypotheses that innovativeness drives the difference between market value and book value, where Innovativeness is a proxy of the competence to continuously being able to gain temporary monopoly rent and hence acquire abnormal earnings.

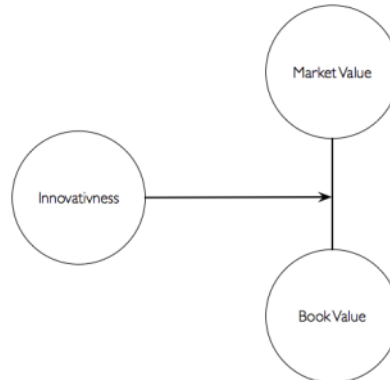

Figure 2. Model, own.

The study is intended to be a longitudinal study for ten years of X listed companies. Control values will be size, industry

## ANALYSIS METHOD

The intention is to use a dynamic linear model (LISTREL).

*Keywords: Innovativeness; monopoly rent, abnormal earnings.*

## REFERENCE

- AbuGhazaleh, N.M., Al-Hares, O.M. & Haddad, A.E. (2012). The Value Relevance of goodwill impairments: UK Evidence. *International Journal of Economics and Finance*, 4(4), 206-216.
- Acs, Z.J. & Audretsch, D.B. (1989). Patents as a Measure of Innovative Activity. *Kyklos*, 42(2), 171-180.
- Acs, Z.J., Anselin, L. & Varga, A. (2002). Patents and innovation counts as measures of regional production of new knowledge. *Research Policy*, 31(7), 1069-1085.
- Asymco (2013-06-28), fetched from: [www.asymco.com](http://www.asymco.com), used with permission.
- Bernard, V.L. (1995). The Feltham-Ohlson Framework: Implications for Empiricists. *Contemporary Accounting Research*, 11(2), 733-747.
- Bollen, L., Vergauwen, P. & Schnieders, S. (2005). Linking intellectual capital and intellectual property to company performance. *Management Decision*, 43(9), 1161-1185.
- Bontis, N. (1998). Intellectual capital: an exploratory study that develops measures and models. *Management Decision*, 36(2), 63-76.
- Chen, M.-C., Cheng, S.-L. & Hwang, Y. (2005) An empirical investigation of the relationship between intellectual capital and firms' market value and financial performance, *Journal of Intellectual Capital*, 6(2), 159-176, doi: 10.1108/14691930510592771
- Feltham, G.A. & Ohlson, J.A. (1995). Valuation and Clean Surplus Accounting for Operating and Financial Activities. *Contemporary Accounting Research*, 11(2), 689-731.

- Fichtner, J., Heemskerk, E.M. & Garcia-Bernardo, J. (2017) Hidden power of the Big Three? Passive index funds, re-concentration of corporate ownership, and new financial risk, *Business and Politics*, 19(2): 298-326.
- Gassmann, O., Enkel, E. & Chesbrough, H. (2010) The future of open innovation, *R&D Management* 40(3), 213-221.
- Glattfelder, J.B. (2010). *Ownership Networks and Corporate Control: Mapping Economic Power in a Globalized World*. Zürich: ETH Zürich.
- Goldsmith, R.E. & Hofacker, C.F. (1991). Measuring Consumer Innovativeness. *Journal of the Academy of Marketing Science*, 19(3), 209-221.
- Hall, B.H., Jaffe, A. & Trajtenberg, M. (2005) Market Value and Patent Citations, *The RAND Journal of Economics*, 36(1), 16-38
- Henning, S.L., Lewis, B.L. & Shaw, W.H. (2000) Valuation of the Components of Purchased Goodwill, *Journal of Accounting Research*, 38(2), 375-386.
- Hurley, R.F. & Hult, G.T.M. (1998). Innovation, Market Orientation, and Organizational Learning: An integration and Empirical Examination. *Journal of Marketing*, 62(3), 42-54.
- Hurley, R. F., Hult, G. T. M. & Knight, G. A. (2005). Innovativeness and capacity to innovate in a complexity of firm-level relationships: A response to Woodside (2004). *Industrial Marketing Management*, 34(3), 281-283. <http://doi.org/10.1016/j.indmarman.2004.07.006>
- Hult, G.T.M., Hurley, R.F. & Knight, G.A. (2004). Innovativeness: Its antecedents and impact on business performance. *Industrial Marketing Management*, 33(5), 429-438.
- Isacsson, W. (2011), *Steve Jobs, Digital eBook: Hachette*.
- Laforet, S. & Tann, J. (2006). Innovative characteristics of small manufacturing firms. *Journal of Small Business and Enterprise Development*, 13(3), 363-380.
- Leonard-Barton, D. (1992). Core Capabilities and Core Rigidities: A paradox in Managing New Product Development. *Strategic Management Journal*, 13(2), 111-125.
- Lo, K. & Lys, T. (2000). The Ohlson Model: Contribution to Valuation Theory, Limitations, and Empirical Applications. *Journal of Accounting, Auditing & Finance*, 15(3), 337-367.
- Lundholm, R.J. (1995) A Tutorial on the Ohlson and Feltham/Ohlson Models: Answers to Some Frequently Asked Questions, *Contemporary Accounting Research*, 11(2), 749-761.
- Magliocca, G.N. (2007) Blackberries and barnyards: patent trolls and the perils of innovation, *Notre Dame Law Review*, 82(5), 1809-1838.
- Mairesse, J. & Mohnen, P. (2002). Accounting for Innovation and Measuring Innovativeness: An Illustrative Framework and an Application. *The American Economic Review*, 92(2), 226-230.
- Malthus, T.R. (1798/1970), *An inquiry into the nature and progress of Rent – and the principles by which it is regulated*, Penguin, Harmondsworth.
- Marx K. (1867/1970) *Capital, Volume I*, New York: International Publisher.
- Marx, K. (1894/1981) *Capital, Volume III*, International Publisher, New York.
- Midgley, D.F. & Dowling, G.R. (1978). Innovativeness: The Concept and Its Measurement. *Journal of Consumer Research*, 4(4), 1-15.
- Miller, M.H. & Modigliani, F. (1961). Dividend Policy, Growth, and the Valuation of Shares. *The Journal of Business*, 34(4), 411-433.
- Ohlson, J.A. (1995). Earnings, Book Values, and Dividends in Equity Valuation. *Contemporary Accounting Research*, 11(2), 661-687.
- Olson, E.M., Walker Jr, O.C. & Ruekert, R.W. (1995). Organizing for Effective New Product Development: The Moderating Role of Product innovativeness. *Journal of Marketing*, 59(1.), 48-62.
- Paugam, L. (2011) Book Review. Accounting for Goodwill. *The International Journal of Accounting*, 46(3), 351-354.
- Ricardo D. (1817/1971). *Principles of Political Taxation and Economy*, Harmondsworth: Penguin.
- Salavou, H. (2004). The concept of innovativeness: should we need to focus? *Organization Science*, 7(1), 33-44.
- Saunila, M. (2017) Managing continuous innovation through performance measurement, *Competitiveness Review: An International Business Journal*, 27(2), [electronic pre-release] <http://dx.doi.org/10.1108/CR-03-2015-0014>
- Santos-Vijande, M.L. & Álvarez-González, L.I. (2007). Innovativeness and organizational innovation in total quality oriented firms: The moderating role of market turbulence. *Technovation*, 27(9), pp. 514-532.
- Schumpeter, J.A (1907) *Das Rentenprinzip in der Verteilungslehre*, Schmollers Jahrbuch für Gesetzgebung, Verwaltung und Volkswirtschaft im Deutschen Reich, 31, 31-65, 591-634.
- Schumpeter, J.A. (1942/1970), *Capitalism, Socialism and Democracy*, London: Unwin.

- Schumpeter, J. A. (1947). The Creative Response in Economic History. *The Journal of Economic History*, 7(2), 149-159.
- Tangen, S. (2004). Performance measurement: from philosophy to practice. *International Journal of Productivity and Performance Management*, 53(8), 726-737.
- Tuominen, M., Rajala, A. & Möller, K. (2004). How does adaptability drive firm innovativeness? *Journal of Business Research*, 57(5), 495-506.
- Urban, G.L. & von Hippel, E. (1998). Lead User Analysis for the Development of New Industrial Products. *Management Science*, 34(5), 569-582.
- von Hippel, E. (1988), *The sources of innovation*, New York: Oxford University Press, Inc..

## THE DETECTION OF FALSE FINANCIAL STATEMENTS USING ACCOUNTING RATIOS: AN EMPIRICAL INVESTIGATION

Pisciotta, Raffaella; Dicuonzo, Grazia

University of Bari Aldo Moro, Department of Economics, Management and Business Law, Bari, Italy

### ABSTRACT

The issue of corporate frauds has been brought into the limelight, after the most important financial scandals that began to appear from late 2000.

Frauds threaten the integrity of the company's assets and generate negative consequences for all stakeholders who are interested in corporate organization. These phenomena increase the interest to develop a method to identify and avoid corporate failures. However, it is not easy to predict this kind of scandals due to several variables that affect frauds.

Previous literature tested different analytical procedures (e.g. analysis of trends and ratios) to identify signals of fraud. Examining a sample of US firms, some researchers find that financial ratios show a limited ability to detect and predict fraudulent financial reporting (Kaminski et al., 2004). However, there is a paucity of evidence in the European context.

The goal of this paper is to understand whether accounting ratios are able to detect an accounting fraud. Specifically, we aim to investigate whether accounting ratios of fraudulent firms differ from those of non-fraudulent firms. To this end, we select a sample of companies listed in the European stock exchange and we classified them in two categories: fraudulent firms and non-fraudulent firms.

We consider "fraudulent firms" those that engage in ascertained behaviours aimed to manipulate financial statements, while "non fraudulent firms" are the others. The sample selection of "non fraudulent firms" is based on firm size, time period and industry of "fraudulent firms".

The exploratory study will be conducted for a eight-year period, between 2000 and 2008.

*Keywords: Financial statement, Corporate fraud, Europe, Financial ratios, Accounting, Management performance*

### REFERENCES

- Altman, E. (1968), "Financial ratios, discriminant analysis, and the prediction of corporate bankruptcy", *Journal of Finance*, September, pp. 589-609.
- Bahram, S. (2013), "The Anatomy of Corporate Fraud: A Comparative Analysis of High Profile American and European Corporate Scandals", *Journal of Business Ethics*, March 2014, Vol. 120, No. 2, pp. 251-274.
- Bian, Y., Cheng, M., Yang, C., Yuan, Y. and Qing, L. (2016), "Financial fraud detection: A new ensemble learning approach for imbalanced data", AIS Electronic Library.

Courtis, J.K. (1978), "Modelling a financial ratios categoric framework", *Journal of Business Finance & Accounting*, Vol. 5, No. 4, pp. 371-386.

Kanapickiene, R. and Grundiene, Z. (2015), "The Model of Fraud Detection in Financial Statements by Means of Financial Ratios", *Procedia - Social and Behavioral Sciences*, pp. 321-327.

Lee, T.A., Ingram, R.W. and Howard, T.P. (1999), "The difference between Earnings and Operating Cash Flow as an indicator of Financial Reporting Fraud", *Contemporary Accounting Research*, Vol. 16 No. 4, pp. 749-786.

Maria, E. and Gudono (2017), "Empirical test of fraud triangle theory on local government (evidence from Indonesia)", *International Journal of Applied Business and Economic Research*, Vol. 15, No. 4, pp. 233-248.

May Liou, F. and Hui Yang, C. (2008), "Predicting business failure under the existence of fraudulent financial reporting", *International Journal of Accounting & Information Management* Vol. 16, No. 1, pp. 74-86.

Kaminski, K.A., Wetzels, T. and Guan, L., (2004), "Can financial ratios detect fraudulent financial reporting?", *Managerial Auditing Journal*, Vol. 19, No. 1, pp.15-28.

Meenatkshi, R. and Sivaranjani (2016), "Fraud detection in financial statement using data mining technique and performance analysis", *International Journal of Control Theory and Applications*, Vol. 9, No. 27, pp. 407-413.

Perols, J., Bowen, R. and Zimmermann, C., (2017), "Finding Needles in a Haystack: Using Data Analytics to Improve Fraud Prediction", *American Accounting Association*, Vol. 92, No. 2, pp. 221-245.

Repousis, S. (2016), "Using Beneish model to detect corporate financial statement fraud in Greece", *Journal of Financial Crime*, Vol. 23, No. 4, pp.1063-107.

Somayyeh, H.N., (2015), "Financial ratios between fraudulent and non-fraudulent firms: evidence from Tehran Stock Exchange", *Journal of Accounting and Taxation*, Vol.7, pp. 38-44.

Spathis, C. (2002), "Detecting false financial statements using published data: some evidence from Greece", *Managerial Auditing Journal*, April, pp. 179-191.

## THE TREND OF HEALTH CARE TOURISM: LITERATURE REVIEW

Pjero (Beqiraj), Elenica<sup>1</sup>; Kamberi, Fatjona<sup>2</sup>; Mechili, Enkeleint Aggelos<sup>3</sup>

<sup>1</sup>Department of Business Administration, Faculty of Economics, *University "Ismael Qemali", Vlore, Albania*

<sup>2</sup>Research Center for Public Health, Faculty of Public Health, *University "Ismael Qemali", Vlore Albania*

<sup>3</sup>Department of Health Care, Faculty of Public Health, *University "Ismael Qemali", Vlore Albania*

### ABSTRACT

### BACKGROUND

*Health Tourism (HT)* is a term used to describe the practice of travelling across international borders to obtain health care. *HT* one of the fastest growing segments in marketing, is becoming a worldwide multibillion-dollar industry today (Kai Ruggeri et al., 2015). According to World Health Organization (WHO), *HT* is a growing trend with enormous economic implications (Edward Kelley, 2013). Many countries are developing comprehensive plans to use this opportunity to improve their economy as well as the quality of medical care (Matthias Helble, 2011). Many capital-poor Third World nations in need of a profitable industry look to tourism as a solution to their economic problems. There are numerous (and often confusing) measures of the economic impact of tourism. The most important measures include tourism's impact on employment rates, GDP, and tourism's contribution to the balance of payments (i.e., repayment of foreign debts) (Harrison D, 1992). To attract more and more medical tourist from different countries the centre as well as the state government should take appropriate steps to improve all types of infrastructure facilities such as access roads, electricity, water supply, sewerage and telecommunications together with airlines, surface transport, safety, security, and accommodation. Apart from the above the government should also undertake capacity building programs to train paramedical and nonmedical staff of the service providers for cross-cultural sensitivities. The government should take steps in the role of a regulator and also as a facilitator of private investment in health care sector (Aparna Sharma et al., 2015).

### OBJECTIVES

The primary objective was the review of published articles in relation to the trend of *HT* and identification of the main health problems associated with *HT*. Secondary objectives were to determine the benefits and the consequences of *HT* in health economy.

### SEARCH METHODS



We searched the PubMed database for studies related to HT during the last 10 years. Research was independent of the three researchers. Key words were health tourism, medical tourism, trend, health economy, health problems related to HT, developing countries, health tourism marketing, as well as combination of them.

### **SELECTION CRITERIA.**

The inclusion criteria were all published full articles or abstracts in English on the theme of *HT*. Review designs were not eligible for inclusion.

### **DATA COLLECTION AND ANALYSIS**

Authors independently created a list of studies found and later sort them based on the inclusion criteria, extracted data and checked them for accuracy. The categorization of studies found, was based on the authors, the year of publication, and the place where the study was conducted, the health problem associated with HT and the impact on the health economy.

### **MAIN RESULTS**

More than 30 potential articles were identified, but we reviewed the results of thirteen articles related to the theme of interest. The review evidenced that the main health problems related to *HT* were reproductive tourism (4 articles); cosmetic surgery (3 articles); hip and knee replacements; spinal surgery, and ophthalmologic procedures (2 articles); dental tourism, renal transplantation; cardiothoracic surgery, general check-ups and medical consultations respectively with 1 article, (Table 1). The main drivers of the growth of inbound *HT* to developing countries were lower costs, shorter waiting periods, and better quality of care. Most studies indicate the benefits of medical tourism in developing countries and more developed countries reflect the consequences of *HT*.

### **CONCLUSIONS**

The trend of HT, especially towards developing countries, is high. Implications for the practice in Albania, to carry out an evaluation study of how present is *HT* in the health economy and its impact on health and medical tourism marketing.

Table 1. A presentation of data analyses

The first author and the publishing year (health problem)	Objectives & Methods	Main results & conclusions
1. Yildiz, M. S., & Khan, M. M. (2016) [reproductive tourism]	Comparison of cost, quality and effectiveness of in-vitro fertilization (IVF) in the USA and in Turkey. The data from Turkey were obtained from a hospital specializing in IVF services and the US data came from secondary sources.	Indicators of quality, cost and success rate in the Turkish hospital were found to be better than the corresponding indicators in US hospitals. It appears that cost and quality are the two most important factors affecting demand for health care services by international patients in Turkey.
2. Ombelet, W. (2011) [reproductive tourism]	The study discuss the global access to infertility care in developing countries, the differences between the developed and developing world, the access of diagnostic procedures and new reproductive technologies (ART) and different socio-cultural value surrounding procreation.	The great majority of infertile couples are residents of developing countries. Keystones in the successful implementation of infertility care in low-resource settings include simplification of ART procedures in order to establish accessible good quality infertility services at low cost.
3. Bassan, S., & Michaelsen, M. A. (2013) [reproductive tourism]	The study analysis how the public media discern different uses of the term "reproductive tourism in Israel and Germany and why patients choose HT.	Patients choose medical (and, as part of it reproductive) treatments abroad for different reasons: to avoid rationing, such as waiting periods in their countries of origin; to benefit from the low costs or higher quality of services overseas; to secure their privacy or to have access to services not provided in their home country.
4. Deonandan, R. (2015) [reproductive tourism]	Analysis of recent trends in reproductive tourism and international surrogacy with focus in ethical considerations and challenges for policy, with the discussion of examples and case studies.	The international surrogacy, is one of the fastest-growing categories of cross-border reproductive care, is the act of infertile clients traveling internationally to engage the paid services of foreign surrogates to carry their babies to term. It is a multibillion-dollar global industry presenting unique legal, ethical, and risk-management challenges. Clients tend to be price-sensitive, middle-income individuals seeking services from surrogates who in the global market are thought to be of quite low socioeconomic status.
5. Franzblau, L. E., & Chung, K. C. (2013) [cosmetic surgery]	The examination of trends in the globalization of the cosmetic surgery market, to better understand the current situation and what plastic surgeons in the USA can expect. The article, explores both domestic and foreign factors that affect surgical tourism and the current state of this industry.	All research suggests that medical tourism is a growing industry. Economic forces, including supply, demand, and competition for market share, are affecting the global plastic surgery industry.
6. Hanefeld, J.et al., (2013) [cosmetic surgery]	This paper reports findings from a study examining effect of inbound and outbound HT on the UK National Health System, by estimating volume of medical tourism and associated costs and benefits.	Findings demonstrate that contrary to some popular media reports, far from being a net importer of patients, the UK is now a clear net exporter of medical travellers. Three types of treatments for which patients commonly travel abroad are fertility treatment, cosmetic and bariatric surgery.

Table 1. A presentation of data analyses (continued)

The first author and the publishing year (health problem)	Objectives & Methods	Main results & conclusions
7. Klein HJ. et al., (2017) [cosmetic surgery]	The study investigates the complications of cosmetic surgery tourism treated as well as to analyze arising costs for the health system. Between 2010 and 2014, retrospectively the study included all patients presenting with complications arising from cosmetic surgery abroad.	All patients were female with a mean age of $38.5 \pm 11.3$ years. Most procedures were performed in South America, Southeast or central Europe. Despite warnings regarding associated risks, cosmetic surgery tourism has become increasingly popular
8. Crooks, V. A et al.,(2012) [hip and knee replacements]	Fourteen Canadian medical tourists participated in semi-structured phone interviews, all of whom had gone abroad for hip or knee surgery to treat osteoarthritis.	Three distinctive attitudinal characteristics among participants were identified: comfortable health-related decision-makers; unwavering in their views about procedure necessity and urgency; and firm in their desires to maintain active lives.
9. Turner, L. (2007) [hip and knee replacements; ophthalmologic procedures]	An article about medical tourism in Canada which analysis the delays for medical interventions and the international health-related travel.	Travel for treatment outside Canada might remain a minor, idiosyncratic option for Canadian patients. Many patients will not want to leave their family members and other loved ones to receive a hip replacement in India, for example. Some patients will prefer the frustration of waiting for treatment over whatever risk they associate with traveling abroad for care.
10. Al-Lamki, L. (2011). [orthopaedic conditions]	The study presents the results on a survey studying the medical tourism patterns of patients going abroad from the Al-Dakhilya Region of Oman.	10% of the respondents went for treatment plus tourism, and 2.5% were healthy. Most of the patients went to Thailand, and orthopaedic conditions were the most common indication for these patients to seek treatment abroad. There are several reasons, related to above, why patients choose to become medical tourists. For the Americans and Europeans the attraction is value, i.e. affordability.
11. Akoh, J. A. (2012) [dental tourism, renal transplantation]	The study determines the state and outcome of renal transplantation associated with transplant tourism (TT) and the key challenges with such transplantation.	The growing demand for transplantation, the perceived failure of altruistic donation in providing enough organs has led to calls for a legalised market in organ procurement or regulated trial in incentives for donation. Developing transplant services worldwide has many benefits - improving results of transplantation as they would be performed legally, increasing the donor pool and making TT unnecessary.
12. Jacobs, J. et al., (2013) [cardiothoracic surgery]	The study investigates the role of surgical tourism. The most common cardiac surgery services include coronary artery bypass, cardiac valve replacement or reconstruction, percutaneous coronary angioplasty and stenting etc.	Several problems are associated with medical tourism. The most serious is the difficulty of evaluating the quality of care. Having access to detailed information about the quality of cardiac surgery programs internationally would increase the safety for patients who need cardiac care but cannot afford US prices.

13. Noree, T et al., (2016) [ general check-ups and medical consultations] To investigate the magnitude and characteristics of medical tourism in Thailand and the impact of such tourism on the Thai health system and economy with the check in 2010, the records of all visits to five private hospitals that are estimated to cover 63% of all foreign patient. Of the medical tourists who attended the study hospitals, 64.8% came from the eastern Mediterranean region or Asia and 34% of them were treated for simple and uncomplicated conditions - i.e. general check-ups and medical consultations.

*Keywords : health care tourism, trend, health economy, medical tourism marketing*

## REFERENCES

- Kai Ruggeri et al. (2015), "Policy & practice", *Global medical travel Bull World Health Organ*, 93:785–789 | doi: <http://dx.doi.org/10.2471/BLT.14.146027>
- Kelley, E. (2013), "Medical Tourism", WHO Patient Safety Programme.
- Helble, Matthias. (2011). The movement of patients across borders: challenges and opportunities for public health. *Bulletin of the World Health Organization*, 89(1), 68-72. <https://dx.doi.org/10.2471/BLT.10.076612>
- Harrison D, ed. *Tourism and the less developed countries*. New York: Halstead Press, 1992.
- Aparna Sharma et al., (2015). *IOSR Journal Of Humanities And Social Science (IOSR-JHSS) Volume 20, Issue 3, Ver. IV (Mar. 2015), PP 89-92 e-ISSN: 2279-0837, p-ISSN: 2279-0845*.
- Yildiz, M. S., & Khan, M. M. (2016), "Opportunities for reproductive tourism: cost and quality advantages of Turkey in the provision of in-vitro Fertilization (IVF) services", *BMC Health Services Research*, 16, 378. <http://doi.org/10.1186/s12913-016-1628-7>.
- Ombelet, W. (2011), "Global access to infertility care in developing countries: a case of human rights, equity and social justice", *Facts, Views & Vision in ObGyn*, 3(4), 257–266.
- Bassan, S., & Michaelsen, M. A. (2013). "Honeymoon, medical treatment or big business? An analysis of the meanings of the term "reproductive tourism" in German and Israeli public media discourses", *Philosophy, Ethics, and Humanities in Medicine : PEHM*, 8, 9. <http://doi.org/10.1186/1747-5341-8-9>.
- Deonandan, R. (2015), "Recent trends in reproductive tourism and international surrogacy: ethical considerations and challenges for policy", *Risk Management and Healthcare Policy*, 8, 111–119. <http://doi.org/10.2147/RMHP.S63862>
- Franzblau, L. E., & Chung, K. C. (2013), "Impact of Medical Tourism on Cosmetic Surgery in the United States", *Plastic and Reconstructive Surgery Global Open*, 1(7), e63. <http://doi.org/10.1097/GOX.0000000000000003>
- Hanefeld, J., Horsfall, D., Lunt, N., & Smith, R. (2013), "Medical Tourism: A Cost or Benefit to the NHS?", *PLoS ONE*, 8(10), e70406. <http://doi.org/10.1371/journal.pone.0070406>
- Klein HJ, Simic D, Fuchs N, Schweizer R, Mehra T, Giovanoli P, Plock JA. (2017). Complications After Cosmetic Surgery Tourism. *Aesthet Surg J*. 2017 Apr 1;37(4):474-482. doi: 10.1093/asj/sjw198. PubMed PMID: 28364525.
- Crooks, V. A., Cameron, K., Chouinard, V., Johnston, R., Snyder, J., & Casey, V. (2012), "Use of medical tourism for hip and knee surgery in osteoarthritis: a qualitative examination of distinctive attitudinal characteristics among Canadian patients", *BMC Health Services Research*, 12, 417. <http://doi.org/10.1186/1472-6963-12-417>
- Turner, L. (2007), "Medical tourism: Family medicine and international health-related travel", *Canadian Family Physician*, 53(10), 1639–1641.
- Al-Lamki, L. (2011). *Medical Tourism: Beneficence or maleficence?* Sultan Qaboos University Medical Journal, 11(4), 444–447.
- Akoh, J. A. (2012), "Key issues in transplant tourism", *World Journal of Transplantation*, 2(1), 9–18. <http://doi.org/10.5500/wjt.v2.i1.9>
- Jacobs, J. P., Horowitz, M. D., Mavroudis, C., Siegel, A., & Sade, R. M. (2013), "Surgical Tourism: the Role of Cardiothoracic Surgery Societies in Evaluating International Surgery Centers", *The Annals of Thoracic Surgery*, 96(1), 10.1016/j.athoracsur.2013.02.058. <http://doi.org/10.1016/j.athoracsur.2013.02.058>
- Noree, T., Hanefeld, J., & Smith, R. (2016), "Medical tourism in Thailand: a cross-sectional study", *Bulletin of the World Health Organization*, 94(1), 30–36. <http://doi.org/10.2471/BLT.14.152165>

## ONLINE BUYING INTENTIONS OF WINE CONSUMERS: THE ROLE OF KNOWLEDGE AND SOCIAL MEDIA

Pucci, Tommaso<sup>1</sup>; Casprini, Elena<sup>2</sup>; Nosi, Costanza<sup>3</sup>; Zanni, Lorenzo<sup>1</sup>

<sup>1</sup>Dipartimento di Studi Aziendali e Giuridici, Università degli Studi di Siena, Siena, Italy

<sup>2</sup>Institute of Management, Scuola Superiore Sant'Anna, Pisa, Italy

<sup>3</sup>Dipartimento di Scienze Umane (Comunicazione, Formazione, Psicologia), Università di Roma Lumsa, Rome, Italy

### ABSTRACT

### INTRODUCTION AND CONCEPTUAL FRAMEWORK

The influence of *social media* in buying behaviour is attracting increasing interest from marketing scholars (Berthon et al., 2012; Hajli, 2014; Heinonen, 2008; Krishnamurthy e Dou, 2008). This influence is particularly important for complex products, such as wine. For these products, whose quality cannot be assessed before consumption, social media may represent an important external clue in driving consumers buying behaviour (Laverie et al., 2011; Szolnoki et al., 2014; Wilson and Quinton, 2012).

Extant research notes that social media may affect the several phases of the buying process, such as need recognition, information research, evaluation, buying and post-buying phases (Gatautis & Kazakevičiūtė, 2012), but scant attention has been deserved to the *online* buying intention. On the contrary, being able to depict if and to what extent social media may influence consumers *online* buying intention is crucial in developing new marketing strategies.

The aim of this study is to understand if and how using social media influences *online* buying intention of wine consumers. In particular, the study focuses on the moderating role of consumers' knowledge. Knowledge is particularly important in consumer behaviour literature. Previous studies distinguish between objective and subjective knowledge (Aurier and N'gobo, 1999; Brucks, 1985; Dodd et al., 2005; Johnson and Bastian, 2007; Perrouy et al., 2008); objective knowledge refers to what a consumer actually knows, while subjective knowledge refers to "*how much an individual thinks he knows about a product*" (Johnson and Bastian, 2007: 186). We advance two hypotheses. First, *the use of social media in information searching positively influences online buying intention (HP1)*. Second, *objective and subjective knowledge moderates the social media-buying intention behaviour (HP2)*.

### METHODOLOGY, DATA ANALYSIS AND RESULTS

A total sample of 2597 wine consumers is used: 2202 responses are collected via an online survey (administered between January and June 2016) and 395 responses are collected offline (control

sample).

**Table 1:** Results from multinomial regression model

	Outcome (2) < 1/month	Outcome (3) 3/4 times/month	Outcome (4) > 1/month
Wine_online_buying_intention			
[2]	1,904***	1,309***	1,358
[3]	1,533***	2,358***	2,666***
[4]	2,091***	2,469***	5,343***
[5]	4,688***	-12,611***	-14,102***
Age	0,133***	0,395***	0,164
Age2	-0,001***	-0,005***	-0,002
Gender	0,278*	1,159***	1,988***
Salary	0,197	0,108	0,711
Level_of_Education	0,089	0,172	0,965**
Freq_wine_consumption			
[2]	0,304	-1,034	-1,233
[3]	0,481	-0,173	-2,466**
[4]	1,163*	-0,581	-3,485***
[5]	1,297*	-0,135	-3,848***
Wine_price			
[2]	0,182	0,100	13,824***
[3]	0,674**	1,324**	13,868***
[4]	1,282***	2,169***	14,809***
[5]	0,328	2,243***	16,195***
Wine_buying_frequency			
[2]	0,232	0,495	-1,522*
[3]	0,185	2,163**	-1,500*
[4]	-0,025	2,197**	1,211
[5]	0,398	2,646**	2,905**
AA	0,980***	1,830***	1,652
BB	-0,108	1,040*	-0,507
AB	-0,297	1,232**	1,296
Social_Media_Use	0,576***	0,923***	1,404***
Constant	-9,406***	-18,345***	-27,233***

N = 2597. Wald Chi2: 4941,10; Pseudo R2: 0,345

Outcome basis: Never (1)

The *dependent variable* (Wine\_online\_buying\_intention) refers to online wine buying behaviour and it assumes 5 values (never; less than once/month; occasionally: 3-4 times/months; regularly: more than once/week; all days). The *independent variable* refers to the use of social media and it is represented by a 4-items construct that look at the degree of use of social media (on a Likert scale) for searching wine information. The items are drawn from Bruwer e Wood (2005), Chen et al. (2011), Quinton e Harridge-March (2008), Thach (2009), Reyneke et al. (2011), Wilson e Quinton (2012). The *moderating variable* refers to the objective and subjective knowledge and they are measured by multi-items (Likert scale) based on Dodd et al. (2005) and Vigar-Ellis et al. (2015). On the basis of objective and subjective knowledge we identify 4 clusters of respondents: "Experts" (high subjective and high objective knowledge - HH), "Self-overevaluated" (high subjective and low objective knowledge - HL), "Modest" (low subjective and high objective knowledge - LH) and "Aware" (low subjective and low objective

knowledge – LL). *Control variables* (age, gender, salary, educational level, frequency of online sales, wine consumption frequency, wine buying frequency, wine average price) are considered in the final model. Convergent and discriminant validities are performed for all multi-items constructs.

A *multinomial logistic model* is used. This model is preferred to the ordinal logistic regression since the parallel regression assumption is violated. Table 1 presents the results.

From the analysis, both hypothesis 1 and hypothesis 2 are supported. Consequently, the use of social media in information searching positively influences online buying intention. (Objective and subjective) knowledge moderates the social media-buying intention behaviour. The higher effect is for “Experts” consumers, i.e. those with high subjective and high objective knowledge, while the lowest effect is for “Aware” consumers, i.e. low subjective and low objective knowledge. The analysis shows that when knowledge grows, the influence of social media on buying intention grows. The *post-hoc analysis* also shows that the social media-buying intention relationship is influenced by socio-demographic factors (age and gender) and consumption-related factors (eg. average price).

## CONCLUSIONS

This study advances extant research on the influence of social media on online buying intentions, showing how social media use positively influences the online buying intentions. In particular, it extends previous studies in analysing the moderating role of subjective and objective knowledge. Managerial implications are threefold. First, despite e-commerce still does not represent the main acquiring channel according to the sampled respondents, social media may influence this choice. Second, from the data collected it seems that consumers who tend to acquire online are Experts, who are looking for medium-high or high wine quality. Consequently, wine marketing strategies could aim at increasing knowledge levels through information sharing on social media. Lastly, the study suggests that age has a quadratic effects and it is particularly important for those consumers who use social media. Future studies should further investigate the relationship between age, social media and use of online channels.

*Keywords: online, wine, buying intentions, social media*

## REFERENCES

- Aurier P. and N’Gobo P. (1999). Assessment of consumer knowledge and its consequences: a multi-component approach. In: L. Scott, and E. Arnould (eds), *Advances in Consumer Research*. 26th ed., Association for Consumer Research, Provo, UT, pp. 569-75.
- Berthon P. R., Pitt L. F., Plangger K., Shapiro D. (2012), “Marketing meets Web 2.0, social media, and creative consumers: Implications for international marketing strategy”, *Business Horizons*, Vol. 55 No. 3, pp. 261-271.

- Brucks M. (1985), "The effects of product class knowledge on information search behavior", *Journal of Consumer Research*, Vol. 12 No. 1, pp. 1-16.
- Bruwer J., Wood G. (2005), "The Australian online wine-buying consumer: motivational and behavioural perspectives", *Journal of Wine Research*, Vol. 16 No. 3, 193-211.
- Chen Y., Fay S., and Wang Q. (2011), "The role of marketing in social media: how online consumer reviews evolve", *Journal of Interactive Marketing*, Vol. 25 No. 2, pp. 85-94.
- Dodd T.H., Laverie D.A., Wilcox J.F., and Duhan D.D. (2005), "Differential effects of experience, subjective knowledge, and objective knowledge on sources of information used in consumer wine purchasing", *Journal of Hospitality and Tourism Research*, Vol. 29 No. 1, pp. 3-19.
- Gatautis R., and Kazakevičiūtė A. (2012), "Consumer Behavior in Online Social Networks: Review and Future Research Directions", *Economics & Management*, Vol. 17 No. 4, pp. 1457-1463.
- Hajli M. N. (2014), "A study of the impact of social media on consumers", *International Journal of Market Research*, Vol. 56 No. 3, pp. 387-404.
- Heinonen K. (2008), "Consumer activity in social media: managerial approaches to consumers' social media behavior", *Journal of Consumer Behaviour*, Vol. 2, pp. 356-364.
- Johnson, T.E. and Bastian, S.E.P. (2007): 'A preliminary study of the relationship between Australian wine consumers' wine expertise and their wine purchasing and consumption behaviour', *Australian Journal of Grape and Wine Research*, Vol. 13, pp. 186-197.
- Krishnamurthy S., and Dou W. (2008), "Advertising with User-Generated Content: A Framework and Research Agenda", *Journal of Interactive Advertising*, Vol. 8 No. 2, pp. 1-7.
- Laverie D.A., Humphrey W.F., Velikova N., Dodd T.H., Wilcox J.B. (2011). Building wine brand communities with the use of social media: a conceptual model. Paper presented at the Sixth AWBR International Conference, 9-10 June, Bordeaux.
- Perrouy, J.P., d'Hauteville, F. and Lockshin, L. (2006): 'The Influence of Wine Attributes on Region of Origin Equity: An Analysis of the Moderating Effect of Consumer's Perceived Expertise', *Agribusiness*, Vol. 22 No. 3, pp. 323-341
- Quinton S., and Harridge-March S. (2008), "Trust and online wine purchasing: insights into UK consumer behavior", *International Journal of Wine Business Research*, Vol. 20 No. 1, pp. 68-85.
- Reyneke M., Pitt L., and Berthon P.R. (2011), "Luxury wine brand visibility in social media: an exploratory study", *International Journal of Wine Business Research*, Vol. 23 No. 1, pp. 21-35.
- Szolnoki G., Tait D., Nagel M., and Fortunato A. (2014), "Using social media in the wine business", *International Journal of Wine Business Research*, Vol. 6 No. 2, pp. 80-96.
- Thach, L. (2009), "Wine 2.0-The next phase of wine marketing? Exploring US winery adoption of wine 2.0 components", *Journal of Wine Research*, Vol. 20 No. 2, pp. 143-157.
- Vigar-Ellis D., Leyland P., and Caruana, A. (2015), "Knowledge effects on the exploratory acquisition of wine", *International Journal of Wine Business Research*, Vol. 27 No. 2, pp. 84-102.
- Wilson D., Quinton S. (2012). Let's talk about wine: does Twitter have value? *International Journal of Wine Business Research*, Vol. 24 No. 4, pp. 271-286.



# RELIGIOSITY AND ORGANIC FOOD CONSUMPTION. TOWARDS A DEEPER UNDERSTANDING

Raggiotto, Francesco<sup>1</sup>; Mason, Michela Cesarina<sup>1</sup>; Moretti, Andrea<sup>1</sup>; Cardinali, Silvio<sup>2</sup>

<sup>1</sup>Dept. of Economics and Statistics, University of Udine, Udine, Italy

<sup>2</sup>Dept. of Management, Università Politecnica delle Marche, Ancona, Italy

## ABSTRACT

## INTRODUCTION

The study analyzes the effect of three constructs as antecedents of organic food consumption: extrinsic religiosity, intrinsic religiosity, and individual attachment to a religious community.

Marketing and consumer research are aware of the potential impacts of religion on consumption choices since a long time. However, few are the studies approaching the matter of organic food consumption considering the effects of religiosity. The effect of three potential antecedents are there considered. Intrinsic and extrinsic religiosity are included in the analysis. A third antecedent regards individual attachment to a religious community. The impact of such perceived individual belonging is here considered for a more comprehensive analysis, and given the negligible attention the concept has received so far in the -scarce- available literature on the topic. Structural Equation Modeling has been performed on a sample of Italian individuals attending Buddhist pilgrimages. Preliminary estimations of the model show a good model fit; all the proposed hypotheses resulted significant.

## BACKGROUND

Organic food consumption has experienced, especially in industrialized markets, a considerable growth (e.g., Richter, 2008; Paul and Rana, 2012). Among those studies devoted to investigating the antecedents of organic food consumption, few considered the potential implications of religious values. Religiosity is defined as «a belief in God accompanied by a commitment to follow principles believed to be set by God» (Vitell et al, 2005). It is well-known that religiosity influences everyday human behaviour (Weaver and Agle, 2002). Religion influences also consumption patterns of people (Essoo and Dibb, 2004; Doran and Natale, 2010). Religion is a clear determinant of consumer behaviour, given the pervasive nature of this cultural component, influencing several traits of societies and individual lives. The relevance of religiosity for marketers is straightforward: as noted by Kim et al (2004) religion is an enduring cultural factor, whose influences extend in the long term. In this sense, religion is very likely to influence marketing strategies and initiatives. Such importance of

religion in consumer behaviour and in marketing science has been long recognized by scholars (e.g., Allport and Ross, 1967; Hirschman, 1983). In consumer behaviour literature, several measurements of the religiosity construct have been proposed (e.g., Allport and Ross, 1967; Hirschman, 1983; Genia, 1993; Worthington et al, 2003; Kim et al, 2004). Following most of research on religiosity in consumer behaviour (e.g., Allport and Ross, 1967; Donahue, 1985; Vitell et al, 2005), the study includes intrinsic and extrinsic religiosity as potential antecedents of consumer behaviour related to organic food consumption. As a third antecedent, the study considers consumer perceived attachment to a religious community. The relatively scarce literature on the impact of religion on consumer behaviour has not devoted relevant attention, as far as it is known, to the impact of perceived belongingness to religious communities in determining individual consumer behaviour. (e.g., Lindridge, 2005).

## METHODOLOGY AND EARLY RESULTS

Data collection was based on the administration of a questionnaire to individuals attending a Buddhist pilgrimage in Northern Italy. Known and validated scales were used for intrinsic and extrinsic religiosity. Due to the substantial lack of studies on the role of religious communities in consumption contexts, a modified version of Sierra et al's (2016) measure of community attachment was adapted to the context of the Buddhist religious community, as a proxy of the individual sense of belonging with respect to religious communities. 310 usable responses resulted after data collection. SEM was performed on the collected data; early estimations of the model shows an acceptable fit (RMSEA= .046; AGFI= .907; GFI= .941). All the hypothesized relationships were found significant, confirming results of extant literature on the impact of intrinsic and extrinsic religiosity on food consumption (e.g., Mukhtar and Mohsin Butt, 2011), providing also evidence for the influencing role of perceived community belonging. Originality of results should be considered in terms of research context, which differs from the majority of existing research on the role of religiosity in food consumption, mostly related to Islamic contexts. These preliminary results also suggest to further explore individual importance of religious communities in consumption, adopting, for example, the lenses of literature on brand/consumer communities.

*Keywords: religiosity; religious communities; organic food; Buddhism.*

## REFERENCES

- Hirschman, E.C. (1981), "American Jewish Ethnicity: Its Relationship to Some Selected Aspects of Consumer Behaviour", *Journal of Marketing*, Summer, Vol. 45, pp.102-110
- Essoo, N., & Dibb, S. (2004). "Religious influences on shopping behaviour: An exploratory study". *Journal of Marketing Management*, number 20, vol. 7-8, pp. 683-712.

Vitell, S. J., Paolillo, J. G., & Singh, J. J. (2005). "Religiosity and consumer ethics". *Journal of business ethics*, number 57, vol. 2, pp. 175-181.

*Additional references available upon request*

## REDEPLOYMENT OF BRAND ASSETS FOLLOWING M&A BY EMERGING MARKET FIRMS

Rahman, Mahabubur

Department of Marketing, Rennes School of Business, Rennes, France

### ABSTRACT

Studies have shown that firms from emerging countries have been increasingly engaged in cross-border mergers and acquisitions. In 2004, the deal value of cross-border M&A by emerging-country firms stood at \$37 billion which skyrocketed to \$182 billion in 2008 — a staggering increase of 392%. According to one report by Boston Consulting Group, top 100 firms from various emerging countries are expanding globally in a wide array of industries such as industrial goods, pharmaceuticals, telecommunications etc., and this global expansion is mainly happening through cross-border mergers and acquisitions. The report further showed that 57% of the cross-border M&A deals made by these emerging-country firms during 1985 to 2005 involved target firms from the developed countries (Emerging to Developed). Some of the major acquisitions by emerging country firms in the recent years include: Chinese automotive company Geely's acquisitions of Volvo, Indian automotive firm Tata Motor's acquisition of Jaguar and Land Rover, Mexico-based Cemex's US \$15.1 billion acquisition of Australia's Rinker Group and most recently, Chinese firm Lenovo's acquisition of Motorola for USD 2.9 billion.

M&A research in developed country context has demonstrated that firms in developed countries engaged in M&A for various motives such as to achieve economies of scale, economies of scope and market power. Put differently, firms engaged in cross-border M&A with diverse motives such as to leverage their current capabilities, expand their current businesses, expand market coverage etc. It thus appears that firms from developed countries engage in M&A mainly to capitalize on their existing *competitive advantage* such as strong brand names. Conversely, the scant research on M&A in emerging-country context has shown that firms from emerging countries engage in M&A predominantly to acquire strategic assets such as technological capability, brand assets etc. with the objective to reduce their *competitive disadvantage*. Extant research has shown that emerging-country firms suffer from significant competitive disadvantages vis-à-vis firms from developed countries. These competitive disadvantages arise from, inter alia, outdated technology, lack of knowledge about overseas markets, lack of internationally known brands. It therefore appears that the motives for engaging in M&A deals of emerging-market firms differ from those of developed-market firms.

While emerging-market firms are acquiring firms from developed-market so as to reduce their competitive disadvantage, acquisition of new strategic assets by itself does not guarantee the reduction of competitive disadvantage of these firms. Research has shown that strategic actions taken by the acquiring firm following acquisition largely determine the extent to which the acquisition benefits the acquiring firms. Specifically, post-merger integration strategy has a crucial impact on the success or failure of the acquisition itself. Thus far, nothing has been written in the academic literature as to how these newly acquired strategic assets help the emerging-market firms to reduce their competitive disadvantage. Moreover, the impact of these strategic assets on the marketing performance of the emerging-market firms in the post-merger years also remains unexplored. The main contribution of this paper is to fill this void. Capitalizing on resource based view (RBV), the paper develops a conceptual framework and demonstrates that the emerging market firms redeploy product attributes from the newly acquired brand to the existing brand of the acquiring firms in an effort to augment the brand equity and thereby improving the marketing performance of the existing brand. The papers develop the following propositions based on the conceptual framework which are yet to be tested.

**Proposition 1:** *To gain synergetic benefit from newly-acquired strategic assets, the acquiring firm will redeploy product attributes from the acquired brand to the acquirer's brand.*

**Proposition 2:** *Successful redeployment of product attribute from the acquired brand to the acquiring brand will be moderated by the level and quality of integration of the two merging firms.*

**Proposition 3:** *Redeployment of product attributes from the acquired brand to the existing target brand will increase the perceived quality of the target brand. .*

**Proposition 4:** *The redeployment of product attributes from the acquired brand to the acquiring brand will lead to improved perceived quality of the acquiring brand and it will moderated by the change in the customers' existing cognitive structure.*

**Proposition 5:** *Increased perceived quality of the acquirer's brand will have a positive impact on the acquiring firm's brand's marketing performance in the post-merger years.*

*Keywords: Brand equity, Mergers and acquisitions, perceived value, Post-merger integration*

## REFERENCES

Upon request

## WHY WE CONSUME FINANCIAL SELF-HELP? A THICK EXPLANATION USING CONSUMER TALES

Rahman, Kaleel

School of Economics Finance and Marketing, RMIT University, Melbourne, Australia

### ABSTRACT

The demand for financial advice in general has seen significant increase in the recent years (Kramer, 2012). Yet, only a small percentage of population actually seek professional financial advice (Knutsen and Cameron 2012). Financial advice can broadly be categorised into professional versus non-professional advice. A vast majority of non-professional advice generally belongs to self-help sector. This research investigates why individual investors use non-professional financial self-help when they have access to credible professional financial advice in making investment decisions. Of particular importance is the trend that consumers spend considerable amount of money in self-help content in order to improve their personal finance despite increasing prevalence of scams.

Financial self-help contents have had a consistently high rating in the recent the years (Bergsma, 2010). The following may be considered as some concrete examples of financial self-help contents: "Don't Worry, Make Money", a book by Richard Carlson; a youtube video on "How to Find Great Investments" by Robert Kiyosaki; "Wealth Mastery", a 3-day seminar by Anthony Robbins. Financial self-help contents are a resource that consumers can use to help improve themselves by reading a book, following audio-visual materials, or attending a self-help seminar (e.g., "wealth mastery" seminar by Anthony Robbins) and they will be shown how they can enhance their personal financial position (Ebben, 1995). The professional finance sector generally considers financial self-help as a potential threat to their existence. For example, McDonald (1998) critiques Richard Carlson's "Don't Worry, Make Money" (book), which topped the New York Times business bestseller list. As McDonald argues, Carlson, a professional feel-good speaker and stress consultant who has a Ph.D. in psychology-but no background in finance - should not be in the business of advising on finances. However, giving that the current system in the professional financial advice in has a number of issues (Knutsen and Cameron 2012), consumers are increasingly being 'sucked in' to self-help systems due to a range of persuasive promotional techniques by non-professional self-help providers. For example, due to recent introduction of self-managed super funds in Australia, a large number of companies are promoting their products and services to individual investors via a range of seminars.

Using phenomenological method (Russell and Levy, 2012; Thompson et al, 1989), combined with a thick explanation (De Munck, 1998), we investigated why consumers use non-professional financial self-help when they have access to credible professional financial advice in making investment

decisions. In this paper, a thick explanation of individual consumer tale is illustrated from four consumers. One summary is illustrated as follows:

Marty: a 47 year old Aussie IT manager, who became interested in IT during high school, and went on to earn a degree in this field and began his career in computing information system as a technical helper, and worked his way up to management, changing jobs along the way. Growing up, Marty had watched his parents invest in real estate, and talk about the value of money, which made him interested in his own finances and how he could increase his money. During university and his early career, Marty invested in shares. He was “interested in short-term returns, than long-term returns” wanting to “make quick money.” In the meantime, Marty fell in love and married Gina who was “living high”, “quite materialistic” and “wanted to best all the time,” and “spent too much”. The marriage broke. Marty then remarried Amanda, with whom things turned around. He started accumulating personal debts but managed to recover and started to meaningfully invest in real-estate, built wealth, and currently owns seven houses.

The presentation of this research focuses on a detailed analysis resulting in commonalities and diversities amongst the consumer tales, and provides insights for policy makers and businesses.

*Keywords: self-help, consumption, financial services, financial literacy, marketing, Australia, thick description*

## REFERENCES

- De Munck, V. C. (1998). Participant observation: a thick explanation of conflict in a Sri Lankan village. Using methods in the field: A practical introduction and casebook, 39-56.
- Bergsma, A. (2010) “The State of the Art in Happiness Advice; Can We Escape the Dodo-Verdict?” *Journal of Happiness Studies*, 11:649–654
- Ebben, M., 1995. “Off the Shelf Salvation: A Feminist Critique of Self-Help” *Women’s Studies in Communication*, 18(2): 111-122.
- Knutsen, J., & Cameron, R. (2012). The Financial Coaching Advice Model: An Exploration into how it Satisfies Expectations of Quality Advice. *Australasian Accounting Business & Finance Journal*, 6(4), 31-45.
- Kramer, M. M. (2012). Financial Advice and Individual Investor Portfolio Performance. *Financial Management (Wiley-Blackwell)*, 41(1), 395-428. doi:10.1111/j.1755-053X.2012.01185.x
- McDonald, D. (1998). Skip this hot self-help money book. *Money*, 27(2), 21.
- Russell, C. A. and Levy, S. (2012) “The Temporal and Focal Dynamics of Volitional Reconsumption: A Phenomenological Investigation of Repeated Hedonic Experiences”, *Journal of Consumer Research*, Vol. 39, pp. 341-358.
- Thompson, C. J., Locander, W. and Pollio, H. (1989), “Putting Consumer Experience Back into Consumer Research: The Philosophy and Method of Existential Phenomenology,” *Journal of Consumer Research*, 16 (2), 133–46.

# A MODERATED MEDIATION MODEL FOR THE ROLES OF TEAM LEARNING IN PROMOTING TEAM INNOVATION IMPLEMENTATION AND PERFORMANCE

Rashkovits, Sarit<sup>1</sup>; Livne, Yael<sup>2</sup>

<sup>1</sup>Department of Health Systems Management, Yezreel Valley College, Yezreel Valley, Israel

<sup>2</sup>Department of Human Services, Yezreel Valley College, Yezreel Valley, Israel

## ABSTRACT

## INTRODUCTION

Innovation implementation is a major challenge for organizations in the contemporary dynamic environment. The present study responds to the need in investigating the role of team learning in team innovation implementation and the associated team performance. Team innovation implementation is achieved when the innovation is assimilated into team practices such that the innovation is widely, skillfully and consistently deployed (Klein and Knight, 2005). Team learning, i.e. the proactive spiral process of reflection and action performed by team members (Edmondson, 1999), assists in the innovation assimilation process by increasing team awareness of innovations in its environment, by promoting the quality of team decisions to adopt innovations, and by adjusting the team practices to the innovation (Tucker et al., 2006; Schippers et al., 2014; Zhu et al., 2006). Accordingly, it is hypothesized that team learning will have a positive effect on team innovation implementation.

Since innovation is a general prototype of an idea, practice, or the implemented innovation often needs to be adjusted to increase its fit to the specific team's characteristics, mission and context. Team learning activity of reflection and experimenting with the innovation in its specific context, enables to adjust the innovation accordingly (Naveh et al., 2006; Tucker et al., 2006). Thus, it is hypothesized that team learning will moderate the relationship between team innovation implementation and team performance, such that this relationship will be stronger when team learning is higher.

Taken together, this study proposes a moderated mediation model that poses team learning as both facilitating team performance through team implementation, and moderating the path between team implementation and team performance. Accordingly, it is hypothesized that the indirect effect of team learning on team performance through team implementation will be moderated by team learning in the path from team implementation to team performance.

## METHODOLOGY

Global and national business theories and practice:  
bridging the past with the future

ISSN: 2547-8516  
ISBN: 978-9963-711-56-7



The study comprised 525 employees from 77 work teams (448 team members and 77 team managers) in various service industries. The research variables were measured by validated questionnaires accompanied by a 7 point Likert scale (1=very inaccurate; 7=very accurate). Team members' responses for team learning (Edmonson, 1999) were aggregated after satisfying the required criteria of Rwg(j), ICC1, & ICC2. The team managers' responses were used for assessing team innovation implementation (Axtell et al., 2000) and Team performance (Zellmer-Bruhn and Gibson, 2006). We controlled for team size and team manager's tenure. Research hypotheses were tested using a moderated mediation analyses using Model 74 in SPSS PROCESS (Hayes, 2013).

## FINDINGS

Team learning significantly predicted team innovation implementation ( $t=3.19$ ,  $p<0.002$ ), supporting hypothesis 1. Additionally, there was a significant interaction effect between team innovation implementation and team learning ( $t=3.82$ ,  $p<0.0003$ ) on team performance, in support with hypothesis 2. Team innovation implementation was more strongly related to team performance when team learning was high rather than low. Finally, the indirect effect of team learning on team performance was stronger for high (mean +1SD) team learning ( $ab=.39$ , CI 95% [.12, .68]) than for low (mean -1SD) team learning ( $ab=.17$ , CI 95% [.06, 0.34]), supporting hypothesis 3. Accordingly, there was also a significant moderated mediation effect of team learning on team performance ( $ab=.10$ , CI 95% [.03, 0.20]).

## IMPLICATIONS

Team learning not only facilitates team innovation implementation, but also moderates the relationships between team innovation implementation and team performance. This moderated mediation effect shows that the routine use of the innovation (i.e., its implementation), is not sufficient for achieving maximum team performance gains. Rather, there is also a need in team learning behavior for enhancing the fit of the innovation to the specific team's setting.

*Keywords: innovation implementation, team learning, team performance*

## REFERENCES

- Edmondson, A.C. (1999), "Psychological safety and learning behavior in work teams", *Administrative Science Quarterly*, Vol. 44 No. 2, pp. 350-383.
- Hayes, A.F. (2013). *Introduction to Mediation, Moderation, and Conditional Process Analysis: A Regression-based Approach*. Guilford Press, New York
- Klein, K.J. and Knight, A.P. (2005), "Innovation implementation: overcoming the challenge", *Current Directions in Psychological Science*, Vol. 14 No. 5, pp. 243-246.
- Klein, K.J. and Knight, A.P. (2005), "Innovation implementation: overcoming the challenge", *Current directions in psychological science*, Vol. 14, pp. 243-246.
- Naveh, E., Meilich, O. and Marcus, A. (2006), "The effects of administrative innovation implementation on performance: an organizational learning approach", *Strategic Organization*, Vol. 4 No. 3, pp. 275-302.
- Schippers, M.C., Edmondson, C.A.C. and West, M.A. (2014), "Team reflexivity as an antidote to team information processing failures", *Small Group Research*, Vol. 45 No. 6, pp. 731-769.
- Tucker, A., Nembhard, L.I. and Edmondson, A.C. (2006), "Implementing new practices: an empirical study of organizational learning in hospital intensive care units", *Management Science*, Vol. 53 No. 6, pp. 894-907.
- Zellmer-Bruhn, M. and Gibson, C. (2006), "Multinational organization context: implications for team learning and performance", *Academy of Management Journal*, Vol. 49 No. 3, pp. 501-518.
- Zhu, K., Kraemer, K.L. and Xu, S. (2006), "The process of innovation assimilation by firms in different countries: a technology diffusion perspective on e-business", *Management Science*, Vol. 52 No. 10, pp. 1557-1576.

# WHO BENEFITS MORE FROM TRANSFORMATIONAL LEADERSHIP? THE CASE OF TEACHERS' BURNOUT UNDER NORMAL VERSUS EXTREME WORK DEMANDS

Rashkovits, Sarit<sup>1</sup>; Livne, Yael<sup>2</sup>

<sup>1</sup>Department of Health Systems Management, Yezreel Valley College, Yezreel Valley, Israel

<sup>2</sup>Department of Human Services, Yezreel Valley College, Yezreel Valley, Israel

## ABSTRACT

## INTRODUCTION

The benefits of transformational leadership are well-known, including its negative effect on burnout (Skakon et al., 2010). Recent studies show that the beneficial consequences of transformational leadership are contingent upon environmental factors (e.g., Den Hartog and Belschak, 2012; Schmitt et al., 2016). However, prior research neglected the intervening role of work conditions in the transformational leadership – burnout relationship. As transformational leadership transforms followers to rise above their self-interest by changing their values, beliefs, self-perceptions, and motivating them to perform above and beyond expectations (Bass and Avolio, 1990), it requires employees to invest high levels of effort in work. In terms of the Conservation of Resources theory (Hobfoll, 1989), the constant investment of effort leads to ongoing use of resources to cope with job demands, resulting in continuous resource loss and consequently in burnout. Therefore, we suggest that in extremely demanding work conditions the effect of transformational leadership on burnout is weaker.

Extremely demanding work conditions can be found in some schools. Specifically, efforts to prevent pupils from dropping out lead to the formation of separate schools for this population, which are characterized by high absenteeism, low achievement, feelings of alienation, social maladjustment, behavioral problems, and violence (McCluskey, 2008). Teachers who work in this type of schools are faced with an extremely demanding work environment.

Accordingly, the present study aims to investigate whether transformational leadership is equally effective in reducing burnout under the different work conditions of extreme versus normal demands. We suggest that the inspiring and motivating nature of transformational leadership should better inhibit burnout when teachers have more available resources to take advantage of their principals' leadership style, that is, when the working environment is not extremely demanding. Therefore, it is hypothesized that school type will moderate the relationship between school principals' level of transformational leadership and teachers' level of burnout, such that in extremely-demanding schools the negative effect of transformational leadership on burnout will be weaker than in normally-demanding schools.

## METHODOLOGY

263 teachers participated in the study, of whom 72 worked in extremely-demanding schools and 191 worked in normally-demanding schools. Data were obtained using anonymous questionnaires and the study variables were measured with well accepted and validated scales.

## FINDINGS

The hypotheses were examined using hierarchical multiple regression analysis. A significant effect was found for school type on teachers' burnout ( $\beta=0.454$ ,  $P<0.0001$ ), such that burnout level was higher in extremely demanding schools. A significant effect was found for transformational leadership on teachers' burnout ( $\beta=-0.449$ ,  $P<0.0001$ ), such that as the manager's level of transformational leadership was higher the burnout level of the teachers was lower. Finally, a significant interaction was found between transformational leadership and school type in predicting teacher's burnout ( $\beta=0.465$ ,  $p<0.05$ ), such that the negative effect of transformational leadership on teachers' burnout was significantly stronger in normally demanding schools in comparison to extremely demanding schools.

## IMPLICATIONS

The results expand our understanding of contingencies of the transformational leadership - burnout relationship, showing that transformational leadership is less effective in extremely demanding work settings, where employees' resources are depleted, therefore not allowing them to use the benefits of transformational leadership for burnout reduction. The findings suggest that in extremely demanding schools there is a need in implementing other burnout reduction mechanisms.

*Keywords: burnout, transformational leadership, work demands.*

## REFERENCES

- Bass, B.M. and Avolio, B.J. (1990), *Transformational Leadership Development: Manual for the Multifactor Leadership Questionnaire*, Consulting Psychologists Press, Palo Alto, CA.
- Den Hartog, D.N. and Belschak, F.D. (2012), "When does transformational leadership enhance employee proactive behavior? the role of autonomy and role breadth self-efficacy", *Journal of Applied Psychology*, Vol. 97 No. 1, pp. 194-202.
- Hobfoll, S.E. (1989), "Conservation of resources: a new attempt at conceptualizing stress", *American Psychologist*, Vol. 44, pp. 513-524.
- McCluskey, G. (2008), "Exclusion from school: what can 'included' pupils tell us?" *British Educational Research Journal*, Vol. 34 No. 4, pp. 447-66.
- Schmitt, A., Den Hartog, D.N. and Belschak, F.D. (2016), "Transformational leadership and proactive work behaviour: a moderated mediation model including work engagement and job strain". *Journal of Occupational and Organizational Psychology*, Vol. 89, pp. 588-610.
- Skakon, J., Nielsen, K. Borg, V. and Guzman, J. (2010), "Are leader's well-being, behaviors and style associated with the affective well-being of their employees? a systematic review of three decades of research", *Work & Stress*, Vol. 24 No. 2, pp. 107-139.

# **ANTECEDENTS OF ORGANIZATIONAL FIELD REGULATORY CHANGE: LINKING INDIVIDUAL PROFILES OF SOCIAL ENTREPRENEURS WITH THEIR REGULATORY NEEDS AND PRIORITIES?**

**Rimac, Tomislav; Gurses, Kerem**

Department of Business and Management, LUISS Guido Carli University, Rome, Italy

## **ABSTRACT**

In this paper, we focus on the interplay between social entrepreneurs and their organizations with the regulatory institutional context within which they work toward positive social change. We show that although regulatory context of the social entrepreneurship field is in its infancy, regulatory needs and priorities of the field are well-defined and heterogeneous. To explain the sources of the heterogeneity, we adopt a two-method strategy which combines traditional quantitative methods with qualitative case analysis. Based on the data about values, motivation, and entrepreneurial orientation of social entrepreneurs from four EU countries, we develop a typology of social entrepreneurs. By establishing links between identified profiles of social entrepreneurs and different regulatory needs and priorities we contribute to the institutional theory literature dealing with organizational field regulatory change. Furthermore, we provide valuable insights for policy makers in the social entrepreneurship field.

## **INTRODUCTION**

Studies have shown that the institutional environment plays a key role for entrepreneurs in that it facilitates or hampers venture emergence and survival (Hwang and Powell, 2005; Pacheco et al., 2010). Within different aspects of an institutional environment, laws and regulations are known to be critical drivers of this process as regulatory actors can promote or hinder new products and services through the institutional mechanisms they develop (Edelman and Suchman, 1997; Russo, 2001). While regulated environments are known to be challenging for entrepreneurs, regulation-free environments are not problem-free either. It is relatively easy to observe how the relative lack of institutions and regulations can be an obstacle to entrepreneurs. However, it is less easy in the social entrepreneurship context to conceive how the lack of institutions/regulations can affect the development of social ventures since social entrepreneurship is more likely to occur where there are significant socioeconomic or cultural problems (Dacin et al 2010), Thus little is known about what are regulatory needs and priorities of social entrepreneurs and what determines these needs and priorities. Since there is no real consensus on what would the proper regulation for social entrepreneurship be, in this

study we propose that we might as well listen to the individual and collective voices of the community of social entrepreneurs and suggest policymakers formulate their regulations accordingly. We aim at improving our understanding of differences among regulatory needs and priorities of social entrepreneurs by looking at the link between configurations of individual profiles of social entrepreneurs consisting of their values, motivation and entrepreneurial orientation, and regulatory needs and priorities identified by these entrepreneurs. In other words, in this paper we are suggesting a motivated regulatory needs cognition argument that posits that differences in individual profiles of social entrepreneurs relate to specific regulatory needs and priorities. Furthermore, we suggest that within a broader community of social entrepreneurs there are specific sub-communities characterized by specific configurations of individual characteristics and regulatory needs and priorities. Specifically, we seek to achieve three main goals: first, we seek to establish a typology of social entrepreneurs based on their value profiles (Schwartz, 1994), motivation, and entrepreneurial orientation (Zhao, Seibert, and Lumpkin, 2009). Second, we aim to analyze and classify regulatory needs of social entrepreneurs. Finally, building on the typologies of individual characteristics of social entrepreneurs and classification of regulatory needs and priorities, we aim to establish a link between specific configuration at the individual level and specific regulatory needs and priorities.

In this study we rely on data from SELUSI database containing data on the population of social enterprises located in Hungary, Romania, Spain, and United Kingdom. The data was collected using two survey instruments – an online and a phone survey. The surveys were conducted during 2009-2010 (1<sup>st</sup> wave) and 2011 (2<sup>nd</sup> wave) either with the founder or the managing director. In total, the final sample has more than 500 social enterprises some of which were interviewed in two waves of data collection. In our data analysis we rely on the two-method strategy which combines traditional quantitative methods with qualitative case analysis, an approach that is becoming a powerful tool in social science research (e.g., Vaisey, 2007). Specifically, we rely on cluster analysis and fuzzy sets comparative qualitative analysis (Ragin, 2008) to reveal configurations of variables associated with specific policy needs and recommendations.

Benefiting from a diversity of personality profiles, organizational characteristics and regional and national regulatory environments in our data, we are able to capture configurations of individual characteristics of social entrepreneurs that are associated with specific categories of regulatory needs these entrepreneurs identify and prioritize. By showing that individual profiles determine how we see the institutional context, our theoretical contribution potentially could be applied to other type of communities. Finally, by conducting a research on social entrepreneurship and regulations we hope to contribute to the literature on social entrepreneurship as well as provide valuable insights for policy makers.

*Keywords: Institutional environment, social entrepreneurship, regulation, community*

## REFERENCES

- Dacin, P. A., Dacin, M. T., & Matear, M. 2010. Social entrepreneurship: Why we don't need a new theory and how we move forward from here. *The academy of management perspectives*, 24(3): 37-57.
- Edelman, L.B., & Suchman, M.G. 1997. The legal environments of organizations. *Annual review of sociology*, 23: 479- 515.
- Hwang, H. & Powell, W.W. 2005. Institutions and entrepreneurship. In S.A. Alvarez, R. Agarwal, & O. Sorenson (Eds.), *Handbook of entrepreneurship research: Disciplinary perspectives*: 201–232. New York: Springer.
- Pacheco, D., York, J.G., Dean, T.J., & Sarasvathy, S.D. 2010. The co-evolution of institutional entrepreneurship: A tale of two theories. *Journal of management*, 36(4): 974-1010.
- Ragin, C. C. 2008. *Redesigning Social Inquiry: Fuzzy Sets and Beyond*. Chicago: University of Chicago Press.
- Russo, M.V. 2001. Institutions, exchange relationships, and the emergence of new fields: regulatory policies and independent power production in America, 1978–1992. *Administrative Science Quarterly*, 46: 57–86.
- Schwartz, S. H. 1994. Are There Universal Aspects in the Structure and Contents of Human Values? *Journal of Social Issues*, 50 (4): 19-45.
- Vaisey, S. 2007. Structure, culture, and community: The search for belonging in 50 urban communes. *American Sociological Review*, 72: 851–873.
- Zhao, H., Seibert, S. E. and Lumpkin, G. T. 2009. The Relationship of Personality to Entrepreneurial Intentions and Performance: A Meta-Analytic Review. *Journal of Management*, 36 (2): 381-404.



# LUXURY CONSUMER-BRAND RELATIONSHIPS – THE IMPORTANCE OF SELF IN BRAND LOVE

Rodrigues, Paula<sup>1</sup>; Rodrigues, Clarinda<sup>2</sup>; Brandão, Amélia<sup>3</sup>; Costa, Paula<sup>1</sup>

<sup>1</sup>School of Economic and Management, Lusíada University North, Porto, Portugal

<sup>2</sup>School of Business and Economics, Linnaeus University, Kalmar, Sweden

<sup>3</sup>Faculty of Economics, University of Porto, Porto, Portugal

## ABSTRACT

### 1. INTRODUCTION

Although the marketing and branding literature has seen a great deal of interest in the study of luxury brands (Kapferer and Laurent, 2016; Chandon et al, 2016), little is yet known of how luxury perceptions can elicit passionate feelings towards luxury brands such as brand love (Batra et al., 2012; Albert and Merunka, 2013). The purpose of this paper is to investigate the influence of self-congruency (Grubb and Grathwohl, 1967; Fugate and Philips, 2010) and self-brand integration (Mohammadian and Karimpour, 2014) on luxury perceptions (Hennings et al., 2013; Hampel et al., 2012). It also aims to investigate the direct and moderating effect of luxury perceptions on brand love.

### 2. THEORETICAL BACKGROUND

The traditional meaning of luxury is associated with excellence, creativity, exclusivity (Jackson and Shaw, 2009; Okonkwo, 2009), heritage of craftsmanship, recognizable style, premium price and global reputation (Nuemo and Quelch, 1998). Nevertheless, recent studies emphasize luxury as an experience that adds value to consumer-brand relationships and stress that luxury brands allow consumers to derive subjective intangible benefits beyond their functional utility (Vigneron and Johnson, 1999) and help them to reflect their self (Belk, 1998). In this regard, fashion goods such as shoes and accessories are used as a means to symbolize social status, prestige and success (Cheah et al., 2015).

Self-congruency theory states that consumers buy and use goods, which are somehow reflective of their own image or identity (Grubb and Grathwohl, 1967; Fugate and Philips, 2010). Given the importance of purchasing luxury goods for their symbolic meaning and their reflection of the individual's self-concept, we believe that those consumers will be influenced to a greater degree by luxury brand perceptions when consumers relate to luxury brands. Specifically:

H1- H3: Self-congruency has a positive and direct relationship with prestigious perception of a brand, luxury brand perception and overall luxury brand perception.

The concept of brand self-brand integration refers to the ability of a brand to express consumer's

actual and ideal identities (Mohammadian and Karimpour, 2014). According to Reimann et al. (2012) a brand is regarded as signifier of the self, allowing consumers to portray their individuality, exhibit their social standing or fulfill their experimental needs (Nuemo and Quelch, 1998; Vigneron and Johnson, 2004). Thus, we suggest that consumers tend to relate to luxury brands, which they perceive to be closer to their own-self image or better address their aspirational needs in the consumption process. Therefore:

H4-H6: Self-brand integration has a positive and direct relationship with prestigious perception of a brand, luxury brand perception and overall luxury brand perception.

Research shows that the concept of luxury is highly subjective, situational contingent and dependent on consumer experiences and individual needs (Wiedmann et al., 2007). Following this perspective, it is claimed that consumers evaluate luxury brands based on financial, functional and emotional attributes (ibid) and that they usually relate to brands, which are able to deliver sufficient value in accordance to consumer subjective expectations and individual perceptions (Dubois and Duquesne, 1993; Zhang and Bloemer, 2008). Therefore, we expect that the result of the perception of a luxury brand is reflected in the strength of consumer-brand relationships such as brand love. Formally, we then state that:

H7-H9: Prestigious perception of a brand, luxury brand perception and overall luxury brand perception has a positive and direct relationship with brand love.

### 3. RESEARCH METHOD

Luis Onofre is a Portuguese designer luxury brand created in 1999. Data collection was done using a structured questionnaire to final consumers, who frequently buy luxury fashion products. Its measurement was made using Likert scale of 5 points, where 1 corresponded to "strongly disagree" and 5 corresponding to "strongly agree." The Luxury Brand Perception (LBP) and Overall Luxury Value Perception (OLVP) was measured using Hennigs et al. (2013) scale the first with 4 items and the second with 3 items, the Brand Love (BL) was measured using the Carroll and Ahuvia (2006) scale with 7 items, the Self-Brand Integration (SBI) was measured using Mohammadian and Karimpour (2014) scale with 7 items, the Self-Congruency (SC) was measured using the Fugate and Phillips (2010) scale with 3 items, the Prestigious Perception of Brand (PPB) was measured using Hampel, Heinrich and Campbell (2012) scale with 4 items.

### 4. RESULTS

A total of 304 valid questionnaires were collected. Of the sample, 40% were male and 60% female. The majority of respondents were aged up to 30 years (71.7%), representing the age range

from 31 to 50 years, 21.4% and above 50 years, 6.9%. 73.4% of the respondents answered that they were single and 22.7% married or in union. The monthly net income of the household with the highest number of responses was between 1001 and 2000 € (31.9%), followed by those with less than € 1000 (27.3%) and those with above 2000 € 37.8%. Of the 304 respondents, 61.8% had secondary education, 33.9% had higher education and 4.3% had only basic education. To the question "Do you know the Luís Onofre brand?" 72.7% answered positively and to the question "Buy Luís Onofre brand products?" 62,55 % answered negatively

The survey questions were tested through exploratory factor analysis (EFA) and confirmatory factor analysis (CFA). Beginning with the EFA and in order to simplify the findings, an estimation with principal components was performed on an initial factor solution. The criteria for acceptance of the results were the value of communalities is greater than 0.6 and the factor loading without rotation are greater than 0.70. Some items were eliminated. CFA was used to validate the measurement models consisting of six constructs. The level of Cronbach's alpha was measured for each factor to assess the internal consistency of the factor. The measurement model shows a reasonable fit when RMSEA is below 0.10 and the CFI are above 0.90 (Hair et al., 2010). Validation of the latent constructs is evaluated by convergent validity. All composite reliabilities are greater than the minimum criteria of 0.70 (Nunnally and Bernstein, 1994). The average variance extracted (AVE) provides evidence of overall convergent validity of each construct as it indicates the amount of variance explained by the construct relative to the amount of variance that may be attributed to measurement error, and should exceed 0.50 (Fornell and Larcker, 1981).

The results of structural equation model to test the hypotheses of the research is indicated in Fig. 1.

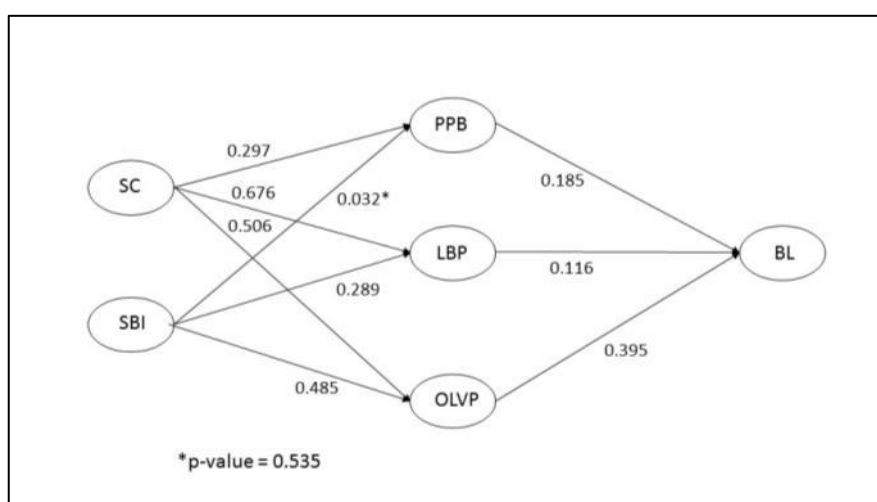

Fig. 1 – Research Model Estimated

As a result of testing the structural equation model, the model generated the following statistics:  $\chi^2_{(165)} = 1586.679$  ( $p = 0.000$ ), CFI = 0.952, TLI = 0.915, IFI = 0.953 and RMSEA = 0.069. The model has a very good fit.

As shown in Fig. 1, all constructs measuring brand love have a positive and significant inter-correlation and the hypotheses were all most validated except the H4. Moreover, the dimensions of PPL, LBP and OLVP are positively related to brand love ( $\gamma_1 = 0.185$ ,  $p = 0.000$ , H7;  $\gamma_2 = 0.116$ ,  $p = 0.000$ , H8; and  $\gamma_3 = 0.395$ ,  $p = 0.000$ , H9) but the influence of the PPL and LBP is smaller than the OLVP dimension. The influence of SC and SBI on LBP and OLVB is also demonstrated ( $\beta_2 = 0.676$ ,  $p = 0.000$ , H2;  $\beta_3 = 0.506$ ,  $p = 0.000$ , H3;  $\beta_6 = 0.289$ ,  $p = 0.000$ , H5 and  $\beta_7 = 0.485$ ,  $p = 0.000$ , H6), as well as the influence of SC on PPB ( $\beta_1 = 0.297$ ,  $p = 0.000$ , H1). Only the influence of SBI on PPL was not verified ( $\beta_4 = 0.032$ ,  $p = 0.535$ , H4).

## 5. CONCLUSION AND IMPLICATIONS

Brand love is a huge concept, on behalf of the brand management context. The literature review highlight the brand love as a construct intrinsically related to the emotions and customer engagement which adds value to the brand in terms of brand equity. The aims of this study is (i) to investigate the influence of self-congruency and self-brand integration on luxury perceptions and (ii) to investigate the direct and moderating effect of luxury perceptions on brand love. A proposal of a structural equation modelling (SEM) to assess the determinants and consequents of Prestigious Perception of a brand (PPB), Luxury Brand Perception (LBP), and Overall Luxury Value Perception (OLVP) was advanced and validated it in the context of marketing B to C. This study represents a contribution to the brand love research. Firstly, it points out the critical variables considered as determinants of the Brand Love in a new perspective, missing in the previous literature review. Secondly, the results consolidate the concept of Brand Love as a crucial construct in the long-term brand consumer relationship. Lastly, it provide key managerial insights answering how brand managers could capitalise brand through loved brands.

*Keywords: Luxury, Brands, Consumer-Brand Relationship, Brand Love, Self-Congruence, Self-Brand Integration; Luxury Brand Perception; Prestigious Perception; Overall Luxury Brand Perception; SEM*

## REFERENCES

- Albert, N. and Merunka, D. (2013), "The role of brand love in consumer-brand relationships", *Journal of Consumer Marketing*, Vol. 30, N° 3, pp. 258-266.
- Batra, R., Ahuvia, A, and Bagozzi, R. (2012), "Brand Love", *Journal of Marketing*, Vol. 76 (March), pp. 1-16.

- Beck, R.W. (1988), "Possessions and the extended self", *Journal of Consumer Research*, Vol. 15, September, pp. 139-68.
- Carroll, B. A., and Ahuvia, A. C., (2006), "Some antecedents and outcomes of brand love" *Marketing Letters*, Vol. 17, pp. 79-89.
- Chandon, J-L., Laurent, G. and Valette-Florence, P. (2016), "Pursuing the concept of luxury: Introducing to the JBR Special Issue on "Luxury Marketing from Tradition to Innovation", *Journal of Business Research*, Vol. 69, pp. 299-303.
- Cheah, I., Phau, I., Chong, C. and Shimul, A.S. (2015), "Antecedents and Outcomes of brand prominence on willingness to buy luxury brands", *Journal of Fashion Marketing and Management*, Vol. 39, N° 4, pp. 402-415.
- Dubois, B. and Duquesne, P. (1993) "The market for luxury goods: Income versus culture", *European Journal of Marketing*, Vol. 27, N° 1, pp. 35-44.
- Fornell, C. and Larcker, D. F. (1981), "Evaluating structural equation models with unobservable variables and measurement error." *Journal of Marketing Research*, Vol. 18 N° 1, pp. 39-50.
- Fugate, D. and Phillips, J. (2010), "Product gender perceptions and antecedents of product gender congruence", *Journal of Consumer Marketing*, Vol. 27, N° 3, pp. 251-261.
- Grubb, E.L. and Grathwohl, H. L. (1967), "Consumer self concept, symbolism and market behavior: a theoretical approach", *Journal of Marketing*, Vol. 31, N° 4, pp. 22-27.
- Hampel, S., Heinrich, D. and Campbell, C. (2012), "Is An Advertisement Worth the Paper It's Printed on? The Impact of Premium Print Advertising on Consumer Perception", *Journal of Advertising Research*, March, DOI:10.2501/JAR-52-1-118-127.
- Hair, J. F., Black, W. C., Babin, B. J. and Anderson, R. E. (2010). *Multivariate data analysis: a global perspective* Upper Saddle River, New Jersey, Pearson
- Hennings, N., Wiedermann, K-P., Behrens, S. and Klarmann, C. (2013), "Unleashing the power of luxury: antecedents of luxury perception and effects on luxury brand strength", *Journal of Brand Management*, Vol. 20, N° 8, pp. 705-715.
- Jackson, T. and Shaw, D. (2009), *Mastering fashion marketing*, Basingstoke, England: Palgrave MacMillan
- Kapferer, J-N. and Laurent, G. (2016), "Where do consumers think luxury begins? A study of perceived minimum price for 21 luxury goods in 7 countries", *Journal of Business Research*, Vol. 69, pp. 332-340.
- Mohammadian, M. and Karimpour, Y. (2014), "Identifying the Factors Influencing the Feeling of Love towards a brand: the Adidas Case", *Nationalpark-Forschung in der Schweiz*, Vol. 103, N° 1, pp. 94-122.
- Nuemo, J.L. and Quelch, J.A. (1998), "The mass marketing of luxury", *Business Horizons*, Vol. 41, N° 6, pp. 61-68.
- Nunnally, J. C. and Bernstein, I. H. (1994), *Psychometric Theory*, 3rd ed. New York: McGraw Hill.
- Okonkwo, U. (2009), "Sustaining the luxury brand on the Internet", *Journal of Brand Management*, Vol. 16, N° 3, pp. 302-310.
- Reimann, M., Castano, R., Zaichkowsky, J. and Bechara, J. (2012), "How do we relate to brands: psychological and neurophysiological insights into consumer-brand relationships", *Journal of Consumer Psychology*, Vol. 22, pp. 128-142.
- Vigneron, F. And Johnson, L.W. (2004). "Measuring perceptions of brand luxury", *Journal of Brand Management*, Vol. 11, N° 6, pp. 484-506.
- Wiedmann, K-P., Hennings, N. and Sibels, A. (2007), "Measuring consumers' luxury value perceptions: A cross-cultural framework", *Academy of Marketing Science Review*, Vol. 7, N° 7, pp. 1-21.
- Zhang, J. and Bloemer, J.M. (2008), "The impact of value congruence on consumer-service brand relationships", *Journal of Service Research*, Vol. 11, N° 2, pp. 161-178.

## CORPORATE GOVERNANCE INDEXES: A PRACTICAL APPLICATION ON ITALIAN SME'S

Roffia, Paolo

Department of Business administration, University of Verona, Verona, Italy

### ABSTRACT

In the economic literature, a group of studies investigated the impact that good corporate governance may have on corporate financial performance. Despite the difficulties underlying the creation of a bridge between the two terms, some authors were able to identify an evident relationship, finding depending and independent components.

One of the main problems they dealt with was the definition of corporate governance itself and its practical measure in the variety of businesses (industry/dimension/geographic area/regulation, family-non family owned, etc.)

Although both academics and practitioners have proposed a set of parameters and indices to assess "good corporate governance", difficulties arise when companies are not listed and are just small or medium enterprises. Corporate governance practices are limited, often firm specific and general prescriptions and measures for corporate governance must consequentially be adapted to the smaller dimension.

This study focuses on SMEs operating in northeast Italy. Following a review of the literature, a set of variables for measuring the "level" of corporate governance in that specific context is defined. A questionnaire with a set of variables was sent to SMEs in the Veneto region and more than 200 of them replied. After a descriptive analysis of responses, factor and cluster analyses were conducted in order to classify and aggregate the companies. In the sample considered, companies revealed that they pay attention to corporate governance matters and tend to polarize to 3 main clusters at the top and in the low-middle of the scale.

*Keywords: Corporate governance, SMEs*

### REFERENCES

- Bhagat, S.; Bolton, B.; Romano R.; (2008), "The promise and peril of corporate governance Indices", Faculty Scholarship series paper 1920, pp 1803-1882.
- Comitato per la corporate governance; (2015), "Codice di autodisciplina", Borsa Italiana.
- Gompers, P.; Ishii, J.; and Metrick, A.; (2003), "Corporate governance and equity prices", Quarterly journal of economics, 118, pp. 107-155.
- IOD and Cass Business School (2015), "The great governance debate – Towards a good governance index for listed companies, pp. 1-32.

OECD; (2015), "Principles of Corporate Governance", G20 Turkey.

## **FROM EMPLOYEE SATISFACTION TO CUSTOMER TRUST: A MODERATED MEDIATION MODEL IN THE ITALIAN CHAMBERS OF COMMERCE**

**Romanazzi, Salvatore<sup>1</sup>; Ambrosino, Gabriella<sup>2</sup>**

<sup>1</sup>University of Bari (Italy) and Italian Ministry of Economy and Finance

<sup>2</sup>University of Salerno (Italy) and Italian Ministry of Justice

### **ABSTRACT**

The importance of employee satisfaction in enhancing customer satisfaction has been emphasized in past research, as well as the link between customer satisfaction and (external) customer trust. Yet there is limited research exploring the mechanism linking them and very little is known about moderators and mediators – if any – affecting in their relationship. As employees are mainly responsible for service delivery, the interpersonal interaction between customers and employees has been found to substantially affect customer perceptions of services and considered as the key to customer satisfaction. Past research also indicated that employee satisfaction can enhance customer-employee interactions, which, in turn, increases customer satisfaction. Thus, there has been dedicated scientific interest for exploring the mechanisms linking employee, customer satisfaction and finally (customer) trust.

Integrating the “congestion” of the service (number of firms / number of employees), this study attempts to bridge this research gap by developing and testing a framework that includes the mediating emotional mechanism through which employee satisfaction affects customer satisfaction in a public service context. Furthermore, the model investigates how customer satisfaction generates trust.

A theoretical framework was developed to explore the employee-customer satisfaction and trust mediated by customer satisfaction. Moreover, the FE ratio (number of firms / number of Chamber’s employees) was taken as moderator of the relationship between customer satisfaction and trust.

Survey data collected from a sample of Italian Chambers of Commerce was examined through structural equation modeling. Results show very interesting implications for both boards of directors and management of the Chambers of Commerce.

### **INTRODUCTION**

Creating superior customer satisfaction has been the primary objective for service organizations. The importance of employee satisfaction in enhancing customer satisfaction has been emphasized in past research, as well as the link between customer satisfaction and (external) customer trust. Yet there is limited research exploring the mechanism linking them and very little is known about moderators and



mediators – if any – affecting in their relationship. As employees are mainly responsible for service delivery, the interpersonal interaction between customers and employees has been found to substantially affect customer perceptions of services and considered as the key to customer satisfaction (Brown and Lam, 2008). Past research also indicated that employee satisfaction can enhance customer-employee interactions, which, in turn, increases customer satisfaction (Homburg et al., 2009). Thus, there has been dedicated scientific interest for exploring the mechanisms linking employee, customer satisfaction and finally (customer) trust.

Integrating the “congestion” of the service (number of firms / number of employees) (Cachon and Feldman, 2011), this study attempts to bridge this research gap by developing and testing a framework that includes the mediating emotional mechanism through which employee satisfaction affects customer satisfaction in a public service context. Furthermore, the model investigates how customer satisfaction generates trust.

A theoretical framework was developed to explore the employee-customer satisfaction and trust mediated by customer satisfaction. Moreover, the FE ratio (number of firms / number of Chamber's employees) was taken as moderator of the relationship between customer satisfaction and trust.

Survey data collected from a sample of Italian Chambers of Commerce was examined through structural equation modeling and thus we developed the following model:

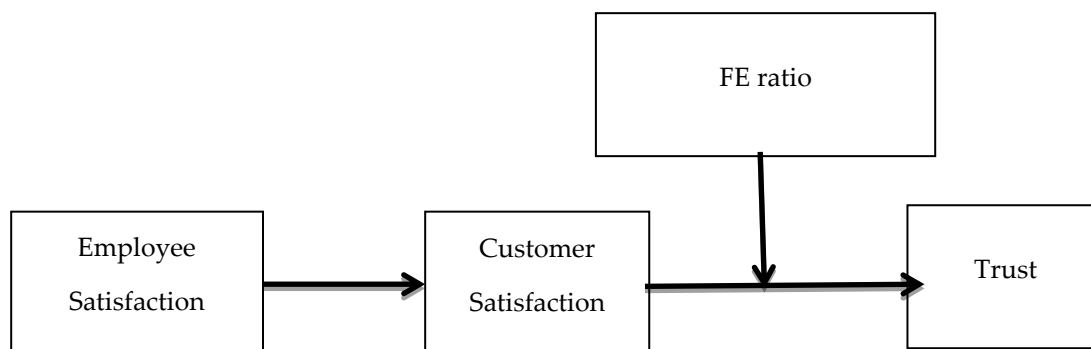

## RESEARCH HYPOTHESIS

All above considered, and consistently with the previous literature frameworks, in order to test our model, we developed the following research hypotheses:

H1: Employee Satisfaction positively influences Trust

H2: Customer Satisfaction mediates the relationship between Employee Satisfaction and Trust

H3: The FE ratio moderates the relationship between Customer Satisfaction and Trust.

## METHOD

In the proposed moderated mediation model (Picture 1) Employee Satisfaction is supposed to impact Customer Satisfaction (path a), which in turn should affect Trust (path b). Further we hypothesized that the link between Customer Satisfaction and Trust would be moderated by the FE ratio: we evaluated the mediation model at (1) *high* (above the average of our sample) and (2) *low* (below the average of our sample) values of the moderator (FE Ratio).

## RESULTS

Overall, without considering the effects of the moderated mediation, Employee Satisfaction positively affect Trust ( $\beta = .27, p < .05$ ). Thus, H1 is confirmed.

However when the effects of mediation (Customer Satisfaction) were considered Employee Satisfaction was no longer significantly related to Trust (path c')  $\beta = .01, p = .93$ . In this moderated mediation model Employee Satisfaction is related to Customer Satisfaction ( $\beta = .45, p < .001$ ), in addition the relation between Customer Satisfaction and Trust is moderated by FE Ratio ( $\beta = .33, p < .05$ ).

Examining the model for high FE Ratio, we found that the higher the Customer Satisfaction the stronger the Trust ( $\beta = .94, p = 0.01$ ). For those Chambers of Commerce with an high FE Ratio, the mediated path was significant  $a*b = 28.01, 95\% CI = 9.55 - 52.29$ ).

Next we examined the model for Chambers of Commerce with low FE ratio. We found that Customer Satisfaction was no longer significantly related to Trust for a low FE ratio ( $\beta = 0.29, p = 0.91$ ). Evaluating the significance of the mediated pathway for those with low FE ratio, customer satisfaction did not significantly mediate the relation between Employee Satisfaction and Trust  $a*b = -.866, 95\% CI = 0.63 - 0.20$ ).

## REGRESSION ANALYSIS

Variable	B	T	p
Employee Satisfaction → Trust (path c)	0.27*	2.10	<.05
Employee Satisfaction → Trust (path c')	.01	.09	.93
Employee Satisfaction → Customer Satisfaction	.45**	3.76	.001
Customer Satisfaction → Trust (moderated by FE Ratio)	.33	2.24	.05

## DISCUSSION AND CONCLUSION

According to Keh et al. (2013), this study so far investigates the link between employee satisfaction and customer trust. We hypothesized that this relationship is mediated by customer satisfaction, as a development of a previous study (Ambrosino and Romanazzi, 2016). Moreover, we also considered the ratio between the number of the firms and the number of the Chamber's employees as a moderator of the relationship between Customer Satisfaction and Trust.

Results show interesting and useful advances and suggestions for both academic and managerial purposes. In fact, results highlighted that without any mediating or moderating factor/effect employee satisfaction positively affects trust (Cho and Park, 2011). This of course suggests that managers should care about the satisfaction of their employees in order to enhance the Chamber of Commerce customer Trust. Despite what we hypothesized in H2, if the mediating effect of Customer Satisfaction is considered, employee satisfaction and trust are no longer so strongly related. This highlights something different to what we found in a previous study (Ambrosino and Romanazzi, 2016) where we just focused on the relationship between Customer Satisfaction and Trust. This could be due also to the different (and smaller) sample of Chambers of Commerce considered.

Finally, we separately examined the model for (1) *high* FE ratio and for (2) *low* FE ratio, because of the not significant results we obtained considering them jointly. Thus, for *high* FE ratio we found that Customer Satisfaction positively affects Trust and the mediated path was significant. While, on the other hand, for *low* FE ratio we found that Customer Satisfaction was no longer significantly related to Trust and also in those cases Customer Satisfaction was found not to mediate the relationship between Employee Satisfaction and Trust.

This should suggest to Chambers' boards of directors and management to take into a very high consideration the FE ratio (congestion of the service) when setting up their policies and strategies: they should be consistently differentiated and *context specific*, on the basis of the significantly different competitive scenario FE ratio could be a signal of.

*Keywords:* employee satisfaction, customer satisfaction, trust, public management, service congestion, citizen satisfaction, moderated mediating model

## REFERENCES

- Alford, J. (2009), *Engaging public sector clients: From service-delivery to co-production*, Palgrave, Basingstoke (UK).
- Bason, C. (2010), *Leading public sector innovation. Co-creating for a better society*, Policy Press, Bristol (England).
- Bouckaert, G., Van de Walle, S., Maddens, B., and Kampen, J. K. (2002), *Identity vs. Performance: An Overview of Theories Explaining Trust in Government*, Leaven (The Netherlands), Katholieke University Leaven, Public Management Institute.
- Bovaird, T. (2007), "Beyond Engagement and Participation: User and Community Coproduction of Public Services", *Public Administration Review*, Vol. 67, No. 5, pp. 846-860.

- Brown S.P., Lam S.K. (2008) "A Meta-Analysis of Relationships Linking Employee Satisfaction to Customer Responses", *Journal of Retailing* Vol. 84 (3, 2008) 243–255
- Brudney, J. L., & England, R. E. (1983), "Toward a definition of the co-production concept", *Public Administration Review*, pp. 59-65.
- Cachon, Feldman, (2011) "Pricing Services Subject to Congestion: Charge Per-Use Fees or Sell Subscriptions?" *Manufacturing & Service Operations Management* Vol. 13, No. 2, Spring 2011, pp. 244–260
- Cho, Yoon Jik, and Hanjun Park. "Exploring the relationships among trust, employee satisfaction, and organizational commitment." *Public Management Review* 13.4 (2011): 551-573.
- Cova, B. and Cova, V. (2012), "On the road to prosumption: marketing discourse and the development of consumer competencies", *Consumption Markets & Culture*, Vol. 15, No. 2, pp. 149-168.
- Ekinci, Y. (2004), "An investigation of the determinants of customer satisfaction", *Tourism Analysis*, Vol. 8, pp. 197-203.
- Fornell, C. (1992), "A National Customer Satisfaction Barometer: The Swedish Experience", *Journal of Marketing*, Vol. 56, No. 1, pp. 6-21.
- Frederickson, H.G. (1996), "Comparing the reinventing government movement with the new public administration", *Public Administration Review*, Vol. 43, pp. 263-270.
- Fryer, K., Jiju, A., and Ogden, S. (2009), "Performance management in the public sector", *International Journal of Public Sector Management*, Vol. 22, No. 6, pp. 478-498.
- Keh, Hean Tat, et al. "The beautiful, the cheerful, and the helpful: The effects of service employee attributes on customer satisfaction." *Psychology & Marketing* 30.3 (2013): 211-226.
- Liljander, V., and Strandvik, T. (1995), "The relation between service quality, satisfaction and intentions", *Managing Service Quality*, pp.45-63.
- Lovelock, C.H. and Young, R. (1979), "Look to consumers to increase productivity", Harvard
- Marlowe, J. (2004), "Part of the solution or cogs in the system?: The origins and consequences of trust in public administrators", *Public Integrity*, Vol.6, No. 2, pp. 93-113
- McLaughlin, K., Osborne, S.P., and Chew, C. (2009), "Relationship marketing, relational capital and the future of marketing in public service organizations", *Public Money & Management*, January, pp.35-42.
- Merlo, O., Bell, S. J., Mengüç, B., & Whitwell, G. J. (2006), "Social capital, customer service orientation and creativity in retail stores", *Journal of Business Research*, Vol. 59, No. 12, pp. 1214-1221.
- Mizrahi, S., Vigoda-Gadot, E., & Cohen, N. (2009), "Trust, participation and performance
- Normann, R. (1991), *Service Management*, John Wiley, Chichester.
- Osborne, S.P., Radnor, Z., and Nasi, G. (2013), "A New Theory for Public Service Management? Toward a (Public) Service-Dominant Approach", *The American Review of Public Administration*, Vol.43, No.2, pp. 135-158.
- Ostrom, E. (1972). Metropolitan reform: Propositions derived from two traditions. *Social Science Quarterly*, 53, 474-493.
- Parasuraman, A., Berry, L. and Zeithaml, V. (1985), "A conceptual model of service quality and its implications for future research", *Journal of Marketing*, Vol. 49, pp. 41-50.
- Parasuraman, A., Zeithaml, V.A., and Berry, L.L. (1988), "SERVQUAL: A Multiple-Item Scale for Measuring Customer Perceptions of Service Quality", *Journal of Retailing*, Vol. 64 (Spring), pp. 12–40.
- Parks, R. B., Baker, P. C., Kiser, L., Oakerson, R., Ostrom, E., Ostrom, V., & Wilson, R. (1981), "Consumers as co-producers of public services: Some economic and institutional considerations", *Policy Studies Journal*, Vol. 9, pp. 1001-1011.
- Pestoff, V., Brandsen, T. and Verschuere, B. (Eds.) (2012), *New public governance, the third sector and co-production*, Routledge, London (UK).
- Reichheld, F. F. (2006), *The ultimate question: Driving good profits and true growth*, Harvard Business Press.
- Seimuskane, L., and Voroslava, M. (2013), "Citizens' trust in public authorities of Latvia and participation paradigm", *European Scientific Journal*, Vol.9, No. 35, pp. 44-59.
- Thom, D.H., Hall, M.A., and Pawlson, L.G. (2004), "Measuring Patients' Trust In Physicians When Assessing Quality Of Care", *Health Affairs*, Vol.23, No.4, pp. 124-132.
- Wang, X.H., and Wart, M.W. (2007), "When public participation in administration leads to trust: An empirical assessment of managers' perceptions", *Public Administration Review*, March-April, pp. 265-278.
- Xue, M. and Harker, P.T. (2002), "Customer efficiency: concept and its impact on e-business management", *Journal of Service Research*, Vol. 4 No. 4, pp. 253-67.

## **AN EXAMINATION OF RESIDENTS' SUPPORT FOR TOURISM DEVELOPMENT: A CASE STUDY IN THE CITY OF YOGYAKARTA**

**Roostika, Ratna**

Department of Management, Universitas Islam Indonesia, Yogyakarta, Indonesia

### **ABSTRACT**

Tourism is recognized as the strategic industry that has created jobs and generated incomes for the nations. Despite its potential, competition in the tourism industry among countries, regions, and cities is escalating due to the scarce resources. A place needs to acquire scarce resources like investments, companies, talented residents, tourists, big events, etc, to remain attractive. The tourism studies have admitted that residents are very important in tourism development because they are the main actors and they participate with tourism in many ways. Residents interact and share their local facilities, services, knowledge and talents with tourists. Residents are also those who receive most impacts from tourism in the long time and thus have more concern on the sustainability of their place. In managing tourism industry, support from the residents is necessary because successful operation and sustainability depend heavily on residents' good-will. Due to the important role of residents, government policies in this sector should be aimed at residents' well being and how tourism stakeholders particularly residents could participate in the development of the tourism industry. The competition between cities also justifies the importance in understanding the factors that may retain the residents to their city. Some studies have used psychological factors such as place attachment and the level of residents' involvement in the tourism sectors. Residents' satisfaction with their life is also factors that call interest among researchers in tourism study in determining their support on tourism development.

This study constructed a model of residents' support for tourism development and its structural relationship with residents' satisfaction, involvement, and place attachments. Using a valid sample size of 179 residents from 14 districts in the city of Yogyakarta, the findings revealed that support for tourism development are influenced by residents' involvement and place attachment. Residents' satisfaction did not affect residents' support. Residents' involvement in tourism influenced both residents' satisfaction and place attachment. Place attachments influenced residents' support on tourism development.

For the governments as well as tourism marketers, knowledge of the perception of residents towards the place they live is vital to the implementation of place and tourism development strategies. When people state "yes, I love to live in this place", this may infer that they may have some memories, attachments, experiences and expectations to the place. This potential should be further explored for

place development. By doing this research, the contributions for the academic are enriching the empirical evidence in Asian context on the role of satisfaction with life, residents' involvement, and place attachments in influencing residents' attitude to support their government strategies/local communities in tourism development. For marketers, governments, and tourism planners, all elements of 'satisfaction with life', 'involvement', and 'place attachments' should be creatively managed so that residents have the sense that their local tourism performance is of because their significant contributions, their life satisfaction would increase if they care with their environment as well as 'the pride' they would receive if their place receives favorable image. While it cannot be denied that different tourism stakeholders view different perspectives from tourism, the priority of tourism development should be placed to the increasing prosperity of the local residents.

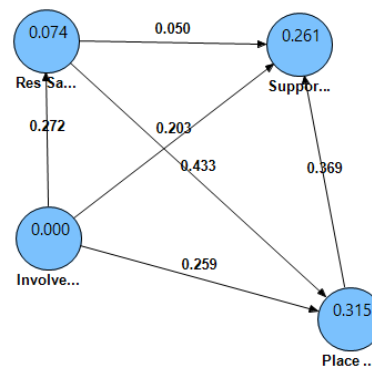

Figure 1. Full model and PLS Results

*Keywords: Support for tourism development, satisfaction with life, residents' involvement, and place attachments*

## REFERENCES

- Allen, L.R., Hafer, H.R., Long, P.T., and Perdue, R.R. (1993). Rural residents' attitudes toward recreation and tourism development, *Journal of Travel Research*, Vol. 31 No. 4, pp. 27-33.
- Azevedo, A.J., Custódio, M.J., Ferreira, M.J., and Perna, F.P. (2013). "Are you happy here?": the relationship between quality of life and place attachment, *Journal of Place Management and Development*, Vol. 6 No. 2, pp. 102-119.
- Guimarães, M.H., Nunes, L.C., Barreira, A.P. and Panagopoulos, T. (2015), "What makes people stay in or leave shrinking cities? An empirical study from Portugal", Working Paper # 592, Nova School of Business and Economics, Universidade Nova de Lisboa, Campus de Campolide, 1099-032 Lisboa, Portugal.
- Gursoy, D. Jurowski, C. and Uysal, M. (2002), "Residents' attitudes: a structure modeling approach", *Annals of Tourism Research*, Vol. 29 No. 1, pp.79-105.
- Insch, A. and Florek, M. (2008), "A great place to live, work and play: Conceptualizing place satisfaction in the case of a city's residents", *Journal of Place Management and Development*, Vol. 1 No. 2, pp. 138-149.
- Ko, D.W. and Stewart, W.P. (2002), "A structural equation model of residents' attitudes for tourism development, *Tourism Management*, Vol. 23, pp. 521-530.
- Nunkoo, R. and Ramkissoon, H. (2011), "Residents' satisfaction with community attributes and support for tourism", *Journal of Hospitality & Tourism Research*, Vol. 35 No. 2, pp. 171-190.

- Royuela, V., Moreno, R. and Vaya, E. (2010), "Influence of quality of life on urban growth: A case study of Barcelona, Spain", *Regional Studies*, Vol. 44 No. 5, pp. 551-567.
- Woo, E., Kim, H. and Uysal, M. (2015). Life Satisfaction and Support for tourism Development, *Annals of Tourism Research*, Vol. 50, pp.84-97.
- Xu, Z. and Zhang, J. (2016), "Antecedents and consequences of place attachment: A comparison of Chinese and Western urban tourists in Hangzhou, China", *Journal of Destination Marketing and Management*, Vol. 5, pp. 86-96.
- Yoon, Y. (2002), *Development of a Structural Model for Tourism Destination Competitiveness from Stakeholders' Perspectives*, unpublished dissertation, Virginia Polytechnic Institute and State University.
- Zenker, S. and Rutter, N. (2014), "Is satisfaction the key? The role of citizen satisfaction, place attachment and place brand attitude on positive citizenship behavior", *Cities*, Vol. 38, pp. 11-17.

## **NETWORKING SMES FOR KNOWLEDGE SHARING: PRELIMINARY EVIDENCES FROM A SURVEY**

**Rossignoli, Francesca**

Departmente of Business Administration, University of Verona, Verona, Italy

### **ABSTRACT**

Previous literature has highlighted that SMEs face particular knowledge sharing challenges and claim that networks allow SMEs to overcome such limitations. Prior studies investigate the role of SMEs as active knowledge participants in networks. Nevertheless, scant empirical evidences are provided about the usefulness of networking among SMEs for knowledge sharing purposes and the literature calls for further investigate such phenomena. This research aims to provide an empirical analysis of whether and how networks enhance the knowledge sharing in SMEs. To this aim the following research question is investigated: how and in what extent networks can enhance knowledge sharing in the SMEs context? The empirical investigation is based on a survey questionnaire submitted to a sample of Italian SMEs. Preliminary empirical evidences about the benefits in term of knowledge sharing from network participation are provided. Beyond the acknowledgment of the importance of network belonging in order to share knowledge, the evidences allow to understand that different type of network serve SMEs for multiple objects and different benefits are achieved depending on the type of network. Opportunities for future research are identified in the field of knowledge sharing in SMEs.

### **BACKGROUND AND PURPOSE**

Despite knowledge is the primary source of competitive advantage for SMEs (Coyte et al., 2012), SMEs have received little research attention from knowledge management literature (Cantù et al., 2009; Massaro et al., 2016). In general, previous management literature has highlighted the need to better understand how SMEs manage knowledge resources (Salojarvi et al., 2005; Ricceri et al., 2010). In particular, recent studies have point out that SMEs face particular knowledge sharing challenges (Zieba et al., 2016; O'Connor et al., 2017).

Networks are seen as tools that allow SMEs in knowledge sharing. Nevertheless, scant empirical evidences are provided about the usefulness of networking among SMEs for knowledge sharing purposes and the literature calls for further investigate such phenomena (O'Connor et al., 2017).

The purpose of this research is to contribute to address these calls providing an empirical analysis of whether and how networks enhance the knowledge sharing in SMEs. To this aim the following



research question is investigated: how and in what extent networks can enhance knowledge sharing in the SMEs context?

## RESEARCH METHOD

This study relies on a quantitative methodology based on a survey aimed at gathering data by means of closed-ended questions structured in a standard questionnaire layout. The survey has been conducted on firms located in North East Italy. We selected SMEs according to the definition provided by the European Commission and included in the sample companies 'which employ fewer than 250 persons and which have an annual turnover not exceeding EUR 50 million, and/or an annual balance sheet total not exceeding EUR 43 million'. We excluded microenterprises with less than 10 employees and less than EUR 2 million annual turnover and/or annual balance sheet. SMEs were contacted via email at their institutional e-mail address, to the concern of the entrepreneur and/or top managers.

We submitted the questionnaire to 1,674 firms and we received 411 completed questionnaires with a response rate of 25%. The responding firms reported their views about knowledge sharing in network, specifying whether or not they belong to a network of companies.

The first section collects information about the entity's participation to network (currently or in the past) and the description of such network. The following sections are restricted to companies that currently belong to a network or have participated in a network in the past. The second section investigates the objectives pursued belonging to a network. The last section captures both the benefits and the difficulties emerging from the network participation. The responses to each question are based on a Likert scale ranging from 1 (strongly disagree) to 5 (strongly agree). A descriptive analysis was elaborated to draw the preliminary findings exposed in the next section. Further multivariate analysis are currently in progress.

## PRELIMINARY FINDINGS

The respondents recognize the importance of networks (37.90%) for knowledge sharing, regardless their participation (current or past) in networks. This is confirmed by the acknowledgment that they need to join with other companies (42.74%) in order to overcome their knowledge limitations. Most of the respondents (60%) has an experience (current or past) as network participants: 55.56% of them are placed at a different point in the value chain, while 44.44% of them belong to complementary networks.

The respondents claims that among the reasons of the aggregation there is a willingness to share knowledge. In particular, network is considered an essential tool to overcome the limitations related to knowledge and its dissemination. Thanks to knowledge sharing respondents claim that were able

to develop new products (2.67%), new commercial policies and the entry into new markets (4.00%). Respondents conceive networks as a means through which they can: access knowledge not obtainable individually (11.11%), produce goods and services not achievable individually (33.33%), promote innovation, research and development (22,22%) and access to distribution channels (22,22%).

Sharing of information within the network is made with different types of subjects, and it is influenced by the type of network to which the SMEs belong: supply chain network or complementary network. Specifically the SMEs share knowledge primarily with suppliers (45.97%), with customers (37,90%), with other companies in the sector belonging to the network (35,48%) and complementary enterprises (20,97 %).

## **CONTRIBUTIONS AND FUTURE RESEARCH**

The findings show that networks enhance knowledge sharing that provides benefits to partners related to learning, to develop innovation capabilities and to improve efficiency. In the following, the findings are discussed according to the Möller et al. (2005) taxonomy, that classifies the type of networks according to three dimensions: benefits of knowledge sharing, types of relations among network partners and network goals.

Benefits in terms of knowledge sharing are pursued in terms of both acquisition of explicit knowledge and of dissemination and deployment of tacit knowledge in order to merge different competencies and to develop new vision and strategy. The relations established within the network involve different subjects such suppliers, complementary companies in the sector, competitors and others, both vertically and horizontally integrated with the SMEs. The goals pursued by participants overcome customer satisfaction and are also configured on R&D, promotion and innovation, access to resources and learning and exploitation of know-how.

All this considered, the evidence show that SMEs participants are engaged in “enhancing network”, despite the literature affirms that most SME networks are mainly hierarchical supply-chain networks established to sustain client satisfaction, where the knowledge sharing is limited to the distribution of explicit knowledge (Valkokari and Helander, 2007).

Opportunities for further research in this area emerge. The research is contributing to the attempts to capture how network belonging allow SMEs to share knowledge. Further research could measure the performance outcomes of belonging to networks and investigate relations between the types of network and the benefits gathered on knowledge incremental.

## **ACKNOWLEDGEMENTS**

I would like to thank the Fondazione Studi Universitari di Vicenza and the Polo Scientifico Didattico Studi sull'Impresa (University of Verona) for their support and funding. This research was part of the "Filiere e Network: i nuovi ambiti di azione delle imprese" (Supply chain and network: new companies' scope of action) research project.

*Keywords: SMEs; Network; Knowledge sharing; Survey*

## REFERENCES

- Cantù, L., Criado, J. and Criado, A. (2009), "Generation and transfer of knowledge in IT-related SMEs", *Journal of Knowledge Management*, Vol. 13 No. 5, pp. 243-56.
- Coyte, R., Ricceri, F. and Guthrie, J. (2012), "The management of knowledge resources in SMEs: an Australian case study", *Journal of Knowledge Management*, Vol. 16 No. 5, pp. 789-807.
- O'Connor, C., Kelly, S., (2017), "Facilitating knowledge management through filtered big data: SME competitiveness in an agri-food sector", *Journal of Knowledge Management*, Vol. 21, No.1, pp. 156-179.
- Massaro, M., Handley K., Bagnoli C., Dumay D., (2016), "Knowledge management in small and medium enterprises: a structured literature review", *Journal of Knowledge Management*, Vol. 20, No. 2, pp. 258-291.
- Möller, K., Rajala, A. and Svahn, S. (2005), "Strategic business nets – their type and management'", *Journal of Business Research*, Vol. 58 No. 9, pp. 1274-84.
- Ricceri, F., Guthrie, J. and Coyte, R. (2010), "The management of knowledge resources within organisational practices: some international best practice illustrations", in O'Brien, E., Clifford, S. and Southern, M. (Eds), *Knowledge Management for Process, Organisational and Marketing Innovation: Tools and Methods*, IGI Global, Pennsylvania, PA, pp. 36-61.
- Salojarvi, S., Furu, P. and Sveiby, K.E. (2005), "Knowledge management and growth in Finnish SMEs", *Journal of Knowledge Management*, Vol. 9 No. 2, pp. 103-22.
- Zieba, M., Bolisani, E., and Scarso, E. (2016) "Emergent approach to knowledge management by small companies: multiple case-study research", *Journal of Knowledge Management*, Vol. 20 No. 2, pp. 292-307.

## KINDNESS, FRED VERSUS NIC: MACHIAVELLIAN LEADERSHIP IN THE 21<sup>ST</sup> CENTURY

Rowland, Caroline<sup>1</sup>; Thomas, Mike<sup>2</sup>

<sup>1</sup>Business School, University of Central Lancashire, Preston, UK

<sup>2</sup>Executive Management, University of Central Lancashire, Preston, UK

### ABSTRACT

*“Three things in human life are important; the first is to be kind; the second is to be kind; and the third is to be kind.” - Henry James, as quoted in Edel, Henry James a Life, Vol V: The Master 1901 -1916 (1972)*

Much has been written concerning leadership styles and practice (Bass and Bass, 2008). It is widely accepted that leadership has a crucial role in both the success of organizations and also in the wellbeing of society. Hence, leadership takes a central role in the public affairs agenda (Cameron, 2011; Thomas and Rowland, 2013). Little has been explored in relation to kindness and leadership yet poor relationships between leaders, managers and others is a major barrier to performance, wellbeing, and wealth creation (Robertson and Cooper, 2011; Rowland and Hall, 2013). This research reviews and investigates the role that kindness may play in establishing good management practice within organizations. It discusses the role of compassion and kindness in both past and current leadership theory and practice and whether these attributes have value in sustainable models.

In particular our work focusses on two opposing leadership philosophies: those of Niccolo Machiavelli (1988) and Frederick the Great of Prussia (1988). The original work by Machiavelli dates from 1532 and the work by Frederick dates from 1740 yet both their works remain in print and the impact of their beliefs still inform management and leadership practice today. Many leaders and managers have adopted Machiavellian strategies. Manipulation often by fear was his preferred model for leadership because he believed that fear was a much more reliable motivator than respect or affection. He stated unequivocally that it was better for a leader to be feared than loved. In 1740 Frederick published his essay “Anti-Machiavel” Frederick’s standpoint was very different. He argued that expediency was not morally right and that leaders should be both rationale and humane. He was highly critical of Machiavelli’s model (1988) which he suggested was leadership based on manipulation and fear and he proposed an alternative model based on kindness and mercy. Although his work is not as well-known as Machiavelli’s in terms of modern leadership he provides more insight into the motivation of people and the complexity of behaviours resulting from altruism and belonging rather than pure self-interest.

The methods used in this research were mainly based on the interrogation of literature. This paper mainly comprises a systematic review of published works on leadership focusing on the concept of kindness. The paper reviews a sample of published management works using concept analysis

methodology to evaluate leadership characteristics and explore the concept of grace with its attributes of kindness and compassion. The sources yielded a total of 2,096 references and 3,016 identified interviews over a 15 year period. Direct observations by the authors and two small employer and employee purposive focus groups were also employed to gather data.

Initial findings were interesting and indicated that there was conceptual confusion regarding the definition of compassion and its application in leadership practices. Kindness is not discussed within the concept of compassion and kindness itself may be viewed as a weakness in contemporary self-selected leadership characteristics. Very few of the books and journals reviewed referred to kindness at all. Kindness does seem to have a positive energising effect, on both the kind individual and the recipient which does seem to have other benefits. Maslow, (1971) Fredrickson, (2009) and Algoe and Haight, (2009) all observed that when individuals observe acts of virtuous kindness then that appears to instigate feelings of compassion which creates improved inter-personal relationships and reinforces good deeds that drive and further reinforce more kindness behaviours. Armstrong, (2015) found that in a business or organizational environment, more compassionate staff were happier and more engaged with work, were more willing and able to foster teamwork and kept customers longer and better satisfied with the service. Research reported by Krakovsky, (2013) found that kind, generous and compassionate personalities are attracted to organizations that match their own personal values but inauthentic acts of kindness for the individuals own personal benefits are soon observed by working colleagues with a negative impact on working relationships. This is definitely a reaction against the instrumental acts of self-serving generosity advocated in Machiavelli's Prince. Barsade and O'Neill, (2016), found a similar result with employees who were kind anyway gaining extra performance motivators from working in an organisation which shared their values

Conclusions suggest that there is disconnect between contemporary models of leadership and calls for sustainable ethical leadership in the spheres of public and business environments. Compassion and kindness remain in the side-lines yet the implications for future trust and commitment are neglected in times where discretionary effort of workers and volunteers is crucial to goal achievement. Leaders have to spend more of their pressured time communicating and negotiating with staff to gain a wider acceptance and understanding of management practices which attempt to bring certainty in uncertain times. It is easier to spend less precious time by instigating hierarchical processes and procedures. This approach ignores major elements of pragmatic kindness and may be counter-productive. Signs such as curtailed meetings, curt emails, no discussion time, lack of humour, the reliance of process over interactions and spending less time receiving messages rather than giving them suggest leadership and kindness fatigue rather than a more efficient organization.

This research contributes to knowledge and understanding in a neglected area of international management discourse. In terms of practice it enables organizations to now appreciate the benefits of kindness by leaders in terms of both the “bottom line” and good citizenship. Consequently it may represent a step back to the future of less Machiavellian manipulation by leaders and result in organizational policies of more Frederickian kindness.

*Keywords: Leadership, Kindness, Pragmatism, Grace, Compassion, Machiavelli*

## REFERENCES

- Algoe, S.B. & Haight, J. (2009), “Witnessing excellence in action: The other-praising emotions of elevation, gratitude and admiration”, *Journal of Positive Psychology*, 4, pp. 105-127
- Armstrong, A. (2015), *Compassion at Work – what’s your business case?* [www.hrzone.com/engage/managers/compassion](http://www.hrzone.com/engage/managers/compassion) downloaded 01/04/2016.
- Aristotle (1999), *Nicomachean Ethics*, (Trans. Oswald, M.) Prentice Hall, Saddle River, NJ.
- Barsade, S. & O’Neill, O.A. (2016), “Manage your emotional culture.” *Harvard Business Review*, Jan/Feb 2016 Issue. <https://br.org/2016/manage-your-emotional-culture> downloaded 05/02/2017
- Bass, B. and Bass, R. (2008) *The Bass Handbook of Leadership* (4th Revised edition), The Free Press, London.
- Cameron, K. (2011), “Responsible leadership as virtuous leadership”, *Journal of Business Ethics*, 98, pp.25-35.
- Frederick II of Prussia, (1981), *The refutation of Machiavelli’s Prince: or Anti-Machiavelli*, (Transl. P. Sonnino), Ohio University Press, Ohio.
- Frederickson, B.L. (2009), *Positivity*. Crown, New York
- Krakovsky, M. (2013) *The psychology of kindness in the workplace – Stanford Grad School Business*, downloaded 02/00/2017.
- Machiavelli, N. (1988), “*The Prince*,” (Transl. G. Bull), Penguin Classics, London.
- Maslow, A. (1971), *The Farthest Reaches of Human Nature*. Viking, New York
- Robertson, I. T., & Cooper, C. L. (2011), *Well-being: Productivity and happiness at work*, Palgrave Macmillan, Basingstoke.
- Rowland, C. A. and Hall, R. D. (2013), “Organizational Justice and Performance; Is Appraisal Fair?” *EuroMed Journal of Business*, Vol. 7, No.3, pp.280-293.
- Thomas, M. & Rowland, C. (2014), “Leadership, pragmatism and grace; A Review.”, *Journal of Business Ethics*, Vol. 123, Iss.1, pp.99-111.

## THE ADOPTION OF ACCRUAL ACCOUNTING IN THE PUBLIC SECTOR: A CASE WITHIN ITALIAN UNIVERSITIES

Rupo, Daniela<sup>1</sup>; Loprevite, Salvatore<sup>2</sup>; Sidoti, Salvatore<sup>1</sup>

<sup>1</sup>Dept. Economics, University of Messina, Italy

<sup>2</sup>University "Dante Alighieri", Reggio Calabria, Italy

### ABSTRACT

Traditionally, the public sector adopt cash-based accounting systems, whose limitations have been broadly highlighted in literature, as they not provide the information that is necessary for a government to operate efficiently and effectively. The potential offered by the accrual accounting, that allows the measurement of economic results and of the assets and liabilities of the public entity, is the main reason behind the choice adopted by a growing number of countries that have decided to shift from cash-based to some form of accrual accounting in the public sector. The introduction of accrual accounting aims to improve the quality of information in terms of usefulness for decision-making, and to increase accountability and responsibility of public choices.

Relevant implications of the accrual accounting implementation in public entities are emerging in the perspective of budgeting and reporting, which ask for integrated information systems, in order to ensure the availability of useful information for decision making and for external stakeholders.

The paper intends to focus the attention on the adoption of accrual accounting in the context of public Italian universities, which become mandatory following Legislative Decree no. 18/2012, starting from 2015.

Moving from a practical experience at the University of Messina, the paper presents a case study as the result of close relationship between knowledge acquisition and action ("action research").

The findings of the research outline some arguments about advantages and drawbacks of the actual implementation of accrual accounting, in the ongoing evolution of the legal framework in the field investigated. At the present stage, in fact, whereas universities are experiencing the first time adoption of consolidated financial statements, they cannot still refer to clear rules and accounting principles. Moreover, the coexistence of cash based accounting, for the purposes of external reporting with the central government, provokes perplexity and requires further efforts in the direction of assuring reliable and coherent information for different users.

### REFERENCES

Anselmi L., Pavan A. & Reginato E. (2012), "Cassa, competenza finanziaria e competenza economica: la scelta delle basi contabili in un sistema armonizzato di contabilità pubblica", Azienda Pubblica, vol. 25, 1, Maggioli Editore, Rimini, pp. 53-68.

- Bento R., & Pereira M., Gomes R. (2013), "International Experiences with Accrual Budgeting in the Public Sector", *Revista Contabilidade & Finanças – USP*, São Paulo, v. 24, n. 62, 103-112.
- Bovaird T. & and Elke Löffler E. (edited by) (2009), *Public Management and Governance*, Second Edition. London, New York: Routledge.
- D'Alessio, L. (2012), "Logiche e criteri di armonizzazione nelle recenti normative di riforma della contabilità pubblica", *Azienda Pubblica*, 25 (1), pp. 23-40.
- Guthrie, J. (1998), "Application of accrual accounting in the Australian public sector: Rethoric or reality?", *Financial Accountability and Management*, 14(1), 1998, pp.1-19.
- Hassan M.M. (2015), "Transformation to more accrual-based accounting practices in Indonesian Government", *Journal of International Business Research*, Volume 14, Number 1, 139-165.
- Hood, C. (1991), "A Public Management for All Seasons?", *Public Administration*, 69, 3-19.
- Lapsley, I., Mussari, R. & Paulsson, G. (2009), "On the Adoption of Accrual Accounting in the Public Sector: A Self-Evident and Problematic Reform", *European Accounting Review*, Vol. 18, No. 4, 719-723.
- Mussari, R. (2012) "Brevi considerazioni sui mutamenti in atto nei sistemi di contabilità pubblica", *Azienda Pubblica*, vol. 25, 1, Maggioli Editore, Rimini, pp. 11-22.
- Mussari R. & Sostero U. (2014), "Il processo di cambiamento del sistema contabile nelle università: aspettative, difficoltà e contraddizioni", *Azienda Pubblica*, vol. 27, 2, Maggioli Editore, Rimini, pp. 125-147.
- OECD (2016), "Accrual practices and reform experiences in OECD countries – Results of the 2016 OECD Accruals Survey", *OECD Journal on Budgeting*, Vol. 1.
- Olson, O., Humphrey, C. & Guthrie J. (2001), "Caught in an evaluatory trap: a dilemma for public services under NPFM", *European Accounting Review*, 10, 3, pp. 505-522.
- Osborne, S.P. (2010), *The new public governance: Emerging perspectives on the theory and practice of public governance*. London and New York: Routledge.
- Paolini, A. & Soverchia M. (2015), "La programmazione delle università italiane si rinnova: riflessioni e primi riscontri empirici", *Azienda Pubblica*, 3, Maggioli Editore, Rimini, pp. 287-308.
- Pozzoli M. & Mazzotta R. (2012), "Un processo di armonizzazione che mortifica la contabilità pubblica", *Azienda Pubblica*, vol. 25, 1, Maggioli Editore, Rimini, pp. 69-82.
- Ricci, P. (2012), "Il potenziale impatto delle nuove disposizioni contabili sui comportamenti aziendali e sul sistema economico", *Azienda Pubblica*, vol. 25, 1, Maggioli Editore, Rimini, pp. 41-52.
- Rupo, D. (2014), *L'introduzione della contabilità economico-patrimoniale nelle università. Principi e logiche contabili nella fase transitoria*, Aracne Ed., Roma.
- Tieghi, M & Gigli, S. (2015), "L'introduzione della Contabilità Economico-Patrimoniale negli Atenei: un commento su alcune opzioni esercitate e alcune possibili proposte di miglioramento", *Azienda Pubblica*, 1, Maggioli Editore, Rimini, pp. 13-31.
- Trequattrini, R; Nappo, F. & Lardo, A. (2015), "Accrual Accounting in the Italian Higher Education System: A Case Study", *Administration and Public Management*, 24, pp. 6-25.
- Van Der Hoek, M. P. (2005). "From Cash to Accrual Budgeting and Accounting in the Public Sector: The Dutch Experience", *Public Budgeting & Finance*, Spring, 32-45.



## PERCEIVING DESTINATION QUALITY ON THE LEVEL OF THE ORGANIZATION/TOURISM SERVICE PROVIDER

Ryglova, Katerina<sup>1</sup>; Rasovska, Ida<sup>2</sup>; Králíková, Andrea<sup>1</sup>; Stojarova, Sarka<sup>1</sup>; Sacha, Jakub<sup>3</sup>;

<sup>1</sup>Department of Marketing and Trade, Faculty of Business and Economics, Mendel University in Brno, Czech Republic

<sup>2</sup>Department of Management, Faculty of Business and Economics, Mendel University in Brno, Czech Republic

<sup>3</sup>Department of Statistics and Operation Analysis, Faculty of Business and Economics, Mendel University in Brno, Czech Republic

### ABSTRACT

The paper briefly summarizes the results of the research analyzing the viewpoints of tourism service providers in the Czech Republic concerning the quality in the destination. Principal quality factors of the destination are revealed, their importance is defined and the dependency of perceiving quality factors importance on the type of the provider, on overall destination quality evaluation or on the existence of destination management is examined. Primary data were obtained through a questionnaire survey with the quota selection of respondents. The nineteen research factors were designed on the basis of contemporary theories and on the qualitative research. Within the discussion the findings are compared with a similar research that focuses on the client/visitor to the destination and then the main discrepancies/gaps in perceiving the quality between offer and demand are determined. The visitors and the service providers in the destination agree on security to be the most important quality factor of the destination. The cleanliness of the destination is the second most important factor for the visitors whereas the service providers consider it to be the eighth most important factor and they have classified the quality level of the personnel to be the second. The obtained results can contribute to more efficient destination management and they are the part of the long-term research aimed at evaluating destination quality.

### INTRODUCTION

So far, the quality of services in the Czech Republic has been one of the areas that evinces insufficiencies and in the long term its level is perceived to be lower – especially by foreign visitors. Mainly in regions big differences in the qualitative level of offered services can be observed. This reality is supported by the fact that almost two thirds of foreign tourists visit Prague only and they do not go to other regions. Quality is currently one of the priorities of the Conception of State Politics of Tourism for the period 2014-2020. For successful tourism management by means of increasing quality level in the destination it is important to be aware of not only the viewpoint of demand – wishes, needs and the perception of the performance itself by the client of the tourism service/the visitor to the

destination – but it is also inevitable to know the offer side – the possibilities and the specific quality perception from the viewpoint of tourism service providers themselves in the destination. The gap model was theoretically developed by Parasuraman, Zeithaml and Berry (1985, 1988). It is based on the presumption that the customer's satisfaction reflects the difference between his or her expectation and perception of the obtained service level. In case of positive gap we talk about a satisfied customer, in other words the customer's expectations have been fulfilled or the customer has even obtained more than he or she expected. If the client's ideas and expectations have not been fulfilled, so called negative gap develops and the client probably acquires an impression that he or she has not obtained an adequate level of service for his or her money. The gap model is divided into two mutually interactive levels – these are a service provider level and a customer level – and it works with five contradictions that can cause the customer's dissatisfaction. The foundation of the model is the presumption that the basic contradiction gap 5 between the perceived and expected quality is a function of four partial contradictions that can emerge during the process of planning and providing the service. In order to eliminate this most significant customer gap (gap 5) the company needs to close all the other gaps on the service provider's side, which means from gap 1 up to gap 4 (Zeithaml, Bitner, 2000). The results of the long term research conducted by the authors focusing on destination quality management in the Czech Republic through gap 5 analysis have shown many negative contradictions (Ryglova et al., 2015, 2016; Rasovska et al., 2016; Stojarova, 2016), therefore it is inevitable to analyse other possible gaps and causes that induce the negative results of the principal customer gap. The text presents the results of the research that focuses on service providers and it identifies the gap 1 mentioned above that results from different images of customers and management/service providers.

## **METHODOLOGY, RESEARCH DESIGN AND DATA ANALYSIS**

The 19 research destination quality factors used in the survey were chosen on the base of the theoretical and scientific research and models related to quality destination (Buhalis, 2003; Middleton and Clarke, 2001; Woods and Deegan, 2003; Grönroos, 2007) and own previous qualitative and quantitative research. Primary data were gained by means of questionnaire survey among 343 tourism service providers operating in the Czech Republic during 2016. The quota sampling has been used, based on organization/firm size and type of offered tourism services (characteristics published by the Czech Statistical Office and Eurostat for the year 2014). For testing the dependency of the results/the importance of the factors on the selected characteristics of respondents the Chi-squared test in the contingent table was used. For the gap 1 analysis the secondary data from the previous authors'

research were used – the same factors from the viewpoint of demand were examined there (n=1097; Ryglova et al., 2015).

## RESULTS, DISCUSSION AND CONCLUSIONS

According to the service providers, the most significant factors of destination quality are the sense of security (F14, average evaluation 4.50 on the five-point scale), the quality level of personnel in tourism services (F13; 4.46) and natural attractions (F1; 4.45). On the other hand, the least important factor for the service providers was local transportation (3.08) followed by additional infrastructure (3.14). The differences in perceiving the significance of individual factors according to the type of tourism service provider can be seen in picture 1.

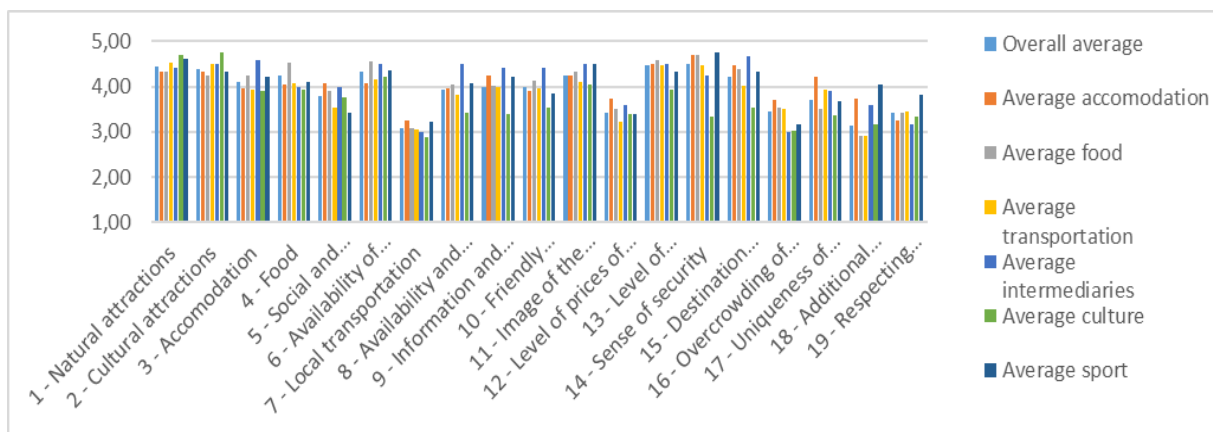

Picture 1 – Quality factors significance according to the type of service provider; n = 343; scale questions: 5 is the most important factor

The dependency of perceiving the significance of individual factors on the type of business was confirmed on the 5% significance level in case of 13 factors out of the 19 evaluated ones. The strongest dependency was shown in case of the sense of security factor, which means that partial branches of tourism perceive the importance of security factor for the client in different ways; for instance, the mediators/cultural service organizers do not consider this fact to be important and place it on only the 15th position out of all the evaluated factors. The perception of the importance of 10 factors depends on the total evaluation of the destination quality. The strongest dependency was confirmed for the factor of the atmosphere in the destination/friendly acceptance by the locals. In case of 6 factors the dependency of the destination quality factors on the destination management performance in the area was confirmed on the same level of significance. For the three most important factors (F14, F13, F1) the dependency on the type of the service provider was confirmed, whereas the dependency on the overall evaluation of the destination was confirmed for factor F13 only: the quality level of personnel. The dependency on destination management performance was not confirmed in case on any of these

factors. In the picture below the values as well contradictions (gap 1) in perceiving the significance of individual destination quality factors between the provider and the consumer/client of tourism in the destination can be followed concurrently.

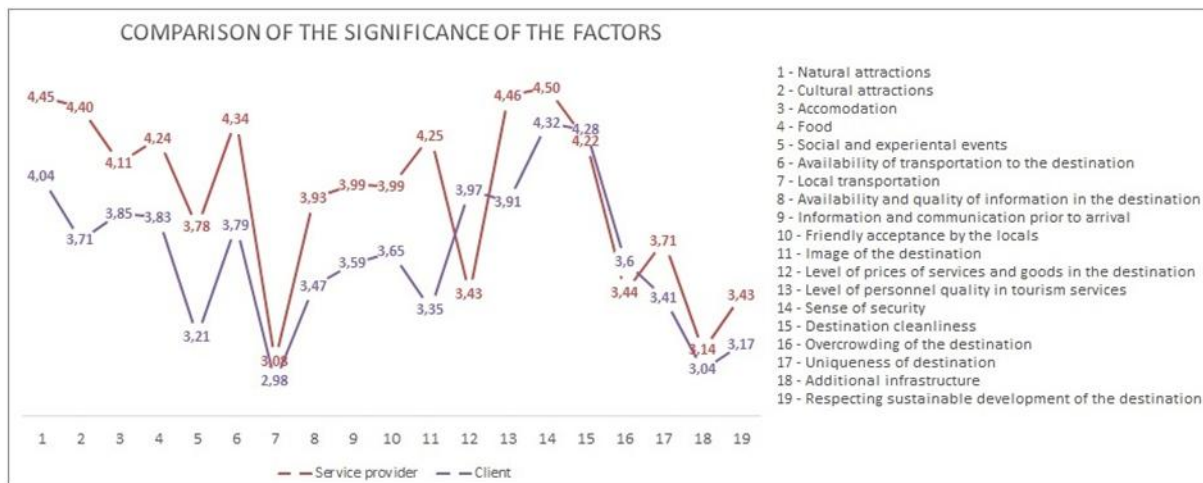

Picture 2 – the comparison of the factor significance evaluation between the service provider and the client (gap 1); Service providers: n = 343; clients/visitors: n = 1097

In most cases the service providers assign higher importance to individual quality factors than the clients do. The positive gap 1 is on average 0.3 points higher and the biggest difference can be seen in case of the factor of image where the provider assigns this factor with 0.9 point higher evaluation of significance than the client. This difference can be also observed in case of the order of individual factors importance when the image of the place is the 6<sup>th</sup> most important factor for the providers while for the clients it only takes the 15<sup>th</sup> position (Ryglova et al., 2015). The negative gap 1 that can be one of the stimuli causing the clients dissatisfaction emerges for three factors: F12, F15 and F16. The service providers do not fully appreciate the significance of the factors for their clients in case of the following factors: the level of prices of services and goods in the destination (F12, gap 1 = -0.54), the destination cleanliness (F15, gap 1 = -0.06) and the overcrowding of the destination (F16, gap 1 = -0.16). At the same time all these factors occupy higher positions in the order of all 19 factors from the client's point of view; F15 is the second, F12 is the fourth and F16 is the 11<sup>th</sup> most important factor for the client. To reveal the causes of such lower satisfaction of the visitors to the destination with its quality in more detail it would be necessary to examine other gaps emerging during the process of service realization on the provider's side as well.

The obtained results can contribute to more efficient destination management and marketing in general and they are the part of the long-term research aimed at evaluating destination quality. The revealed key factors of quality and their importance can simplify the application of scientific methods for example SERVQUAL or IPA analysis. The findings can also serve as input data for these methods

that enable the evaluation of the actual qualitative level of the destination by means of customer satisfaction. Last but not least the research findings with revealed gaps in perception of the quality among clients and providers contribute to broadening the current studies with the destination quality and to better understanding of the behavioural mechanism and can be used by services providers to increase the efficiency of quality management to improve their competitiveness.

## ACKNOWLEDGEMENTS

The results presented in this paper are part of the project No. 15-21179S „The Quality Evaluation of Tourism Destination “, which is conducted with support of Grant Agency of the Czech Republic.

*Keywords: tourism; destination quality factors; service provider’s perception; consumer’s perception, gap analysis*

## REFERENCES

- Buhalis, D. (2003), “eTourism: information technology for Strategic Tourism Management”, Prentice Hall, London.
- Grönroos, C. (2007), “Service Management and Marketing: Customer Management in Service Competition”, John Wiley & Sons, New York, NY.
- Middleton, V. T. C., Clarke, J. R. (2001), “Marketing in Travel and Tourism”, Butterworth-Heinemann, Boston.
- Rasovska (Vajcnerova), I., Ryglova, K., Sacha, J. (2016), “The dimensions and quality factors in urban destinations”, Czech Hospitality and Tourism Papers. 27/2016.
- Ryglova, K., Vajcnerova, I., Sacha, J., Stojarova, S. (2015), "The Quality as a Competitive Factor of the Destination", Conference BEM Procedia Economics and Finance, Vol. 34, pp. 550-556.
- Ryglova, K., Vajcnerová (Rasovska), I., Sacha, J. (2016), “Destination Quality Perception in the Context of Different Behavioural Characteristics of Visitors”, Czech Journal of Tourism, 5(1), pp. 5-20.
- Stojarova, S., Sacha, J., Ryglova, K., Vajcnerova (Rasovska), I. (2016), “The Influence of Chosen Characteristics of Social Status on Consumer's Perceptions of Destination Quality Factors”, in Euromed 9th Annual Conference of the EuroMed Academy of Business Innovation proceedings, Warsaw, Poland, 2016, pp. 1759-65.
- Woods, M., Deegan, J. (2003), "A Warm Welcome for destination quality brands: the example of the Pays Cathare region", International Journal of Tourism Research, Vol. 5, No. 4, pp. 269–282.
- Parasuraman, A., Zeithaml, V. A., Berry L. L. (1985), “A Conceptual Model of Service Quality and Its Implications for Future Research”, Journal of Marketing, 49(4), pp. 41-50.
- Parasuraman, A, Ziethaml, V.A., Berry, L.L. (1988), "SERVQUAL: A Multiple- Item Scale for Measuring Consumer Perceptions of Service Quality”, Journal of Retailing, Vol. 62, no. 1, 1988, p. 25.
- Zeithaml, V. A., Bitner, M. J. (2000), “Service Marketing: Integrating Customer Focus across the Firm”, New York: McGraw-Hill, 576 p.

## **EXAMINING THE IMPACT OF EMPLOYEE SOCIAL MEDIA USAGE ON EMPLOYEE WORD OF MOUTH: THE ROLE OF BONDING SOCIAL TIES**

**Sakka, Georgia**

University of Nicosia, Nicosia, Cyprus

### **ABSTRACT**

Social Media (SM) are public e-platforms that enable users to interact in various ways and forms. According to Doyle et al. (2015) are divided into six categories such as blogs, content communities, collaborative projects, micro blogs and social networking sites (SNSs) that considered to be the most widely used category. A considerable number of studies during the last years are researching the way that these online platforms impact people's live and behavior. This study will try to identify the way that employee SM social usage is affecting contemporary workplaces, by specifically examining their affect on the workplaces bonding social ties such as workplace friendship, teamness and socio-emotional support; plus researching its implications to employee WOM. This is because SM does not only impact employee's ties and relationships but also transform essential organizational constructs. The main purpose of this study is to develop a framework that will help organizations to confront the possible negative implications of employee SM usage in the workplace, and to take advantage of the positives for enhancing the social capital ties of the organization and for pursuing positive WOM.

### **LITERATURE REVIEW AND GAP**

SM researchers underline the need for additional research in the area mostly because the research results around SM employee usage seem to be contradictory (Schmidt et al., 2016; Kluember et al, 2016; Men and Muralidharan, 2017; Hanna et al., 2017). While there are studies identified negative impact for organizations and employees such as misbehavior and harassment in the workplace (Mac Donald and Thompson, 2016), there are others showing benefits such as employee productivity (Fraser and Dutta, 2008). Therefore it is argued that further research should examine the employee SM usage for identifying more clearly the implications for organizations, in order to take the necessary actions for reaching possible benefits and overcoming drawbacks (Kluember et al, 2016; Men and Muralidharan, 2017; Hanna et al., 2017).

Conferring also on the role of workplace social capital and SM, foregoing research principally examined quantitatively its effect on employees and organizations (e.g. Ali-Hassan et al., 2015), and mainly by focusing solely on bridging social capital instead of bonding (Xerry and Brunetto, 2010; Pinho, 2013; Kwahk and Park, 2015). In connection to this, there is also a debate on the issue if workplace bonding social ties are affected by the employee SM usage (Bargh and McKenna, 2004;

Ellison et al., 2007, Li and Chen, 2014; Neves, 2015). In responding to this research gap, this study will research qualitatively the way that SM employee usage affects the bonding ties of an organization. Further to this, it will also try to examine how it affects employee WOM through employee satisfaction. Previous research focused on the students' SNSs usage, users' relational social capital and electronic WOM (eWOM) and underlined the need for further research to connect SM usage with bonding social capital for identifying possible marketing advantages (Choi and Scott, 2012; Thoumrungroje, 2014). It has been suggested that positive WOM and eWOM could work as a mechanism for developing positive employee advocacy as an important marketing tool (Harris and Ogbonna, 2013; Huotari et al., 2015). This study will contribute to this aspect.

## METHODOLOGY

The rationale of following qualitative research approach in this study is twofold. At first this approach is more appropriate for examining the sensitive bonding constructs included in this study such as socio-emotional support and friendship and secondly it will help the researcher to obtain a deeper picture of the phenomenon. Therefore the chosen data gathering technique for this study is depth semi-structured interviews and the sample chosen technique is the purpose sampling. The key informants that will take part in the research will be selected according to a purposive sampling criterion: the frequent use of any type of SM for social interaction with colleagues. Further as the preliminary framework of this study will be tested in the tertiary education in Cyprus, 30 interviews will be conducted including the eight recognized universities of Cyprus (according to the Cyprus Ministry of Education and Culture). This number is expected to be sufficient for reaching the required data (Creswell, 2007; Saunders et al., 2012). However the exact number of interviews will depend on the theoretical saturation that the researcher will follow (based on Eisenhardt, 1989). The university sample will include both administration and faculty members. Lastly, the interview questionnaire will include open-ended questions. The primary research of this study will take place at the beginning of 2018 and the results will be published thereafter.

*Keywords: Social Media (SM), employee social media usage, workplace social capital, workplace social bonding ties, word of mouth (WOM), Human Resource Management (HRM).*

## REFERENCES

- Ali-Hassan, H., Nevo, D. and Wade, M. (2015), "Linking dimensions of social media use to job performance: The role of social capital", *Journal of Strategic Information Systems*, Vol. 24, pp. 65-89.
- Bargh, J., and McKenna, K. (2004), "The Internet and social life", *Annual Review of Psychology*, Vol. 55(1), pp. 573-590.

- Choi, J.H. and Scott, J.E. (2012), "Electronic Word of Mouth and Knowledge Sharing on Social Network Sites: A Social Capital Perspective", *Journal of Theoretical and Applied Electronic Commerce Research*, Vol 8(1), pp. 69-82.
- Creswell, J. (2007), *Qualitative inquiry and research design: Choosing among five approaches*, Thousand Oaks, Calif.: Sage Publications.
- Doyle, C., Sammon, D. and Neville, K. (2015), "Building an evaluation framework for social media-enabled collaborative learning environments (SMECLEs)", *Journal of Decision Systems*, Vol. 24 (3), pp. 298-317.
- Eisenhardt, K.M. (1989), "Building Theories from Case Study Research", *The Academy of Management Review*, Vol. 19(4), pp. 532-550.
- Ellison, N. B., Steinfield, C and Lampe, C. (2007), "The Benefits of Facebook "Friends:" Social Capital and College Students' Use of Online Social Network Sites", Vol. 12, pp. 1143-1168.
- Fraser, M. and Dutta, S. (2008), *Throwing Sheep in the Boardroom: How Online Social Networking Will Transform Your Life, Work and World*, West Sussex: John Wiley.
- Hanna, B., Kee K.F. and Robertson, B.W. (2017), "Positive Impacts of Social Media at Work: Job Satisfaction, Job Calling, and Facebook Use among Co-Workers", *SHS Web of Conferences* Vol. 33,00012. Available online at [https://www.shs-conferences.org/articles/shsconf/pdf/2017/01/shsconf\\_icode2017\\_00012.pdf](https://www.shs-conferences.org/articles/shsconf/pdf/2017/01/shsconf_icode2017_00012.pdf) [Accessed on 27 May 2017].
- Harris, L. C. and Ogbonna, E. (2013), "Forms of employee negative word-of-mouth: a study of front-line workers", *Employee Relations*, Vol. 35(1), pp. 39-60.
- Huotari, L., Ulkuniemi, P., Saraniemi, S. and Mäläskä, M. (2015), "Analysis of content creation in social media by B2B companies' ", *Journal of Business & Industrial Marketing*, Vol. 30(6) pp. 761-770.
- Kwahk, K. and Park, D. (2016), "The effects of networks haring on knowledge-sharing activities and job performance in enterprise social media environments", *Computers in Human Behavior*, Vol. 55, pp. 826-839.
- Kluemper, D. H., Mitra, A. and Wang, S. (2016), "Social Media use in HRM", *Research in Personnel and Human Resources Management*, Vol. 34, pp. 153-207. DOI: 10.1108/S0742-730120160000034011
- Li, X. and Chen, W. (2014), "Facebook or Renren? A comparative study of social networking site use and social capital among Chinese international students in the United States", *Computers in Human Behavior*, Vol. 35, pp. 116-123.
- McDonald, P. and Thompson, P. (2016), "Social Media(tion) and the Reshaping of Public/Private Boundaries in Employment Relations", *International Journal of Management Reviews*, Vol. 18, pp. 69-84. DOI: 10.1111/ijmr.12061
- Men, L. R. and Muralidharan, S. (2017), "Understanding Social Media Peer Communication and Organization-Public Relationships: Evidence from China and the United States", *Journalism & Mass Communication Quarterly*, Vol. 94(1), pp. 81-101.
- Neves, J.C. (2015), "Does the Internet matter for strong ties? Bonding social capital, Internet use, and age-based inequality", *International Review of Sociology*, Vol. 25(3), pp. 1-19.
- Pinho, J. C. (2013), "The e-SOCAPIT scale: a multi-item instrument for measuring online social capital", *Journal of Research in Interactive Marketing*, Vol. 7(3), pp. 216-235.
- Schimidt, G.B., Lelchook, A. M. and Martin, J. E. (2016), "The relationship between social media co-worker connections and work-related attitudes", *Computers in Human Behavior*, Vol. 55, pp. 439-445.
- Thoumrungroje, A. (2014), "The Influence of Social Media Intensity and EWOM on Conspicuous Consumption", *Procedia - Social and Behavioral Sciences*, Vol. 148, pp.7-15. doi: 10.1016/j.sbspro.2014.07.009
- Xerri, M. and Brunetto, Y. (2010), "The strength of workplace social network ties in SMEs: a social exchange perspective." Published in: *Management research in a changing climate: British Academy of Management Conference, 14-16 September, Sheffield, UK.*



## HOW QUALITY OF LIFE INDICATORS CAN DEFINE CARE PROCESSES PERFORMANCE?

Salvatore, Fiorella Pia<sup>1</sup>; Crema, Maria<sup>2</sup>; Contò, Francesco<sup>1</sup>; Fiore, Mariantonietta<sup>1</sup>

<sup>1</sup>Dept. of Economics, University of Foggia, UNIFG, Foggia, Italy

<sup>2</sup>Dept. of Management and Engineering, University of Padova, Vicenza, Italy

### ABSTRACT

#### THEORETICAL BACKGROUND

According to the World Health Organization (WHO), the assessment of life quality spent in good health is one of the most important indicators used for the evaluation of health care (WHO, 2012). In addition, several authors (Mancini *et al.*, 2015; Naughton *et al.*, 2015) confirm that diseases and medical care deriving from nutritional problems cause an increase in health care costs and worsen the quality of life. Since care processes are linked to these problems, an assessment system would contribute to the measurement and monitoring of their performance in terms of care quality. A measurement system should be developed and adopted before and after the implementation of processes optimization considering the dimensions of the quality concept (Crema and Verbano, 2015).

In the healthcare sector, the practice of evaluating the quality of life associated to the care processes performances is not widespread; the impact of illness and its costs on patients' health for example is investigated by Ware (1987). Mor (1987) has defined "the quality of life" as a set of living aspects essential for living fully, such as safety, job, level of education, living standards, wages and eating habits (Diener and Suh, 1997). All these attributes can be considered for defining a new Performance Assessment System (PAS) that can provide feedbacks to healthcare managers, assisting them in reporting the company results to the key stakeholders and in improving the achieved performance. From a practical standpoint, measuring performance is a process whereby the drivers and results of the core activities of a care process are measured using different types of information (Barbuio, 2014). These measures permit a better understanding of how processes are performing. Furthermore, based on the outcomes deriving from a PAS, resources can be allocated to improve the efficiency and effectiveness of the referring system

, Different Key Performance Indicators (KPI) are available in the literature for the assessment and control of care processes (Arah *et al.*, 2006). The Joint Commission on Accreditation of Healthcare Organizations has developed an indicator system widely used. In addition, there are not standard models to evaluate the improvement of the care quality (Botje *et al.*, 2016).

Typically, the performance measurement system needs to adopt different dimensions to fully assess the care process. In this sense, the U. S. Department of Health and Human Services (2011) identifies four measures: (1) process measures; (2) outcome measures; (3) balancing measures; and (4) measures regarding the health care structure. Indicators for assessing the Quality-Of-Life (QOL) could be part of “outcome measures” because indicators try to quantify the patient’s health state comparing it with a standard of care (Higginson and Carr, 2001).

The recently published papers about this topic, demonstrate that the concept is still being developed. For example, it could be adopted for assessing the health status of patients with cardiovascular diseases (CVD). Specifically, for measuring the health-related quality of life in patients with CVD, generic and disease-specific measures can be adopted. The measures in the generic group are for instance: Sickness Impact Profile, Medical Outcomes Study 36-Item Short, Form Health Survey (SF-36) and Nottingham Health Profile (NHP). Instead, the measures in the disease-specific group are: Duke Activity Status Index (DASI), Mac New Heart Disease QOL Measure, Seattle Angina Questionnaire (SAQ), Minnesota Living with Heart Failure Questionnaire (MLHF) and Heart-QOL project (Thompson *et al.*, 2016).

Despite the widespread use of these different indicators, CVD in the European context still represent the leading cause of death (Eurostat, 2014). Therefore, it is necessary to provide patients with the right cares. Preventive actions could be taken based on the results of the adoption of a performance measurement system, saving money from the national health budget and managing healthcare processes in the best way. In particular, a standard model to evaluate the use of QOL as a dimension for the performance of care processes of patients with eating problems that provoke CVD is missing in the literature.

Based on a wide review of the literature, the purpose of this study is to investigate possible uses of the QOL indicators as an additional dimension to assess healthcare performance of patients with CVD

## **PURPOSE**

Due to the relevance of performance measurement system in the health sector to reduce waste of resources during the care processes, this study aims to understand whether and how QOL indicators for CVD can be used as a dimension of a healthcare performance measurement. system.

## **Methodology**

To pursue the research purpose, the present work carried out a structured literature review, following the methodology adopted by Khangah *et al.*, (2016) and Crema and Verbano, (2015). The review was executed by searching through two electronic databases such as Scopus and Web of Science (WOS). Using reference lists and meeting experts in the sector, information for searching and selecting the reference articles were obtained. The searched keywords have been the followings: “quality of life”

AND “cardiovascular disease” AND “indicator”. Moreover, inclusion and exclusion criteria in the following way were adopted. As inclusion criteria, authors only selected papers that were published from 2000 to 2017 with the following subject areas: “medicine”, “social science”, “economics, econometric and finance”, “engineering”, “cardiac cardiovascular system”, “health care sciences services”, “nutrition dietetics”, “multidisciplinary sciences”, “endocrinology metabolism”, “peripheral vascular disease”, “economics”, “primary health care”, “computer science” and “business finance”. Only papers in English were considered in order to obtain an international validity of studies. On the other hand, we did not consider book sections, conference proceedings, book chapters, special issues and dissertations. By doing these searches, Scopus released 157 papers and WOS did 22 in. Finally, a descriptive analysis of the database of international relevance will be conducted in addition to a content analysis, which will support the classification of QOL dimensions referred to cardiovascular pathologies.

## EXPECTED FINDINGS AND FUTURE RESEARCH

It is expected to obtain a literature database that can be used to create a framework with QOL indicators and their potential use inside a healthcare performance measurement system to assess the performance of care processes of patients with cardiovascular pathologies. This result will meet the objective of the research, including whether QOL indicators are used, for what CVD and how they are included into a performance measurement system in a healthcare structure. The development of the state of art about QOL indicators used for evaluating CVD care processes will provide academics with a research agenda for the future, based on the emerging gaps in the literature. Ultimately, the framework will allow the creation of a measurement system for monitoring CVD care processes, adding the QOL indicators and therefore enabling decision makers to intervene on the care processes and on preventing food-related illnesses. With this standardized system, it will be possible to avoid the worsening of population health status and thus, improving their quality of life.

## REFERENCES

- Arah, A. O., Westert, G. P., Hurst, J. and Klazinga, N. S. (2006), “A conceptual framework for the OECD Health Care Quality Indicators Project”, in *International Journal for Quality in Health Care*, pp. 5-13
- Barbuio, F. (2014), “Performance Measurement: a Practical Guide to KPIs and Benchmarking in Public Broadcasters”, available at: <https://publicmediaalliance.org/knowledge-hub/our-publications/> (accessed 04/10/2017)
- Botje, D., ten Asbroek, G., Plochg, T., Anema, H., Kringos, D. S., Fischer, C., Wagner, C. and Klazinga, N. S. (2016), “Are performance indicators used for hospital quality management: a qualitative interview study amongst health professionals and quality managers in The Netherlands”, in *BMC Health Services Research* (16) 574
- Diener, E. and Suh, E. (1997), “Measuring Quality of Life: Economic, Social and Subjective Indicators” , in *Social Indicators Research* 40, pp.189-216

- Eurostat, (2014), "Statistiche sulla causa di morte", available at: [http://ec.europa.eu/eurostat/statistics-explained/index.php/Causes\\_of\\_death\\_statistics/it](http://ec.europa.eu/eurostat/statistics-explained/index.php/Causes_of_death_statistics/it) (accessed 04/10/2017)
- Higginson, I. J. and Carr, A. J. (2001), "Using quality of life measures in the clinical setting", in *BMJ* (322), pp. 1297-1300
- Khangah, H. A., Jannati, A. and Imani A. (2016), "Assessment of Healthcare Providers' Performance Considering Three Healthcare Quality Indicators: A Review Article", in *Shiraz E Medical Journal* 17(4-5):e37522
- Mancini, P., Marotta, G., Nazzaro, C. and Simonetti, B. (2015), "Consumer Behaviour, Obesity and Social Costs. The Case of Italy", in *International Journal of Business and Society*, Vol. 16 No. 2, pp. 295-324
- Maria, C. and Verbano C. (2015), "Investigating the connections between health lean management and clinical risk management", in *International Journal of Health Care Quality Assurance*, Vol. 28 Iss 8 pp. 791 – 811
- Mor, V. (1987), "Cancer patients' quality of life over the disease course: Lessons from the real world", in *Journal of Chronic Diseases* 40(6), pp. 535-544
- Naughton, P., McCarthy, S. N. and McCarthy, M. B. (2015), "The creation of a healthy eating motivation score and its association with food choice and physical activity in a cross sectional sample of Irish adults", in *International Journal of Behavioral Nutrition and Physical Activity* 12:74
- Thompson, D. R., Ski, C. F., Garside, J. and Astin, F. (2016), "A review of health-related quality of life patient-reported outcome measures in cardiovascular nursing", in *European Journal of Cardiovascular Nursing*, Vol. 15(2), pp. 114-125
- U. S. Department of Health and Human Services, (2011), "Performance management and measurement", available at: <https://www.hrsa.gov/quality/toolbox/methodology/index.html> (accessed 04/20/2017)
- Ware, J.E. (1987), "Standards for validating health measures: Definition and content", in *Journal of Chronic Diseases* 40(6), pp. 473-480
- WHO, (2012), "World Health Statistics – A snapshot of global health", available at: [http://www.who.int/gho/publications/world\\_health\\_statistics/2012/en/](http://www.who.int/gho/publications/world_health_statistics/2012/en/) (accessed 04/20/2017)

## MORAL REASONING AND CORPORATE PLANNING

Santosuosso, Pierluigi

Dept. Law and Economics of Productive Activities, Sapienza University of Rome, Rome, Italy

### ABSTRACT

Appeals for ethics in business, Codes of ethics, systems for reporting malpractice and other ethical compliance programs do not seem to reduce unethical behaviours and legal violations (McKendall *et al.*, 2002; Webley and Werner, 2008; Brenkert, 2010). Various episodes of misconduct are reported in many companies around the world, such as the infringement of environmental standards, the violation of workplace health and safety rules, the mismanagement and misuse of organization's resources and false or deceptive sales practices (KPMG Forensic, 2008; Ethics Resource Center, 2012).

To overcome the gap between ethical principles and practice within firms, two main approaches have been suggested. First, the creation of an ethical corporate culture has been proposed by the adoption of several measures such as the charismatic role of top managers and leadership styles (Ferrell *et al.*, 2011), the rewarding of behaviours that support the importance of ethical values (Grojean *et al.*, 2004), the discussion of moral issues as part of the manager's job (Water and Bird, 1987), the ethics training (Valentine, 2009), the ethical climate of benevolence (Cullen *et al.*, 2003). Although the ethical culture in an organization play an important role in ethical decision-making (Trevino *et al.*, 1998), empirical studies have not yet provided conclusive results about its effectiveness (Loe *et al.*, 2000; O'Fallon and Butterfield, 2005; Helin and Sandström, 2007; Kaptein and Schwartz, 2008). Second, several studies have suggested the development of an effective ethics policy by the integration of ethical values into corporate planning. Robin and Reindenbach (1987) examined the integration of ethical and socially responsible plans into strategic marketing planning. Guerrette (1988) set out a five-step development plan of management strategies emphasizing the need for continuing training and for reformulation of corporate strategy in accordance with a Code of ethics. Hosmer (1994) highlighted the role that planning has to enhance trust, commitment and effort among stakeholders. Rampersad (2003) provided a strategic management model in which the personal goals are integrated into the organizational Balanced Scorecard.

The purpose of the current study is to provide a theoretical framework for an integration of ethical values into corporate planning using Activity-Based Budgeting (ABB). ABB is a well-known approach that allows managers to create and simulate a model of business activities aiming to overcome the limitations of traditional budgeting (Hansen *et al.*, 2003; Brimson and Antos, 1999; Bunce *et al.*, 1995; Hansen *et al.*, 2003). More specifically, we underline the key role that moral reasoning plays in

integrating ethical values into business activities and the role that ABB has vice versa in affecting moral reasoning by providing real and simulated information about firm and individual performances.

*Keywords: moral reasoning, corporate planning, ethical decision-making, budgeting, Activity-Based Budgeting, business ethics*

## REFERENCES

- Bonn, I. and Fisher, J. (2005), "Corporate governance and business ethics: insights from the strategic planning experience", *Corporate governance: an international review*, Vol. 13, No 6, 730-738.
- Brenkert, G. G. (2010), "The limits and prospects of business ethics". *Business Ethics Quarterly*, Vol. 20, No 4, 703-709.
- Brimson, J. A and Antos, J. (1999), *Driving value using Activity-Based Budgeting*, Wiley, New York, NY.
- Bunce, P., Fraser, R. and Woodcock, L. (1995), "Advanced budgeting: a journey to advanced management systems", *Management Accounting Research*, No 6, 253-265.
- Cullen, J. B., Praveen Parboteeah, K. and Bart, V. (2003), "The effects of ethical climates on organizational commitment", *Journal of Business Ethics*, No 46, 127-141.
- Ethics Resource Center (2012), *2011 National business ethics survey: workplace ethics in transition*, Arlington, VA.
- Ferrell, O. C., Fraederic, J. and Ferrell, L. (2011), *Business ethics: ethical decision making and cases*, South-Western Cengage Learning, Mason, OH.
- Ford, R. C. and Richardson, W. D. (1994), "Ethical decision making: a Review of the empirical literature", *Journal of Business Ethics*, No 13, 205-221.
- Grojean, M. W., Resick, C. J., Dickson, M. W. and Brent Smith, D. (2004), "Leaders, values, and organizational climate: examining leadership strategies for establishing an organizational climate regarding ethics", *Journal of Business Ethics*, No 55, 223-241.
- Guerrette, R. H. (1988), "Corporate ethical consulting: developing management strategies for corporate ethics", *Journal of Business Ethics*, No 7, 373-380.
- Haines, R., Street, M. D. and Haines, D. (2008), "The influence of perceived importance of an ethical issue on moral judgment, moral obligation, and moral intent", *Journal of Business Ethics*, No 81, 387-399.
- Hansen, S. C., (2011), "A Theoretical analysis of the impact of adopting rolling budgets, Activity-Based Budgeting and Beyond Budgeting", *European Accounting Review*, Vol. 20, No 2, 289-319.
- Helin, S. and Sandström, J. (2007), "An inquiry into the study of corporate codes of ethics", *Journal of Business Ethics*, No 75, 253-271.
- Hope, J. & Fraser, R. (2003), "Who Needs Budgets? ", *Harvard Business Review*, Vol. 81, No 2, 108-115.
- Hope, J. and Fraser, R. (2000), "Beyond budgeting", *Strategic Finance*, Vol. 82, No 4, 30-35.
- Hosmer, L. T. (1994), "Strategic planning as if ethics mattered", *Strategic Management Journal*, No 15, 17-34.
- Jensen, M. C. (2003), "Paying people to lie: the truth about the budgeting process", *European Financial Management*, Vol. 9, No 3, 379-406.
- Kaptein, M. and Schwartz, M. S. (2008), "The effectiveness of business codes: a critical examination of existing studies and the development of an integrated research model", *Journal of Business Ethics*, No 77, 111-127.
- KPMG Forensic. (2008), *Integrity Survey 2008-2009*, KPMG LLP.
- Libby, T. and Lindsay, R. M. (2010), "Beyond budgeting or budgeting reconsidered? A survey of North-American budgeting practice", *Management Accounting Research*, No 21, 56-75.
- Loe, T. W., Ferrell, L. and Mansfield, P. (2000), "A review of empirical studies assessing ethical decision making in business", *Journal of Business Ethics*, 2000, No 25, 185-20.
- McKendall, M., DeMarr, B. and Jones-Ridders, C. (2002), "Ethical compliance programs and corporate illegality: testing the assumptions of the corporate sentencing guidelines", *Journal of Business Ethics*, Vol. 37, No 4, 367-383.
- O'Fallon, M. and Butterfield, K. D. (2005), "A review of the empirical ethical decision-making literature: 1996-2003", *Journal of Business Ethics*, 2005, No 59, 375-413
- Rampersad, H. K. (2003), "Linking self-knowledge with business ethics and strategy development". *Business Ethics: a European review*, Vol. 12, No 3, 246-257

- Rest, J. R. (1986), *Moral development: advances in research and theory*, Praeger Publishers New York, NY.
- Robin, D. and Reidembach, R. E. (1987), "Social responsibility, ethics and marketing strategy: closing the gap between concept and application", *Journal of marketing*, No 51, 44-58.
- Schmidt, J. A. (1992), "Is it time to replace traditional budgeting? A method to make a budget more useful to management is proposed", *Journal of Accountancy*, Vol. 174, No 4, 103-107.
- Trevino, L. K. (1986), "Ethical decision making in organizations: a person-situation interactionist model", *Academy of Management Review*, No 11, 601-617.
- Trevino, L. K., Butterfield, K. D. and McCabe, D. L. (1998), "The ethical context in organizations: Influences on employee attitudes and behaviors", *Business Ethics Quarterly*, Vol. 8, No 3, 447-476.
- Valentine, S. and Barnett, T. (2003), "Ethics code awareness, perceived ethical values, and organizational commitment", *Journal of Personal Selling & Sales Management*, Vol. 23, No 4, 359-367.
- Waters, J. A. and Bird, F. (1987), "The moral dimension of organizational culture", *Journal of Business Ethics*, No 6, 15-22.
- Weber, J. and McGivern, E. (2010), "A new methodological approach for studying moral reasoning among managers in business settings". *Journal of Business Ethics*, No 92, 149-166.
- Webley, S. and Werner, A. (2008), "Corporate codes of ethics: necessary but not sufficient", *Business ethics: a European review*, Vol. 17, No 4, 405-415.

## INTERNATIONALIZATION PROCESS OF FAMILY SMES: EVIDENCE FROM ITALY

Schiesari, Roberto; Bollani, Luigi; Battisti, Enrico

University of Turin, Department of Management, Turin, Italy

### ABSTRACT

The efficiency problem of Italian industry depends on the ability of our SME to internationalize (i.e. Caroli, 2000; Caroli and Liparini, 2002; Zucchella, Palamara and Denicolai, 2007; Perretti, 2009) and innovate (i.e. Acs and Audretsch, 1988; Cooke and Wills, 1999; Pianta and Vaona, 2007; O'Casey and Weerawardena, 2009).

For Italian family owned SMEs internationalization is crucial for their development and sustainability, as demonstrated even from evidences of the performance of the enterprises during the period of financial crisis (Zucchella and Hagen, 2015).

If there are some companies, even SME, that have been able to increase their capacity to compete in the international markets, exporting, investing abroad and innovating, others, are struggling to keep up with technological changes and the growing global competition, losing turnover and with serious risks even for their survival.

The companies with a good presence in foreign markets have better faced the drop of internal demand, reduced the operating and financial risk and bettered their processes and level of innovation. Innovation of products and processes is the key resource to compete in the global market but the small and medium family owned companies have to face many other challenges to develop their international presence.

In many sectors the "light way" of internationalisation through export is not still sufficient for the challenges of a global market. A strategic presence in the emerging markets requires investments in immaterial and material assets. Representative offices, strategic agreements with local partners, joint ventures or direct investment through subsidiaries are strategies of internationalization which request competences and investments (Caroli, 2008)

The family SME may have good opportunities but they must face the risks related to these investments and adapt their organisation and business model.

The financial needs are not the only risk; for many SMEs, the main problem is linked to the to attract or educate human resources with the appropriate skills and competences and obtain good quality informations about the new markets.

To share investments, knowledge and even human resources with other companies through alliances (in form of joint venture, networks or specific agreements) can accelerate the internationalisation



process and better the performance and reduce the failure risk, even if the findings of many researches show the difficulties of long term strategic collaboration among SME.

*Purpose:* The aim of this paper is to investigate the role of internationalization for Italian SMEs to identify perceived opportunities and internal and external constraints in their strategic path to international markets, compared with their current situation, in relation to their size, age and governance.

*Design/methodology/approach:* The research scheme is based on a survey that was submitted on a sample of Italian family owned SMEs involved, or evaluating to be involved, in an internationalization process. The questionnaire, based on qualitative and quantitative questions, investigates different aspects related to scenario, objectives, perceived risks and business model.

*Findings:* The analysis of the collected data highlights an increasing awareness to consider internationalization by direct investment a key driver of their business strategy, leveraging mainly on innovation capability. The firms underline their growing interest for strategic alliances, even if they consider also the related difficulties. Because of the complexity of the relationships between the different variables collected through the questionnaire, a multivariate statistical analysis allows to sketch a general overview of the investigated phenomena.

*Research limitations/implications:* The results are limited due to an explorative analysis focused on Italian SMEs.

*Social implications:* This study evidences how internal and external qualified human resources are perceived as an essential but critical element, with possible implications for training programs

*Practical implications:* The results of this study propose to management that the main needs and constraints for Italian family owned SMEs to achieve a more structured internationalization.

*Originality/value:* The research evidences how Italian SMEs are changing their approach to internationalization and the way they consider the best to have a strategic presence in foreign markets.

**Keywords:** Family Business, Italian SMEs, Internationalization, Innovation, Joint Venture, Direct International Investment, Alliances, Finance.

## REFERENCES

- Acs Z. J., Audretsch, D. B. (1988), "Innovation in large and small firms: An empirical analysis", *American Economic Review*, Vol. 78, n.4, pp. 678-690.
- Beamish P.W., Lu J. (2001), "The Internationalization and Performance of SMEs", *Strategic Management Journal*, Vol. 2, n. 6-7, pp. 565-586.
- Bresciani S. Vrontis D., Thrassou A. (2013), "Change through Innovation in Family Business: Evidence from an Italian Sample", *World Review of Entrepreneurship, Management and Sustainable Development*, Vol. 9, n. 2, pp. 195-215.

- Bukley P.J. (1996), "The Role of Management in Internalisation Theory: A meta-analysis and integration of the literature on international business and international management", *Management International Review*, Vol. 36, n. 1, pp. 7-54.
- Cafferata R., Mensi R. (1995), "The Role of Information in the Internationalization of Small and Medium-Sized Enterprises: A Typological Approach", *International Small Business Journal*, Vol. 14, pp. 35-46.
- Caroli M. (2000), *Globalizzazione e localizzazione dell'impresa internazionalizzata*, FrancoAngeli, Milano.
- Caroli M. (2008), *Economia e gestione delle imprese internazionali*, McGraw-Hill, Milano.
- Caroli M., Lippardini A. (2002), *Piccole imprese oltre confine. Competenze organizzative e processi di internazionalizzazione*, Carocci, Roma.
- Colapinto C., Gavinelli L., Zenga M., Di Gregorio A., (2015), "Different approaches to the pursuit of internationalization by Italian SMEs", *Journal of Research in Marketing and Entrepreneurship*, Vol. 17, n. 2, pp. 229-248.
- Cooke P., Wills D. (1999), "Small Firms, Social Capital and the Enhancement of Business Performance Through Innovation Programmes", *Small Business Economics*, Vol. 13, n. 9, pp. 219-234.
- Coviello N.E., McAuley, A. (1999), "Internationalization and the small firm, A Review of Contemporary Empirical Research", *Management International Review*, Vol. 39, n. 3, pp. 223-237.
- Francioni B., Vissak T., Musso F. (2016) The Role of Wine Tourism in Italian SMEs' Internationalization: Eight Cases. In Petruzzellis L., Winer R. (eds) *Rediscovering the Essentiality of Marketing. Developments in Marketing Science: Proceedings of the Academy of Marketing Science*. Springer, Cham.
- Hagen, B., S. Denicolai, Zuccella A. (2014), "International entrepreneurship at the crossroads between innovation and internationalization", *Journal of International Entrepreneurship*, Vol. 12, n. 2, pp. 111-114.
- Hitt M.A., Hoskisson R.E., Kim H. (1997), "International diversification: effects on innovation and firm performance in product-diversified firms", *Academy of Management Journal*, Vol. 40, n. 4, pp. 767-798.
- Humphrey J. (2014), Internalisation theory, global value chain theory and sustainability standards. In Van Tulder R., Verbeke A., Strange R. (eds) *International Business and Sustainable Development (Progress in International Business Research, Volume 8)* Emerald Group Publishing Limited.
- Hutchinson K., Alexander N., Quinn B. (2005), "The internationalisation of small to medium-sized retail firms: towards a conceptual framework", *Journal of Marketing Management*, Vol. 21, pp. 149-179.
- Li L., Li D., Dalgic T. (2004), "Internationalization process of small and medium-sized enterprises: towards a hybrid model of experiential learning and planning", *Management International Review*, Vol. 44, n.1, pp. 93-116.
- Lu J.W., Beamish P.W. (2001), "The internationalization and performance of smes", *Strategic Management Journal*, Vol. 22, n. 1, pp. 565-586.
- Moen Ø. (1999), "The Relationship between Firm, Size, Competitive Advantages and Export Performance Revisited", *International Small Business Journal*, Vol. 18, n.1, pp. 53-72.
- O'Cass A., Weerawardena J. (2009), "Examining the role of international entrepreneurship, innovation and international market performance in SME internationalisation", *European Journal of Marketing*, Vol. 43, n. 11/12, pp. 1325-1348.
- Perretti F. (2009), *Strategie di internazionalizzazione*, Egea, Milano.
- Pianta M., Vaona A. (2007), "Innovation and productivity in European industries", *Economics of Innovation and New Technology*, Vol. 16, n.7, pp. 485-499.
- Ruigrok W., Wagner H. (2003), "Internationalization and performance: An Organizational learning perspective", *Management International Review*, Vol. 43, n., pp. 63-83.
- Verbeke A. (2009), *International Business Strategy*, Cambridge University Press, Cambridge.
- Wolff J.A., Pett T.L. (2000), Internationalization of small firms: an examination of export competitive patterns. Firm size and export performance, *Journal of Small Business Management*, Vol. 38, n.2, pp. 34-47.
- Zucchella A., Magnani G. (2016), *International entrepreneurship. Theoretical foundations and practices*, Palgrave.
- Zucchella A., Palamara G., Denicolai S. (2007), "The drivers of the early internationalization of the firm", *Journal of World Business*, vol. 42, n. 3, pp. 268-280
- Zucchella, A., Hagen, B. (2015). The internationalization of SMEs in Italy. In P.Ghauri and Kirpalani M. (eds) *Handbook of Research on International Entrepreneurship Strategy: Improving SME Performance Globally*, Elgar.

## THE MORE THINGS CHANGE, THE MORE THEY STAY THE SAME

Schipani, Cindy;<sup>1</sup> Dworkin, Terry<sup>2</sup>

<sup>1</sup>Business Law, University of Michigan; Ann Arbor, MI USA

<sup>2</sup>Law School, Seattle University, Seattle, WA, USA

## ABSTRACT

The pay gap between men's and women's salaries is another prime example of bias in the workplace. Women are more likely to have an advanced degree than men, are entering the workforce in nearly equal numbers as men, and are protected by the Equal Pay Act of 1963 and Title VII, yet the needle has barely nudged (Dworkin, Ramaswami, & Schipani, 2015). More than 50 years after the Equal Pay Act became law, women still earn 79 cents for every dollar men earn ("America's Women and the Wage Gap," 2016). In 2013, women made a median salary of \$706, compared to a median salary of \$860 for men (U.S. Department of Labor, 2015). The disparity intensifies among those with higher degrees. Men with bachelor's degrees made a median of \$1,246 per week, but the median of women with bachelor's degrees was only \$931. Among those with professional degrees, men received a median of \$1,896, while women received a median of only \$1,411 (U.S. Bureau of Labor Statistics, 2013).

While the above figures are based on median salaries of full-time workers, the discrepancies occur in a wide range of occupations where the comparisons in terms of education, experience, and other traits are easier to make. For example, female surgeons earn 71 percent of what male surgeons do and five of the 10 major occupational groups where women lagged the most were in finance (Miller, 2016). This is not an unusual discrepancy. A Wall Street Journal poll found that in many "elite jobs" and professions, women in these areas showed the biggest pay gaps (Adammy & Overberg, 2016). Additionally, women with children incurred a "motherhood wage penalty" up to five percent per child, further compounding how dangerous this disparity really is (Magid, 2014). This evidence exhibits just how insidious the gender divide remains.

Our methodology will involve synthesizing the available studies on the issue and collecting data on the supervisory and non-supervisory roles of women in comparison to men, to suggest ways to reduce the pay gap. With respect to data collection, we have conducted a survey of alumni of prominent business schools in the U.S. and Italy, which includes a question on supervisory and nonsupervisory roles in business. We will analyze this data for gender differences both overall and with regard to country differences. If women tend to hold significantly fewer supervisory positions than men, we anticipate the wage gap to continue to proliferate.

A preliminary suggestion to reduce the gap, based on our synthesis of current studies, is to promote, and perhaps achieve, transparency in salaries (Burkus, 2016). For example, one study suggested that transparent pay conditions tended to reduce the gender pay gap. (Belogolovsky & Bamberger, 2014) In another study such transparency gives legitimacy to an employee's wage bargaining, and even just

being aware of discrepancies can change norms. (Rosenfeld & Denise, 2015) Bargaining for better pay is something men are much more likely than women to do.

Perhaps the easiest is to make it clear that discussing salaries between workers is allowed. When employers have encouraged such discussions or provided information about pay scales, many misconceptions about pay are corrected (Burkus, 2016). Governments at various levels are also looking to transparency to help correct the gender wage gap.

Several other practices to narrow the gap have recently been suggested. One proposal is to ignore past salaries in order to avoid reproducing previous disadvantages. And transparency may not only help with pay gaps—it may also increase productivity. Emiliano Huet-Vaughn (2013) suggests that workers who know of their placement in the earnings distribution provide significantly more effort on average than those without knowledge of their peers' earnings. Thus, despite the traditional mind-set against such comparisons, pay transparency would be good for business.

*Keywords: gender, discrimination, employment, pay, diversity, women, organizations*

## REFERENCES

- Adammy, J. & Overberg, P. (2016, May 18). Pay gap widest for elite jobs. *Wall Street Journal*, A1.
- America's women and the wage gap. (2016, April). Retrieved from <http://www.nationalpartnership.org/research-library/workplace-fairness/fair-pay/americas-women-and-the-wage-gap.pdf>.
- Belogolovsky, E. & Bamberger, P. A. (2014, December 1). Signaling in secret: Pay for performance and the incentive and sorting effects of pay secrecy. *Academy of Management Journal*, 57(6).
- Burkus, D. (2016, May 31). Say goodbye to the deepest corporate secret: Salaries. *Wall Street Journal*, R2.
- Dworkin, T. M., Ramaswami, A., & Schipani, C. A. (2016). A half century post Title VII: Still seeking pathways for women to organizational leadership. *UCLA Women's Law Journal* 23(1): 29-77.
- Huet-Vaughn, E. (2013, November). Striving for status: A field experiment on relative earnings and labor supply. UC Berkeley. Retrieved from [http://econgrads.berkeley.edu/emilianohuet-vaughn/files/2012/11/JMP\\_e.pdf](http://econgrads.berkeley.edu/emilianohuet-vaughn/files/2012/11/JMP_e.pdf).
- Magid, J. M. (2014). Cloaking: Public policy and pregnancy. Manuscript in preparation.
- Miller, C. C. (2016, January 15). How to bridge that stubborn pay gap. *New York Times*. Retrieved from [http://www.nytimes.com/2016/01/17/upshot/how-to-bridge-that-stubborn-pay-gap.html?\\_r=0](http://www.nytimes.com/2016/01/17/upshot/how-to-bridge-that-stubborn-pay-gap.html?_r=0).
- Rosenfeld, J. & Denise, P. (2015). The Power of Transparency: Evidence from a British Workplace Survey. *American Sociological Review* 80: 1045-1068.
- U.S. Bureau of Labor Statistics. (2013). Women in the labor force: A databook. Retrieved from <http://www.bls.gov/cps/wlf-databook-2012.pdf>.
- U.S. Department of Labor. (2015). Latest annual data. Retrieved from <http://www.dol.gov/wb/stats/recentfacts.htm#age>.

## **WORKING IN VIRTUAL TEAMS: THE ROLE OF TEAM CONNECTEDNESS, KNOWLEDGE SHARING AND TEAM DIVERSITY**

**Schreiber, Ezolda; Van Dijk, Dina; Drory, Amos**

Ben-Gurion University of the Negev

### **ABSTRACT**

### **INTRODUCTION**

Employees working in global virtual space, who use technology to interact with one another across geographic and organizational boundaries, are growing in number and importance and becoming increasingly common strategic work units in global organizations (Colbert et. al., 2016; Gilson et. al., 2015; Jackson & Chen, 2007; Gibson & Cohen, 2003). Given the numerous technological advancements (e.g., Priem, Li, & Carr, 2012) a recent survey suggests that approximately 66% of multinational organizations utilize virtual teams (Society for Human Resource Management, 2012), and 80% of companies surveyed believe this number will continue to grow (Gilson et. al., 2015; Perry, 2008). Hence, researchers call to examine how technology is shaping employees perceptions, beliefs and values and how it changes the workspace and organizations (Colbert et. al., 2016). Particularly, research is needed to better understand how digital fluency and reduced face-to-face interaction may influence job performance and employees' effectiveness (Colbert et. al., 2016). Given what we know about the characteristics of the digital workforce and the increasing use of technology at work, the question remains regarding how organizations can most effectively manage the digital workforce and advantage technology while avoiding potential downsides. Research has only begun to provide guidance on these issues (Colbert et. al., 2016; Kirkman and Mathieu, 2005; Martins et al., 2004). To fill this gap, this study aims to explore some of the fundamental factors affecting the success of working virtually.

The virtual team efficiency is associated with the quality of relationships between the remote team members (De Jong & Elfring, 2010; Balkundi & Harrison, 2006) and the level of knowledge and information they share with each other (Haas, 2010; Cummings, 2004). Researchers have given considerable attention to how social process and dynamics, including social interaction (Ren & Gray, 2009; Richter et al., 2006), identification with the team (Ibarra & Barbulescu, 2010; Richter et al., 2006;) and trust among team members (Renzel, 2008; Kirkman et al., 2002) are related to performance and effectiveness of organizations and in particular to productivity and quality (De Jong & Elfring, 2010, Hsu et al., 2007). Team members who interact identify and trust each other are more likely to engage

in productive interactions and teamwork processes that enhance team performance. In addition, the virtual team efficiency is also associated with how knowledge sharing process affects team/organizational effectiveness (Haas, 2010; Chudoba et al., 2003), as Nonaka (1994) noted: "knowledge is considered to be one of the most strategically important, and even vital, organizational resources" (Nonaka, 1994). Thus, it seems important to understand how the level of virtuality affects both connectedness dynamics and knowledge sharing processes and how those dynamics and processes affect employees' effectiveness.

The current study investigates how working from remote locations and communicating electronically affect the team's connectedness dynamics and knowledge sharing processes (i.e., mediators), and how these dynamics are further related to employees' outcomes. The current study also explores the moderating role of key components that are influencing this process, specifically, task interdependence, employees' tenure in the team and the level of diversity in the team (in terms of demographics and values). The research model is presented in Figure 1.

Figure 1: The Research Model

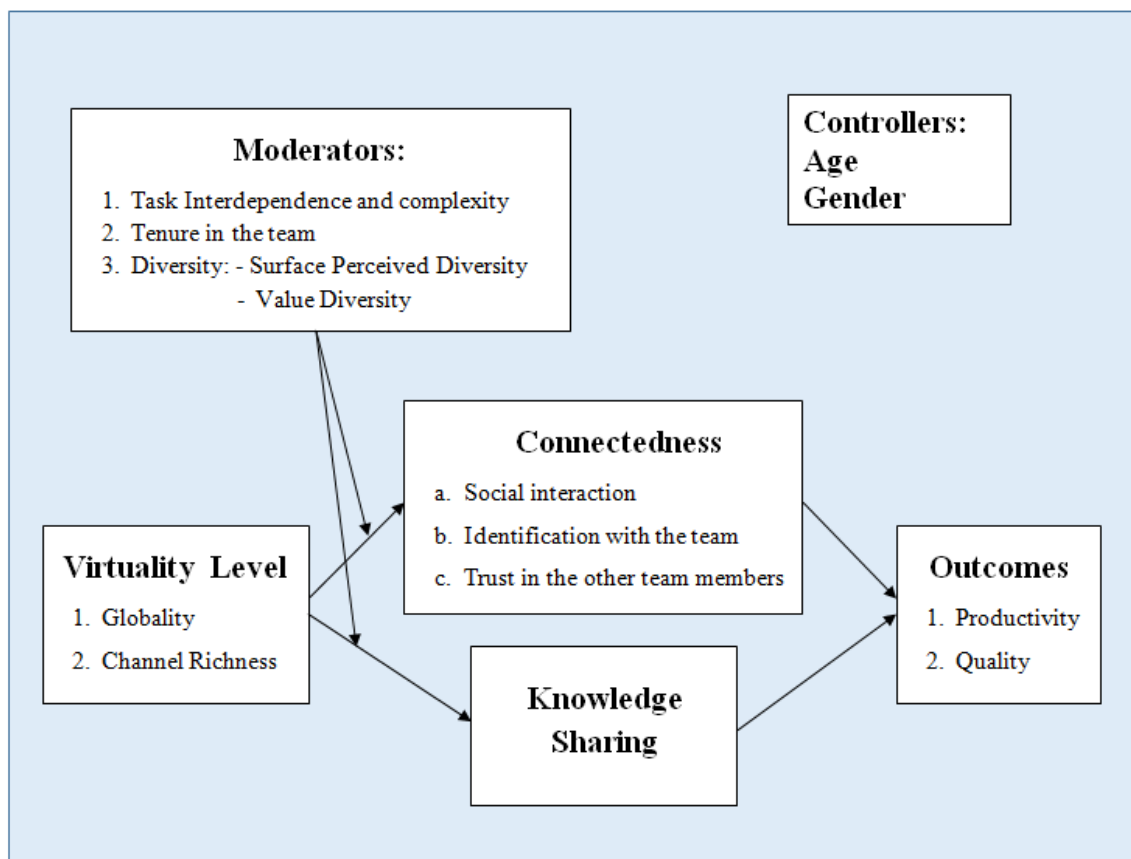

## METHOD

Sample: Our sample contains 867 LinkedIn members operating in virtual teams working in global high-tech companies. Nearly 20% work at IBM, 20% work at Cisco Systems, 14% work at Dell, and 12% work at Amdocs. Others (17%) work at others firms such as Atos, Oracle, and EMC, and 17% were not willing to disclose their employer. Nearly 40% of the respondents held managerial or executive positions. A total of 50% of the respondents reported being from the EMEA (Europe and the Middle East) region (e.g., Netherland, Poland, Romania, Israel); nearly 20% reported being from the Americas region (e.g., USA, Brazil, Mexico, Canada); and nearly 15% reported being from the Asia Pacific region (e.g., India, Australia, China) and 15% of the respondents were not willing to disclose their nationality. Nearly 85% of the reported were male and 10% female, 5% did not report their gender. The average virtual team tenure was 4.4 ( $SD=3.5$ ) years. A total of 85% of the respondents were male and 10% were female. The average age of the respondents was 41 ranging from 20 to 79. About 65% reported being married with 50% having 1-3 children.

The data was collected using an Internet survey (Qualtrics) and was then aggregated into an SPSS file. All errors and wrong or outlier values were removed after which the data was analyzed using SEM procedure by Amos 17 software.

Measures: *virtuality level* was measured using empirical indexes based on definitions of virtuality taken from previous studies. Two indexes were used, reflecting different aspects of team virtuality level: 1. *Globality*, which reflects the geographical disparity of the employee from his or her other team members. 2. *Channel Richness*, which reflects the media channels that are used in order to communicate between the remote team members.

1. *Globality* was developed by aggregating two types of indexes a. Geographic Dispersion and b. Time Zone Differences: *Geographic dispersion* is the air distance (in kilometers) between the respondent's location and that of his/her other team members. *Time Zone Differences* is the time zone's lag between the respondent's location and his/her other team members. In order to calculate the *Geographic Dispersion* and the *Time Zone Differences*, the respondent was asked to indicate the total number of site locations, the location of each site, and the number of team members at each site location. The values of both geographic dispersion and time zone differences between two sites were taken from the Google Map website. For each respondent, the total geographic dispersion and the total time zone differences were calculated as a star network. These measures takes into consideration both the number of locations and the number of individuals in the team, residing at each location (O'Leary & Cummings, 2007).

2. *Channel Richness* score measures the frequency of use of each communication channel, as a function of channel richness: i.e., the ability of the communication channel to transmit multiple cues, transmit immediacy feedback, and focus on the other person (Daft & Lengel, 1986). The channels available to communicate and collaborate with the other team members are: face to face, video conference, telephone calls, telephone conference, chat, and email, on an ordinal scale, so that: face to face communication is considered to be the richest form, while email is considered to be the leanest form (Daft & Lengel, 1986). In order to calculate the Channel Richness score, the respondent was asked to rate how frequently he/she uses each communication channel to collaborate with his/her other team members on a 7-point Likert scale. The frequency of use of each communication channel was multiplied using an ordinal factor creating a 0-100% continuous Channel Richness score. Higher scores indicated using richer communication channels included face to face interaction and video conferences, whereas lower scores indicated using leaner communication channels such as phone calls and emails.

3. The other variables of the model - *connectedness (social interaction, identification, and trust), knowledge sharing, outcome measures (productivity, quality), and the moderators (task independence, tenure in the team, team diversity)* – were measured using reliable and valid self-reported scales.

## RESULTS

Our results confirmed the relationships between virtuality level and connectedness only for the 'channel richness' index of virtuality but not for globality index. To sum up our main results:

1. Channel richness was positively related to connectedness (i.e., social interaction, identification with the team, trust). 2. Connectedness and knowledge sharing were both positively related to the outcomes measures (i.e., productivity and quality). 3. Connectedness, (including social interaction, identification with the team, trust) mediated the relationships between channel richness and the outcomes measures. Also, 4. Connectedness was positively related to knowledge sharing.

These results indicate that when virtual teams communicate via rich channels of communication (in terms of both quality and frequency), the team members become more connected to and identified with their virtual team, and this connectedness feeling further leads to improved team outcomes. In addition, the connectedness relates to knowledge sharing, which also relates to the team outcome. This indicate that when employees of virtual teams feel connected to their team, they are more willing to share their knowledge with their remote team members, which is crucial for the team ability to perform well.



Regarding the moderators that were tested, we found that value diversity strengthens the positive relationships between channel richness and connectedness for two indices of connectedness (identification with the team and trust). This means that in the case of low value diversity, communicating via richer communication channels would not make any difference to the identification with the team or the trust level, but in cases of mid and high levels of value diversity, identification with the team and trust would be stronger when using richer communication channels.

## DISCUSSION

This study contributes to the existing knowledge by shedding light on how the virtual space might be re-designed to take advantage of its competencies, to promote connectedness dynamics and knowledge sharing processes and to ensure that technology is most effectively used as a tool in service of the organization's goals. By using the virtual working space wisely and reasonably, via sequential interventions, the negative consequences of working remotely may be reduced or possibly be prevented.

The effective management of social dynamics, team diversity and knowledge exchange as organizational resources, is one of the most important challenges facing organizations today (Rico et al., 2008). From a management perspective, it is vital to know which possible interventions have the potential to help an organization scale the social fence and move towards a scenario where everyone cooperates.

There are two main limitations: 1. Measuring the outcome variables reflected in productivity and quality was a self-reported, rather than objective measure. 2. The virtuality level would better analyzed by a team-level research and not by an individual-level as this study was. However, to accurately assess the level of virtuality of the team of each respondents, we have used detailed scales, which measured for each respondent - the number of his/her team members and their location, which allow us to compute the geographical disparity of the respondent's team, and through this to assess its virtuality level.

*Keywords: Virtual Teams; Geographic Dispersion; Knowledge Sharing; Social Integration; Team performance*

## REFERENCES

- Balkundi, P., & Harrison, D. A. (2006). Ties, leaders, and time in teams: Strong inference about network structure's effects on team viability and performance. *Academy of Management Journal*, 49, 49-68.
- Chudoba, K. M., Wynn, E., Lu, M., & Watson-Manheim, M. B. (2003). How virtual are we? Measuring virtuality and understanding its impact on a global organization. *Information Systems Journal*, 15, 279-306.
- Colbert, A., Yee, N., & George, G. (2016). The Digital Workforce and the Workplace of the Future. *Academy of Management Journal*, 59, 731-739.

- Cummings, J. (2004). Work groups, structural diversity, and knowledge sharing in a global organization. *Management Science* 50, 352-364.
- Daft, R. L. & Lengel, R. H. (1986). Organisational information requirements: Media richness and structural design. *Management Science*, 32, 554- 571.
- De Jong, B. A. & Elfring, T. (2010). How does trust affect the performance of ongoing teams? The mediating role of Reflexivity, Monitoring, and Effort. *Academy of Management Journal*, 53, 535-549.
- Gibson, C.B. & Gibbs, J.L. (2006): Unpacking the Concept of Virtuality: The Effects of Geographic Dispersion, Electronic Dependence, Dynamic Structure, and National Diversity on Team Innovation. *Administrative Science Quarterly*, 51, 451-495.
- Gilson, L. L., Maynard, M. T., Young, N. C. J., Vartiainen, M., & Hakonen, M. (2015). Virtual teams research 10 years, 10 themes, and 10 opportunities. *Journal of Management*, 41, 1313-1337.
- Haas, M. R. (2010). The double-edged swords of autonomy and external knowledge: Analyzing team effectiveness in a multinational organization. *Academy of Management Journal*, 53, 989-1008.
- Hsu, M.H., Ju, T.L., Yen, C.H., Chang, C.M. (2007) Knowledge sharing behavior in virtual communities: the relationship between trust, self-efficacy, and outcome expectations. *International Journal of Human-Computer Studies*, 65, 153-169.
- Ibarra, H., & Barbulescu, R. (2010). Identity as narrative: Prevalence, effectiveness, and consequences of narrative identity work in macro work role transitions. *Academy of management review*, 35, 135-154.
- Kirkman, B. L., Rosen, B., Gibson, C. B., Tesluk, P. E., & McPherson, S. O. (2002). Five challenges to virtual team success: Lessons from Sabre, Inc. *Academy of Management Executive*, 16, 67-79.
- Kirkman, B.L. & Mathieu, J.E. (2005). The Dimensions and Antecedents of Team Virtuality, *Journal of Management*, 31, 700-718.
- Martins, L.L, Gilson, L.L, & Maynard, M.T. (2004): Virtual Teams: What Do We Know and Where Do We Go From Here? *Journal of Management*, 30, 805.
- Nonaka, I (1994). A Dynamic Theory of Organizational Knowledge Creation, *Organizational Science*, 5, 14-37.
- Perry, B. (2008). Virtual teams now a reality: Two out of three companies say they will rely more on virtual teams in the future. <http://www.pr.com/press-release/103409>. Accessed February 1, 2014.
- Priem, R. L., Li, S., & Carr, J. C. (2012). Insights and new directions from demand-side approaches to technology innovation, entrepreneurship, and strategic management research. *Journal of Management*, 38, 346- 374.
- Ren, H., & Gray, B. (2009). Repairing relationship conflict: How violation types and culture influence the effectiveness of restoration rituals. *Academy of Management Review*, 34, 105-126.
- Renzel, B. (2008). Trust in management and knowledge sharing: the mediating effects of fear and knowledge documentation. *Omega*, 36, 206-222.
- Richter, A. W., West, M. A., Van Dick, R., & Dawson, J. F. (2006). Boundary spanners' identification, intergroup contact, and effective intergroup relations. *Academy of Management Journal*, 49, 1252-1269.
- Rico, R., Miriam Sánchez-Manzanares, M., Gil, F., Gibson, C. (2008). Team Implicit Coordination Processes: A Team Knowledge-Based Approach. *Academy of Management Review*, 33, 163-184.
- Society for Human Resource Management. 2012. Virtual teams. <http://www.shrm.org/research/surveyfindings/articles/pages/virtualteams.aspx>. Accessed January 15, 2014.

# DESTINATION MARKETING IN THE UNITED KINGDOM AND ORGANIZATIONAL AMBIDEXTERITY: EXPLOITATIVE DILEMMAS AND EXPLORATIVE PROSPECTS?

Scott, Peter<sup>1</sup>; Stokes, Peter<sup>2</sup>; Rowland, Caroline<sup>3</sup>; Gordon, David<sup>2</sup>

<sup>1</sup>School of Education, Leisure and Sport Studies, Liverpool John Moores University, Liverpool, U.K.

<sup>2</sup>Castle Business School, De Montford University, Leicester, U.K.

<sup>3</sup>Chester Business School, University of Chester, Chester, U.K.

## ABSTRACT

Significant change is currently taking place in the governance of place and destination marketing organizations in England. A destination marketing organization (DMO) is defined by Pike (2008, p. 31) as 'The organization responsible for the marketing of an identifiable destination'. The term 'destination marketing' generally refers to marketing related to tourism development whilst the term 'place marketing' has a similar meaning save that it tends to refer to marketing activity designed to attract inward investment and skilled and talented residents as well as tourists (Quinn, 2013). As such, the practice of place marketing tends to have a wider brief than that of destination marketing.

The changes underway in place marketing organizations in the United Kingdom reflect international trends but they are primarily the result of continuing austerity measures and government policy. The central proposition underpinning the government policy is the desire to reduce public sector funding of destination marketing dramatically (Government Tourism Policy, 2011). The expectation is that the private sector will fill the resulting funding gap. However, the extent to which the private sector is willing or is able to fill this gap is open to conjecture. If the destination marketing organizations are unable to adapt sufficiently to these changed circumstances they may face an existential threat if, and when, their core funding disappears. A 2011 survey of a network of European DMOs known as *European Cities Marketing* found that the majority were public private partnerships with an average reliance on public sector funding of 48% (Heeley, 2015). If they are to continue as 'going concerns' such organizations have to adapt their working practices and attract new funding streams or they may cease to exist.

Organizational ambidexterity is a term that can readily be used to characterise and analyse the situation confronting DMOs. Organizational ambidexterity is the ability of an organization to be both exploitative and explorative in the way that it operates. The exploitative element involves a focus on, *inter alia*: existing customers and markets whereas the explorative element requires a focus on new markets and new methods (O'Reilly and Tushman, 2013, Smith, 2016). Exploitative resources are largely extant whilst exploratory resources are generally evolving and are representative of new

opportunities (Stokes et al, 2015). Junni et al (2013) observe that the management of innovation may have particular resonance in organizations that largely draw upon intangible assets and knowledge to make themselves marketable and this is particularly the case with DMOs. The need to be organizationally ambidextrous and strategically agile in order to ensure survival exemplifies the challenge currently confronting DMOs in England. Chief executives with organizational ambidexterous skills of a high order are required to lead DMOs through the current financial maelstrom. This will necessitate the well-developed leadership skills that are required to effect transformative change as well as a willingness to embrace change throughout the organization. As exploitative and exploratory operations compete for the same resources (Junni et al, 2013), DMO leadership that is wedded to previous operating regimes may lack the flexibility to adapt to the new order. On the other hand, too much of a focus on exploratory operations may alienate existing partnership organizations such as local authorities. Achieving optimum organizational performance will require a balanced approach that involves the capacity to look both backwards and forwards or, in other words, to have a something of Janus perspective (O'Reilly and Tushman, 2004). The theoretical concept of organizational ambidexterity has been applied to a number of different industries and contexts but it has yet to be applied to DMOs. It is therefore hoped that the current research will make a valuable contribution to this growing field of academic enquiry.

Methodologically, the study employs an overall interpretive framework (Denzin & Lincoln, 2011). Fifteen semi-structured interviews have been conducted to date with senior figures in England's destination context including nine DMO senior executives and two DMO board members. The sample has involved a combination of purposive and snowball approaches. The reliability, validity and generalizability of the findings will be assured through thematic analysis (King, 2004). A range of issues and themes have so far been identified in relation to the challenges and manners in which DMOs and the senior figures leading them have variously engaged (or not) in organizational ambidexterous behaviours and postures. The research has already identified a number of managerial implications that need to be taken forward if DMOs are to evolve and be sustained.

It is hoped that this research will contribute a deeper knowledge and understanding of the challenges currently faced by DMOs in England and elsewhere and will provide a theoretical basis for improving the effectiveness and efficiency of the change management processes that are required to confidently face the future.

*Keywords: Organizational ambidexterity; place marketing; destination marketing; United Kingdom*

## REFERENCES

- Denzin, N.K. and Lincoln, Y.S. (2011) *The Sage Handbook of Qualitative Research*. London: Sage Publications Ltd.
- Department for Culture, Media and Sport (2011) *Government Tourism Policy* [online] Available at: [https://www.gov.uk/government/uploads/system/uploads/attachment\\_data/file/78416/Government2\\_Tourism\\_Policy\\_2011.pdf](https://www.gov.uk/government/uploads/system/uploads/attachment_data/file/78416/Government2_Tourism_Policy_2011.pdf) [Accessed 28th February 2017]
- Heeley, J. (2015) *Urban Destination Marketing in Contemporary Europe*. Bristol: Channel View Publications
- Junni, P., Sarala, R.M., Taras, V. and Tarba, S. Y. (2013) Organizational Ambidexterity and Performance: A Meta-Analysis. *The Academy of Management Perspectives* 27 (4) pp. 299-312
- King, N. (2004). Using templates in the thematic analysis of text. In: Cassell, C and Symonds, G. (Eds.) *Essential Guide to Qualitative Methods in Organizational Research*. London: Sage Publications Ltd. pp.256-287.
- O'Reilly, C.A. and Tushman, M.L. (2004) The Ambidextrous Organization. *Harvard Business Review* 82 (4) pp. 74-81
- O'Reilly, C.A. and Tushman, M.L. (2013) Organizational Ambidexterity: Past, Present and Future. *The Academy of Management Perspectives* 27 (4) pp. 324-338
- Pike, S. (2008) *Destination Marketing*. Oxford: Butterworth-Heinemann
- Quinn, B. (2013) *Key Concepts in Event Management*. London: Sage Publications Ltd.
- Smith, S.M. (2016) Management and organization: The 21st-century global and international context. In: Stokes, P., Moore, N., Smith, S.M., Rowland, C. and Scott, P. (eds.) *Organizational Management*. London: Kogan Page pp. 1-26
- Stokes, P., Moore, N., Moss, D., Mathews, M., Smith, S.M. and Liu, Y. (2015) The Micro-Dynamics of Intraorganizational and Individual Behavior in Organizational Ambidexterity Boundaries. *Human Resource Management* 54 (S1) pp. 63-86

## EXPLORATORY TEST OF A NEW FOOTBALL CLUB AGGRESSION SCALE

Shuv-Ami, Avichai; Alon, Anat Toder

The School of Business Administration, Peres Academic Center, Israel

### ABSTRACT

### INTRODUCTION

Sports research have examined many different aspects of sport fandom (Wann, Melnick, Russell, & Pease, 2001), however, one of the predominant topics of interest continues to be fan aggression and violence during sporting events. Fan aggression is a societal problem that affects many football clubs worldwide, causing deaths, injuries and extensive property destruction (Dunning 2000; Russell, 2004), and leading to potential economical and reputational damage to sports clubs. The need to understand and leverage sports fans behavior has become especially critical for sports marketers dealing with marketplaces characterize by increasing commercialization (Crawford, 2004). Consequently, it is not surprising that the nature and expression of sports fans aggression are of special interest for both marketers and researchers.

Aggression in sport is defined as any intentional behavior, which is not recognized as legal within the official rules of conduct, directed towards an opponent, official, teammate, or spectator who is motivated to avoid that behavior (Maxwell, 2004). Various studies attempt to measure levels of fan aggression from different perspectives. For example, Buss-Perry Aggression Questionnaire (Buss & Perry, 1992) assesses participants' trait aggression. This scale consisted of four factors with three items measuring each factor: physical aggression, verbal aggression, anger and hostility. In addition, Rocca and Vogl-Bauer (1999) Fan Behavior Measure assesses participants' perceptions of the appropriateness of verbal and physical aggression among sport spectators. This scale consists of twelve Likert-scale items comprising two subscales: appropriateness of verbal aggression (nine items) and appropriateness of physical aggression (three items). Lately, the Dysfunctional Fandom Scale developed by Wakefield and Wann (2006) was designed to assess fan dysfunction. Fan dysfunction concerns the extent to which fans complain about various components of the fan experience (e.g., stadium amenities) and the degree to which they are confrontational (e.g., enjoy arguing with rival fans).

Even though the sports literature has used several types of fan aggression scales, which furthered our understanding of fan aggression, none of those measures examined club aggression. Importantly, the current study proposes that levels of club aggression can serve as a trigger mechanism for fans' violent behavior. Thus, the purpose of this study is to develop a scale that examines levels of club's

aggressiveness. Specifically, the current study attempts to develop a scale which assesses club aggression through two different measures: fan's aggression, which measure participants' perceptions of their favorite team's fan behavior; and team aggression, which measure participants' perceptions of their favorite team aggression (i.e., coach, players and management). Indeed, players' violence, coaches' aggressive behavior, and management's reaction toward fans' violence are important as fan aggression. For example, previous research have showed that player violence and aggressive play on the pitch were related to higher levels of spectator violence (Braun & Vliegenthart, 2008; Semyonov & Farbstein, 1989)

## METHODOLOGY

The two set of data used in the current study were collected from an online panel that comprised more than fifty thousand people over the age of 18. The first set of data used to test the construct validity for the Club Aggression Scale employing Exploratory Factor Analysis using Principal Component with oblique rotation. The second set of data used to test the nomological validity of the scale.

Participants in the first set of data were 244 Israeli football fans. Participants ages ranged from 19 to 81 with a mean age of 43.73 ( $sd = 15.5$ ), 52.9% were males, 50.6% had academic education and 71.1% were married. The participants in the second set of data were 250 Israeli football fans with ages ranged between 19 to 81 with a mean age of 42.1 ( $sd = 15.4$ ), 52% were males, 50.6% had academic education and 67.1% were married.

The current study develops a Club Aggression Scale that has two sub-scales; Fan Aggression and Team Aggression. All items were measured on a 10-point agree-disagree scale. Each of sub-scales had three items (see Table1).

The nomological validity is testing the correlations between the sports club aggression scale and hatred, self-reported aggressiveness and fan's depression. Fan hatred is defined as an extremely strong feeling of dislike toward opponents of the fan's football team. Self-reported aggressiveness represents the way fans feel or think they may offensively behave while watching their team's games. Fan's depression is defined as a state of feeling sad as a result of the performance of his or hers' team. All correlations are expected to be significant and positive.

## RESULTS

Items of the Club Aggression Scale were subjected to exploratory factor analysis with an oblique rotation. According to the criteria of eigenvalue  $> 1$  and Scree test (Hair, Black, Babin, Anderson, & Tatham, 2006) two factors were extracted. On the basis of hypothesized structure and items content, the two factors labeled "Fan Aggression", and "Team Aggression". These factors accounted for 82.1%

of the common variance of the scale. This two factors solution is presented in tables 1. All items loaded highest on the appropriate factor and had substantive loadings that exceeded .60.

Alpha coefficients for the three-item Fan Aggression and the three-item Team Aggression sub-scales were .93 and .83. Correlations among the unit-weighted scale scores were similar to those between the factors. The correlation between the two factors was .58 suggesting discrimination between the factors. The substantial correlations found between the factors justified the use of the oblique rotation and suggested higher order constructs.

Table 1. Factor analysis of the football sports club aggression scale

Sports club aggression items	Factors		Communalities
	Fans' Aggression	Team Aggression	
When watching games, fans of my favorite team tend to curse the opposing team	.99		.93
While watching games, fans of my favorite team tend to curse the referees when they make a call against their team	.99		.93
While watching games, there are situations in which fans of my favorite team behave violently	.73		.81
During the game, the coach of my favorite team act aggressively toward the referees when they make a call against their team		.86	.77
Players of my favorite team play aggressively against opposing teams		.90	.81
In cases where fans behave violently, the team's management does not make enough effort in order to prevent it		.84	.68
Rotated eigenvalue	3.9	1.00	
% of explained variance	65.3%	16.7%	

The nomological validity of the club aggression scale was assessed by testing its relations with three relevant scales in its hypothesized nomological network. As expected, results indicate significant ( $p < .01$ ) and moderate correlations between the sports club aggression scale and hatred ( $r=.32$ ), self-



reported aggressiveness ( $r=.36$ ) and fan's depression ( $r=.35$ ). Thus, these correlations provide evidence for the nomological validity for the football club's aggression scales.

## CONCLUSION

The current study explores a new scale for sports club aggression. Exploratory factor analysis showed that all the items loaded highest on the appropriate factor had substantive loadings. Thus, supporting the hypothesized scale structure that is comprised from two sub-scale; Fan Aggression and Team Aggression. The overall scale and the two sub-scales were found to be reliable. The nomological validity indicates significant relationship between sports club aggression scales and hatred toward opposing teams, self-reported aggressiveness and fan's depression as a result of their team performance.

*Keywords: Football Club Aggression, Scale Development, Fan Aggression, Sports Fan*

## REFERENCES

- Braun, R., & Vliegenthart, R. (2008). The contentious fans: The impact of repression, media coverage, grievances and aggressive play on supporters' violence. *International Sociology, 23*(6), 796-818.
- Buss, A. H., & Perry, M. (1992). The aggression questionnaire. *Journal of Personality and Social Psychology, 63*, 452-459.
- Dunning E. (2000) Towards a Sociological Understanding of Football Hooliganism as a World Phenomenon. *European Journal on Criminal Policy and Research, 8*, 141-162.
- Maxwell, J. P. (2004). Anger rumination: An antecedent of athlete aggression? *Psychology of Sport and Exercise, 5*, 279-289.
- Rocca, K. A., & Vogl-Bauer, S. (1999). Trait verbal aggression, sports fan identification, and perceptions of appropriate sports fan communication. *Communication Research Reports, 16*, 239-248.
- Semyonov, M., & Farbstein, M. (1989). Ecology of Sports Violences: The Case of Israeli Soccer. *Sociology of Sport Journal, 6*(1), 50-59.
- Wakefield, K. L., & Wann, D. L. (2006). An examination of dysfunctional sport fans: method of classification and relationships with problem behaviors. *Journal of Leisure Research, 38*, 168-186.
- Wann, D. L., Melnick, M. J., Russell, G. W., & Pease, D. G. (2001). *Sport fans: The psychology and social impact of spectators*. New York: Routledge Press.

## EXPLORATORY TEST OF A NEW SCALE FOR SPORT FANS SOCIAL AND PERSONAL IDENTITIES

Shuv-Ami, Avichai; Alon, Anat Toder

The School of Business Administration, Peres Academic Center, Israel

### ABSTRACT

### INTRODUCTION

In line with social identity theory (Tajfel & Turner, 1986) and self-categorization theory (Turner, 1987), the current study proposes that sports fans may perceive themselves as unique individuals or as members of the sports club and these two are equally valid expressions of self. Sports fans' social identities (deriving from the sports club in which they perceive themselves to be members) are significant to the self as their personal identity (derived from views of oneself as a unique individual). Social identity theory and self-categorization advocate that the self is in not a fixed entity, but is socially defined in the context. Hence, there are different possible identities that participants can assume within the same interactive context. Accordingly, the choice about what possible self to show is driven by individuals' perception of how the social situation is characterized and what features are more relevant and more effective in that specific situation. Further, social identity and self-categorization theories assume that there are two types of self-regulation: as a group member (social identity salience) and as an individual (personal identity salience) (Reicher, 1987). Importantly, salience relates not just to the general relevance of a group membership, but also to a selective change in self-perception whereby people actually define themselves as unique individuals or as members of groups. Further, these theories acknowledge that the nature of behavior is carefully regulated by the different self-images (Hogg, 2001).

The context of sport fandom represents a kind of middle landscape that allows individuals to exercise their impulses for both separation and connectedness. As such, sports clubs operate as sites where centrifugal and centripetal forces meet. In other words, sports clubs are co-determined by the simultaneous and dynamic forces of fans' desires for independence and uniqueness (i.e., differentiating the individual as distinct from other fans) and for collective identity (i.e., emphasizing the similarities shared with other fans). It is important to note that de-personalization caused by immersion and anonymity in the group does not result in loss of identity or reduced self-awareness. Rather, this de-personalization results in heightened group-level self-regulation (Spears & Postmes, 2015).

## THE SUGGESTED SCALE

Researchers in the self-categorization tradition emphasize that the relative salience of different identity levels depends on the context of interaction of the person (Turner, Oakes, Haslam, & McGarty, 1994). However, following Nario-Redmond et al. (2004), the current study maintains that there is a dispositional tendency toward self-definition at either the personal or social level of identification. Also, it is assumed that such differences are measurable and remain relatively stable over time, moderating self-perceptions and group behaviors across a variety of situations. Consistent with Nario-Redmond et al. (2004), the current study operationalized the social and personal identity constructs of sport fans, as conceptually separable levels of the self.

## METHODOLOGY

The purpose of the current study is to explore a new scale of sports fans' social and personal identities. Participants were recruited using an online panel-based survey that comprised more than fifty thousand people over the age of 18. The participants in this study were 265 Israeli football fans. Participants ages ranged between 19 to 81 with a mean age of 42.0 ( $sd = 15.3$ ), 58.1% were males, 57.7% had academic education and 64.6% were married. The participants for the nomological validity study were 273 Israeli football and basketball fans. Participants ages ranged between 19 to 83 with a mean age of 42.1 ( $sd = 15.6$ ), 59.3% were males, 49.8% had academic education and 67.7% were married.

The *Sports Fans Social-Personal Identities* scale that was developed in the current study follows Nario-Redmond et al. (2004) sixteen items social and personal identities scale. The current scale used eight items that were relevant and thus were modified to fit sports fans context. The question was "Please rate from 1 to 9 how important or unimportant to whom you are, the behavior described in the following sentences. When score 1 means that you think the behavior "is not important to who I am" and "the behavior is very important to who I am." Where items 1, 3, 5 and 8 represent social identity salience and items 2, 4, 6 and 7 represent personal identity salience. In order to create a continuous scale where low is personal identity behavior and high is social identity behavior; the personal identity items were reversed.

1. it's important for me to behave like other fans of my team.
2. I have my own way to be a fan of my team (R)
3. I identify with the nationalist / ideological fans of my team
4. I have the need to be completely distinct and unique from other fans of my team (R)
5. It is important for me to be part of the fan base of my team
6. I have my own creative ways to be a fan of my team (R)
7. I feel that I am different from other fans of my team (R)

8. I have a sense of belonging to my team

## RESULTS

The items of the sports fans' social and personal identities scale were subject to exploratory factor analysis with oblique rotation. According to the criteria of eigenvalue  $> 1$  and Scree test (Hair, Black, Babin, Anderson, & Tatham, 2006) two factors were extracted. Items loaded onto the hypothesized factors (see Table 1). On the basis of hypothesized structure and items content, the two factors were labeled social and personal salience. These factors accounted for 62.9% of the common variance, above the recommended minimum threshold of 60%. All items loaded highest on the appropriate factor and had substantive loadings that exceeded .65. No item was found to have cross loading the exceeded .3 loading on the non-primary factor. The reliability for the overall scale was good (.82), and each subscale had good reliability (greater than .78). In addition, the two factors were correlated at .43 suggesting discrimination between the two factors. The substantial correlations found between the factors justified the use of the oblique rotation.

Table 1. Factor analysis of the sports fans' personal and social identities scale

Sports social and personal identity items	Factors		Communalities
	Personal	Social	
I have my own way to be a fan of my team	.67		.60
I have the need to be completely distinct and unique from other fans of my team	.75		.60
I have my own creative ways to be a fan of my team	.80		.70
I feel that I am different from other fans of my team	.89		.71
It's important for me to behave like other fans of my team		.83	.59
I identify with the nationalist / ideological fans of my team		.83	.58

It is important for me to be part of the fan base of my team	.69	.68
I have a sense of belonging to my team	.84	.66
<hr/>		
Rotated eigenvalue	3.55	1.48
% of explained variance	44.3%	18.5%

Note.  $N = 265$ .

All factor loadings  $> .30$  are presented in the table.

a. Rough estimates based on eigenvalues from the orthogonal, varimax rotation (cannot be estimated for the oblimin rotation due to confounded factors contribution).

The sports fans' social and personal identities scale was assessed by testing its relations with three relevant scales in its hypothesized nomological network. Testing nomological validity with respect to football fans, the results indicate, as expected, significant ( $p < .01$ ) and moderate correlations between the sports fans social and personal identities scale and Wann's (Wann et al. 2001) sports spectator identity ( $r=.55$ ), Shuv-Ami's and others' (Shuv-Ami et al. 2015) fan commitment ( $r=.45$ ) and Shuv-Ami's and others' (Shuv-Ami et al.2017) love for the team ( $r=.51$ ).

## CONCLUSIONS

The current research explores a new scale of Sport Fans Social and Personal Identities. Exploratory factor analysis showed that all the items loaded highest on the appropriate factor had substantive loadings. Thus, establishing the two factors; one for sports fans' personal identity salience and the other for sports fans' social identity salience. The overall scale and the two sub-scales were found to be reliable. The nomological validity indicates significant relationship between sports fans' social and personal identities and their identity as sports spectators, their commitment and their love for their team.

*Keywords: Social and Personal Identities, Social Identity Theory, Scale Development, Football, Sports Fan*

## REFERERNCES

Hair, J. F., Jr., W. C. Black, B. Babin, R. Anderson, and R. Tatham, (2006), *Multivariate Data Analysis*, (6th ed.). Upper Saddle River, NJ: Prentice Hall.

- Hogg, M. A. (2001). Social categorization, depersonalization, and group behavior. In M. A. Hogg & R. S. Tindale (Eds.), *Blackwell handbook of social psychology: Group processes*. Oxford, England: Blackwell, 56-85.
- Nario-Redmond, M. R., Biernat, M., Eidelman, S., & Palenske, D. J. (2004). The social and personal identities scale: A measure of the differential importance ascribed to social and personal self-categorizations. *Self and Identity*, 3(2), 143-175.
- Reicher, S. (1987). Crowd behavior as social action. In J.C. Turner, M. A. Hogg, P.J. Oakes, S.D. Reicher & M.S. Wetherell. *Rediscovering Social Group: A Self Categorization Theory*. Oxford, England: Basil Blackwell, 171-202.
- Shuv-Ami Avichai, Demetris Vrontis and Alkis Thrassou (2017), "Brand lovemarks scale of sport fans," *Journal of Promotion Management*, Volume 23, Issue 2, Forthcoming.
- Shuv-Ami Avichai, Alkis Thrassou and Demetris Vrontis (2015) "Fans' brand commitment to basketball teams - establishing the validity and reliability of a new multidimensional scale," *Journal of Customer Behavior*. 14(4), 329-311.
- Spears, R., & Postmes, T. (2015). Group Identity, Social Influence, and Collective Action Online. *The Handbook of the Psychology of Communication Technology*, John Wiley & Sons, Oxford, 23-46.
- Tajfel, H. (1978). *Diferentiation between social groups*. London: Academic Press.
- Tajfel, H., & Turner, J. C. (1979). An integrative theory of social conflict. In W. Austin, & S.Worchel (Eds.), *The social psychology of intergroup relations*. Monterey, CA: Brooks-Cole.
- Turner, J. C., Oakes, P. J., Haslam, S. A., & McGarty, C. (1994). Self and collective: cognition and social context. *Personality and Social Psychology Bulletin*, 20, 454 – 463.
- Wann, D. L., Melnick, M. J., Russell, G. W., & Pease, D. G. (2001). *Sport fans: The psychology and social impact of spectators*. New York: Routledge Press.

## DISCLOSURE VIA SOCIAL MEDIA AND MARKET REACTION WITHIN THE STAKEHOLDER THEORY

Solimene, Silvia; Coluccia, Daniela; Fontana, Stefano

Dept. Business and Law, Sapienza University of Rome, Italy

### ABSTRACT

The main aim of this project is to analyze corporate disclosure through social media among a sample made of the biggest 100 firms listed on the Eurostoxx 100 and its effect on financial market.

The first part of the research is focused on the identification of the social channel used by the companies (Twitter, Facebook, LinkedIn, Youtube, etc); then, on the selection of the information released during the 2014 and on the attribution to the many stakeholders of the company, in order to find if there is a prevailing stakeholder when companies disseminate their voluntary disclosure.

The latter section of the project is devoted to deepen the significance and the relevance of the disclosure via social media, at a financial market level. In order to do that, we use an Event Study Methodology, carried out by the Event Study Metrics Software.

### THEORETICAL BACKGROUND

#### *The increasing importance of Social Media for Firms*

Corporate use of social media for external communication – using social media to communicate with external stakeholders such as customers, investors, and the general public (Welch and Jackson 2007) – has grown in the past few years. External communication professionals are attracted to social media for its capacity to reach a broad audience, generate spread of information, and engage audiences (Macnamara 2010).

Using social media, corporate communicators hope to fulfill external stakeholders' demands for transparency, particularly in the wake of the loss of public trust incurred by the Enron accounting scandal and the collapse of major financial institutions during the subprime mortgage-induced crisis.

While social media is now expected to be part of the external corporate communications toolbox, such use of social media remains overlooked by academics. This is contrasted starkly by the extensive attention that social media use for internal communication has received, also in knowledge Management, in Knowledge creation and in Knowledge collaboration and sharing field (Zammuto et al. 2007; Wagner and Bolloju 2005; Yates, Wagner, and Majchrzak 2010; Turban, Bolloju, and Liang 2011; Treem and Leonardi 2012; Arazy and Gellatly 2013). Furthermore, the existing studies on social media use in external communications focus on customer (Majchrzak, Wagner, and Yates 2006). Some

Authors have examined the use of social networking sites for product endorsement and customer relationship management (Meadows-Klue 2008; Harris and Dennis 2011; Laroche, Habibi, and Richard 2013). Very little, however, is known about social media use for external audiences other than customers, despite the vital importance of good communication with investors and the general public to firms' financial future (Petersen and Martin 1996; Hutton 1999). As a result, communications specialists "understand they should be doing more with social media but are unsure where to begin" (Schlinke and Crain 2013).

Here, we investigate which stakeholders firms do select to devote their voluntary communication and which channels they use to enhance their communication activities to a wide variety of external stakeholders—not only customers, but also investors, suppliers, environment and the general public. In so doing, we focus on different types of social media tools— Facebook, LinkedIn, Twitter, social networking sites—because these are the types most commonly used for external communications.

Social Media allow different chances consisting on different capabilities users reach through them, such as encouraging active participation, providing audience interconnectivity, and fostering ongoing engagement with the firm, among others. Many of these affordances are unique to social media (Hazleton, Harrison-Rexrode, and Kennan 2007; Jung et al., 2014). Social media are different from Mass media tools that are designed to disseminate and gather information in a monological manner (Kent and Taylor 2002). Therefore, mass media are dissimilar to social media, which foster dialogical communications between firm and audience (Kaplan and Haenlein 2010).

This unique characteristic may help users and practitioners to find appropriate social media tools for specific external communication activities and for specific stakeholders.

#### *Voluntary Disclosure*

The mandatory information has proven to be insufficient to meet the information demand by the various company's stakeholders.

Voluntary disclosure, as it is known, refers to information that is not subject to reporting requirements or certification, whether quantitative or qualitative, regardless of the channel through which it occurs (press releases, annual reports, websites etc.) (Bozzolan, 2005).

There are several reasons that lead companies to supplement the compulsory information with voluntary disclosure. First, voluntary disclosure contributes to low information asymmetries and agency conflicts that arise between managers and investors (Brammer and Pavelin, 2008). Information asymmetries arise because of the presence of different information and conflicting incentives between companies and investors that can potentially lead to a rupture of the proper functioning of the capital market (Akerlof, 1970). The agency conflicts arise as a result of conflicts of interest between managers



and investors. Since the interests of managers very often do not coincide with those of shareholders and creditors, it is possible that managers do act in their own interests (Jensen and Meckling, 1976).

Through voluntary disclosure, on the other side, managers are free to illustrate aspects of management that are not imposed by rules and regulations, which potentially can better capture the relevant features of company management and allow the company to be different compared to competitors (Quagli, 2004). Voluntary disclosure allows greater understanding of the Company and the opportunity to reach a broader range of investors. In addition, through the use of additional information to the mandatory disclosure, the company is able to build credibility towards its investors by communicating information which can help them to create valid expectations about the future performance of the company.

As a toolbox of voluntary disclosure managed by companies, the information via social media is a new topic on the research ground, within the mainflow of Voluntary Disclosure.

Our project is on the price-sensitivity of voluntary disclosure released via social media, in a multistakeholder perspective. To our knowledge this is the first study that combine these three aspects of disclosure of firms. All the previous researches were conducted on single stakeholder. Infact, the only empirical research existing on voluntary disclosure in a multi-stakeholder perspective is that of Boesso and Kumar (2007) who gave an initial step in the direction of examining voluntary disclosure from a multi-stakeholder perspective with 5 stakeholder groups (Investor; Employee; Customer; Supplier; Social and Environmental). They identified new drivers of voluntary disclosure other than what previous literature did. Differently from prevoius literature on the topic, our willing is to relate, for the first time to our knowledge, the voluntary disclosure to all categories of stakeholders identified by the literature (abroad theory), however, in a different way from what previously was done. In fact, we qualify the disclosure according to the content of such disclosure. In this perspective, the stakeholders become the object, ie the content of information, not the recipients of it. In this sense, the disclosure is qualified in various ways (disclosure on customers, suppliers, institutions, human capital and corporate governance, and so on). We also add to the literature the component of the relevance of multistakeholder disclosure via social media to the financial market.

## **METHODOLOGY**

### *Premise*

Our research has took inspiration form the Netflix case.

Netflix, in 2012, was involved in a case of fair disclosure. July 3, 2012 the founder of Netflix, Reed Hastings, announced through his Facebook profile that Netflix had reached a content of a billion hours of streaming. Hasting in the past had never used Facebook to make similar corporate announcements.

In addition post on Facebook Netflix founder was not accompanied either by a press release or a Form 8-K (The Form 8-K is a form used to alert investors of listed companies in the United States of specific events that may be important to the member or to the SEC).

The SEC began to investigate the following aspects of the case:

- a) The application of Regulation Fair Disclosure (FD) to the post of Hastings;
- b) The applicability of the 2008 Guide.

At the end of the investigation the Commission decided not to initiate any action against Netflix. However, it was the occasion to issue a survey report containing guidelines to be followed by issuers while disseminating the public disclosure of sensitive and confidential information. Corporate disclosure must be made in accordance with the provisions of Regulation FD (Fair Disclosure) whenever such information is disclosed to any interest group. In this regard, the issuer has to determine whether disclosure includes material and/or confidential information. Whenever the issuer decides not to issue a Form 8-K, the company should ensure that information is disseminated in a "reasonable" manner so that a greater part of the public have access to such information. The issuer also must declare to its investors the communication channels to be used for the dissemination of material and confidential information. The SEC report is not intended to inhibit corporate communication through social media because the commission has confirmed his appreciation to it as a means of communication.

In literature, the effects of information disclosed to the market is closely linked to the line of research on a single event introduced by Fama, Fisher, Jensen and Roll in 1969. Such studies offer valuable insights into how stock prices do react to information. Over time several studies have took place in this field, such as, for instance, those on the effect on the market of good and bad news (Skinner, 1994, 1997).

Over time, the voluntary disclosure has also been conveyed through social media. They became extraordinarily popular and are transforming the communication strategy of companies. It is estimated that over 70% of Fortune 500 companies has an official page or an account on Facebook, Twitter or LinkedIn.

Given the increase on the use of social networks by companies, the literature dealing with this topic is still poor (Jung et al. 2014), most of all about how many firms use social media to communicate financial information to investors and how investors process information provided through social media channels. Among the empirical research existing on social media disclosure, it has been demonstrated that among the social media channels Twitter is the most occurring to disclose financial voluntary information, while few companies do act the Facebook channel (Blankespoor et al. 2014). But, to some companies, social media channels are not a way to disseminate all relevant and significant information (bad or good), but only to communicate good news to the market in order to manage

stakeholder perception of the firm. As about “good” and “bad” news, previous literature (Healy e Palepu 2001; Skinner 1994; Aboody and Kasznik 2000; Trueman,1986) has demonstrated that, normally, only good news go through social media channels. In particular, quarterly earnings are useful for market participants who need to take their investment decisions. Diamond and Verrecchia (1991) has shown that information that has the power to reduce information asymmetry makes the share price more highly liquid. On the other side, Kim e Verrecchia (1994) demonstrated that the quarterly earnings financial announcement may enable some operators to formulate upper judgments: this leads to greater information asymmetry and a lower liquidity within the market.

## RESEARCH DESIGN

As for the first part of the methodology, we will select all the voluntary information released through social media channel over the year 2014 among the sample, despite the characteristic of the information (quantitative or qualitative). This phase will be carried on empirically by the group of the researchers. Then, we will gather the information in order to assess which stakeholder is interested by the information. In this research, we identify the following stakeholder from major Stakeholder Theory:

- customers;
- supplier;
- competitors;
- financial lenders;
- community;
- human capital and corporate governance;
- environment;
- institutions;

At a descriptive level, we will be able to identify the prevailing stakeholder as for the dissemination of the information from a company, for every social media channel.

As for the second part of the methodology, our efforts will be addressed to understand if there is an effect of the information on the market, using the Event Study Methodology.

The first step of Event Study methodology is to determine an equation (market model) able to correctly predict the returns of the  $i$ -th title. You can estimate the expected return of a stock  $i$  ( $R_i$ ) by assuming that it depends linearly on the market return ( $R_m$ ) according to the following relationship:

$$R_{i,t} = \alpha_i + \beta_i \cdot R_{m,t} + \epsilon_{i,t}$$

Where:

- $\alpha_i$  and  $\beta_i$  are the coefficients that need to be estimated by regression in a period (estimation window) prior to the period of investigation; and

- $\varepsilon$  is the error term.

In particular, the coefficients are estimated by regressing the logarithmic returns of the title compared to logarithmic returns recorded by the chosen market parameter along the estimation window.

Each coefficient estimated by the model is associated with a t-statistic that measures the level of significance. The logarithmic return on a security or an index is obtained from the observation of market prices in a given period using the following formula:

$$R_t = \ln(P_t/P_{t-1})$$

Where:

$P_t/P_{t-1}$  are the market share price (or index value) at time  $t/(t-1)$ . The predictive validity of a model is defined by its RSquared, namely the portion of variance explained by the performance of the stock market return. After the estimation of  $\alpha_i$  and  $\beta_i$ , the next step of the methodology consists of calculating the expected returns of the title by the following equation:

$$E(R_{i,t}) = \alpha_i + \beta_i \cdot R_{m,t}$$

Then, the Abnormal return ( $AR_{i,t}$ ) in the event window is estimated by the following:

$$AR_{i,t} = R_{i,t} - E(R_{i,t})$$

Where  $R_{i,t}$  e  $E(R_t)$  are respectively the effective and the expected stock return of for  $t$  time.

To test whether the deviation is considered abnormal or is due to the case, it is necessary to estimate the statistical significance. The null Hypothesis is that  $AR_{i,t}=0$  ( $H_0: AR_{i,t}=0$ ), and it is verified by the absolute value of the T-statistic

In the case the null hypothesis is verified, it can be concluded that abnormal returns are not statistically different and that therefore the difference between the effective return and expected yield has not been caused by specific events having an impact on the stock price, but due to chance.

If it appears that the AR estimates are statistically different from zero it can be said that the abnormal changes were caused by a specific event.

Starting from a single abnormal return is also possible to obtain the cumulative abnormal return (Cumulative Abnormal Return, CAR) until the  $n$  period, in order to capture any price changes before and/or after the date of the event and related to the event itself:

$$CAR_n = \sum AR_t$$

As for AR, we will verify the statistical significance of the CAR.

The methodology involves the following steps:

- a) Identification of the event to be analyzed ("Event"), for us the event is the disclosure selected during the 2014 coming from different social media channels;

- b) Choosing the time window to study the effects (“Event window”). Usually the event window is chosen in a time interval that begins before the event and ends after it, according to the possibility that the market anticipates the information and that the price effects will last for few days;
- c) Definition of a time period (“Estimation window”), prior to the event window, in which to estimate the relationship between the stock and the market return and to estimate the equations. This relationship is to be estimated through regression of the market model which will lead us to the stock expected returns;
- d) Calculation of Abnormal Returns (AR) in event window, as the difference between actual and expected stock returns, so as to remove by the performance under the effects of market trends;
- e) Validation of the statistical significance of AR to determine if the deviation between abnormal and expected returns is due to chance or has an economic belonging.

The dates on which material information is disclosed to the market, the AR measures the impact it had on the stock price, that is because the stock return has deviated from its expected return.

If the deviation is not statistically significant, it can be concluded that the AR is not relevant from an economic point of view; but if the AR is statistically significant, it can be asserted that the difference between the actual and the expected stock return has an economic sense and therefore that the information to the market is “material”; the higher is the AR, the more “material” is the information disclosed.

In the end, the case study will allow us to better understand if voluntary disclosure via social media has a real effect on the market at a financial level. In particular, we will try to identify, by an Event Study, the content of the information relevant to the market, namely the price-sensitive information. Further, to capture which stakeholder is mostly accounted for in voluntary terms, in order to suggest for the future if the voluntary disclosure is a way to address transparency to stakeholders or to manipulate them (Arena et al., 2015).

*Keywords: Social Media, Corporate Disclosure, Financial Market.*

## REFERENCES

- Aboudy D., Kasznik R. (2000), CEO stock option awards and the timing of corporate voluntary disclosures, *Journal of Accounting and Economics*, 29, pp. 73-100.
- Akerlof G.A. (1970), The Market for "Lemons": Quality Uncertainty and the Market Mechanism, *The Quarterly Journal of Economics*, 84(3), pp. 488-500.
- Arazy, O., & Gellatly, I. (2013). Corporate wikis: The effects of owners' motivation and behavior on group members' engagement. *Journal of Management Information Systems*, 29, 87-116.
- Arena C., Bozzolan C., Michelon G. (2015), Environmental reporting: Transparency to stakeholders or stakeholder manipulation? An analysis of disclosure tone and the role of the board of directors, *Corporate Social Responsibility and Environmental Management*, 22 (6), pp. 346-361.

- Blankespoor E., Miller G.S., White H.D. (2014), "The Role of Dissemination in Market Liquidity: Evidence from Firms' Use of Twitter", *The Accounting Review*, 89(1), pp. 79-112.
- Boesso G., Kumar K. (2007), Drivers of corporate voluntary disclosure : A framework and empirical evidence from Italy and the United States, *Accounting, Auditing & Accountability Journal*, 20(2), pp. 269-296.
- Bozzolan S. (2005), *Trasparenza informativa e mercato finanziario: modelli e comportamenti di comunicazione volontaria*, McGraw-Hill.
- Brammer S., Pavelin S. (2008), Factors Influencing the Quality of Corporate Environmental Disclosure, *Business Strategy and the Environment*, 17, 120–136.
- Diamond D.W. , Verrecchia R.E. (1991), Disclosure, Liquidity, and the Cost of Capital, *The Journal of Finance*, 46(4), pp. 1325–1359.
- Efraim Turban, Narasimha Bolloju & Ting-Peng Liang (2011): Enterprise Social Networking: Opportunities, Adoption, and Risk Mitigation, *Journal of Organizational Computing and Electronic Commerce*, 21(3), pp. 202-220.
- Fama E.F., Fisher L., Jensen M.C., Roll R. (1969), The Adjustment Of Stock Prices To New Information, *International Economic Review*, Vol. 10.
- Harris L. and Dennis C. (2011), Engaging customers on Facebook: Challenges for e-retailers, *Journal of Consumer Behaviour*, 10, pp. 338–346.
- Hazelton V., Harrison-Rexrode J. Kennan, W. (2007), New technologies in the formation of personal and public relations; Social capital and social media. In S. Duhe (Ed.), *New media and public relations* (pp. 91-105). New York: Peter Lang.
- Healy P.M., Palepu K.G. (2001), Information asymmetry, corporate disclosure, and the capital markets: A review of the empirical disclosure literature. in *Journal of Accounting and Economics*, 31, pp. 405-440.
- Jeffrey W. Treem, Paul M. Leonardi (2012), Social Media Use in Organizations: Exploring the Affordances of Visibility, Editability, Persistence, and Association, *Communication Yearbook*, Vol. 36, pp. 143-189.
- Jensen M.C., Meckling W.H. (1976), Theory of the firm: Managerial behavior, agency costs and ownership structure, *Journal of Financial Economics*, 3(4), pp. 305-360.
- Kaplan A.M, Haenlein M. (2012), Social media: back to the roots and back to the future *Journal of Systems and Information Technology*, Vol. 14 No. 2, pp. 101-104.
- Kent M., Taylor M. (2002), Toward a dialogic theory of public relations. *Public Relations Review* 28(1), 21–37.
- Kim O., Verrecchia R.E. (1994), Market liquidity and volume around earnings announcements, *Journal of Accounting and Economics*, 17(1–2), pp. 41-67.
- Laroche M., Habibi M.R., Richard M.O. (2013), To be or not to be in social media: How brand loyalty is affected by social media?, *International Journal of Information Management*, 33, pp.76– 82.
- Macnamara, J. (2010), Public communication practices in the Web 2.0-3.0 mediascape: The case for PRevolution, *PRism* 7(3): <http://www.prismjournal.org>.
- Majchrzak, A., Wagner, C., and Yates, D. (2006), Corporate wiki users: Results of a survey, *WikiSym'06*, Odense, Denmark, pp. 21 – 23.
- Meadows-Klue D. (2008), Opinion piece: Falling in Love 2.0: Relationship marketing for the Facebook generation, *Journal of Direct Data and Digital Marketing Practice* 9(3), pp. 245-250.
- Quagli A. (2004), *Comunicare il futuro: l'informativa economico-finanziaria di tipo previsionale delle società quotate italiane*, Francoangeli.
- Schlinke J. CrainS. (2013), Social Media from an Integrated Marketing and Compliance Perspective, *Journal of Financial Service Professionals*, 67(2), p. 85-92.
- Skinner D.J. (1994), Why Firms Voluntarily Disclose Bad News, *Journal of Accounting Research*, 32(1), pp. 38-60.
- Skinner D.J. (1997), Earnings disclosures and stockholder lawsuits, *Journal of Accounting and Economics*, 23, pp. 249-282.
- Trueman B. (1986), Why do managers voluntarily release earnings forecasts?, *Journal of Accounting and Economics*, 8(1), pp. 53-71.
- Wagner C. and Bolloju N. (2005), Supporting Knowledge Management in Organizations with Conversational Technologies: Discussion Forums, Weblogs, and Wikis, *Journal of Database Management*, 16(2), pp. i-viii.
- Welch, M., & Jackson, P. R. (2007). Rethinking internal communication: A stakeholder approach. *Corporate Communications: An International Journal*, 12(2), 177–198.
- Yates, D., Wagner, C., and Majchrzak, A. (2010), Factors affecting shapers of organizational wikis, *Journal of the American Society for Information Science and Technology*, 61(3), pp. 543 – 554.
- Zammuto, R. F., T. L. Griffith, A. Majchrzak, D. J. Dougherty and S. Faraj (2007), Information technology and the changing fabric of organization, *Organization Science*, 18, pp. 749–762.

# A GENERALISED PROPENSITY SCORE ANALYSIS TO INVESTIGATE INFLUENCE OF AGRICULTURAL RESEARCH SYSTEMS ON GHGS EMISSIONS

**Spada, Alessia; Fiore, Mariantonietta; Contò, Francesco**

Dept. of Economics, University of Foggia, Foggia, Italy

## ABSTRACT

## INTRODUCTION

Sustainable innovation management can give the chance to face new global challenges and can move ahead the transition from a waste economy to an economy based on renewable resources and sustainable consumption (Bresciani et al., 2015). Air pollution is a grave issue in green challenges, mainly caused by anthropogenic factors. Agriculture sector is a great contributor to global GHGs emissions due to lacking efficient management of the resources involved and research policies (Alemu et al., 2017; Cerri et al., 2016). In particular, livestock sector contributes to emissions of GHGs, deforestation, and nutrient imbalances. More effective agricultural research systems and technologies are necessary in order to improve farm productivity but also to reduce the GHGs emissions. The aim of this research is to evaluate the impact of ASTI (Agricultural Science and Technology Indicators) R&D on GHGs emissions for some international countries in 2013.

## METHODS

The work collects data from FAOSTAT statistics concerning 28 OECD countries in 2012. We study the effects of ASTI on the emissions that result from the variation in the intensity of the treatment by means of generalized propensity score (GPS) procedures, estimating a dose-response function, also considering a set of covariates. The focus is on understanding how the effect of ASTI for 28 countries (variables) on the enteric emission (outcome) varies at different levels, using stock with covariates, based on a generalization of the Rosenbaum and Ruby propensity score. Propensity-based techniques have long been used for causal inference in observational studies to reduce the injury caused by non-randomized treatment. In recent years, Imbens and Hirano (2004) have suggested extending the propensity score for ordinal and categorical treatments respectively. In this study, the adjustment of GPS is obtained by inserting, as covariates, population and inventories in the result of regression. We also compared the GPS approach with the usual regression in order to estimate a function. Then, we use the corresponding Hirano and Imbens (2004) GPS to estimate ASTI's impact on emissions. In the

context of this study, two important advantages of the GPS estimator are the ability to capture potential non-linearity in the relationship between emissions and countries heterogeneity. Because GPS is a non-parametric estimator, no specific functional form for the R & D productivity ratio must be imposed a priori.

## RESULTS

Results show the existence of influence of ASTI R&D on GHGs across 28 countries with a decreasing dose-response function for treatments, with no local minimum that is, as ASTI grows, emissions continue to decline (Fig. 1). Implications are crucial: reducing GHGs emissions by means of R&D based policies and correlatively reaching efficient resources management through green available practices could have a crucial role for intra-generational fairness. To our knowledge, this work is the first application GPS of in the context of the impact assessment of Agricultural Research Expenditure on the control of Enteric Emissions.

Fig. 1 : Results from dose response function

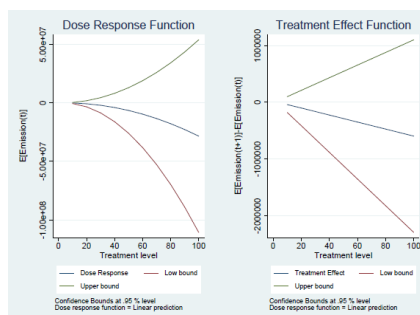

Source: our processing on FAOSTAT database

Efforts should target single practices (e.g. vaccination against rumen methanogens), but also take into account the interactions between practices, to develop suites of effective mitigation practices for specific production systems (FAO, <http://www.fao.org/home/en/>).

*Keywords: Agricultural research systems, GHGs emissions, generalized propensity score, dose-response function, innovation management*

## REFERENCES

- Alemu, A.W., Amiro, B.D., Bittman, S., MacDonald, D., Ominski, K. H. (2017), "GHGs of Canadian Cow-Calf Operations: A Whole-Farm Assessment of 295 Farms", *Agricultural Systems*, 151, 73-83.
- Bresciani, S., Thrassou, A., & Vrontis, D. (2015), "Strategic R&D internationalisation in developing Asian countries. The Italian experience", *World Review of Entrepreneurship, Management and Sustainable Development*, 11(2-3), 200-216.



Cerri, C. C., Moreira, C. S., Alves, P. A., Raucci, G. S., Castigioni, B. D. A., Mello, F. F. C., . . . Cerri, C. E. P. (2016), "Assessing the carbon footprint of beef cattle in brazil: A case study with 22 farms in the state of Mato Grosso", *Journal of Cleaner Production*, 112, 2593-2600.

Hirano, K., Imbens, G. (2004), "The propensity score with continuous treatment". In: Gelman, A., Meng, X.-L. (Eds.), *Applied Bayesian Modelling and Causal Inference from Missing Data Perspectives* Wiley, New York, 73-84.

# SUBSIDIARY'S DUAL RELATIONAL EMBEDDEDNESS FOR THE MANAGEMENT OF KNOWLEDGE NETWORKS IN EUROPEAN MULTINATIONAL FIRMS

Tardivo, Giuseppe<sup>1</sup>; Ferraris, Alberto<sup>2</sup>; Bresciani, Stefano<sup>1</sup>

<sup>1</sup>Department of Management, University of Torino

<sup>2</sup>Department of Management, University of Torino and Laboratory for International and Regional Economics, Graduate School of Economics and Management, Ural Federal University.

## ABSTRACT

### OBJECTIVE(S)

This paper arises due to the emergence of the growing phenomenon of "dual embeddedness" of MNC's subsidiaries (Figuereido, 2011; Achcaoucaou et al., 2014; Ciabuschi et al., 2014; Ferraris, 2014) in IB studies and to the relevance of networks of knowledge (Del Giudice et al., 2010; Nicotra et al., 2014; Ferraris et al., 2016). The main objectives of this paper are: a) to conceive relational embeddedness as one of the main source and tool for knowledge sharing and transfer within MNCs in a globalized scenario; b) to highlight how external and internal relational embeddedness impact and interact in the process of knowledge transfer; c) to explain how subsidiary's dual relational embeddedness is useful in order to leverage and exploit a geographically dispersed body of knowledge in an effective manner.

### RELEVANT THEORIES

In order to reach the objectives of this paper, we mainly based our analysis on the stream of literature that refers to relational embeddedness. Several IB scholars have studied embeddedness phenomena in particular from two different dimensions: structural and relational. Moran (2005) refers to structural embeddedness as the configuration of network relationships, i.e. the presence or absence of network ties between actors along with structural characteristics such as connectivity and centrality, whereas relational embeddedness concerns the quality of the network relationships. Relational embeddedness, which is the focus of our paper, is based on principles such as mutual adaptation, interdependence, and trust between counterparts (Uzzi, 1997).

Moreover, relational embeddedness varies in its degree from *arm's length linkages* to *knowledge-intensive linkages* (Figuereido, 2011; Ferraris, 2016). Arm's length linkages are relationships that are based on a lack of social closeness between the actors and have some key features: a) they are based on a profit-seeking and opportunistic logic, b) they tend to be more infrequent, and c) they may difficultly enable

the discovery of opportunities of potential partners and knowledge (Granovetter, 1985). Embedded or knowledge-intensive linkages, instead, are based on strong social attachments involving trust and reciprocity (Uzzi, 1997) and a long-term perspective. Through such linkages the firm can acquire different types of distinctive knowledge and skills (Maggioni and Del Giudice, 2011). The manner and the frequency of the firm's engagement in such linkages may generate benefits for the firm in terms of knowledge accumulation and dissemination and innovative performance (Figuereido, 2011; Ciabuschi, 2014). Specifically, the relational embeddedness approach emphasizes that firms can acquire strategic assets through interfirm linkages embedded in social relations and networks in order to achieve competitive advantage (Uzzi, 1997). In a MNC context, there are two kind of relational embeddedness: external embeddedness, that is characterized by each subsidiary being embedded in a specific business network (Andersson et al., 2002; Ciabuschi, 2014) and internal embeddedness that is characterized by each subsidiary being embedded in the corporate network, i.e. headquarters and sister subsidiaries (Yamin and Andersson, 2011; Achcaoucaou et al., 2014; Bresciani and Ferraris, 2016).

## METHODS

It has been taken the list of the largest 500 corporations in the world published annually by *Fortune* magazine that is one of the most important annual ranking of the firm worldwide as measured by revenue. In this list, 152 European MNCs has been individuated through Amadeus database. Thus, using a standardised questionnaire, specific data were collected through a postal survey between 2013 and 2014. This study focuses on European subsidiaries of MNCs with HQs located in Europe that are active in knowledge generation and transfer ("Integrated Player" in the sense of Gupta and Govindarajan, 1991). Due to incorrect answers or missing values the final sample includes answers from 165 subsidiaries. An OLS regression analysis has been performed in order to test the effect of both internal and external relational embeddedness on the degree of knowledge transfer.

### Degree of Knowledge transfer:

The operationalization was adopted from Gupta and Govindarajan (2000) and Mimbaeva (2007). Data was collected on the following items: marketing know-how, distribution know-how, packaging design/technology, product designs, process designs, purchasing know-how, and management systems and practices. Subsidiary respondents were asked to evaluate the degree of knowledge transferred from its unit to other units (HQ or sister subsidiaries) for each aspect using a five-point Likert-type scale, where 1 indicated very low use of knowledge by the subsidiary and 5 indicated

substantial use of knowledge. Responses were averaged to yield a composite index reflecting the degree of knowledge transferred to the focal subsidiary.

#### Subsidiary's internal and external embeddedness

The variable *external and internal embeddedness* capture the characteristics of the focal subsidiary's network, by examining the relationships with and among various external and internal network actors, such as customers, suppliers, research centers, universities and competitors for external one and MNC's HQ and sister subsidiaries for internal one. The variable comprises four indicators reflecting the extent to which the relationships in the subsidiary's external and internal business network are characterized by aspects of embeddedness. They are: a) degree of specific adaptations in technology among network counterparts, b) long-term orientation and stability of the relationships, and the level of c) interdependence and of d) mutual trust (Hallin et al., 2011). The indicators were measured on a five-point Likert-type scale ranging from 1 (very low), to 5 (very high). The average value was used when constructing the two variables

## **MAIN FINDINGS AND CONTRIBUTIONS**

The main findings are: a) an high level of subsidiary's internal embeddedness positively affected the degree of knowledge transfer through an increase in building relationships with other internal counterparts based on reciprocity, trust and frequency; b) an high level of subsidiary's external embeddedness did not directly affect the degree of knowledge transfer leveraging to a increase in the ability and in the willingness of senders to transfer knowledge; c) an high level of both internal and external embeddedness reinforce the positive effect of the internal one on the degree of knowledge transfer due to interdependencies between the external and internal embeddedness.

In line with these findings, the main theoretical contributions are: a) to propose a dual relational way in managing knowledge flows in MNCs through subsidiary's embedded ties; b) to suggest MNCs managers how to manage their networks of knowledge, leveraging and exploiting knowledge in the home country and in all the host countries where they operate through their subsidiaries; c) to individuate positive effects that arise from the combination and interaction of internal and external embeddedness that is, in practice, rarely sought by subsidiaries and that could be a source of dynamic capabilities (these are shaped by enabling variables within and outside the firm).

*Keywords: dual embeddedness, relational embeddedness, subsidiary, knowledge transfer, multinational companies*

## REFERENCES

- Achcaoucaou, F., Miravittles, P., León-Darder, F. (2014). Knowledge sharing and subsidiary R&D mandate development: A matter of dual embeddedness. *International Business Review*, 23(1), 76-90.
- Andersson, U., Forsgren, M., Holm, U. (2002). The strategic impact of external networks: Subsidiary performance and competence development in the multinational corporation. *Strategic Management Journal*, 23(11), 979-996.
- Bresciani, S., Ferraris, A. (2016) "Innovation-receiving Subsidiaries and Dual embeddedness: impact on business performance", *Baltic Journal of Management*, Vol. 11 No.1, pp. 108-130.
- Ciabuschi, F., Holm, U., Martín Martín, O. (2014). Dual embeddedness, influence and performance of innovating subsidiaries in the multinational corporation. *International Business Review*.
- Del Giudice M., Della Peruta M.R., Carayannis E. (2010), *Knowledge and the Family Business*, Springer, New York, ISBN 978-1-4419-7352-8
- Ferraris A. (2014). Rethinking the literature on "multiple embeddedness" and subsidiary-specific advantages. *Multinational business review*, 22(1), 15-33.
- Ferraris, A. (2016), *La gestione delle imprese multinazionali e le principali dinamiche e sfide dell'international business*, Giappichelli, Torino.
- Ferraris, A., Bresciani, S., Del Giudice, M. (2016). International diversification and firm performance: a four-stage model. *EuroMed Journal of Business*, 11(3), pp.362-375.
- Figueiredo, P. (2011). The role of dual embeddedness in the innovative performance of MNC subsidiaries: evidence from Brazil. *Journal of Management Studies*, 48, 417-440.
- Granovetter, M. (1985). Economic action and social structure: The problem of embeddedness. *American Journal of Sociology*, 91(3), 481-510.
- Gupta, A.K., Govindarajan, V. (1991). Knowledge flows and the structure of control within multinational corporations. *Academy of management review*, 16(4), 768-792.
- Gupta, A.K., Govindarajan, V., (2000). Knowledge Flows within MNCs, *Strategic Management Journal*, 21(4), pp. 473-496.
- Hallin, C., Holm, U., Sharma, D. D. (2011). Embeddedness of innovation receivers in the multinational corporation: Effects on business performance. *International Business Review*, 20, 362-373.
- Maggioni V. Del Giudice M. (2011), *Relazioni sistemiche tra imprenditorialità interna e gemmazione d'impresa: una ricerca empirica sulla natura cognitiva delle nuove imprese*, Sinergie rivista di studi e ricerche, 71
- Minbaeva, D. B. (2007). Knowledge transfer in multinational corporations. *Management International Review*, 47(4), 567-593.
- Moran, P. (2005). Structural vs. relational embeddedness: Social capital and managerial performance. *Strategic management journal*, 26(12), 1129-1151.
- Nicotra, M., Romano, M., Del Giudice, M. (2014). The evolution dynamic of a cluster knowledge network: the role of firms' absorptive capacity. *Journal of the Knowledge Economy*, 5(2), 240-264.
- Uzzi, B. (1997). Social structure and competition in interfirm networks: The paradox of embeddedness. *Administrative Science Quarterly*, 42(1), 35-67.
- Yamin, M., Andersson, U. (2011). Subsidiary importance in the MNC: What role does internal embeddedness play?. *International Business Review*, 20, 151-162.

## THE CUSTOMER EXPERIENCE WITH SELF-SERVICE TECHNOLOGIES IN SERVICE ENCOUNTERS

Teixeira, Antonio Samuel<sup>1</sup>; Nobre, Helena<sup>2</sup>; Simões, Cláudia<sup>3</sup>

<sup>1</sup>EEG, University of Minho, Braga, and GOVCOPP, University of Aveiro, Aveiro, Portugal

<sup>2</sup>DEGEIT, GOVCOPP, University of Aveiro, Portugal

<sup>3</sup>School of Economics and Management (EEG), University of Minho, Braga, Portugal

### ABSTRACT

Customer experience (CE) is a holistic notion embracing different situations in service delivery and consumption. The focus on CE has increased among service researchers and practitioners over the last decades (Heinonen *et al.*, 2010; Lipkin, 2016). Building a meaningful CE is the key to achieving competitive advantage and satisfied customers (Bolton *et al.*, 2014). Prahalad and Ramaswamy (2004) argue that CE is co-created by the customer and the service provider in an interactive process in which customers co-create unique experiences during their contact with the service at different touch points (Vargo and Lusch, 2004). Such view assumes that customers create their personal experience with a service (Helkkula *et al.*, 2012; Verhoef *et al.*, 2009) and can develop their own setting for the service process and experience. Customers choose specific service aspects that will shape things according to their own experiences (Heinonen *et al.*, 2010). Under this perspective, value-in-use has been regarded as a process in which value is achieved during the interactive process itself (Heinonen *et al.*, 2010).

Creating strong, positive experiences within the customer journey will result in improvements to create unique experiences (Lemon and Verhoef, 2016). Yet, the area is challenging because of the increasing number and complexity of customer touch points. This study addresses the CE in settings where self-service technologies (SSTs) are used. SSTs are “technological interfaces that enable customers to produce a service independently of direct service employee involvement” (Meuter *et al.*, 2000 p. 50). SSTs transformed the way service companies relate to customers (Wang *et al.*, 2012) given that the usual “high-touch and low-tech” in service encounters has been complemented with the “high-tech and low-touch” technological interfaces (Bitner *et al.*, 2000). The introduction of SSTs changes the interaction between service providers and customers because traditional encounters become supported or transformed by technological interfaces (Bitner *et al.*, 2000). The increasing number of interactions with SSTs affects the way consumers experience the service encounters creating challenges and opportunities for companies (Åkesson *et al.*, 2014). Consequently, traditional processes of service delivery can be enhanced by the use of technological platforms.

Researchers have been addressing CE from an SST perspective (Lemon and Verhoef, 2016). In particular, previous studies on SSTs have focused on variables with positive and negative impact on the adoption and continued use of SSTs (e.g. Meuter *et al.*, 2000). CE in this new arrangement has also

been carried out to understand the perception of customers in several distinct circumstances: for example airlines, retailing, and hotels (Wang *et al.*, 2012). Yet, Lemke *et al.*, (2011) observe that the outcome of CE has not been the center of most of the theoretical models because the literature on CE is relatively recent (Lemon and Verhoef, 2016). There is a call to create a model in which CE is the outcome in the moment of purchase (Lemon and Verhoef, 2016). The objective of this research is to develop and empirically test a research model where CE is the outcome variable. The quantitative methods, like scales, will be used to measure this model. We propose a preliminary conceptual framework including independent variables affecting CE. The framework is developed in the context of the SSTs. It is our view that perceived usefulness (PU), perceived ease of use (PEOU), hedonic value (HV), utilitarian value (UV) and convenience (CO) will affect CE. The literature provided some scales to measure the independent and dependent variables presented in this model by a questionnaire. PU and PEOU affect directly consumer's attitude in the adoption of any new technology, which is based on the easy understanding and operating with SSTs because customers want a comfortable experience during the use of technology. See figure 1.

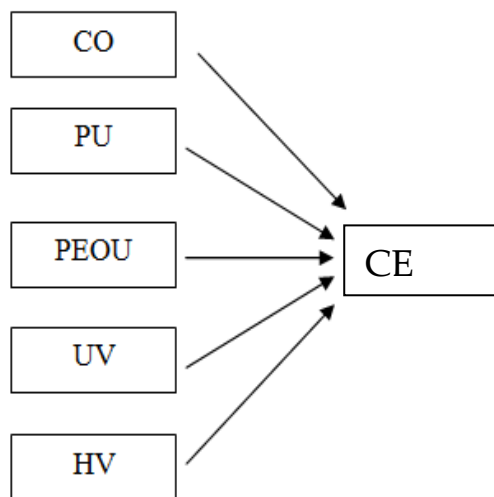

**Figure 1 - Preliminary conceptual framework**

The purpose of the study is to access the consumer's perceptions in a CE context and analyze the factors that can help to improve their experience with SSTs. It then becomes possible to understand consumer's reactions to the self-service technology efforts. Aforementioned building a meaningful CE is a key to achieve competitive advantage and satisfied customers. In terms of contribution to the literature, it is improve the understanding about the CE because as mentioned before some authors (Lemke *et al.*, 2011; Lemon and Verhoef, 2016) asked for CE as outcome in the models because CE literature is relatively new. Clearly, this model it is in development, so during the process can be added some control variables.

## ACKNOWLEDGEMENTS

This research is supported by the FEDER funds through COMPETE 2020, from the Operational Program for Competitiveness and Internationalization (POCI), and by National Funds through FCT – Foundation for Science and Technology, within the financial support assigned to the research unity GOVCOPP (POCI-01-0145-FEDER-0085).

*Keywords: customer experience, self-service technologies, SSTs, service encounter, value-in-use, retailing industry.*

## REFERENCES

- Åkesson, M., Edvardsson, B. and Tronvoll, B. (2014), "Customer experience from a self-service system perspective", *Journal of Service Management*, Vol. 25 No. 5, pp, 677–698.
- Bitner, M.J., Brown, S.W. and Meuter, M.L. (2000), "Technology Infusion in Service Encounters", *Journal of the Academy of Marketing Science*, Vol. 28 No. 1, pp, 138–149.
- Bolton, R.N., Gustafsson, A., McColl-Kennedy, J., Sirianni, N.J., and Tse, D.K. (2014), "Small details that make big differences: a radical approach to consumption experience as a firm's differentiating strategy", *Journal Service Management*, Vol. 25 No. 2, pp, 253–274.
- Froehle, C.M. and Roth, A. V. (2004), " New measurement scales for evaluating perceptions of the technology-mediated customer service experience", *Journal of Operations Management*, Vol. 22, No. 1, pp, 1–21.
- Heinonen, K., Strandvik, T., Mickelsson, K-J., Edvardsson, B., Sundstrom, B. and Andersson, P. (2010) "A Customer-dominant Logic of Service", *Journal of Service Management* Vol. 21, No.4, pp, 531–48.
- Helkkula, A. Kelleher, C. and Pihlstrom, M. (2012), "Characterizing Value as an Experience: Implications for Service Researchers and Managers", *Journal of Service Research*, Vol. 15, No. 1, pp, 59–75.
- Lemke, F., Clark, M. and Hugh, W. (2011), "Customer Experience Quality: An Exploration in Business and Consumer Contexts using Repertory Grid Technique", *Journal of the Academy of Marketing Science*, Vol. 39, No. 6, pp, 846–869.
- Lemon, K.N. and Verhoef, P.C. (2016), "Understanding Customer Experience and the Customer Journey", *Journal of Marketing*, Vol. 80, No. Special-November, pp,69–96.
- Lipkin, M. (2016), "Customer experience formation in today's service landscape", *Journal of Service Management*, Vol. 27, No. 5, p, 1-25.
- Meuter, M. L., Ostrom, A. L., Roundtree, R. I., and Bitner, M. J., (2000), "Self-service technologies: Understanding customer satisfaction with technology-based service encounters", *Journal of Marketing*, Vol. 64, No. July, pp, 50–64.
- Prahalad, C. K. and Ramaswamy, V. (2004). "Co-creation experiences: The next practice in value creation." *Journal of Interactive Marketing*, Vol. 18, No. 3, pp, 5-14.
- Vargo, S.L. and Lusch, R.F. (2004), "Evolving to a New Dominant Logic for Marketing", *Journal of Marketing*, Vol. 68, No. 1, pp.1–17.
- Verhoef, P. C., Lemon, K. N., Parasuraman, A., Roggeveen, A., Tsiros, M., and Shlesinger, L. A. (2009). "Customer experience creation: determinants, dynamics and management strategies", *Journal of Retailing*, Vol. 85, No.1, pp, 31–41.
- Wang, C., Harris, J. and Patterson, P.G. (2012), "Customer choice of self-service technology: the roles of situational influences and past experience", *Journal of Service Management*, Vol. 23, No. 1, p.35-46.



## EXPLORING INTERVAL-VALUED SCALES: A COMPARISON OF SCALE ATTRIBUTES BETWEEN INTERVAL VALUED AND SEMANTIC DIFFERENTIAL SCALES

**Themistocleous, Christos<sup>1</sup>; Pagiaslis, Anastasios<sup>1</sup>; Smith, Andrew<sup>1</sup>; Cristian Wagner<sup>2</sup>**

<sup>1</sup>Nottingham University Business School, The University of Nottingham, Nottingham, UK

<sup>2</sup>Lab for Uncertainty in Data and Decision Making (LUCID), School of Computer Science, The University of Nottingham, Nottingham, U.K. and Institute for Cybersystems, Michigan Technological University, USA

### ABSTRACT

### BACKGROUND

Even though crisp single-point capturing scales such as Likert and Semantic Differential offer valuable information regarding a respondent's perceptions on a specific topic, more recently-developed scales allow respondents to record their answers by choosing an interval rather than a single point. Wagner et al., (2015) introduce interval-valued scales (IVS) allowing respondents to record their responses and capture the uncertainty contained in the response. Figure 1 provides a visual representation of an IVS. The wider the interval the more uncertain the response is. IVS survey data may for example be analysed based on summary statistics or modelled via the Interval Agreement Approach. (see Wagner et al., 2015).

**Q1. How many times do you go to a restaurant in an average week?**

*How invasive do you feel this question is?*



Figure 1. Interval valued scale (IVS)

This paper explores Interval-Valued Scales (IVS) in a marketing research context and provides comparative results of an exploratory study between IVS and Semantic Differential Scales (SDS) comparing the scales using Preston and Colman's (2000) scale attributes: i) Ease of use, ii) Speed of use, iii) Ability to precisely record desired answers, iv) Adequate expression of exact thoughts and feelings, v) Certainty/Uncertainty with personal answers and vi) Overall satisfaction with each scale.

### DATA, METHODS AND RESULTS

The study is based on a convenience sample of 122 UK adults (equally split between IVS and SDS samples). The data collection was completed through personal survey interviews using a quasi-experimental questionnaire-based approach. A questionnaire was formulated which focused on eighteen questions designed to measure the sensitivity of respondents in respect to the capture of private information by rating the questions' degree of invasiveness (see Fig. 1). Two versions of the questionnaire were constructed for this set of eighteen questions, one utilizing IVS and one SDS. The rest of the questionnaire was common and measured: familiarity with survey scales, respondent perceptions of scale attributes and demographics.

The study contrasts IVS and SDS scale attributes (N=61 per sample) utilizing a series of independent sample t-tests including effect size and power calculations. Demographic consistency and respondent survey familiarity between samples were tested and found to hold. Independent sample t-tests show that overall perceptions of satisfaction ease of use, certainty, precision and expression with IVS equals that of SDS. 'Speed of Use' results marginally in favor of IVS. This result may be explained either due to SDS respondents preferring single-point scales with fewer response categories (i.e. respondents preferring an SDS with less than 10 categories used presently) (Preston & Colman, 2000) or due to curiosity using a new scale leading to excitement and positive subjective perceptions thus overrating IVS (Kashdan et al., 2004).

## DISCUSSION

The contribution of this paper is the exploration of IVS for capturing respondent data in a marketing context. The initial results presented suggest that IVS is not considered more difficult than SDS and is actually considered quicker to complete. IVS has the advantage of explicitly modelling response uncertainty through the utilization of an interval. The consistency of respondent perceptions between IVS and SDS indicates new pathways for measuring consumer responses (IVS) which entail a wider range of analytical capabilities especially so for modeling uncertainty. Future studies should expand sample size and compare the statistical capabilities of IVS vs other traditional scales used in marketing research.

*Keywords: Interval Valued Scale, Semantic Differential Scale, Scale Attributes, Survey*

## REFERENCES

- Wagner, C., Miller, S., Garibaldi, J.M., Anderson, D.T. and Havens, T.C., (2015). "From interval-valued data to general type-2 fuzzy sets", *IEEE Transactions on Fuzzy Systems*, Vol. 23(2), pp.248-269.
- Preston, C.C., and Colman, A.M. (2000), "Optimal number of response categories in rating scales: Reliability, validity, discriminant power and respondent preferences", *Acta Psychologica*, Vol. 104, pp.1-15.

Kashdan, T. B., Rose, P., & Fincham, F. D. (2004), "Curiosity and exploration: Facilitating positive subjective experiences and personal growth opportunities", *Journal of personality assessment*, Vol. 82(3), pp.291-305.

# **MONTREAL'S MULTIMEDIA AND VIDEOGAME INDUSTRY: THE SOURCES OF ITS COMPETITIVENESS AND INNOVATION CAPACITY**

**Tremblay, Diane-Gabrielle**

Téluq, University of Québec, Montreal, Québec, Canada

## **ABSTRACT**

### **INTRODUCTION AND CONTEXT**

The video games cluster in Montreal emerged in the early 1990s, within the context of an affirmation culture of the Quebec Society in politics, the arts and economics. At the regional level, Montreal, can be seen as a cultural bridge between Europe and North America. In the context of a digital animation culture, related to the National Film Board, this has apparently been an important advantage, although other elements also contribute to explain the competitiveness of the Montreal Multimedia and Videogame Industry. Our paper will develop on these elements which appear to be the source of competitiveness and innovation, including an important subsidy program offered by the State, but also training institutions, as well as the relational proximity to the Hollywood entertainment culture. These all appear to be important characteristics which explain the emergence and the development of the Montreal Multimedia and Videogame cluster and its innovative capacity, which largely explains its development over recent years.

### **METHODOLOGY**

Our research is based on many years of research in the sector, as well as on the cluster policy of the City of Montreal in general. We have conducted over 50 open-ended interviews with various actors in the multimedia cluster and sector, including governmental organizations, intermediary organizations, as well as firms and training organizations. The research is thus based on qualitative methods, mainly documentary analysis and semi-directed qualitative interviews on issues related to the process of innovation, competitiveness, as well as collaboration between various industry actors.

### **SOME RESULTS**

The video games cluster of Montreal has considerably grown, from 400 employees in 1996<sup>1</sup>, to 1000 in 2003, 5 500 in 2009, and approximately 8000 employees today (2016). Montreal accounts for 80 percent of the industry in the province of Quebec (Canada) and has become known as an important

---

<sup>1</sup> Before Ubisoft settled in 1997, and the public policy implemented in 1998.

international hub in the videogame and multimedia industry. One can now ask: what is the source of this growth?

In our view, the explanation rests partly in the fact that Montreal is a cultural bridge between Europe and North America, and has a strong digital animation culture. Indeed, firms such as Softimage and the Multimedia City have contributed to brand the city as a “low cost high creativity” culture in film as in the multimedia sector. Also the fact that the government supported the industry with financial incentives is amongst the main explanations. Also, within an increasingly American and Hollywood-based entertainment culture Montreal was apparently at the right place, with the right talents to go forward with the video games cluster, and the Multimedia City program, which financed firms to establish themselves in Montreal (by contributing to labour costs), did the rest in terms of branding the city in the Gaming and Multimedia sectors. This led to the establishment of several foreign video games firms, from France, the UK and the U.S<sup>1</sup>, in the late 1990s, and in the growing popularity of video games based on Hollywood movies and other foreign licenses. The local firms who took this “Hollywood road”, such as Hexacto, Kutoka, A2M now Behavior Interactive, Airborne, Beenox faced the fastest and the highest growth among local firms.

Behavior Entertainment is a typical case of the positive influence of the Hollywood entertainment culture on the development of the cluster. Through global partnerships of video games based on movie licenses, Behavior has become the biggest independent developer in North America (later bought off by a US company however). Also, as the first and major anchor firm, Ubisoft has generated creative talent through successful video game titles and through the creation of the Ubisoft campus. Finally, given the quality of training, due to the concentration of universities and technical colleges (IT, Image and sound, and video-film programs, etc.), video game firms were thus able to be nourished by creative talent and to operate and innovate at very competitive costs in comparison with the US and Europe. Montreal is more and more recognized as a « low cost high creativity » culture in the gaming and film sector and this has been mentioned in many of our research interviews. Over the years, other firms have joined the first anchor firm; for example Electronic Arts (from California), Warner Bros Interactive and THQ, from LA, Eidos, from UK, and Square Enix from Japan have created many jobs over recent years.

A deeper investigation into the Montreal’s cluster seems to indicate that tolerance and the openness of society as well as the quality of urban life and the low cost of rent in have had a positive impact in attracting and retaining local and foreign creative talent. This is important for various sectors of the so-called “creative economy” and appears to partially support the thesis of Florida and

---

<sup>1</sup> Such as, Gameloft, Microïds, Bug Tracker, Electronic Arts, Eidos, DC Studios, Babel Media, Javaground, Cyanide.

*al.* (2005), who consider that tolerance and openness are important features encountered in the Quebec society and contribute to innovation and competitiveness.

Our research underlines the importance of knowledge and cooperation in the development of a creative cluster. It stresses the sources of the dynamism of the sector which rest in knowledge transfers and exchanges within the cluster. It shows that proximity of actors and the creative dynamism of the human resources have been essential factors in the development of the multimedia cluster. The value of our research is based on the identification of these factors favouring the development of clusters in general (training, proximity, local embeddedness, etc.) and their contribution to the Creative Ecosystem which the Multimedia City and Gaming industry represent in Montreal.

As concerns practical implications, the research contributes in developing more efficient policies for clusters and ecosystems in the multimedia, IT or other sectors. The research can also help creative firms understand how they can use the cluster theory and policies to support their creative activities and be more innovative. The local entrepreneurs as well as the Quebec government, with an important financial program, also are important actors, and this model of public intervention appears to have been replicated in other North-American regions as a way to attract firms and develop a competitive advantage.

*Keywords: Multimedia, Videogame, Cluster, Competitiveness, Innovation, IT, Montreal, proximity, training,*

## REFERENCES

- Pilon, S. et D.-G. Tremblay (2013) A Cultural Perspective of the Geography of Clusters: The case of the Video games Clusters in Montreal and in Los Angeles. In *Urban Studies Research*. Volume 2013 (2013), Article ID 957630, 9 pages. <http://www.hindawi.com/journals/usr/contents/>
- Tremblay, D.-G., (2012). Creative careers and territorial development: the role of networks and relational proximity in fashion design. *Urban Studies Research*. Vol.. 2012, article ID 932571. 9p. doi: 10.1155/2012/932571.
- Tremblay, Diane-Gabrielle et Thomas Pilati (2008). The Tohu and Artist-run Centers: Contributions to the Creative City? In *Canadian Journal of Regional Science*. Vol. 30, no 2. Pp. 337-356.
- Tremblay, D.G. & S. Rousseau (2005), Le secteur du multimédia à Montréal peut-il être considéré comme un milieu innovateur?, *Géographie, économie et société*, p. 37-56

## **FARM BUSINESS RESOURCES, GOALS AND STRATEGIES: IMPLICATIONS FOR ACCELERATING THE CERTIFICATION**

**Tselempis, Dimitrios; Karipidis, Philippos; Pavlouidi Alexandra**

Department of Agricultural Technology –Agricultural Economics, Alexander Technological Educational Institute of Thessaloniki, Thessaloniki, Greece.

### **ABSTRACT**

Research findings indicate that the public authorities, the marketers, and the certifiers face serious impediments in their attempts to implement the Quality Management Systems (QMS) in primary food production to be dispersed. These impediments are mainly connected with the ineffectiveness of the supply side to sufficiently respond to the demand for certified products, especially in the case of small farm businesses, and with the weaknesses of the public policy to effectively mitigate the problems leading the supply system to meet the expectations of consumers and society for higher quality products. Thus, some opportunities for the farm businesses and the food marketers can be lost due to the inefficient exploitation of the farm businesses resources and due to the low growth rate of the certified products market. As a result, some welfare and quality of life losses can arise.

Many researchers explore the implementation of QMS by farm businesses worldwide. They analyze the farmers' certification and his related decisions, and they compare certified with non-certified farm businesses, by incorporating some factors of the external and internal business environment in the exploration. As far as we are concerned, there are no studies examining the role of the resources of the farm businesses and their strategies on farmers' certification decisions. This leads to incomplete interpretations and to the loss of some information which can be useful to farmers, marketers, certifiers, and public authorities.

The present study examines how certain farm businesses resources and strategies impact on their decision to implement QMS and to become certified. Particularly, this paper focuses on two choices that affect the farmers' decision: 1) the time they decide to be certified in relation to the others farmers' decisions and 2) the type of the QMS standard (Organic, AGRO 2 -a national Greek standard- and GlobalGAP) they choose between a public and private standard.

A survey was conducted among farm businesses producing fruits and vegetables in Central Macedonia–North Greece. Based on the collected data, two discrete choice models are estimated: an ordered logit model for the time the farm businesses implement a QMS, and a binary probit model for the selection of the type of QMS standard, between public and private. The results indicate that two out of the seven factors connected with the resources accelerate the certification. Specifically, the farmers' knowledge about the institutional environment, for example the mandatory regulations,

impacts positively on the acceleration, while farmers' insufficient technical knowledge impacts negatively on it. Regarding the farm business strategies, has been found that the differentiation, imitation, selling in local markets, and buyer dependency strategies, impact positively on the acceleration of certification. It has been also found that the choice of a private standard relates to the differentiation, buyer dependence and vertical integration strategies and to the technical insufficiency of farmers, while the choice of a public standard is connected to their special education, implying a higher dependence of farmers' decisions on public policy measures.

These findings suggest for public authorities the need to take into account the level of available internal resources when they design the certification - related public policy mix, in order to avoid a divergence between the level of the existing farm business capacities and the requirements for the implementation of QMS. Also, the public policy should review its role when the farmers' decisions are not taken in alignment within the policy goals and strategies, but they are strongly pushed by the market forces in a way that do not meet the needs of the society. Furthermore, the results regarding the factors affecting the choice of QMS standard, between public and private, imply the effectiveness of the public policy in motivating farm businesses to be certified and at the same time, the arising of the private governance of food certifications.

*Keywords: farm business; certification decisions; quality systems; standards; resources; goals; strategies*

## REFERENCES

- Asfaw, S., Mithöfer, D. and Waibel, H. (2010a), "What impact are EU supermarket standards having on developing countries' export of high-value horticultural products? Evidence from Kenya", *Journal of International Food & Agribusiness Marketing*, Vol. 22, No. 3-4, pp. 252-276.
- Smith, G. (2009), "Interaction of Public and Private Standards in the Food Chain", working paper No. 15, OECD Food, Agriculture and Fisheries, Rome, 1 February.
- Tselempis, D., Karipidis, P., Pavludi, A., and Semos, A. (2015). Is quality certification in fruit and vegetable production a market-driven choice in Greece?. *Agricultural and Food Economics*, Vol. 3, No. 13, pp. 1-12.
- Veldstra, M. D., Alexander, C. E. and Marshall, M. I. (2014), "To certify or not to certify? Separating the organic production and certification decisions", *Food Policy*, Vol. 49, pp. 429-436.



## THE EFFECTS OF CEO NARCISSISM AND CORPORATE BRAND REPUTATION ON FIRM PERFORMANCE

Turner, Karynne

Department of Business and Management, LUISS Guido Carli University, Rome, Italy,

### ABSTRACT

The attributes of the Chief Executive Officer (CEO) have a significant influence on the actions of the organization and, ultimately, firm performance (Chatterjee and Hambrick, 2007). Recently, there has been growing interest in one particular CEO attribute, i.e., narcissism and how this individual characteristic affects actions taken by the firm and the outcomes achieved. Narcissistic CEOs have been described as “having an inflated self-concept that is enacted through a desire for recognition and a high degree of self-reference when interacting with others (Resick, 2009: pg. 1367).” Prior research has found that CEOs with a more narcissistic personality make riskier decisions by changing the company’s strategy more often (Chatterjee and Hambrick, 2007), making acquisitions more frequently and of larger targets (Chatterjee and Hambrick, 2007), adopting discontinuous technologies (Gerstner, et al., 2013), and expanding international business activities (Oesterle, et al., 2016). The results of previous studies show that by pursuing decisions with greater risk and involving the firm in wide-ranging efforts, the actions of narcissistic CEOs lead to fluctuating firm performance (Chatterjee and Hambrick, 2007) and diminishes the positive affect of various firm activities, e.g., Corporate Social Responsibility (CSR) (Petrenko, et al., 2016) and Entrepreneurial orientation (Engelen, et al., 2016), on performance.

While these prior studies have provided valuable insight, the strong emphasis on the organizational actions taken as a consequence of the narcissistic CEO has not added to our understanding of the relationship between CEOs who seek personal affirmation, admiration, and attention and the corporate brand reputation. Corporate brand reputation signals the status of an organization and influences the actions of capital markets, investors, consumers, and applicants in the job market (Fombrun and Shanley, 1990). Due to stakeholders’ use of corporate brand reputation as a means to compare and contrast competitors, favorable reputations have a significant effect on competitive advantage and organizational performance (Roberts and Dowling, 2002). Managers actively work to construct favorable corporate brand reputations through the actions the firm takes and the information selectively released to the media and public. Yet, the literature suggests that narcissistic CEOs spend time focusing on how to enhance their own image rather than on achieving organizational goals (Resick, 2009). In this regard, the attention-seeking CEO likely becomes a focal point for the corporate brand. However, no research to date has examined the relationship between

the narcissistic CEO's personality and corporate brand reputation. This study fills the gap in the literature by investigating how CEO narcissism influences the effectiveness of corporate brand reputation on firm performance.

We conducted our study using data from U.S. services firms. Firms in the service sector rely on relationships as a key inimitable resource and the corporate brand reputation is fundamental for distinguishing competitors. Our dependent variable was return on assets (ROA) (total assets/ total revenue) based upon data from the COMPUSTAT database. COMPUSTAT was also the source for our measure of CEO narcissism, the rank of CEO total compensation (salary + bonus)/rank of next highest executive's total compensation (Chatterjee and Hambrick, 2007). Corporate brand reputation was measured using the Harris Interactive Assessment on a scale of 1 to 100. The Harris Interactive Assessment conducts over 23,000 online interviews with adults over the age of 18 regarding their opinions of the best and worst companies along six dimensions: 1) social responsibility, 2) emotional appeal, 3) product and services, 4) vision and leadership, 5) financial performance and 6) workplace environment. Our initial findings show that in the services sector CEOs with a higher narcissistic personality trait have a more negative effect on ROA. We attribute this result to the likelihood that narcissistic CEOs do indeed spend more time and resources than less narcissistic CEOs to promote themselves and not the firm. In addition, these CEOs likely distract from the corporate reputation by diluting stakeholders' attention. However, we also found that the interaction of brand reputation and CEO narcissism has a positive effect on ROA. Thus, firms with stronger corporate brand reputations are able to compensate for the behaviors of the narcissistic CEO.

*Keywords: CEO narcissism, corporate brand value, firm performance*

## REFERENCES

- Chatterjee, A. and Hambrick, D.C. (2007), "It's all about me: Narcissistic CEOs and their effects on company strategy and performance", *Administrative Science Quarterly*, Vol. 52, pp. 351–386.
- Engelen, A., Neumann, C., and Schmidt, S. (2013), "Should entrepreneurially oriented firms have narcissistic CEOs?", *Journal of Management*, Vol. 42 No.3, pp 698-721.
- Fomburn, C. and Shanley, M. (1990), "What's in a name? Reputation building and corporate strategy", *Academy of Management Journal*, Vol. 33 No. 2, pp. 233-258.
- Gerstner, W., Konig, A., Enders, A., and Hambrick, D. C. (2013), "CEO Narcissism, Audience Engagement, and Organizational Adoption of Technological Discontinuities", *Administrative Science Quarterly*, Vol. 58 No.2, pp. 257 – 291.
- Oesterle, M., Elosge, C. and Elosge, E. (2016), "Me, myself and I: The role of CEO narcissism in internationalization decisions", *International Business Review*, Vol. 25 No. 5, pp. 997-1184.
- Petrenko, O. V., Aime, F., Ridge, J., and Hill, A. (2015), "Corporate social responsibility or CEO narcissism? CSR motivations and organizational performance", *Strategic Management Journal*, Vol. 37, pp. 262–279
- Resick, C. J., Whitman, D. D., Weingarden, S. M., and Hiller, N. J. (2009), "The bright-side and the dark-side of CEO personality: Examining core evaluations, narcissism, transformational leadership, and strategic influence", *Journal of Applied Psychology*, Vol. 94, pp. 1365–1381.

Roberts, P.W. and Dowling, G.R. (2002), "Corporate reputation and sustained superior financial performance", *Strategic Management Journal*, Vol.23 No. 12, pp. 1077-1093.

## CONSUMER MOTIVES IN TIMES OF ECONOMIC RECESSION: ADOPTION OF THE MEANS END THEORY

Tzimas Dionysios<sup>1</sup>, Karipidis Philippos<sup>2</sup>, Kontogeorgos Achilles<sup>3</sup>

<sup>1</sup>University of Nicosia, Nicosia, Cyprus

<sup>2</sup>Alexander Technological Educational Institute of Thessaloniki, School of Agricultural  
Technology and Dept. of Agricultural Economics, Thessaloniki, Greece

<sup>3</sup>Dept. of Business Administration of Food and Agricultural Enterprises

### ABSTRACT

The crisis is not an uncommon phenomenon in world economies last decades. Thus, some researchers examine its impact on certain issues of consumer behaviour. For example, research findings indicate that consumer behaviour during the economic crisis differs than that in good times (Griffith *et al.*, 2015; Hampson & McGoldrick, 2013; Kaswengi and Diallo, 2015; Kaytaz and Gul, 2014). Engel *et al.*, (1995) report that consumers adjust their lifestyle to new economic situation, while Schiffman and Kanuk (1994) conclude that the consumption decisions are influenced by perceived risk, consumers become more careful in their choices, devote more time to search products and look forward to the greatest benefits for their limited available income.

It is apparent that the impact of economic crisis is not sufficiently understood if the investigation is limited to consumer behaviour issues without a deeper understanding of consumer motivations. The marketing choice models adopted in a lot of consumer behaviour studies tend to overstate the importance of product attributes and ignore the personal connections consumers make with products at higher levels of abstraction (Phillips and Reynolds, 2009; Walker and Olson, 1991). The Means-End Chain (MEC) approach is adopted in the analysis of consumer behaviour at different levels when evaluating their purchase options choosing actions that produce desired consequences and minimize undesired consequences (Pieters *et al.*, 1995; Khalifa, 2004). It posits that attributes derive their relative importance from satisfying (functional) consequences, which in turn, derive their importance from satisfying higher-order personal values. This theory compared to other consumer behaviour analysis methods, provides a better understanding of consumer incentives, performing a hierarchical model of cognitive consumer structure (Gutman, 1982; Xiao *et al.*, 2014).

This work is the outcome of a preliminary study focusing on food consumer behaviour during the economic crisis in Greece, which explores the consumers' preferences related to food and retailing service attributes, the consequences and personal consumer values by adopting the Means-End Chain theory. The laddering technique is used as a means of understanding consumers' motivations for food product and retailer choice. In a first step a literature review is conducted to identify food product and retailer characteristics, connected with the consequences and the consumer personal values. In a

second step, the laddering procedure is developed into three steps. 1) Elicitation of differences among products/brands: four respondents are asked to make comparisons between selected basic food items and retailers, 2) in-depth interviewing with the same persons are conducted and 3) analysis of the data and construction of a Hierarchical Value Map is conducted which can help to segment food consumers in groups having similar personal values.

*Keywords: consumer behaviour; personal values; economic crisis; retailing; means- end chain; laddering*

## REFERENCES

- Ang S. H., (2001), "Crisis marketing: a comparison across economic Scenarios", *International Business Review*, Vol. 10, pp 263–284.
- Engel, J., Blackwell, R. and Miniard, P. (1995), *Consumer Behaviour*, Dryden Press Fort Worth, TX.
- Griffith, R., O'Connell, M., and Smith, K. (2015), "Shopping around: how households adjusted food spending over the Great Recession", *Economica*, Vol. 83 No.330, pp. 247-280.
- Gutman, J., (1982), "A means-end chain model based on consumer categorization processes", *The Journal of Marketing*, Vol. 46 No. 2, pp. 60-72.
- Hampson, D. P., and McGoldrick, P. J. (2013), "A typology of adaptive shopping patterns in recession", *Journal of Business Research*, Vol.66 No.7, pp. 831-838.
- Harrison, P. (2009), "The recession and consumer behaviour", available at : <http://www.deakin.edu.au/deakin-speaking/node/11> (accessed 12 February 2014)
- Khalifa, A.S. (2004), "Customer value: a review of recent literature and an integrative configuration", *Management Decision*, Vol. 42 No. 5, pp. 645-666.
- Kaswengi, J., and Diallo, M. F. (2015), "Consumer choice of store brands across store formats: A panel data analysis under crisis periods", *Journal of Retailing and Consumer Services*, Vol. 23, pp. 70-76.
- Phillips, J. M., and Reynolds, T. J. (2009), "A hard look at hard laddering: A comparison of studies examining the hierarchical structure of means-end theory", *Qualitative Market Research: An International Journal*, Vol. 12 No. 1, pp.83-99.
- Piercy, N. (1983), "What marketing lessons can retailers learn from the recession?", *International Journal of Retail & Distribution Management*, Vol. 11 No. 3, pp.15-20.
- Pieters, R., Baumgartner, H., and Allen, D. (1995), "A means-end chain approach to consumer goal structures", *International Journal of Research in Marketing*, Vol. 12 No. 3, pp. 227-244.
- Schiffman, L. and Kanuk, L. (1994), *Consumer Behaviour*, Prentice Hall, Englewood Cliffs, NJ.
- Walker, B. A., and Olson, J. C. (1991). "Means-end chains: Connecting products with self", *Journal of business research*, Vol. 22 No.2, pp.111-118.
- Xiao, L., Guo, Z., D'Ambra, J., and Fu, B. (2014), "Understanding online group purchase decision making: A means–end chain approach", *PACIS 2014*, Vol. 10 No. 4, pp.587-615.

## RECENT DEVELOPMENTS IN THE HYDROCARBON ENERGY MARKETS IN THE EASTERN MEDITERRANEAN

Vasilopoulou, Panagiota

Department of Political Science and International Relations, University of Peloponnese, Corinth, Greece

### ABSTRACT

The political-economic situation in the Eastern Mediterranean in the energy sector is changing rapidly. The political change in Egypt after the Arab Spring, the war in Syria, the emergence of Turkey as a new force in the region, the ever-existing tensions between Israel and Palestine, the turbulent relations between Turkey and Israel, the Cyprus issue, which remains unresolved between Cyprus and Turkey, are factors that lead to the redistribution of forces and the disturbance of the balance in the region. The purpose of this article is to record the current situation, to explore new balances between states and to highlight potential bracings and new opportunities through reviewing the literature of recent years.

The region's energy map is possibly going to be re-adjusted in the prism of the possibility of the presence of natural gas in the Eastern Mediterranean region (the area close to Egypt, Israel and Cyprus). As a consequence, a change in the position of these countries in the global energy community, from peripheral to prominent stakeholders is eminent. Consequently, geopolitical and energy pressures create new opportunities and challenges for all those involved in the region. The energy sector is directly linked to the social, economic and political situation of the states concerned (Tagliapietra, 2013: 4)

The discovery of new oil and gas reserves, in effect, forces all parties involved to consider both the relationship between them and the new balances they are developing.

- Recent developments in the Mediterranean: Cyprus, Israel and, to a lesser extent, Greece, are (or can be) the new protagonists in the field of energy. The relatively recent discoveries of two new gas fields (Leviathan and Tamar) off the coast of Israel in 2009 and the possible existence of oil, create a new dynamic for the region's energy security.

The republic of Cyprus, with the discovery of the Aphrodite plot in the EEZ in December 2011, some 34 kilometers west of the Israeli field, provides a new perspective in its growth prospects. This discovery came at a difficult time for the Cypriot economy, while its membership as an EU member provides the necessary support for the exploration of the field.

Greece started extracting oil in 1981, in small amounts, from the Thassos deposits in the northern Aegean sea. New research, shows what there might be significant reserves in the Ionian sea, South Crete and Kastelorizo. The latter area, may be problematic as it is very close to the Turkish coast. (Source: Natali, 2012). In addition, Greece could act as a transit hub for gas to Europe (Tagliapietra,

2013:19-20). In November 2012, Israel, Cyprus and Greece signed an agreement to set up working groups to discuss the development of an Energy Corridor in the Eastern Mediterranean with a view to allowing exports of gas from Israel and Cyprus to Greece and from there To Europe.(Stavris, 2012).

- Energy concerns in the EU- Europe "sees" a possible way out of its energy dependence on Russia. With the ever-increasing economic growth and declining energy production, the energy needs of the EU Member States are expected to increase significantly over the coming years. According to the European Commission, 57% of gas and 82% of oil were imported for 2008, and these needs are expected to increase significantly by 2030. Demand for gas has been increasing as opposed to oil. Algeria and Egypt are the most likely to export Liquefied Natural Gas (LNG) in the EU. Italy possesses small deposits, it only 80% of its energy needs is covered. Spain and Portugal show increased demand for gas and, due to their geographical location, countries such as Greece, Slovenia and Turkey are more dependent on Russia for gas. Greece's natural gas needs were covered by Russia in a rate touching 80% of its gas energy needs and the agreement with Gazprom was extended until 2040. (Winrow, 2009).

- The United States, albeit geographically remote, is seeing such a positive development as its strategic allies gain a more prominent position in the field of global energy.

- The suspension of Ukraine's gas supply in January 2006 over a price dispute, combined with new long-term agreements for gas supply to European countries such as France and Italy were consider by some as evidence that Russia was going to use gas and oil production but also its pipeline accessibility to gain more political influence. Others, mainly in Western Europe, argue that the fact that Europe remains Russia's largest energy market, and hence the largest source of foreign revenue, has led Russia to pay more attention to dealing with EU countries.

Russia-Turkey relations are at a marginal point and at the moment there are insufficient data on the outcome of the case. (Ratner et al 2013: 15)

## CHALLENGES

Access to resources: High costs and advanced technology are needed to make them accessible. Gas extraction: It is necessary to build pipelines, liquefaction facilities, facilities and hinterland that are exposed to terrorist activities, the definition of territorial waters, the attraction of technologically advanced mining companies, the provision of political support within each Member State. Terrorist and civil or non-conflicting actions, ISIS and turmoil caused by the Arab Spring are important factors for exploiting or not (if applicable) the available oil or gas reserves. (Stavris, 2012)

## TYPES OF ENERGY

The term “energy resource” refers to any natural resource that provides energy. Energy resources are distinguished into: **Renewable Energy Sources** (RES) that include solar, wind, geothermal, hydropower and biomass energy. Renewable energy sources are non exhaustible and there are unlimited in the environment, and their production does not burden the environment. **Non-renewable or Conventional forms of energy** that mainly include oil, natural gas and coal. Practically, Non-renewable or Conventional forms of energy refer to the planet’s mineral wealth, which is currently used to produce energy and results in quite damaging consequences for the environment and the climate of the planet. The energy which is produced by **nuclear fission (nuclear energy)** is otherwise referred to as an alternative form of energy, and is, in reality, the energy, which is released when the atomic nuclei are transformed. (Source: Koroneos Ch., 2012: 11-46)

*Keywords: Hydrocarbon, energy, market, Eastern Mediterranean, Cyprus, Egypt, Israel, oil, gas, LNG*

## REFERENCES

- Koronaos Ch. (2012) Renewable Energy Sources, National Technical University of Athens, <http://environ.survey.ntua.gr/files/mathimata/6420/APE-kef1-6.pdf>, accessed on 14/12/15
- Natali D. (2012), “The East Mediterranean Basin: A New Energy Corridor?”, Event Report, Institute for National Strategic Studies, National Defense University, Washington D.C.
- Ratner M. et al. (2013), Europe’s energy Security: Options and challenges to natural gas Supply diversification, Congressional research service
- Stavris George,(2013), “Gas games in the eastern Mediterranean”, Turkish policy quarterly, vol 11 , nO2, 88-102
- Tagliapietra Simone (2013), “Towards a new Eastern Mediterranean corridor? Natural gas development between market opportunities and geopolitical risks”, Note di lavoro, Fonazione Enrico Mattei.
- Winrow M. G. (2009), Energy Security in the boarder Mediterranean, European security, Vol 17, no 1, 161-163, Routledge, Taylor and Francis group.



## **JOB SATISFACTION IN THE HOSPITALITY INDUSTRY. A CASE STUDY FROM GREECE**

**Vasilopoulou, Panagiota**

Department of Political Science and International Relations, University of Peloponnese

### **ABSTRACT**

In a globalized, highly competitive environment, service-providing enterprises such as the ones within the hospitality industry, have come to realize that enhancing service quality and increasing customer satisfaction are crucial to their survival. Given the fact that service quality depends on employee performance, they are compelled to create customer-centric strategies. Concepts such as job performance, job satisfaction and job burnout, are directly linked to the degree of commitment to work and the quality of work. Given that the quality of services depends on the performance of first-line employees (Zeithaml, Berry and Parasuraman, 1988; Schneider, 1980 in Karatepe et al.) and that they handle approximately sixty five percent of customer complaints, the industry should focus on the critical role of front-line workers and the creation of customer-centered strategies. Factors that affect job performance are apart from the wages, (long) hours of work, the working environment, the sense of security, employees' involvement, the sense of purpose of the work, any benefits included in the pay system, the culture of the enterprise. (Boshoff and Allen, 2000; Kotler, Bowen and Makens, 1999; Rust et al., 1996 in Karatepe, O., et al.).

### **JOB SATISFACTION**

"The pleasant emotional state that results from the evaluation of the work of the individual, as well as the attainment or the facilitation of achievement of the individual's work goals" is described to be job satisfaction (Locke 1969, p. 316 in Karatepe et Al). The subject has been extensively studied in connection with other issues such as empowerment, role conflict, role ambiguity, rewards, organizational commitment, and the rate of staff renewal (Brown and Peterson, 1993 : Liden, Wayne and Sparrow, 2000: Hartline and Ferrell, 1996 in Karatepe et al). A limited number of studies show a correlation between job satisfaction and service quality. For example, Hartline and Ferrell (1996 in Karatepe et al) found a significant positive correlation between job satisfaction of frontline workers and customer perceptions of hotel quality.

### **ESTIMATION (OR SELF-ESTEEM) FROM WORK**

Work self-esteem has been described as the process of judging the work of an individual as it results from a self- assessment and feelings about work by the employ (Washington, Feinstein, & Busser, 2003 in Byung- Gook Kim (2014). There are strong indications that employment is the key determinant of job satisfaction (Jung & Lee, 2010; Byung-Gook Kim (2014)).

## **WORK/ JOB BURNOUT**

The concept of burnout has been growing more and more so in recent years, and has been extensively studied by psychologists, sociologists and management specialists as they have recognized its significant impact on the individual, the organization and more generally in the economy and production. "Burn out" means "progressively extending from the interior to the point of charring" (Maslach & Jackson, 1984 in Theophilus, 2009).

## **EFFECTS OF THE HOTEL ENVIRONMENT ON EMPLOYEES**

A key element of the hotel work environment for the continuous and unhindered employee job performance is the fact that certain conditions should be met that could be summarized as follows:

- Work environment that provides a sense of security for both the physical integrity of the employees and for safeguarding and maintaining their job.
- Existence of premises in order for the employees to meet basic individual needs
- Technical specifications and the provision of equipment and materials designed to facilitate work and increase employees' efficiency
- Provision for the correct and employee-friendly appearance of employees

The employees' dissatisfaction with their work environment may lead to behaviors that are either detrimental to the person himself or, more often than not, damaging to the business. (Lytras, 2004: 140)According to Laloumis (2002:168) the working climate or atmosphere is a significant job satisfaction factor. This refers to a certain space or area but it includes the aesthetic and emotional environment as well. The emotional environment is mainly about the emotional disposition of the people in the area.

## **CASE STUDY**

The seaside, 4 \* resort hotel complex, holds a capacity of 225 rooms, operates 12 months of the year and employs 50 employees on a year round basis in all departments. During high season, there are approximately another 50 employees, occupied on a temporary or extra basis.

The purpose of the survey is to investigate the levels of job satisfaction that the employees derive from their occupation. In order to achieve the above, a primary quantitative survey was designed using a questionnaire consisting mainly of closed questions (a total of 25 questions, 4 open and 21 closed questions).

The survey involved a total of 25 employees, accounting for 50% of all year-round employees. The results were processed with KNIME software.

An overall assessment of the responses shows that although the firm is in a decline phase, staff shows high rates of job satisfaction, a high degree of loyalty to the firm, and no interest in seeking employment with another employer. There is strong correlation between the years of employment and the satisfaction rate, the level of education and the years of employment, a ratio of 52% female and 48% male employees, 75% of the personnel is 35 years old or older, 40% hold a University or Technological Educational Institute degree, 72% have been employed by the firm for more than 10 years, 70% find their job quite meaningful/fulfilling, and 50% feel that they are being moderately paid whereas 12,5% feel that they are being underpaid.

*Keywords: Hospitality industry, front line employees, quality, services, Job performance, job burnout, job satisfaction*

## REFERENCES

- Byung-Gook Kim (2014) The Effectiveness of a Training Program for the Self-Evaluated Job Performance of Cultural Tourism Interpreters, *Journal of Quality Assurance in Hospitality & Tourism*, 15:4, 382-398, DOI: 10.1080/1528008X.2014.921780
- Karatepe M. Osman, Turgay Avci & Huseyin Arasli (2004) Effects of Job Standardization and Job Satisfaction on Service Quality, *Services Marketing Quarterly*, 25:3, 1-17, DOI: 10.1300/J396v25n03\_01
- Laloumis D.. (2002), *Hotel Management*, Stamoulis publications, Athens
- Lytras P. (2004), *Sociology and psychology of tourism*, Interbooks, Athens
- Theophilou P., (2009), *The job burn out syndrome on the health sector*, [http://e-jst.teiath.gr/issue\\_13\\_2009/Theofilou\\_13.pdf](http://e-jst.teiath.gr/issue_13_2009/Theofilou_13.pdf), accessed 10/01/16
- Young Sarah, Sturts R. Jill, Ross M. Craig & Kyoung T. Kim (2013) Generational differences and job satisfaction in leisure services, *Managing Leisure*, 18:2, 152-170, DOI: 10.1080/13606719.2013.752213

# FEAR OF TERRORISM AND THE COSMOPOLITAN VALUE SYSTEM REFLECTED IN THE TOURISTS' PERCEPTION OF COUNTRY IMAGE AND TRAVEL DECISION

Vereb, Vanda<sup>1</sup>; Nobre, Helena<sup>2</sup>; Farhangmehr, Minoo<sup>1</sup>

<sup>1</sup>School of Economics and Management (EEG), University of Minho, Braga, Portugal, and GOVCOPP, University of Aveiro, Aveiro, Portugal

<sup>2</sup>DEGEIT, GOVCOPP, University of Aveiro, Aveiro, Portugal

<sup>3</sup> School of Economics and Management (EEG), University of Minho, Braga, Portugal

## ABSTRACT

While tourism is one of the most effective ways to build up (Thompson and Tambyah, 1999) and express on one's cosmopolitan orientation (Alden et al., 2006), it is also a prime target for terrorism (Butler, 2014; Goldma and Neubauer-Shani, 2016). This makes tourism a perfect test field to investigate how the cosmopolitans' desire for openness and freedom (Cannon and Yaprak, 2002) clashes with the recent restraining fear of terrorism (Araña and León, 2008), and understand how these competing drives impact the worldview, destination perception, consumption preferences, and final consumer choices of the global travellers.

Most previous studies conceptualized and studied cosmopolitanism as a stable orientation rather than a context specific state (e.g., Riefler et al., 2012), while others argue for a gradual transition in cosmopolitan orientation (e.g., Thompson and Tambyah, 1999) but without solid empirical validation. This study is an attempt to address the research gap, suggested by Riefler et al. (2012, p. 300), to test empirically if "major shock" (like a terrorist attack or the fear of it) "can dampen a cosmopolitan orientation, while fuelling ethnocentric tendencies". Contemporary societies are moving in the direction of so-called new racism, associating the fear of terrorism to race (Koskela, 2010) and living in constant panic (Europol, 2016). As a direct result of the fear of terrorism travellers are drastically changing their travel preferences by avoiding destinations that are culturally too different (Araña and León, 2008), or traveling in total isolation (Clancy, 2012; Yoon & Shafer, 1997). Will this tendency, make also cosmopolitans rethink their value of cultural tolerance, change their perception of a destination, and amend their travel habits?

Cosmopolitan values, like risk taking, do affect tourism behaviour (Lepp and Gibson, 2008). Some studies argue that risk aversion (fear, in this case) directly affect personal values that influence destination perception and final travel decision (Alvarez and Campo, 2014; Sarman et al., 2015). While others place fear as a moderator between perception and final decision (Woodside and Lysonski, 1989). The aim of this study is first to explore how fear exactly changes individual values, perception and final

decision in the case of global travellers; and then validate the findings through national tourism and global terrorism statistics.

The findings will contribute by not only mapping a more informed profile of cosmopolitan consumers, but also providing a valuable insight for tourism professionals on just how diverse the expectations of their cosmopolitan clients are. Furthermore this research sets to develop strategies on how marketers and policy makers can build a destination/country image that keeps up with the current realities of global tourism.

## ACKNOWLEDGEMENTS

This research is supported by the FEDER funds through COMPETE 2020, from the Operational Program for Competitiveness and Internationalization (POCI), and by National Funds through FCT – Foundation for Science and Technology, within the financial support assigned to the research unity GOVCOPP (POCI-01-0145-FEDER-0085).

*Keywords: Cosmopolitanism; Terrorism; Tourism; Cultural Clash; New Racism; Destination image; Country image;*

## REFERENCES

- Alden, D. L., Steenkamp, J.-B. E. and Batra, R. (2006), "Consumer attitudes toward marketplace globalization: Structure, antecedents and consequences", *International Journal of Research in Marketing*, Vol. 23 No. 3, pp. 227–239.
- Alvarez, M. D. and Campo, S. (2014), "The influence of political conflicts on country image and intention to visit: A study of Israel's image", *Tourism Management*, Vol. 40, pp. 70-78.
- Araña, J. E. and León, C. J. (2008), "The impact of terrorism on tourism demand", *Annals of Tourism Research*, Vol. 35 No. 2, pp. 299–315.
- Butler, R. (2014), "Book Review of "Future tourism: political, social and economic challenges"", *Annals of Leisure Research*, Vol. 17 No. 3, pp. 345-346.
- Cannon, H. M. and Yaprak, A. (2002), "Will the Real-World Citizen Please Stand Up! The Many Faces of Cosmopolitan Consumer Behavior", *Journal of International Marketing*, Vol. 10 No. 4, pp. 30-52.
- Clancy, M. (2012), "Security and the Future of Tourism", in J. Leigh, C. Webster and S. Ivanov (Eds.), *Future Tourism: Political, Social and Economic Challenges*, Routledge, Abingdon, Oxon, pp. 37-52.
- Europol (2016), "European Union Terrorism Situation and Trend Report (TE-SAT) 2016", available at: <https://www.europol.europa.eu/activities-services/main-reports/european-union-terrorism-situation-and-trend-report-te-sat-2016> (accessed 27 April 2017)
- Goldma, O. S. and Neubauer-Shani, M. (2016), "Does International Tourism Affect Transnational Terrorism?", *Journal of Travel Research*, Vol. 56 No. 4, pp. 451–467.
- Koskela, H. (2010), "Fear and its Others", in S. J. Smith, R. Pain, S. A. Marston and J. P. Jones (Eds.), *The SAGE Handbook of Social Geographies*, SAGE, London, UK, pp. 389-409.
- Lepp, A. and Gibson, H. (2008), "Sensation seeking and tourism: Tourist role, perception of risk and destination choice", *Tourism Management*, Vol. 29 No. 4, pp. 740-750.
- Riefler, P., Diamantopoulos, A. and Siguaw, J. A. (2012), "Cosmopolitan consumers as a target group for segmentation", *Journal of International Business Studies*, Vol. 43 No. 3, pp. 285-305.
- Sarman, I., Scagnolari, S. and Maggi, R. (2015), "Acceptance of Life-Threatening Hazards among Young Tourists: A Stated Choice Experiment", *Journal of Travel Research*, Vol. 55 No. 8, pp. 979-992.

- Thompson, C. J. and Tambyah, S. K. (1999), "Trying to Be Cosmopolitan", *Journal of Consumer Research*, Vol. 26 No. 3, pp. 214-241.
- Woodside, A. G. and Lysonski, S. (1989), "A General Model Of Traveler Destination Choice", *Journal of Travel Research*, Vol. 27 No. 4, pp. 8-14.
- Yoon, J. and Shafer, E. L. (1997), "Research: An Analysis of Sun-Spot Destination Resort Market Segments: All-Inclusive Package Versus Independent Travel Arrangements", *Journal of Hospitality & Tourism Research*, Vol. 21 No. 1, pp. 141-159.

## CORPORATE GOVERNANCE, CORPORATE SOCIAL RESPONSIBILITY AND CORPORATE SOCIAL PERFORMANCE

Vinarski -Peretz Hedva

Department of Political Science and Department of Health System Management, The Max Stern Yezreel Valley College, Israel

### ABSTRACT

This paper is aimed to add a glance at the development of corporate governance in Israel and the legal amendment acted to facilitate the adoption of corporate social performance (CSP) among firms and corporation. Scholars have challenged to understand what constitutes corporate social performance (CSP) and establishing the numerous internal and external factors affecting firm behavior (Karassin and Bar-Haim, 2016). In this regard, the link between corporate governance and corporate social performance is well known in the literature. However, a fundamental gap exists in our knowledge of what specifically drives CSP and the role of institutional structures in influencing CSP at the level of the firm. The interrelationship between corporate governance and social corporate performance in Israel discussed with regard to the legislative amendments.

### INTRODUCTION

Recently, as the interest in corporate social responsibility (CSR) adopted by various institutional actors and firms, its shift 'the way we think about and understand the relationship between firms, their institutional environment, and important stakeholders, such as communities, employees, suppliers, national governments and global society' (Ioannou and Serafeim, 2010). As the social awareness increased, CSR become more and more vital and stakeholders have recognized that firms expected to benefit rather than strengthen their financial assets and obey the law. Clapp and Rowlands, (2014, 42) have noted that the idea of CSR is to "promote social and environmental goals and to minimize any potential social and environmental costs associated with their business activities. The rationale behind CSR is that firms themselves are best placed to ensure compliance and implementation and to monitor progress toward their own environmental and social performance targets and will do so because it makes good business sense" (2014, 42).

As part of CSR, the corporate social performance (CSP) is away to making CSR applicable and putting it into practice (Maron, 2006; Huang, 2010). CSP explained as the operationalization of socially responsible activities (Blanco, *et al.*, 2013). Researchers have studied corporate social performance in CSR as parameter to measurable organizational achievement (Hafsi and Turgut, 2013). A successful CSP create a condition or circumstance that puts the firm in a favorable or superior position and is

argued to be an effective means enhancing overall reputation, and, that may add advantage and benefit the financial performance of a firm in the long run (Orlitzky, *et al.*, 2003). Regard to the management responsibility in the firms, Lin-Hi and Muller, (2013) have noted that the accountability of corporate managers to multiple stakeholders harmonizes with ongoing analysis of the impact of CSR strategies on economic, social, and environmental concerns and strategies aimed at doing better. In order to understand what drives CSP among firms, studies focus on what motivate or impede economically, socially, and environmentally responsible behavior in firms (Matten and Moon 2008; Aguinis and Glavas 2012). Ioannou and Serafeim, (2010) have classified four distinct segment of institutional structure in a country that foster firms to engage in socially responsible behaviors: 1) legal institutions, 2) political institutions, 3) labor market institutions and 4) capital market institutions and discuss the mechanism through which the specific institutions may influence CSP among other drivers. They have suggested that 'legal institutions play an important role in facilitating the corporation's engagement with its key stakeholders as well as regulating to an extent the relationships among corporate actors within the same industry' (p. 11). Based on their work, this paper is aimed to add a glance at the development of corporate governance in Israel and the legal amendment acted to facilitate the adoption of corporate social performance (CSP) among firms and corporation. The link between corporate governance and corporate social performance is well known in the literature (Huang, 2010). However, a fundamental gap exists in our knowledge of what specifically drives CSP and the role of institutional structures in influencing CSP at the level of the firm (Ioannou and Serafeim, 2010).

The findings indicate that, in the Israeli case the current policy does not have binding legislation or systematic doctrine on the subject of mandatory reporting regarding CSR activities, duties and principals. The corporate governance in Israel is currently experiencing significant and rapid change in respect to corporate governance regulation and practice (Shaham and Schapiro, 2011), however, "...the ambiguity of the concept of CSR combined with public ignorance about the effects of processes, products and services for society and the environment have left each corporation the freedom to choose the proper amount of transparency and action needed" (Nathanson and Gazala 2014; 4) Practically speaking, for successful implementation of CSR and CSP, more policies and regulation, is inevitable.

**Keywords:** *corporate social responsibility, Corporate Social Performance, Corporate Governance, Public Policy*



## REFERENCES

- Aguinis, H. and Glavas, A., 2012. What we know and don't know about corporate social responsibility a review and research agenda. *Journal of management*, 38(4), pp.932.
- Blanco, B., Guillamón-Saorín, E. and Guiral, A., 2013. Do non-socially responsible companies achieve legitimacy through socially responsible actions? The mediating effect of innovation. *Journal of business ethics*, 117(1), pp.67-83.
- Clapp, J. and Rowlands, I.H., 2014. *Corporate social responsibility. The Essential Guide to Global Environmental Governance*. Routledge: London, pp.42-44.
- Hafsi, T., & Turgut, G. (2013). Boardroom diversity and its effect on social performance: Conceptualization and empirical evidence. *Journal of Business Ethics*, 112(3), 463-479.
- Huang, C.J., 2010. Corporate governance, corporate social responsibility and corporate performance. *Journal of Management & Organization*, 16(05), pp.641-655.
- Ioannou, I. and Serafeim, G., 2010, August. The Impact of Corporate social responsibility on investment recommendation. In *Academy of Management Proceedings* (Vol. 2010, No. 1, pp. 1-6). Academy of Management.
- Karassin, O. and Bar-Haim, A., 2016. Multilevel corporate environmental responsibility. *Journal of Environmental Management*, 183, pp.110-120.
- Lin-Hi, N. and Müller, K., 2013. The CSR bottom line: Preventing corporate social irresponsibility. *Journal of Business Research*, 66(10), pp.1928-1936.
- Marom, I.Y., 2006. Toward a unified theory of the CSP–CFP link. *Journal of business ethics*, 67(2), pp.191-200.
- Matten, D. and Moon, J., 2008. "Implicit" and "explicit" CSR: A conceptual framework for a comparative understanding of corporate social responsibility. *Academy of management Review*, 33(2), pp.404-424.
- Nathanson, R. and Gazala, I. 2014. Corporate Social Responsibility in the EU and in Israel: Corporate Cultures regarding Humanitarian Law and Human Rights and their Impact on Conflict Solutions. The Macro Center for Political Economics- Israeli European Policy Network working paper, 1-12. <http://www.iepn.org/>
- Orlitzky, M., Schmidt, F.L. and Rynes, S.L., 2003. Corporate social and financial performance: A meta-analysis. *Organization studies*, 24(3), pp.403-441.
- Shaham, S. and Schapiro, D. (2011). *The International Comparative Legal Guide to: Corporate Governance 2011*. Global Legal Group Ltd: Ashford Colour Press Ltd. <http://www.iclg.co.uk/>

## DETERMINANTS OF YOUTH'S TRUST IN THE RETAIL BANKING SECTOR IN TURBULENT TIMES

Viterbo, Marília Ribeiro; Azevedo, António J. A.

School of Economics and Management, University of Minho, Braga, Portugal

### ABSTRACT

Trust is a determinant for the success of relationships building particularly among young adult customers in a period of financial crisis. The proposed model is a simplified version of the European Customer Satisfaction Index (ECSI) applied to the banking sector, since it includes as predictors of satisfaction (image, perceived quality, expectations and perceived value (price), trust (satisfaction as predictor), loyalty (trust as predictor) and word-of mouth. The data was collected by a questionnaire realized to 491 individuals. The results suggest that only price is not a predictor of satisfaction. This study also concluded that to build trust among young people, is crucial that bank meet their expectations. The bank must be transparent and their products and services must be reliable. The determinants of loyalty are trust, satisfaction, easiness of access (convenient location), stability in the market and good agencies facilities (tangibility).

Keywords: Banking sector; crisis; trust; youth; European Customer Satisfaction Index (ECSI)

### INTRODUCTION

Nowadays the economic realities are increasingly uncertain due to multiple financial collapses, thus producing a feeling of mistrust regarding the banking institutions especially after the period of 2008-2009 (Shim, Serido and Tang, 2013; Chaudhry and Jayasekera, 2014).

This paper aims to study the antecedents and consequences of trust and loyalty in retail banking sector among the youth target segment.

The retail banking is traditionally characterized by long-term relationships which increase the propensity for loyalty (Beerli, Martin and Quintana, 2004; Yognathan, Jebarajakirthy and Thaichon, 2015). Berry (1995) stressed that the idea of making gains through the loyalty and satisfaction of customer needs was common by the early traders, being this as old phenomenon as the history of trade (Grönroos, 2006). Although Relationship Marketing is a truly studied theme, there is no consensus regarding their concept definition: "It's all about to attract, maintain and improve the relationship with customers in multi-service organizations" (Berry, 1983, p.25).

The proposed model is a simplified version of the European Customer Satisfaction Index (ECSI) comprising the predictors of satisfaction (perceived quality, expectations, image and the perceived

value) and its consequences (trust, loyalty and WOM-word-of-mouth). The ECSI model was developed and applied to the bank sector (Ball, Coelho and Machás, 2004). This paper explores a gap in literature regarding the decision-making behavior of the youth target segment in retail banking after the financial crisis period. The decision of opening a bank account occurs at 16-18 years old and it is fostered by the emergence of new needs such as pocket-money, the purchase of the first car, or the use of credits to studies. Therefore customer's *satisfaction* and *trust* emerge as key concepts in building long-term relationships.

## METHODOLOGY

**An online survey was answered by 491 respondents (average age= 23.93; SD=4,25). 65% of the respondents were women. 48.5% of sample stated to have a monthly income lower than 300€, while only 39.5% earn more than 500€/month, probably because 60.3% unemployed or students.**

## DISCUSSION OF RESULTS

The majority of the respondents (55.4%, N=272) stated that the preferred bank is Caixa Geral de Depósitos (CGD), followed by Santander Totta or Millennium BCP (9.4%). The average time of the customer-bank relationship was 7.78 years (SD=6,00). 86% have a debit card, use the internet banking channel (38%) or mobile apps (18%).

The majority of banks have a negative image score (below 5 points). The CGD has the best image score (M=7,34; SD=2,08). As a possible explanation for the negative image 54% respondents answered "I do not trust in this bank" and 40% said "this bank is not stable and solid in the market".

A multiple linear regression ( $F < 0,001$ ) (stepwise method) was performed in order to assess the following significant predictors which explain 76% of the trust variance amongst the respondents who mentioned that CGD is their bank: product and services reliability ( $\beta = 0,474$ ); efficient and high quality services ( $\beta = 0,173$ ); solid/well established in market ( $\beta = 0,141$ ); transparency ( $\beta = 0,125$ ).

On other hand, satisfaction is a predictor of trust ( $R^2 = 0,601$ ). The average total score of trust (M=4,79; SD=0,872; in 1 to 6 Likert scale) is very low. Authors also verified that trust is positively correlated with loyalty ( $R^2 = 0,554$ ) and WOM ( $R^2 = 0,764$ ). These findings confirm the conclusions of and Ball, Coelho and Machás (2006).

## CONCLUSIONS AND PRACTICAL IMPLICATIONS

By analyzing the ECSI applied to the banking sector (ECSI Portugal, 2016) the objectives of this study were accomplished through the assessment of the determinants of satisfaction, trust and loyalty. The

results only rejected the hypothesis that perceived value would be one of the predictors of satisfaction which the not consistent with contributions from Fornell, et al. (1996) and the ECSI Portugal (2016).

This paper provides some recommendations to bank managers. It is crucial for young people that the bank will meet their expectations; the quality and the convenience of agencies' location are also key success factors. Young customers value innovative strategies and customized communication channels for building trust and still showing a preference for reliability, transparency and clarity of information.

Recent studies also confirmed that banking customers aged between 18-35 years old are the most active when it comes to underwrite new financial services. The conclusions drawn on the "actions" of young people tend to dictate the needs for change in the banking channels, thus eventually also affecting the older individuals preferences.

*Keywords: Banking sector; crisis; trust; youth; European Customer Satisfaction Index (ECSI)*

## REFERENCES

- Ball, D., Coelho, P. and Machás, A. (2004), "The role of communication and trust in explaining customer loyalty", *European Journal of Marketing*, Vol.38 No.9/10, pp. 1272 – 1293.
- Beerli, A., Martín, J. and Quintana, A. (2004), "A model of customer loyalty in the retail banking market", *European Journal of Marketing*, Vol.38 No.1/2, pp.253 – 275.
- Berry, L. (1983). *Relationship marketing*. American Marketing Association.
- Berry, L.(1995), "Relationship Marketing of Services- Growing Interest, Emerging Perspectives", *Journal of the Academy of Marketing Science*, Vol.23 No.4, pp. 236-245.
- Chaudhry, T. and Jayasekera, R. (2014), "Market efficiency during the global crisis. Empirical evidence from European banks", *Journal of International Money and Finance*. Vol.49, pp.299-318.
- Fornell, C., Johnson, M., Anderson, E., Cha, J. and Bryant, B. (1996), "The American Customer Satisfaction Index: Nature, Purpose, and Findings", *Journal of Marketing*, Vol.10, pp.7-18.
- Grönroos, C. (2006), "Adopting a service logic for marketing", *Marketing theory*, Vol.6 No.3, pp. 317 - 333.
- Shim, S., Serido, L. and Tang, C. (2013), "After the global financial crash: Individual factors differentiating young adult consumers' trust in banks and financial institutions", *Journal of Retailing and Consumer Services*, Vol.20, pp.26 – 33.
- Yoganathan, D., Jebarajakirthy, C. and Thaichon, P. (2015), "The influence of relationship marketing orientation on brand equity in banks", *Journal of Retailing and Consumer Services*, Vol.26 No.1, pp. 14 – 22.

## THE IMPORTANCE OF SOUND IN THE GAMING AREA OF A CASINO

Wannenburg, Elizma; Drotsky, Tonie; De Jager, Johan

Faculty of Management Sciences, Department of Marketing, Logistics and Sport Management, Tshwane University of Technology, Pretoria, South Africa

### ABSTRACT

### INTRODUCTION

When entering a supermarket, consumers are faced with various consumer products that varies in size, colour, weight, volume, smell, taste, touch, quantity and style to name a few. These elements are known as product attributes. Casinos are in a sense similar to supermarkets seeing that visitors to the casino are faced with hundreds of slot machines that differ in colour, theme and sound. a reporter at the Baltimor Sun also indicated that time and technologies are catching up with traditional slot machines, which don't hold anywhere near the same appeal for younger players as they do for their parents. In an interview with the former gaming director of the Sun International casino group in South Africa, Mr Witcher (2016) he agrees with Barker (2015) and pointed out that casinos need to stay abreast of the new technological developments in the gaming market in order to satisfy the needs of new slot machine gamers.

### RESEARCH METHODOLOGY

The research question can be asked: "Does sound have any influence on gamers' slot machine selection? To answer this question, the study intends to explore the importance of music in the gaming area as well as sound as slot machine attribute. For the purpose of this paper a hypothesis was formulated:

#### Hypothesis 1

**H<sub>01</sub>**-No significant differences exist between male and female slot machine gamers regarding the way they perceive sound as a slot machine attribute.

**H<sub>a1</sub>**-Significant differences exist between male and female gamers regarding the way they perceive sound as a slot machine attribute.

The primary objective of this paper is to determine whether sound, as slot machine attribute, play any role in the gamers' slot machine selection process. The secondary objectives of this paper are to determine whether slot machine gamers are influenced by the sound effects found in the gaming area of the casino and to determine if slot machine gamers would enjoy playing on slot machines with new

pay-out sound effects. Cluster sampling method was used to select six Sun International casinos in South Africa. Personal interviews and self-administrated questionnaires were used in this study. Field workers conducted structured interviews with 630 gamers in the gaming areas and 10 regular slot-machine gamers at each of the six selected casinos were asked to complete a self-administered questionnaire in an enclosed environment. The purpose of the self-administered questionnaire was to determine whether colour, theme and sound, as slot-machine attributes, could be seen as important slot-machine attributes or not. The researcher used a conjoint analysis, whereby music along with different slot machine themes and colours were combined to determine if sound effects are amplified when visual stimuli are added.

## RESULTS AND RECOMMENDATIONS

The data were captured on an Excel spread sheet and then statistically analysed with the SPSS version 20 software program. Chi-square test in Frequency distribution tables were used to establish the levels of agreement and disagreement between male and female gamers. The results indicated that  $H_0$  ( $p > 0.05$ ) was accepted for nine variables and one variable was rejected. The rejected variable indicated that male and female gamers perceive sound as a slot machine attribute differently. The self-administered questionnaire used in this paper was statistically analysed by means of a conjoint analysis. Sound as a slot machine attribute was rated the most important slot machine attribute and the Las Vegas melody followed by the fantasy melody were most enjoyed by slot machine gamers. It is recommended that slot machine manufacturers and casino management should take sound effects into consideration when designing or acquiring new slot machine games. The sound effects of the slot machines could influence the gamers and that can lead to approach or avoidance behaviour by the gamers. It is further recommended that slot machine manufacturers should: create pay-out sound effects that sound realistic, musical melodies can also be added to the pay-out sound effects; the option to control the sound levels of the pay-out sound effects can also be considered. In conclusion, sound is a piece of art that enters in the ears of the gamers, straight to the heart of the gamers.

*Keywords: sound, slot machine, casino, music, gamers, selection, gaming*

*In loving memory of Dr Tonie Drotzky<sup>2</sup>*

*(Co-author)*

## REFERENCES

- Barker, J. 2015. New-fangled machines will aim to hook younger casino players. [Online] Available from: <http://www.baltimoresun.com/business/bs-bz-slots-millennials-20150724-story.html>. [Accessed: 13/06/2017].
- Whitcher, D. 2016. Interview. Johannesburg. (Notes in possession of author).

# THE IMPACT OF THE SUBSIDIARY'S INTRAPRENEURIAL CAPACITY ON THE EVOLUTION OF MNC'S STRATEGIC ORIENTATION IN THE EURO- MEDITERRANEAN REGION

Yahiaoui, Dorra<sup>1</sup>; Chebbi, Hela<sup>2</sup>

<sup>1</sup>Kedge Business School, France

<sup>2</sup>EDC Paris Business School, France

## ABSTRACT

### THEORY

The last two decades, a growing number of European multinational corporations (MNCs) have established subsidiaries in the south-Mediterranean countries, especially in North Africa. Few researches were made on how such European MNCs are controlling and managing their operations in these countries (D'Iribarne, 1987; Franck, 1997). However, less is known about the evolution of the strategic orientation of the MNC operating in this region.

This dominance of French FDI in Tunisia is partly an outcome of history and culture. According to Zghal (2000), France's colonisation of Tunisia has left behind cultural and institutional influences which contribute to enabling French FDI today. There are, for instance, similarities in several aspects of Tunisian and French employment law (Zghal, 2000; Yahiaoui, 2015). Similarly, certain characteristics of French management which were developed in the colonial period can be observed in contemporary Tunisian organisations. These include bureaucratic forms of control, a relatively high power distance between managers and workers, the importance of qualifications from the *grandes écoles* in recruitment and promotion, and the presence of strong trade unions (Yahiaoui, 2015). We add the influence of the French education system on the Tunisian one (Yagoubi, 2003) and the presence of many French schools (around twenty) in Tunisia. All of these historical and cultural factors give French FDI a unique advantage in Tunisia.

This paper aims at exploring the evolution of the MMNC's strategy in Tunisia. Particularly, it focuses on the impact of the subsidiary and its intrapreneurial strategy on this evolution. According to Perlmutter (1969) and Heenan and Perlmutter (1974), MNCs, depending on their stage of internationalisation, follow one of these four different strategic orientations: ethnocentrism (the dependence of subsidiaries on the parent company), polycentrism (decision-making autonomy of subsidiaries), geocentrism (subsidiaries as complementary to the parent company) and regiocentrism (decision-making, control and appraisals are carried out at regional level). According to previous research (D'Iribarne, 1987; Franck, 1997), French MNCs have tendency to prefer the ethnocentric



orientation. According to a survey carried out by Poirey (1997) on 35 French MNCs, ethnocentrism is *"moderate in Europe and developed countries, whereas it is high in developing countries"*.

The choice of MNCs' strategic orientation depends on a variety of different organizational, economic and cultural factors. The explanation most often advanced is linked to the quality of the labour force available in the host country (Dowling and Welch, 2004). Institutional context and pressure are also considered as other factors impacting the choice of strategic orientation. According to Kostova and Zaheer (1999), for example, subsidiaries are exposed to isomorphic pressures deriving from both home- and host-country institutional contexts. Perlmutter (1969) stresses the degree of economic development of the host country in determining the strategic orientation to adopt. Thus, MNCs often adopt a 'polycentric' orientation in relation to subsidiaries located in developed economies while opting for 'ethnocentrism' in developing nations. Based on these factors, Mucchielli (1998) confirms that strategic orientations have a tendency to change, with subsidiaries being given greater autonomy when they become more mature. The position and role of the subsidiary in the multinational network becomes very important in the evolution of the strategic orientation. Some subsidiaries operate as receptive while other act as more or less independent entities. According to Bartlett and Ghoshal (1986), this variety depends on the skills of the subsidiaries and the importance of their local environment. Since the 1990s, some authors have considered the subsidiary as an important source of knowledge because of the local relationships it develops (Birkinshaw, 1998; Birkinshaw and Hood, 1998). Considering the subsidiary as a real contributor to the whole MNC leads the headquarter to take advantage from the local initiatives. In this context, the intrapreneurial literature can be mobilized to understand the innovative capabilities of some subsidiaries.

Historically, intrapreneurship was perceived as the grip of innovative initiatives by an isolated, rather refractory employee on the organizational system of the company. This gave rise to a stream of literature based on *a positive, individualistic, and not programmable abnormality of corporate entrepreneurship* (Le Masson and Weil, 2009). On the organizational level, intrapreneurship is a part of an innovative strategy based on initiatives and autonomy (Ireland et al. 2009; carrier 2000). Many researchers underlined the importance of the favorable conditions under which they evolve within the organization. The employees can innovate within their organizations on different levels (Thornberry, 2001): organizational transformation, new activities' creation, new products/services' creation, etc. The challenge of the top managers thus is to exploit the workspace to promote new and disruptive ideas in the whole organization.

The intrapreneurial strategy first needs the creation of a convenient working environment to develop innovation, where every collaborator can show his/her ability. To assess the intrapreneurial behavior, we chose the CEAI method (corporate entrepreneurship assessment instrument). This instrument was

initially created in 1990 by Kuratko et al. It aims at measuring the efficiency of internal organizational factors or the climate susceptible to influence activities and innovative behavior. This model was tested and validated by Hornsby and al. (2002, 2013). The more recent validation showed five main factors that can favor any intrapreneurial approach: top management support, work discretion, reward system, time availability, and organizational boundaries.

In the MNCs context, the parent company and the subsidiary can have different life cycles, which may lead to an evolution of the subsidiary's behaviour (Chebbi and Yahiaoui, 2012). In some cases, a headquarter can afford a favourable environment for some mature subsidiaries to be innovative. This intrapreneurial strategy can enrich the MNC's and lead the headquarter to change its strategic orientation towards it.

## **METHODOLOGY**

To pursue our research question about this subject, we conducted a qualitative study within two medium sized Tunisian subsidiaries of one French MNCs (Chemical) operating in Tunisia for more than 20 years. We adopted an exploratory case study methodology (Yin, 2014) in order to explore the evolution of its strategic orientation. We conducted our qualitative research in two phases (2005-06 and 2016) in France and in Tunisia in order to examine whether the intrapreneurial capability of Tunisian subsidiaries influenced the strategy of Chemical Company. We conducted 26 semi-direct interviews in two distinct phases. In the first phase (2005-2006), we conducted interviews with 2 Tunisian HR managers, 10 Tunisian general managers and 3 HR managers from the parent companies in charge of the North Africa region and involved in international strategic decision making. The 5 general managers of each company were belonging to different departments (sales, manufacturing, marketing, finance, and logistics). The main themes and questions discussed during these interviews are related to international strategy, the environment established by parent company to foster innovation (top management support, work discretion, reward system, time availability, and organizational boundaries) and the intrapreneurial behavior of local subsidiaries,. In phase two (2016), we returned a decade later in order to investigate whether and how the firms' strategic orientation had changed over time. We interviewed 2 new Tunisian HR managers, 1 previous Tunisian HR manager that had moved to another position as legal compliance manager and 8 Tunisian general managers belonging to manufacturing, marketing, finance and logistics. The interviews lasted between 1 and 2 hours. All interviews were recorded and then transcribed. The data was then coded using NVivo software and analyzed following Miles and Huberman (1994) guidelines.

## **FINDINGS AND CONTRIBUTIONS**

The analysis of the first interviews in 2006 reveals a clear desire for "*standardisation*". A high ethnocentrism orientation is noticed in Chemical, expressed through its unilateral transfer of home-country practices and the use of French expatriates to manage the subsidiaries and make important decisions. These statements therefore lead us to believe that there is no willingness to take local practices into account and that the parent company's practices are superior. This quest for the subsidiaries' conformity to the practices of their parent company seems to contribute to establishing a common corporate culture to all the group in order to maintain competitiveness, facilitate the national and international identification of the practices in all the subsidiaries and help audit and control the subsidiaries. This could be explained by the priority given by the headquarter to institutional characteristics that resemble their own in the host country. Among these characteristics, we have identified the similarity between the Tunisian and French education systems. Local staff acculturation through the adoption of certain standards of the parent company country, linked to the history between the two countries, is also an important factor in bringing them together.

Deeply concerned about the development of their subsidiaries in Tunisia, the parent company HRDs view the subsidiary country's HRM practices as old and inefficient. These managers try to change the subsidiary's local environment by transferring their own practices, which are considered more modern and efficient, hence the evolutionist stance.

Ten years later, we returned to the same companies for further research and interviewed the local managers. Our analysis shows a gradual move to less ethnocentric forms and also a great change in the position of Tunisian subsidiaries. After the revolution occurred in 2011, local entities become more mature and asked for more autonomy. This "rebel behavior" leads the headquarter to review its policy on different levels.

The top management support becomes more important since 2011 and become a facilitator by mobilizing the necessary human and financial resources for innovative and audacious local employees. Some expatriates are replaced by local managers to promote the ideation, culture of sharing and error acceptance (McGinnis and Verney, 1987). The corporate culture also evolved to pay more attention to the collaboration and less formalization. Some global rewards system are established for the Tunisian subsidiaries while giving employees time to create and think out the box. Considering the organizational boundaries, internal and external collaborations become open and local subsidiaries can work with local startups to provide some innovative projects.

Consequently to these changes, Chemical, in 2016, moved away from an ethnocentric orientation toward, a geocentric strategy. Most of the Tunisian managers went on training programmes in France once a year or every two years to update their knowledge in their respective field of expertise and present their ideas. There was a clear interest in having Tunisian managers operate more

autonomously, thereby reflecting a shift to geocentrism. Success in Tunisia thus depended on a degree of decentralisation but this was very much on the condition that the Tunisian environment and market – and by implication Tunisian managers – remained French-like.

The orientation of Chemical evolved from ethnocentric to a geocentric strategy according to the configuration of Heenan and Perlmutter (1974). This is due to the change of the behaviour of Tunisian subsidiaries and their maturity. After the revolution, the managers of the Tunisian subsidiary considered that they don't have to behave passively. Their intrapreneurial capability leads the parent company to trust the local employees. The interviews made in 2016, showed that the Tunisian subsidiary is no more considered as a receptive unit but as a real contributor to the whole MNC network. Each subsidiary can add its contribution thanks to its local competencies, but the main decisions remain still to the parent company. The local suppliers of the subsidiary become real partners of the whole group. This result confirms the conclusion of Kynighou (2014) among others (Perlmutter, 1969). In this sense, our results contradict the literature (Mucchielli, 1998; Jaussaud et al., 2000) which states that practices are often transferred in subsidiaries at the time of their set-up and that as the subsidiary matures it becomes more independent.

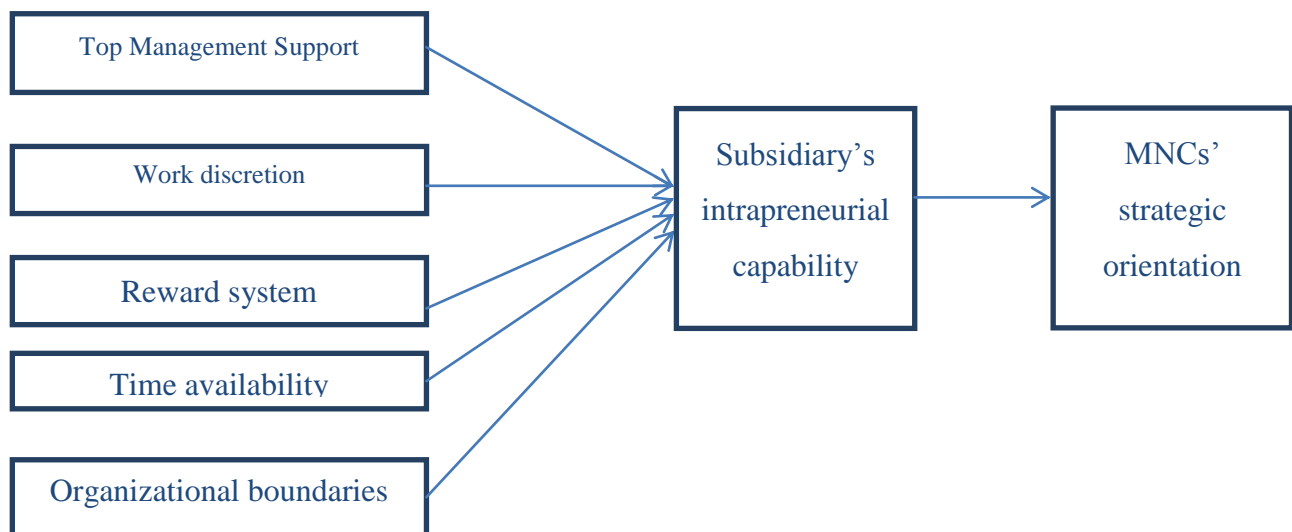

*Keywords: Strategic orientation, MNCs, intrapreneurship, France, Tunisia, Euro-Mediterranean*

## REFERENCES

- Bartlett, C.A., & Ghoshal, S. (1989). *Managing Across Borders*. Harvard Business Press, Boston, MA.
- Birkinshaw, J. (1998), Multinational subsidiary evolution: capability and charter change in foreign-owned subsidiary companies, *Academy of Management Review*, vol. 23, n°4, pp. 773-795.
- Birkinshaw, J. Hood, N (1998), Multinational subsidiary evolution: capability and charter change in foreign-owned subsidiary companies, *Academy of Management Review*, vol. 23, N°4, pp.773-795.

- Carrier, C. (2000), L'intrapreneuriat: à la recherche de complices innovants et entrepreneurs, dans Verstraete, T. (dir.), Histoire d'entreprendre : les réalités de l'entrepreneuriat. Éditions Management et Société, pp. 199-210.
- Chebbi H., Yahiaoui, D, (2012), "Local subsidiaries initiatives: Cultural determinants and outcomes", World Review of Entrepreneurship, Management and Sustainable Development, Vol. 8, N°4, p. 389-404
- D'Iribarne, P. (1987). Ce qui est universel et ce qui ne l'est pas. Revue française de gestion, 64, 6-9.
- Dowling, P.J., & Welch, D.E. (2004). International human resource management: Managing people in a multinational context, London, Thompson, 4th Edition.
- Franck, G. (1997). A la conquête du marché américain. Paris, les éditions Jacob.
- Heenan, D., & Perlmutter H. (1974). How Multinational Should Your Top Manager Be?. Harvard Business Review, 52(6), 121-132.
- Hornsby, J. S., Kuratko, D. F., & Zahra, S. A. (2002). Middle managers' perception of the internal environment for corporate entrepreneurship: Assessing a measurement scale. Journal of Business Venturing, 17, 253-273.
- Hornsby, J. S., Kuratko, D. F., Holt, D. T., Wales, W. J. (2013), Assessing a measurement of organizational preparedness for corporate entrepreneurship, Journal of Product Innovation Management, Vol. 30, p. 937-995.
- Ireland, R.D., Covin J.G., Kuratko D.F. (2009), Conceptualizing Corporate Entrepreneurship strategy, Entrepreneurship: Theory and Practice, Vol. 33, p. 19-46.
- Jaussaud, J., Schaaper, J., & Zhang, Z.Y. (2000). Gestion internationale des ressources humaines : pratiques d'expatriation et contrôle des filiales au sein des groupes multinationaux. Revue de gestion des ressources humaines, 38, 133-145.
- Kostova, T., & Roth, K. (2002). Adoption of an organizational practice by subsidiaries of multinational corporations: institutional and relational effects. Academy of Management Journal, 45(1), 215-233.
- Kynighou, A. (2014). Variations in corporate influence over HRM between the early and later stages in the life of foreign subsidiaries. International Journal of Human Resource Management, 25(1), 113-132.
- Kuratko, D. F., Montagno, R. V., & Hornsby, J. S. (1990). Developing an intrapreneurial assessment instrument for an effective corporate entrepreneurial environment. Strategic Management Journal, 11, 49-58
- Le Masson P., Weil B. (2009) La conception innovante comme mode d'extension et de régénération de la conception réglée : les expériences oubliées aux origines des bureaux d'études. Entreprises et Histoire, Eska, vol. 58, p.51-73.
- McGinnis M.A., Verney T.P. (1987), Innovation management and intrapreneurship, Advanced Management Journal, Vol. 52, p. 19-23.
- Miles, M. B., & Huberman, A. M. (1994). Qualitative data analysis (2nd ed.). Thousand Oaks, CA: Sage.
- Mucchielli, J.L. (1998). Multinationales et mondialisation. Paris, les éditions du Seuil.
- Perlmutter, H. (1969). The Tortuous Evolution of the Multinational Corporation, Columbia journal of world business. 4. 9-8.
- Poirey, K. (1997). Ethnocentrisme dans les organisations multinationales françaises : quels risques de crise pour la gestion internationale des ressources humaines ?, Actes du 8ème congrès de l'AGRHR, Montréal.
- Thornberry, N.(2001), Corporate Entrepreneurship: Antidote or Oxymoron?, European Management Journal, Vol. 19, p. 526-533.
- Yin, R. K. (2014). Case study research, design and methods (5th ed.). Thousand Oaks, CA: Beverly Hills.
- Yagoubi, M. (2003). HRM in Tunisia. In Kamoche, K., Debrah Y., Horwitz F., Nkombo Muuka G., Managing human resources in Africa, London, Routledge.
- Yahiaoui, D. (2015). Hybridization: striking the balance between the adoption and adaptation of Human resource management practices within French MNCs and their Tunisian subsidiaries. The International Journal of Human Resource Management, 26(13), 1665-1693.
- Zghal, R. (2000). Globalisation et différences des systèmes de gestion, les entreprises au Maghreb et la gestion des ressources humaines. In Actes du colloque, L'analyse des organisations et le management stratégique : perspective latine, Zacatecas.

# AN EXAMINATION OF THE INFLUENCE OF ISLAMIC BRAND LOVE ON BRAND LOYALTY, WORD OF MOUTH AND PURCHASE INTENTION: AN EMPIRICAL STUDY IN SAUDI ARABIA

Yousef, Waleed; Melewar, T.C.; Dennis, Charles; Foroudi, Pantea

The Business School, Middlesex University London, United Kingdom, UK

## ABSTRACT

This research aims to examine religious beliefs as a new antecedent to brand love, and proposes a new construct which is Islamic brand love. Brand love as a construct has been linked with different constructs such as brand loyalty, brand trust, brand likeability, brand commitment and word of mouth (Albert and Merunka, 2013; Batra et al., 2012; Cengiz and Yayla, 2007; Nguyen et al., 2013). In addition, brand love can be influenced by other psychological factors such as cultural identity, religiosity or strongly held values (Batra et al., 2012). Therefore, it is suggested that religious beliefs as one of the cultural components can be one of the brands love antecedents. (See the conceptual model in figure 1).

To address the research objective, a mixed method research design will be adopted following a positivist research philosophy (Malhotra and Birks, 2003). From the positivist perspective, qualitative methods can be applied in the initial stages of research in order to gain a deeper understanding of the nature of the research problem and also to improve the primary research model and hypotheses (Malhotra and Birks, 2003). Since this study aims to investigate the influence of religious beliefs on brand love within the Islamic context, qualitative research methods will be used in the first stage. Therefore, Churchill's (1979) paradigm will be adapted in this study, in order to develop a scale for the new construct proposed (Islamic brand love). Moreover, the relevant literature will be reviewed to validate the scale, and to generate measurement items. In order to collect sufficient information of the Islamic brand love as focal construct, three focus group interviews will be conducted with Muslim consumers and seven in-depth interviews will be conducted scholars of Islamic studies. Therefore, by employing a mixed method approach, with a quantitative basis, but using some qualitative techniques in the early stages of the research, it is possible to generate law-like regularities which can later be generalized to broader situations.

This study contributes to the academic body of knowledge on the brand love construct by providing religious beliefs as a new antecedent. Since love is considered to be the highest level of satisfaction (Albert et al., 2008), it is vital for brand managers to focus on consumers' religious beliefs to create love for their brands.

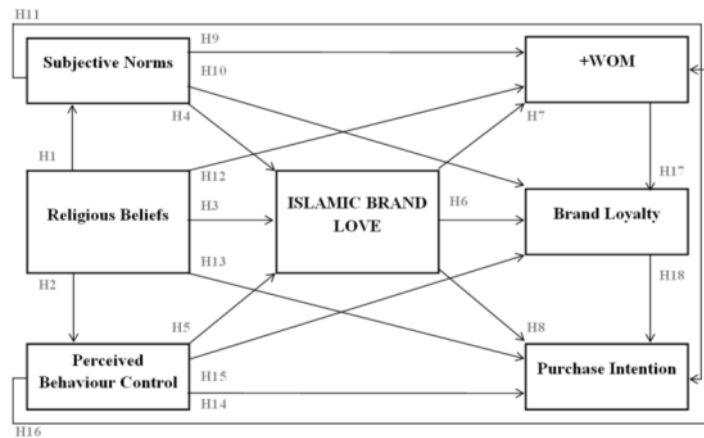
**Figure 1: The conceptual model**

Source: The researcher

**Keywords:** Islamic brand love, Brand love, Religious beliefs, Brand loyalty, Word of mouth, Purchase intention

## REFERENCES:

- Albert, N. and Merunka, D., 2013. The role of brand love in consumer-brand relationships. *Journal of Consumer Marketing*, 30(3), pp.258-266.
- Albert, N., Merunka, D. and Valette-Florence, P., 2008. When consumers love their brands: Exploring the concept and its dimensions. *Journal of Business research*, 61 (10), pp.1062-1075.
- Batra, R., Ahuvia, A. and Bagozzi, R.P., 2012. Brand love. *Journal of Marketing*, 76 (2), pp.1-16.
- Cengiz, E. and Yayla, H.E., 2007. The effect of marketing mix on positive word of mouth communication: Evidence from accounting offices in Turkey. *Innovative Marketing*, 3 (4), p.73.
- Churchill Jr, G. A. (1979). A paradigm for developing better measures of marketing constructs. *Journal of marketing research*, 64-73.
- Malhotra, N.K. and Birks, D.F., 2007. *Marketing research: An applied approach*. Pearson Education.

**STYLES OF GOVERNANCE AND COMPANY PERFORMANCE. NEW  
INTERDISCIPLINARY MODEL APPLIED TO BEST PERFORMING  
AUTOMOTIVE INDUSTRY GIANTS**

**Zanda, Stefania**

Department of Management, Sapienza University, Rome, Italy

**ABSTRACT**

The choice of the automotive industry derives from the major role that this sector plays in the economies of the main industrialized countries, particularly in Western Europe, especially in terms of employment and the percentage share of GDP, despite the significant downsizing in the last twenty years in terms of production and turnover.

In 1990, car production in Western Europe was 38% of the world market; in 2015, it was just over 17.4%. However, some car manufacturers, have returned to register significant increases in terms of production and sales with different dynamics (2014-2016).

We wondered whether in a general climate of the Knowledge economy, in which the technological, economic and financial efforts required to counter competition, regain market share and increase sales, have required specific adaptation in terms of management styles.

Our research involves the construction of a systematic model to assess the management style of executives in the last five years.

The model chosen is interdisciplinary and is combined with our own questionnaire to be submitted to the top management of the best-performing car companies, to investigate different organizational variables.

Analysis of the questionnaire involves determining an overall score for each executive interviewed, to which are associated the values of the following outcome variables for the individual companies: ROI, ROE, increase/decrease of turnover, increase in number of employees.

The research objective is to identify which variables of management models adopted by managers of the analyzed companies were more efficient in terms of efficiency, effectiveness and development of the companies.

*Keywords: leadership, knowledge management, management models, organizational variables, intellectual capital, management process, performance indicators, strategic management, automotive.*



## **ECONOMIC AND SOCIAL COMMUNICATION NETWORKS: STRUCTURAL COMPARISON**

**Zvereva, Olga M.; Kondratyev, Andrey; Zverev, Fedor**

Ural Federal University, UrFU, Russia, Ekaterinburg

### **ABSTRACT**

#### **ECONOMIC AND SOCIAL SYSTEMS AS COMMUNICATION NETWORKS**

Communication process is a process which runs in systems from various scientific domains. There is a scientific branch known as communication theory which studies communications, and it determines a single communication as a process with the following obligatory characteristics: there are, at least, two entities taking part in the process (they are both called communicants, or a communicant and a recipient); there is something to be transferred and is of a real value for both communicants (presented in a material or non-material form); there is a communication channel for transferring; and a communication process must have a goal (Kashkin, 2013). There is no doubt that communications are the basis for every social group existence, but the fact that economic system, in its essence, is a communication network can be debated. To prove that relations in an economic system may be considered as communications, it is necessary to look for the earlier discussed characteristics. In an economic relation two communicants are involved: one of them initiates communication in order to sell manufactured product, and the other consumes this product to produce its own output. Something to be transferred is a product manufactured by one of the communicants (a seller), and it is of a value for another communicant (a customer). As a kind of a channel, one can consider a logistic chain. Through a channel the product is moving in one direction, and money is moving in the opposite direction. The goal of this process is to exchange a product for money.

Moreover, social and economic systems can be considered as networks and visualized as graphs where communicants become nodes (vertices) and communications are links (in most cases arcs). Social systems as networks are considered by most of nowadays professionals in sociology, main concepts of the network approach were formulated by B. Wellman in (Wellman, 1988). There is a special methodology, SNA-methodology (SNA- Social Network Analysis), proposing techniques, methods, and parameters for a social system investigation from the network standpoint. This methodology is based on graph theory, linear algebra and sociometric theory.

In economics many scholars also consider a network to be the most prospective system structure. Fukuyama in (Fukuyama, 2000) argued that, being an intermediate form between hierarchy and

market, a network proposed the best opportunities for technology development and organization success in the modern world.

The main goal of this submission is to compare structural characteristics of economic and social local networks and to understand whether both type networks are similar or have certain peculiarities. Thorough understanding of communication process structure could result in recommendations for economic and social communication process improvements. This research focus was made on the issue of system sustainability, it was decided to find social and economic system structural peculiarities from the standpoint of sustainability support.

## **EXPERIMENTAL NETWORKS**

To compare network structures, one must engineer these networks on the basis of some data. It is a common knowledge that it is very difficult to receive real economic data. That is why, economic communication networks were developed with the experimental economics approach usage. On the basis of three different entrepreneurial communities three economic communication networks were generated as results of business games. For more relevance, these business games were organized in three different regions of Russian Federation: Ufa city (Bashkortostan Republic), Ekaterinburg (one of the industrial centres), and Moscow (the capital of Russia). Participating in these games, individuals exchanged goods and services in the way similar to they are doing in the real life.

As to social network engineering, data was collected with "KOMPAS TQM" information system usage. "KOMPAS TQM" system is a quality management system which was implemented into the educational process of one of the departments in Ural Federal University. This system supports the process of regular communication result evaluation. System users enter positive or negative marks from the certain range. Thus, the marks entered into the system reflect the real communications between system users. The mark sign ("+" or "-") characterizes the recipient attitude to the communication result in a whole (positive or negative) while numerical value (from 1 to 5 points) reflects the strength (weight) of this communication (i.e. the usefulness degree for the recipient). This research process and results are discussed in details in (Berg and Zvereva, 2015). Two networks under discussion are visualized in Fig.1: Fig.1*a* is a network of social communications, and Fig. 1*b* is a network of economic communications – the result of the business game in Ufa city.

## **STRUCTURAL TEMPLATES OF SYSTEM SUSTAINABILITY**

In economic systems cyclic (closed) contours are considered to be structural patterns for system sustainability. To prove this fact special SNA techniques were used: for every investigated network the set of corresponding (of the same size and density) Erdos-Renyi random graphs was built, than the

number of cycles was calculated in the investigated economic network and in the random graphs (mean value), and these numbers were compared. To reveal cyclic structures in a graph program framework was engineered (both graphs in Fig.1 are depicted by this framework). It was revealed that in all inspected cases the number of revealed cycles in an economic network is greater than in the corresponding random graph set. The result for social networks was quite opposite: cyclic structures were more seldom for social networks than for corresponding random graphs. We can postulate that a cyclic pattern is a very seldom structure in a social network and cannot be considered as a basis for its sustainability.

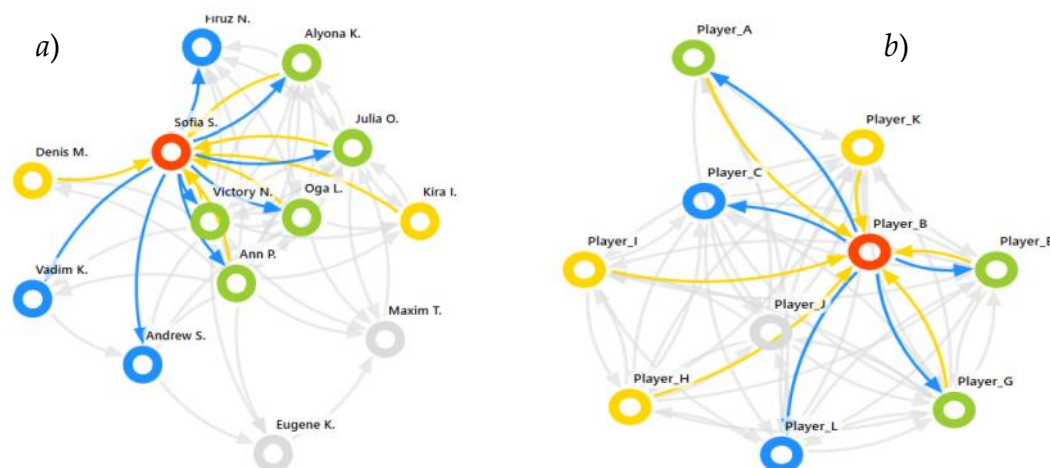

Figure 1. Social communication network (a) and economic communication network (b)

There are several theories (models) of structural balance developed for social system analysis. Most of them are based on and extend the cognitive theory of Heider (Faust, 2007). They can be realized using triad census, a special network characteristic, which can be received by Pajek framework (Pajek, 2017). As in the discussed case with cyclic structures, network censuses were received for every social and economic network and for the aim of comparison with corresponding random networks. It was revealed that the social network triad censuses correspond to the structural balance models (some of them) while corresponding random graphs do not. For the economic networks both network and random graph censuses were not in accordance with these structural balance models.

As a result, we can conclude that although social and economic issues are tightly interconnected and intertwined in our life, both type communication networks have their own structural peculiarities. Keeping this fact in mind, managers can try to improve a network structure in accordance with its type and goals: if the goal is to increase efficiency of production, it means that a network is of an economic type, and it is necessary to provide cyclic structures for its sustainable functioning. If an analyzed system (network) is formed of social communications than for its sustainable existence, its structure has to be modified to be in accordance with structural balance models.

*Keywords: Communications, Network, Social Network Analysis (SNA), Sustainability, Structural Balance, Triad Census, Cyclic Contour*

## REFERENCES

- Berg, D. and Zvereva, O. (2015), "Identification Of Autopoietic Communication Patterns in Social And Economic Networks", in N. Konstantinova, et.al. (Ed.). *Analysis Of Images, Social Networks And Texts*. 4th International Conference, AIST 2015 Yekaterinburg, Russia,. Revised Selected Papers. S.L.Springer International Publishing Switzerland, pp. 286-294.
- Faust K. (2007), "Very Local Structure In Social Networks", *Sociological Methodology*. Volume 37, Issue 1, pp.209-256
- Fukuyama, F. (1999), *Great Disruption: Human Nature and the Reconstitution of Social Order*, Free Press, 368p.
- Kashkin, V.B. (2013), *Introduction to Communication Theory*, Nauka:Flinta, Moscow, 224p.
- Pajek (2017): "Analysis and visualization of large networks", available at: <http://mrvar.fdv.uni-lj.si/pajek/>, (accessed 12 April 2017).
- Wellman, B. (1988), "Social Structures: A Network Approach", in B.Wellman & S. Berkowitz (Ed.), *Structural Analysis: From Method And Metaphor To Theory And Substance*. Cambridge, England, Cambridge University Press, pp. 19-61.