

DROPS

Dagstuhl Research Online Publication Server



License

when quoting this document, please refer to the following

DOI: [10.4230/DagRep.6.6.10](https://doi.org/10.4230/DagRep.6.6.10)

URN: [urn:nbn:de:0030-drops-67255](https://nbn-resolving.org/urn:nbn:de:0030-drops-67255)

URL: <http://drops.dagstuhl.de/opus/volltexte/2016/6725/>

Aumann, Yonatan ; Lang, Jérôme ; Procaccia, Ariel D.

Weitere Beteiligte (Hrsg. etc.): Yonatan Aumann and Jérôme Lang and Ariel D. Procaccia

Fair Division (Dagstuhl Seminar 16232)

pdf-format: [dagrep_v006_i006_p010_s16232.pdf \(0.8 MB\)](#)

Abstract

This report documents the program and the outcomes of Dagstuhl Seminar 16232 "Fair Division". The seminar was composed of technical sessions with regular talks, and discussion sessions distributed over the full week.

BibTeX - Entry

```

@Article{aumann_et_al:DR:2016:6725,
  author = {Yonatan Aumann and Jérôme Lang and Ariel D. Procaccia},
  title = {{Fair Division (Dagstuhl Seminar 16232)}},
  pages = {10--25},
  journal = {Dagstuhl Reports},
  ISSN = {2192-5283},
  year = {2016},
  volume = {6},
  number = {6},
  editor = {Yonatan Aumann and Jérôme Lang and Ariel D. Procaccia},
  publisher = {Schloss Dagstuhl--Leibniz-Zentrum fuer Informatik},
  address = {Dagstuhl, Germany},
  URL = {http://drops.dagstuhl.de/opus/volltexte/2016/6725},
  URN = {urn:nbn:de:0030-drops-67255},
  doi = {10.4230/DagRep.6.6.10},
  annote = {Keywords: cake cutting, computational social choice, envy-freeness, fair division}
}

```

Keywords: cake cutting, computational social choice, envy-freeness, fair division

Seminar: Dagstuhl Reports, Volume 6, Issue 6

Issue date: 2016

Date of publication: 2016

[DROPS-Home](#) | [Fulltext Search](#) | [Imprint](#)

Operated by LZI 

Fair Division

Edited by

Yonatan Aumann¹, Jérôme Lang², and Ariel D. Procaccia³

1 Bar-Ilan University – Ramat Gan, IL, yaumann@gmail.com

2 University Paris-Dauphine, FR, lang@lamsade.dauphine.fr

3 Carnegie Mellon University – Pittsburgh, US, arielpro@cs.cmu.edu

Abstract

This report documents the program and the outcomes of Dagstuhl Seminar 16232 “Fair Division”. The seminar was composed of technical sessions with regular talks, and discussion sessions distributed over the full week.

Seminar June 5–10, 2016 – <http://www.dagstuhl.de/16232>

1998 ACM Subject Classification I.2.11 Distributed Artificial Intelligence

Keywords and phrases cake cutting, computational social choice, envy-freeness, fair division

Digital Object Identifier 10.4230/DagRep.6.6.10

Edited in cooperation with Nhan-Tam Nguyen

1 Executive Summary

Yonatan Aumann

Steven J. Brams

Jérôme Lang

Ariel D. Procaccia

License  Creative Commons BY 3.0 Unported license
© Yonatan Aumann, Steven J. Brams, Jérôme Lang, and Ariel D. Procaccia

Fair division has been an active field of research in economics and mathematics for decades. More recently, the topic has attracted the attention of computer scientists, due to its algorithmic nature and its real-world applications. There had been a first Dagstuhl Seminar on fair division, in 2007, and none since. The aim of the 2016 Dagstuhl seminar on fair division was to bring together top researchers in the field, from among the multiple disparate disciplines where it is studied, both within computer science and from economics and mathematics, to share knowledge and advance the state of the art.

The seminar covered fair division of both divisible and indivisible goods, with a good mix between economics and computer science (with a significant number of talks being about economics *and* computer science). Topics included algorithms, lower bounds, approximations, strategic behavior, tradeoffs between fairness and efficiency, partial divisions, alternative definitions of fairness, and practical applications of fair division. The ratio between the number of participants with a main background in computer science and in economics was about 3–1, with a couple of participants with another main background (mathematics or political science). This ratio is similar to the corresponding ratios for Dagstuhl seminars on computational social choice (2007, 2010, 2012, 2015).

The seminar started by a short presentation of the participants (3 minutes per attendee). The rest of the seminar was composed of technical sessions with regular talks, and discussion sessions distributed over the full week (Tuesday morning, Tuesday afternoon, Wednesday



Except where otherwise noted, content of this report is licensed under a Creative Commons BY 3.0 Unported license

Fair Division, *Dagstuhl Reports*, Vol. 6, Issue 6, pp. 10–25

Editors: Yonatan Aumann, Jérôme Lang, and Ariel D. Procaccia



DAGSTUHL
REPORTS

Dagstuhl Reports
Schloss Dagstuhl – Leibniz-Zentrum für Informatik, Dagstuhl Publishing, Germany

morning, Friday morning). One of these discussion sessions was specifically about *Fair division in the real world*, two were about open problems, and one was about high-level thoughts about the topic and its future. Moreover, there was a significant amount of time left for participants to interact in small groups.

2 Table of Contents

Executive Summary

<i>Yonatan Aumann, Steven J. Brams, Jérôme Lang, and Ariel D. Procaccia</i>	10
---	----

Overview of Talks

A discrete and bounded envy-free cake cutting protocol for any number of agents <i>Haris Aziz and Simon William Mackenzie</i>	14
Complexity of Manipulating Sequential Allocation <i>Haris Aziz, Sylvain Bouveret, Jérôme Lang, and Simon William Mackenzie</i>	14
Nash Social Welfare Approximation for Strategic Agents <i>Simina Brânzei, Vasilis Gkatzelis, and Ruta Mehta</i>	15
Equitable cake cutting <i>Katarina Cechlarova</i>	15
The Power of Swap Deals in Distributed Resource Allocation <i>Yann Chevaleyre</i>	16
Dividing homogeneous divisible goods among three players <i>Marco Dall’Aglío</i>	16
Price of Pareto Optimality in Hedonic Games <i>Edith Elkind</i>	16
Approximating the Nash Social Welfare <i>Vasilis Gkatzelis, Simina Brânzei, Richard Cole, Gagan Goel, and Ruta Mehta</i>	17
Matroids and Allocation of Indivisible Goods <i>Laurent Gourves</i>	18
The redesign of the Israeli medical internship lottery <i>Avinatan Hassidim</i>	18
Procedural Justice in Simple Bargaining Games <i>Dorothea Herreiner</i>	18
Inheritance Game <i>Mehmet Ismail</i>	19
Making the Rules of Sports Fairer <i>Mehmet Ismail and Steven J. Brams</i>	19
Open Problems: Rules That Make Service Sports More Competitive <i>Mehmet Ismail, Steven J. Brams, D. Marc Kilgour, and Walter Stromquist</i>	20
Direct algorithms for balanced two-person fair division of indivisible items: A computational study <i>Marc Kilgour and Rudolf Vetschera</i>	20
Maximin Envy-Free Division of Indivisible Items <i>Christian Klamler, Steven J. Brams, and Marc Kilgour</i>	20
What is the highest guaranteed maximin approximation? <i>David Kurokawa</i>	21
Fair Division under Additive Utilities: good and bad news <i>Hervé J. Moulin</i>	21

Strategy-Proofness of Scoring Allocation Correspondences for Indivisible Goods <i>Nhan-Tam Nguyen</i>	22
The Single-Peaked Domain Revisited: A Simple Global Characterization <i>Clemens Puppe</i>	22
Preferences over Allocation Mechanisms and Recursive Utility <i>Uzi Segal and David Dillenberger</i>	23
Fair Division of Land <i>Erel Segal-Halevi</i>	23
Fairness and False-Name-Proofness in Randomized Allocation of a Divisible Good <i>Taiki Todo, Yuko Sakurai, and Makoto Yokoo</i>	24
Deceased Organ Matching in Australia and New Zealand. <i>Toby Walsh</i>	24
Participants	25

3 Overview of Talks

3.1 A discrete and bounded envy-free cake cutting protocol for any number of agents

Haris Aziz (Data61 / NICTA – Sydney, AU) and Simon William Mackenzie (UNSW – Sydney, AU)

License © Creative Commons BY 3.0 Unported license

© Haris Aziz and Simon William Mackenzie

Main reference H. Aziz, S. Mackenzie, “A Discrete and Bounded Envy-Free Cake Cutting Protocol for Any Number of Agents”, arXiv:1604.03655v10 [cs.DS], 2016.

URL <http://arxiv.org/abs/1604.03655v10>

We consider the well-studied cake cutting problem in which the goal is to find an envy-free allocation based on queries from n agents. The problem has received attention in computer science, mathematics, and economics. It has been a major open problem whether there exists a bounded and discrete envy-free protocol. We resolve the problem by proposing a discrete and bounded envy-free protocol for any number of agents. The maximum number of queries required by the protocol is a power tower of n of order six. We additionally show that even if we do not run our protocol to completion, it can find in at most n^{n+1} queries a partial allocation of the cake that achieves proportionality (each agent gets $\frac{1}{n}$ of the value of the whole cake) and envy-freeness. Finally we show that an envy-free partial allocation can be computed in n^{n+1} queries such that each agent gets a connected piece that gives the agent $\frac{1}{3n}$ of the value of the whole cake.

3.2 Complexity of Manipulating Sequential Allocation

Haris Aziz (Data61 / NICTA – Sydney, AU), Sylvain Bouveret (LIG – Grenoble, FR & Université Grenoble-Alpes, FR), Jérôme Lang (University Paris-Dauphine, FR), and Simon William Mackenzie (UNSW – Sydney, AU)

License © Creative Commons BY 3.0 Unported license

© Haris Aziz, Sylvain Bouveret, Jérôme Lang, and Simon William Mackenzie

Joint work of Haris Aziz, Sylvain Bouveret, Jérôme Lang, Simon William Mackenzie

Main reference H. Aziz, S. Bouveret, J. Lang, S. Mackenzie, “Complexity of Manipulating Sequential Allocation,” arXiv:1602.06940v1 [cs.GT], 2016.

URL <http://arxiv.org/abs/1602.06940v1>

Sequential allocation is a simple allocation mechanism in which agents are given pre-specified turns and each agent gets the most preferred item that is still available. It has long been known that sequential allocation is not strategyproof. This raises the question about the complexity of computing a preference report that yields more additive utility than the truthful preference. We show that is NP-complete. In doing so, we show that a previously presented polynomial-time algorithm for the problem is not correct. We complement the NP-completeness result by two algorithmic results. We first present a polynomial-time algorithm for optimal manipulation when the manipulator has Boolean utilities. We then consider stronger notions of manipulation whereby the untruthful outcome yields more utility than the truthful outcome for all utilities consistent with the ordinal preferences. For this notion of manipulation, we show that there exists a polynomial-time algorithm for computing a manipulation.

3.3 Nash Social Welfare Approximation for Strategic Agents

Simina Brânzei (The Hebrew University of Jerusalem, IL), Vasilis Gkatzelis (Stanford University, US), and Ruta Mehta

License © Creative Commons BY 3.0 Unported license
 © Simina Brânzei, Vasilis Gkatzelis, and Ruta Mehta
Main reference S. Brânzei, V. Gkatzelis, R. Mehta, “Nash Social Welfare Approximation for Strategic Agents,”
 arXiv:1607.01569v1 [cs.GT], 2016.
URL <http://arxiv.org/abs/1607.01569v1>

The fair division of resources among strategic agents is an important age-old problem that has led to a rich body of literature. At the center of this literature lies the question of whether there exist mechanisms that can implement fair outcomes, despite the agents’ strategic behavior. A fundamental objective function used for measuring fair outcomes is the *Nash social welfare* (NSW), mathematically defined as the geometric mean of the agents’ values in a given allocation. This objective function is maximized by widely known solution concepts such as Nash bargaining and the competitive equilibrium with equal incomes.

In this work we focus on the question of (approximately) implementing this objective. The starting point of our analysis is the Fisher market, a fundamental model of an economy, whose benchmark is precisely the (weighted) Nash social welfare. We study two extreme classes of valuations functions, namely perfect substitutes and perfect complements, and find that for perfect substitutes, the Fisher market mechanism has a constant price of anarchy (PoA): at most 2 and at least $e^{\frac{1}{e}}$ (≈ 1.44). However, for perfect complements, the Fisher market mechanism has an arbitrarily bad performance, its bound degrading linearly with the number of players.

Strikingly, the Trading Post mechanism – an indirect market mechanism also known as the Shapley-Shubik game – has significantly better performance than the Fisher market on its own benchmark. Not only does Trading Post attain a bound of 2 for perfect substitutes, but it also implements almost perfectly the NSW objective for perfect complements, where it achieves a price of anarchy of $(1 + \epsilon)$ for every $\epsilon > 0$. Moreover, we show that all the equilibria of the Trading Post mechanism are pure (so these bounds extend beyond the pure PoA), and satisfy an important notion of individual fairness known as proportionality.

3.4 Equitable cake cutting

Katarina Cechlarova (Pavol Jozef Safarik University – Kosice, SK)

License © Creative Commons BY 3.0 Unported license
 © Katarina Cechlarova
Joint work of Katarina Cechlarova, J. Dobos, E. Pillarova

The cake is represented by real interval $[0,1]$ and each of n players has her valuation of the cake in the form of a nonatomic probability measure. We look for equitable divisions, i.e. such that the values received by players by their own measures are equal, and everybody gets one contiguous piece. We show that such divisions always exist but they cannot be computed by a finite algorithm. Therefore we propose a simple algorithm to find approximately equitable divisions.

3.5 The Power of Swap Deals in Distributed Resource Allocation

Yann Chevaleyre (University of Paris North, FR)

License  Creative Commons BY 3.0 Unported license
© Yann Chevaleyre

Joint work of Y. Chevaleyre, A. Damamme, A. Beynier, N. Maudet

In the simple resource allocation setting consisting in assigning exactly one resource per agent, the top trading cycle procedure stands out as being the undisputed method of choice. It remains however a centralized procedure which may not well suited in the context of multiagent systems, where distributed coordination may be problematic. In this paper, we investigate the power of dynamics based on rational bilateral deals (swaps) in such settings. While they may induce a high efficiency loss, we provide several new elements that temper this fact: (i) we identify a natural domain where convergence to a Pareto-optimal allocation can be guaranteed, (ii) we show that the worst-case loss of welfare is as good as it can be under the assumption of individual rationality, (iii) we provide a number of experimental results, showing that such dynamics often provide good outcomes, especially in light of their simplicity, and (iv) we prove the NP-hardness of deciding whether an allocation maximizing utilitarian or egalitarian welfare is reachable.

3.6 Dividing homogeneous divisible goods among three players

Marco Dall’Aglia (LUISS Guido Carli – Rome, IT)

License  Creative Commons BY 3.0 Unported license
© Marco Dall’Aglia

Joint work of Marco Dall’Aglia, Camilla Di Luca, Lucia Milone

Main reference M. Dall’Aglia, C. Di Luca, L. Milone, “Characterizing and Finding the Pareto Optimal Equitable Allocation of Homogeneous Divisible Goods Among Three Players,” arXiv:1606.01028v1 [math.OA], 2016.

URL <http://arxiv.org/abs/1606.01028v1>

We consider the division of a finite number of homogeneous divisible items among three players. Under the assumption that each player assigns a positive value to every item, we characterize the optimal allocations and we develop two exact algorithms for its search. Both the characterization and the algorithm are based on the tight relationship two geometric objects of fair division: the Individual Pieces Set (IPS) and the Radon-Nykodim Set (RNS).

3.7 Price of Pareto Optimality in Hedonic Games

Edith Elkind (University of Oxford, GB)

License  Creative Commons BY 3.0 Unported license
© Edith Elkind

Joint work of Edith Elkind, Angelo Fanelli, Michele Flammini

Price of Anarchy measures the welfare loss caused by selfish behavior: it is defined as the ratio of the social welfare in a socially optimal outcome and in a worst Nash equilibrium. A similar measure can be derived for other classes of stable outcomes. In this paper, we argue that Pareto optimality can be seen as a notion of stability, and introduce the concept of Price of Pareto Optimality: this is an analogue of the Price of Anarchy, where the maximum is computed over the class of Pareto optimal outcomes, i.e., outcomes that do not permit a

deviation by the grand coalition that makes all players weakly better off and some players strictly better off. As a case study, we focus on hedonic games, and provide lower and upper bounds of the Price of Pareto Optimality in three classes of hedonic games: additively separable hedonic games, fractional hedonic games, and modified fractional hedonic games; for fractional hedonic games on trees our bounds are tight.

3.8 Approximating the Nash Social Welfare

Vasilis Gkatzelis (Stanford University, US), Simina Brânzei, Richard Cole, Gagan Goel, and Ruta Mehta

License  Creative Commons BY 3.0 Unported license
© Vasilis Gkatzelis, Simina Brânzei, Richard Cole, Gagan Goel, and Ruta Mehta

We study the problem of allocating a collection of items among a set of agents with the goal of maximizing the geometric mean of their utilities, i.e., the Nash social welfare. We consider both the computational tractability of this problem as well as the issues that arise when the participating agents behave strategically, aiming to maximize their own utility.

When the items are divisible, the problem of maximizing the Nash social welfare is known to be computationally tractable, so we focus on the strategic interactions among the agents that arise when their preferences are private. We first analyze the efficiency of simple mechanisms in terms of their price of anarchy using the Nash social welfare measure. That is, we study the ratio of the optimal Nash social welfare for a given instance and the Nash social welfare at the worst Nash equilibrium, and we prove upper and lower bounds for this ratio [3]. Furthermore, we design novel mechanisms that achieve strategy-proofness by keeping some of the items unallocated. We show that these mechanisms combine strategy-proofness with a good approximation of the optimal Nash social welfare [2].

When the items are indivisible, the problem of maximizing the Nash social welfare becomes APX-hard, even when the valuations of the agents are additive. Our main result is the first efficient constant-factor approximation algorithm for this objective. We first observe that the integrality gap of the natural fractional relaxation is exponential, so we propose a different fractional allocation which implies a tighter upper bound and, after appropriate rounding, yields a good integral allocation [1].

References

- 1 Richard Cole and Vasilis Gkatzelis, Approximating the Nash Social Welfare with Indivisible Items. Proceedings of the Forty-Seventh Annual ACM on Symposium on Theory of Computing, STOC 2015, Portland, OR, USA, June 14-17, 2015
- 2 Richard Cole and Vasilis Gkatzelis and Gagan Goel, Mechanism design for fair division: allocating divisible items without payments. ACM Conference on Electronic Commerce, EC'13, Philadelphia, PA, USA, June 16-20, 2013
- 3 Simina Brânzei and Vasilis Gkatzelis and Ruta Mehta, Nash Social Welfare Approximation for Strategic Agents. arxiv (<http://arxiv.org/abs/1607.01569>) 2016

3.9 Matroids and Allocation of Indivisible Goods

Laurent Gourves (University Paris-Dauphine, FR)

License © Creative Commons BY 3.0 Unported license
© Laurent Gourves

Joint work of Laurent Gourves, Carlos A. Martinhon, Jerome Monnot, Lydia Tlilane

We propose an extension of the allocation of indivisible goods to matroids in the sense that the agents get elements that form a base of a matroid. We present some exchange properties that can be used for a matroid extension to MMS and the Cut and Choose protocol, together with an expansion of a matroid that helps to maximize the utilitarian social welfare, with upper bounds on the number of elements that each agent receives.

3.10 The redesign of the Israeli medical internship lottery

Avinatan Hassidim (Bar-Ilan University – Ramat Gan, IL)

License © Creative Commons BY 3.0 Unported license
© Avinatan Hassidim

Joint work of Arnon Afek, Noga Alon, Slava Bronfmann, Avinatan Hassidim, Assaf Romm

Acquiring an Israeli m.d. requires performing an internship in one of the hospitals in Israel. In the past, interns were assigned using a variant of Random Serial Dictatorship. We redesigned the market to use a proprietary algorithm achievement a benefit in satisfaction.

3.11 Procedural Justice in Simple Bargaining Games

Dorothea Herreiner (Loyola Marymount University, US)

License © Creative Commons BY 3.0 Unported license
© Dorothea Herreiner

Giving an affected person some control in a decision-making process generally increases the satisfaction with the outcome because participation contributes to procedural justice. Empowering a receiver in a simple bargaining game by providing the option to reject a proposal (ultimatum game) instead of imposing a proposal (dictator game) leads to more equitable outcomes as Shor (2007) shows. Whether empowerment itself matters, i.e. the fact that the receiver can influence outcomes, or the implicit recognition by the proposer that the receiver is disadvantaged, i.e. the intention behind the empowerment, remains an open questions addressed in this experimental study. Several variants of Shor’s empowerment game (choice between ultimatum and dictator game) are considered where the choice to empower the receiver is made by the proposer, randomly, or a third party. Significant differences emerge between proposals depending on the empowerment of the receiver and in the frequency with which the receiver is empowered; the intentionality behind the empowerment decisions, however, does not seem to make a significant difference.

3.12 Inheritance Game

Mehmet Ismail (Maastricht University, NL)

License  Creative Commons BY 3.0 Unported license
© Mehmet Ismail

A couple delegates a person, D, to divide a cake (their inheritance) of unit length among their children, players A and B. Players are in separate rooms and each have half of the cake on the table in front of them. Each chooses (e.g., by cutting) a piece from the cake, $[0, 1/2]$. The rules are as follows:

1. If some of the players disagree with the rules, nobody will receive anything. The choice 0 expresses disagreement.
2. Otherwise, players receive their own piece. And, if there is some piece left from either player, D will pay each an extra 1 unit of money (as he'd like to taste the cake and convince them to agree with this rule).

The unique Nash equilibrium is $(0, 0)$, which resembles a Bertrand duopoly outcome since 0 is weakly dominated by any strategy. Unlike in the duopoly game, however, all strategies but $1/2$ are dominated. Thus, the only undominated strategy profile is $(1/2, 1/2)$, which is also the unique maximin equilibrium [1]. Each has a profitable deviation from this profile, but the deviator would receive a smaller piece than the non-deviator, which gives incentives to free ride on the deviators: a social dilemma situation.

References

- 1 Mehmet Ismail. *Maximin Equilibrium: A Minimal Extension of Maximin Strategies*. 2014.

3.13 Making the Rules of Sports Fairer

Mehmet Ismail (Maastricht University, NL) and Steven J. Brams

License  Creative Commons BY 3.0 Unported license
© Mehmet Ismail and Steven J. Brams

Main reference S. J. Brams, M. S. Ismail, "Making the Rules of Sports Fairer," SSRN, 2016.

URL <http://dx.doi.org/10.2139/ssrn.2737672>

In the beginning of my presentation, I ran a mini tournament on Catch-Up [1], which is a two-person game in which players alternate removing numbers from an initial set $\{1, 2, \dots, n\}$. Players begin with scores of 0, and the acting player removes numbers (which are added to his score), one by one, until his score *equals* or *exceeds* the opponent's score. If the scores are tied, the game is drawn; otherwise, the player with the higher score wins.

I then presented "Making the Rules of Sports Fairer," which is a joint work with Steven J. Brams. In this paper, we argue that the rules of many sports are not fair – they do not ensure that equally skilled competitors have the same probability of winning. As an example, the penalty shootout in soccer, wherein a coin toss determines which team kicks first on all five penalty kicks, gives a substantial advantage to the first-kicking team, both in theory and practice. We show that a so-called Catch-Up Rule for determining the order of kicking would not only make the shootout fairer but also is essentially strategy proof. By contrast, the so-called Standard Rule now used for the tiebreaker in tennis is fair. We briefly consider several other sports, all of which involve scoring a sufficient number of points to win, and show how they could benefit from certain rule changes, which would be straightforward to implement.

References

- 1 Aaron Isaksen, Mehmet Ismail, Steven J. Brams, Andy Nealen. *Catch-Up: A Game in Which the Lead Alternates*. *Game & Puzzle Design* 1, no. 2:38–49. 2015.

3.14 Open Problems: Rules That Make Service Sports More Competitive

Mehmet Ismail (Maastricht University, NL), Steven J. Brams, D. Marc Kilgour, and Walter Stromquist (Swarthmore College, US)

License © Creative Commons BY 3.0 Unported license
© Mehmet Ismail, Steven J. Brams, D. Marc Kilgour, and Walter Stromquist

The Standard Rule – presently used in badminton, racquetball, squash, and volleyball – says that the player who *won* the last point serves for the next point, whereas the so-called Catch-Up Rule says that the player who *lost* the last point serves for the next.

The open problem was that the probability of the first-serving player winning is the same under both Standard Rule and Catch-Up Rule, which was solved by Walter Stromquist, one of the participants at Dagstuhl Seminar.

3.15 Direct algorithms for balanced two-person fair division of indivisible items: A computational study

Marc Kilgour (Wilfrid Laurier University, CA) and Rudolf Vetschera

License © Creative Commons BY 3.0 Unported license
© Marc Kilgour and Rudolf Vetschera

Direct algorithms for the balanced fair division of indivisible items between two persons are assessed computationally. Several algorithms are applied to all possible fair-division problems with 4, 6, 8, and 10 items to determine how well the algorithms do at achieving various fairness properties such as envy-freeness, Pareto-optimality, and maximality.

3.16 Maximin Envy-Free Division of Indivisible Items

Christian Klamler (Universität Graz, AT), Steven J. Brams, and Marc Kilgour (Wilfrid Laurier University, CA)

License © Creative Commons BY 3.0 Unported license
© Christian Klamler, Steven J. Brams, and Marc Kilgour

Assume that two players have strict rankings over an even number of indivisible items. We propose two algorithms to find balanced allocations of these items that are maximin – maximize the minimum rank of the items that the players receive – and are envy-free and Pareto-optimal if such allocations exist. To determine whether an envy-free allocation exists, we introduce a simple condition on preference profiles; in fact, our condition guarantees the existence of a maximin, envy-free, and Pareto-optimal allocation. Although not strategy-proof, our algorithms would be difficult to manipulate unless a player has complete information about its opponent’s ranking. We assess the applicability of the algorithms to real-world problems, such as allocating marital property in a divorce or assigning people to committees or projects.

3.17 What is the highest guaranteed maximin approximation?

David Kurokawa (Carnegie Mellon University – Pittsburgh, US)

License  Creative Commons BY 3.0 Unported license
© David Kurokawa

Joint work of David Kurokawa, Ariel D. Procaccia, Junxing Wang

The maximin share guarantee is one of the few well-established notions of fairness in the setting of fairly dividing indivisible goods. Although believed to always exist, [Procaccia and Wang, Fair Enough: Guaranteeing Approximate Maximin Shares, EC 2014] showed that in very intricately constructed examples, the property is not guaranteeable – but were only able to demonstrate the absence in examples with high approximations to the maximin share guarantee. In the same work, they showed that a $2/3$ approximation does always exist. This leads to a natural question of what is the highest guaranteed maximin approximation? We explore previous techniques of approximation and examine where they break down to improve the bound and also touch upon finding examples with worse guarantees.

3.18 Fair Division under Additive Utilities: good and bad news

Hervé J. Moulin (University of Glasgow, GB)

License  Creative Commons BY 3.0 Unported license
© Hervé J. Moulin

Joint work of Anna Bogomolnaia, Herve Moulin

Modern economic analysis mostly dismisses additive utilities that ignore complementarities between commodities. But recent work on the practical implementation of fair division rules in user-friendly websites (Spliddit, Adjusted Winner) gives a central role to this simple preference domain for compelling practical reasons, and brings back into sharp focus the 1959 results of Eisenberg and Gale on linear economies. Think of distributing the family heirlooms between siblings, splitting the assets of a divorcing couple, or allocating job shifts between substitutable workers: most people cannot form sophisticated preferences described by general utility functions, just like participants in a combinatorial auction do not form a complete ranking of all subsets of objects. Thus individual preferences are elicited by a simple bidding system: you distribute 100 points over the different goods, and these weights define your additive utility. The proof of the pudding is in the eating: thousands of visitors use these sites every month, fully aware that their bid is interpreted as their additive utility. Fairness as equal opportunities is achieved by the familiar Competitive Equilibrium with Equal Incomes. When dividing goods this rule is normatively compelling. Because it also maximizes the Nash product of utilities, it is unique utility-wise, continuous in the utility matrix, and easy to compute. It also guarantees that more manna to divide is never bad news for any participant (Resource Monotonicity), that by raising my bid on a certain good I cannot end up with a smaller share of that good (Responsive Shares), and that the size of my bids for the goods I do not eat is irrelevant (Independence of Lost Bids). The latter property is characteristic. When dividing bads, the Competitive Equilibria with Equal Incomes captures all the critical points of the Nash product of utilities, and is still characterized by Invariance of Lost Bids. It can be severely multi-valued: up to $2^{\min\{n,p\}} - 1$ distinct utility profiles with n agents and p goods. Moreover any single-valued efficient division rule attempting to implement equal opportunities faces two severe impossibility results: no such rule can be resource monotonic and guarantee the fair share; no such rule can be Envy-Free and continuous in the utility parameters. The fair division of bads is not a piece of cake.

3.19 Strategy-Proofness of Scoring Allocation Correspondences for Indivisible Goods

Nhan-Tam Nguyen (Heinrich-Heine-Universität Düsseldorf, DE)

License © Creative Commons BY 3.0 Unported license
© Nhan-Tam Nguyen

Joint work of Nhan-Tam Nguyen, Dorothea Baumeister, Joerg Rothe
Main reference N. Nguyen, D. Baumeister, J. Rothe, “Strategy-Proofness of Scoring Allocation Correspondences for Indivisible Goods”, in Proc. of the 24th Int’l Joint Conf. on Artificial Intelligence (IJCAI’15), pp. 1127–1133, AAAI Press, 2015.
URL <http://ijcai.org/Abstract/15/163>

We study resource allocation in a model due to Brams and King [1] and further developed by Baumeister et al. [2]. Resource allocation deals with the distribution of resources to agents. We assume resources to be indivisible, nonshareable, and of single-unit type. Agents have ordinal preferences over single resources. Using scoring vectors, every ordinal preference induces a utility function. These utility functions are used in conjunction with utilitarian social welfare to assess the quality of allocations of resources to agents. Then allocation correspondences determine the optimal allocations that maximize utilitarian social welfare.

Since agents may have an incentive to misreport their true preferences, the question of strategy-proofness is important to resource allocation. We assume that a manipulator has responsive preferences over the power set of the resources. We use extension principles (from social choice theory, such as the Kelly and the Gardenfors extension) for preferences to study manipulation of allocation correspondences. We characterize strategy-proofness of the utilitarian allocation correspondence: It is Gardenfors/Kelly-strategy-proof if and only if the number of different values in the scoring vector is at most two or the number of occurrences of the greatest value in the scoring vector is larger than half the number of goods.

References

- 1 Brams S, King D (2005) Efficient fair division: Help the worst off or avoid envy? *Rationality and Society* 17(4):387–421
- 2 Baumeister D, Bouveret S, Lang J, Nguyen N, Nguyen T, Rothe J (2014) Scoring rules for the allocation of indivisible goods. In: *Proceedings of the 21st European Conference on Artificial Intelligence*, IOS Press, pp. 75–80

3.20 The Single-Peaked Domain Revisited: A Simple Global Characterization

Clemens Puppe (KIT – Karlsruher Institut für Technologie, DE)

License © Creative Commons BY 3.0 Unported license
© Clemens Puppe

Main reference C. Puppe, “The Single-Peaked Domain Revisited: A Simple Global Characterization,” Manuscript, March 2016.
URL <http://micro.econ.kit.edu/downloads/Charact-SP.pdf>

It is proved that, among all restricted preference domains that guarantee consistency (i.e. transitivity) of pairwise majority voting, the single-peaked domain is the only minimally rich and connected domain that contains two completely reversed strict preference orders. It is argued that this result explains the predominant role of single-peakedness as a domain restriction in models of political economy and elsewhere. The main result has a number of corollaries, among them a dual characterization of the single- dipped domain; it also

implies that a single-crossing (‘order-restricted’) domain can be minimally rich only if it is a subdomain of a single-peaked domain. The conclusions are robust as the results apply both to domains of strict and of weak preference orders, respectively.

3.21 Preferences over Allocation Mechanisms and Recursive Utility

Uzi Segal (Boston College, US) and David Dillenberger

License © Creative Commons BY 3.0 Unported license
© Uzi Segal and David Dillenberger

We deal with a simple problem: There are n units of two types that need to be allocated among n people, one per person. Preferences are stochastic. Each person prefers good 1 with probability q and good 2 with probability $1 - q$. These probabilities are independent across individuals. We analyze several allocation mechanisms with different levels of knowledge and show that:

1. Mechanisms may be identical from an ex-post point of view, but not ex-ante, as individuals are not indifferent between them.
2. Preferences over some well known mechanisms are linked to different forms of rejection and acceptance of ambiguity.
3. Both the well known top-cycle and serial-dictatorship mechanisms are inefficient.

3.22 Fair Division of Land

Erel Segal-Halevi (Bar-Ilan University – Ramat Gan, IL)

License © Creative Commons BY 3.0 Unported license
© Erel Segal-Halevi
Joint work of Yonatan Aumann, Avinatan Hassidim, Shmuel Nitzan, Erel Segal-Halevi, Balazs Sziklai
URL <http://erelsgl.github.io/topics/en/fairness/>

The talk is a short summary of my Ph.D. research (2013–2016). The goal of this research is to apply cake-cutting algorithms for dividing land. I present several issues that have to be addressed.

1. Geometry: When dividing land, in contrast to cake, the two-dimensional geometric shape of the pieces is important.
2. Redivision: Dividing land, in contrast to cake, is an on-going process. Land often has to be re-divided. The re-division process should be fair both for the old and for the new agents.
3. Group ownership: The ownership of land, in contrast to cake, is often shared among several individuals, such as family members. Each of these members may have different preferences.
4. Land-value data: For land, in contrast to cake, there exist detailed value maps, which can be used to test the performance of cake-cutting algorithms.

3.23 Fairness and False-Name-Proofness in Randomized Allocation of a Divisible Good

Taiki Todo (Kyushu University – Fukuoka, JP), Yuko Sakurai, and Makoto Yokoo

License  Creative Commons BY 3.0 Unported license
© Taiki Todo, Yuko Sakurai, and Makoto Yokoo

Cake cutting has been recognized as a fundamental model for allocating a divisible good in a fair manner, and several envy-free cake cutting algorithms have been proposed. Recent works reconsidered cake cutting from the perspective of mechanism design and developed strategy-proof cake cutting mechanisms; no agent has any incentive to cheat them by misrepresenting her utility function. In this talk I consider a different type of manipulations; each agent might create fake identities to cheat the mechanism. Such manipulations have been called Sybils or false-name manipulations, and designing robust mechanisms against them, i.e., false-name-proof, is a challenging problem. I first present an impossibility result, which states that no false-name-proof mechanism simultaneously satisfies envy-freeness and Pareto efficiency. I then present a new mechanism that is optimal in terms of worst-case loss among those that satisfy false-name-proofness, strong envy-freeness, and a weaker efficiency property. To improve the efficiency, I also provide another mechanism that satisfies a weaker notion of false-name-proofness, as well as strong envy-freeness and Pareto efficiency. Furthermore, I give a short discussion on the effect of introducing agents' costs for managing fake accounts.

3.24 Deceased Organ Matching in Australia and New Zealand.

Toby Walsh (UNSW – Sydney, AU)

License  Creative Commons BY 3.0 Unported license
© Toby Walsh

I discuss how we might match deceased organs to patients more effectively. One of the primary goals is to match the quality of the deceased organ and the patient due to the increasing age of donated kidneys. I formulate this as an online problem, discuss axiomatic properties and propose some novel mechanisms.

Participants

- Yonatan Aumann
Bar-Ilan University –
Ramat Gan, IL
- Haris Aziz
Data61 / NICTA – Sydney, AU
- Sylvain Bouveret
LIG - Grenoble, FR & Université
Grenoble-Alpes, FR
- Simina Brânzei
The Hebrew University of
Jerusalem, IL
- Katarina Cechlarova
Pavol Jozef Safarik University –
Kosice, SK
- Yann Chevaleyre
University of Paris North, FR
- Marco Dall'Aglio
LUISS Guido Carli – Rome, IT
- Edith Elkind
University of Oxford, GB
- Ulle Endriss
University of Amsterdam, NL
- Serge Gaspers
UNSW – Sydney, AU
- Vasilis Gkatzelis
Stanford University, US
- Laurent Gourves
University Paris-Dauphine, FR
- Avinatan Hassidim
Bar-Ilan University – Ramat
Gan, IL
- Dorothea Herreiner
Loyola Marymount Univ., US
- Mehmet Ismail
Maastricht University, NL
- Michael A. Jones
Mathematical Reviews – Ann
Arbor, US
- Marc Kilgour
Wilfrid Laurier University, CA
- Christian Klamler
Universität Graz, AT
- David Kurokawa
Carnegie Mellon University &
Pittsburgh, US
- Jérôme Lang
University Paris-Dauphine, FR
- Simon William Mackenzie
UNSW – Sydney, AU
- Hervé J. Moulin
University of Glasgow, GB
- Nhan-Tam Nguyen
Heinrich-Heine-Universität
Düsseldorf, DE
- Trung Thanh Nguyen
New York University –
Abu Dhabi, AE
- Ariel D. Procaccia
Carnegie Mellon University –
Pittsburgh, US
- Clemens Puppe
KIT – Karlsruher Institut für
Technologie, DE
- Jörg Rothe
Heinrich-Heine-Universität
Düsseldorf, DE
- Uzi Segal
Boston College, US
- Erel Segal-Halevi
Bar-Ilan University –
Ramat Gan, IL
- Walter Stromquist
Swarthmore College, US
- Taiki Todo
Kyushu Univ. – Fukuoka, JP
- Toby Walsh
UNSW – Sydney, AU



Characterizing and Finding the Pareto Optimal Equitable Allocation of Homogeneous Divisible Goods Among Three Players

Marco Dall'Aglio, Camilla Di Luca, Lucia Milone
LUISS University
Rome, Italy

mdallaglio@luiss.it , cdiluca@luiss.it, lmilone@luiss.it

May 30, 2016

Abstract

We consider the division of a finite number of homogeneous divisible items among three players. Under the assumption that each player assigns a positive value to every item, we characterize the optimal allocations and we develop two exact algorithms for its search. Both the characterization and the algorithm are based on the tight relationship two geometric objects of fair division: the Individual Pieces Set (IPS) and the Radon-Nykodim Set (RNS).

1 The Problem

This paper investigates the optimal allocation problem for a finite number m of divisible and homogeneous objects, with $M = \{1, 2, \dots, m\}$, $m \in \mathbb{N}$, divided among three players. Players will be usually denoted as $N = \{1, 2, 3\}$, but roman numbers *I*, *II* and *III* will be employed in the pictures.

We write the matrix of evaluation as $(a_{ij})_{i \in N; j \in M}$, where each entry a_{ij} tells us the value that player $i \in N$ assigns to item $j \in M$. We assume that utilities are

normalized $\sum_{j \in M} a_{ij} = 1, \forall i \in N$

i.e., utilities attached to the q goods sum up to 1 for each player; and

linear if player i gets share $t_j \in [0, 1]$ of item j and share $t_k \in [0, 1]$ of item k , she gets a total utility of $t_j a_{ij} + t_k a_{ik}$.

Let $\mathbf{X} = \{x_{ij}\}_{i \in N; j \in M}$, $x_{ij} \geq 0, \forall i \in N, j \in M$ be an allocation matrix, with $\sum_{i \in N} x_{ij} = 1, \forall j \in M$ and $\mathbf{X} \in \mathcal{X}$, where \mathcal{X} is the set of all possible allocation matrices. Let us label with $\hat{\mathbf{X}}$ any integer allocations where $x_{ij} \in \{0, 1\}, \forall i \in N, j \in M$, and with $\hat{\mathcal{X}}$ the set of such allocations. Any integer allocation can be equivalently described by a vector $\mathbf{x} = (x_j)_{j \in M}$ such that each component

$x_j = I, II$ or III depending on whether $x_{1j} = 1$, $x_{2j} = 1$ or $x_{3j} = 1$. Define now, for any $\mathbf{X} \in \mathcal{X}$,

$$a(\mathbf{X}) = \left(\sum_{j \in M} a_{ij} x_{ij} \right)_{i \in N}.$$

It is a vector in which each entry tells us, for any player, the total value that she derives from the given allocation \mathbf{X} .

We are going to search for an allocation \mathbf{X}^* which simultaneously satisfies

(Strong) Pareto Optimality (PO) There is no other allocation $\mathbf{X}' \in \mathcal{X}$ such that [

$$a_i(\mathbf{X}') \geq a_i(\mathbf{X}^*) \quad i \in N$$

with strict inequality for at least one player.

Equitability (EQ) $a_1(\mathbf{X}^*) = a_2(\mathbf{X}^*) = a_3(\mathbf{X}^*)$

The proposed allocation coincides with the Kalai-Smorodinsky solution (see [10] and [9]) for bargaining problems.

A well-known procedure for two players is the Adjusted Winner (AW) (see [4] and [5]). This procedure returns allocations that are not only PO-EQ but also envy-free.

Throughout the rest of the work we are going to consider the following simplifying assumption:

Mutual absolute continuity (MAC). Each player assigns a positive value to any item

$$a_{ij} > 0 \quad \text{for any } i \in N \text{ and } j \in M$$

When MAC holds a PO-EQ allocation always exists, and it coincides with the maxmin allocation defined by

$$\mathbf{X}^* \in \operatorname{argmax}_{\mathbf{X} \in \mathcal{X}} \left\{ \min_{i \in N} a_i(\mathbf{X}) \right\}$$

2 Geometrical Framework

We are now going to review two geometric structures that are useful for the analysis of PO and PO-EQ allocations. First of all we characterize the PO allocations.

Theorem 1. (Theorem 1, [3], Proposition 4.3 [6]) Under MAC, an allocation is PO iff, for some $\gamma = (\gamma_1, \gamma_2, \gamma_3) \in \overset{\circ}{\Delta}_2$ the following holds:

$$x_{ik} > 0 \quad \text{if } \gamma_i a_{ik} \geq \gamma_j a_{jk} \text{ for any } i, j \in N, \quad k \in M. \quad (1)$$

We denote with $\mathbf{X}^\gamma = \{x_{ik}^\gamma\}$ any allocation satisfying (1)

2.1 The Partition Range

We consider the Individual Pieces Set $IPS \subset \mathbb{R}^3$ (see [2]), also known as Partition Range, defined as follows

$$IPS = \{a(\mathbf{X}) : \mathbf{X} \in \mathcal{X}\}.$$

Proposition 1. $IPS = \text{conv} \left(a(\hat{\mathbf{X}}) : \hat{\mathbf{X}} \in \hat{\mathcal{X}} \right)$.

Proof. First of all we show that all the extreme points of IPS , i.e. all points in IPS which are not interior points of any segment lying in IPS , correspond to integer allocations of the goods.

Argue by contradiction, and suppose that an extreme point of IPS corresponds only to noninteger allocations of goods. Let $\mathbf{X}_n = \{x_{ij}^n\}$ be any such allocation. Since \mathbf{X}_n is non-integer, there must exist a good $j_0 \in M$ and two players $i_1, i_2 \in N$ such that, for some $\delta > 0$

$$\delta < x_{i_1, j_0}, x_{i_2, j_0} < 1 - \delta$$

The following must also hold:

$$a_{i, j_0} \neq 0 \text{ for at least an } i \in \{i_1, i_2\} \quad (2)$$

In fact, assuming $a_{i_1, j_0} = a_{i_2, j_0} = 0$ we can replace \mathbf{X}_n with another allocation \mathbf{X}_t which is integer in the good j_0 and such that $a(\mathbf{X}_n) = a(\mathbf{X}_t)$. The argument can be replicated to other goods to conclude that (2) holds. Without loss of generality, we assume $a_{i_1, j_0} \neq 0$ and consider two other allocations.

$$\mathbf{X}_+ = \begin{cases} x_{ij}^n & j \neq j_0 \text{ or } (j = j_0 \text{ and } i \neq i_1, i_2) \\ x_{ij}^n + \delta & j = j_0 \text{ and } i = i_1 \\ x_{ij}^n - \delta & j = j_0 \text{ and } i = i_2 \end{cases}$$

$$\mathbf{X}_- = \begin{cases} x_{ij}^n & j \neq j_0 \text{ or } (j = j_0 \text{ and } i \neq i_1, i_2) \\ x_{ij}^n - \delta & j = j_0 \text{ and } i = i_1 \\ x_{ij}^n + \delta & j = j_0 \text{ and } i = i_2 \end{cases}$$

Now $a_{i_1}(\mathbf{X}_+) - a_{i_1}(\mathbf{X}_-) = 2\delta a_{i_1, j_0} \neq 0$. Therefore $a(\mathbf{X}_+) \neq a(\mathbf{X}_-)$ and $a(\mathbf{X}_n)$ is the midpoint of the segment $[a(\mathbf{X}_+), a(\mathbf{X}_-)]$, yielding a contradiction. By Carathéodory's Theorem (see for instance [8]), and the fact that $IPS \subset \mathbb{R}^3$, every point of IPS is the convex combination of at most 4 extreme points of IPS \square

The value of a PO-EQ allocation is the common coordinate of the intersection between the egalitarian ray, i.e. the orthant of the first quadrant in \mathbb{R}^3 , and the upper surface of IPS , denoted as the Pareto Boundary, thereon PB. Proposition 1 shows that PB is composed of faces, denoted Pareto faces (PF). MAC implies that no Pareto face is parallel to any of the coordinate axes.

If we consider the partition range from above, Finding the PO-EQ allocation amounts to finding the face of the PB that contains the egalitarian ray (actually more than one face may be involved if the egalitarian ray "hits" an edge, or coincides with an integer allocation), and then find the allocation of the Pareto face which yields the optimal value (Figure 1(a)).

Consider, for any $x = (x_1, x_2, x_3) \in \mathbb{R}_+^3$, the normalizing operator

$$N(x) = \left(\frac{x_1}{s(x)}, \frac{x_2}{s(x)}, \frac{x_3}{s(x)} \right) \quad \text{with } s(x) = x_1 + x_2 + x_3$$

and define the Normalized Pareto Boundary, thereon NPB, as a Δ_2 simplex such that

$$NPB = \{N(x) : x \in PB\}$$

Then, the Pareto Faces partition the set NPB, and finding the PO-EQ allocation amounts to finding the allocation corresponding to the center $(1/3, 1/3, 1/3)$ on NPB (Figure 1(b)).

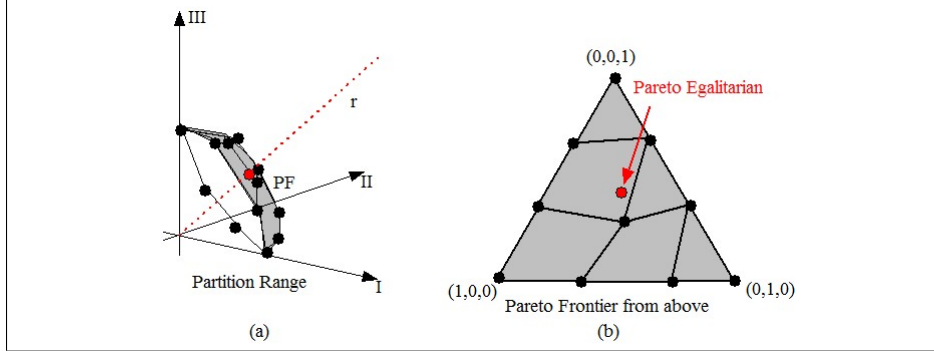

Figure 1: (a) The red dot indicates the value of the PO-EF allocation. (b) The same picture from above

To find the PO-EQ allocations we will employ the following result valid for general fair division problems (any number of players, completely divisible and non-homogeneous goods).

Theorem 2. (Proposition 6.1 in [6]) Consider the following function $g : \Delta_2 \rightarrow [0, 1]$

$$g(\gamma) = \sum_{i \in N} \gamma_i a_i(\mathbf{X}^\gamma) \quad \gamma = (\gamma_1, \gamma_2, \gamma_3) \in \Delta_2$$

with \mathbf{X}^γ PO allocation associated to γ by (1). Then

(i) The hyperplane

$$\mathcal{H}(\gamma) = \left\{ (x_1, x_2, x_3) \in \mathbb{R}^3 : \sum_{i \in N} \gamma_i x_i = g(\gamma) \right\}$$

supports IPS at the point $(a_1(\mathbf{X}^\gamma), a_2(\mathbf{X}^\gamma), a_3(\mathbf{X}^\gamma))$, i.e.

$$(a_1(\mathbf{X}^\gamma), a_2(\mathbf{X}^\gamma), a_3(\mathbf{X}^\gamma)) \in \mathcal{H}(\gamma)$$

$$\text{and} \quad \sum_{i \in N} \gamma_i y_i \leq g(\gamma) \quad \forall (y_1, y_2, y_3) \in \mathcal{P}$$

(ii) The hyperplane \mathcal{H} intersects the egalitarian ray at the point $g(\gamma)(1, 1, 1)$

(iii) The function $g(\cdot)$ is convex, and for any of its minimizing points γ^* the hyperplane $\mathcal{H}(\gamma^*)$ supports IPS at a set of points containing the PO-EQ allocation.

In [6] an algorithm that returns the leximin allocation is described. This can be adapted to return the PO-EQ allocation in the present situation:

1. Find γ^* , an absolute minimum for g
2. Find the Pareto face corresponding to $\mathcal{H}(\gamma^*)$
3. Find the equitable allocation within the Pareto face

In order to fully adapt the algorithm to the present situation, we need to better characterize the Pareto faces.

2.2 The Radon-Nykodim set

Figure 1(b) shows that the PB can be represented as a 2-dimensional simplex. We will now consider another 2-dimensional simplex, due to Weller [11] and extensively investigated by Barbanel [2], that enables us to represent the items, the efficient partitions and the faces of PB into a single geometric figure. Following [2], we refer to the Radon-Nikodyn set, thereon RNS, to define this new simplex.

Each vertex of RNS represents a player. We next plot the single items into RNS by considering the normalized vectors of evaluations of the single items

$$a_j^n = N(a_{.j}) \quad j \in M$$

The normalized coordinates of all objects are plotted on a 2-dimensional simplex where each vertex represents a player. Under MAC, $a_j^n \in \overset{\circ}{\Delta}_2$ for each $j \in M$.

Definition 1. For each point $\beta = (\beta_1, \beta_2, \beta_3) \in RNS$ in the simplex, consider the lines joining β with each vertex; we denote as **disputing segments** the half open segments on those lines from β to the opposite side of each vertex, with β excluded.

Definition 2. For each $\beta \in \overset{\circ}{RNS}$, we derive the following **Pareto Allocation Rule** after β , thereon $PAR(\beta)$, which delivers one or more PO allocations under MAC (see theorem 10.9 in [2]). The disputing segments of β divide the simplex in three parts, each a neighborhood of a vertex. The objects in each neighborhood are assigned to the player associated to the vertex. Denote as \mathbf{X}^β any such allocation. In case the allocation is integer we will use $\hat{\mathbf{X}}^\beta$.

It is important to notice that the allocation rule may not be unique: In case an object lies on one of the disputing segments of β , it can be considered on both sides of the segment, and therefore it can be assigned to any of the corresponding players, or it can be split between the interested players.

Every Pareto allocation lies on the upper border of the convex set IPS , and a hyperplane supports IPS at this point. A more precise account of the relationship between supporting hyperplanes and the Pareto allocation rule is given by the following result.

Theorem 3. (Theorem 2 in [1]) Assume MAC. If, for any $x = (x_1, x_2, x_3) \in \overset{\circ}{\Delta}_2$, we denote

$$RD(x) = N\left(\frac{1}{x_1}, \frac{1}{x_2}, \frac{1}{x_3}\right),$$

then, for any $\gamma \in \overset{\circ}{\Delta}_2$, the allocation \mathbf{X}^γ satisfies $PAR(\beta)$ with $\beta = RD(\gamma)$. Conversely, for any $\beta \in RNS$, the allocation rule $\hat{\mathbf{X}}^\beta$ supports \mathcal{P} through the hyperplane H^γ with $\gamma = RD(\beta)$.

When, given $\beta \in RNS$, one or more objects lie on disputing segments, the associated hyperplane supports all the integer allocations and their convex hulls. This fact plays a crucial role in how the Pareto faces are generated; a detailed explanation will be provided in proof of Theorem 4.

Definition 3. For any item $j \in K$ we denote the segments joining a_j^n to each of the three vertices the supporting segments. Two items, $j, k \in K$ are support independent, or s -independent, if none of a_j^n and a_k^n lie on the supporting segments of the other item.

In Figure 2 we illustrate dividing and supporting segments of one or more items.

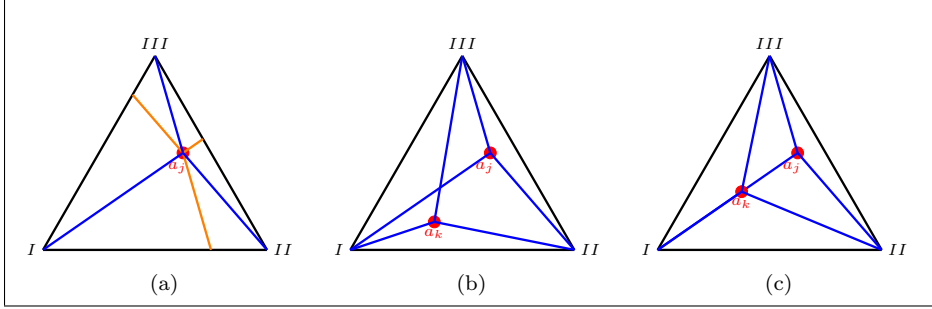

Figure 2: (a) disputing colored by orange and supporting segments colored by blue, (b) two s -independent items, (c) two dependent items.

Proposition 2. The supporting segments of two items intersect exactly once if and only if the two items are s -independent.

Proof. Suppose two items, j, h are s -independent. Then a_j lies in the interior of one of the triangles that the supporting lines of a_h form in the RNS, and does not lie on any of the disputing lines of the same item. The supporting line of a_j with the vertex on the other side of the triangle, will intersect a supporting line of a_h once, and this is the only possible intersection.

Conversely, if two items are s -dependent, a supporting line of one of them will be a subsegment of the supporting line of the other, yielding an infinite number of intersections. \square

3 Pareto faces on the Radon-Nykodim set

The following lemma consider the situation in which there are other items lying on the disputing segments between two players.

Lemma 1. Under MAC, the following statements hold:

- (i) If a disputing segment between players i and j of a point β in RNS contains only one item (namely, k), then the hyperplane with coefficients vector $\alpha = RD(b)$ supports the partition range IPS in a region containing the line segment $[a(\hat{\mathbf{X}}_i^k), a(\hat{\mathbf{X}}_j^k)]$, where $\hat{\mathbf{X}}_i^k$ ($\hat{\mathbf{X}}_j^k$ respectively) denotes the allocation in which all items but k are assigned according to a common PAR compatible with the coefficients and item k is assigned to player i (player j respectively).
- (ii) If a disputing segment between players i and j of a point β in RNS contains more than one item (namely, r items with $r \geq 2$ and $K = \{k_1, \dots, k_r\}$), then the hyperplane i (i) still supports the partition range

IPS in a region containing the line segment $[a(\hat{\mathbf{X}}_i^K), a(\hat{\mathbf{X}}_j^K)]$, where $\hat{\mathbf{X}}_i^K$ ($\hat{\mathbf{X}}_j^K$ respectively) denotes the allocations in which all items but those in K are assigned according to a common Pareto rule compatible with the coefficients, and items in K are all assigned to player i (player j , respectively). Moreover, each point of the line segment $[a(\hat{\mathbf{X}}_i^K), a(\hat{\mathbf{X}}_j^K)]$ is obtained by splitting at most one item in K , while attributing the remaining ones in K either to Player i or to Player j in their own entirety.

Proof. (i) Let $\gamma \in \overset{\circ}{\Delta}_2$ be the coefficients vector of a hyperplane supporting *IPS* and let $\beta = RD(\gamma) \in RNS$. Following $PAR(\beta)$, two optimal integer allocations are generated, which differ only in the allocation of item k : $\hat{\mathbf{X}}_i^k$, in which item k is assigned to player i , and $\hat{\mathbf{X}}_j^k$, in which item k is assigned to player j . So, the hyperplane characterized by γ supports *IPS* in $a(\hat{\mathbf{X}}_i^k)$ and $a(\hat{\mathbf{X}}_j^k)$ and, by Proposition 1, the whole line segment $[a(\hat{\mathbf{X}}_i^k), a(\hat{\mathbf{X}}_j^k)]$.

(ii) Following the same line of reasoning adopted in (i), the evaluations vectors $a(\hat{\mathbf{X}}_i^K)$ and $a(\hat{\mathbf{X}}_j^K)$ belong to the region where *IPS* supports the given hyperplane, together with the line segment $[a(\hat{\mathbf{X}}_i^K), a(\hat{\mathbf{X}}_j^K)]$

We recall that goods $\ell \in K$ are characterized by the following relationship

$$\gamma_i a_{i\ell} = \gamma_j a_{j\ell} > \gamma_h a_{h\ell} \quad \ell \in K .$$

Therefore, letting $T_i = \sum_{\ell \in K} a_{i\ell}$ and $T_j = \sum_{\ell \in K} a_{j\ell}$, we have

$$T_j = \frac{\gamma_i T_i}{\gamma_j} .$$

Moreover,

$$a(\hat{\mathbf{X}}_i^K) = \mathbf{c} + \mathbf{d}_i \quad a(\hat{\mathbf{X}}_j^K) = \mathbf{c} + \mathbf{d}_j$$

where \mathbf{c} is the evaluation vector where all the goods but those in K are assigned according to a compatible common Pareto rule, $\mathbf{d}_i = (T_i, 0, 0)$ and $\mathbf{d}_j = (0, T_j, 0)$, where, for simplicity, we assume that player i (player j , resp.) occupies the first (second, resp.) coordinate.

Consider now an intermediate situation where a subset of goods $H \subset K$ are assigned to player i and the remaining ones in K are given to j . Denoting with $\hat{\mathbf{X}}_H$ the corresponding allocation, we have

$$a(\hat{\mathbf{X}}_H) = \mathbf{c} + \mathbf{d}_H$$

with

$$\mathbf{d}_H = \left(\sum_{\ell \in H} a_{i\ell}, T_j - \sum_{\ell \in H} a_{j\ell}, 0 \right) = \left(\sum_{\ell \in H} a_{i\ell}, \frac{\gamma_i}{\gamma_j} (T_i - \sum_{\ell \in H} a_{i\ell}), 0 \right) = \frac{\sum_{\ell \in H} a_{i\ell}}{T_i} \mathbf{d}_i + \left(\frac{T_i - \sum_{\ell \in H} a_{i\ell}}{T_i} \right) \mathbf{d}_j .$$

Letting $t = \frac{\sum_{\ell \in H} a_{i\ell}}{T_i}$ we therefore have

$$a(\mathbf{x}_H) = ta(\mathbf{x}_i^K) + (1-t)a(\mathbf{x}_j^K)$$

and $a(\mathbf{x}_H) \in [a(\mathbf{x}_i^K), a(\mathbf{x}_j^K)]$.

To prove the last statement, consider the collection $H_p = \{k_1, \dots, k_p\}$, $p \leq r$ and $H_0 = \emptyset$. Clearly $a(\hat{\mathbf{X}}_{H_p})$, $p = 0, 1, \dots, r$ spans the line segment $[a(\hat{\mathbf{X}}_i^K), a(\hat{\mathbf{X}}_j^K)]$, with $a(\hat{\mathbf{X}}_{H_0}) = a(\hat{\mathbf{X}}_j^K)$ and $a(\hat{\mathbf{X}}_{H_r}) = a(\hat{\mathbf{X}}_i^K)$. Consequently, each point of the line segment is included between $a(\hat{\mathbf{X}}_{H_{p-1}})$ and $a(\hat{\mathbf{X}}_{H_p})$ for some $p \leq r$. Thus, if the inclusion is strict, item p is split between Players i and j , while the remaining ones in K are attributed in their entirety to one player or the other. \square

3.1 A classification of the Pareto faces

Faces on the Pareto surface are obtained when a given hyperplane is compatible with three or more different integer allocations of the goods. Under MAC, this can take place only when the items are located on the disputing segments of a given hyperplane and/or coincide with the hyperplane itself, according to specific patterns listed below.

[f1] **Faces corresponding to any $\beta \in R\overset{\circ}{N}S$ coinciding with an item a_j^n , $j \in K$, and no other goods on the disputing segments.** In such case item j can be assigned to any of the three players, while the other items are univocally assigned according to the Pareto rule. The face is a triangle, each vertex corresponding to a different assignment of item j .

[f2] **Faces corresponding to any $\beta \in R\overset{\circ}{N}S$ lying at the intersection of the supporting segments of two s-independent items a_j^n, a_k^n with $j, k \in K$, and no other goods in that intersection.** In this case each of the items j and k can be shared between two players (with only one player participating in the dispute of both items). The face is a parallelogram with each vertex corresponding to a different allocation of the pair of contested goods.

[f3] **Faces corresponding to any $\beta \in R\overset{\circ}{N}S$ lying at the intersection of the supporting segments of three s-independent items a_j^n, a_k^n, a_l^n , with $j, k, l \in K$, and no other goods in that intersection.** In such case, each of the items j , k and l can be shared between two players (with each player participating in two disputes out of the three). The corresponding face on the Pareto surface is a hexagon with opposite sides parallel and of equal length. Therefore 6 out of the 8 points are vertices of the hexagon, while the remaining two points lie in the interior of the face.

[f4] **Faces corresponding to any $\beta \in R\overset{\circ}{N}S$ coinciding with any item a_j^n , $j \in K$, and a second item a_k^n , $k \in K$ that lies on a disputing segment.** The six different allocations produce a trapezoid, with the two extra points lying on its larger base.

[f5] **Faces corresponding to any $\beta \in \overset{\circ}{RNS}$ lying at the intersection of the supporting segments of two s-independent items a_j^n, a_k^n with $j, k \in K$, and an additional item $a_h^n, h \in K$ located in the same position as the hyperplane.** The 12 different allocations produce a face with 5 vertices and with two pairs of parallel edges with unequal length. The largest edge of each pair contains two additional points, while the remaining three points are in the interior of the face.

[f6] **Faces corresponding to any $\beta \in \overset{\circ}{RNS}$ lying at the intersection of the supporting segments of three s-independent items a_j^n, a_k^n, a_ℓ^n , with $j, k, \ell \in K$, and an additional item $a_h^n, h \in K$ located in the same position as the hyperplane.** The 24 different distributions produce hexagons with parallel opposite sides of unequal length. The largest edge of each pair contains two additional points, while the remaining 12 points are in the interior of the face.

When several goods lie on a single disputing segment, these can be replaced by a single good obtained by summing up utilities for each player, and the situation can be traced back to one of the cases listed above.

Theorem 4. *Under MAC, each face on the Pareto Frontier is identified by one of the six characterizations listed in the above classification.*

Proof. A face is formed when goods are located on the disputing segments of a hyperplane in a way that three or more different goods' allocations generate unaligned points on the Pareto surface of the partition range. Moreover, according to Lemma 1, when several goods lie on a disputing segment (given a fixed common Pareto rule for the remaining goods) an edge on the Pareto surface is produced and it is equivalent to the one that we obtain replacing all those disputed goods with a single one by summing up utilities for each player.

Based on these simple remarks, we notice that different faces are formed depending on whether (a) the hyperplane coincides with a good in $\overset{\circ}{RNS}$ and (b) other items lie on one, two or all the disputing segments originated by the same hyperplane. Therefore, six cases [(f1) through (f6)] are generated. Let us analyze each case with the aid of Figure 3 through Figure 8.

In each of them, we move β that determines the PAR out of its original location by a small step in the directions shown by the arrows. This corresponds to a slight tilt of the supporting hyperplane on the Pareto surface, so that the single edge becomes the only supporting region for the hyperplane.

We obtain edges that are connected to each other and form a cycle. Moreover, every time we consider the hyperplane moving in opposite directions in the RNS diagram (actually all cases but (f1)) we consider goods that are contested between players with constant utility ratio. This yields parallel edges of the faces. We distinguish between two cases:

- In cases (f2) and (f3), when moving the hyperplane in opposite directions, the contested good remains the same. In such cases the opposite sides are

not only parallel, but also of equal length¹.

- In cases **(f4)**, **(f5)** and **(f6)**, the number of contested goods changes from 1 to 2 when the opposite direction is taken. Correspondingly, the length of the side changes, the larger side corresponding to the case with two contested goods. The interior points on this larger side correspond to the intermediate cases where one good is allotted to each player².

□

The maximum number of faces is obtained when all items are s-independent, and all the intersections of the disputing segments do not coincide with goods in *RNS*. In such case only faces **(f1)** and **(f2)** are present, producing $k + \binom{k}{2} = (k(k+1))/2$ faces.

The classification of the faces on PF enables us to bound the number of split items of any PO allocation.

Theorem 5. *Under MAC, every Pareto optimal allocation can be obtained under the following alternative conditions:*

¹As an example, let us analyze the case **(f2)** in Figure 4. Case **(f2)** corresponds to the situation in which any $b \in \Delta_2$ lying at the intersection of the supporting segments of two s-independent items a_j, a_k with $j, k \in K$, and no other goods in that intersection. Looking at the geometrical representation in the simplex, we are able to identify four directions (shown by black arrows and labeled by A, B, C and D) that correspond to a slight tilt of the supporting hyperplane on the Pareto surface, so that the single edge becomes the only supporting region for the hyperplane. They are opposite two by two; namely, A is opposite to B and C is opposite to D. Moving towards A (see Figure 4b), the initial allocation changes as follow: item 1 (in blue) ends to be disputed and is assigned to player III; item 2 (in red) is still disputed between players I and II. Two possible assignments are generated: III, I and III, II; they are vertices of edge A. Moving towards the opposite direction B, the initial allocation changes as follow: item 1 ends to be disputed and is assigned to player I; item 2 is still disputed between players I and II. Two possible assignments are generated: I, I and I, II; they are vertices of edge B. The contested good remains the same in both cases; i.e., item 2. Applying an analogous reasoning, moving towards direction C and D item 2 ends to be disputed and is assigned to player II or (player I, respectively); item 1 is still contended between players I and III. Still, the contested good remains the same; i.e., item 1. Hence, we can conclude that edges generated by A and B are not only parallels (since moving in opposite directions we have constant utility ratio across players) but also of equal length (since the contested good remains the same). Same reasoning applies to edges generated by C and D.

²As an example, let us analyze the case **(f4)** in Figure 6. Case **(f4)** corresponds to the situation in which any $b \in \Delta_2$ coinciding with any item a_j , $j \in K$, and a second item a_k , $k \in K$ that lies on a disputing segment. Looking at the geometrical representation in the simplex, we identify four directions (shown by black arrows and labeled by A, B, C and D) that correspond to a slight tilt of the supporting hyperplane on the Pareto surface, so that the single edge becomes the only supporting region for the hyperplane. Only two of them are opposite directions; namely, C and D. Moving towards C (see Figure 6b) items 1 and 2 are still contested between players I and II; player III exits the dispute. Four possible assignments are generated: I, II - I, I - II, I and II, II. Two of them (namely, I, I and II, II) are vertices of edge C. The remaining two are points that lie on the same edge; their respective position depends on the matrix of evaluation. Moving towards D (see Figure 6c) item 1 ends to be disputed and it is assigned to player III; at the same time, item 2 is still contested between player I and player II. Hence, two possible assignments are generated: III, I and III, II. They are vertices of edge D. The number of contested goods is different in the two analyzed directions.; namely, it is equal to two with respect to direction C and equal to one with respect to direction D. As a result, edges generated by C and D are parallel (since moving in opposite directions we have constant utility ratio across players) but length of C is larger than length of D since in C the number of contested goods is greater. The interior points on this larger side correspond to the intermediate cases where one good is allotted to each player.

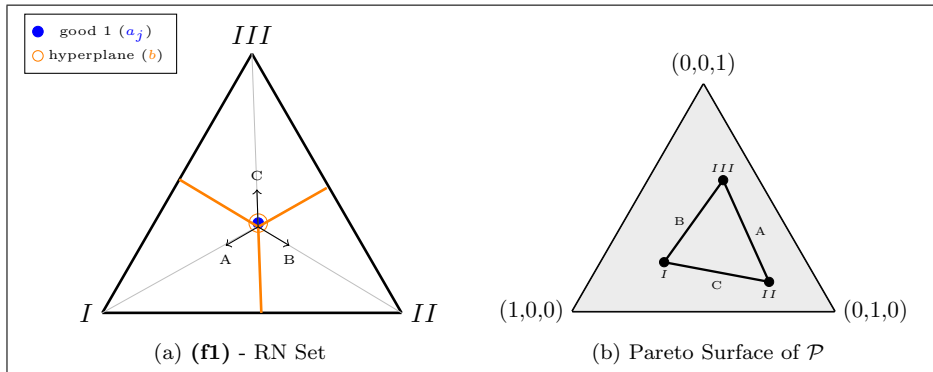

Figure 3: Simplex and Pareto surface of \mathcal{P} for face $(f1)$. Item j can be assigned to any of the three players, while the other items are univocally assigned according to the Pareto rule. Hence, three possible allocations for the disputed good are generated. The face is a **triangle**, each vertex corresponding to a different assignment of item j .

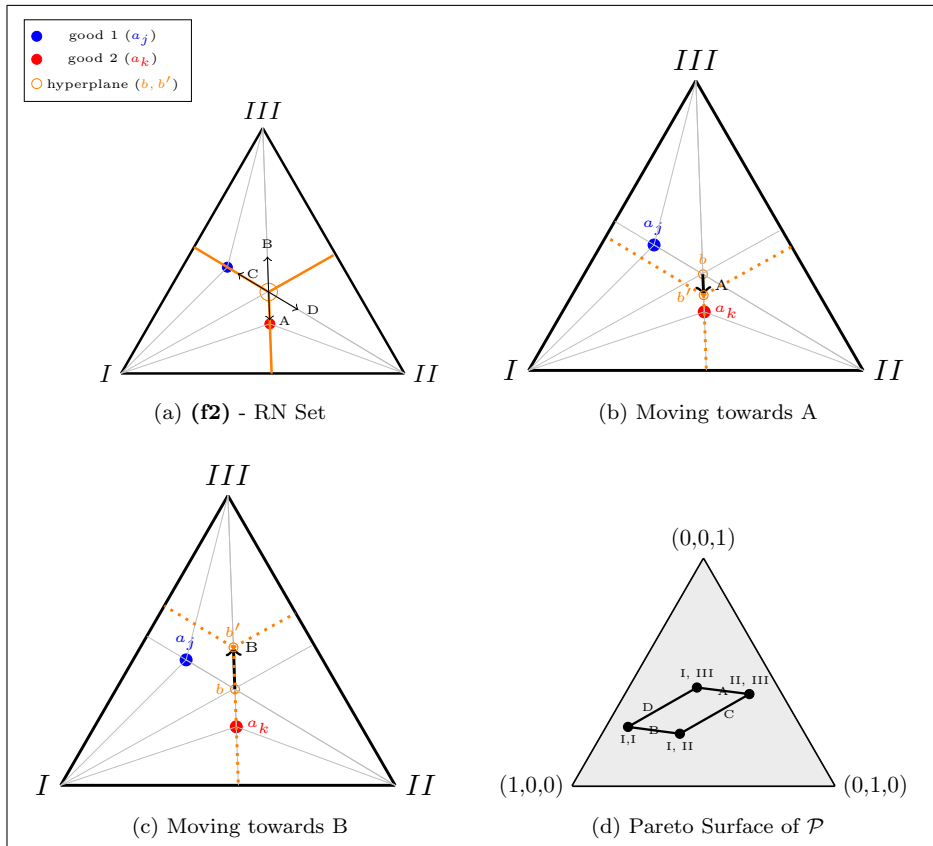

Figure 4: Simplex and Pareto surface of \mathcal{P} for face $(f2)$. Both item j and item k can be shared between two players (with only one player participating in the dispute of both items). The face is a **parallelogram** with each vertex corresponding to a different allocation of the two contested items j and k .

a) No good is split among the players

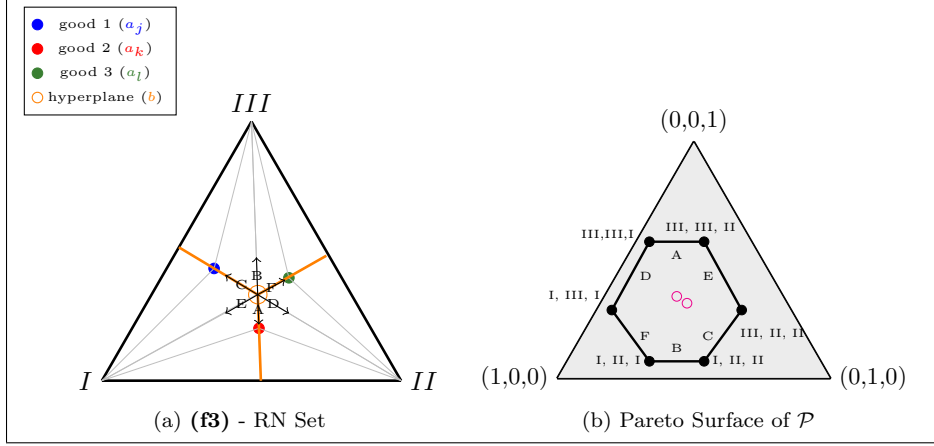

Figure 5: Simplex and Pareto surface of \mathcal{P} for face $(\mathbf{f3})$.

Each of the items j , k and l can be shared between two players (with each player participating in two disputes out of the three). Eight possible assignments are generated and (consequently) eight points in the simplex; six of them are vertices of the **hexagon**, while the remaining two points lie in the interior of the face.

b) *One good is split among at most three players*

c) *Two goods are split, each one between two players*

Proof. Case *a* occurs when the Pareto optimal allocation is also an integer one. Otherwise, the allocation belongs to (at least) one of the faces (f1) through (f6). If the face is of type (f1) or (f2), there is nothing to prove, and we dealing with cases *b* and *c*, respectively.

Consider now any allocation \mathbf{X} with value $a(\mathbf{X}) = (z_1, z_2, z_3)$ on a face (f3). Assume w.l.o.g. that the items are distributed according to the example in Figure 5. For the sake of simplicity set $\gamma_1 = x_{11}$, $\gamma_2 = x_{22}$ and $\gamma_3 = x_{13}$. Also, denote as r_1, r_2 and r_3 the players' allocation value for the remaining goods (other then the first three) obtained with a Pareto rule compatible with $\beta = (\beta_1, \beta_2, \beta_3)$. Any solution of the following linear system denotes an allocation compatible with (z_1, z_2, z_3)

$$\begin{cases} \gamma_1 a_{11} + \gamma_3 a_{13} + r_1 & = z_1 \\ \gamma_2 a_{22} + (1 - \gamma_3) a_{23} + r_2 & = z_2 \\ (1 - \gamma_1) a_{31} + (1 - \gamma_2) a_{32} + r_3 & = z_3 \end{cases}$$

in the constraint region

$$R_1 = \{(\gamma_1, \gamma_2, \gamma_3) \in \mathbb{R}^3 : 0 \leq \gamma_1, \gamma_2, \gamma_3 \leq 1\}.$$

The system, after proper rearrangement, becomes

$$\begin{cases} a_{11}\gamma_1 & & + a_{13}\gamma_3 & = z_1 - r_1 \\ & a_{22}\gamma_2 & - a_{23}\gamma_3 & = z_2 - r_2 - a_{23} \\ -a_{31}\gamma_1 & - a_{32}\gamma_2 & & = z_3 - r_3 - a_{31} - a_{32} \end{cases}.$$

Consider now the coefficient matrix

$$\mathbf{A} = \begin{bmatrix} a_{11} & 0 & a_{13} \\ 0 & a_{22} & -a_{23} \\ -a_{31} & -a_{32} & 0 \end{bmatrix}$$

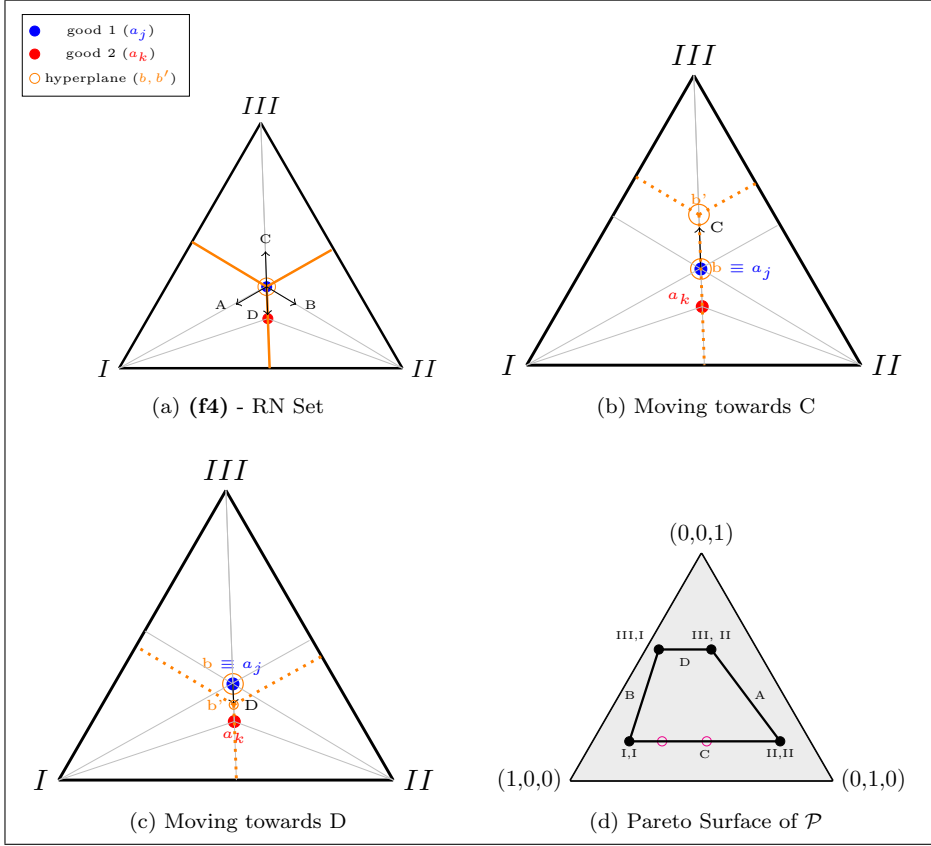

Figure 6: Simplex and Pareto surface of \mathcal{P} for face (f4).

Item j can be assigned to any of the three players; the second item k can be shared between two players. Six different allocations are generated; they produce a **trapezoid**, with the two extra points lying on its larger base.

Since good 1 is disputed between Players I and III , we have $\phi_1 a_{11} = \phi_3 a_{31} > \phi_2 a_{21} \geq 0$, where $(\phi_1, \phi_2, \phi_3) = RD(\beta)$. Moving to goods 2 and 3, we have $\phi_2 a_{22} = \phi_3 a_{32} > \phi_1 a_{12} \geq 0$ and $\phi_1 a_{13} = \phi_2 a_{23} > \phi_3 a_{33} \geq 0$, respectively. Therefore, $\det(\mathbf{A}) = a_{13}a_{22}a_{31} - a_{11}a_{23}a_{32} = 0$, $\det \begin{bmatrix} a_{11} & 0 \\ 0 & a_{22} \end{bmatrix} = a_{11}a_{22} > 0$ and $\text{rank}(\mathbf{A}) = 2$.

Since the allocation lies in the face, the system is admissible, and the set of solutions forms a line in \mathbb{R}^3 , which intersects the border of R_1 at least once (actually twice). Any face of the border describes situations where at most two goods are split, each between two players, that is case c . By virtue of the last statement in (ii) of Lemma 1 the proof can easily be extended to the case where several goods lie on the same disputing line.

Consider now an allocation with values $a(\mathbf{X}) = (z_1, z_2, z_3)$ on an (f4) type of face. Considering w.l.o.g. the distribution of goods described in Figure 6, and denoting for simplicity $\xi_1 = x_{11}$, $\xi_2 = x_{21}$ and $\gamma = x_{12}$, any allocation of goods 1 and 2 compatible with (z_1, z_2, z_3) is a solution of the following system

$$\begin{cases} \xi_1 a_{11} + \gamma a_{12} + r_1 & = z_1 \\ \xi_2 a_{21} + (1 - \gamma) a_{22} + r_2 & = z_2 \\ (1 - \xi_1 - \xi_2) a_{31} + r_3 & = z_3 \end{cases}$$

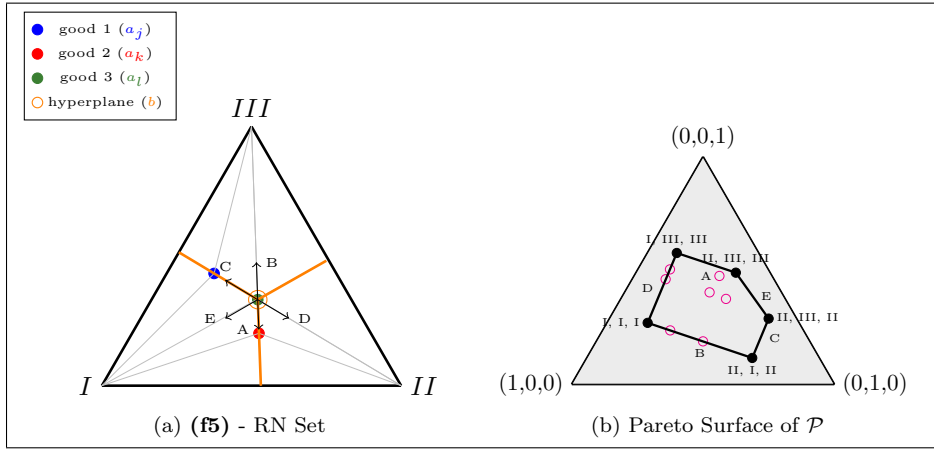

Figure 7: Simplex and Pareto surface of \mathcal{P} for face **(f5)**.
Item j can be assigned to any of the three players; the second item k can be shared between two players. The twelve different allocations produce a **pentagonal** face with five vertices and with two pairs of parallel edges with unequal length. The largest edge of each pair contains two additional points, while the remaining three points are in the interior of the face.

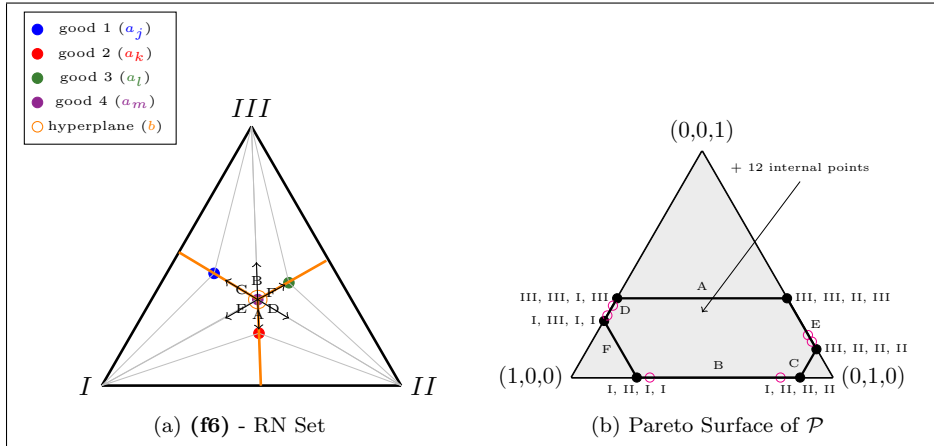

Figure 8: Simplex and Pareto surface of \mathcal{P} for face **(f6)**.
Item j can be assigned to any of the three players; the second item k can be shared between two players. The twenty-four different distributions produce **hexagons** with parallel opposite sides of unequal length. The largest edge of each pair contains two additional points, while the remaining twelve points are in the interior of the face.

in the constraint region (see Figure 9)

$$R_2 = \{(\xi_1, \xi_2, \gamma) \in \mathbb{R}^3 : 0 \leq \gamma \leq 1, \xi_1, \xi_2 \geq 0, \xi_1 + \xi_2 \leq 1\}$$

After proper rearrangement, the linear system becomes

$$\begin{cases} a_{11}\xi_1 & & +a_{12}\gamma & = & z_1 - r_1 \\ & a_{21}\xi_2 & -a_{22}\gamma & = & z_2 - r_2 - a_{22} \\ -a_{31}\xi_1 & -a_{31}\xi_2 & & = & z_3 - r_3 - a_{31} \end{cases}$$

Similarly to the previous case the coefficient matrix has rank 2 and the admissible system has a set of solutions given by a line in \mathbb{R}^3 , which intersects the

border of the closed and bounded admissibility region R_2 at least once. R_2 has 5 faces. In case the solution belongs to one of the two faces (colored in gray in Figure 9)

$$\gamma = 0 \text{ or } 1, \quad \xi_1, \xi_2 \geq 0, \xi_1 + \xi_2 \leq 1$$

we fall on case *b*. For the other 3 faces, namely

$$\begin{aligned} \xi_1 &= 0, & 0 \leq \gamma, \xi_2 \leq 1 \\ \xi_2 &= 0, & 0 \leq \gamma, \xi_1 \leq 1 \\ \xi_1 + \xi_2 &= 1, & 0 \leq \gamma \leq 1 \end{aligned}$$

we fall on case *c*. Notice that in the third case (corresponding to the shaded rectangle in Figure 9), item 1 is split between Players 1 and 2. As before, the extension to several goods on the same disputing line is guaranteed by Lemma 1.

Moving to face (f5), we consider the goods' distribution described in Figure 7. Setting $\gamma_1 = x_{11}$, $\gamma_2 = x_{12}$, $\xi_1 = x_{13}$ and $\xi_2 = x_{23}$ we must find a solution of

$$\begin{cases} \gamma_1 a_{11} + \gamma_2 a_{12} + \xi_1 a_{13} + r_1 & = z_1 \\ (1 - \gamma_1) a_{21} + \xi_2 a_{23} + r_2 & = z_2 \\ (1 - \gamma_2) a_{32} + (1 - \xi_1 - \xi_2) a_{33} + r_3 & = z_3 \end{cases}$$

in the constraint region

$$R_3 = \{(\xi_1, \xi_2, \gamma_1, \gamma_2) \in \mathbb{R}^4 : 0 \leq \gamma_1, \gamma_2 \leq 1, \xi_1, \xi_2 \geq 0, \xi_1 + \xi_2 \leq 1\}$$

Rearranging the terms of the system, we have

$$\begin{cases} a_{11}\gamma_1 & +a_{12}\gamma_2 & +a_{13}\xi_1 & & = & z_1 - r_1 \\ -a_{21}\gamma_1 & & & +a_{23}\xi_2 & = & z_2 - r_2 - a_{21} \\ & -a_{32}\gamma_2 & -a_{33}\xi_1 & -a_{33}\xi_2 & = & z_3 - r_3 - a_{32} - a_{33} \end{cases}$$

The system is admissible with rank 2, and the set of solution forms a two-dimensional subspace in \mathbb{R}^4 . This set will intersect³ at least one of the two dimensional faces composing the border of the closed and bounded constraint region R_3 . If this solution belongs to one of the following faces

$$\left. \begin{array}{l} \gamma_1 = 0 \text{ or } 1 \\ \gamma_2 = 0 \text{ or } 1 \end{array} \right\} \quad \xi_1, \xi_2 \geq 0, \xi_1 + \xi_2 \leq 1$$

we fall on case *b*. For the remaining faces, namely

$$\begin{aligned} & \left. \begin{array}{l} \gamma_i = 0 \text{ or } 1 \quad (i = 1, 2) \\ \xi_h = 0 \text{ or } 1 \quad (h = 1, 2) \end{array} \right\} \quad 0 \leq \gamma_j, \xi_k \leq 1 \quad (j \neq i, k \neq h) \\ & \quad \xi_1 = \xi_2 = 0, \quad 0 \leq \gamma_1, \gamma_2 \leq 1 \\ & \left. \begin{array}{l} \xi_1 + \xi_2 = 1 \\ \gamma_i = 0 \text{ or } 1 \quad (i = 1, 2) \end{array} \right\} \quad 0 \leq \gamma_j \leq 1 \quad (j \neq i) \end{aligned}$$

We fall on case *c*. In the last situation, item 3 is split between Players 1 and 2 and item i is split among the corresponding Players. The usual extension to a larger number of item applies.

³Each bidimensional object is the intersection of two hyperplanes. The intersection between two bidimensional objects will be the intersection of four hyperplanes in \mathbb{R}^4 – typically a point

Suppose now that the allocation value (z_1, z_2, z_3) belongs to face (f6). Following the distribution in Figure 8, we let $\gamma_1 = x_{11}$, $\gamma_2 = x_{22}$, $\gamma_3 = x_{13}$, $\xi_1 = x_{14}$ and $\xi_2 = x_{24}$, and we solve

$$\begin{cases} \gamma_1 a_{11} + \gamma_3 a_{13} + \xi_1 a_{14} + r_1 & = z_1 \\ \gamma_2 a_{22} + (1 - \gamma_3) a_{23} + \xi_2 a_{24} + r_2 & = z_2 \\ (1 - \gamma_1) a_{31} + (1 - \gamma_2) a_{32} + (1 - \xi_1 - \xi_2) a_{34} + r_3 & = z_3 \end{cases}$$

in the constraint region

$$R_4 = \{(\xi_1, \xi_2, \gamma_1, \gamma_2, \gamma_3) \in \mathbb{R}^5 : 0 \leq \gamma_1, \gamma_2, \gamma_3 \leq 1, \xi_1, \xi_2 \geq 0, \xi_1 + \xi_2 \leq 1\}$$

Rearranging the terms, the system becomes

$$\begin{cases} a_{11}\gamma_1 & a_{13}\gamma_3 & +a_{14}\xi_1 & & = z_1 - r_1 \\ & a_{22}\gamma_2 & -a_{23}\gamma_3 & +a_{24}\xi_2 & = z_2 - r_2 - a_{23} \\ -a_{31}\gamma_1 & -a_{32}\gamma_2 & & -a_{34}\xi_1 & -a_{34}\xi_2 & = z_3 - r_3 - a_{31} - a_{32} - a_{34} \end{cases}$$

The system is admissible with rank 2, and the solution set is now tridimensional. It must then intersect⁴ at least one of the following bidimensional faces of the closed and bounded region

$$\begin{aligned} & \left. \begin{array}{l} \gamma_1 = 0 \text{ or } 1 \\ \gamma_2 = 0 \text{ or } 1 \\ \gamma_3 = 0 \text{ or } 1 \end{array} \right\} \xi_1, \xi_2 \geq 0, \xi_1 + \xi_2 \leq 1 \\ & \left. \begin{array}{l} \xi_i = 0 \text{ or } 1 \quad (i = 1, 2) \\ \gamma_j = 0 \text{ or } 1 \quad (j = 1, 2, 3) \\ \gamma_h = 0 \text{ or } 1 \quad (h \neq j) \end{array} \right\} 0 \leq \xi_k, \gamma_\ell \leq 1 \quad (k \neq i, \ell \neq j, h) \\ & \left. \begin{array}{l} \xi_1 + \xi_2 = 1 \\ \gamma_j = 0 \text{ or } 1 \quad (j = 1, 2, 3) \\ \gamma_h = 0 \text{ or } 1 \quad (h \neq j) \end{array} \right\} 0 \leq \gamma_\ell \leq 1 \quad (\ell \neq j, h) \end{aligned}$$

The first type of face describes a type *b* situation, while all the other describe a type *c* situation. The usual extension to a larger number of item applies. \square

4 The Pareto Boundary as a graph

We now show that *RNS* can be used to build a graph $\mathcal{G} = \{V, E\}$ where each vertex $v \in V$ is a face on the Pareto surface, and two vertices v_i and v_j are connected by an arc⁵ $e_{ij} \in E$ if and only if the corresponding faces are adjacent, i.e. they share a common edge. The idea to build this graph is simply to consider all the goods in *RNS* with their disputing segments. The vertices V will consist of all the points in *RNS* coinciding with a good or with an intersection of the dividing lines. Two vertices $v_i, v_j \in V$ will be connected by an arc $e_{ij} \in E$ whenever there is supporting segment joining the two vertices, with no other vertex of V in between. We refer to Figure 10(a) for an example of such graph.

⁴Here we consider the intersection of one bidimensional object with a tridimensional one

⁵We prefer to use ‘‘arc’’ in place of the more common ‘‘edge’’ to avoid confusion with the edges of a face on the Pareto surface.

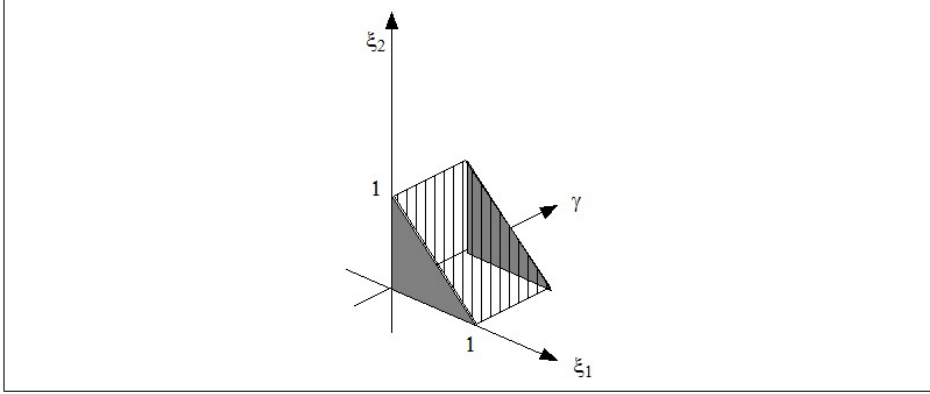

Figure 9: The constraint region for face **(f4)**

Theorem 4 shows that each vertex in V represents a face on the Pareto surface. We now show that two vertices are adjacent (i.e., share an arc) whenever the corresponding faces on the Pareto surface are adjacent (i.e., share an edge).

Theorem 6. *Under MAC, two faces on the upper border of \mathcal{P} are adjacent, i.e. they share a common line segment, if and only if the corresponding vertices v_k and v_ℓ are joined by an arc in \mathcal{G} .*

Proof. First of all we prove that adjacent faces on the Pareto surface correspond to vertices lying on the same disputing segment. In fact, each edge of the faces **(f1)** through **(f6)** is obtained when are assigned first to one player and then to another, while the allocation of the remaining goods remains unchanged. In order for two different hyperplanes to support the same edge, both hyperplanes must have the same disputing segment in common. Therefore one of them must lie on the supporting segment of the other, and, as a consequence they have to be connected by a disputing segment. Also, two faces cannot be associated with vertices on the same supporting segment separated by a third vertex. For, in such a case they would have no allocation and, a fortiori, no edge in common.

We now show that every two adjacent vertices on \mathcal{G} correspond to adjacent faces on the Pareto surface. In fact, consider any two adjacent vertices $v_i, v_j \in V$ and take the hyperplane placed on the midpoint of the arc e_{ij} connecting the two vertices. Whatever the type of face represented by v_i and v_j , the hyperplane touches the Pareto surface on an edge obtained by allocating the goods on both sides of the disputing segment aligned with the edge. The two faces associated to v_i and v_j (respectively) have the same edge in common, since they are both compatible with the allocation of the goods provided by the midpoint hyperplane. We refer to Figure 10(b) for an illustration of the proof. \square

5 Algorithms

5.1 A simple algorithm

We now consider a function $\tilde{g} : RNS \rightarrow [0, 1]$ defined for each $\beta \in RNS$ as

$$\tilde{g}(\beta) = g(RD(\beta))$$

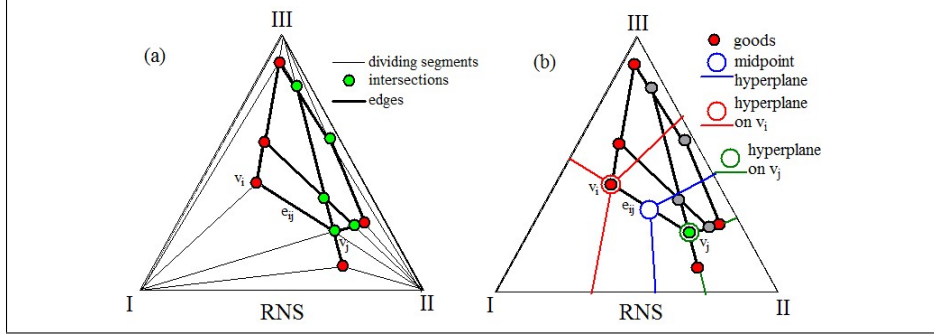

Figure 10: (a) The graph formed by 5 goods. (b) A sketch of the last part of the proof in Theorem 6. Three hyperplanes, those centered at v_i , v_j and their midpoint, share the same two allocations, with all the goods but that in v_i allocated according to the Pareto rule of the midpoint hyperplane, and the good in v_i allocated first to player 1 and then to player 3

this function, in particular is defined for every vertex of the graph $\tilde{g}(v)$. The following Theorem shows that it suffices to check the value of \tilde{g} on the face/vertices only. Moreover, the function \tilde{g} inherits the convexity property of g according to which it suffices to show that \tilde{g} is a "local" minimum (i.e. a minimum w.r.t. the adjacent vertices) to make it a global optimum.

Theorem 7. *Under MAC, a face/vertex v^* containing the egalitarian ray has the following properties*

i) *It is the global minimum for g*

$$\tilde{g}(v^*) \leq \tilde{g}(v) \quad \text{for any } v \in V \quad (3)$$

ii) *It suffices to show that it is a local minimum for g :*

$$\tilde{g}(v^*) \leq \tilde{g}(v') \quad \text{for any } v' \text{ adjacent to } v^* \quad (4)$$

Proof. (i) The PO-EQ allocation belongs to one or more Pareto faces. According to Theorem 2 (iii) one of the minimizing arguments of g (and therefore of \tilde{g}) will correspond to such Pareto face. The corresponding vertex on the graph will be associated to the same absolute minimum.

(ii) We need to prove two preliminary claims.

We consider two hyperplanes: $\mathcal{H}(\text{face})$ passing through a Pareto face, and $\mathcal{H}(\text{edge})$ passing through an edge of the face. Denote with $g(\text{face})$, $g(\text{edge})$ resp., the value of g corresponding to $\mathcal{H}(\text{face})$, $\mathcal{H}(\text{edge})$ resp., and denote with ℓ_{ed} the line intersection of the two (non parallel) hyperplanes containing the edge. Consider now the following projections on NPB, obtained by normalizing the points in the geometrical object: p_{face} , p_{ed} , p_{eq} , projections of the Pareto face, the line ℓ_{ed} and the bisector, respectively. We prove the following claims:

Claim 1a If p_{face} and p_{eq} are on the same side of p_{ed} (see Figure 11, left) then $g(\text{edge}) \geq g(\text{face})$;

Claim 1b If p_{face} and p_{eq} are on opposite sides of p_{ed} (see Figure 11, right) then $g(\text{edge}) \leq g(\text{face})$;

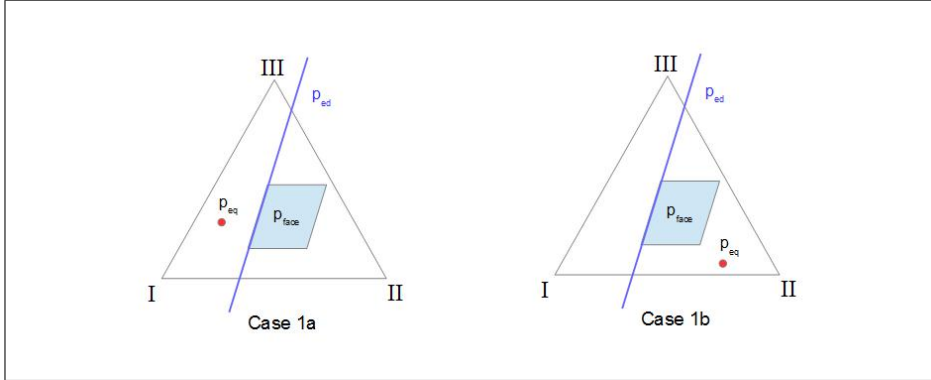

Figure 11: The two cases for claim 1

Proof of Claims 1a and 1b. (1a) Suppose $g(\text{edge}) < g(\text{face})$. Then the hyperplane $\mathcal{H}(\text{edge})$ passes through the edge and $g(\text{edge})(1, 1, 1)$, separating \mathcal{P} from the Pareto face and $g(\text{face})(1, 1, 1)$ (see Figure 12, left) – a contradiction. (1b)

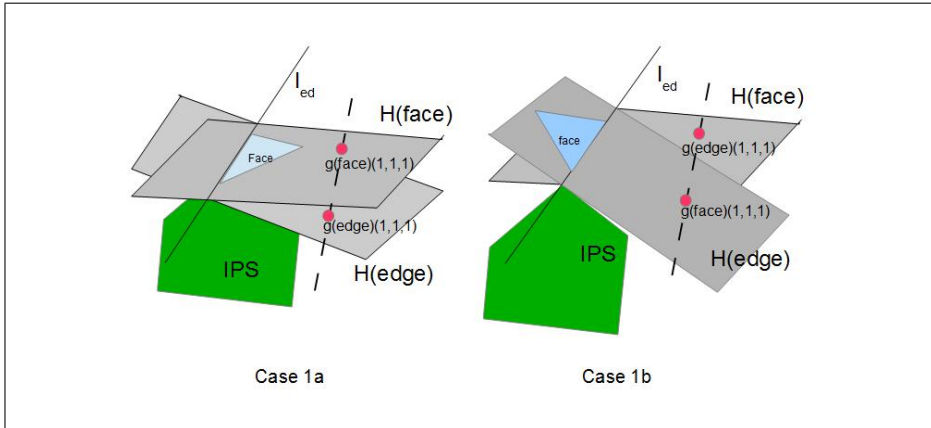

Figure 12: Proofs of Claims 1a and 1b

Suppose $g(\text{edge}) > g(\text{face})$. Then the hyperplane $\mathcal{H}(\text{edge})$ passes through the edge and $g(\text{edge})(1, 1, 1)$, separating \mathcal{P} from the Pareto face and $g(\text{face})(1, 1, 1)$ (see Figure 12, right) – again a contradiction. \square

As a consequence of these claims suppose $\tilde{g}(v') < \tilde{g}(v'')$ for two adjacent faces, then, projecting the Pareto face v' , the line containing the edge and the bisector on NPB, the projected Pareto face and the projected bisector must lie on the same side of the projected line.

Claim 2. Suppose $\tilde{g}(v') = \tilde{g}(v'')$ for two adjacent faces. Then the bisector intersects the line generated by the common edge.

Proof of Claim 2. Denote with $\mathcal{H}(v')$, $\mathcal{H}(v'')$ resp., the hyperplane passing through face v' , face v'' resp. Since $v' \neq v''$, the two hyperplanes are neither parallel nor coincident and intersect in a line ℓ_{ed} that includes the common edge. Suppose the bisector does not meet the line. Then the two hyperplanes $\mathcal{H}(v')$ and $\mathcal{H}(v'')$ have more than three non aligned points in common: those in ℓ_{ed} and

$g(v')(1, 1, 1)$. Being distinct hyperplanes this is impossible. The bisector must meet the common line ℓ_{ed} . \square

To prove the theorem we distinguish three cases:

Case 1 (4) holds with strict inequality sign for all the adjacent edges.

Consider the projection of the the faces and the bisector on NPB. For each adjacent edge, the Pareto face and the bisector lie on the same side of the line generated by the edge. The projected bisector must belong to the projected bisector and the same is true on the Pareto Boundary. By theorem 2 (iii) v^* is an absolute minimum of g , and therefore of \tilde{g} .

Case 2 (4) holds with strict inequality sign for all the adjacent edges, but one $\tilde{g}(v^*) = \tilde{g}(v'')$.

Considering the projections on NPB, the bisector and the Pareto face v^* must lie on the same side of each line generated by all the adjacent edges different from v'' . Moreover the bisector must lie on the (projected) line generated by the edge between the faces v^* and v'' . Once again the bisector meets the Pareto face v^* , and the theorem holds.

Case 3 (4) holds with $\tilde{g}(v^*) = \tilde{g}(v'')$ for two or more adjacent vertices v'' .

The bisector must belong to all the lines generates by the edges of the adjacent faces for which equality holds. The bisector belongs to their intersection which must be a vertex of the face. Once again the bisector meets the Pareto face v^* , and the theorem holds. \square

The theorem suggests the following simple algorithm

5.2 A simple algorithm

The following algorithm is based on theorem 7.

Beginning Start from any $v^0 \in V$ (For instance the one closest to the center in RNS)

Body For the current $v^k \in V$, compute the value $\tilde{g}(v')$ any adjacent vertex v' :

- If (4) holds $\implies v^k$ is optimal \implies End
- Otherwise move towards the adjacent vertex v^{k+1} with lowest value of \tilde{g} . \implies Repeat step with v^{k+1} .

End From the optimal vertex/face \implies find the optimal allocation.

Theorem 8. *The simple algorithm converges in a finite number of steps.*

Proof. There is a finite number of vertices in the graph, and the algorithm cannot cycle. \square

5.3 Steepest descent along the graph

Moving along the edge from (c_1, c_2, c_3) to $(c_1 + \varepsilon, c_2 - \frac{c_2}{c_2+c_3}\varepsilon, c_3 - \frac{c_3}{c_2+c_3}\varepsilon)$, with $0 < \varepsilon < c_2 + c_3$, note that

$$\frac{c_2 - \frac{c_2}{c_2+c_3}\varepsilon}{c_3 - \frac{c_3}{c_2+c_3}\varepsilon} = \frac{c_2 \left(1 - \frac{\varepsilon}{c_2+c_3}\right)}{c_3 \left(1 - \frac{\varepsilon}{c_2+c_3}\right)} = \frac{c_2}{c_3}$$

i.e. the ratio remains the same, and the new point is on the supporting segment joining (c_1, c_2, c_3) to the vertex of Player *I*.

We now investigate what happens to the corresponding hyperplane coefficients.

Lemma 2. *If $S(\varepsilon) = (s_1, s_2, s_3)$ denotes the variation of the hyperplane coefficients, i.e.*

$$S(\varepsilon) := RD\left(c_1 + \varepsilon, c_2 - \frac{c_2}{c_2+c_3}\varepsilon, c_3 - \frac{c_3}{c_2+c_3}\varepsilon\right) - RD(c_1, c_2, c_3)$$

then

$$S(\varepsilon) = \delta(\varepsilon)(-c_2 - c_3, c_2, c_3)$$

where

$$\delta(\varepsilon) = \frac{c_2 c_3 \varepsilon}{(c_2 c_3 + c_1 c_2 + c_1 c_3)(c_1(c_2 + c_3) + c_2^2 c_3 + c_2 c_3^2 + \varepsilon(c_3^2 + c_2^2 + c_2 c_3))}$$

Proof. Verify it with Mathematica □

The shifts along the RNS cause an analogous shift in the hyperplane coefficients, but in the opposite direction: To an increase in c_1 , there corresponds a decrease in b_1 , and, conversely, a decrease in c_2 and c_3 determines an increase in the corresponding hyperplane coefficients b_2 and b_3 .

The shift in b is not linear. This implies that the value of the function g will not change linearly. Instead of choosing an arbitrary value for ε , we may consider the instantaneous rate of change at $\varepsilon = 0$

$$\delta'(0) = \frac{c_2 c_3}{(c_2 + c_3)(c_2 c_3 + c_1(c_2 + c_3))^2}$$

Therefore we will consider the following variations in the hyperplane coefficients

$$\delta'(0)(-c_2 - c_3, c_2, c_3)$$

Note also that a similar in the other direction is obtained by reversing signs. Similarly, shifts along other supporting signs are obtained by replacing the roles of c_1 , with that of c_2 (c_3 , resp.) if the supporting segment toward Player *II* (Player *III*, resp.) is considered.

Whatever shift is considered, denote with s_1 , s_2 and s_3 the variation in the hyperplane coefficients, with $s_1 + s_2 + s_3 = 0$. Assuming that the shift does not take to a point out of RNS, the variation in g is given by

$$\Delta \tilde{g} = \sum_{i \in N} s_i a_i(\mathbf{X}_i^-) + \sum_{j \in dg(c)} \max_{i \in dp(j)} \{s_i a_{ij}\}$$

where \mathbf{X}_i^- denotes the goods that, according to $PAR(c)$ are allocated to Player i without disputing (and do not belong to a disputing line of c), $dg(c)$ denotes the set of disputing goods in c , and $dp(j)$ denotes the set of disputing players for good j .

In case $(s_1, s_2, s_3) = \delta'(0)(-c_2 - c_3, c_2, c_3)$ we can define the directional derivative $\frac{dg}{d\vec{\ell}} = \Delta\tilde{g}$ of \tilde{g} in the direction $\vec{\ell}$ towards pl.I. Similar definitions can be given for the other admissible directions from a given face/vertex v .

5.4 A more subtle algorithm

The following algorithm is based on a steepest descent rule:

Beginning Start from any $v^0 \in V$ (For instance the one closest to the center in RNS)

Body For the current $v^k \in V$, compute the directional derivative towards any adjacent vertex v_j :

- If $\frac{dg}{d\vec{\ell}} \geq 0$ towards any adjacent $v_j \implies v^k$ is optimal \implies End
- If $\frac{dg}{d\vec{\ell}} < 0$ towards some adjacent $v_j \implies$ Move towards the adjacent vertex v^{k+1} with lowest derivative. \implies Repeat step with v^{k+1} .

End From the optimal vertex/face \implies find the optimal allocation.

Theorem 9. *The algorithm converges in a finite number of steps*

Proof. There is a finite number of vertices in the graph, and the algorithm cannot cycle. \square

References

- [1] Barbanel, Julius B. On the structure of Pareto optimal cake partitions. J. Math. Econom. 33 (2000), no. 4, 401–424.
- [2] Barbanel, Julius B. The Geometry of Efficient Fair Division. Cambridge University Press (2005).
- [3] Barbanel, Julius B.; Zwicker, William S. Two applications of a theorem of Dvoretzky [Dvoretzky], Wald, and Wolfowitz to cake division. Theory and Decision 43 (1997), no. 2, 203–207.
- [4] Brams, Steven J., Taylor, Alan D. Fair Division: From Cake-Cutting to Dispute Resolution. Cambridge University Press (1996).
- [5] Brams, Steven J., Taylor, Alan D. The Win-Win Solution: Guaranteeing Fair Shares to Everybody. W.W.Norton (1999).
- [6] Dall’Aglio, Marco. The DubinsSpanier optimization problem in fair division theory. Journal of Computational and Applied Mathematics. 130 (2001), no.1, 17–40.

- [7] Dall'Aglio, Marco; Di Luca Camilla. Finding Maxmin Allocations in Co-operative and Competitive Fair Division. *Annals of Operations Research*. 230 (2014), no.1, 121–136.
- [8] Donzer, L.; Grünbaum, B.; Klee V. Kelly's Theorem and Its Relatives, *Convexity Proc. Symp. Pure Math*, American Mathematical Society (1963), 101–179
- [9] Kalai, E. Proportional Solutions to Bargaining Situations: Interpersonal Utility Comparisons. *Econometrica*. 45 (1977). no. 77. 1623–1630.
- [10] Kalai, E; Smorodinsky, M. Other Solutions to Nash's Bargaining Problem. *Econometrica*. 43 (1975). no. 3. 513–518.
- [11] Weller; Dietrich. Fair Division of a Measurable Space. *Journal of Mathematical Economics*. 14 (1985). no.1. 5–17.